



20th
Wonca Europe
Conference 2015
istanbul



TAMUD
TURKISH ASSOCIATION
OF FAMILY PHYSICIANS

October 22-25, 2015

Halic Congress Center
Istanbul / TURKEY



Wonca
World family doctors. Caring for people
EUROPE

ABSTRACT BOOK



WELCOME MESSAGES

Dear Colleagues,

We are proud to celebrate 20th anniversary of Wonca Europe and 25th anniversary of TAHUD, Turkish Association of Family Physicians. We hope to continue the success of previous congresses and carry out that success to the next congress.

The idea of choosing the theme “Being Young Staying Young” was to look through past and to look ahead when we were leaving behind the twenty years as Wonca Europe and twenty five years as TAHUD.

The years ending with zero and five have been accepted as evaluation and planning years. For this reason we aimed to place sessions to discuss the future perspectives of Wonca Europe on education, clinical practice, organization of family physicians, when we were forming the congress program.

We wanted to ensure to provide wide variety of opinions to be presented on such important issues. That’s how the “Grand Sessions” created. With the aim of increasing the number of plenary sessions beyond the keynote sessions, and capturing the opportunity to listen more doyens and experts, five grand session time slots have been created at the congress while there were 21 paralel sessions in other slots.

With the motto “Being Young Staying Young” meaning dynamism for our disicpline, our aim was not only to make the experts to be heard but also to give the chance to each participant who wish to share and exchange their own experiences thus to ensure a more colorful and broad participation congress and increase attendance of young doctors.

With this aim we have created nineteen BRITE sessions. BRITE sessions aim to provide family doctors to share their ideas by discussing the positive and negative consequences of their practices. We think these sessions will motivate reflective learning by encouraging the physicians to review their practice and also will contribute to the identification of new research areas.

The participants of Pre Conference organized by VdGM has increased seventy percent. On the other hand one third of the participants attending to the congress are young family doctors. In this congress, for the first time, we have made all leaders of Young Doctors’ Movement of Wonca to come together in Istanbul.

Our congress is colorful in terms of content and it has a green philosophy. For this purpose, we avoided to print papers as much as possible. We have saved at least 1,500 trees when we calculate only our monthly emails. More than this we contributed developments of forest by creating Wonca Europe Memorial Forest.

We are also proud of giving new opportunities to the participants who “stays young”. Participants of the congress who wishes to observe the primary care in Turkey closely, and to have new friends, are hosted by Turkish colleagues before the congress within the HostPro program.

Istanbul is a magnificent city in the heart of Europe and Asia. We advice you to see beauty of the city. We have decided to make 20th year celebration at a private boat on Bosphorous particularly. We hope you to have splendid time with beautiful Istanbul panorama.

We would like to thank Wonca Europe president Job FM Metsemakers and the liason person Anna Stavdal, other members of Wonca Europe Executive Committee and International Advisory Board for their supports and contributions. We are also grateful to Micheal Kidd, Wonca World President, and to all people who made this congress real.

Hoping to have a successful congress.

Prof. Mehmet Ugan
Chair, Scientific Committee

Prof. Okay Basak
President, Turkish Association
of Family Physicians

Prof. Dilek Guldal
Chair, Host Organizing Committee

COMMITTEES

Host Organizing Committee

Okay BASAK	President of Turkish Association of Family Physicians
Dilek GULDAL	Chair of Host Organizing Committee
Mehmet UNGAN	Chair of Scientific Committee
Resat DABAK	Vicechair of Host Organizing Committee

Scientific Committee

Mehmet UNGAN	Chair
Yesim UNCU	Scientific Secretary
Arzu UZUNER	Scientific Secretary
Ilhami UNLUOGLU	Academic Representative
Altug KUT	Academic Representative
Selçuk MISTIK	Chair of 2015 National Conference
Zekeriya AKTURK	Representative of EQUIP
Esra SAATCI	Representative of EURACT
Pınar TOPSEVER	Representative of EGPRN
Berk GEROGLU	Representative of VdGM

Local Organizing Committee

Dilek GULDAL	Chair
Resat DABAK	Vice chair
Hulya AKAN	
Murat ALTUNTAS	
Mehmet AKMAN	
Fatma Goksin CIHAN	
Gokhan EMINSOY	
Ziya T. GUNES	
Refik IMAMECIOGLU	
Emrah KIRIMLI	
Mümtaz MAZICIOGLU	
Didem SUNAY	
Nil TEKİN	
Mehmet UGURLU	
Pemra C. UNALAN	
Erdinc YAVUZ	
Tanju YILMAZER	

SUB COMMITTEES

Newsletter Group

Nil TEKIN
Suheyra ATALAY
Huseyin CAN
Candan Kendir
COPURLAR
Gokhan EMINSOY
Berk GEROGLU
Mehtap KARTAL
Mümtaz MAZICIOGLU
Tugba ONAT
Pemre C. UNALAN
Ali CERRAHOGLU
Sandra Adalgiza ALEXIU

Website & Social Medya Group

Emrah KIRIMLI
Mehmet AKMAN

Social Events Group

Mumtaz
MAZICIOGLU
Erdinc YAVUZ
Selcuk MISTIK
Esra SAATCI
Nazan KARAOGLU

Official Support Group

Umit AYDOGAN
Vildan MEVSIM

Sponsorship Group

Altug KUT
Huseyin CAN
Sehnaz HATIPOGLU
Erdinc YAVUZ

Hostpro-Ist2015 Group

Nilgun OZCAKAR
Candan Kendir
COPURLAR
Tuba ONAT
Zeynep Vural
TUZCULAR
Isik GONENC

ADVISORY BOARD

Vaclav BENES, Czech Republic
Thomas FREEMAN, Canada
Raquel GOMEZ BRAVO, Spain
Amanda HOWE, United Kingdom
Liljana KOCANKOVSKA, Macedonia
Torsten LAURITZEN, Denmark
Christos LIONIS, Greece
Harris LYGIDAKIS, Italy
Manfred Maier, Austria
Luis PISCO, Portugal
Michael PRINGLE, United Kingdom
Maira STEWART, Canada
Jelle STOFFERS, The Netherlands
Ljubin SUKRIEV, Macedonia

KEYNOTE LECTURE

The tree bends when it is young - The value of flexibility and adaptability for the development of family medicine



Amada Howe is a professor of Primary Care in University of East Anglia, she was former honorary secretary Royal College of General Practitioners, currently she is Vice Chair Council (Professional Development Portfolio) in the same organization. She is also President Elect Wonca.

Honoured hosts, dear colleagues and friends,

It is a great privilege to be a keynote speaker for the 2015 WONCA EUROPE Conference in Istanbul. My talk will relate to the conference theme, and my title "Ağaç yaş iken eğilir" ('Trees bend when they are young') reflects my intention to discuss the cycle of growth for both our discipline and our organisations - and to evaluate the strengths of being young and growing older!

I have had two reasons to reflect on what it means to be young, or stay young. The first is personal - I have recently had my 60th birthday, and also become a grandmother for the first time. The return to having significant responsibility for a very young child, and remembering the very basic demands of parenting, provides me with a life experience that is very different from that of caring for patients, or chairing medical school committees, or meeting senior colleagues across the world for major scientific and policy discussions. It is an unconditional commitment, with little glamour or intellectual output, but huge emotional demands and rewards. It also heralds a new cycle of life – one where one is reminded of the fragility of health and wellbeing. And it brings more experience of the patient perspective – our essential reliance on the health providers getting it right – in the clinic, in the hospital, and at all stages of care.

How has this helped me to think about our discipline of family medicine, and our careers as family doctors? I can look back at my own career and see different phases - the contribution of my family background, school and university opportunities; then choosing family medicine, entering clinical practice, and an unexpected transition into academic, national and international roles.

I know that for many young doctors, it is often daunting to think about how to make appropriate career choices – especially where to work, how much work to do, how to balance clinical work with other interests and commitments such as child rearing, and indeed how to choose a speciality. Our discipline is also young in global terms, and often this adds insecurity – we may have to defend our status, the value of our discipline, the quality of our service, and fight for the resources we need to do a good job. We also have to increase the both the public's and politicians' understanding of the added value of family medicine as a speciality in the health system. So being young, whether personally or professionally, can be an uncomfortable and uncertain time, with added risks and anxieties. I shall include some factors in my talk which can help to guide us through these early stages.

The second reason I have been thinking about 'growing up' is related to my deepening understanding of WONCA, its history and different organisational parts. The lens of history is one which can magnify our understanding of who we are and why we act as we do – just as family doctors often need to understand what motivates our patients to use health care and live healthily, we need to understand our own strengths and weaknesses.

If we look back at WONCA's inaugural meeting, the key ingredients were a core group of committed people with a vision, building on their own experiences and others to create a professional organisation. They worked hard to define and deliver the new organisation, using conventional modes of creating a professional governance and representational structure. Wes Fabb, in his report of the inaugural conference, noted that what had been achieved could not yet be measured in finite terms, but would worldwide add to the quality of care people received from their family doctors.

One of the striking aspects of the history of WONCA, and this remains true today, is the longstanding commitment of many of its leaders in what essentially is a voluntary capacity. Wes Fabb, for example, was involved from 1972, and was CEO for twenty years. Our President, Michael Kidd, mentions in his obituary message to David Game (who was President, and also WONCA Editor for 28 years) that Michael was already attending WONCA Conferences in 1990 – 25 years ago. I myself can therefore only count as a relatively young activist within WONCA, attending my first European conference in the late 1990s, joining a working party in 2001, and my first world conference in Orlando in 2004. But many have joined after me – we have seen huge increases in the numbers of member organisations, and of young doctors getting involved in their regional movements - and more are welcome! We hope that WONCA in all its forms – national, regional, working parties and special interest groups – will offer our members a scope which will enhance their professional development over many years to come.

We welcome the growth and activities of our members – and at the same time, it presents challenges. With bigger aims, more members, and more activities come new demands; but our Secretariat globally is still only 4 people. In Singapore we had 3 staff, Wes and Marian ran this on 1.5 people – 4 still seems very small for the work we are now doing. The regional groupings also struggle with capacity, and to me this is a bit like a young forest growing on a hill side – we have great strength in our roots but the ground under us could slide away. So there are some conditions we need to fulfil for organizational resilience which I will outline – these include sustainable financing; strong but flexible governance; streamlining bureaucracy; capacity building; being effective politically; being flexible, inclusive and open; making strong political alliances which promote our mission and its impacts; having evidence to support our work; and delivering on our promises.. We have to be effective at both doing our jobs well and collecting data to prove our effectiveness – or to identify areas where we could do better if further resourced.

The final part of my talk will be about staying young – how to stay fresh in spite of the demands of work, home, long-term relationships, and the varying challenges of professional and political environments. In Prague in 2013 I spoke about factors which assist doctors to be resilient – this includes keeping ourselves educationally up to date, making good relationships with patients and colleagues, knowing how to get support when needed, and making sure that over time we have different career opportunities which develop new skills and enthusiasms. WONCA has a role in helping with your resilience, and therefore keeping you ‘young’ as a professional – we provide support networks, new information and ideas, and a peer group with shared values. We also work on your behalf - we try to make persistent and committed efforts to improve the external status of family medicine, and so to make your own experience as family doctors more meaningful. My final slides will give some early views about the programmes of work that I aim to pursue with you over the next period of time.

KEYNOTE LECTURE

Role of Academia, Science, Ethics and Mentor for the Future of Medicine



Prof. Emin Kansu is a professor of hematology and chairman at basic oncology department of Hacettepe University in Ankara, Turkey. He has been member of European Union and Europe Scientific Committee Ethics Working Groups. He is a member of Turkish Scientific and Technical Research Council (TUBITAK) and Scientific Research Ethics Committee.

University is an educational institution designed for instruction, examination, or both, of students in many branches of advanced learning, conferring degrees in various faculties, and often embodying colleges and similar institutions. Its vision should include to achieve the highest levels of distinction in discovery and dissemination of knowledge in the education of students.

Also an academic institution should attain the highest possible level of achievement in education and prepare them for positions of leadership and service. It will also give priority to research and teaching of its faculty with its distinctive emphasis on excellence in undergraduate and postgraduate education as well as service to society. During the university training, each student has to learn science, how to reach the scientific truth, to ask right questions at right time and to find the correct answers to his or her questions. Students are expected to acquire analytical and creative thinking leading to novel ideas.

In academia, scientific leaders are mentors and they help to build the mentee's career. This mentor-mentee relationship forms the basis of an academic microenvironment. Academic microenvironment is an interactive environment in which a mentee can greatly benefit and receive a learning experience. A mentor should recognize the mentee's potential abilities and encourages him/her. A good mentor should set reachable standards, goals and expectations for the mentee. A mentor should be supportive, "good listener" and a "good communicator". Mentor – mentee relationship usually includes mutual interests in area of study. If this becomes a productive scientific relationship it will eventually promote professional excellence and growth. All mentors should be honest and teach their mentee's ethical standards in research and publication. The perfect mentor/mentee relationship is an essential aspect of future of medicine.

KEYNOTE LECTURE

What changes in the role of family physicians and general practitioners?



Jan De Maeseneer is professor and head of department of family medicine and primary health care, Ghent University.

Family physician community health center "Botermarkt", Ledeborg – Gent, Belgium.
Chairman European Forum for Primary Care.

1. Introduction: The changing society.

Nowadays, general practitioners and family physicians are confronted with a very rapidly changing environment. First of all, there are the epidemiological and demographical transitions: from acute conditions towards chronic disorders, with an increasing amount of people with multi-morbidity¹. Another important evolution is the scientific and technological innovation (e.g. ICT), that creates opportunities to bring technology that was formerly not available in primary care in the hand of family physicians. Unfortunately, we are confronted in the daily practice for primary care with an increasing social gradient in health, with as a consequence e.g. in a country like Belgium, a gap of 18 years in healthy life expectancy for men at the age of 25, depending on whether they had only basic education, or a university or a school for higher education degree. Probably the most "disruptive innovation" in the last decade, has been the changing position of the patient, who becomes more and more an informed actor in the health care process. Finally, nowadays, and increasingly due to migration of refugees for war and insecurity, the population we serve is more and more diverse, multi-cultural, and so health care becomes more and more "global".

These challenges require a change in the role of general practitioner/family physicians, but also in the way the profession organizes its practice. Society expects primary care providers to contribute to the "triple aim": better care, more health and more value (i.e. the relation between quality and cost)². We will now describe the changes in roles of family physicians and general practitioners at the nano-, micro-, meso- and macro-level.

2. The Nano-level.

This is the level of the concrete interaction between a person looking for care and a provider. At this level, to a large extent, the experience of "quality" will be assessed by the person looking for care. Person-centered approach as defined in the "World Health Support: Primary Health Care: now more than ever!³. Nowadays the family physician does no more work as a single-handed practitioner, but will work in team, acting as an "integrator" of the care process: exploring new complaints and problems, taking care for appropriate support of chronic conditions, empowering the patient and shifting the paradigm from problem-oriented care, towards goal-oriented care, taking the goals of the patient as the ultimate point of reference for the care processes⁴. At the nano-level, increasingly, electronic devices will be used in order to capture information from the patient. The challenge will be to avoid a "digital device" and to find an appropriate balance between "compassion" and "computer".

3. The Micro-level.

The Micro-level is where a team, working in a practice organizes the care for a (defined) community. At this level appropriate sharing of information, through the Electronic Patient Record (with actions for the patient and for all the care providers, taking into account privacy-issues), is the cornerstone of a comprehensive approach. Increasingly, it will be needed to agree on appropriate coding and classification of the information. Both the International Classification of Primary Care (ICPC-2) and the "International Classification of Function" (ICF), will be needed in order to classify appropriately the (multiple) conditions of a patient. A contextual approach will require cooperation with care providers from other sectors e.g. social workers. In complex situations, the patient may choose one of his/her care providers as a "case-manager" to coordinate the care in continuous interaction with the patient. Increasingly, the practices active at the micro-level will work together through networks in order to share expertise and improve access. Patients appreciate very much the opportunity to choose (1 or 2) "preferred providers" in order to enhance "personal continuity".

The information available in the "Electronic Patient Record" may not only be used for individual care, but may contribute to an analysis of the problems a community is facing. This can happen in the framework of

"Community Oriented Primary Care", where primary care providers, together with the community identify problems, formulate a "Community Diagnosis" and develop interventions in order to address the "upstream causes" of ill-health⁵. An important focus in these interventions will be the contribution to more "social cohesion" in order to improve the health status of the population.

Increasingly, the model of Interprofessional Community Health Centers is developed. In general, these interprofessional practices comprise family physicians/general practitioners, nurses, social workers, occupational therapists, dentists, health promoters, physiotherapists, nurses, midwives,... The team takes responsibility for the care for a defined population. Cooperation may be stimulated by the use of a "Needs-based integrated mixed capitation", as e.g. is the case in the Belgian Community Health Centers.

4. The Meso-level.

The different practices at the primary care level, also when they work together in networks, are not able to provide the organizational power that is needed to make a strong primary care system. Therefore, organization at the meso-level is needed. Internationally, a meso-level is quite often defined as a geographic area, with 75.000 up to 125.000 inhabitants. At this level primary care may realize continuity functions (GP-posts for out-of-hours care,...), support services e.g. palliative home care,... And this may also be the level where the providers interact and negotiate with the local authorities. It is also at this level that primary care providers and especially family physicians/ general practitioners may take up an "advocacy role" giving a voice to those who do not have a voice in society (the poor, disabled, illiterate, undocumented,...). More and more tasks will shift from hospital to primary care, it will be important to strengthen the meso-level, in order to increase the performance of the primary health care system.

5. The Macro-level.

This is the level where policy-decisions are taken. Nowadays, there is a lot of rhetoric by politicians, explaining why it is so important to strengthen the primary care. On the other hand, it is quite difficult to shift resources from secondary to primary care, when components of the care are no longer dealt with in hospitals, but at the primary care level. The principle "the money follows the patient" is simple, the practice is tough. In Europe, still a lot of countries do not have a full patient list system, neither they have the regulations in order to enable appropriate referral and "gate-keeping"⁶.

As far as financing is concerned, primary care, should basically be financed through a "population-oriented" mechanism, whereas in secondary care a "disease-oriented" financing mechanism is used. Strong organizations or family physicians/general practitioners, if possible in interprofessional cooperation, are needed in order to translate the scientific evidence into concrete policy actions.

6. What does this mean for the family physician/general practitioner?

This transition will not only require the acquisition of new skills (Collaborative Leadership, Comprehensive Data-Analysis, understanding of policy development), but also a new type of organization of the practice, using interprofessional networks that engage in Intersectoral Action for Health. These networks will ask for new organizational approaches: replacing the traditional bureaucratic "Command-and-Control"-approach by a "Complex Adaptive Systems"-approach⁷. In order to be able to perform all these tasks in a sustainable way, the family physician/general practitioner will become a "reflective practitioner" who takes care of the personal health and of the wellbeing of the team of care providers. By doing so, family physicians/general practitioners are ready to contribute to the "Sustainable Development Goals" 2015-2030.

References

1. Barnett K, Mercer SW, Norbury M et al. Epidemiology of multi-morbidity and implications for health care, research, and medical education a cross-sectional study. *The Lancet* 2012;380:37-43. doi:10.1016/s0140-6736
2. Berwick DM, Nolan TW, Whittington J. The Triple Aim: care, health and cost. *Health Affairs* 2008;27(3):759-769.
3. World Health Organisation. Primary Health Care: now more than ever! Geneva, WHO, 2008. Available at: <http://www.who.int/whr/2008/en/>
4. De Maeseneer J, Boeckxstaens P. James MacKenzie Lecture 2011 : multimorbidity, goal-oriented

care, and equity. Br J Gen Pract. 2012; (62) (600) : e522-4. <http://www.ncbi.nlm.nih.gov/pubmed/22782000>.

5. Rhyne R, Bogue R, Kukulka G, Fulmer H, editors. Community-oriented primary care: health care for the 21st century. Washington, DC: American Public Health Association, 1998.

6. EXPH (EXpert Panel on effective ways of investing in Health), report on Definition of a frame of reference in relation to primary care with a special emphasis on financing systems and referral systems, 10 July 2014. Available at

http://ec.europa.eu/health/expert_panel/opinions/docs/001_defintionprimarycare_en.pdf

7. Anderson RR, McDaniel RR. Managing health care organisations: where professionalism meets complexity sciences. Health care manage Rev 2000; 25 (1): 83-92.

8. United Nations. General Assembly. Draft outcome document of the United Nations Summit for the Adoption of the Post-2015 Development Agenda. Available at

http://www.un.org/ga/search/view_doc.asp?symbol=A/69/L.85&Lag=E

SCIENTIFIC PROGRAM

THURSDAY, OCTOBER 22, 2015

09:00-12:30

COURSE	MARMARA ROOM
Basic Ultrasonography Course: Method and Practice of Ultrasonography in Primary Care	Erdinç Yavuz, Ismail Hamdi Kara, Mehmet Halis Tanrıverdi, Bahri Yıldız
COURSE: IPCRG	CIBALI ROOM 1
All About Inhalers	Jaime Correia De Sousa, Svein Høegh Henrichsen, Ioanna Tsiligianni
COURSE	CIBALI ROOM 2
Spirometry Made Easy	Miguel Román Rodríguez, Jim Reid
COURSE	KASIMPASA ROOM 1
Introduction to Homoeopathy	Günnur Şerife Başar, Levent Hekimoğlu
COURSE	KASIMPASA ROOM 2
Panic attacks... The 10 minute solution	Enda Murphy, Patrick Paddy Halligan, Kandan Loganathan
COURSE	KASIMPASA ROOM 3
Difficult To Manage Asthma	Umut Gök Balcı, Arzu Yorgancıoğlu, Jaime Correia de Sousa, Kurtuluş Öngel, Umit Aydoğan, Dursun Cadırcı, Fatma Göksin Cihan, Hüseyin Elbi, Yasemin Simsek, Seda Coskun
COURSE	KASIMPASA ROOM 4
Insertion of The Levonorgestrel Intrauterine System in Family Practice	Zeynep Tuzcular Vural, Işık Gönenc
Insertion of Copper IUD's in Family Practice	Işık Gönenc, Zeynep Tuzcular Vural
COURSE	KASIMPASA ROOM 5
Myths, Misconceptions and Facts on Contraception	Vera Pires Da Silva, Sara Rigon, Ula Chetty
COURSE	BALAT ROOM
Domestic Violence Good Practice In Training The Trainers To Deal With Family Violence in Primary Health Care	Lodewijk Pas, Gene Feder, Sylvie Lo Fo Wong, Carmen Fernandez, Raquel Gomez
COURSE: PCDE	HASKOY ROOM
How To Start And Manage Insulin Therapy In Primary Care	Mehmet Sargin, Frances Xavier Co
COURSE	AVO 1
A Glance To The Treatment Options Of Osteoarthritis: Old And Traditional, New And Challenging	Ülkü Sur Ünal, Sabah Tüzün, Serap Çifçili

THURSDAY, OCTOBER 22, 2015

14:00-15:15

SYMPOSIUM	SADABAT HALL
Indigenous and Minority groups Issues and Health Outcomes	Tane Taylor
SYMPOSIUM	EYUP HALL
Noncontraceptive Uses And Benefits Of Hormonal Contraceptives	Işık Gönenç, Emine Zeynep Tuzcular Vural
TURKISH TRACT	FENER HALL
Panel Cogito Ergo Sum; Yin and Yang Reality	Betül Battaloğlu Inanç, Mümtaz Mazıcıoğlu, Zekeriya Aktürk
CONFERENCE	TOPHANE HALL
Chairs:	İlhami Ünlüoğlu, Ayfer Gemalmaz
Meeting the diagnostic problems introduced by increased aminotransferases or imaging tests indicating liver steatosis	Christos Lionis
Conference: EPCC Stroke Prevention in AF-State Of The Science	Richard Hobbs
WORKSHOP	MIMOZA HALL
Affirmations As A Tool to Help Patients Move Towards Behavioural Changes	Anneli Rätsep, Ruth Kalda
WORKSHOP	MARMARA ROOM
Innovation For Primary Care. The Development Of An Optimal Care Delivery Framework	Joachim Sturmberg, Bruno Kissling, Rick Botelho
WORKSHOP	CIBALI ROOM 1
The Hard Art of Clinical Decision Making In General Practice	Alessandro Menin, Giorgio Visentin
WORKSHOP	CIBALI ROOM 2
The Impact of Gender on Everyday Practice	Sara Rigon, Yusianmar Mariani, Nina Monteiro, Patrick Reichel, Luís De Pinho Costa, Ana Nunes Barata, Sara Belinchon, Hassoune Hanim
WORKSHOP	KASIMPASA ROOM 1
How To Assess Risk-Taking Behaviors and Sexuality During An Adolescent Care Office Visit	Grace Abi Rizk, Jihane Naous
BRITE: BR - 14	KASIMPASA ROOM 2
Chairs:	Katharine Ann Wallis, Güzel Dişçigil
Elderly Care	Katharine Ann Wallis, Firdous Jahan, Hakan Yaman, Nur Şehnaz Hatipoğlu, Erdiñç Yavuz, Güzel Dişçigil, Fatma Göksin Cihan, Didem Kafadar, Mehmet Urgan, Canan Tuz
BRITE: BR - 1	KASIMPASA ROOM 3
Chairs:	Hardisman Dasman, Fatih Özcan
New Ways for Dealing with Medical Conditions	Hardisman Dasman, Suat Sincan, Andrea Pighi, Diana Dominguez Jimenez, Josep Vidal Alaball

THURSDAY, OCTOBER 22, 2015**14:00-15:15**

WORKSHOP: WOMEN & FAMILY MEDICINE	KASIMPASA ROOM 4
Practical Skills Workshop For GPs in Responding to Family Violence	Amanda Barnard, Jan Coles

WORKSHOP: EUROPREV	KASIMPASA ROOM 5
M-And E-Mental Health: New Dimensions to Deal With Problematic Alcohol Use. An Update By The Alcohol Working Group of Europrev	Lodewijk Pas, Frederico Rosario, Mateja Bulc

WORKSHOP: ESPCG	BALAT ROOM
Diagnostic Discrimination Between Functional And Organic Bowel Disease in Primary Care	Niek De Wit, Pali Hungin, Greg Rubin, Knut Arne Wensaas

WORKSHOP	HASKOY ROM
Addressing Sexual Health Consultations in Primary Care	Ruth Muñoz Maya, María Dolores Bernal Peinado, Elvira García Martín

ORAL PRESENTATION	AVO 1
OP-001 - OP-008	Chairs: Gene Feder, Mehmet Sargin

ORAL PRESENTATION	AVO 2
OP-009 - OP-016	Chairs: Mehmet Uğurlu, Uğur Bilge

ORAL PRESENTATION	AVO 3
OP-017 - OP-023	Chairs: Turan Set, Sevsen Cebeci

THURSDAY, OCTOBER 22, 2015**15:30-16:30**

PANEL	HALIC AUDITORIUM
Moderators:	Job Metsemakers, Luisa Pettigrew
Development and Challenges of Family Medicine	Okay Basak, Michael Kidd, Raman Kumar, Peter Sloane, Anna Stavdal, Pavel Ursu

THURSDAY, OCTOBER 22, 2015**17:00-18:30**

OPENING CEREMONY	HALIC AUDITORIUM
-------------------------	-------------------------

THURSDAY, OCTOBER 22, 2015

18:30-20:30	WELCOME COCKTAIL
--------------------	-------------------------

FRIDAY, OCTOBER 23, 2015**09:00-10:15**

SYMPOSIUM CONFERENCE	HALIC AUDITORIUM
Chairs:	Hülya Parıldar, Yasemin Korkut
The Future of Family Medicine - a Contextual View 50 Years From Now	Carl Steylaerts
Issues, Challenges and way forward for Primary Care Research: A global Perspective	Waris Qidwai

SYMPOSIUM: ESPCG	SADABAT HALL
Role of European general practitioners in communicating colorectal cancer screening	Bohumil Seifert, Charles Helsper, Martin Rasmussen, Greg Rubin

FRIDAY, OCTOBER 23, 2015**09:00-10:15**

SYMPOSIUM: EURIPA	EYUP HALL
Poverty: A Treat And Challenge For Rural General Practice – EURIPA Symposium	Tanja Pekez Pavlisko, Christos Lionis, Jane Randall Smith, Oleg Kravtchenko, Ferdinando Petrazzuoli, Jean Pierre Jacquet
TURKISH TRACT	FENER HALL
Opening: 14 th National Congress and 25 th Anniversary of TAHUD	
SYMPOSIUM: PCDE	TOPHANE HALL
DAWN 2 Symposium - PCDE	Antonio Nicolucci, Richard Holt, Ingrid Willaing
WORKSHOP: ICPC-3	MIMOZA HALL
ICPC-3: Progress Toward a New Version of the International Classification of Primary Care	Ferdinando Petrazzuoli, Nicola Buono, Thomas Kühlein
WORKSHOP: VdGM & EQUIP	MARMARA ROOM
Quality Circles at a Glance – Use of Antibiotics in General Practice	Peter A Sloane, Christina Svanholm, Ulrik Bak Kirk, Adrian Rohrbasser
WORKSHOP	CIBALI ROOM 1
Curiosity & Complexity in Primary Care and Health Education. A Complexity SIG workshop	Joachim Sturmberg, Carmel Martin, Jim Price, Bruno Kisling
WORKSHOP	CIBALI ROOM 2
Medical Leadership - A Competency for GPs	Sietse Wieringa, Renee Weersma
BRITE: BR – 2	KASIMPASA ROOM 1
Chairs:	Alexandra Georgious Tsipou, Tanju Yilmazer
Socio Economic Situations and Health Care	Veronica Rasic, Elle Mall Keevallik , Alexandra Georgious Tsipou, Emily Clark, Emrah Kırımlı
BRITE: BR – 15	KASIMPASA ROOM 2
Chairs:	Vildan Mevsim, Tijen Şengezer
Mental Health	Kendall Anne Searle, Ian Casson
WORKSHOP: VDGM	KASIMPASA ROOM 3
The Right To Be Protected – A Practical Approach To Family Violence Within Primary Care	Sara Belinchon, Sara Rigon, Rosa Avino, Raquel Gomez Bravo, Nina Monteiro, Yusianmar Mariani, Elena Klusova, Sara Conde, Monica Teran VdGM Special interest group on Family Violence

FRIDAY, OCTOBER 23, 2015**09:00-10:15**

WORKSHOP	KASIMPASA ROOM 4
Should A Physician Use Short Interview Techniques in Primary Care?	Pemra Unalan, Bilge Turgut, Selcuk Akturan, Cigdem Apaydin Kaya, Mehmet Akman

WORKSHOP	KASIMPASA ROOM 5
WONCA ICOH Statement and Pledge on Primary Health Care&Workers' Health: How to proceed? Introduction to a Workshop PHC&Workers' Health	Peter Buijs, Frank Van Dijk

WORKSHOP	BALAT ROOM
A Collaborative Framework For European Primary Care Clinical Trials: First Experiences	Catherine Friderieke Enters-Weijnen, Diederick E. Grobbee, Richard Hobbs, Paul Wallace, Nicolaas J De Wit2, Stéphane Heijmans, Miguel A. Munoz-Perez

WORKSHOP	HASKOY ROOM
What Do 'People-Centred' and 'Integrated' Health Services Look Like? A Project by the World Health Organization, World Organization of Family Doctors And International Alliance of Patients' Organizations	Maria Luisa M Pettigrew, Amanda Howe, Michael Kidd, Dheepa Rajan, Shannon Barkley, Nittita Prasopa Plaizier, Hernan Montenegro, Alison Lightbourne

WORKSHOP	SUTLUCE ROOM 1
How Can We Make Clinical Decision Support Systems Effective In General Practice?	Derk L Arts, Henk C Van Weert

WORKSHOP EURACT	SUTLUCE ROOM 2
How to Prepare For A Pandemic – PREPARE PG Course, Part I	Zalika Klemenc Ketis, Anna Stavdal, Mehmet Urgan

ORAL PRESENTATION	AVO 1
OP-024 - OP-031	Chairs: Elana Benigni, Murat Ünalacak

ORAL PRESENTATION	AVO 2
OP-032 - OP-039	Chairs: Annette Berendsen, Kurtuluş Öngel

ORAL PRESENTATION	AVO 3
OP-040 - OP-047	Chairs: Catalina Panaitescu, Zuhul Sağlam

FRIDAY, OCTOBER 23, 2015**10:30-11:00**

KEYNOTE LECTURE	HALIC AUDITORIUM
Moderators:	Job Metsemakers, Yesim Uncu
The tree bends when it is young - The value of flexibility and adaptability for the development of family medicine	Amanda Howe

11:00-11:30	COFFEE BREAK
--------------------	---------------------

FRIDAY, OCTOBER 23, 2015**11:30-12:45**

SYMPOSIUM	HALIC AUDITORIUM
Making a World Book of Family Medicine	Carl Steylaerts, Mehmet Urgan

PANEL	SADABAT HALL
Tobacco Control In Europe: 10 Years After the WHO FCTC	Recep Erol Sezer, Özlem Tanrıöver, Kristina Mauer Stender, Luminita Sanda, Gemma Vestal, Toker Ergüder

FRIDAY, OCTOBER 23, 2015

11:30-12:45

SYMPOSIUM: AGPFMSEE	EYUP HALL
Collaboration of the Association of General Practice /Family Medicine of South East Europe	Ljubin Sukriev
Harmonization And Equalization Of General Practice/Family Medicine Work Quality In South East Europe	Biserka Bergman Markovic
Harmonization of specialization on General Practice/Family Medicine in South East Europe	Katarina Stavrikj
Research at the Level of the Association and the Importance of this in the Region	İlhami Ünlüoğlu

TURKISH TRACT	FENER HALL
Panel Living Spaces for the Elderly	Nil Tekin, Güzel Dişçigil, Gülru Pemra Ünal, Saliha Serap Çifçili

SYMPOSIUM: PCDE	TOPHANE HALL
Chair:	Pinar Topsever
EXPLORE Symposium PCDE	Peter Schwarz, Johan Wens, Martin Hadley Brown

WORKSHOP	MIMOZA HALL
Family Medicine Practice Beginning And Population Assessment Guideline	Aysel Başer, Giray Kolcu

WORKSHOP	MARMARA ROOM
European Forum for Primary Care (EFPC) Workshop on Interprofessional Collaboration (IpC): Communication and Language	Diederik Aarendonk, Kathryn Hoffmann, Jan De Maeseneer, Mehmet Akman

WORKSHOP: CANCER & PALLIATIVE CARE, WONCA SIG	CIBALI ROOM 1
The Role of Family Doctors In Cancer Rehabilitation and Palliative Care	Annette Berendsen, Dorte Gilså Hansen, David Weller, Alis Ozcaker, Hibah Osman, Scott Murray, Geoff Mitchell

WORKSHOP: WONCA CONFLICT & CATASTROPHE SIG	CIBALI ROOM 2
WONCA Conflict and Catastrophe Special Interest Group	Rich Withnall, Tanja Pekez Pavliško, Hüseyin Avni Şahin

BRITE: BR – 3	KASIMPASA ROOM 1
Chairs:	Claire Wilson, Aclan Özder
Obesity	Sergey Rostislavovich Sokolovsky, Patrick Tabouring, Susan Saffel Shrier, Clare Wilson, Simon Victor Rudland, Emre Yılmaz, Aykut Ardiç, Suzan Yazıcı

BRITE: BR – 16	KASIMPASA ROOM 2
Chairs:	Fatma Gökşin Cihan, Ton Drenthen
Preventive Care	Aml Ahmed Salama, Duygu Altıparmak, Tevfik Tanju Yilmazer, Fatma Gökşin Cihan, Fikret Sipahioğlu, Yusuf Karayürek

WORKSHOP	KASIMPASA ROOM 3
Wisdom And Wellbeing - A Priority For Tomorrow's Doctor	Sabena Yasmin Jameel, Katharine King

WORKSHOP	KASIMPASA ROOM 4
Communicating with the Difficult Patient	Basem Roberto Saab, Nisrine Makarem

FRIDAY, OCTOBER 23, 2015

11:30-12:45

WORKSHOP	KASIMPASA ROOM 5
Balint Group Work-Reflective Practice in Action	David Watt, Ceri Dornan
WORKSHOP: WONCA WORKING PARTY ON EDUCATION	BALAT ROOM
Working Together to Enhance Family Medicine Education: Tools from the Wonca Working Party on Education	Allyn Walsh, Val Wass, Victor Ng, Roar Maagaard, Marcelo Demarzo, Sam Merriel, William Watson
WORKSHOP: MIGRANT CARE and INTERNATIONAL HEALTH	HASKOY ROOM
Health and Health Care for Refugee Children	Maria Van Den Muijsenbergh, Suzanne Gagnon, Anne Meynard, Pinar Doner, Rebecca Farrington
WORKSHOP	SUTLUCE ROOM 1
Music Therapy: A Hands-on Session for Biofeedback	Er Chiao Lee, Elena Benigni
WORKSHOP: EURACT	SUTLUCE ROOM 2
How to Prepare For A Pandemic – PREPARE PG Course, Part II	Ronnie Moore, Zalika Klemenc Ketis, Anna Stavdal
ORAL PRESENTATION	AVO 1
OP-048 - OP-055	Chairs: Jean Claude Leners, Tamer Edirne
ORAL PRESENTATION	AVO 2
OP-056 - OP-063	Chairs: Toine Lagro Janssen, Gökhan Eminsoy
ORAL PRESENTATION	AVO 3
OP-064 - OP-071	Chairs: Zehra Dağlı, Ayşe Palandüz
12:45 – 14:00	LUNCH BREAK

FRIDAY, OCTOBER 23, 2015

14:00-15:15

PANEL: VDGM&EQUIP	HALIC AUDITORIUM
Social Media: An Exercise in Time Wasting for Young People?	Peter A Sloane, Raluca Zoitanu, Harris Lygidakis, Luis De Pinho Costa, Ulrik Bak Kirk, Raquel Gomez Bravo
SYMPOSIUM: WONCA-ICOH-WHO	SADABAT HALL
What WONCA, Together With ICOH And WHO, Can Contribute to Workers' Health: A Short History, But A Challenging Great Future Ahead!	Peter Buijs, Frank Van Dijk
TURKISH TRACT	FENER HALL
Chairs:	Selçuk Mistık, Bektaş Murat Yalçın
Conference: Communicating With Patients With Multiple Chronic Co-Morbidity	John Yaphne
Conference: LGBTI Health and Primary Care in Turkey	Filiz Ak
SYMPOSIUM: CONTROL of ALLERGY-EAACI	TOPHANE HALL
Poorly Controlled Asthma	Dermot Ryan
Developing Information Systems to Improve Allergy Care	Miguel Román Rodríguez
Anaphylaxis: A Primary Care Approach	Elizabeth Angier

FRIDAY, OCTOBER 23, 2015**14:00-15:15**

WORKSHOP	MIMOZA HALL
Reverse Innovation - Re-Engineering Primary Care	Sinan Mir, Joanna Thorne

WORKSHOP	MARMARA ROOM
Who to inform? How to manage the cancer diagnose?	Özden Gökdemir, Ülkü Bulut, Olgu Aygün, Seval Yaprak, Hadiye Küçükkaragöz, Dilek Güldal

WORKSHOP	CIBALI ROOM 1
Comparative Global Health Care Systems: Single-Payer And Multi-Payer Ways of Achieving Universal Health Care: What Can Family Doctors Do?	Vincent T Leon, C. Ruth Wilson, Claudia Chaufan

WORKSHOP	CIBALI ROOM 2
Management and Education of Fasting Patients by the General Practitioner: The Example of Ramadan	Melissa Dominicé Dao, Anbreen Slama Chaudhry

BRITE: BR – 5	KASIMPASA ROOM 1
Chairs:	Nazan Karaoğlu, Nena Kopcavar Gucek
Violence in Health	Suzana Milivoje Ivković, Patrick S Mcfarlane, Diana Dominguez Jimenez, Nazan Karaoğlu, Vishal Mallusingh Baghele

BRITE: BR – 17	KASIMPASA ROOM 2
Chair:	Pınar Topsever, Ayşe Selda Tekiner
Cronical Non-Communicable Diseases	Elena Benigni, Anbreen Slama Chaudhry, Lucio Giuseppe Granata, Senem Buğdaycı

FRIDAY, OCTOBER 23, 2015**14:00-15:15**

WORKSHOP: EURACT	KASIMPASA ROOM 3
Identifying Expert Family Medicine Teachers In Europe Using Work Based Appraisal – EURACT Education Workshop	Adam Windak, Justin Allen, Jo Buchanan, Roar Maagaard, Ruth Kalda, Manfred Maier, Janko Kersnik, Tomasz Tomasik, Igor Svab, Katarzyna Dubas, Niels Kjaer, Violetta Kijowska

WORKSHOP: EURIPA	KASIMPASA ROOM 4
EURIPA Workshop: Modernising Our Rural Practice: From Old Patterns Towards The Future	Oleg V Kravtchenko, Tanja Pekesz-Pavlislo, Ferdinando Petrazzuoli, Jean-Pierre Lorzet

WORKSHOP: EUROPREV & FAMILY VIOLENCE	KASIMPASA ROOM 5
Detection And Multidisciplinary Collaboration In Intimate Partner Violence Primary Care. A Europrev And Wonca Special Interest Group Family Violence Workshop	Leo Pas, Sylvie Lo Fo Wong, Carmen Fernandez Alonso, Joyce Kenkre, Tanja Pekez Pavlislo, Raquel Gomez Bravo, Gene Feder, Mateja Bulc

WORKSHOP	BALAT ROOM
WONCA Working Party on Education Developing WONCA CPD Standards: Engaging the WONCA Europe perspective	Victor Ng, Allyn Walsh

WORKSHOP	HASKOY ROOM
Red Roses Writing About Then Learning from Encounters With Patients	Alec Logan, Khairat Al-Habbal, Janice Crofts

WORKSHOP	SUTLUCE ROOM 1
Starting your Own Balint Group	David Watt, Ceri Dornan

FRIDAY, OCTOBER 23, 2015**14:00-15:15**

WORKSHOP	SUTLUCE ROOM 2
Clinical Research Methodology Workshop	Firdous Jahan

ORAL PRESENTATIONS	AVO 1
OP-072 - OP-080	Chairs: Maria Van Den Muijsenbergh, Alis Özçakır

ORAL PRESENTATIONS	AVO 2
OP-081 - OP-088	Chairs: Sandra Alexiu, Zeynep Tuzcular Vural

ORAL PRESENTATIONS	AVO 3
OP-089 - OP-096	Chairs: Bhomil Seifert, Hüseyin Avni Şahin

FRIDAY, OCTOBER 23, 2015**15:30-16:45**

GRAND SESSION	HALIC AUDITORIUM
Moderators:	Anna Stavdal, Canan Tuz
Future of WONCA: Contribution of Young Doctors	Raman Kumar, Kayode Alao, Kyle Hoedebecke, Shin Yoshida, Bhavna Matta, Peter Sloane, Andrea de Angulo, Nagwa Nashat

GRAND SESSION	SADABAT HALL
Moderator:	Mladenka Vrcicmr Keglevic
Improvement of Quality and Inequity in Publishing Scientific Papers	Paula Broeiro, Jelle Stoffers, Mehmet Akman

GRAND SESSION	EYUP HALL
Moderator:	Mehmet Ungan
Translational Research And Complexity Of Care	Moira Stewart, Waris Qidwai

GRAND SESSION	FENER HALL
Moderator:	Carl Steylaerts
Wonca Networks: Contribution to Family Medicine	Ruth Kalda, Piet Vanden Bussche, Tanja Pekez-Pavlisko, Mateja Bulc

GRAND SESSION	TOPHANE HALL
Moderator:	Andree Rochfort
Patient Centeredness And Community Centeredness: How to Deal With Diversity	Thomas Freeman, Tina Eriksson

16:45 – 17:15	COFFEE BREAK
----------------------	---------------------

FRIDAY, OCTOBER 23, 2015**17:15-18:30**

PANEL	HALIC AUDITORIUM
Challenges to Our Professional Attitudes – Treating Friends and Family	Manfred Maier, Imre Rurik Jean Karl Soler Nazan Karaoğlu

WORKSHOP	SADABAT HALL
Writing For Publication - Meet The Editors!	Jelle Stoffers, Hans Thulesius

SYMPOSIUM	EYUP HALL
Tuberculosis as a Professional Disease aAmong Health Care Workers	Ljiljana Cvejanov Kezunovic, Milena Cojic, Olgun Göktaş

FRIDAY, OCTOBER 23, 2015

17:15-18:30

WORKSHOP	FENER HALL
Why Do We Drink?	Marta Velgan, Helena Tamm
WONCA EUROPE	TOPHANE HALL
OPEN MEETING	
WORKSHOP	MIMOZA HALL
Vaccination for Pregnant Women	Dorica Sandutu, Sandra Alexiu, Cristina Barbu, Gindrovel Dumitra, Daniela Stefanescu, Raluca Zoitanu, Dana Stefana Popescu, Anca Deleanu, Maria Lup
WORKSHOP	MARMARA ROOM
Using The Arts In General Practice/Family Medicine Education: Experiences And Way To Go Ahead?	Mehmet Akman, Mladenka Vrcić Keglević, Hrvoje Tiljak, Pemra Cöbek Ünalán
WORKSHOP	CIBALI ROOM 1
Preparing Trainees And Their Trainers For The GP Care of The Future: Working With 'Entrustable Professional Activities' In GP Training	Paul Van De Vijver, Kees Van Der Post, Marcel Reinders, Mirjam Nijvelt
WORKSHOP	CIBALI ROOM 2
What Options For Developing Integrated Care In Rural Family Practice In Europe: What Building Blocks Need To Be In Place?	Zalika Klemenc-Ketis, Carolyn Wallace, Oleg V. Kravtchenko, Donata Kurpas, Christos Lionis
BRITE: BR – 4	KASIMPASA ROOM 1
Chairs:	Igor Svab, Neşe Yeniçeri
Dealing with Difficult Situations in Primary Care	Gabriela Cristina Elena Badea, Naldy Parodi López, Hayriye Kulbay Yuksel, Enda Murphy, Raquel Vaz Cardoso, Camille Defrancesch
BRITE: BR – 19	KASIMPASA ROOM 2
Chairs:	Özgür Enginyurt, Fikret Sipahioğlu
Legal and Ethical Issues	Yasemin Kılıç Öztürk, Riitta Anneli Heiskanen, Rabia Adviye Aktaş
WORKSHOP	KASIMPASA ROOM 3
Enriching The Clinical Dialogue by The Aid of A Conversational Response Model	Carl Edvard Rudebeck, Maria Yngvesson, Helena Bäckström, Henrik Nelson, Bertil Isaksson, Viktor Skobe
WORKSHOP	KASIMPASA ROOM 4
Graphic Medicine A Valuable Method of Reflection For Patients, Clinicians, Teachers And Trainees	Linda Miller, Niro Amin, Fleur Navey, Rowena O'brien, Stephanie Drymiotou
WORKSHOP	KASIMPASA ROOM 5
Gender-based Violence Against Women and Approach in Primary Care	Filiz Ak, Zehra Dağlı
WORKSHOP	BALAT ROOM
Primary Care As A Strategy To Tackle Health Inequity In Europe	William Wong, Sara Willems, David Blane, Patrick O'donnell
WORKSHOP	HASKOY ROOM
Goshinken, A Practical Tool to Improve Mind-Body Fitness in Family Medicine	Elena Benigni, Yosuke Iida

FRIDAY, OCTOBER 23, 2015**17:15-18:30**

WORKSHOP	SUTLUCE ROOM 1
The Family Doctor As a Promotor of Breastfeeding	Maria Ana Sobral, Daniela Runa, Mario Machado Cruz, Susana Medeiro, Sara Magalhães, Ines Dias Ferreira
WORKSHOP	SUTLUCE ROOM 2
The Family's Syndrome With Psychodrama and Sociodrama Techniques	Hadiye Küçükkaragöz, Tolga Nasuh Aran
ORAL PRESENTATIONS	AVO 1
OP-97 - OP-105	Chairs: Recep Erol Sezer, Adem Özkara
ORAL PRESENTATIONS	AVO 2
OP-106 - OP-114	Chairs: Mateja Bulc, Mustafa Çelik
ORAL PRESENTATIONS	AVO 3
OP-115 - OP-123	Chairs: Victor Ng, Ertan Mert

SATURDAY, OCTOBER 24, 2015**09:00-10:15**

WORKSHOP: FAMILY VIOLENCE	HALIC AUDITORIUM
Intimate Partner Violence: Picking Up Signals And Responding In Daily Practice	Sylvie Lo Fo Wong, Toine Lagro Janssen
WORKSHOP	SADABAT HALL
Smarter Planet Smarter Health Care, e-Health	Zelal Akbayın, Charilaos Lygidakis, Ulrik Bak Kirk, Raquel Gomez Bravo, Peter A. Sloane
PANEL	EYUP HALL
The Pacemaker Agenda: Promoting A Culture of Wellness, Scientific Update, and Happiness For Teaching Professionalism and Ethics In Daily Practice	Pablo Gonzalez Blasco, Graziela Moreto, Rosana Irie, Marcelo Rozenfeld Levites, Marco Aurelio Janaudis, Pedro Subtil Paula, Olgun Gökteş
TURKISH TRACT	FENER HALL
Panel Management of Childhood Obesity in Primary Care	Merve Şen, Arzu Uzuner, Nazire Öncül Börekçi
SYMPOSIUM	TOPHANE HALL
Early Detection and Management Of Frailty In Primary Care	Serap Çiççili, Güzel Dişçigil, Çiğdem Apaydın Kaya, Pemra Gülru C. Ünalın
WORKSHOP	MIMOZA HALL
Approach to The Patient With Abnormal Blood Cell Count In Primary Care	Leonor Troni, Vanessa Carvalho, Ieda Paula
WORKSHOP	MARMARA ROOM
Domestic Violence Workshop: What We Think? What We Do?	Nilgün Özçakar, Akça Toprak Ergöner, Özden Gökdemir, Gözde Yeşiltepe, Seval Yaprak, Melike Çağaydın, Ülkü Bulut, Gamze Akyol, Mine Tevrizoğlu
WORKSHOP	CIBALI ROOM 1
Ethical dilemmas in General Practice- a workshop	Manfred Maier

SATURDAY, OCTOBER 24, 2015**09:00-10:15**

WORKSHOP	CIBALI ROOM 2
Can We Improve Our Low Back Pain Tackling?	José Miguel Bueno Ortiz, Jose Antonio García Garcerán, Noemi Del Cerro Álvarez, Alberto Palacios Colom, Ignacio Ramírez Manent, Fernando Jose Rodriguez Martínez, Juan Francisco Mulero Cervantes, Juan Reyes Reyes, Mari Carmen Santiago García, Rafael Luquin Martínez, Ana Maria Gómez Vizcaino, Esther García Delgado, Domingo Orozco Beltran
BRITE: BR – 7	KASIMPASA ROOM 1
Chairs:	Hüseyin Can, Halis Tanriverdi
Anticoagulan Therapy in Primary Care	Ana Sofia Pena, Vishal Mallusingh Baghele
BRITE: BR – 5	KASIMPASA ROOM 2
Chairs:	Hans Thulesius, Muharrem Ak
Self Care	Firdous Jahan, Ruth Munoz Maya, Rahul Arora
WORKSHOP	KASIMPASA ROOM 3
The Resistant Patient: How to Improve Your Interaction in A Difficult Situation	Siggy Rausch, Nico Haas, Monique Aubart
WORKSHOP	KASIMPASA ROOM 4
Management of “Cross-Border” Children`s Immunization Schedule	Gheorghe Gindrovel A Dumitra, Dana Stefana Popescu, Sandra Alexiu, Cristina Barbu, Daniela Stefanescu, Dorica Sandutu, Maria Lup, Anca Deleanu, Raluca Zoitanu
WORKSHOP	KASIMPASA ROOM 5
Workshop On Addressing The Inverse Care Law: Innovative Teaching on Working In Areas of Deprivation And With Marginalised Groups	Austin O Carroll, Patrick O Donnell, Fiona O Reilly, Suzanne Barror, Cathy Cullen, John Latham, Louise Malone, Anne Macfarlane, Neasa Mcdonagh, Ming Rawat
WORKSHOP	BALAT ROOM
Health Literacy: Finding The Right Words For Better Health	Fatma Gökşin Cihan, Dursun Çadırcı, Didem Kafadar
WORKSHOP	HASKOY ROOM
Quality Indicators for Family Practice	Zekeriya Aktürk, Ebru Yılmaz
WORKSHOP	SUTLUCE ROOM 1
The Role of Training In A Hospital Setting During Vocational Training For General Practitioners In Europe	Johan Buffels, Eveline Boogaerts
WORKSHOP	SUTLUCE ROOM 2
Professional Identity Formation In Medical Education: Implications For Teachers	Pieter Barnhoorn, Chris Walinga
ORAL PRESENTATION	AVO 1
OP-124 - OP-131	Chairs: Amanda Barnard, Nil Tekin

SATURDAY, OCTOBER 24, 2015**09:00-10:15**

ORAL PRESENTATION	AVO 2
OP-132 - OP-138	Chairs: Allyn Walsh, Mustafa Fevzi Dikici

ORAL PRESENTATION	AVO 3
OP-139 - OP-146	Chairs: Ayşe Çaylan, Yeltekin Demirel

SATURDAY, OCTOBER 24, 2015**10:30-11:00**

KEYNOTE LECTURE	HALIC AUDITORIUM
Modiators:	Micheal Kidd, Arzu Uzuner
Role of Academia, Science, Ethics and Mentor for the Future of Medicine	Dr. Emin Kansu

11:00 – 11:30	COFFEE BREAK
----------------------	---------------------

SATURDAY, OCTOBER 24, 2015**11:30-12:45**

SYMPOSIUM: EPRN & RESEARCH	HALIC AUDITORIUM
Multi-National Symposium By Wonca Europe-EGPRN & Wonca World-WWPR On "Organization Of The Healthcare System In Europe: What Facilitates & What Impedes The Delivery of Effective Primary Care"	Mehmet Urgan, Christos Lionis, Radost Asenova, Jean Pierre Jacquet, Knut Arne Wensaas, Nicola Buono, Anna Nager, Claire Collins, Peter Torzsa

SYMPOSIUM	SADABAT HALL
Building Primary Care In A Changing Environment: Evidence For Practice	Willemijn Schäfer, Mehmet Akman, Wienke Boerma, Dionne Kringos, Peter Groenewegen, Phameu Consortium, Qualicopc Consortium

CONFERENCE	EYUP HALL
Chairs:	Esra Saatçi, Serpil Demirağ
Quaternary Prevention: The Basis For Its Operationalization In The Doctor-Patient Relationship	Armando Henrique Norman, Charles Dalcanale Tesser
Evidence Based Medicine in Primary Care	Aml Ahmad Salama

TURKISH TRACT	FENER HALL
Symposium: Depression Management in Family Medicine "What we do-What we can do"	Nilgün Özçakar, Vildan Mevsim, Tolga Günvar

SYMPOSIUM	TOPHANE HALL
The Role of Primary Care Physicians In Addressing Frailty Prevention In Older People	Ines Garcia Sanchez, Anna Carta, Jorge Pinto Antunes

WORKSHOP	MIMOZA HALL
What's in A Name? General Practice or Family Medicine?	Carl Steylaerts, Berk Geroglu

WORKSHOP: EQUIP	MARMARA ROOM
Health Inequalities Related To Socio-Economic Status: How Primary Care May Reduce Them	Hector Falcoff, Sara Willems, Piet Vande Bussche, Isabelle Dupie

WORKSHOP	CIBALI ROOM 1
Delivering Person-Centred Care	Nigel Joseph Mathers, Helen Jayne Stokes Lampard

SATURDAY, OCTOBER 24, 2015**11:30-12:45**

WORKSHOP	CIBALI ROOM 2
Managing Emergencies in Primary Care With Limited Resources	Panagiotis Andripoulos, Lamprini Tina, Anargyros Mariolis, Maria Tsironi
BRITE: BR – 8	KASIMPASA ROOM 1
Chairs:	Sara Rigon, Şehnaz Hatipoğlu
Learning by Experiences in Different Practice Areas	Martins Moreira, Pedro Caetano, Sara Rigon, Laura Montesinos Ramon, Burcu Başaran, Clare Wilson
BRITE: BR – 18	KASIMPASA ROOM 2
Chairs:	Vildan Mevsim, Anneli Ratsep
Communication in Primary Care	Hasan Hüseyin Şahin, Nazan Karaoğlu
WORKSHOP	KASIMPASA ROOM 3
How To Remain Patient-Centered While Using Electronic Health Records (EHR)	Cédric Lanier, Melissa Dominicé Dao, Noëlle Junod Perron
WORKSHOP	KASIMPASA ROOM 4
Providence For A Pilot Program: A New Class For Medical Students Named 'Being Young, Staying Young'	Yeşim Uncu, Züleyha Alper, Zehra Dağlı, Canan Tuz, Pınar Topsever
WORKSHOP	KASIMPASA ROOM 5
Developing a Scientific Network for Young General Practitioners: Opportunities and Obstacles – The Danish experience	Ulrik Bak Kirk, Mads Dannesbo, Christina Svanholm, Gazelle Maghsoudi, Karolina Lewandowska
WORKSHOP	BALAT ROOM
Recruiting Healthy Volunteers to Clinical and Epidemiological Studies And Receiving Personal Consent According to International and National Regulations	Mümtaz Mazırcıoğlu, Neşe Yeniçeri
WORKSHOP	HASKOY ROOM
"Keep the Flame" Avoiding Burnout and Promoting Happy Doctors	Dimitrios Alepidis, Veronika Rasic, Alexandra Tsipou, Ivana Babic, Emna Zarrad
WORKSHOP	SUTLUCE ROOM 1
Do The Women Doctors Have The Equal Opportunities For Practice, Research And Leadership In Family Medicine In Europe?	Nil Tekin, Amanda Barnard, Amanda Howe, Zorayda Leopanda
WORKSHOP	SUTLUCE ROOM 2
What Happens In The Bedroom? Can You Solve The Mystery?	Elle Mall Keevallik, Maili Jorro
ORAL PRESENTATION	AVO 1
OP-147 - OP-155	Chairs: Adam Windak, Serap Çiftçili
ORAL PRESENTATION	AVO 2
OP-156 - OP-164	Chairs: Oana Sever Cristian, Ümit Aydoğan
ORAL PRESENTATION	AVO 3
OP-165 - OP-172	Chairs: Dilek Toprak, Erkan Melih Şahin
12:45 – 14:00	LUNCH BREAK

SATURDAY, OCTOBER 24, 2015

14:00-15:15

HALIC AUDITORIUM	HALIC AUDITORIUM
Cuban Health System	Moderator: Dilek Güldal

SYMPOSIUM	SADABAT HALL
Strategies To Manage Cross-Border/Migrant Children Immunization Schedule	Gheorghe Gindrovel A Dumitra, Dana Stefana Popescu, Sandra Alexiu, Dorica Sandutu, Daniela Stefanescu, Anca Deleanu, Maria Lup, Raluca Zoitanu, Cristina Barbu

SYMPOSIUM	EYUP HALL
COPD Symposium	Jim Reid, Miguel Román Rodríguez, Svein Høegh Henrichsen, Ioanna Tsiligianni, Jaime Correia De Sousa

Turkish Tract	FENER HALL
Chairs:	Cahit Özer, Serdar Öztora
Conference: Healthy Lifestyle Behaviors and the Role of the Family Medicine	Nafiz Bozdemir
Conference: Use of Abbreviations for Database of Medical and Health Science Journals	Kurtuluş Öngel

SYMPOSIUM	TOPHANE HALL
Clinical Management of Elderly People With Diabetes - PCDE Symposium	Leocadio Rodriguez Manas, Berry Van Der Steen, Serap Çiftçili

TURKISH TRACT	MIMOZA HALL
Workshop: Family Medicine Residency Training in Primary Care Settings: Family Health Centers for Teaching	Serap Ciftçili, İsmail Hamdi Kara, Tolga Günvar, Okay Başak

WORKSHOP: UEMO&EFPC	MARMARA ROOM
Joint European Union of General Practitioners (UEMO), European Forum for Primary Care (EFPC) & WONCA Europe Workshop on the Rational Use of Medicines Within Primary Care	Diederik Aarendonk, Anna Stavdal, Nena Kopcevar Gucek, Isabelle Moulon

WORKSHOP	CIBALI ROOM 1
Who Will Care About The Caregiver?	Özden Gökdemir, Ülkü Bulut, Olgu Aygün, Renata Pavlov, Ana Nunes Brata, Hadiye Küçükkaragöz, Dilek Güldal

SATURDAY, OCTOBER 24, 2015

14:00-15:15

Workshop	CIBALI ROOM 2
Which Patients With Head Injury Need CT Imaging And When Is Watchful Waiting In General Practice A Safe Alternative?	Miranda Kurver, Willem Draijer

BRITE: BR – 9	KASIMPASA ROOM 1
Chairs:	Hülya Akan, Altuğ Kut
Chronic Communicable Diseases (HIV, TBC etc.)	Abdul Hafiz Mohamad Gani, Lenche Zdravko Janeva

SATURDAY, OCTOBER 24, 2015**14:00-15:15**

WORKSHOP: WWP ON RESEARCH	KASIMPASA ROOM 2
Workshop On Current Status, Issues, Barriers, Challenges And Way Forward For Primary Care Research Globally And In Europe	Waris Qidwai, Mehmet Ungan

WORKSHOP: EURACT	KASIMPASA ROOM 3
Multimorbidity in Family Practice – Educational Needs”	Ruth Kalda, Jáchym Bednář, Elena Frolova, Fransesco Carelli

WORKSHOP	KASIMPASA ROOM 4
The Adolescent Years..... Guiding Your Child And Your Teenage Patient Through Adolescent And Young Adulthood	Enda Murphy, Kandan Loganathan, Patrick Paddy Halligan

WORKSHOP: EUROPREV	KASIMPASA ROOM 5
Community Based Preventive Activities And The Role Of The GP: A Europrev Workshop	Ton Drenthen, Karolien Van Den Brekel, Mateja Bulc, Eva Jurgova

WORKSHOP: EHEALTH	BALAT ROOM
How Does Coding Support The Key Tasks of The GP And Improve Patient Care?	Ilkka Kunnamo, Karen Kinder, Ferdinando Petrazzuoli, Fernando Alonso Lopez, Angel Ruiz Téllez

WORKSHOP	HASKOY ROOM
Integrating a Research Career Into Practice	Eugene Yee Hing Tang, Victoria Welsh, Hannah Fox, Rakesh Modi, Camille Gajria

WORKSHOP	SUTLUCE ROOM 1
Experience Based Learning During The Family Medicine Clerkship: Are You Experienced?	Chris W. Walinga, Pieter C. Barnhoorn, Marieke H. de Jong

WORKSHOP	SUTLUCE ROOM 2
Factors Influencing The Career Decisions Of Young Female General Practitioners. Is There Variation Within European Settings?	Dudley James Graham, Amanda Barnard

ORAL PRESENTATION	AVO 1
OP-173 - OP-180	Chairs: Karen Flegg, Erol Aktunç

ORAL PRESENTATION	AVO 2
OP-181 - OP-188	Chairs: Hector Falcoff, Nezih Dağdeviren

ORAL PRESENTATION	AVO 3
OP-189 - OP-196	Chairs: Sara Williems, Zekeriya Aktürk

SATURDAY OCTOBER 24, 2015**15:30-16:45**

GRAND SESSION	HALIC AUDITORIUM
WONCA Europe Anniversary Project Presented by EQUIP	

GRAND SESSION	SADABAT HALL
Moderator:	Micheal Kidd
The Future Organization Of Family Physicians: How Do Meet The Needs Of Family Physicians/General Practitioners	Maria Fernández-García, Ljubin Sukriev

SATURDAY OCTOBER 24, 2015**15:30-16:45**

GRAND SESSION	EYUP HALL
Moderator:	Niels Kristian Kjær
War, Immigrants and Ethnicity: Effects on Primary Care	Oana Sever-Cristian, Jonah Yaphe, Şebnem Korur Fidanç

GRAND SESSION	FENER HALL
Moderator:	Roar Maagaard
Wonca Europe Special Interest Groups: Contribution to Family Medicine	ESPCG Niek De Vit, IPCRG Jim Reid, EAACI Dermot Ryan

GRAND SESSION	TOPHANE HALL
Moderator:	Allyn Walsh
Projection on Specialty Training In Family Medicine	Maureen Baker, Okay Başak

16:45 – 17:15	COFFEE BREAK
----------------------	---------------------

SATURDAY OCTOBER 24, 2015**17:15-18:30**

WORKSHOP: EGPRN&VDGM	HALIC AUDITORIUM
Research by New and Future GPs Incorporating the 2015 Vasco da Gama Movement Junior Researcher Award	Peter A Sloane, Persijn Honkoop, Harris Lygidakis, Ivana Babic, Ana Luisa Neves

SYMPOSIUM	SADABAT HALL
Common Zoonoses In Family Medicine. Problems And Managment	Panagiotis Andripoulos, Vedat Turhan, Maria Tsironi

SYMPOSIUM	EYUP HALL
Transforming Primary Health Care In The World Largest Archipelago - Road Map For The Establishment Of Primary Care Physicians In Indonesia	Indah S Widyahening, Dhanasari Vidiawati, Herqutanto Herqutanto, Monika Saraswati Sitepu, Novana Perdana Putri

SATURDAY OCTOBER 24, 2015**17:15-18:30**

TURKISH TRACT	FENER HALL
Moderator:	Okay Başak
Panel A 20 Year Old Journey: The Turkish Journal of Family Practice	Ümit Aydoğan, Zeynep Vural Tuzcular, Pinar Topsever, Mehmet Akman, Dilek Güldal Birgül Coşkun, Işık Gönenç, Emrah Kırımlı

SYMPOSIUM	TOPHANE HALL
Dysphagia As A Geriatric Syndrome: A White Paper Position Agreements Between EUGMS And ESSD For GP	Jean Claude Leners, Pere Clave, Aubart Monique, Rausch Siggy, Patrick Tabouraing

WORKSHOP	MIMOZA HALL
Vaccine Advocacy The Bridge Between Vaccine Refusal And Social Norms Awareness	Valeria V Herdea, Liliana Barbacariu, Ileana Brinza, Emiliana Costiug, Ioan Muresan, Raluca Ghionaru

WORKSHOP: WOMEN & FAMILY MEDICINE	MARMARA ROOM
Professional Resilience Of Female Family Doctors During Lifecycle Transition Events	Alice Shiner, Amanda Howe, Jessica Watson, Noemi Doohan

SATURDAY OCTOBER 24, 2015**17:15-18:30**

WORKSHOP	CIBALI ROOM 1
Movie Clips to Teach Medical Professionalism: From Emotions To Reflection And Attitudes. A Faculty Development Workshop	Pablo Gonzalez Blasco, Olgun Goktas, Graziela Moreto, Rosana Irie

WORKSHOP	CIBALI ROOM 2
Toxicology in Family Medicine: Treating the Occasional Overdose	Victor K Ng, Susanne Cording

BRITE: BR -11	KASIMPASA ROOM 1
Chairs:	Isabelle Dupie, Erdiñç Yavuz
Electronic Health Records	Adeel Nazir Ahmad, Cemal Kavasogullari, Erdiñç Yavuz

BRITE: BR – 10	KASIMPASA ROOM 2
Chairs:	Mohammed Abdel Rasoul Tarawneh, Ramazan Tetikçok
Clinical Inertia	Valerija Bralic Lang, Giray Kolcu, Mohammed Abdel Rasoul Tarawneh , Murat Altuntaş , Miro Hanzevacki Hanzevacki

WORKSHOP	KASIMPASA ROOM 3
Genetics on Primary Care	Sara Almeida Magalhães, Susana Reis Gonçaves, Sónia Lima Cost

WORKSHOP	KASIMPASA ROOM 4
Infection Prevention In General Practice; An Unbridgeable Gap Between Theory And Practice?	Masja Loogman, Stijn Van Den Broek, Margriet Bouma

WORKSHOP	KASIMPASA ROOM 5
Health Inequalities Related To Socio-Economic Status: How Primary Care May Reduce Them	Hector Falcoff, Sara Willems, Piet Vande Bussche, Isabelle Dupie

SATURDAY OCTOBER 24, 2015**17:15-18:30**

WORKSHOP: RURAL HEALTH	BALAT ROOM
Rural Proofing for Health Policy: Use of a Rural Lens - an update from the WONCA Working Party on Rural Practice	David Schmitz, Tanja Pekez Pavliško

WORKSHOP: MIGRANT CARE	HASKOY ROOM
Migration-Related Health Disparities In Immigrant Children; The Need For Community Oriented Primary Care And The Role Of The GP	Maria Van Den Muijsenbergh, Anne Meynard, Rebecca Farrington4, Viviane Martinez Bianchi, Marwa Achmed, Guus Busser, Eldine Oosterberg

WORKSHOP: EQUIP	SUTLUCE ROOM 1
Quality In My Practice. How Do I Start?	Piet Vanden Bussche, Andrée Rochefort, Piet Vanden Bussche, Andrée Rochefort

WORKSHOP	SUTLUCE ROOM 2
A Workshop on Significant Events in General/Family Practice (Primary Care): Analysis of the Good-The Bad-The Ugly	David G Moores, Mirella C Chiodo

ORAL PRESENTATION	AVO 1
OP-197 - OP-205	Chairs: Waris Qidwai, Hakan Yaman

SATURDAY OCTOBER 24, 2015**17:15-18:30**

ORAL PRESENTATION	AVO 2
OP-206 - OP-214	Chairs: Manfred Maier , Kamile Marakoğlu

ORAL PRESENTATION	AVO 3
OP-215 - OP-223	Chairs: Firdous Jahan, Süleyman Görpelioğlu

OCTOBER 25, 2015**09:00-10:15**

SYMPOSIUM	HALIC AUDITORIUM
How To Implement Guidelines And Training Initiatives In Practice: Learning From The RESTORE Project	Christopher Dowrick, Christos Lionis, Erik Teunissen

PANEL	SADABAT HALL
Correct Exercise is Medicine!	Hatice Kurdak, Sevgi Özcan, Sanlı Sadi Kurdak

SYMPOSIUM: EGPRN	EYUP HALL
Dementia Management In The Primary Care Setting Across Europe	Ferdinando Petrazzuoli, Louise Robinson, Hans Thulesius, Nicola Buono, Shlomo Vinker, Tuomas Koskela, Thomas Frese, Jean Karl Soler, Eugene Yee Hing Tang, Kathryn Hoffmann, Diego Schrans, Radost Asenova, Jette Ahresen, Jean Yves Le Reste, Athina Tatsioni, Peter Torzsa, Clarie Collins, Bjorn Lichtwarck, Donata Kurpas, Daniel Pinto, Claudia Iftode, Davorina Petek, Quinti Foguet Boreu, Sven Streit, Harm Van Marwijk, Pemra Unalan, Gulsen Ceyhun Peker, Miro Hanzevacki

SYMPOSIUM	FENER HALL
Is Diabetes the Index Disease? Co- and Multimorbidity in Diabetic Individuals - PCDE Symposium	Frans Pouwer, Manel Mata, Samuel Seidu

OCTOBER 25, 2015**09:00-10:15**

TURKISH TRACT	MIMOZA HALL
Course: Short Pediatric Musculoskeletal Examination Technique in Primary Care: PGALS (pediatric Gait, Arm, Leg, Spine)	Demet Merder Coşkun, Özge Keniş Coşkun, Evrim Karadağ Saygi

TURKISH TRACT	MARMARA ROOM
Workshop: Educational Family Health Center Integrated to an University Implementation and Research Center	Kurtuluş Öngel, Güney Aktaş

WORKSHOP	CIBALI ROOM 1
Theatre of the Oppressed Workshop	Austin O Carroll, Patrick O Donnell

WORKSHOP	CIBALI ROOM 2
Training Clinical Communication Skills With Simulated Patients; Sharing The Acibadem University Experience	Pinar Topsever, Sirin Parkan, Demet Dinc, Efe Onganer

WORKSHOP: VdGM	KASIMPASA ROOM 1
Developing Resources to Facilitate Change Management in General Practice	Peter A Sloane, Claire Marie Thomas, Christofer Patrick Reichel, Yusianmar Mariani, Canan Tuz

OCTOBER 25, 2015**09:00-10:15**

WORKSHOP	KASIMPASA ROOM 2
The Right Words To Promote Vaccination	Sandra Adalgiza Alexiu, Arzu Uzuner, Dilek Guldal, Christos Lionis

WORKSHOP	KASIMPASA ROOM 3
How To Establish An Outpatient Clinic For The Elderly, Measures to Take	Didem Kafadar, Hakan Yaman

WORKSHOP	KASIMPASA ROOM 4
GPathome: How To Get Evidence Based Patient Education In Our Pocket	Roy Beijaert, Ton Drenthen

WORKSHOP	KASIMPASA ROOM 5
Staying Young: Empowering General Practitioners And Family Doctors To Reinvent Their Careers Using The Theory Of Optimising Professional Life	Lesley M Piko, Karen Flegg

WORKSHOP EUROPREV	BALAT ROOM
Prevention of Mental Health Problems In Family Medicine	Mateja Bulc, Lodewijk Pas

WORKSHOP	HASKOY ROOM
Electronic Primary Care Guidelines: Experiences Of Translation And Adaptation In Different Settings	Rabia Kahveci, Ilkka Kunnamo, Nicole Dekker, Roman Schlager, Duygu Ayhan Baser

ORAL PRESENTATION	AVO 1
OP-224 - OP-230	Chairs: Radost Asenova, İsmail Hamdi Kara

ORAL PRESENTATION	AVO 2
OP-231 - OP-237	Chairs: Eda Çelik Güzel, Nafiz Bozdemir

OCTOBER 25, 2015**09:00-10:15**

ORAL PRESENTATION	AVO 3
OP-238- OP-244	Chairs: Mümtaz Mazıcıoğlu, Mehmet Akman

OCTOBER 25, 2015**10:30-11:00**

KEYNOTE LECTURE	HALIC AUDITORIUM
Moderators:	Anna Stavdal, Resat Dabak
What has changed in the role of family physician and general practitioner	Jan De Maeseneer

11:00 – 11:30	COFFEE BREAK
----------------------	---------------------

SUNDAY, OCTOBER 25, 2015**11:30-12:45**

PANEL	HALIC AUDITORIUM
Does Discipline Have The Power To Maintain Institutions Young?	Patrick Tabouring, Hirsia Farghadani, Siggy Rausch

PANEL	SADABAT HALL
Vaccination Of The Migrant Child - A Challenge	Sandra Adalgiza Alexiu, Daniela Ștefănescu, Dorica Sănduțu, Cristina Barbu, Gindrovel Dumitra, Dana Ștefana Popescu, Raluca Zoițanu, Anca Deleanu, Maria Lup

SUNDAY, OCTOBER 25, 2015**11:30-12:45**

TURKISH TRACT	EYUP HALL
Oral Presentations OP-272 – OP-280	Chairs: Tolga Günvar, Ruhuşen Kutlu

TURKISH TRACT	FENER HALL
Oral Presentations OP-281 – OP-289	Chairs: Melahat Akdeniz, Nilgün Özçakar

TURKISH TRACT	MIMOZA HALL
Chairs:	Murat Altuntaş, Refik İmamecioğlu
BRITE – 2: Assessment Of Medical Practice in Low Prevalence Diseseses In Primary Care	Giray Kolcu
BRITE – 3: Safety Of Family Medicine Centres - Determination Of The Situation	Giray Kolcu

WORKSHOP	MARMARA ROOM
A Visit to the Temple: The Cardiac Exercise Stress Laboratory	Vincent Ted Leon, Ruth Wilson

WORKSHOP	CIBALI ROOM 1
Reviews - Are there different types?	Mary G Kearney, Mary M Hanratty

WORKSHOP	CIBALI ROOM 2
	Işık Gönenç, Zeynep Tuzcular Vural

SUNDAY, OCTOBER 25, 2015**11:30-12:45**

WORKSHOP	KASIMPAŞA ROOM 1
Tips on Managing Students in your Rural Practice	Christos Lionis, Janko Kersnik, Zalika Klemenc Ketis, Gunta Ticmane, Lars Agreus, Elizabeth Swensen, Jose Manuel Lopez Abuin

BRITE: BR – 13	KASIMPASA ROOM 2
Chairs:	Niels Kristian Kjær, Çiğdem Apaydın Kaya
Management in Primary Care	Paul Irving Brown, Nilgun Yapan Goral, Gerard Nguyen, Patricia McWalter

WORKSHOP: EURACT	KASIMPASA ROOM 3
Learning Needs For Cultural Competence In Family Medicine, So To Develop A Teaching Curriculum In Culturally Responsive Healthcare For Medical Education In Europe	Jachym Bednar, Ruth Kalda, Elena Frolova, Francesco Carelli

TURKISH TRACT	KASIMPASA ROOM 4
Chairs:	Mehtap Kartal, Züleyha Alper
BRITE: 1 Adulthood Vaccines: Do We Suggest To Our Patients And Do They Accept?	Hülya Akan

WORKSHOP	KASIMPASA ROOM 5
Patient Safety In Primary Care: Get Started	Isabelle Dupie, Andree Rochfort

SUNDAY, OCTOBER 25, 2015

11:30-12:45

WORKSHOP	BALAT ROOM
Effective Interventions With Survivors Of Violence- Primary Care Interventions That Empower Patients, Increase Provider Efficacy, And Reduce Morbidity In A Residency Curriculum	Patrick S Mcfarlane

WORKSHOP	HASKOY ROOM
Dealing With Intimate Partner Violence From A Family Perspective In Different Cultural Contexts	Lodewijk Pas, Amanda Barnard, Lorraine Bacchus, Carmen Fernandez Alonso, Sylvie Lo Fo Wong, Nena Kopcovar, Joyce Kenkre, Tanja Pekez Pavlisko, Angela Taft, Abimbola Silva, Omneya El Sharif

SUNDAY, OCTOBER 25, 2015

11:30-12:45

ORAL PRESENTATION	AVO 1
OP-245- OP-253	Chairs: A. Gülsen Ceyhun Peker, Oğuz Tekin

ORAL PRESENTATION	AVO 2
OP-254 - OP-262	Chairs: Didem Sunay, Nazlı Şensoy

ORAL PRESENTATION	AVO 3
OP-263- OP-271	Chairs: Füsün Sözen, Nejat Demircan

SUNDAY, OCTOBER 25, 2015

12:45-14:30

CLOSING CEREMONY	HALIC AUDITORIUM
-------------------------	-------------------------

CONFERENCES

CON-001

Stroke prevention in AF - state of the science

Richard Hobbs

University of Oxford

BACKGROUND: Atrial fibrillation (AF) is the commonest cardiac arrhythmia, and is associated with high risk of embolic stroke (cause in 15% of strokes), which anticoagulation will reduce by about two-thirds. To have a public health impact, patients with AF needs efficient and correct identification, with appropriate treatment directed at those at most risk of stroke.

The evidence: The prevalence of AF (UK primary care) is 1.7% in a randomly sampled population of those over 45, ranging from 1% in the 55-64 year olds, 1.5% in ages 65-74, 8% in ages 76-84, and 12% over 85. AF stroke prevention trials show that anticoagulation with warfarin is significantly more effective than aspirin in prevention of stroke in atrial fibrillation (AF), particularly in those over the age of 75. Studies based in primary care have recently validated the best screening strategies for AF. A range of newer anticoagulants are now available (direct thrombin II inhibitors and Factor Xa inhibitors) which do not require any INR monitoring, and are at least as effective and probably safer than warfarin.

Implications: Despite the strong evidence base on who to treat and how, patients at risk are currently under-treated in terms of both initiation of anticoagulation and INR control if treated.

Keywords: atrial fibrillation, stroke, risk, anticoagulation

CON-002

Quaternary prevention: the basis for its operationalization in the doctor-patient relationship

Armando Henrique Norman¹, Charles Dalcanale Tesser²

¹Durham University, Anthropology Department, UK

²Federal University of Santa Catarina, Public Health Department, Brazil

The quaternary prevention (P4) concept is gaining prominence since its official inclusion in WONCA dictionary in 2003. The current debate over the Evidenced-based Medicine (EBM) paradigm, depicted as movement in crises in the BMJ, has increased the doctors' responsibility in the face of greater uncertainty due to a lack transparency in the research protocols, participant bias selection, and publication bias and so on. Thus, our aim is to present the clinical and conceptual basis to operationalize quaternary prevention in primary health care services and teaching contexts and/or residency programmes in family medicine. The enhanced Calgary-Cambridge model of medical consultation is used as an organizational matrix to insert quaternary prevention in two moments: diagnosis and care plan. To strengthen quaternary prevention in these two consultation moments, the discussion explores: a) conceptual disease axes (pathological, physiopathological, semiological and epidemiological); b) illness explanatory approaches (ontological and dynamic); and c) suffering in relation to time (present and future), differentiating present lived suffering from concerns about future health. We conclude that despite limitations of any consultation framework, formalising quaternary prevention in the consultation process can help reduce the diagnostic and prescribing automatism, which has medicalized many illness expressions in the routines of primary health care services.

Keywords: Physician-Patient Relations; Medicalization; Primary Health Care; Family Practice; prevention & control

CON-003

The Future of Family Medicine - a Contextual View 50 Years From Now

Carl Steylaerts

WONCA Europe

Imagine 50 years from now - 2065.

Great technological advances have moved most of the (organ) specialties to extinction.

Giving birth is obsolete, cloning is the trend. Drug (ab)use is obsolete since the introduction of the Memory Loss Pill - addiction is simply forgotten. And bodies are made up of steel, glass fibre and use photosynthesis as an energy source - meet the Singularity.

Family Medicine is thriving more than ever. How come? What were the driving forces?

In what context are we living in 2065?

Are we close to Kardashev phase 1? What do we do to pass our time?

Are there new illnesses or diseases? What do we do about that?

Will there be a pandemic? What kind?

Can literature illuminate us? Which authors?

The future is notoriously uncertain. But has been thought of, somewhere... maybe now!

Keywords: Future; family medicine; policy

CON-004

Meeting the diagnostic problems introduced by increased aminotransferases or imaging tests indicating liver steatosis

Christos Lionis

Department of Social and Family Medicine, Faculty of Medicine, University of Crete, Greece

Justification

Abnormal values of transaminases and other liver biochemical test results is a common reason for a visit to a General Practitioner (GP). It is essential for the GP to comprehend the potential morbidity, infection, metabolic or malignant morbidity that is likely behind the abnormal tests and which a diagnostic algorithm should be followed. This remains an interesting and challenging subject in General Practice. The GP should be aware of the a priori probability of the underlined causes of the abnormal tests while requires background information about the diagnostic values of the tests in the area of his/her practice.

Content

This conference that is supported by the European Society Primary Care Gastroenterology (ESPCG) aims to clarify certain issues on this clinical subject. Invited speakers from this European Network will offer their expertise in an interactive manner with the audience, using case study approaches.

Keywords: liver steatosis, general practice, morbidity

CON-001

Stroke prevention in AF - state of the science

Richard Hobbs

University of Oxford

BACKGROUND: Atrial fibrillation (AF) is the commonest cardiac arrhythmia, and is associated with high risk of embolic stroke (cause in 15% of strokes), which anticoagulation will reduce by about two-thirds. To have a public

health impact, patients with AF needs efficient and correct identification, with appropriate treatment directed at those at most risk of stroke.

The evidence: The prevalence of AF (UK primary care) is 1.7% in a randomly sampled population of those over 45, ranging from 1% in the 55-64 year olds, 1.5% in ages 65-74, 8% in ages 76-84, and 12% over 85. AF stroke prevention trials show that anticoagulation with warfarin is significantly more effective than aspirin in prevention of stroke in atrial fibrillation (AF), particularly in those over the age of 75. Studies based in primary care have recently validated the best screening strategies for AF. A range of newer anticoagulants are now available (direct thrombin II inhibitors and Factor Xa inhibitors) which do not require any INR monitoring, and are at least as effective and probably safer than warfarin.

Implications: Despite the strong evidence base on who to treat and how, patients at risk are currently under-treated in terms of both initiation of anticoagulation and INR control if treated.

Keywords: atrial fibrillation, stroke, risk, anticoagulation

CON-002

Quaternary prevention: the basis for its operationalization in the doctor-patient relationship

Armando Henrique Norman¹, Charles Dalcanale Tesser²

¹Durham University, Anthropology Department, UK

²Federal University of Santa Catarina, Public Health Department, Brazil

The quaternary prevention (P4) concept is gaining prominence since its official inclusion in WONCA dictionary in 2003. The current debate over the Evidenced-based Medicine (EBM) paradigm, depicted as movement in crises in the BMJ, has increased the doctors' responsibility in the face of greater uncertainty due to a lack transparency in the research protocols, participant bias selection, and publication bias and so on. Thus, our aim is to present the clinical and conceptual basis to operationalize quaternary prevention in primary health care services and teaching contexts and/or residency programmes in family medicine. The enhanced Calgary-Cambridge model of medical consultation is used as an organizational matrix to insert quaternary prevention in two moments: diagnosis and care plan. To strengthen quaternary prevention in these two consultation moments, the discussion explores: a) conceptual disease axes (pathological, physiopathological, semiological and epidemiological); b) illness explanatory approaches (ontological and dynamic); and c) suffering in relation to time (present and future), differentiating present lived suffering from concerns about future health. We conclude that despite limitations of any consultation framework, formalising quaternary prevention in the consultation process can help reduce the diagnostic and prescribing automatism, which has medicalized many illness expressions in the routines of primary health care services.

Keywords: Physician-Patient Relations; Medicalization; Primary Health Care; Family Practice; prevention & control

CON-003

The Future of Family Medicine - a Contextual View 50 Years From Now

Carl Steylaerts

WONCA Europe

Imagine 50 years from now - 2065.

Great technological advances have moved most of the (organ) specialties to extinction.

Giving birth is obsolete, cloning is the trend. Drug (ab)use is obsolete since the introduction of the Memory Loss Pill - addiction is simply forgotten. And bodies are made up of steel, glass fibre and use photosynthesis as an energy source - meet the Singularity.

Family Medicine is thriving more than ever. How come? What were the driving forces?

In what context are we living in 2065?

Are we close to Kardashev phase 1? What do we do to pass our time?

Are there new illnesses or diseases? What do we do about that?

Will there be a pandemic? What kind?

Can literature illuminate us? Which authors?

The future is notoriously uncertain. But has been thought of, somewhere... maybe now!

Keywords: Future; family medicine; policy

CON-004

Meeting the diagnostic problems introduced by increased aminotransferases or imaging tests indicating liver steatosis

Christos Lionis

Department of Social and Family Medicine, Faculty of Medicine, University of Crete, Greece

Justification

Abnormal values of transaminases and other liver biochemical test results is a common reason for a visit to a General Practitioner (GP). It is essential for the GP to comprehend the potential morbidity, infection, metabolic or malignant morbidity that is likely behind the abnormal tests and which a diagnostic algorithm should be followed. This remains an interesting and challenging subject in General Practice. The GP should be aware of the a priori probability of the underlined causes of the abnormal tests while requires background information about the diagnostic values of the tests in the area of his/her practice.

Content

This conference that is supported by the European Society Primary Care Gastroenterology (ESPCG) aims to clarify certain issues on this clinical subject. Invited speakers from this European Network will offer their expertise in an interactive manner with the audience, using case study approaches.

Keywords: liver steatosis, general practice, morbidity

CON-005

Evidence Based Medicine in Primary Care

Aml Ahmed Salama

Faculty of Medicine, Family Medicine Department, Menoufia University, Egypt.

In my own practice as a lecturer of family medicine, one of the most important methods of counting medical education and build up own experience is Evidence Based Medicine. According to Sackett, et al., 2001, Evidence-based medicine is the integration of best research evidence with clinical expertise and patient values". Studies showed that general physicians identified up to sixteen needs for new clinically important information in just half a day at a rate of two questions for every three patients they come across. About half of their questions were related to therapeutics and a quarter to diagnosis. EBM is aiming at: Liberation from tradition, The use of randomized controlled trials, as well as systematic reviews and meta-analysis. Practicing EBM consists of five steps: Asking a question, Collection information to answer the question, Evaluating the information for the relevance and validity, Applying the information to the patient and Evaluating the effect. Converting the patient's problem into clinical question: in specific format (PICO format). P patient problem. I Intervention or exposure. C Comparison intervention or exposure. O Outcome the patient looks. To effectively change your authority based practice we have to Evaluate your own practice, Open your mind to ideas of change, Develop an information network of high quality and relevant information. Categories of EBM Questions: four categories of EBM questions Therapy: About which treatment to be given, and the outcome of different treatment options. Diagnosis: solves questions about degree to which a test is reliable and clinically useful. Example: search for the best diagnostic test for Alzheimer's disease. Etiology: for a possible cause of disease. Prognosis: Answers questions about a patient's life span and quality of life. The best study design needed to answer the clinical question will be also included.

Keywords: Evidence, Based, Medicine, Primary Care.

CON-006

Issues, Challenges and way forward for Primary Care Research: A global Perspective

Waris Qidwai

Aga Khan University, Karachi, Pakistan

Research in primary care is neglected at the level of Primary Care Practitioners as well as policy makers and academic institutions. 90% of resources are used for hospital based research and 10 % are utilized at primary care level, whereas 90% of the health related issues need to be addressed are in primary care. This is known as 90/10 gap.

Patients present with multiple co-morbidities at primary care clinics and one has to manage patients with limited resources and diagnostic uncertainty. Data needed to practice at primary care level should be therefore derived from Primary Care Practices. Hospital based data is unlikely to be usable at the primary care level. Guidelines are often developed based on hospital based data and therefore, cannot be used at primary care level. Cost; benefit ratio is in favor of investing in primary care research.

This presentation will address issues and challenges which are in the way of promoting research in primary care. Capacity building in primary care research is a challenge for a lot of countries while lack of appropriate training opportunities and infrastructure are faced by others.

A lot of opportunities exist in primary care research since a lot of work need to be done in this area. and A framework for way forward for primary care research globally is required that will address issues from a holistic viewpoint.

Keywords: Primary Care Research, Primary Care, Family Medicine Research; Research

CON-007

Use of Abbreviations for Database of Medical and Health Science Journals

Kurtuluş Öngel¹, Haluk Mergen², Utku Eser³

¹Izmir Katip Celebi University, Faculty of Medicine, Department of Family Medicine

²Izmir Tepecik Education and Research Hospital, Clinic of Family Medicine

³İKÇÜ Atatürk Education and Research Hospital Directorate

Today, it has become quite easy to get information by internet technology. However, advances in technology also leads to some stressful situations. Find the accurate and reliable information is very difficult among information pollution. Information becomes useable as it is obtained in the right way from the true sources. Especially in the field of medicine and health; the most important factor in the literature screening to get information is reaching the right database with the right magazine publishing abbreviations.

As known; there is no standard for the journal abbreviations used in the context name of the magazines printed and published electronically. In this presentation, standard approaches to acronym titles of the national and international medical and health sciences periodicals was tried to be shared.

Especially in academic upgrading our country; number of publications cited in the citation indexes are trying to be upgraded by taking part in an international directory. The importance of the correct journal abbreviations is increasing at this point.

In this presentation; it has been attempted to explain the rules to be complied with national journal abbreviations in Turkey, according to the abbreviations used by National Library of Medicine (NLM) and ISSN center.

In particular, it is very important for the new experts and academics to make a literature research on the basis of correct abbreviations. The results of this report will help shortening services and their products, articles accompanying bibliography and the guiding document identification.

Keywords: Documentation, literature, medicine, abbreviations, magazines

CON-008

Communicating with patients with multiple chronic co-morbidity

John Yaphe¹, Maria José Ribas²

¹Community Health, School of Health Sciences, University of Minho, Braga, Portugal

²Garcia de Orta Family Health Unit, President, Clinical Council, Porto Ocidental Primary Health Care Group, Porto, Portugal

BACKGROUND: As chronic disease prevalence increases, the task of caring for patients with multiple comorbidities becomes more complex. Electronic counselling is increasing in importance as a cost-effective means of supporting patients with chronic diseases.

OBJECTIVES: The purpose of this study was to analyze the use of electronic counselling in caring for patients with chronic disease to determine patient needs when facing chronic disease and effective communication strategies that family doctors may use to meet the needs.

METHODS: The anonymized case files (n=1850) of one electronic counsellor were searched for elements of care of chronic disease. Patient needs were identified along with communication strategies used by the family physician to meet these needs.

RESULTS: Text analysis revealed patient needs for emotional support, information about the disease, specific instructions regarding care, resource management, and plans for ongoing care. Physician skills required to meet these needs included active listening, validation, support, advice giving, resource management, and long-term availability.

DISCUSSION: Electronic counselling is an efficient and cost effective way of communicating with patients facing chronic disease. These findings may have implications for the training of physicians involved in chronic care management and for the planning of services.

Key words: Electronic counselling, chronic disease

CON-009

Healthy Lifestyle Behaviors and the Role of the Family Medicine

Nafiz Bozdemir

Cukurova University Faculty of Medicine Family Medicine

In the history of medicine and health services development, people try to heal all sick people before, then they research to protect them from diseases. All efforts are directed to people as healthy sustenance purposes. To do this, people get sick of being healthy throughout their lives, so many applications that have been developed. Today these applications all of them are called healthy lifestyle.

Healthy lifestyle, the individual's health check, all behaviors that affect daily activities to choose their own health status in appropriate editing behavior.

The way of life of individuals, it also affects the quality of life as it affects survival.

The World Health Organization (WHO) estimates that 70-80% of deaths in developed countries and 40-50% of deaths in developing countries are occur due to lifestyle. This disease is the formation of bad eating habits, sedentary lifestyle, increasing bad habits, deteriorating environmental conditions and cause stressful life.

Looking at the statistics across the world in 2012; 68% of all deaths constitute non-communicable diseases. (cardiovascular diseases, cancer, diabetes and chronic lung diseases) The formation of these diseases; smoking, alcohol use, unhealthy eating and physical inactivity generate significant challenges, with the resulting metabolic and physiological changes. (elevation of arterial blood pressure, being overweight or obese, high levels of cholesterol and blood glucose)

Hypertension, diabetes mellitus (DM), coronary heart diseases and cancers in both primary and secondary protection in maintaining healthy lifestyle behaviour in the protection is great importance

The potential benefits of a healthy lifestyle;

- The mortality rate due to all causes by 40% - 65%
- Coronary heart disease by 81% - 87%
- All cardiovascular disease in %67
- The risk of stroke by 50% - 71%
- Progression of type 2 diabetes by 58% - 93%
- Cancer-related death by 36% - 60% is defined as a decrease in the range.

Nutrition, stress management, exercise, spirituality, interpersonal relationships and health responsibility among the healthy lifestyle behaviors.

In our country, usually as a secondary protection nutrition and exercise for behavior change. With the healthy lifestyle behaviors to protect health, is an important step in creating a healthy society. To do this; protecting and maintaining existing healthy situation for the importance of healthy lifestyle behavior must be noticing.

The acquisition of healthy lifestyle behavior, information, thoughts and values of individuals is subject to be modified. Therefore, individuals should be informed about the importance of healthy lifestyle behavior.

According to the Ministry of Health's 2013 Health Promotion Research in Turkey; 18 years of age and over 85.4% prefer health professionals as a source of information.

Family physicians serve continuous, coordinated and comprehensive care to the patients. About the healthy lifestyle of patients; family physicians have an important role in maintaining healthy behaviors created. They provide information about positive lifestyle changes, suggestions and support. They promote health and prevent disease through appropriate screening tests.

Last of all; family physicians should be evaluated information on healthy lifestyle behaviors, skills, attitudes and behavior. They should improve their knowledge on this subject.

Keywords: Healthy Lifestyle

CON-010

LGBTI Health and Primary Care in Turkey

Filiz Ak

Family Medicine Department, Ankara University School of Medicine, Ankara, Turkey

Gender-based approach and gender and sexual diversity needs in education and practice of family medicine discipline are important. Knowing the needs or health behaviors or health risks of Lesbian, Gay, Bisexual, Transgender, Intersex (LGBTI) adults concerning family medicine/general practice (FM/GP) is important. The purpose of this conference is to review the terms of LGBTI population, history of LGBTI activism, specific health needs, expectations and self-reported risks of LGBTI communities in order to better respond to their health concerns.

FM/GP is a medical specialty of primary care that provides continuing and comprehensive health care for the individuals of all ages and genders in the context of the family and community. Having information about health concerns and expectations of LGBT community is important in order to give a better care. Health risks of LGBTI individuals are emphasized in the guidelines of Gay & Lesbian Medical Association in USA. In Turkey, lesbians and bisexual women need to learn these risks from their physicians but there are some barriers to care that impact their health status. These barriers can be eliminated by specific education without homophobia and respecting to privacy. LGBT health is one of the basic issues of gender-based medicine and must take part in FM/GP residency programs and national guidelines.

Keywords: LGBTI health, primary care,

SYMPOSIUMS

SYM-001

COPD Symposium

Jim Reid¹, Miguel Román Rodríguez⁴, Svein Høegh Henrichsen⁵, Ioanna Tsiligianni², Jaime Correia De Sousa³

¹University of Otago, Dunedin, New Zealand

²Asites Rural Practice and Clinic of Social and Family Medicine, University of Crete, Greece

³Associate Professor Community Health, School of Health Sciences, University of Minho, Portugal

⁴Son Pisa primary Health care centre. c/ Vicente Joan Rossello 65 07011 Palma de Mallorca. Spain and IdisPa Balears research Institute

⁵IPCRG representative for WONCA-Europe. Oslo, Norway

Chronic Obstructive Respiratory Disease (COPD) is a common respiratory problem whose prevalence is increasing. It causes increasing morbidity and mortality in all countries of the world. It is principally caused by cigarette smoking. Early diagnosis and treatment is essential if we are to influence potential sufferers, and current sufferers to continue to "be young, and stay young"

The symposium will be presented by the INTERNATIONAL PRIMARY CARE RESPIRATORY GROUP and will include coverage of the following

- Diagnosis (With emphasis on earlier diagnosis) Dr Miguel Román Rodríguez (Spain)
- Investigation, including outline of spirometry Dr Svein Høegh Henrichsen (Norway)
- Smoking cessation Dr Ioanna Tsiligianni (Greece)
- Other treatments Assoc Prof Jaime Correia de Sousa (Portugal)
- Management of exacerbations Assoc Prof Jim Reid (New Zealand)

All are well known in primary care circles in Europe, especially with reference to respiratory medicine.

Keywords: COPD, diagnosis, spirometry, smoking cessation, exacerbations

SYM-002

Poorly controlled asthma

Dermot Ryan, Miguel Roman Rodríguez, Elizabeth Angier

Centre For Population Studies, University of Edinburgh

Although we have many treatments and guidelines available to us within primary care, the majority of those suffering from asthma are either poorly controlled or uncontrolled by GINA definition. Guidelines do not ignore the fact that there are a number of factors behind poor asthma control, but these are often presented to clinicians in a format which advocate step wise increments in medication without prompting the clinician to examine the reasons for poor control, always assuming that the diagnosis is correct in the first place. SIMPLER (Smoking Cessation, Inhaler technique, Monitoring, Pharmacotherapy, Life Style, Education and Support) is a simplified framework which describes a systematic approach to problem solving the patient with poor control: this is applicable both to new and existing patients. This approach also has the propensity to identify those patients for whom a standard approach to therapy may not be sufficient and thus stratify those patients who need referral to specialist care for further evaluation.

Keywords: Poorly controlled asthma; framework; problem solving

SYM-003

Developing information systems to improve allergy care

Miguel Roman Rodríguez, Elizabeth Angier, Dermot Ryan
Centro de salud Son Pisa, Palma de Mallorca, Spain

Rationale: it is impossible for GPs to keep abreast of all developments in all fields. How can we use IT to help us? Asthma and other allergic conditions have proved difficult to control for primary care professionals and patients themselves. The use of Informatics for clinical recordings is common and nearly universal in our health Systems, and present a new opportunity to develop this field and improve the management and follow up of those patients suffering with allergies. Integration of information systems could be really helpful to introduce alarms, control tests registers, objective measurements and to monitor the adherence to medications by electronic prescriptions. On a higher development level, they can also be useful to guide the clinicians in the best way to manage allergic conditions by aiding clinical decision making by incorporating guidelines and algorithms into the normal work flow of the health professionals electronic files.

I have no competing interests namely support from any organisation for the submitted work, financial relationships with any organisations that might have an interest in the submitted work in the previous three years and/or relationships or activities that could appear to have influenced the submitted work.

Keywords: allergy, information systems, clinical decision support

SYM-004

Is Diabetes the Index Disease? Co- and Multimorbidity in Diabetic Individuals - PCDE Symposium

Frans Pouwer¹, Manel Mata², Samuel Seidu³

¹Department Medical and Clinical Psychology, Tilburg University, The Netherlands

²Catalan Diabetes Association and Spanish Diabetes Society, Barcelona, Spain

³Hockley Farm Medical Practice, University of Leicester, Leicester Diabetes Centre, Leicester, U.K.

Diabetes and Mental Health:

Type 2 diabetes is associated with mental health problems in several ways. Research focus is on depression. The association between depression and type 2 diabetes is complex and probably bidirectional. To date, depression is associated with an increased risk of the development of type 2 diabetes, but the mechanism that links depression with the onset of type 2 diabetes is still unclear. There is also a debate whether we should screen for depression in diabetes. The pros and cons will be discussed in the presentation.

Diabetes and Cancer:

Diabetes and cancer share modifiable risk factors (overweight, obesity, and possibly weight change; diet; physical activity; tobacco smoking; alcohol). Diabetes might promote the neoplastic process through hyperinsulinemia, hyperglycaemia, and chronic inflammation. Some medications used to treat diabetes might affect cancer risk. Metformin, the most common therapy in patients with type 2 diabetes, is associated with reduced cancer risk when compared with other glucose-lowering therapies in observational studies. Although the evidence is limited, exogenous insulin is associated with increased cancer risk. In recent years, some of the newest anti diabetic drugs have been associated with cancer but the absolute risk is relatively low.

Diabetes and Cardiovascular Risk:

The most prevalent cardiovascular risk factors (Hypertension and dyslipidemia) will be the focus of the session. A debate is still alive considering Diabetes as a secondary prevention equivalent or not and the usefulness of Diabetes risk scales to consider a medication to treat cholesterol in that patients. And non less intense is the controversial opinions on blood pressure levels in patients with Diabetes. That lecture will provide you the latest available evidence on that matter and will invite to be part in that debate discussing about the best targets for that chronic comorbidities.

Keywords: Multi morbidity, Co morbidity, Diabetes, Depression, Cancer, Cardiovascular Disease

SYM-005

DAWN2 Symposium - PCDE

Antonio Nicolucci¹, Richard Holt², Ingrid Willaing³

¹Department of Clinical Pharmacology and Epidemiology, Consorzio Mario Negri Sud, Chieti, Italy

²Department of Diabetes and Endocrinology, University of Southampton, U.K.

³Steno Diabetes Center, Getnofte, Denmark

The impact of the psychosocial burden of diabetes is still not fully recognised. Many people with diabetes still face significant challenges in areas including self-management, adherence, access to support and involvement in care. Healthcare systems are struggling to accommodate person-centred models of care and to encourage people with diabetes to self-manage their condition. A network of international experts and organizations, build on the results of the original DAWN study and initiated the DAWN2™ study in 2011. DAWN2™ is a global study conducted in collaboration with the International Diabetes Federation (IDF), the International Alliance of Patient Organizations (IAPO), the Steno Diabetes Center and other national, regional and global partners like PCDE.

Prof. Richard Holt will highlight some methodological challenges of this global study that was performed in 17 countries, questioning 4785 health care professionals (of which 2066 primary care physicians), 8596 people with diabetes of which 7228 suffering from type 2 diabetes mellitus and 2057 family members. It will highlight the questionnaires that were used and how, which people were questioned and how and offer some insight in the performed analyses.

Ingrid Willaing will elaborate on education related issues in the different countries involved in the DANW2 study as seen in a primary and secondary care perspective.

Prof. Antonio Nicolucci will document an example of possible implementation action of DAWN2 results into practice. In Italy, the BENCH-D project results from the national DAWN2 data were used to make and utilise some tools in the field of psychosocial help for people with type 2 diabetes. Preliminary data from one region show a substantial reduction in diabetes related distress, associated with an increase in empowerment and psychological wellbeing.

These lectures related to DAWN2 study results will be a leading symposium for all those interested in the psychosocial care towards people living with diabetes.

Keywords: Diabetes, psychosocial, burden

SYM-006

EXPLORE Symposium – PCDE

Peter Schwarz¹, Johan Wens², Martin Hadley Brown³

¹Department of Prevention and Care of Diabetes at the Technical University Dresden, Germany

²Department of Family Medicine University of Antwerp, Antwerp, Belgium

³School Lane Surgery, Thetford, Norfolk; Hughes Hall, Cambridge, U.K.

Care for people living with (type 2) diabetes mellitus (T2DM) changes gradually from primarily medical guided patients directions (“you need to do this and that”) towards a model of shared decision making where a proactive health care team is in interaction with a well-informed individual living with a chronic condition. These new model aims to encourage patients’ self-management, stimulates education and enhance person-provider interaction, resulting in improved adherence and as a consequence better health care outcomes. Together, these elements improve the communication between health care professionals and informed individuals.

People with diabetes and clinicians might have different perspectives regarding the management of the focus disease. Diabetes management is complex and a challenge for both, patients and clinicians. Ineffective communication due to disparities between what clinicians emphasise and what people with T2DM consider increases the likelihood for misinterpretation and even distrust at both sides.

In this symposium we discuss the EXPLORE study (EXpert and Patient views on Living with and cOntrolling type 2 diabEtes) which was created to understand the complexity of T2DM management by discovering similarities and differences in perceptions of primary care providers and patients.

Keywords: Diabetes, Patient empowerment, Person-centeredness, Clinical communication skills

SYM-007

Clinical Management of Elderly people with Diabetes - PCDE Symposium

Leocadio Rodriguez Manas¹, Berry Van Der Steen², Serap Çiftçili³

¹Department of Geriatrics at the University Hospital of Getafe, Medicine Faculty at the University of Madrid, Spain

²Langerhans Institute, The Netherlands

³Department of Family Medicine, Marmara University Faculty of Medicine, Istanbul, Turkey

In this session, speakers will address the care of diabetes in the elderly. It is hoped that the issues around the management of diabetes in the elderly population will be addressed to ensure a more consistent quality in provision of care. The session is designed to support delegates understand the provision of a multidimensional integrated approach to the comprehensive management of diabetes in older people.

The issue of frailty will be addressed. These individuals are characterized by a combination of recent weight loss, significant fatigue, severe restriction in mobility and strength, increased propensity to falls, and increased risk of institutionalization.

A consideration will be given to the management of medicines in older people. Like all diabetes patients, older people are very individual, therefore there is a need to individualize the medication regimen so as to maintain an optimum balance between control of diabetes and other cardiovascular risk factors and the minimization of medicine related adverse events such as falls and admission to hospital or emergency departments.

Keywords: Diabetes, Elderly, Frailty, Management, Multi morbidity, Polypharmacy

SYM-008

Common zoonoses in Family Medicine. Problems and management

Panagiotis Andriopoulos¹, Vedat Turhan², Maria Tsironi¹

¹Faculty of Nursing, University of Peloponnese

²Infectious Diseases And Clinical Microbiology, GATA Haydarpaşa Training Hospital Istanbul

Justification:

Zoonoses are a common cause of acute infection in Family Medicine, especially in rural areas. Zoonoses can present with a variety of clinical presentations and may lead to life threatening complications. Purpose of this symposium is to focus on common zoonoses and discuss the clinical context of suspicion, diagnosis and treatment

Content:

The symposium will focus on common zoonoses such as Brucellosis, Tularemia and Leishmaniasis. Three formal lectures will be presented:

1. "Clinical Presentations and diagnostic puzzles in Acute Brucellosis" by Dr.P.Andriopoulos
2. "Tularaimia as a common cause of tonsillopharyngitis and cervical LAP" by Dr. Vedat Turhan
3. "Leishmaniasis as a public health threat in Europe" by Dr. M. Tsironi.

The symposium will focus on latest epidemiological data, diagnostic features of the diseases, treatment options

and clinical puzzles that any primary care physician may encounter in everyday practice especially in rural areas. Brucellosis is the most common zoonotic disease in the Mediterranean basin with a prevalence that varies between 10-20/100.00 and an estimated incidence of half a million cases annually. Tularemia has been reported in many countries of the northern hemisphere, in the Russian Federation, Kazakhstan and Turkmenistan, in most countries in eastern Europe and outbreaks comprising hundreds of cases have occurred recently in Portugal, Spain, Sweden and UN Administered Province of Kosovo (Serbia). Leishmaniasis is endemic mostly in East Africa and Asian countries, however the migration of populations due to political and financial turmoil suggest the need for enhanced surveillance. Lectures and discussion will serve to remind the importance of zoonotic diseases in family medicine and to present to family physicians a detailed account on diagnosis and treatment of them.

Keywords: Zoonoses, Brucellosis, Tularemia, Leishmaniasis

SYM-009

Anaphylaxis: A Primary Care Approach

Elizabeth Angier, Dermot Ryan, Miguel Rodriguez

Department of Immunology and Allergy, Sheffield Teaching Hospitals, Sheffield, UK.

Background

The rate of anaphylaxis is increasing globally. It is a medical emergency, so all primary care workers should be familiar with how to manage it. It is often suboptimally treated and under recognised and under diagnosed. The key learning points will be the recognition, treatment and the ongoing management of patients with an emphasis on taking an allergy focused history.

Content

The origin and meaning of the word Anaphylaxis with a brief exploration of mechanisms.

The recognition and assessment of anaphylaxis in practice. An examination of risk factors for severe anaphylaxis with emphasis on optimal control of asthma and consideration of other exacerbating co-factors.

How to make the diagnosis and possible differential diagnoses with an emphasis on taking an allergy focused clinical history - the cornerstone of diagnosis and supportive diagnostic tests.

Differences between adult and paediatric presentation and managements.

Initial treatment and management in the primary care environment. The role of intramuscular adrenaline,

Individualised treatment plans and the subsequent role of self management,

Education of patients, carers and schools.

Special considerations (teenagers and young adults) reasons for non compliance.

Referral to specialist centres Follow up in primary care and management of co-morbidities.

Holistic care of the allergy patient.

The presentation will refer to current guidelines of European Allergy and Clinical immunology, World Allergy Organisation, Royal College Paediatric Child Health, National Institute Clinical Excellence and Anaphylaxis guidelines of the Resuscitation Council.

Keywords: Anaphylaxis, risk assessment, clinical diagnosis and management

SYM-010

Dementia management in the primary care setting across Europe

Ferdinando Petrazzuoli¹, Louise Robinson², Hans Thulesius³, Nicola Buono⁴, Shlomo Vinker⁵, Tuomas Koskela⁶, Thomas Frese⁷, Jean Karl Soler⁸, Eugene Yee Hing Tang², Kathryn Hoffmann⁹, Diego Schrans¹⁰, Radost Asenova¹¹, Jette Ahresen¹², Jean Yves Le Reste¹³, Athina Tatsioni¹⁴, Peter Torzsa¹⁵, Clarie Collins¹⁶, Bjorn Lichtwarck¹⁷, Donata Kurpas¹⁸, Daniel Pinto¹⁹, Claudia Iftode²⁰, Davorina Petek²¹, Quinti Foguet Boreu²², Sven Streit²³, Harm Van Marwijk²⁴, Pemra Unalan²⁵, Gulsen Ceyhun Peker²⁶, Miro Hanzevacki²⁷

¹EGPRN- Department of Clinical Sciences in Malmö, Centre for Primary Health Care Research, Lund University, Malmö, Sweden

²Newcastle University

³EGPRN-Department of Clinical Sciences, Lund University, Malmö, R&D Region Kronoberg, Växjö, Sweden

⁴EGPRN-SNAMID (National Society of Medical Education in General Practice), Caserta, Italy

⁵EGPRN-Department of Family Medicine, Sackler School of Medicine, Tel Aviv University, Tel Aviv, Israel

⁶EGPRN-University of Tampere, Omapihlaja Health Centre, Finland

⁷EGPRN-Department of General Practice, University of Leipzig, Leipzig, Germany

⁸EGPRN-Mediterranean Institute of Primary Care, Attard, Malta

⁹EGPRN-Department of General Practice and Family Medicine Center for Public Health, Medical University of Vienna, Austria

¹⁰WICC-Departement Family Medicine and Primary Health Care Ghent University, Belgium

¹¹EGPRN-Department of General Practice, Medical University of Plovdiv, Bulgaria

¹²EGPRN-Research Unit for General Practice, University of Aarhus, Denmark

¹³EGPRN-Equipe reconnue par la commission recherche SPURBO, Department of General Practice, Université de Bretagne occidentale, Brest, France

¹⁴EGPRN-General Medicine, Department of Internal Medicine, Faculty of Medicine University of Ioannina School of Health Sciences, Ioannina, Greece

¹⁵EGPRN-Department of Family Medicine, Faculty of Medicine, Semmelweis University, Budapest, Hungary

¹⁶EGPRN-Irish College of General Practitioners, Dublin, Ireland

¹⁷EFPRN-Centre for Old Age Psychiatric Research, Innlandet Hospital Trust, Norway

¹⁸EURIPA-Department of Family Medicine, Wroclaw Medical University, Poland

¹⁹WICC-Department of Family Medicine, NOVA Medical School, Lisbon, Portugal

²⁰EGPRN Advisory Board, Timis Society of Family Medicine, Timisoara, Romania

²¹EGPRN-Department of Family medicine, Medical Faculty, University of Ljubljana, Slovenia

²²EGPRN-Institut Universitari d'Investigació en Atenció Primària- IDIAP Jordi Gol, Universitat Autònoma de Barcelona, Catalonia, Spain

²³Institute of Primary Health Care BIHAM, University Bern, Bern, Switzerland

²⁴Primary Care Research, University of Manchester, United Kingdom

²⁵EGPRN-Dept of Family Medicine, Marmara University Medical Faculty, Istanbul, Turkey

²⁶EGPRN-Ankara University School of Medicine, Turkey

²⁷Director Health Care Center Zagreb, Croatia

Background

The aim of this Symposium is to highlight current research conducted on dementia in the primary care setting in Europe.

a)EGPRN PREDEM Collaborative Group

The European General Practice Research Network (EGPRN) is currently involved in a collaborative study called (PREDEM) aimed at exploring the management and the diagnostic workup of dementia in Primary Care in 26 European Countries. In this study we wanted to explore: 1) the initial signs and symptoms, 2) who is responsible for establishing the diagnosis of dementia, 3) initiating management and drug treatment of dementia, and 4) which specific tests for cognitive dysfunction, instrumental investigations and blood tests are used in the workup. Data have been obtained from questionnaires filled by GPs in the participating EGPRN countries. Over 400 questionnaires from these 26 Countries have been collected and analysed.

b)"Dementia and primary care: has a National Dementia Strategy made a difference to quality of care" Professor Louise Robinson, Newcastle University

Worldwide, the number of people with dementia is estimated to double to 115 million by 2050. Dementia

presents healthcare with one of the biggest economical and social challenges of the 21st century. In western countries, 40% of dementia care costs are from community and care home costs (Alzheimer's Disease International, 2010). Despite this, research consistently reveals that people with dementia, and their families, are often in receipt of poorly integrated and inadequate health and social care. Care of people with dementia has particular implications for primary care, with two thirds of people with dementia currently living in their own home or in care homes, cared for by their general practitioner (GP).

Internationally some countries have introduced a National Dementia Strategy to raise the quality of care and range of services for people with dementia and their families. Drugs are available to slow the progress of the disease. However a recent report from the World Alzheimer Association (2011) has shown that some non-drug approaches could also be effective as a routine part of community dementia care but currently there is limited translation of this evidence into practice. This presentation will consider:

i) whether the introduction of a National Dementia Strategy in England has improved patient experience and quality of care

ii) the facilitators and barriers to introducing a National Dementia Strategy

c) Management of Dementia in the UK: Views of Future General Practitioners.

Eugene Yee Hing Tang, MBChB, MSc

BACKGROUND: General Practitioners (GPs) have consistently expressed a lack in confidence and skills in managing dementia. There is evidence that future GPs are generally positive about promoting the quality of life of patients with dementia (PwD) and their carers. It is unclear however what challenges future GPs face when dealing with these complex patients. We aimed to survey a large group of future GPs on their knowledge and attitudes to current dementia care.

METHODS: We formatted and distributed the survey to all GP trainees in the North East of England. This included both paper and electronic versions with one single reminder. The survey included questions on attitudes to dementia care, difficulties encountered when managing dementia and a dementia knowledge quiz.

RESULTS: 153 of 513 trainees responded to the survey (response rate 30%); 102 female and 51 male trainees responded with the majority of trainees (87.1%) feeling that much could still be done to improve the lives of PwD. Although most trainees had experience in specialties with exposure to dementia in their training around 1 in 4 trainees have or would not in the future. Main difficulties encountered by trainees in dementia management included 1) coordinating support services for PwD and their carers as well as responding to co-existing behavioural and psychiatric problems. The majority of trainees (90.4%) also felt that GPs have a key role to play in identifying those at high risk of dementia and almost two thirds feeling that a risk prediction tool would be useful. Around 80% of trainees also felt that more education in management of dementia during or after training would be useful.

DISCUSSION: PwD are complex individuals often requiring multidisciplinary support. In order to ensure that these patients continue to live well in the community educational and clinical resources could be improved for future GPs either during training or soon after completion of training.

Method

Data from the EGPRN collaborative study on dementia management in the primary care setting will be presented and discussed along with the data from UK from the experience of young doctors on the topic.

Timeframe

Introduction to the Symposium Ferdinando Petrazzuoli EGPRN PREDEM collaborative group

"Dementia and primary care: has a National Dementia Strategy made a difference to quality of care" Louise Robinson Newcastle University

"Dementia management across Europe-I" Hans Thulesius Sweden (EGPRN PREDEM collaborative group)

"Dementia management across Europe-II" Tuomas Koskela Finland (EGPRN PREDEM collaborative group)

"Dementia management across Europe-III" Claire Collins Ireland (EGPRN PREDEM collaborative group)

"Dementia management across Europe-IV" Pemra Unalan Turkey (EGPRN PREDEM collaborative group)

"Attitudes of future GPs on the management of dementia" Eugene Yee Hing Tang, Newcastle University

An open interactive discussion will follow each presentation.

Keywords: dementia, MMSE, Alzheimer,

SYM-011

Early detection and management of frailty in primary care

Serap Cifçili¹, Güzel Dişçigil², Çiğdem Apaydın Kaya¹, Pemra Gülru C. Ünalın¹

¹Department of Family Medicine, Marmara University, Istanbul, Turkey

²Department of Family Medicine, Adnan Menderes University, Istanbul, Turkey

Justification: In our aging world, one of the important challenges of primary care is to meet the needs of the elderly. Frailty is a prevalent condition in old age and it leads to loss of independence and mortality. Early detection and appropriate management of frailty in primary care might prevent disability. However, there are a number of challenges in this area.

Content: First of all, selection of a screening instrument, which is simple, easy to use and suitable for primary care among a number of choices, seems to be a challenge. There is still a need to studies which evaluates the validity and reliability of these instruments.

Another challenge is that, in order to help the frail elderly an interdisciplinary approach is needed. However, this prerequisite may not be met in all primary care settings across the world. What is more; a number of intervention studies in the primary care setting display controversial outcomes.

Interventions including multidimensional assessment of the low-risk elderly, disease management and health promotion might reduce disability. In addition, review of medications and deprescribing have a positive effect on mortality. Strength exercises and protein-rich diet seem to be the most effective treatment options however long-term adherence is needed. In recent studies; treatment of Vitamin D deficiency, combined with exercise and protein supplementation appear to be a newer strategy. Results of cognitive training studies revealed promising results.

Nevertheless; we need to discuss effective strategies concerning management of frailty in primary care. In this panel discussion we aim to discuss current evidence and share experiences with the participants.

Keywords: elderly, frailty, primary care

SYM-012

Role of European general practitioners in communicating colorectal cancer screening

Bohumil Seifert¹, Charles Helsper², Martin Rasmussen³, Greg Rubin⁴

¹Department of General Practice, 1st Faculty of Medicine, Charles University in Prague, Czech Republic

²Julius Center, UMC Utrecht, the Netherlands

³Finnish Association of General Practice, Finland

⁴Wolfson Research Institute, Durham University, Great Britain

Justification

150 000 European citizens die every year because of colorectal cancer (CRC). The struggle against CRC is one of the health priorities in European Union. Population based colorectal cancer screening has been proven to be effective in reducing morbidity and mortality of CRC and has been adopted in a majority of European countries. European Guidelines on Quality Assurance in CRC Screening emphasize: "People who use CRC screening services should receive accurate and accessible information that reflects the most current evidence about the CRC screening test and its potential contributions to reducing illness as well as information about its risks and limitations". The role of GPs in communicating CRC screening is crucial.

Content

For Great Britain, the Netherlands, Finland and the Czech Republic the common aspects of CRC screening are

established addressed invitation system and two steps screening programme based on FOBT followed by colonoscopy in case of positive samples. Differences are in the programme management, in the role of GPs, in type and performance of faecal occult blood tests, in participation rates and capacities. These differences may project into communication strategies.

In this workshop suggested by European Society for Primary Care Gastroenterology (ESPCG) four speakers from above mentioned countries will reflect the role of GPs in communicating CRC screening in different health care systems and different screening programmes. Comparative effectiveness of methods of invitation, strategies for increasing participation in population and insights into the reasons for non-participation will be presented. A space for discussion on other aspects of GP involvement and attitudes to CRC screening in other European countries will be provided.

Keywords: colorectal cancer, screening, general practitioner, communication

SYM-013

Strategies to manage cross-border/migrant children immunization schedule

Gheorghe Gindrovel A Dumitra, Dana Stefana Popescu, Sandra Alexiu, Dorica Sandutu, Daniela Stefanescu, Anca Deleanu, Maria Lup, Raluca Zoitanu, Cristina Barbu
Immunization working group– Romanian National Society of Family Medicine

BACKGROUND: Though their immunization activity family doctors in Romania have identified the problem of lack of knowledge about the immunization history of children who are vaccinated in several European countries. These children receive true “vaccines cocktails ” due to the temporary residence of their families in various countries. The evolution of the epidemic of measles in recent years justifies the existence of a "vaccination passport" for children but also for adults with a special focus on pregnant women.

OBJECTIVE: This workshop aims to identify useful tools for vaccinators for ensuring optimal immunization of children with temporary residence in different countries of Europe and adequate protection against vaccine-preventable diseases.

METHODS: A short presentation will reveal the cross-border/migrant children vaccination situation, the importance of knowing the vaccination history, the instruments to access registered, including electronic, data for each child available now in Europe. Participants will be distributed in small groups which will be asked to work on prioritizing proposed instruments.

RESULTS: Small groups will report to the larger group and the results will be summarized and quantified and after the workshop will be communicated. At the end of the workshop a questionnaire will be used to collect individual choices of the participants.

CONCLUSION: This workshop will give participants the opportunity to use in their current vaccination activity useful communication methods to identify vaccination history. This process is designed to help develop a real "vaccination passport" extremely useful for vaccinators and families. As part of the workshop, we also propose to seek interest in establishing a WONCA Immunization Special Interest Group, and the participants are invited to contribute directly to further development.

Keywords: s: immunization schedules, prevention, vaccination, cross-border

SYM-014

Noncontraceptive uses and benefits of hormonal contraceptives

Işık Gönenc, Emine Zeynep Tuzcular Vural
Haydarpaşa Numune Training and Research Hospital

Since its approval in 1960 for contraceptive purposes, the “pill” changed many women’s lives and approach to sexuality worldwide. Although causing a relief to the centuries long trouble of unwanted conceptions, now we have a lot more to consider when prescribing contraceptive methods. The development in contraceptive medicine yielded many alternatives in the pill formulations as well as many other types of hormonal contraceptive methods. This is the result of constant interest in creating different solutions to the different types of women with many other non contraceptive needs and concerns.

After more than half a century since the approval of the pioneer method, lots of controversies remain regarding their safe use, but against all odds hormonal contraception methods are significant keystones of reproductive health and can be used throughout the reproductive years even beyond, in many women with different medical conditions and different life styles.

Their expanded use beyond pregnancy prevention include relief from menstrual symptoms such as heavy periods, dismenorrhea and irregular bleeding as well as acne and hirsutism. Many women also experience improvement in menorrhagia, polycystic ovary syndrome or endometriosis. They can also be used in the transition to the menopause relieving the perimenopausal symptoms and bleeding abnormalities. Their long term use have been associated with reduction in the risk of developing some types of cancer such as the ovary and the endometrium. They can even be used to design a woman’s yearly menstrual calendar.

Besides prescribing hormonal contraception for contraceptive needs, family physicians should be capable in making choices among hormonal methods and should be familiar with using guidelines and eligibility criteriae in order to ameliorate many accompanying health conditions and adjusting to different expectations and life styles thus enhancing the quality of many women’s lives.

Keywords: Female Contraception, health, hormone

SYM-015

"Poverty: a treat and challenge for rural general practice" – EURIPA Symposium

Tanja Pekez Pavlisko¹, Christos Lionis², Jane Randall Smith³, Oleg Kravtchenko⁴, Ferdinando Petrazzuoli⁵, Jean Pierre Jacquet⁶, Maja Racic⁷

¹EURIPA Croatia Interim President

²EURIPA Greece

³EURIPA United Kingdom

⁴EURIPA Norway

⁵EURIPA Italy

⁶EURIPA France

⁷EURIPA Bosnia and Herzegovina

Andrija Stampar phrased the definition of health accepted by the World Health Organisation: Health is a state of complete physical, mental and social well-being and not merely the absence of disease or infirmity. Even after 70 years this definition is still widely used. In multiple countries of the WHO European Region poverty rates are higher in rural areas. Demographic issues (out-migration and an ageing population), remoteness and the accompanying limited access to infrastructure and services, lower levels and quality of education, lower employment rates and less effective social protection are among the reasons for poverty's often entrenched nature in many rural areas of the Region. According to OECD: Poverty is not only about income; poor people do not only live in poor countries; poverty is not standard or static; it is only a question of „getting to zero“– but of staying there. General practitioners are among the first to meet the problem of poverty through work with

patients, healthcare system and social services. Some of us find it difficult to cope with pressure from surrounding poverty and therefore decide to work in countries which offer them better work conditions and earnings. In this way, they increase their society's poverty as the number of available health workers decreases. On the other hand, by going to rural areas of other countries they face language barriers, and with them the issue of patient safety. During the EURIPA symposium lecturers will present: a) data and evidence on poverty, homelessness and immigrants in rural Europe; b) problems and barriers in keeping practitioners involved in meeting rural poverty and homelessness; c) issues in patient safety due to new-coming practitioners; d) health policy issues aiming to alleviate the burden to healthcare and social services in rural areas.

At the symposium's events and after debate we will bring conclusions which tie into the WHO global strategy on people-centered and integrated health services.

Keywords: Rural Practice, Rural Primary Care, Rural Family Medicine, poverty

SYM-016

How to implement guidelines and training initiatives in practice: learning from the RESTORE project

Christopher Dowrick¹, Christos Lionis², Erik Teunissen³

¹Department of Psychological Sciences, University of Liverpool, UK

²Department of Social and Family Medicine, University of Crete, Greece

³Department of Family Medicine, Radboud University Nijmegen, Netherlands

Justification

There is an ever-expanding quantity of guidelines and training initiatives (G/TIs), but it is often difficult to apply them in practice. In this symposium we present effective techniques to enable participation and change, combined with robust methods to understand the implementation process.

We share experience of RESTORE, a multi-centre EU-funded study, designed to enhance implementation strategies to improve the cross-cultural primary care consultation. Our implementation journeys were based on dialogues with local stakeholders, brokered by Participatory Learning and Action (PLA) methods, around four key constructs of Normalization Process Theory (NPT). A mapping exercise identified relevant guidelines and training initiatives. Using PLA and NPT, we supported the implementation journey in each of five sites, from selection of a suitable G/TI, through local and cultural adaptation, to policy impact, delivery and evaluation.

This symposium is relevant to everyone wishing to learn more about how to implement guidelines or training initiatives effectively in primary care. The goals are to:

- explain how implementation activity is enhanced by the combination of PLA and NPT
- Provide case studies focusing on processes of selection, implementation and evaluation of G/TIs
- Offer GPs and researchers tools to undertake effective implementation journeys in their own settings.

Methods

The symposium will compose three 10 minute presentations, with 30 minutes for discussion and debate.

Christos Lionis (Crete) will describe the processes involved in selecting a G/TI in each site, how key PLA methods built stakeholder consensus around the NPT constructs of sense-making and engagement.

Christopher Dowrick (Liverpool) will describe how additional PLA techniques addressed barriers and enabled implementation of selected G/TI in each site, informed by the NPT construct of enactment.

Erik Teunissen (Nijmegen) will explain how we appraised the implementation journeys of the selected G/TIs, drawing on further PLA techniques and the NPT construct of appraisal.

Keywords: guidelines, training initiatives, implementation, participation, normalisation

SYM-017

The role of primary care physicians in addressing frailty prevention in older people

Ines Garcia Sanchez, Anna Carta, Jorge Pinto Antunes
DG SANTE European Commission

Justification

Frailty is a geriatric concept referring to a state of increased vulnerability to poor resolution of homeostasis after a stressor event, which increases the risk of adverse outcomes, including falls and disability. It has biological, physiological and psychological components.

The most distressing outcome of frailty is the older person's poor ability to function and eventually to live independently. Ultimately it increases the risk of adverse health outcomes including, hospitalisation, institutionalisation and death.

Prevalence of frailty in 65+ is high: 7-16%. Prevalence increases with age and is greater in women. The challenges in finding a standard definition of frailty that could be widely recognized and valid in different settings makes any estimation of prevalence approximate and tentative. Frail people usually have a high use of community resources, hospitals and long-term care institutions. However, frailty is preventable and disability can be avoided by detecting and treating frailty at an early stage and preventing the decline of patients' health conditions. Based on the work done for over 3 years within the European Partnership of Active and Healthy Ageing, the European Commission has taken forward frailty prevention through different channels. The aim of the session will be to raise awareness on the public health challenge at EU level that frailty in older people represent and discuss on the necessary next steps to affirm frailty prevention as a priority of European national healthcare systems. Primary health care professionals have an important role to play in this concern.

Content

Structured in 3 formal presentations and an introduction by the moderator, the following contents will be addressed:

Why is frailty relevant in public health and in clinical practice?

What are the steps to address frailty in clinical practice (screening, diagnosis, intervention)?

What is the role of primary health care physicians vs geriatricians in tackling frailty?

Keywords: Frailty, primary care, older people, health intervention,

SYM-018

Transforming primary health care in the world largest archipelago - Road map for the establishment of Primary Care Physicians in Indonesia

Indah S Widyahening¹, Dhanasari Vidiawati¹, Herqutanto Herqutanto¹, Monika Saraswati Sitepu², Novana Perdana Putri²

¹Community Medicine Department, Faculty of Medicine Universitas Indonesia, Jakarta, Indonesia

²Ministry of Health of the Republic of Indonesia, Jakarta, Indonesia

Justification

To achieve health for all, WHO recommends four primary health care reforms. Indonesia has started the reform through the implementation of universal coverage in 2014. This should be followed by service delivery reform to reorganized health services as primary care. The existing primary care providers need to be converted so they could possess the distinctive features of primary care which enable them to provide more effective, efficient and equitable care. This is a huge challenge as Indonesia currently have around 90000 general practitioners (those graduated from medical school) registered whom situated all over the wide archipelago. A road map has been

established to guide this process.

Content

The road map development was lead by the Ministry of Health together with all significant stakeholders. This presentation will describe the steps planned in the road map and the responsibilities of each stakeholder in the fulfillment of each step. To create a seamless transition, a set of policies and regulations need to be established. Different conversion tracks is made available to produce around 110 thousand competent primary care physicians by the year 2030.

Keywords: Primary care physicians, primary health care, developing countries

SYM-019

Collaboration of the Association of General Practice /Family Medicine of South East Europe

Ljubin Sukriev

Center for Family Medicine, Medical Faculty Skopje, Macedonia

Association of General Practice/Family Medicine of South East Europe was founded six of June 2003 in Ohrid, Republic of Macedonia. The idea of the forming this kind of Association was born at the Third Congress of doctors of General Practice of former Yugoslavia, at 2002, in Vrnjacka Banja. At this Congress declaration were adopted. Association was established mostly for the coordination of the activities of family medicine in the region, with one AIM: to strengthen collaboration between countries in the South East Europe which have similar reforms of their health systems. Countries members of the Association are: Albania, Bosnia and Herzegovina (with Federation Bosnia and Herzegovina and Republic of Srpska), Bulgaria, Croatia, Macedonia, Montenegro, Romania, Serbia, Slovenia and Turkey.

There are a lot of activities between the countries members, such as organizing a lot of professional meetings in the form of Congress, Conferences, roundtables, workshops, studies in the Association and as well publishing activity in the Association and in every country member. Also, numerous meetings of the Association held in different countries, an which, there was a discussion about problems of mutual interest for the family medicine of South East Europe. On the last time, to advance collaboration between department of Family Medicine the countries member of the Association. Through exchange of opinion expertise and experiences, helping each others, in collobaration, mutual values of the general practitioners in South East Europe, are build. Association will coordinate activities and will stimulate national organizations of family medicine, to influence at the public opinion and the Government authorities, to accept the central role of the Primary Health Care and Family Medicine in the health systems.

Keywords: Collaboration of the Association

SYM-020

Harmonization of specialization on General Practice/Family Medicine in South East Europe

Katarina Stavrikj

Center for Family Medicine, Medical Faculty Skopje, Macedonia

BACKGROUND: Association of General Practitioners/Family Medicine of South East Europe is taking lot of activities to improve the status of family medicine in countries members of the Association. Specialization on family medicine is introduced in all South East European (SEE) countries members of the Association according the recommendation of EU directives, but with lot of challenges in there development in different countries. Collaborations between countries in defining curricula, improving teaching staff and research can contribute to harmonization of specialization and enable straitening of the family medicine.

METHODS: This study assesses the development of specialist training programmes on family medicine in SEE countries members of the Association. Questionnaire was conducted in 11 South East European (SEE) countries members of the Association.

RESULTS: Family medicine in SEE countries is now formally recognized as a medical specialty and successfully introduced into medical training at postgraduate level although in Romania, Slovenia and Turkey the specialization is compulsory. The specialist training programmes have duration of 3 or 4 years, from which in most of the countries half of the training is in family medicine practice. In some countries BiH, Croatia, Slovenia, Turkey, Macedonia and Montenegro were developed retraining programs for general practitioners to become specialist in family medicine. In most of the countries the trainees have to participate in research during the training period. In all countries there is final exam with some differences in its organization. In most of the countries the final exam is consist of portfolio, Multiple Choice Questioner test and oral exam. Objective Structured Clinical Examination exists in Slovenia, Croatia, Macedonia, Montenegro, Romania and Republica Srpska. Publishing of research paper during the training is obligatory in BiH, Croatia, Macedonia, Republica Srpska and Romania. Turkey has non standardized final exam consist only with oral part.

CONCLUSIONS: In most of the SEE countries specialization is not obligatory. There is harmonization of duration and curricula as well as participation in research. The key area of further improving are hospital rotations, the work based assessment, professional development of educators and mentors and final exam. Sharing expiriances and cooperation between medical faculties in countries members of the Association of General Practitioners/Family Medicine of South East Europe will promote further harmonization of specialization and empower the position of FM in those countries.

Keywords: Harmonization

SYM-021

Harmonization And Equalization Of General Practice/Family Medicine Work Quality In South East Europe

Biserka Bergman Markovic

Department of Family Medicine, Medical School University of Zagreb, Croatia

The countries of Southern Eastern Europe are going through a similar social development, which is reflected on the working process in primary health care, and in General Practice/Family Medicine as well. Professional society of General Practice/Family Medicine in these country are gathered in Association of General Practitioner/Family Medicine in South East Europe (AGP/FM SEE).It is therefore gratifying that A GP/FM SEE member are driving the elevation of the Organization's first Global Goal-harmonization and equalization of working process in Family Medicine in these countries, uprising the quality of work. These effort is strategic direction and goal, especially against a background of a continuing global economic crisis. A series of operational changes and adjustments were put in place in these last years through sharing experience on organizations and clinical topics by participating all the members on Congress which take place every four years, and in every year's Conference. There was analyzed A GP/FM SEE's basic attributes and comparative advatages in relation to these challenges within the context of evolving development cooperation environment, leading to revision of our core functions,

which are our means of action-improving the quality of work in General Practice/Family Medicine. Also A GP/FM is unique in having broad mandate spanning a range of activities working on norms and standard settings, data and information, policy dialogue, knowledge and technologies, partnerships, capacity development, communication and project investigations.

In view of the challenging economic circumstances for many member countries harmonization and equalization of working process through structural changes leads to the strengthening of GP/FM and will realign the health care system from very expensive secondary health care to good organized but much cheaper primary health care.

Keywords: Harmonization And Equalization Of General Practice

SYM-022

What WONCA, together with ICOH and WHO, can contribute to Workers' Health: A short history, but a challenging great future ahead!

Peter Buijs¹, Frank Van Dijk², Garth Manning¹

¹Department Work&Health Dutch Research Institute TNO Work&Employment, Leiden, Netherlands

²Coronel Institute for Occupational&Environmental Health Medical Faculty, Amsterdam University, Netherlands

The famous WHO Alma Ata-Declaration (1978) aimed at bringing Primary Health Care (PHC) to where people live and work. However, the worlds of primary and occupational health care mostly remained separated, and PHC even developed a 'Blind Spot for work'.

However, ten years ago, Wonca and ICOH (International Commission on Occupational Health) started exchanging views: Wonca Europe asked an ICOH-speaker on this topic (Kos, 2005; repeated in 2008, 2010 and 2013). ICOH invited the Wonca-presidents on topics like how to link primary and occupational health care (Milan, 2006; Capetown, 2009). In 2009 WHO joined in with her first Intercountry Consultation (Santiago de Chili), and later organizing the first WHO Conference 'Connecting Health and Labour' (The Hague, 2011).

These developments resulted in the ICOH-Wonca Statement (2014), concluding to address jointly "gaps in services, research, and policies for the health and safety of workers and to better integrate occupational health in the primary care setting, to the benefit of all workers and their families".*

How to conceptualize and operationalize these important developments? What structural support is needed? What can we learn from practice? During the ICOH 31th World Congress (Seoul, June 2015) we have organized a Special Session about these questions, inviting speakers from 7 countries all over the world to tell more about local, national and international initiatives. We asked the participants to describe the nature, strengths and weaknesses of the (experimental) practice in their country, and the future opportunities and difficulties. Furthermore the role of science and what support is expected from international organizations was discussed.

In our Workshop in Istanbul we will present some of these results, as 'food for thought and discussion' about how PHC can pay more attention to work.

*<http://www.globalfamilydoctor.com/News/WONCAandICOHstatementonworkersandtheirfamilies.aspx>

Keywords: Primary Health Care, occupational health care, history of International collaboration

SYM-023

Multi-national Symposium by Wonca Europe-EGPRN & Wonca World-WWPR on "Organization of the healthcare system in Europe: What facilitates & What impedes the delivery of effective primary care"

Mehmet Ungan¹, Christos Lionis², Radost Asenova³, Jean Pierre Jacquet⁴, Knut Arne Wensaas⁵, Nicola Buono⁶, Anna Nager⁷, Claire Collins⁸, Peter Torzsa⁹

¹EGPRN & WONCA Europe

²EGPRN & WWPR-WONCA World

³Bulgaria

⁴France

⁵Norway

⁶Italy

⁷Sweden

⁸Ireland

⁹Hungary

Symposium is based on a Project by WONCA World Working Party (WP) on Research. In Europe, EGRPN is in coordination with WP. The project is supported and endorsed by WONCA, WONCA Europe & its Network EGPRN and by the International Committee of the North American Primary Care Research Group (NAPCRG). Professor Ungan and Professor Lionis will co-chair the session on behalf of the 3 organizations. Format is designed to address a knowledge gap in terms of how primary care (PC) is organized around the world, and to create dialogue between colleagues and colleges about how the fundamental values of primary care can be addressed and preserved within the constraints of different healthcare systems, sometimes operating within the same country. The representatives from 7 European countries will present the facilitators and barriers that the organization of the healthcare system in their nation impacts on providing effective PC. Each presenter will have 7 minutes to and not more than 11 slides to answer the default questions in the template. A facilitated discussion will be in the last 20 minutes. The presentations will be published in web sites together with the presentations of last symposium held in the 2014 WONCA Europe Conference. The presentation format (template) is as follows:

1. INTRODUCTION: Basic demographics:

- Population
- Distribution (eg urban / rural / remote)
- Socioeconomic breakdown
- Ethnic groups
- Other relevant characteristics eg religions

2. Health system design:

- Funding – state, public
- Secondary care
- Health insurance available? Who would get? insurance available - offers choice of specialist & hospital care eg elective surgery
- Primary care
- Medicines & investigations

3. How primary care is delivered in <country> - model(s) of care

4. Access to primary health care in <country>

- How universal is it?
- What are the inequities?
- Who pays?

5. Benefits and drawbacks of health care system

- Positive aspects to PHC system, enablers of care
- Negative aspects PHC system – barriers to care
- Current challenges faced by the healthcare system in <country>

6. Impact of system on care

- Impact of PHC system on patient care / population health

7. Growing health care burden in <country>

- Identify the major health care burden that this country is facing:-

- May be non-communicable eg multi-morbidity eg diabetes / obesity / CVD / CORD

- May be communicable eg HIV / AIDS

- Ways in which healthcare system supports or impedes the capacity to provide appropriate medical services for growing health burden that is also person-and-community oriented.

8. Lessons for other countries

- Summary of what works well and does not work well in PHC in this country.

Keywords: Primary, Care, Family, Health, System, Organization, Effective

SYM-024

Dysphagia as a geriatric syndrome: a white paper position agreements between EUGMS and ESSD for GP

Jean Claude Leners¹, Pere Clave², Siggy Rausch¹, Aubart Monique¹, Patrick Tabouraing¹

¹LTCF ALA and Pontalze Erpeldange, Luxembourg

²Consorci Sanitari del Maresme, Universitat Autònoma de Barcelona, Spain

In 2014, members from EUGMS (European Union Geriatric Medicine Society and the ESSD (European Society for Swallowing Disorders) formed a working group to examine the management and position of oropharyngeal dysphagia (OD) among older people and agreed to write a white paper for increasing awareness and better management, especially intended towards general practitioners.

The draft has been reviewed by specialists and is applicable to GP in their daily practice.

The symposium will put forward the consensus in the recent literature and all useful aspects in our daily care of the elderly as family medicine physicians.

The symposium will include:

Prevalence and risk factors (20 min),

OD affects up to 40% of the population 65 years or older. Prevalence of OD is higher in patients with neurodegenerative diseases and is related to age, frailty and muscular, endocrine and psychiatric diseases.

Pathophysiology and instrumental assessments (30 min)

Aging slows the process of swallowing, increases the risk for particles to be aspirated. All older people need to be screened for OD in order to protect them against complications. Simple clinical screens that can detect the presence of OD by all GP and allow appropriate diet adaptation to be presented.

Treatment strategies and ethical aspects (20 min)

Complications of OD in older patients centre around malnutrition and aspiration pneumonia. To protect against these complications, patients require diet adaptation for nutritional supplementation and protection against aspirations, and oral health strategies. The focus will be put on elderly living at home or in institutions and cared by their GP.

Patients also have the right to refuse treatment and to decide which treatment to follow, so a specific focus will be put on ethical aspects for people with dementia in an advanced stage of their disease.

Discussion with the audience (20 min)

Keywords: oropharyngeal dysphagia, elderly, practical approach for GP

SYM-025

Building primary care in a changing environment: evidence for practice

Willemijn Schäfer¹, Mehmet Akman², Wienke Boerma¹, Dionne Kringos³, Peter Groenewegen¹, Phameu Consortium¹, Qualicopc Consortium¹

¹NIVEL (the Netherlands Institute for Health Services Research), Utrecht, the Netherlands

²Marmara University School of Medicine, Department of Family Medicine, Istanbul, Turkey

³Academic Medical Center of the University of Amsterdam, Dept. of Social Medicine, Amsterdam, the Netherlands

Justification (purpose of the activity)

The purpose of this workshop is to discuss the evidence that a number of international studies in primary care and family medicine have added to the body of knowledge for decision makers in the health sector and to exchange ideas and topics for a future research agenda for primary care.

Content

This workshop will be based on three international comparative studies on health services delivery and organization within primary care that have been conducted over the past years: the PHAMEU study (Primary Health Care Activity Monitor) and the QUALICOPC study (Quality and Costs of Primary Care in Europe), both with a main focus on European countries, and the implementations of the WHO Primary Care Evaluation Tool (PCET) in 10 countries in transition. From different perspectives and with different methodologies these studies have contributed to the body of knowledge on how primary care can help health systems become more responsive to changing health needs of populations.

The call for more evidence-based health policy making requires that researchers and decision makers jointly endeavor to critically view how outcomes of health services research can be applied in policy making. This workshop aims to bridge the gap between research and policy making by presenting core outcomes of the three studies and inform the audience how these could be translated into applicable knowledge for policy makers. The final presenter will elaborate on evolution of the Turkish health care system in the times of change and the implications of this evolution on primary care. In the following discussion, the audience will be invited to reflect on the presentations and to identify and discuss future challenges and ideas for a research agenda.

Keywords: Health Services Research; Research and Policy; International comparisons

SYM-026

Research at the Level of the Association and the Importance of this in the Region

İlhami Ünlüoğlu

Eskisehir Osmangazi University

When we look at the broadcast sense of the word; the definition of “research” includes any gathering of data, information and facts for the advancement of knowledge. As known; the strict definition of scientific research is performing a methodological study in order to prove a hypothesis or answering a specific question. Finding a definitive answer is the main goal of experimental process.

Association of General Practice/Family Medicine in South Eastern Europe (AGP/FMSEE) was founded in 2003. The aim of this foundation is to strengthen the collaboration between the countries of SEE, which have similar reforms of their health systems. For reaching this aim; in the light of living together for centuries and having similar culture we must share our experiences and for developing the level of the collaboration we must conduct common researches. Research is also one of the basic principals of continuous medical education and developing the quality in health services.

In our region (SEE), we must have researches about all the aspects of our discipline and the practice; for increasing and revising current knowledge by discovering new facts. For organizing and completing successful researches we must have a core team, education for the young members, scientific journals, conferences and congresses and many infrastructural preparations. If we can combine, the characteristics of our discipline such as; being a young discipline, dynamism that brought community needs, belief to express qualified service, educated staffs that working beside futures and experience with researches and can put into practice the results we will be successful and will have perfect health services in primary care.

Keywords: Family medicine, Research, South Eastern Europe

SYM-027

Indigenous and minority groups Issues and Health Outcomes

Tane Taylor

Royal New Zealand college of General Practitioners, Wonca Indigenous and Minority Groups Health Issues Working Party

BACKGROUND: New Zealand a population of 4.5 million people with an approximate 3000 strong GP workforce is in the forefront of building bridges amongst its multicultural community. This is underpinned by the Treaty of Waitangi signed between the Crown and Maori the indigenous people of New Zealand in 1840. The overwhelming evidence shows that Maori are over represented in poor housing, low socio-economic status, poor health, high prison rates, domestic violence etc. In 2007, The Royal New Zealand College of General Practitioners released its Cultural Competency Guidelines for General Practice, a substantial part of this document is dedicated to issues around Maori. However, the frame work is generic and can be used for all other cultures and ethnicities. It is helpful when governments and professional bodies are prepared to take on such challenges, however the greater challenge will always remain at the individual level, specifically at the General Practitioner level.

OBJECTIVES:

- General Practitioners – as health and political advocates
- International challenges and barriers
- Indigenous outlook as a Health Determinant
- Poor health outcomes and indigenous communities
- Building bridges within indigenous environments
- Facilitating cultural exchange provides more safer and efficient health service delivery

METHODS: This will be an interactive workshop. There will be a brief presentation to set the scene – The New Zealand Experience and than followed on with smaller (4 – 8 persons) group problem solving or tasks (20 minutes) with feedback from each group leading into general discussions.

Key Message(s): Will come out of the discussions

CONCLUSION: It is my belief that by encouraging open and frank discussions around indigenous and minority groups health issues we can better understand and therefore provide a more tailored and effective service to indigenous communities.

Keywords: indigenous, minority groups, equity, quality

SYM-028

Making a World Book of Family Medicine

Carl Steylaerts¹, Mehmet Ungan²

¹WONCA Europe

²EGPRN

Aim

to filter the 100 most representative abstracts that describe our job best out of the database of the collection of 20 years WONCA Europe congresses

Method

After digitalising all the abstracts of the last 20 years, a long list of 275 titles was hand-picked, then presented to a jury of Executive members, and they voted with 7, 8, 9 or 10 points. That resulted in a ranking.

Then a search began to find the original authors. Some were not found and replaced by a “body double”.

Conclusion

It is feasible to make a selection of 100 very interesting titles to make a World Book.

Since most of the authors are from European origin, we call it the European Edition.

That means that every Region can make a World Book, with this or another strategy.

In 2022, for WONCA's 50th Anniversary, a real World Book should emerge.

Who will be the author?!

Keywords: World Book; WONCA Europe; Abstracts

SYM-029

Tuberculosis as a Professional Disease among Health Care Workers

Ljiljana Cvejanov Kezunovic¹, Milena Cojic¹, Draginja Radunovic¹, Olgun Göktaş²

¹Department of Family Medicine, University of Montenegro, Montenegro

²Uludağ University Family Medicine Health Center, Görükle Campus, Nilüfer, 16059 Bursa, Turkey

Tuberculosis (TB) as the oldest and the most frequent infectious disease in the world is not past time disease. During two past decades, some factors have altered views about the risk of TB in health care workers (HCWs): the resurgence of the disease, and increasing number of multidrug-resistant cases of TB. Among patients, TB is dominant in migrants, HIV infected, and homeless.

Transmission can only occur with prolonged, frequent, or intense contact such are HCW serving high-risk clients at inpatient TB facility, laboratory, internal medicine, and emergency rooms, especially between radiology technicians, patient attendants, and nurses. The most dangerous for HCW are patients with: disease of the lungs, airways or larynx, with presence of cavitations on the radiograph, and inappropriate or short duration of treatment. The most dangerous procedures are: endotracheal intubation, suctioning, bronchoscopy, sputum induction, surgical drainage of a TB abscess, and autopsy.

Environmental factors that increase risk of transmission are: exposure in a small enclosed space, inadequate ventilation, recirculation of air containing infectious droplet nuclei etc.

HCWs at primary care level also have an important role to defend patients and themselves against TB, having in mind competencies to order appropriate tests for TB, and to give basic information as well as support to the patient and his family when suspected of having TB, communicate with the local services responsible for TB, record and report procedures associated with TB management.

CONCLUSION: it is extremely important for HCW to respect guidelines, to provide administrative controls and standard treatment plans, environmental controls, and to use regularly respiratory-protection facilities (ex. personal respirators for nursing staff) aim to reduce the risk of infection when exposure to TB is unavoidably high.

Keywords: tuberculosis, professional disease, health care workers

SYM-030

Depression Management in Family Medicine “What we do-What we can do”

Nilgun Özçakar, Vildan Mevsim, Tolga Gunvar

Department of Family Medicine, Dokuz Eylul University Medical Faculty, Izmir, Turkey

Mental disorders are both common health problems in primary care and community. The most common mental health problem seen in primary care is depression and the prevalence is reported to be between 5-19%. According to Mental Health Profile of Turkey research; 40% of the individuals visit psychiatrists, 30% other specialists and 20% doctors in primary care for mental health care. Rate of having treatment by contact primary care physician is reported to be 18%. Reforms in health and mental health emphasizing primary care have intensified in last 20 years. WHO-WONCA collaboration research emphasized systematic treatment approach at earliest possible stage in people's home and community-based environment will produce good results for mental disorders. It's well known that prevalence of mental disorders remained high all countries; contribution offered by primary care, treatment of these patients by reaching is important closing the gap can not be treated. In Family Medicine common mental disorders are known as depression, anxiety disorders and somatization disorder; antidepressants used for the treatment of all these disorders. While there is no significant change in recent years in the number of antidepressants prescribed by the psychiatrist and neurologists, an increase was seen in family physicians that prescribe antidepressants. Diagnosing and treating depression in primary care effectively and providing necessary referral scheme implementations are clinical issues that need to be updated for family physicians.

Mental health is recognized as an integral part of health. Frequent problems of mental health have great importance, may cause economic loss and disability. In light of this information, this symposium will contribute to development of depression management in primary care for family physicians, aimed to share knowledge. Framework is planned as; "Recognize the symptoms, identify, differential diagnosis, depression types common in primary care, warning signs and symptoms," "Diagnosis, screening, referral criteria" and "Treatment, prognosis, follow-up".

Keywords: Depression, family medicine, management of chronic diseases

PANELS

PNL-001

Vaccination of the migrant child - a challenge

Sandra Adalgiza Alexiu, Daniela Ștefănescu, Dorica Sănduțu, Cristina Barbu, Gindrovel Dumitra, Dana Ștefana Popescu, Raluca Zoițanu, Anca Deleanu, Maria Lup
Immunization Working Group, National Society of Family Medicine, Romania

Justification

Family doctors who also provide immunizations are faced with mixing the immunization schedules from different countries to ensure protection against vaccine-preventable diseases, taking into account both the specific local epidemiological context and that of the country in which the child might migrate to. Often children receive a real “vaccine cocktail” in several countries of Europe.

This raises several problems:

1. Is there need for a "vaccination passport"?
2. What is the correct medical and ethical attitude when faced with a child with an unknown vaccination history? To try and find out their history by contacting their previous doctor or to start a new vaccination scheme?
3. What are the technical tools and legal barriers of communication between practitioners in the vaccination field?

Experts on immunization activities in several European countries will try to answer.

Content

Experts on immunization activities in several European countries will discuss the problem of child migration. This topic is very timely for both “exporting” countries such as Romania, Bulgaria, Turkey and the “importing” countries such as Spain, Italy, Germany, France, Netherlands, UK.

There are children who start vaccination in the country where they are born. Due to the workforce migration parents choose to continue vaccination in another country. There is also the reverse phenomenon, in which parents working in a Western country return to their home country with a larger family.

Experts on immunization activities in several European countries will try to answer.

Keywords: immunization schedules, vaccination passport, cross-border

PNL-002

Tobacco control in Europe: 10 years after the WHO FCTC

Recep Erol Sezer¹, Özlem Tanrıöver¹, Kristina Mauer Stender², Luminita Sanda², Gemma Vestal², Toker Ergüder²

¹Yeditepe University Faculty of Medicine

²World Health Organization

Justification:

Although impressive progress has been made in tobacco control after the adoption of the WHO Framework Convention of Tobacco Control, tobacco remains an international concern to global health, killing nearly 6 million people each year and causing hundreds of billions of dollars of economic harm annually in the form of excess health-care costs and lost productivity. To control this deadly pandemic, there have been important challenges to be faced, addressed and solved. Family physicians and their organizations worldwide have played and keep playing important roles to achieve a tobacco-free world. This symposium will describe the current status of tobacco control in Europe and in the world including a focus on the impact of new forms of tobacco use (waterpipe smoking and e-cigarettes) on tobacco control, discuss the achievements and challenges, and will provide suggestions for the future.

Chairs: Professor Erol Sezer, Assoc.Professor Özlem Tanrıöver

Speakers:

- a. Kristina Mauer Stender: WHO FCTC implementation in Europe: looking into past in order to look into future
- b. Luminita Sanda: Electronic Nicotine Delivery Systems (ENDS)
- c. Gemma Vestal: Tobacco Waterpipe Smoking: Health effects and why it needs to be regulated
- d. Toker Erguder: Tobacco Control in Turkey; Story of Commitment and Leadership

Keywords: Tobacco control, waterpipe, e-cigarette

PNL-003

Social Media: An Exercise in Time Wasting for Young People?

Peter A Sloane¹, Raluca Zoitanu¹, Harris Lygidakis¹, Luis De Pinho Costa¹, Ulrik Bak Kirk², Raquel Gomez Bravo¹

¹Vasco da Gama Movement (VdGM)

²European Society for Quality and Safety in Family Practice (EQUIP)

Justification

The immense potential of Social Media is still unknown to most Primary Care professionals. For the past five years, the Vasco da Gama Movement has had a presence at most European Family Medicine conferences spreading the word about Social Media: what it is, the potential that it can bring to communication, and how it can be used to communicate, create networks, learn, improve quality of care, educate, research, build a better image for family medicine, influence policy making and much more.

Content

The panel debate will involve the audience in the form of a huge Tweetchat which will be run live on a secondary large screen in the auditorium. The audience can participate as well as colleagues who cannot join us in Istanbul and even Conference delegates who are not attending the debate. Examples of questions to be discussed include:

-

Is Social Media just for entertainment and the young generation?

Can it really be used professionally and, if so, what is the evidence?

How are patients and health care professionals using Social Media?

Which WONCA leaders are using Social Media and what is their experience?

What are the trends for the near future?

Do the codes of conduct need an update already?

Keywords: #SoMe, Social Media, Tweetchat, communication, VdGM, WONCA

PNL-004

Does discipline have the power to maintain institutions young?

Patrick Tabouring, Hirsia Farghadani, Siggy Rausch
Université du Luxembourg, Luxembourg, Luxembourg

Justification

Institutions are establishments of education and instruction. However education tries to maintain traditional values. Consequently, institutions are based on persistence, and that's why they use discipline.

On the other hand, each institution has a mission. The community of professionals of the institution dispenses of competences which accord a power of action to them. It is exactly this power of the institution that risks, in case of abuse, to lead to institutional violence. This risk is so much greater than the institution continues to exist and feels itself in danger to get older or to disappear. So, how to preserve the youth of a well justified institution, in order to avoid it to deviate into violence?

Content

After some basic theoretical notions in order to elucidate our ideas, this last question is asked to the assistance. Several discussion groups will be constituted and after that each group will report his answers.

The totality of the answers will be discussed in plenary session, in order to evolve to a common consensus.

Finally, the common propositions will be confronted to the theoretic model that has been elaborated before by the author.

To conclude the workshop, we will try to come to a common attitude.

Keywords: education, instruction, institutions, power, persistence, discipline

PNL-005

The Pacemaker Agenda: Promoting a culture of wellness, scientific update, and happiness for teaching Professionalism and Ethics in daily practice

Pablo Gonzalez Blasco¹, Graziela Moreto¹, Rosana Irie¹, Marcelo Rozenfeld Levites¹, Marco Aurelio Janaudis¹, Pedro Subtil Paula¹, Olgun Göktaş¹

¹Sobramfa- Medical Education and Humanism, São Paulo, Brazil

²Uludag Universitesi, Aile Sagligi Merkezi, Nilufer, Bursa, Turkey

To prepare General Practitioners for the growing opportunities in private practice in São Paulo (Brazil), SOBRAMFA- Medical Education and Humanism, has developed an innovative learning agenda required for all trainees and senior members. The practicing scenarios include: Geriatric Care, Managing Complicated Patients with comorbidities in Hospitals, Palliative Care, Family Medicine Clinics and Ambulatory, Home Visits, Nursing homes and Hospices. Ethical dilemmas, and ongoing challenges come daily to our practice. An assorted routine of regular meetings booked in advance permits to combine a busy work schedule with scientific learning, develops competences and professionalism, solves ethical issues, and allows physicians to perceive personal success in their lives.

The presenters will share how they have organized the Pacemaker Agenda (PA) for more than a decade, which includes:

- Scientific “pacemaker” - Weekly Scientific Meeting. Case-based discussion, update with articles from the most relevant publications, case-decisions for specific patients supported by Evidence Based Medicine, and solve ethical issues.
- Construction “pacemaker”- Monthly Meeting. Conducted as workshops include topics to promote reflective practice: professionalism, medical education, ethics, humanism, personal development, teamwork, and leadership.
- Cultural monthly Meetings –with leaders coming from non-medical fields. (Philosophers, Journalists, Educators, Lawyers, Artist and Musicians, Entrepreneurs, Humanists). At dinner time displayed as a familiar get-together.

- Young Doctor Monthly Meeting- case-based discussions lead by medical students, and the young doctors play the facilitator role.
- Mentoring and Evaluation- every trimester the trainees are evaluated and giving feedback by their respective preceptors.

The main outcomes of the agenda are:

- Effective Training- Clinical Competence
- Mastering Communication
- Respect, Credibility and happiness

The audience will learn how:

1. A well designed agenda could combine a very busy work schedule with real scientific learning, develop competences and professionalism.
2. When the routine includes monthly meetings regarding philosophical, educational and cultural issues a familiar, collaborative and teamwork scenario is created

Keywords: Medical Education, Family Medicine Training, Young Family Doctors, Scientific Meeting, Reflective Practice, Teamwork, Wellness Culture.

PNL-006

Challenges to our professional attitudes – treating friends and family

Manfred Maier¹, Imre Rurik³, Nazan Karaoğlu², Jean Karl Soler²

¹Dept. General Practice, Centre for Public Health, Medical University of Vienna, Austria

²Medical Education and Informatics Department, Meram Medical School, Necmettin Erbakan University, Konya, Turkey

³University of Debrecen, Debrecen, Hungary

⁴EGPRN-Mediterranean Institute of Primary Care, Attard, Malta

BACKGROUND:

Most physicians will confirm that they have been asked or have offered to provide care to friends or family members. This experience may start already during medical training and can range from providing advice, prescribing medications, issuing certificates, ordering diagnostic tests to managing difficult or chronic conditions. Due to the broad competencies characteristic for the field of General Practice and the comprehensive care provided by GPs it is likely that its prevalence is particularly high in this medical discipline. However, although they may provide the best care, GPs who are also close friends or family members of a patient certainly face several conflicts of interest in their dual roles. For example, an objective clinical perspective may be biased or endangered with an emotional or personal relationship with the patient. Further, sensitive questions may not be asked, informed consent may be skipped or documentation may not be appropriate.

The symposium:

This year's symposium "challenges to our professional attitudes" aims to address ethical aspects which arise from treating friends or family members or providing informal care to neighbours. Three to four speakers will address pro- and contra arguments and different approaches to the topic by providing background information and the evidence. In this context the guidance available from medical organisations will be reviewed and the attitudes of colleagues will be surveyed.

Participants of the symposium will have an opportunity to discuss the presentations and to add personal experiences from their own situation and experience. The symposium will conclude with a summary of the ethical considerations which arise from treating friends and family.

Keywords: ethics, professionalism, General Practice

PNL-007

Correct Exercise is Medicine!

Hatice Kurdak¹, Sevgi Özcan¹, Sanlı Sadi Kurdak²

¹Department of Family Medicine, Çukurova University, Adana, Turkey

²Department of Physiology, Division of Sports Physiology, Çukurova University, Adana, Turkey

Titles of the speeches:

1. What happened to the human who was born to move?
2. What can we do for our patients to move again?
3. "150 minutes in a week" is that all?

Almost every activity in our daily lives could be performed with minimum energy due to the rapidly developing technology. This sedentary life style leaves humans, who by nature are inclined to activity, facing with numerous health issues. Today it is well known that exercise has a crucial role in establishing a healthy life, prevention and treatment of various diseases. If the correct conditions are fulfilled in light of today's scientific knowledge exercise is indeed medicine. The benefits of exercise could be attained through proper and regular practice of the physical activities. However, increasing the amount of physical activity and ensuring that it remains effective, consistent and regular is not as easy as it is believed to be. There are numerous bio-psychosocial factors that influence physical activity habits. Therefore to guide individual in starting and maintaining regular exercise requires the detailed and holistic evaluation of the person. To identify the factors that might hinder the patients' ability to perform exercise, a detailed physical examination that includes the target organ systems should be done before starting a program. It is important that the individuals are informed about the abnormalities that might arise before during and after exercise. As they do in improving healthy behaviors, family physicals have a potential role in increasing exercise. In that sense it is of utmost important for family physicians to increase their competencies in areas of exercise consultancy. This panel aims to answer questions like "Who? Why? How long? In what frequency, intensity, volume, pattern and progression should exercise be performed?" along with up to date guidelines.

Keywords: Exercise, Family Medicine, Sports Physiology

PNL-008

Management of Childhood Obesity in Primary Care

Merve Şen, Arzu Uzuner, Nazire Öncül Börekçi

Marmara University Department of Family Medicine

PURPOSE:

Childhood obesity is a very important health problem that increasing morbidity and mortality in adulthood.

Researches show that incidence of childhood obesity is about 1.1-16% in Turkey.

The purpose of this workshop is to review the management and intervention methods for childhood obesity in primary care, to share the participants' experiences and to create small workshop groups for discussing applicable intervention methods for childhood obesity in primary care.

CONTENTS:

Management of overweight child and child with obesity will be overviewed by clinical history, physical examination and laboratory tests. The treatment options will be discussed; the effective intervention methods will be overviewed in the light of the current research. The researches about game intervention methods for gaining healthy eating and exercise habits to children will be discussed. The participants will share their own experiences in management; small workshop groups will be created for discussing applicable intervention models in primary care.

Keywords: childhood obesity, primary care, overweight, obesity

WORKSHOPS

WS-001

The Resistant Patient: How to improve your Interaction in a difficult situation

Siggy Rausch, Nico Haas, Monique Aubart
University of Luxembourg

GP's often have patients, who are reluctant or opposant to any proposition of their doctor. These encounters are the most difficult and frustrating GP's can face. Resistance doesn't mean, that the specific patient rejects all the good advice of his GP, but he is opposant to parts of the proposed approach or treatment options. This is particularly regretteble in issues of important health behaviour change. It is often difficult to understand, why patients seem to jeopardise their own best interests.

In this specific situation, a motivational communication, practiced in the motivational Interviewing approach, can help tremendously to open new perspectives and issues.

In our workshop, we will first describe and practice together different situations in which the discord between patient and GP is evident.

Second, we will discuss the issues which are particularly interesting to help move on and find new ways and solutions.

Third, we will applicate these approches in smaller groups to show the direct impact on the patient and the GP.

Keywords: Resistance, Motivation, Difficult patient, Frustration in GP

WS-002

Can we improve our low back pain tackling?

José Miguel Bueno Ortiz¹, Jose Antonio García Garcerán², Noemi Del Cerro Álvarez², Alberto Palacios Colom², Ignacio Ramírez Manent¹, Fernando Jose Rodriguez Martínez², Juan Francisco Mulero Cervantes², Juan Reyes Jimenez², Mari Carmen Santiago García², Rafael Luquin Martínez², Ana Maria Gómez Vizcaino², Esther García Delgado², Maria Fernández García¹

¹Spanish Society of Family and Community Medicine

²Gerencia Area Sanitaria 2. Servicio Murciano de Salud

INTRODUCTION: Low Back pain (LBP) is, after respiratory infections, the most frequent cause of consultation in primary health care. It is also one of the most common disease of Family Doctors (FD) since computerisation. Multidisciplinary and multinational evidence-based Guidelines(G) for the prevention and treatment of acute and chronic LBP were issued by a European project launched in 1999 by the European-Commission (COST B13 Action). In Spain and other countries, multidisciplinary national Working Groups adapted COST B13 guidelines to their own setting.

In 2013 in our (Sub-Regional) Cartagena-Health-Area (CHA) (200.000 patients registered) we have produced our G. Our Working Group was chaired by a Family Doctor (FD) and composed of specialists in Traumatology-Rheumatology-Rehabilitation-Anaesthesiology-Radiology-Internal Medicine and Family Medicine as well as Physiotherapists-Informatics and Health Authorities.

Prevention and treatment of chronic LBP should be multidisciplinary and include exercise and health education focusing on active management. The doctor could produce either placebo or nocebo effect.

Some related procedures have been included in the Choosing wisely initiative

Since 1995 we have run more than 60 Back-School Workshops in National and Regional Spanish Conferences. We would like to share with you our experience.

GOALS: FD should (1) acquaint with COST B13 LBP guidelines and our CHAG; (2) learn the possibilities of prescribing therapeutical exercises (TE) and postural hygiene (PH) to their patients with LBP; (3) acquaint with the abilities to help the patient to learn and carry out TE-PH as part of his treatment; (4) Change attitudes about TE-PH prescription in their daily work; (5) learn exercises to be carried out during their surgery and at home.

METHODOLOGY: Interactive. Each FD will have a facilitator. Role-playing followed by group discussion of LBP tackling in daily consultation. G will be discussed. All TE-PH recommended for the patient will performed by FD supervised by their facilitator.

Keywords: low back pain, occupational health, workshop, guideline

WS-003

Management and education of fasting patients by the general practitioner: the example of Ramadan

Melissa Dominicé Dao¹, Anbreen Slama Chaudhry²

¹Departement of Community Medicine, Primary Care and Emergency Medicine, Geneva University Hospitals, Switzerland

²Medical Education & Training Services, Switzerland

Justification:

Fasting is a commonly held spiritual and cultural practice in many communities, such as Ramadan for Muslim populations. Because of the importance of global migration, general practitioners around the world may encounter patients wishing to fast despite the presence of one or several illnesses or regular treatment intake. Ramadan fasting presents new health challenges due to the current length of the daily fasting period during the hotter period of the year in the northern hemisphere. Health care professionals should be aware of effects and potential risks associated with prolonged fasting and understand strategies to limit these risks. These strategies include: addressing the challenge and planning the fast with the patient, treatment adaptation, and structured education and support for safe fasting.

Content:

The goals of this workshop are to:

- 1) Understand the main health issues related to fasting
 - 2) Examine specific fasting issues for diabetic patients and review expert recommendations
 - 3) Practice skills to help patients make informed choices about fasting and to educate those who decide to fast
- This workshop will discuss, through a Muslim patient case vignette, how to approach the topic of fasting while considering patient's cultural/spiritual issues and health hazards related to fasting. Breaking into smaller groups for role play, participants will practice how to counsel and educate patients wishing to fast. Participants will have the opportunity to observe and practice communication, education and patient support skills, while receiving continuous feedback from organizers. Groups will reconvene to share content and process displayed by the role play. A reminder of expert recommendations will conclude the session.

Keywords: Fasting, Ramadan, Chronic Condition, Patient Education

WS-004

Innovation for primary care. The development of an {O}ptimal {C}are {D}elivery framework

Joachim Sturmberg¹, Bruno Kissling², Rick Botelho³

¹Newcastle University - Australia

²private practice

³independent researcher

Illness and disease are unique personal experiences and change over the life trajectory. Care needs change over time in light of altering physical, social, emotional and cognitive states. These aspects are rarely reflected in primary care frameworks to guide the management of people with, especially, chronic disease in primary care – most simply focus on individual diseases as if they were all independent of the person affected by them.

The experience of illness and disease emerges from interactions between the key domains of genome, cellular and immune function in the context of the person's physical and social environments. These insights require new approaches to patient care in the primary care setting.

This workshop aims to

- engage participants to reflect on their current approaches to care delivery, and
- identify deficit areas that are not part of the person's management plan.

Workshop activities will

- work in small groups to develop frameworks for whole person care taking account of cultural, socio-economic and population density factors,
- present individual frameworks, and most importantly
- identify key strategies to implement their frameworks in their community.

Participants will have the opportunity to continue the development of the OCD-framework through an ongoing online discussion forum.

Keywords: chronic illness, chronic care, community care, social health, environmental health

WS-005

Prevention of mental health problems in family medicine

Mateja Bulc¹, Leo Pas²

¹Ljubljana University Medical School, Dpt of Family Medicine

²Academic Center General Practice, Catholic University Leuven, Belgium

AIMS: To exchange experiences with the implementation of preventive activities in the field of mental health in European family medicine (EUROPREV countries).

MATERIAL-METHODS: The workshop will be based on scientific literature dealing with mental health problems prevention and consecutive health outcomes, approaches in EUROPREV countries as well as experiences of GPs in counselling their patients.

RESULTS:

In Slovenia, model practices of family medicine actively screen patients for anxiety and depression for the last 6 month. The latest results will be presented.

In Belgium collaborative models have been developed to deal with depression and prevent suicide. Several other countries have also been involved in such strategies.

Other countries' examples will be presented in discussion.

To implement effectively detection and counselling for different psychosocial problems in general practice we need to develop a clear strategy. Qualitative research shows that general practitioners integrate several aspects from existing psychotherapeutic approaches

CONCLUSION:

Based on scientific evidence, on the lessons learned from national programs, and on personal experience, the workshop will give the opportunity to discuss strategies regarding promoting mental health in the primary care setting. After the meeting participants are invited to join a Europrev working group to collaborate further in this priority area for research and quality assurance of care.

Justification: According to results of Europrev study, 14% of participating men had anxiety problems and 7% depressive disorders, 15% of women were depressive and 22% anxious.

Content

- Introduction
- Results of Europrev study
- Belgium example
- Slovenian model practices and mental health
- Discussion
- Conclusions

Keywords: preventive activities, family medicine, mental health

WS-006

Delivering person-centred care

Nigel Joseph Mathers, Helen Jayne Stokes Lampard

Royal College of General Practitioners, 30 Euston Square, London NW1 2FB, UK

Justification

The Royal College of General Practitioners (UK) recently sponsored a comprehensive independent inquiry into patient-centred care in the 21st century. The aim was to identify cost-effective solutions to the medical, social and financial challenges posed by rising levels of multi-morbidity. Eighty written evidence submissions were received and discussions with more than 50 individuals from a broad range of health, care and patient organisations were held.

The purpose of the proposed workshop is to examine the implications of rising levels of multi-morbidity and long-term conditions for primary care. In addition, a number of ways to address these issues in European health and welfare systems will be discussed.

Content

1. Keynotes (30 minutes): 2 keynotes will be delivered – the first (HSL) will summarise the key findings of the inquiry. The second (NM) will address possible responses by clinicians to the increase in long-term conditions and multi-morbidity and the associated increase in workload. The focus will be on improving the partnership with our patients. There will be time for clarification and questions.
2. Group work (30 minutes): participants will be divided into small groups to identify the obstacles and facilitators to the introduction of patient-centred care into their clinical practice at the individual, system and policy levels.
3. General discussion (30 minutes): the raconteurs from each small group will be asked to summarise the key outcomes of their discussion and common principles identified which can underpin our response to these new challenges. The intended outcome will be a consensus statement on patient-centred care in the 21st century.

Keywords: Person centred-care General Practice

WS-007

Who Will Care About The Caregiver?

Özden GÖKDEMİR¹, Ülkü Bulut², Olgu Aygün³, Renata Pavlov⁴, Ana Nunes Brata⁵, Hadiye Küçükkaragöz⁶, Dilek Güldal¹

¹Dokuz Eylül University, Medical Faculty, Family Medicine Department, İzmir, Turkey

²Balçova Public Health Center, İzmir

³Karabağlar Family Health Care Center, İzmir

⁴Family Health Care Center Aleja lipa 2a, 10 000 Zagreb, Croatia

⁵USF Amora Saudável, Portugal

⁶Dokuz Eylül University, Institute of Education Sciences, İzmir, Turkey

Background

Adults caring for persons living with dementia are the second largest informal care giver group not only in the United States but also Turkey because most people with dementia are older adults aged 65 or older. Dementia care givers are more likely to experience a wide range of negative behaviors or health problems than persons with non dementia health problems. For example, dementia caregivers frequently exhibit maladaptive coping strategies, express concern about their poor quality of life, experience lower self-rated health, and report a higher level of care giver burden. In addition, dementia care givers report severe sleep disturbances, clinical depression, and higher mortality compared to other care givers. Interestingly, these negative effects of dementia care giving project to their care recipients because care givers and persons with dementia are interdependent in the family unit. These issues could be concerned for the caregivers of ill children, too. Thus, timely reduction of caregiver stress and related problems are critical for both caregivers and care recipients.

Medical education and medicine (as well as a psychologist, social worker, family counselor, nurse etc) provide care for members of professional groups are also people like themselves. After a while these professionals begin experiencing burnout about themselves. To know the limits of the individual to cope with this situation, to escape from the pressure to be perfect, to be able to continue to grow and learn without losing the motivation.

Method

Before the workshop emotional intelligence scale will be introduced and implemented.

Discussions will be carried out by forming working groups.

Workshop Program Topics:

Burn out Syndrome

Satisfaction of life (Case studies)

Quality of life (Cases and problems)

Coping Stress (Solutions to improve)

Emotional Quantities

Conclusion and Evaluation.

The results will be presented as a declaration.

Keywords: caregiver, burn-out syndrome, coping stress, life quality, emotional quantities, satisfaction of life

WS-008

Diagnostic discrimination between functional and organic bowel disease in primary care

Niek De Wit¹, Pali Hungin³, Greg Rubin³, Knut Arne Wensaas²

¹Julius Center for Health Sciences and Primary Care, Unioversity Medical Center Utrecht, the Netherlands

²Uni Health Reserach UNit for General Practice, Bergen, Norway

³School of Medicine, Pharmacy and Health, University of Durham, UK

Lower gastro-intestinal tract complaints are frequently presented in primary care. About 7% of these patients has organic bowel disease (OBD), such as inflammatory bowel disease or colorectal cancer. Most of the patients have functional bowel disease (FBD), such as the irritable bowel syndrome (IBS). Adequate discrimination is important, as both unnecessary endoscopies as well as delayed detection of OBD is burdening and costly. Presently 20-40% of patients with persisting lower gastrointestinal complaints in primary care is referred for endoscopy, but only in one-third OBD is found. Obviously the diagnostic process in patients with lower GI symptoms in primary care needs to be refined. Patient characteristics, signs and symptoms and specific lab test may in isolation all contribute to the diagnostic process, but integrated diagnostic models are required to adequately discriminate OBD from FBD.

In this workshop the state of the art knowledge regarding the diagnostics process in patients with lower abdominal complaints will be reviewed in the following presentations

1. Prof. dr..Pali Hungin, Durham, UK: The value of the ROME diagnostic criteria in diagnosing functional bowel disease in primary care
2. Dr. Knut Arne Wensaas, Bergen, Norway: The diagnostic contribution of laboratory tests and genetic markers to an adequate diagnosis of organic bowel disease
3. Prof. dr. Greg Rubin, Durham, UK. Lower gastro-intestinal symptoms and signs: how much can they tell us?
4. Prof. dr. Niek J de Wit, Utrecht, the Netherlands: The effectiveness of integrated diagnostic models in discriminating functional and organic bowel disease in primary care

These presentations will be discussed with the audience and put in a clinical perspective. The workshop will finish with recommendations to improve the clinical management of patients with lower GI complaints in primary care.

Keywords: lower gastrointestinal symptoms, diagnosis, organic bowel disease, IBS,

WS-009

Managing Emergencies in Primary care with Limited Resources

Panagiotis Andripoulos¹, Lamprini Tina², Anargyros Mariolis³, Maria Tsironi¹

¹Faculty of Nursing, University of Peloponnese

²Sparta General Hospital, Sparta Lakonia

³Health Center of Areopois, Areopolis Lakonia

Justification:

The managing of emergencies in Family Medicine is always a challenge especially in clinical settings with limited resources, such as rural areas, isolated environments or even areas of political turmoil and refugee camps. Aim of this workshop is to focus on the priorities of emergency management in general and in specific conditions in particular.

Content:

The workshop will have the form of active participation in real case scenarios of emergencies in infectious diseases, respiratory failure, cardiovascular and metabolic emergencies. Each case report will be presented and discussion upon assessment, stabilization and management will take place by the participants. Alternatives according to available resources of each setting will be proposed and additional visual aids will be presented. The participants will have the opportunity to debate on different approaches and strategies proposed by the presenters and the validity of them will be assessed in the closing of the workshop.

Keywords: Emergencies, Family medicine, rural medicine, limited resources, acute conditions.

WS-010

Toxicology in Family Medicine: Treating the Occasional Overdose

Victor K Ng, Susanne Cording

Division of Emergency Medicine, Western University, London, Ontario, Canada.

Justification:

In societies around the world, the use of both prescription and non-prescription drugs have been rising at an exponential rate. Physicians have more access to medications to treat diseases and patients have greater choice and access to the availability of non-prescription and/or over the counter medications. The number of illegal drugs or drugs of abuse have also increased with the advent of synthetic/chemically modified drugs leading to significant harm in its users.

Given the significant morbidity and mortality that can result from medication misuse or overdose, family physicians need to be aware of common drugs that may be involved. The clinical approach to assess and manage patients with undifferentiated overdose conditions should be optimized by understanding classic toxidromes. Physicians should have an understanding of the basic pathophysiology behind the overdose and recognize the importance of initiating early emergency care. Awareness of antidotes to common drug overdose is important to expedite care. Physicians should also be aware of local resources such as the poison control center or intensive care units that may need to be accessed in order to provide appropriate medical care.

Content:

The workshop will be delivered in a large group setting with clinical cases illustrating real life examples of overdose patients. Common drugs involved in an overdose will be reviewed with discussion of clinically relevant pathophysiology and key management modalities. Overdoses that require specific antidotes will be illustrated. The workshop will be interactive such that participants will be encouraged to not only ask questions, but also to share their own clinical cases and offer their perspective on treatment based on their context of practice.

Keywords: Toxicology, family medicine, overdose

WS-011

Which patients with head injury need CT imaging and when is watchful waiting in general practice a safe alternative?

Miranda Kurver, Willem Draijer

Department of Guideline Development and Science, Dutch College of General Practitioners (NHG), Utrecht, the Netherlands

The Dutch College of General Practitioners guideline 'Head injury' provides recommendations for the diagnosis and treatment of patients with head injury. The guideline distinguishes three patient categories based on the risk of brain damage. For patients with a high risk of brain damage, referral to an emergency department is indicated. Criteria for urgent referral are unconsciousness, neurological deficits, post-traumatic seizures or suspicion of severe brain injury following high-energy trauma. For patients with an increased risk of brain injury, for example those taking anticoagulants, referral to, or consultation with, a specialist is recommended. For patients with a low risk of brain injury, for example a 40-year-patient who has vomited after head injury, the guideline recommends watchful waiting and regularly waking from sleep during the first 24 hours. There is little known about the prognostic value of this approach, but it is commonly used in general practice in the Netherlands. In other countries, however, most referred patients will get computed tomography scanning. Despite widespread availability of CT imaging in the Netherlands, the policy of the guideline is to prevent unnecessary referral of patients and to reduce costs. Our aim is to explore the management of patients with head injury in other countries, in rural and urban areas. Participants will get more knowledge about risk assessment and treatment of patients with head injury in general practice.

Content:

After a short introduction about the clinical guideline for general practitioners in the Netherlands and comparison with the English and Scottish guidelines, we will initiate a discussion in subgroups about:

- the criteria for referral;
- use of CT imaging,
- use of watchful waiting and a regularly waking advice.

Then, we will plenary discuss the relevant differences between countries and between rural and urban areas and what can be learnt from the Dutch approach.

Keywords: 'brain injuries', 'craniocerebral trauma', 'tomography, x-ray computed'

WS-012

The adolescent years..... Guiding your child and your teenage patient through adolescent and young adulthood

Enda Murphy, Kandan Loganathan, Patrick Paddy Halligan
Health Service Executive, Ireland

This workshop focus's on the challenges faced by young people in today's fast-paced technology -saturated world and provides advice for GP's on dealing with these challenges.

Discussing everything from low mood and Depression to peer pressure and cyber bullying this work shop will answer frequent questions asked by both parents and teenagers patients of GP's, and addresses what GP's can do to help stabilise young people's mental health through their journey from adolescence to adulthood

Keywords: Adolescence, Teenager, Technology, Bullying, Parent, Guiding

WS-013

Migration-related health disparities in immigrant children; the need for community oriented primary care and the role of the GP

Maria Van Den Muijsenbergh¹, Anne Meynard³, Rebecca Farrington⁴, Viviane Martinez Bianchi, Gp⁷, Marwa Achmed, Gp⁶, Guus Busser², Eldine Oosterberg⁵

¹Pharos centre of expertise on health disparities, Utrecht, The Netherlands

²Department of Primary and community care, Radboud University Medical Centre, Nijmegen, the Netherlands

³Département de l'enfant et de l'adolescent, Hôpitaux Universitaires Genève, Switzerland

⁴Community Based Medical Education, University of Manchester, UK

⁵Dutch College of General Practitioners NHG, Utrecht, the Netherlands

⁶General Practice, London, UK

⁷Family Medicine, USA

Justification:

A growing number children and adolescents in Western countries (more than 20% of all children) belong to ethnic minorities and / or are of immigrant origin. In general their health is worse compared to the health of native children of the same socio economic BACKGROUND: higher incidences of perinatal death, obesity, problem behaviour) and there are indications that they face lower quality of care – in particular less continuity of care and less timely or appropriate care, also in general practice. GPs experience challenges in providing good care for these children as their needs extend beyond the physical domain, and because of ethnic differences in symptoms and prevalence's, as well as language and cultural barriers.

Goals of this workshop organised by the WONCA Special Interest Group on Migrant care and International health and Travel medicine:

- exchange knowledge on health and health care of ethnic minority and migrant children in Western Countries
- exchange experiences and good examples for optimising primary care for these children
- expanded awareness of the need for integrated, community oriented primary care
- inspiration to provide good quality primary care for migrant children and for collaboration with other organisations in the neighbourhood.

Content

1. Health and health care of ethnic minority and migrant children.

Short Presentations on the health problems of migrant youth, the challenges primary care providers face followed by discussion and exchange of experiences.

2. Good care for migrant children: the need of integrated community oriented primary care.

An example will be presented to prevent social exclusion of migrant children. Participants will discuss in small groups the need and possibilities for GPs to work together with other organisations in the neighbourhood (schools, social work, play grounds etc).

3. Plenary report 5 minutes conclusions

Keywords: migrant children, health disparities, community oriented primary care

WS-014

Health and Health Care for Refugee Children

Maria Van Den Muijsenbergh¹, Suzanne Gagnon², Anne Meynard³, Pinar Doner⁴, Rebecca Farrington⁵

¹department of Primary and community care Radboud University Medical Centre, Nijmegen, the Netherlands

²Clinique santé des réfugiés, CSSS de la Vieille-Capitale, Québec, Canada

³Médecin adjoint chef de service Unité Santé Jeunes. Département de l'enfant et de l'adolescent Hôpitaux Universitaires Genève Switzerland

⁴GP Syrian refugee camps Turkey,

⁵GPwSI in asylum seeker mental health for Greater Manchester Mental Health Trust

Justification

Approximately 8 million refugees worldwide are younger than 18 years; refugee children make up 45% of all refugees. They are especially vulnerable in their physical and mental health and social well-being. Trauma's of violence and losses affecting themselves or their parents, harsh living circumstances, frequent moving of places and changing of schools all have a negative influence on their health. At the same time these children often need to fulfill tasks not proper for them, like interpreting for their parents, leading to unhealthy parentification. Family Physicians are usually the first to face these problems and should be aware of the impact of forced migration on the health of children. At the same time primary care offers unique possibilities to guarantee accessible quality care to all in the population, including vulnerable refugee children.

Goals of this workshop organised by the WONCA Special Interest Group on Migrant care and International health and Travel medicine:

- exchange knowledge on health and wellbeing of refugee children in different settings
- exchange experiences on problems primary care providers face in relation to good care for refugee children
- exchange ideas and good examples for optimising primary care for refugee children
- inspiration and tools to provide accessible good quality primary care for refugee children

Content

1. Health and wellbeing of refugee children in different settings.

Short presentations on the health problems of refugee children in general and in the Syrian refugee camps in Turkey as well as on the hidden problems of parenting in refugee children in the UK.

2. Primary care for refugee children: challenges and opportunities.

Discussion in small groups followed by plenary discussion about what care refugee children need, what challenges GPs meet and what they can offer and good examples.

3. Plenary report and conclusions

Keywords: Migrant children, Refugees, asylumseekers

WS-015

The Family doctor as a promotor of breastfeeding

Maria Ana Sobral¹, Daniela Runa¹, Mario Machado Cruz¹, Susana Medeiros¹, Sara Magalhães¹, Ines Dias Ferreira²

¹Unidade de Saúde Familiar AlphaMouro, Rio de Mouro, Portugal

²Unidade de Saúde Familiar Venda Nova, Amadora, Portugal

INTRODUCTION: Human milk has all the ideal nutritional characteristics for the development of biological functions, immunological protection and emotional development. Extensive research on the matter has proved its role in the diminishing of infant mortality rate and disease prevention. In spite of the growing recognition that lactation is important, the training of healthcare professionals in breastfeeding (BF) has been a little disregarded. Family Medicine aim at promoting health education and are fortunate to contact not only with pregnant women but also with children. Thus, it is crucial to provide both knowledge and proper advice on BF in the maternal and child health appointments. **AIMS:** Recognise the importance and advantages of BF; Facilitate knowledge of techniques related to BF; Identify problems that might occur in breastfeeding and provide strategies to deal with the most common difficulties; Promote BF in a way that is both satisfactory for the mother and the baby.

METHODOLOGY: Introduction: presentation, aims, knowledge test; International background; The importance of breastfeeding; Brainstorming; Turning points in BF: Exposition; Difficulties in breastfeeding and how to support:

Brainstorming /Video/Roleplay;How to keep breastfeeding when returning to work:Video. Exposition and DISCUSSION: Simulation of practical scenarios: Role-play;Self-evaluation. Discussion: Bearing in mind that this is a workshop we think that a self-evaluation test done at the beginning and repeated at the end of the session is important so that we can assess if the aims of the training were achieved. We look forward to a dynamic session that will be possible through varied teaching formats in a way that all participants will get involved in their own training. It is expected of the participants that in the end they will feel more comfortable in guiding pregnant women and parents in BF thus promoting healthy breastfeeding for both parents and children.

Keywords: Breastfeeding; Promotion

WS-016

How To Establish An Outpatient Clinic For The Elderly, Measures to Take

Didem Kafadar¹, Hakan Yaman²

¹Department of Family Medicine, Bagcilar Training and Research Hospital, Istanbul,Turkey

²Akdeniz University,School of Medicine, Department of Family Medicine, Antalya, Turkey

Justification: Population is getting old. Most of the patients admitted to outpatient clinics are geriatric, over 65. They have been diagnosed with usually more than one disease. Due to the availability of treatments for chronic diseases, they usually are on polymedications for a very long time. Elderly may face cardiovascular diseases, cancer, dementia, depression, osteoporosis, vision and hearing problems. We need specialized outpatient clinics run by family physicians. Elderly are frail and certain assessments are needed. Mental, nutritional, social evaluations with the help of certain established tools are needed. Fall risks should be mentioned to the family. If the patient has a serious disease then palliative care in all means should be introduced to the patient and the family. Quality of life of the elderly should be assessed also. Once the basic care and assessments are done if needed the patient may be referred to the geriatrists in the secondary health centers. If a standardized patient care is established, we can then promote a healthier life for them.

Content: The setting of the outpatient clinic, the basic tests for assessment of the health of the patient, further assessments to be done, tools to be used, the algorithm of the approach to the elderly, managing medications, informing the family about the patient, the follow-up are the topics to be covered. The activity will consist of problem solving by different cases, seminars and role plays and interactive discussions. We will try to develop interventions that will enable more elderly people to be and feel healthier.

- Mini-Lecture: Health Promotion in Aging Population: An Overview (20 min)
- Mini-Lecture: Screening of Elderly People in Primary Care (20 min)
- Group Work and Presentations (25 min)
- Round-up: Conclusion and Remarks (10 min)

Keywords: Aging, Family Practice, Elderly Care, Prevention, Health Promotion

WS-017

"What happens in the bedroom? Can you solve the mystery?"

Elle Mall Keevallik¹, Maili Jorro²

¹Department of Family Medicine, Tartu Ülikool, Estonia

²University of Tartu

Sexual health is an important component of primary care. Sexual health is thought to be very important for overall health and disease free life. But talking about sex and sexual health is taboo in many countries around Europe.

We as general practitioners should be able to talk about these topics without judgement or embarrassment, shame.

We need to know how to bring up the topic if patient is afraid/ embarrassed to talk. We need to be psychics literally - to understand what the patient wants.. Usually patient don't come to doctors telling they want to talk about their sex life, usually GP's need to ask multiple questions before patient starts to talk. Before asking questions - GP has to develop a certain rhythm and pattern about sexual health topic. If one is afraid to ask questions or is not a mindreader then there is a change, that the patient leaves without any help.

Asking questions about sexual health should be part of every day practice and should come naturally even if patient does not bring the topic of sexual health to the table.

We as family doctors should feel comfortable talking about sex and sexual health.

Main goal for this workshop is to make GP's comfortable to ask the questions without fear and shame. Practice makes perfect as we all know.

Plans for the workshop

- interactive game, breaking the taboos
- discussion in small groups
- role play
- conclusions and take home message - receipt how to ask the first questions.

Keywords: Sexual health, awareness, taboo, education, self-improvement

WS-018

Goshinken, a practical tool to improve mind-body fitness in Family Medicine

Elena Benigni

Family Medicine department, Accademia Shoho, Italy

Justification: Physical exercise is the based-evidence first step to approach lots of different disorders. Reviews suggest that in order to improve self-efficacy and long-term adherence in healthy behaviors, as well as to improve personal stress management skills in primary and secondary preventions. Nevertheless, physical activities require more time and money than patients want to spend, so we often skip this, which is the more effective and significant step to treat and prevent the most common and onerous diseases. In our Academy we provide free courses to these doctors and health workers who want to provide to their patients a shorter assessment tool, which is called Goshinken (in Japanese it means "Energetic Martial Art").

Goshinken involves a very easy and powerful exercises to any ages and physical conditions. These activities, besides stimulating metabolism and oxygenation, also could improve the empathy amongst doctors (or health workers) and their patients, so the compliance and care feelings become easier.

Content: We will demonstrate the 10 basic Goshinken exercises (for at least about 2-5 minutes) with every participant. We want to stimulate discussions on the practicality and applicability of the short techniques learned among our patients population. In the end, we hope there will be proposals for researching and collaboration within family physicians from different countries to promote exercises in the daily clinical practice.

Keywords: Physical exercise, primary preventions, secondary prevention, compliance, Goshinken

community health



WS-019

How To Assess Risk-Taking Behaviors and Sexuality During An Adolescent Care Office Visit

Grace Abi Rizk, Jihane Naous

Department of Family Medicine, Saint Joseph University, Beirut, Lebanon

Justification

Detection and discussion of risk-taking behaviors in adolescents by pediatricians and family physicians could be limited if not addressed adequately. Using a psychosocial review of systems and ensuring confidentiality could increase spotting problems and reduce morbidity and mortality among teenagers.

Content

To have effectual communication and retrieve valuable information, physicians should facilitate convenient interview environment and acquire technical interviewing skills to approach adolescents. The workshop aims at providing further understanding on using screening tools, open-ended and/or oblique questions as techniques to move from a topic to another during a HEEADSSS interview. Moreover, the workshop will highlight on the importance of confidentiality in adolescent care, particularly when assessing risk behaviours, gender identity and sexuality among other psychosocial matters.

Oblique questions about peers' activities and peer pressure; beside CRAFFT questionnaire: a validated office-friendly tool; are useful in an initial assessment to obtain understanding on substance misuse including tobacco and alcohol, and its related safety.

Assessing sexuality can be evenly addressed by passing from general to specific questions. Gender identity, sexual history/behaviour and joint occurrences should be screened. In fact, in sexuality, more than in other topics, the teenager will not tell unless asked specifically. He/she might not know what is considered sexual activity and what he/she should disclose from his/her sexual history.

Family physicians can practice on clinical case scenarios to improve their interviewing skills. The use of recommended open ended questions/tools for each category assists in developing their unique interviewing style. If a screening question turns positive in any section, the interviewer can go deeper and provide education and counseling. The most important is that the teenager feels the support and guidance whenever he/she wants to reveal something, whether during the actual visit, or in a subsequent one.

Keywords: adolescents, risk behaviors, sexuality, gender, substance misuse

WS-020

GPathome: how to get evidence based patient education in our pocket

Roy Beijaert, Ton Drenthen

Dutch College of General Practitioners (NHG)

“Justification”: Guideline based patient education is becoming a major tool in general practice in the Netherlands. Tablets and smartphones bring our patients self-efficacy *“in their pocket”*.

The purpose of our workshop is: to share knowledge and experiences on patient education (PE) in our countries. To discover the relation between PE and the regional guidelines and the different levels of PE in different countries. How do the different GP's use evidence based PE before, during and after consultation?

“Content workshop”:

“Introduction”: In 2011 the NHG launched a public website with information about health and diseases, named in Dutch: thuisarts.nl (*“GPathome”*). The aim was to 1) guide patients in the labyrinth of health-related information on the internet, 2) support GP's in patient education and 3) produce patient versions of our guidelines. In 2013 a *“GPathome”* app was launched. We had 13.000.000 visits last year.

“Summing up/discussion”: how does patient education work in your country/region? Do you use it? Do your patients use it? Do you use it together?

“Plenary feedback”: result from each group

“Description of Dutch situation”: The content of our website *“GPathome”* is largely based on evidence-based practice guidelines of the Dutch College. Information on what to do and when to call the GP is given. The patient can reach in to: illustrations, short video's, patient decision aids and evidence based e-health self-management tools. 90% of the Dutch GPs use *“GPathome”* in daily practice.

“Discussion in small groups”:

What is the relation between PE and your regional guidelines?

What are the different levels of PE available in your region?

How do you use PE before, during and after consultation?

“Plenary feedback”: result from each group

“Sharing Tips and tricks”: including tips and tricks from the *“GPathome”* team

“Take home message”

Keywords: patient, education, guidelines, evidence, ehealth, selfmanagement, selfefficacy

Home page of GPathome <www.thuisarts.nl>



Waar bent u naar op zoek?

ZOEKEN

Zoek op beginletter:

A B C D

JACQUELINE GROEN IN 'T WOOD, HUISARTS

Thuisarts.nl geeft betrouwbare en onafhankelijke informatie van uw huisarts over gezondheid en ziekte. [Meer info](#)

Zoek op lichaamsdeel



Updates

- > Nieuw: Psoriasis
- > Vier nieuwe onderwerpen
- > Nieuw: etalagebenen

Nieuws

- > E-consult bij eigen huisarts
 - > Mazelenepidemie voorbij
 - > Cholesterol laten meten? Test uw risico
- [Meer nieuws](#)

Direct naar

- > Lentef
- > Huisartsenzorg
- > Moet ik naar de dokter?

Download Thuisarts app



Thuisarts.nl is ontwikkeld door ook namens uw huisarts
nederlands huisartsen
genootschap



[Sitemap](#) [Over thuisarts.nl](#) [Disclaimer](#)

Trough this forum Dutch patients and their GP's are informed about recent evidence.

Thuisarts statistics

Visitors 22-2 t/m 24-3-14



Insight in number of visitors at GPathome.

WS-021

A Visit to the Temple: The Cardiac Exercise Stress Laboratory

Vincent Ted Leon¹, Ruth Wilson²

¹Dept of Family and Community Medicine, John A. Burns School of Medicine, University of Hawaii, Honolulu, Hawaii, USA

²Department of Family Medicine, Queen's University, Kingston Ontario Canada

Justification:

Despite advances in medical therapy, cardiovascular disease continues to cause high morbidity and mortality in all developed nations. More recently, the WHO and other leading international organizations have brought attention to cardiovascular disease as a leading cause of death in all developing nations, as well. Early detection and prevention of cardiovascular disease is more important than ever. The Cardiac Exercise Stress Lab provides important diagnostic and prognostic information, and plays a therapeutic role as well.

Content:

In this Workshop, participants will learn about exercise stress testing, using standard protocols of treadmill testing, cycle ergometry testing, and upper extremity ergometry testing. A brief presentation will include indications and contraindications for testing; common hemodynamic responses to exercise; interpretation of common ECG findings; The Duke Treadmill Risk Score; The additional diagnostic value of stress echo imaging and nuclear myocardial perfusion imaging.

Three Case Studies will include a 30 yr old female with morbid obesity who is seeking bariatric surgery, a 50 yr old male with cardiac risk factors, and a 70 yr old male who is a competitive ironman triathlete and endurance runner.

Participants will break into small groups to discuss how cardiac exercise testing is performed in the countries where they practice, and international comparisons will be made, and discussed.

Dr Leon is the Director of the Cardiac Exercise Stress Laboratory at Queens Medical Center, and was a Bariatrician and Associate Director for their Comprehensive Weight Management Program from 2004-2012, where he did all the pre-op and post-op evaluation for over 1000 morbidly obese patients who underwent bariatric surgery. He is also an endurance runner and 4 time Ironman triathlete, most recently at the 2012 Kona Ironman World Championships. He has worked as a medical tent physician for the Ironman Championship since 1999.

Keywords: English

WS-022

Community based preventive activities and the role of the GP: A Europrev workshop

Ton Drenthen¹, Karolien Van Den Brekel², Mateja Bulc³, Eva Jurgova⁴

¹Dutch College of GPs, Utrecht, The Netherlands

²Julius Health Centers Leidsche Rijn, University of Utrecht, The Netherlands

³Ljubljana Community health center and Ljubljana University Medical Faculty, Ljubljana, Slovenia

⁴Slovak Society of General Practitioners

Justification

To effectively deal with the increasing burden of lifestyle related chronic disease in Europe, a combination of a personalized prevention approach and a community based approach in the population is needed. In Europe and other parts of the world there are effective and [promising community-based programs and interventions, which aim to prevent disease and create a healthier population.

Aims of this workshop: to show best practice examples of community based prevention programmes and to exchange experiences with the implementation of these programmes in GP and public health in EUROPREV countries.

Content

In this workshop some examples of good practice programmes in different countries will be presented. The role of the GP in prevention and the collaboration with public health will be discussed.

In the workshop the following aspects will be presented:

- Brief introduction about Europrev network (Mateja Bulc)
- Introduction and examples of community based prevention activities in Europrev countries (based upon survey among Europrev delegates, and the role of the GP in prevention (Ton Drenthen)
- Examples of community based prevention in different countries:
 - The Netherlands: with a variety of best practice preventive projects, such as the web-based cardiovascular health risk assessment (the personal health check), an implementation model has been developed for 'infrastructure of a healthy community, by Karolien van den Brekel, GP, Utrecht The Netherlands
 - The national preventive programme in Slovenia- model family medicine practices, by Mateja Bulc
 - The Slovakian experience, by Eva Jurgova

Discussion with the audience: share experiences, success factors and pitfalls about strategies to organize community based prevention programmes in a variety of countries with different background. How to implement community based health prevention, and how can GP's collaborate with public health and other partners in the community.

Conclusion and take home messages

Keywords: prevention, public health, health promotion

WS-023

M- and E-mental health: new dimensions to deal with problematic alcohol use. An update by the ALCOHOL WORKING GROUP OF EUROPREV

Lodewijk Pas¹, Frederico Rosario², Mateja Bulc³

¹Academic Center General practice, Catholic University Leuven, Belgium

²University of Lissabon

³Society of Slovene family physicians, Ljubljana, Slovenia, Chair of Europrev

AIMS:

- To review strategies to implement effectively identification and counselling in general practice on problematic alcohol use
- To review how m and e-health can be integrated into general practice to deal more effectively with problematic alcohol use (EUROPREV countries).

BACKGROUND:

Increasingly web programs are used for self-care on alcohol problems. Multimedia use and mobile phones show different possibilities. Several reviews were made to illustrate their possibilities, but integration in general practice is only in its beginning.

METHODS:

This workshop will create a forum for exchange about different models for support of general practice involvement on dealing with problematic alcohol use. Barriers to implementation will be explored and models how to overcome them.

In particular we will review e- health initiatives through self-evaluation and web based support only, integrated care into multiphasic prevention and a stepped care model. The advantage of active follow up through m-health will be additionally discussed.

Web-based self-care has also shown to be effective. However to enhance more long term effects a strategy is needed to include self-care, general practice counselling and specialist support into a comprehensive primary care strategy with active follow up. M-health can provide a methodology for latter element.

CONCLUSION:

As we adapt our health education to stages of change of our clients, we must adapt also our support to different general practices to help them to become more actively involved in dealing with problematic alcohol use. A model will be presented how to do this. After the meeting participants may be invited to join collaborative action in this field.

Keywords: prevention,alcohol,e-health,m-heath,quality assurance

WS-024

Management of “cross-border” children`s immunization schedule

Gheorghe Gindrovel A Dumitra, Dana Stefana Popescu, Sandra Alexiu, Cristina Barbu, Daniela Stefanescu, Dorica Sandutu, Maria Lup, Anca Deleanu, Raluca Zoitanu

Immunization working group– Romanian National Society of Family Medicine

One of the greatest challenges Romanian family doctors face is how to manage the health needs of children coming from families that temporarily live in different EU countries following the implementation of EU laws on freedom of movement for workers. The recommendations on preventing transmissible diseases through vaccination vary throughout Europe. Every country`s healthcare system has a different approach regarding vaccination, therefore Romanian physicians / GPs have to adapt the immunization schedules taking into consideration several facts. Some of them are: the country where the child was born or raised in, the history of the child regarding vaccination, the epidemiological context but also the future of the child. The general practitioner`s approach towards this problem involves assuming responsibility for the child, his/her family, the community and last but not least for the fellow GPs from other countries. What is the right approach regarding this problem? Are there other GPs dealing with this situation? If so, how are they dealing with it ?

Keywords: immunization schedules, prevention, vaccination

WS-025

The right words to promote vaccination

Sandra Adalgiza Alexiu¹, Arzu Uzuner², Dilek Guldal³, Christos Lionis⁴

¹Immunization Working Group, National Society of Family Medicine, Romania

²Family Medicine Department, Marmara University Medical School, Turkey

³Family Medicine Department, Dokuz Eylul University Medical School, Turkey

⁴Clinic of Social and Family Medicine, Faculty of Medicine, University of Crete, Heraklion, Greece

Most countries are facing decreasing vaccination coverage in children. One of the causes is the increase in refusals from parents to vaccinate their children. Therefore, counseling of the parents done by family doctors who vaccinate becomes extremely important. Family doctors must have solid knowledge related to building the messages used when speaking to parents, the media and healthcare decision makers.

AIMS

The aim of this workshop is to understand the importance of using proper / right words in building simple-messages and key-messages in order to promote vaccination, using communication tools on the subject, at our disposal on the CDC, ECDC and WHO websites.

OBJECTIVE

After the workshop, the attendees will:

- ♣ be able to compose at least three pro-vaccination messages
- ♣ take home a few good ideas about using proper / right words in communication with patients, media and decision-makers

METHODS

Introduction by moderator (5 mins)

1. Brainstorming (10 minutes): collecting goals and expectations and list the main challenges the participants face in their counselling set.

Lecture 1 (15 minutes): data about the decreasing vaccination coverage, main causes of the process, focus on parents refusals and the importance of good communication skills of GPs.

Lecture 2: (15 minutes): buliding simple-messages and key-messages, targets and resources for GPs

2. Work in small groups (20 mins)

3. Reports from the small groups (15 mins)

4. Conclusion by moderator (10 mins)

EXPECTED RESULTS

The findings, strategies and resources identified in the workshop will be summarised. As part of the workshop, we also propose to seek interest in establishing a WONCA Immunization Special Interest Group, and the participants are invited to contribute directly to further development.

Disclosure: No conflict of interest declared

Keywords: Refusal, key-words, communication tools, messages

WS-026

Vaccination for pregnant women

Dorica Sandutu, Sandra Alexiu, Cristina Barbu, Gindrovel Dumitra, Daniela Stefanescu, Raluca Zoitanu, Dana Stefana Popescu, Anca Deleanu, Maria Lup

Immunization working group—Romanian National Society of Family Medicine

Starting with 2004, CDC'S ACIP strongly recommended flu vaccination for pregnant women in second and third trimester, during the winter and spring season. The immune system, and organs, are changing during the pregnancy, so, women are more likely to become ill or to have a more severe clinical evolution of the illness. Moreover, complications occur more frequently leading to hospitalization or even exitus. This translates, from the baby point of view, in an increased risk of abortion, or premature delivery.

Therefore, flu vaccination is recommended for all pregnant women during the second and third trimester.

Antibodies produced by the mother's immune system, will protect baby during the flu season.

It was noticed the hesitation, or, even refusal of the vaccination on behalf of pregnant women, and the doubt, resistance from families, facing these preventive action on the future mother. Vaccinator doctor – family doctor in Romania, must answer the questions from pregnant women, present her information about efficiency and safety of vaccine, in turn to risks of vaccine refusal.

Keywords: pregnancy, flu, prevention, vaccination

WS-027

Vaccine advocacy the bridge between vaccine refusal and social norms awareness

Valeria V Herdea, Liliana Barbacariu, Ileana Brinza, Emiliania Costiug, Ioan Muresan, Raluca Ghionaru
Romanian Association for Education in Family Medicine

Justification

In the modern world we have three great threats: antibiotic resistance, low vaccination coverage and peace maintenance. All three are strongly interconnected. If vaccination coverage will be low, people are not vaccinated, we will be serious clients for infectious diseases. If we are not vaccinated, we will take a lot's of antibiotics and finally we will be in the situation to see high rate for antibiotic resistance. The diseases, born poverty, conflicts and in the end wars.

The modern era seems to be in conflict with her own progress

PURPOSE: sharing vaccine advocacy's experience with GP's team from other countries in finding optimal solutions for raising rate of vaccination coverage.

Vaccination remains indisputably the most cost-effective measure that we can preserve the life and health of dearests. Evidence based medicine remains the best lawyer for this purpose. Life has demonstrated the superiority of prevention versus treatment.

Imunise, prevent and protect: protect yourself first. Protect your family and then the community where you live.

The concept of freedom- must be well understand. You can understand the freedom like the understood necessity. The aspect means taking the hole responsibility and accepting social norms without that life can not be conceived as evolving but as an involutive process

The existence of a National Immunization Program (NIP), compliance with this program to the whole population, optimal vaccine coverage of over 95%, remain the guarantor of maintaining long-term health of our children

Key words: advocacy, teams, norms

WS-028

Why do we drink?

Marta Velgan, Helena Tamm

University Family Clinic

Excessive alcohol consumption can lead to different health related, psychological and socioeconomic problems. As family doctors it is our job to screen people's alcohol consumption, inform them about the health risks related to excessive alcohol consumption and help them drink less or quit for good. But how often do we ask ourselves why do we drink? Why do our patients drink? Understanding why we consume alcohol can help us as doctors understand our patients better and help people to be healthier. We can also use this knowledge to influence the health policy in our countries to create an environment which supports better choices.

The session will start with group work, each group will get a sentence to finish or a question to answer; for example "Alcohol makes people feel...", "Why people drink?", "In which occasions people drink?" etc. In the next part there will be a short presentation about the psychology of drinking and the theory of planned behavior. At the end of this session we will practice on each others using motivational interviewing how to talk with our patients about alcohol consumption, how to find out the reasons why they drink and their motivation to change their behaviour.

Keywords: Alcohol; psychology; health policy

WS-029

Practical tips for obtaining a PAP smear in family practice

Işık Gönenc, Zeynep Tuzcular Vural

Department of Family Medicine, Haydarpaşa Numune Training and Research Hospital, Istanbul, Turkey

Justification: In 1928, Dr Papanicolaou discovered that cells in the cervix changed microscopically in appearance before they became cancerous. Thus the Pap smear is recognized as a screening tool to find early warning signs that cancer might develop in the future. The sensitivity and specificity of Pap smears are reported to be 72% and 94%, respectively. Obtaining a Pap smear is a simple, quick, and painless procedure. It only takes a few minutes. No drugs or anaesthetics are required and it can be done by anybody who is working in primary health care.

Content: A Pap smear is a valuable tool, which incorporates the partnership of both the physician and the pathologist. Although a very valuable tool, unfortunately there are still inadequacies in collecting cells, preparing slides, interpreting and managing the results. So it is crucial to know the techniques of proper Pap smear taking and to be able to interpret the results of the report to complete the picture. In this workshop we aimed to emphasize some tips for getting the best results from Pap smears. The participants will get a chance to review proper sexual history taking before obtaining Pap smears. They will review the "Bethesda" terminology and practice the management of Pap smear results. New techniques will be introduced and their advantages and disadvantages over one another will be discussed. Each participant will be able to know the necessary equipment and to obtain smears from a life size pelvic model and learn the techniques of preparing slides. Participants will also discuss their experience with PAP smears.

Keywords: PAP smear, Bethesda terminology, screening, cervical cancer

WS-030

Cancer & Palliative Care WONCA Special Interest Group: The role of family doctors in cancer rehabilitation and palliative care

Annette Berendsen¹, Dorte Gilså Hansen², David Weller³, Alis Ozcaker⁴, Hibah Osman⁵, Scott Murray³, Geoff Mitchell⁶

¹University of Groningen, Netherlands

²University of Southern Denmark, Denmark

³University of Edinburgh, United Kingdom

⁴Uludag University, Turkey

⁵American University of Beirut, Lebanon

⁶University of Queensland, Australia

Justification - Family doctors play an increasing part in the care of cancer patients. This workshop will provide up to date evidence on cancer rehabilitation and palliative care

Content - The workshop is divided into two sections - for each we will present latest evidence and research, along with practice tips for family doctors.

The first section will focus on some of the many problems family doctors must address in helping patients with cancer and their partners/care givers. Patients whose acute phase of cancer treatment is over typically have complex needs. Support from their family doctors can take many forms including detection of recurrences and psychosocial support. There are many issues that can sometimes be neglected, such as chronic co-morbidities, fatigue, lack of physical activity, help with returning to work and mental health problems.

The second half of the workshop will focus on palliative care, and include the results of a study of family physicians' attitudes about end of life care in Turkey (including opioid prescribing, communication issues etc), and an overview of palliative care developments in Lebanon (examining strategies to maintain function in our patients despite advancing illness).

Presentation type – workshop format, comprising speakers followed by panel discussion. The workshop will be interactive, and will focus on practical, up-to-date advice to help family doctors enhance their roles in caring for cancer and palliative care patients

Keywords: cancer rehabilitation, palliative care

WS-031

Effective Interventions with survivors of violence- Primary care interventions that empower patients, increase provider efficacy, and reduce morbidity in a residency curriculum

Patrick S Mcfarlane

Department of Family Medicine, Family Medicine Center and Residency Program Eastern Maine Medical Center

The confounding issues of interpersonal, cultural and institutional violence is often conflated with patient medical conditions.

Robust psychosocial tools supported in the scientific literature are available, and physicians are in a powerful role to address violence in primary care settings. When the physician addresses violence briefly and directly using these tools it can reduce morbidity in patients and patient families, while also improving the outcome of medical interventions, reducing physician burnout and empowering the physician by understanding the context of the patient.

This presentation will focus on a powerful curriculum used in residency education that has been transformative to practice in terms of adding a perspective related to patient history, empowerment, and activation and changing physician review of systems to include violence.

Resident physicians report that their practice and engagement with patients has radically improved and that patient course and outcomes have been improved. Physicians report that their competence in their professional

behavior to be significantly changed ($p=.0003$). This curriculum is now an edited and peer reviewed part of the American Academy of Family Practice (AAFP) and Society for Teachers of Family Medicine (STFM) Residency Curriculum Resource, and the pilot study was peer reviewed for discussion at the STFM annual conference. What is new here is that the number of residencies and primary care clinics involved has increased to a national sample of 11, and these data will be presented. Workshop participants will receive the curriculum in brief and the pilot curriculum outcome study data and methods, and then participate in a discussion about interpersonal and community violence (IPCV) in their clinic and discuss primary care approaches to intervention and how they might use this curriculum and assessment or invent their own.

Keywords: Primary Care, Violence, Intervention, Curriculum, Educational Research

WS-032

Detection and multidisciplinary collaboration in intimate partner violence primary care. A EUROPREV and WONCA SPECIAL INTEREST GROUP FAMILY VIOLENCE WORKSHOP

Lodewijk Pas¹, Sylvie Lo Fo Wong², Carmen Fernandez Alonso³, Joyce Kenkre⁴, Tanja Pekez Pavlisko⁵, Raquel Gomez Bravo⁶, Gene Feder⁷, Mateja Bulc⁸

¹Academic Center General practice, Catholic University Leuven, Belgium

²Primary health care, Gender & Women's Health, Radboud University medical center Nijmegen, Nijmegen, the Netherlands

³SEMFyC, Consejeria de sanidad, generancia regional de Salud Castilla y Leon, Valladolid, Spain

⁴University of South Wales, Glenmorgan, Wales, UK

⁵Primary care center Kutina and Wonca Rural working party, Croatia

⁶VASCO DA GAMMA

⁷Bristol University, UK

⁸Society of Slovene family physicians, Ljubljana, Chair of Europrev, Slovenia

Justification:

Intimate Partner Violence has been gaining epidemic dimensions in last decades and emerged as an important health issue in the 21st century. It is responsible for the greatest burden of disease in young women, and is associated with poorer physical and mental health, risk behaviors and early death.

The Wonca Special Interest Group is a network of researchers and trainers coordinating efforts to develop effective implementation strategies for family violence and intimate partner violence in particular.

In this workshop participants will be informed about recent advances how to detect counsel and collaborate in the care for intimate partner violence. Priorities for research will be defined and collaborative projects may be initiated.

Content:

Topics dealt with will be

1° Prevention and counselling for intimate partner violence

2° Multidisciplinary approach of intimate partner violence according to available facilities

3° Research priorities about intimate partner violence

Results of network exchange and selected projects will be presented by representatives of the Special Interest Group and discussed with the audience. Following issues prepare the debate: Conclusions of the Europrev meeting in Austria on prevention and the Wonca Rural meeting on multidisciplinary collaboration. A synthesis of experiences in the Netherlands, Australia, Belgium, Spain, US and UK discussed at a preconference symposium will also be presented.

Presentation type:

Introductory presentations will be followed by small group work to discuss application possibilities in countries of all participants.

To conclude:

Representatives of national colleges and academies of general practice / family medicine are invited to join actively the development of a common implementation plan to put into practice the role of general practice in dealing with IPV. A formal statement WILL BE submitted to WONCA in his regard. Promotion of resource materials online to support this role should be promoted.

Keywords: domestic violence, intimate partner violence, prevention, multidisciplinary collaboration

WS-033

Dealing with intimate partner violence from a family perspective in different cultural contexts

Lodewijk Pas¹, Amanda Barnard², Lorraine Bacchus³, Carmen Fernandez Alonso⁴, Sylvie Lo Fo Wong⁵, Nena Kopcovar⁶, Joyce Kenkre⁷, Tanja Pekez Pavlisko⁸, Angela Taft⁹, Abimbola Silva¹⁰, Omneya El Sharif¹¹

¹Academic Center General Practice, Catholic University Leuven, Leuven Belgium

²Australian National University, College of Medicine, Biology and Environment, Canberra, Australia,

³Gender Violence and Health Centre, Department of Global Health and Development; London School of Hygiene & Tropical Medicine, London

⁴SEMFyC and Consejería de sanidad, generancia regional de Salud, Valladolid, Spain

⁵Primary health care, Gender & Women's Health, Radboud University medical center Nijmegen, Nijmegen, the Netherlands

⁶Department of Family Medicine, Faculty of Medicine, University of Ljubljana, Ljubljana, Slovenia

⁷University of South Wales, Glenmorgan, Wales (UK)

⁸Primary care center Kutina and Wonca Rural working party, Dubrovnic, Croatia

⁹Judith Lumley Centre (formerly Mother and Child Health Research) La Trobe University, Melbourne, Australia

¹⁰University Nigeria

¹¹Cairo University Hospitals, Egyptian Fellowship Board

Justification:

Family violence has been gaining epidemic dimensions in the last decades and has emerged as an important health issue in the 21st century. It is responsible for the greatest burden of disease in young women, and is associated with poorer physical and mental health, risk behaviors and early death.

The WONCA Special Interest Group is a network of researchers and trainers coordinating efforts to develop effective implementation strategies for family violence and intimate partner violence in particular.

In this workshop participants will be informed about the results of a consensus process about dealing with intimate partner violence with particular attention to the family perspective and local communities. This exchange was held as an interaction online within the WONCA SIGFV.

Content:

Topics dealt with will be

1° Intimate partner violence and the local family perspective including children witnessing violence

2° Intimate partner violence and cultural diversity

3° Research priorities on domestic violence

Synthesis of literature and projects in a number of countries (e.g. Netherlands, Australia, Belgium, Spain, US and UK) will inform the debate. Results of network exchanges and selected pilot projects will be presented by representatives of the Special Interest Group and discussed with the audience as follows:

WONCA Rural meeting in Croatia (Topic 2, April 2015)

WONCA Africa meeting (Topic 1, 2 and 3, April 2015)

EGPRN meeting in Rumania (Topic 3, May 2015)

Presentation type:

Introductory presentations per topic and small group work to discuss application possibilities in countries with participants.

To conclude:

Representatives of national colleges and academies of general practice / family medicine will be invited to join actively the development of a common policy plan to implement and study the primary care role. Resource materials will be shared online after the meeting for country application.

Keywords: intimate partner violence, mental health, multidisciplinary care, family, abuse, women health, prevention, detection, counselling

WS-034

The right to be protected – a practical approach to Family Violence within Primary Care

Sara Belinchon, Sara Rigon, Rosa Avino, Raquel Gomez Bravo, Nina Monteiro, Yusianmar Mariani, Elena Klusova, Sara Conde, Monica Teran

VdGM Special interest group on Family Violence

Justification:

Family Violence, particularly violence against women, is one of the most pervasive and yet least recognized human rights abuse in the world. It is universal and prevalent across many different cultures and countries. According to a WHO global survey, conducted in 2013, 35% of women worldwide have suffered physical and/or sexual abuse. Moreover, other studies have shown that up to 70% of women have experienced violence by an intimate partner during their lifetime.

Raising awareness of this reality is essential for health care providers, because the more this form of violence is recognized, the easier it will be to identify and address it.

GPs are among the first line of care contact with victims and their families. Despite this, training in recognizing and addressing domestic violence is not common in Primary Care training or undergraduate education.

Content/METHODS:

This workshop aims to give Family Doctors a set of tools that should render their daily practice when dealing with family violence victims.

The proposed activity will include:

- Presentation about key theory points on family violence;
- Group DISCUSSION:
 - o Propose different situations and give the opportunity to each group to develop options on how to manage each case by using role playing and case-scenario discussion.
- Report back and final discussion.

CONCLUSION: It is fundamental that Family Doctors should be provided with the necessary tools in order to recognize, treat and manage domestic violence with confidence. However, there is a real lack of education in this field jeopardizing the opportunity for GPs to play a key role in the fight against such a devastating epidemic, with multiple consequences for its victims. With this workshop, participants will gain a valuable insight into the approach to family violence, thereby allowing them to be more prepared to deal with it, particularly through early detection.

Keywords: Gender Violence, Family, Gender Equity, Vasco de Gama Movement

WS-035

Intimate partner violence: picking up signals and responding in daily practice

Sylvie Lo Fo Wong, [Toine Lagro Janssen](#)

Department of Primary & Community Care, Gender & Women's Health

Justification

Intimate Partner Violence (IPV) is: violence caused by a partner in an intimate relationship. IPV is worldwide a prevalent problem and it is one of the most important causes of disability and disease in women both in the short and long term. Mostly women are victimised. Physical injuries are thought to be the classic presentation of abuse, however mental health consequences are far more common. Family doctors hardly identify abused although a full-time working FD encounters at least 1-2 women weekly with a background of IPV. The aim of this workshop is to educate family doctors on how to recognise and respond to abused female patients in a day-to-day doctor-patient encounter.

Content

This workshop presents a short overview of the epidemiology, consequences of IPV on mental and physical health. The focus lies on how to recognise and respond to abused women in family practice in a day-to-day encounter. With film fragments (English subtitled) of a consultation in family practice participants are invited to discuss their observations according to assignments in subgroups that will be interspersed by plenary discussion and clarification. The film is produced especially for education purposes. The premise is the ordinary doctor-patient encounter when help-seeking behaviour, clinical presentation and a patient's history are of great value in confirming a suspect of IPV together with how to ask and respond. Active contribution will be asked of the participants.

Keywords: intimate partner violence, female patients, doctor-patient encounter

WS-036

WWPWFM - Practical skills workshop for GPs in responding to family violence

[Amanda Barnard](#)¹, Jan Coles²

¹Medical School, Australian National University, Canberra Australia

²Medical School, Monash University, Melbourne Australia

WWPWFM workshop – Practical skills workshop on training GPs in responding to family violence

Justification: With growing recognition of the role that GPs play in identifying and responding to family violence and intimate partner abuse, this workshop is a practical training session to equip GPs with knowledge skills and confidence to ask about abuse and respond appropriately to disclosure

Content: The workshop is based on GPs needs identified through WWPWFM workshops at Wonca meetings over the last 2 years, the RACGP Abuse and violence -Working with our patients in general practice (4th edition) clinical guidelines, and training material developed by Professor Jan Coles and colleagues
Workshop. format – 3 hours

The workshop will focus on 3 areas of skills train and development, It will consist of a brief overview of the topics, discussion of skills and strategies, and then the opportunity for participants to practice new skills in a safe and supported environment. This will include case studies and role playing opportunities. The areas covered are

- Identification and initial response and validation- how to identify, ask about and respond to initial disclosure of intimate partner abuse
- How to assess risk and assist women to reflect on their own safety and their children's safety.
- Ongoing management and counselling strategies. – Whilst recognizing that optimum management involves a multidisciplinary approach, there are effective counselling strategies that GPs can use to assist survivors of abuse.

The workshop will conclude with a plenary discussion and tips on GP self care when working with survivors of abuse

Keywords: skills training; family violence; intimate partner abuse

WS-037

Domestic Violence Workshop: What we think? What we do?

Nilgün Özçakar¹, Akça Toprak Ergöner², Özden Gökdemir¹, Gözde Yeşiltepe², Seval Yaprak¹, Melike Çağaydın¹, Ülkü Bulut³, Gamze Akyol¹, Mine Tevrizoğlu¹

¹Department of Family Medicine, Dokuz Eylül University Medical Faculty, Izmir, Turkey

²Department of Forensic Medicine, Dokuz Eylül University Medical Faculty, Izmir, Turkey

³Narlıdere Public Health Center, Izmir, Turkey

Background

Violence can be seen in every aspect of human life, is important and growing public health problem in the world. Violence is reported as mostly seen in the family atmosphere and against women (WHO). Violence against women is a phenomenon extremely common in the world, regardless of culture, economic development and education level. According to the "Survey of Violence against Women in Turkey"; exposure to family violence in any period of life is high. Although violence against women, children and elder is common all over the world, reflected in a small number of forensic medicine. In many cases of domestic violence in communities having great risk of exposure, socially it is considered normal. Domestic violence often not reported for reasons such as lack of awareness, security, shame and fear.

Wounded individuals physically and psychologically, referral to health organizations and judicial authorities in time is important for people health as well as detection of medical evidence. Domestic violence, as it directly affects woman suffering violence, children growing up in violent environments negatively affected by physical and mental aspects. This situation defines vicious cycle of violence; domestic emphasizes the importance of combating violence.

Method

Discussions will be carried out by forming working groups.

Workshop Program Topics

- Convention on preventing and combating violence against women and domestic violence (Istanbul Convention)
- Family Protection Law No. 6284 on the Prevention of Violence against Women
- Workshop (Case studies - legal and social aspects of the evaluation)
- Available coordination and cooperation related to violence against women cases and problems
- Solutions to improve the possibilities of coordination and cooperation and functionalized
- Conclusion and Evaluation

We believe that with this workshop producing solutions which contribute to the production by demonstrated the problems and experience.

The results will be presented as a declaration.

Keywords: Domestic Violence, Family Medicine, Forensic Medicine

WS-038

Gender-based Violence against Women and Approach in Primary Care

Filiz Ak, Zehra Dağlı

Department of Family Medicine, Ankara University School of Medicine, Ankara, Turkey

Violence which is a major public health issue affects most women and girls as a result of the patriarchal system which leads to the gender inequality. The first approach to victims of violence and sexual violence is important not only for the field of forensic medicine but also of primary care as well. Women who are the victims of violence and sexual violence have many lifelong acute and chronic health problems. Primary care physicians should give a woman centered care to the women who are the victims of intimate partner violence and sexual violence. The updated resources on this subject have been published by the World Health Organization by the end of 2014.

Gender, adopted by the World Health Organization (WHO) as one of the determiners of health, develops postpartum by means of the existing social values and stereotypes of the society surrounding the individual. Gender inequality and sexism negatively affect the health of women and lead to many additional health risks. Violence against women as a result of gender inequality and sexism is one of the main issues that need to take place in medical education and family medicine residency training program.

This conference aims to review the principle concepts about violence and gender inequality, data from World and Turkey, the health problems as the result of violence, Turkey's problem of violence against women, the responsibilities of Turkey and state parties obliged by Istanbul Convention, GREVIO process and basic approaches and practices that primary care physicians must develop according to the guidelines of WHO.

Keywords: gender inequality, violence, intimate partner violence, sexual violence

WS-039

European Forum for Primary Care (EFPC) Workshop on Interprofessional Collaboration (IpC): Communication and Language

Diederik Aarendonk, Kathryn Hoffmann, Jan De Maeseneer, Mehmet Akman

European Forum for Primary Care

OBJECTIVE: a common understanding about the role of Communication and Language within Interprofessional Collaboration of the involved stakeholders.

Specific objectives

- The identification of factors that hinder and/or facilitate the development of shared language between health professionals working in primary care as part of the item-list after 3 months
- Sharing knowledge on the way Interprofessional Collaboration is developed within different health care systems in Europe and how language/terminology barriers can be overcome
- Stimulate the discussions between professional associations on what they can do to improve communication among themselves at practice level as well as at policy making level
- Increase the awareness about art and theatre, being a good way to improve communication and the use of language, for all stakeholders in the development of- and practicing in- primary care.
- Assess the impact of international comparison challenges in relation to selected primary care professions and their implications for further research and data interpretation.

Format

The Forum will use deliberately other formats like role-plays and theater to create more impact and engagement within the target groups.

Keywords: Primary Care; Interprofessional Collaboration; Communication; Language; Health Systems Research and Terminology; Humanities

WS-040

EURIPA workshop: What options for developing integrated care in rural family practice in Europe: what building blocks need to be in place?

Zalika Klemenc-Ketis¹, Carolyn Wallace², Oleg V. Kravtchenko³, Donata Kurpas⁴, Christos Lionis⁵

¹Department of Family Medicine, Medical School, University of Maribor, Taborska 8, 2000 Maribor, Slovenia

²Faculty of Life Sciences and Education, Pontypridd, University of South Wales, Wales

³University of Tromsø, Fredensborgklinikken, P.B. 994, 8001 BODOE, Norway

⁴Department of Family Medicine, Wrocław Medical University, 1 Syrokomli St., 51-141 Wrocław, Poland

⁵Clinic of Social and Family Medicine, School of Medicine, University of Crete, Greece

Justification

Integrated care has recently become a very popular term in health policies. The UK RCGP defined it as “patient-centred, primary care led, delivered by multi-professional teams, where each profession retains their professional autonomy but works across professional and organizational boundaries to deliver the best possible health outcomes”. This definition is horizontal. However, other definitions are vertical, from primary to acute service levels which could lead to the misunderstanding of integrated care itself, as was presented recently by Amanda Howe.

Integrated care in rural family medicine settings deserves more attention and discussion and with this workshop, we aim to share news and ideas on developing of integrated rural care model in family practice in Europe.

Content

A workshop will consist of two parts. In the first part, short plenary presentations about the experiences of integrated care and patient-centred care in rural family practice from different countries will be given. Then, the participants will be divided into several groups to discuss about what are the elements of integrated care in rural family practice and to propose the elements of the integrated rural care model. During the workshop, a nominal group technique will be used.

We expect that during the workshop, many good ideas for integrated rural care will be presented as well as threats and challenges across European health care systems will be indicated by moderators and participants. These would serve as a good basis for the development of the integrated rural care model in the European rural family medicine.

Keywords: rural family medicine, integrated care, management

WS-041

EURIPA Workshop: Modernising our Rural Practice: from old patterns towards the future

Oleg V Kravtchenko¹, Tanja Pekez Pavlisko², Ferdinando Petrazzuoli³, Jean Pierre Jacquet⁴

¹EURIPA Norway

²EURIPA President Iterim, Wonca Working Party on Rural Practice – Vice-Chair. Croatia

³SNAMID Caserta Italy, Dept. of Clinical Sciences in Malmoe, Centre for Primary Health Care Research

⁴Dept. of General Medicine, Med. Faculty, University of Grenoble, France

In the modern and fast developing world, affected by society stratification, global migration, social insecurities and austerity measures, threatened by local and regional conflicts, it is crucial to create and maintain highly professional and fast-adjusting healthcare, available for all groups of population. This task is especially important for the rural areas as these are going to be affected first and hardest due to their relatively vulnerable economic and demographic situation. At this EURIPA (European Remote and Isolated Practitioners Association) workshop the authors are going to define the most crucial challenges and steps in developing such a healthcare, comparing different existing models cross-country and cross-continent, based on theory and practice. During the interactive groupwork the participants are going to define 3 tasks of the effective healthcare system and 5 variables in creating and maintaining such a system in rural location(s). In the end the authors and the participants are going to produce a consensus paper on the subject, which could be used as a reference in the future.

Keywords: healthcare, rural practice, modernising, effective

WS-042

What do 'people-centred' and 'integrated' health services look like? A Project by the World Health Organization, World Organization of Family Doctors and International Alliance of Patients' Organizations

Maria Luisa M Pettigrew¹, Amanda Howe², Michael Kidd², Dheepa Rajan⁴, Shannon Barkley⁵, Nittita Prasopa Plaizier³, Hernan Montenegro³, Alison Lightbourne⁶

¹Department of Health Services Research and Policy, London School of Hygiene and Tropical Medicine, UK

²World Organization of Family Doctors

³Department of Service Delivery and Safety, Health Systems and Innovation, World Health Organisation, Geneva, Switzerland

⁴Department of Health Systems Governance and Financing, Health Systems and Innovation, World Health Organisation, Geneva, Switzerland

⁵Department of Family and Community Medicine, Baylor College of Medicine, Houston, USA

⁶International Alliance of Patients' Organizations

Universal health coverage (UHC) requires that individuals have access to necessary, effective health services across the full spectrum of service provision and the life course. In recognition of the difficulty providing such services and in response to demand for services which are oriented around the health needs of individuals and communities the World Health Organization (WHO) is developing a strategy on People-Centred and Integrated Health Services.

This workshop aims to discuss participants' understanding of 'people-centredness' and 'integration' and explore potential strategies increase these. Ideas generated in this discussion will build on qualitative analysis of previous responses to a global survey of primary care providers and patients in order to inform the implementation of the WHO strategy. Interim strategy reports on the evidence base around people-centredness and integration of health services will be presented.

The workshop will take the form of a focus group discussion and informed consent will be sought from participants.

Keywords: People-centred, integration, primary care, health services, policy, WHO

WS-043

Medical Leadership - a Competency for GPs

Sietse Wieringa, Renee Weersma

Platform Medical Leadership

Medical Leadership involves the competency and the will to trigger change by influencing others, society and yourself to improve healthcare. Recently it is gaining recognition as a key feature of a new generation of GPs in order to tackle challenges and innovate general practice. In this workshop we will explore your medical leadership skills, your ideas for the future of general practice and provide some tools to start changing healthcare today.

This workshop is organised by PML in cooperation members of BOHAG and FMLM. PML (Platform Medical Leadership) is a Dutch cooperation of young GPs, young specialists, young public health doctors, young doctors in elderly care and the Royal Dutch Medical Association (KNMG). The BOHAG (Policy and Organisation GP Advisory Group) is the union of Dutch GPs with a special interest and training in leadership and management. FMLM (Faculty of Medical Leadership and Management) is the association of doctors with a special interest in medical leadership in the UK.

Keywords: Leadership, Management, Competencies

WS-044

Comparative Global Health Care Systems: Single-Payer and Multi-payer ways of achieving Universal Health Care: What Can Family Doctors Do?

Vincent T Leon¹, C. Ruth Wilson², Claudia Chaufan³

¹John A. Burns School of Medicine, University of Hawaii, Honolulu, USA

²Department of Family Medicine, Queen's University, Kingston Ontario Canada

³University of California San Francisco, USA

Justification:

"I regard universal health coverage as the single most powerful concept that public health has to offer. It is inclusive. It unifies services and delivers them in a comprehensive and integrated way, based on primary health care."

"A health system where primary care is the backbone and family doctors are the bedrock delivers the best health outcomes, at the lowest cost, and with the greatest user satisfaction" Dr. Margaret Chan, Director-General WHO
Family doctors have an important role to play, not just in delivering primary care, but in shaping health policy in their country and around the world, working towards systems which provide access to high quality health care for all, and a family physician for every family.

Content:

After a brief introduction to the status of health care systems around the world with regard to their status in providing universal health care, participants will divide into small groups. Each group will represent a country, and participants will work through common tasks of family physicians in that country, using resource material provided. This will allow for an appreciation of how universal health coverage is achieved in various health care systems, along with the advantages and disadvantages of various policy frameworks used at a national level. Participants will have the opportunity to learn about three systems in depth. The small group format will encourage interaction and relationship-building amongst participants. The conclusion of the workshop will include information and discussion about WONCA's current efforts to promote universal health care at WHO and nationally.

Keywords: universal health care; health policy; single payer systems

WS-045

WONCA Conflict and Catastrophe Special Interest Group

Rich Withnall¹, Tanja Pekez Pavliško², Hüseyin Avni Şahin³

¹Defence Professor of General Practice, Royal Centre for Defence Medicine, ICT Centre, Birmingham Research Park, Vincent Drive, Edgbaston, Birmingham, B15 2SQ, UK

²EURIPA President Iterim Wonca Working Party on Rural Practice

³Department of Family Medicine, Medical Faculty of Yuzuncu Yil University, Van, TURKEY

Justification.

WONCA's special interest groups (SIGs) comprise groups of individuals who share a common interest that is consistent with the Mission and Objectives of The Organization. The WONCA Executive has just approved the formation of a Conflict & Catastrophe SIG to specifically consider the impact of conflict or catastrophes upon health. The workshop proposer is the Convenor of the WONCA Conflict & Catastrophe SIG.

Content.

A brief presentation, then group discussions about the new Conflict & Catastrophe SIG considering the impact of conflict or catastrophes upon health, including:

1. Provision of useful in-country and regional contacts and networks of family medicine doctors.

2. Sharing of best practice and developments in conflict and catastrophe family medicine.
3. Discuss the management of medical services during conflict or post-catastrophe in areas that have big needs but are resource poor.
4. Encourage collegial discussions between countries.

Background & Aim.

Military actions, conflict and catastrophes may all adversely impact upon quality of life, universal human rights, gender equity and health inequality. The Inverse Care Law highlights how those in the greatest need often received the lowest, if any, standards of care. This SIG provides a forum through which WONCA can lend its support to improving the quality of care of peoples of the world when they face some of life's greatest challenges.

Method.

A soft launch of the WONCA Conflict & Catastrophe SIG.

Results.

The result of the discussions will be reported and published in the Journal of Turkish family Physicians.

Conclusions.

Introductory meeting of the WONCA Conflict & Catastrophe SIG.

Keywords: Humanitarian, Conflict, Catastrophe

WS-046

Rational prescription and use of medicines in Primary Care

Diederik Aarendonk¹, Anna Stavdal³, Nena Kopcevar Gucek², Isabelle Moulon⁴

¹EFPC (European Forum for Primary Care)

²UEMO

³WONCA

⁴EMA

OBJECTIVE: Increasing impact of Primary Care professionals on the European Medicine Agency (EMA) policy and decision making.

Specific objectives

- Clarify

- o what can GP's together with Pharmacists and other primary care providers contribute towards EMA in order to reach the best rational use of medicines?

- o What would be the best way of communicating between EMA and healthcare professionals to support their role in the safe and rational use of medicines?

- o What countervailing force Primary Care can be in the EMA decision making against the current input by specialists and pharma industry?

- o How to contribute to the Agency's scientific work intended to continuously improve benefit-risk assessment of medicines throughout their life-cycle?

- Stimulate the discussions between professional associations on what they can do to improve their impact towards EMA

- Increasing the number of European GP's involved in advising the EMA in order to include their specific knowledge on the prescription of drugs at Primary Care level

- Support the Agency to gain a better understanding of how medicines are being used in real clinical practice and how EU regulatory decisions impact clinical practice

Format

1. Introduction (10 minutes) Nena Kopcevar Gucek
2. Lecture (20 minutes) EMA representative

Questions and comments.

3. Lecture (10 minutes) Thierry Christiaens / Pieter van den Hombergh / Walter Marrocco / UEMO about the Evaluation System of Drugs and the added value for GP's to become involved

Questions and comments

4. Group discussion 15 minutes

Exchange of experiences.

5. Report from the group discussion (15 minutes)

6. Plenary discussion and final remarks. (15 minutes)

Keywords: Primary Care; European Medicine Agency; rational use of drugs

WS-047

Rural Proofing for Health Policy: Use of a Rural Lens - an update from the WONCA Working Party on Rural Practice

David Schmitz, Tanja Pekez Pavliško

University of Washington School of Medicine, Seattle, Washington, United States

Several countries have adopted "Rural Proofing" strategies to examine law, policy and regulation as related to rural health. The goal of these tools is to look with a "rural lens" to examine the potential for unique consequences on health and patients in rural areas. The impact of some decisions can too often have negative unintended consequences without such a process. During this interactive workshop, the currently published tools used in areas such as the United Kingdom and Southern Africa will be reviewed while the attendees will also have the opportunity to learn techniques and to develop skills to apply their own strategy for Rural Proofing. Case examples will be collected from WONCA Europe to contribute to this international effort. The WONCA Working Party on Rural Practice is developing a paper for use worldwide and this workshop is an opportunity to contribute to a tool that will support Family Physicians addressing policy issues resulting in better health for rural patients.

References:

1. Institute for Health. Rural Proofing for Health Toolkit, <http://www.ruralproofingforhealth.org.uk>, Accessed April 2015.
2. Rural Health Advocacy Project (2015). Rural-Proofing for Health: Guidelines – A guide to Accounting for Rural Contexts in Health Policy, Strategic Planning and Resourcing. <http://www.health-e.org.za/wp-content/uploads/2015/02/2015-01-13-RHAP-Rural-Proofing-Guideline-A4-Email-1.pdf>, Accessed April 2015.

Keywords: policy, rural, rural proofing, tool development

WS-048

Factors influencing the career decisions of young female general practitioners. Is there variation within European settings?

Dudley James Graham¹, Amanda Barnard²

¹Royal Centre for Defence Medicine, Birmingham, UK

²Australian National University, ANU Medical School, Acton, Australia

Justification

Within many settings, the demographic profile of the General Practitioner workforce is changing. A significant change has been the balance of male to female GPs. This long recognised trend looks set to continue. In parallel to a changing workforce composition, a number of more general attitudinal changes linked to career planning and expectations amongst the younger workforce are emerging. These have significant implications for future General Practice workforce planning. Whilst current research has concentrated on factors that affect workforce planning in single nation settings, no research has been published to date that explores qualitative comparators between countries.

Content

The aim of this workshop will be to explore an understanding of factors that influence the career decisions of young female general practitioners from different national settings, capture participant narratives and draw together the dataset for analysis, reporting and potential publication.

Activity: A brief presentation will introduce the recent Masters level research that DG has conducted in a UK setting: What influences female military First5® GPs' career decisions? A qualitative exploration. Building on these findings and drawing reference from relevant national and international literature, a backdrop will be drawn to enable small group discussion towards exploration of the workshop question.

Participants will be invited to consider and develop topics in small groups. During a final plenary, groups will present their findings and a collective summation of themes will be drawn together.

No competing interests to declare. DG has undertaken research on the career decisions of young female military General Practitioners as part of a funded MSc. Although he is a member of the UK Defence Medical Services and paid from Ministry of Defence (UK) funds, he has not been directed in any way by the MOD in relation to this work.

Keywords: career decisions, female, general practitioner,

WS-049

Should A Physician Use Short Interview Techniques in Primary Care?

Pemra Unalan¹, Bilge Turgut¹, Selcuk Akturan², Cigdem Apaydin Kaya¹, Mehmet Akman¹

¹Department of Family Medicine, Marmara University, Istanbul, Turkey

²Department of Family Medicine, Tercan Community Hospital, Erzincan, Turkey

AIM: Primary care physicians need to use counseling approaches on their patients to help health risk behaviours and ambivalence to change. And it is hard to find a cultural sensitive language in official interview. Motivational interviewing is accepted as a tool to help either physicians or the patients in counselling. On the other hand time is an important obstacle to provide counseling in primary care. The aim of this workshop is to display short interviewing techniques as an alternative. To share experiences and refresh knowledge and skills about short interviewing techniques in primary care is the objective of this study.

METHOD: After an allocation about the participants' needs and experiences about short counseling techniques the objectives of the workshop program will be re-structured. This workshop is planned to enhance the experiential learning of the primary care health workers, depends on their needs, uses interactive education methods, presents current evidence about the efficiency of the short interviews in primary care. There will be three short tutor presentations; 1-"Can we make a favourable difference by short interviewing techniques?" 2-

"Background and essentials of motivational interviews" 3-"Types of short interviewing techniques in primary care". A role play will be shared to observe, to assess and to brief the opportunities and/or limitations of the interview. A handout that will help the participants to follow the short interviewing technique in practice will be delivered. The workshop will finalize with a feedback session both about the roleplay and the whole workshop program.

Keywords: short interview, motivational interview, primary care

WS-050

WONCA ICOH Statement and Pledge on Primary Health Care&Workers' Health: how to proceed? Introduction to a Workshop PHC&Workers' Health

Peter Buijs¹, Frank Van Dijk²

¹Dutch Research Institute TNO Work&Employment Department of Work&Health

²Coronel Institute of Occupational&Environmental Health Medical Faculty, Amsterdam University, Netherlands

During the last WONCA-Europe conference (Lisbon, 3-7-14), President Michael Kidd's keynote stated, that WONCA and ICOH (International Commission on Occupational Health) were looking at the health of workers and their families, especially in developing countries, saying that health and safety are threatened by poor working conditions. "We recognize that most health care and preventive services for workers and their families is provided in primary care settings by family doctors like you and me. So today WONCA and ICOH launch a joint statement on workers and their families, pledging to work with partner organizations (WHO, International Labor Organization) to address gaps in services, research and policies, for the health and safety of workers."

This Statement revitalizes the famous WHO 1978 Alma Ata Declaration, saying that PHC aims at "... bringing health care as close as possible to where people live and work." Yet, as the WONCA-ICOH Statement says: "...health and safety of people at work are too often addressed separately from their health outside of work."

For decades only 10-15% of the global workforce has (some) occupational health care, mostly in developed countries. The poorest, most in need, with the most precarious working conditions, have none. Meanwhile, workers are the backbone of all economies, so their health is very important for themselves and their families as well as for the country's prosperity and social provisions.

PHC covers 70-80 % of the world population, containing many workers far beyond reach of current occupational care: in informal economies, rural and migrant workers. However, many GPs seems to have a 'Blind Spot' for work-related health problems.

So the WONCA-ICOH Statement conclusion "...to better integrate occupational health in the primary care setting, to the benefit of all workers and their families." creates new opportunities to improve workers' health, to be discussed in our Workshop

Keywords: workers' health, delivering basic occupational health care, family doctors

WS-051

Wisdom and Wellbeing - A priority for tomorrow's doctor

Sabena Yasmin Jameel, Katharine King
Health Education England - West Midlands

Justification

What does it mean to be well? Perfect health or "the strength to be" ? This workshop will explore definitions of health in terms of flourishing and well-being. We will look at the predominant ethical frameworks which shape health provision and discuss some of the shortcomings and institutional failings. A neglected area in Medical Education is virtue ethics, which may enhance the way we approach medical education with the goal of attaining Aristotle's 'Eudaimonia' (flourishing). It encompasses the fact that life has a purpose, and the way to seek the good life is to strive for moral excellence. The challenge is to implement this in our societies of moral pluralism. We will then look at the concept of Practical Wisdom (Phronesis) as an intellectual virtue in clinical practice and discuss if it can be taught.

Content

Small groups will consider character attributes required to be a good doctor (ranking exercise), these results will be compared to previous studies and to other ideas within the room. We will then contemplate what exactly it means to be wise, considering our own role-models and mentors, their attributes and professional virtues. We will trial a few wisdom inventories and discuss their validity. Finally we conclude by debating whether a 'wisdom approach' to medical education would not only result in a more fulfilled workforce but also improve patient outcomes.

Keywords: Virtue Ethics, Bioethics, Well-being, Flourishing, Wisdom, Phronesis

WS-052

Working Together to Enhance Family Medicine Education: Tools from the Wonca Working Party on Education

Allyn Walsh¹, Val Wass⁶, Victor Ng³, Roar Maagaard⁴, Marcelo Demarzo², Sam Merriel⁵, William Watson⁷

¹Wonca Working Party on Education

²Department of Preventive Medicine - Federal University of Sao Paulo, Sao Paulo Brazil

³College of Family Physicians of Canada Toronto Canada

⁴University of Aarhus, Centre for Medical Education, Aarhus Denmark

⁵Centre for Academic Primary Care, School of Social & Community Medicine, University of Bristol, Bristol UK

⁶School of Medicine Keele University, Staffordshire UK

⁷Department of Family and Community Medicine, University of Toronto, Toronto Canada

Justification:

Wonca's Working Party on Education has a focus on developing useful tools to enhance family medicine education around the world. In 2012, a checklist of essential experiences for medical students in a family medicine placement was published. Wonca Global Standards for Postgraduate Family Medicine were approved 2013. Since then, these standards have been used to enhance family medicine training globally. More recently, standards in Continuing Professional Development are under development along with further recommendations for Basic Medical Education. The goal of this session will be to engage participants in further developing these tools and their use in our diverse educational and clinical contexts.

Content:

At the end of the workshop participants will have:

- Shared experience of Family Medicine Education and identified skills they bring to enhancing its development internationally
- Identified and shared specific challenges for developing and quality assuring international medical education programmes

- Shared experience of educating across the continuum of medical education (undergraduate, vocational/postgraduate training, CPD) and the lessons learnt
 - Identified the principles of quality assurance frameworks/ tools to address some of the challenges identified for enhancing medical education
 - Identified strategies for enhancing medical education in FM in their own countries,
- There will be a brief presentation on each of the Wonca-developed tools including their adaptation to local contexts. Participants will break into several groups for interactive discussions to discuss them, and provide suggestions for further development. Participants will share perspectives on how these tools could be used in their contexts as well as other strategies for success.

Keywords: Education, Undergraduate, Vocational, Postgraduate, CPD, Quality Assurance

WS-053

Communicating in Difficult Situations

Basem Roberto Saab, Nisrine Makarem
American University of Beirut, Beirut, Lebanon

Family physicians encounter in their daily practice difficult patients. The prevalence of having a difficult patient varies from 15-30%. This variation is attributed to more than one factor like physician, patient and environmental causes. Physicians who develop good communication skills are more likely to handle difficult patients better. In this workshop the facilitator will describe the C.O.N.E.S strategy that helps you in dealing with an angry patient. The format is variable. The workshop will start with an interactive power point presentation of 11 slides, followed by comments on a DVD clip, then a role play and will conclude with comments on another DVD clip. The whole session is expected to last one hour.

Competing interest: None

Keywords: Communication Skills, Difficult Patient, Angry Patient

WS-054

Multimorbidity in family practice – educational needs”

Ruth Kalda¹, Jáchym Bednář², Elena Frolova³, Francesco Carelli⁴

¹Department of Family Medicine, Tartu University, Estonia

²Department of General Practice, Charles University Prague

³The North-Western State Medical University named after I.I. Mechnikov, St-Petersburg, Russia

⁴Milano, Italy

Background.

A 2007 study from the UK showed that approximately 80% of patients aged 50 years and older in the primary care setting have multiple health problems. Despite the increasing numbers of patients with multimorbidity, the delivery of care is usually built around one single disease. Guidelines are derived from studies that often exclude patients with multimorbidities. The studies highlight difficulties of managing multimorbidity in family practice. The amount of educational literature about patients with multimorbidities is very limited. However, findings indicate that recognition of the significance of multimorbidity in family practice is growing. Clinicians need a management approach that considers the challenges particular to each individual, including patient preferences, goals and prognosis.

Aim of the workshop.

Identifying the most challenging areas of clinical practice in the case of patients with multimorbidity.

Methods of the workshop. The workshop will start with a small presentation about clarification of the terms and importance of multimorbidity in primary care setting. After this participants will be divided into small groups (5-6 people) to discuss on a case-vignette on a preestablished structured way. The groups are organised so that in each there are some younger and some more experienced FDs. These groups will be asked to identify the most problematic areas in working with patients with multiple diseases as well as components of good practice to overcome these problems.

Results and Conclusion. At the end of the workshop the participants are more aware about the complexity of the multimorbidity and know more about their personal learning needs related to this challenging topic.

Keywords: multimorbidity, vignettes, educational needs

WS-055

Learning needs for cultural competence in family medicine, so to develop a teaching curriculum in culturally responsive healthcare for medical education in Europe

Jachym Bednar¹, Ruth Kalda², Elena Frolova³, Francesco Carelli⁴

¹Department of General Practice, Charles University Prague, Czech Republic, EURACT

²Department of Family Medicine University of Tartu, Tartu, Estonia, EURACT

³St. Petersburg Medical Academy for postgraduate Study Department of Family Medicine, St. Petersburg, Russia, EURACT

⁴University of Milan, Milano, Italy, EURACT

BACKGROUND:

Cultural competence is a set of behaviors, attitudes, and policies that come together in a system and among professionals that enables the system or the professionals to work effectively in cross-cultural situations. It is an important skill because it reduces disparities in health services and increases detection of culture-specific diseases. Adoption of cultural competent behaviour is a lifelong continual process starting from sensitivity and awareness leading to knowledge and skillful practice. At the present time, in Europe, no universal professional training and curriculum in cultural competence exists. It is dealt with significant differences across the European

Union.

Aim of the workshop:

We let participants to be aware of what cultural competence is to think over and summarize in 1,5 hour workshop their learning needs in GP, so to work out a future model as teaching curriculum in culturally responsive healthcare.

Methods of the workshop: Participants will be split into three groups and each group will be asked to make up learning needs for one of three target groups they choose (group at BME, ST, CPD/CME level) describing besides the learning objective of the WS (according to adoption of cultural competence in level of awareness knowledge or skill - they choose the level too: also methods, tools, used materials and resources,). The groups will present the results to the others.

Results and CONCLUSION:

After the workshop participants are more aware of their learning needs and as well as colleagues' ones and through learning cultural competence they are more interested to be involved also in teaching and developing of the model of culturally responsive healthcare in their countries. Together with WONCA SIG - Migrant Care EURACT group would like to develop teaching curriculum in culturally responsive healthcare for medical education in Europe.

Keywords: education, cultural competence, culturally responsive healthcare

WS-056

Reviews - Are there different types?

Mary G Kearney¹, Mary M Hanratty²

¹Cochrane Collaboration, Cochrane Neuromuscular Disease Group, London, England

²Irish College General Practitioners, Dublin, Ireland

OBJECTIVES:

Before changing your practice in the light of a recently published review it is important to decide if the review is valid. i.e. Did the author just use his friends studies in the review? Is it an objective review? Every year, researchers and scientists publish more than three million new articles in scientific journals, It has been estimated you would need to read 20 articles every day just to stay on top of their field. These articles range from background information, expert opinion, case series, case controlled studies, cohort studies, randomised controlled trials, critically appraised topics to systematic reviews.

To explore different types of reviews

To critical appraise papers which are used in reviews

To look at the framework of Cochrane systematic reviews

MATERIALS - METHODS

Discussion with participants initially about how they keep up to date, what they do when faced with a difficult clinical problem, what journals they read.

CASE:

Two abstracts from different sources on the same topic will be given to participants. The European Heart Journal article on "Cardiovascular disease in women: a statement from the policy conference of the European Society of Cardiology" and the systematic Cochrane review on "Hormone therapy for preventing cardiovascular disease in post-menopausal women.

RESULTS:

Participants will be able to assess which review is most helpful to them. Did the review:

- 1) obtain all studies on the research question,
- 2) minimize bias,
- 3) pool the results of small studies in meta-analysis,

4) help resolve contradictory findings among different studies on the same question.

CONCLUSION:

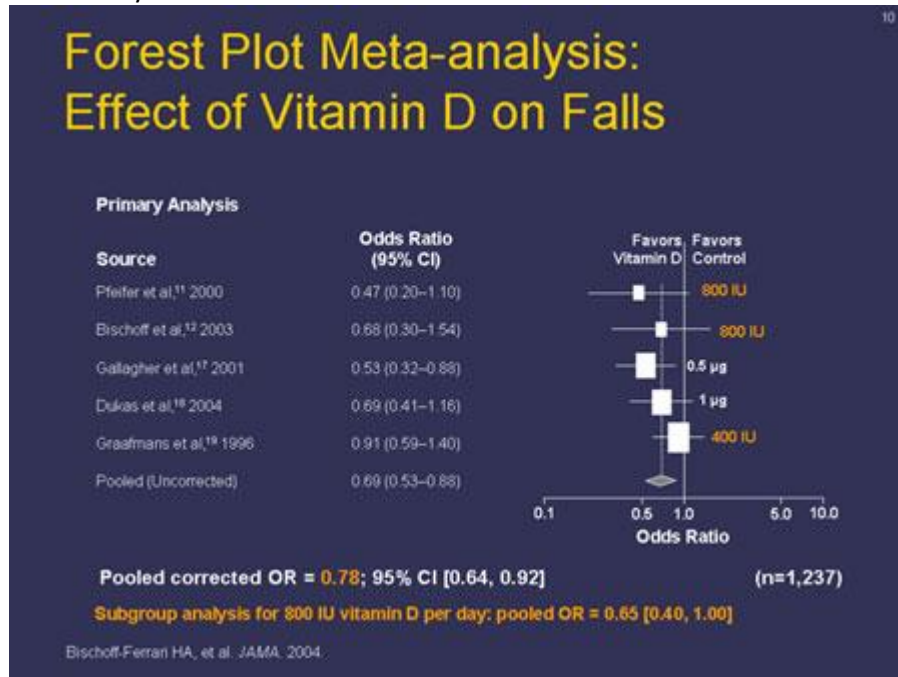
Obviously this will be decided on the day but I suspect that participants will find systematic reviews differ from narrative reviews as they use a very structured approach, explicitly formulated, reproducible, are constantly updated.

DISCUSSION:

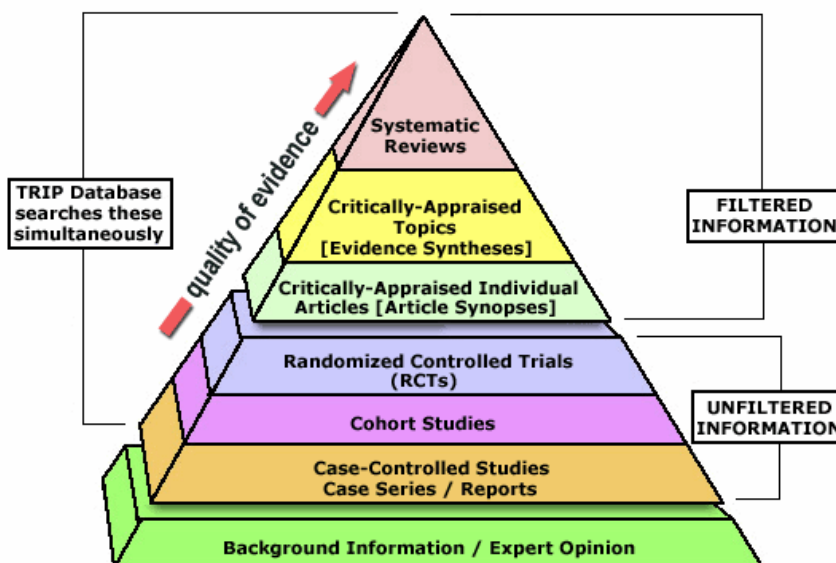
Will participants will be able to access Cochrane reviews freely.

Keywords: Review, Bias, meta-analysis

Meta-analysis



Pyramid



WS-057

Identifying expert family medicine teachers in Europe using work based appraisal – EURACT education workshop

Adam Windak¹, Justin Allen², Jo Buchanan², Roar Maagaard³, Ruth Kalda⁴, Manfred Maier⁵, Janko Kersnik², Tomasz Tomasik⁸, Igor Svab⁶, Katarzyna Dubas⁷, Niels Kjaer³, Violetta Kijowska⁸

¹Jagiellonian University Medical College, Poland

²European Academy of Teachers in General Practice and Family Medicine (EURACT)

³Danish College of General Practice

⁴University of Tartu

⁵Medical University of Vienna

⁶Institute for Development of Family Medicine, Slovenia

⁷ZiZ Education Centre, Poland

⁸College of Family Physicians in Poland

Justification

EURACT and its project partners have previously developed a framework for the continuing professional development of teachers in family medicine in Europe by promoting the acquisition of expertise in the teaching of family medicine. The Leonardo EU project provided specific training courses aimed at teachers from novice to expert. A new project is now looking to develop the instruments that could be used to appraise levels of teaching expertise in individual countries. This process will help to harmonise European teaching and improve family medicine programmes.

Learning goals

During the workshop participants will gain an understanding of:

- the appraisal of levels of expertise in general practice teachers
- the characteristics of competent and expert teachers
- the appraisal instruments that might be used to identify these
- how this process might impact on their own personal development as teachers

Session description

The workshop will start with a 5 minute presentation from the project director, introducing the workshop and briefly describing the work so far, followed by a 5 minute description of the types of evidence teachers might need to produce, This will be followed by a 5 minute question and answer session.

There will then be small group work. Groups will be formed randomly, each facilitated by a EURACT leader and each should appoint a rapporteur. Each group will have 30 minutes to discuss the types of evidence suggested for one domain at either competent or expert level. Discussion will be for thirty minutes. The workshop will end in plenary discussion, with targeted feedback from the rapporteur of each group, strictly limited to 3 bullet points in 3 minutes. Finally there will be a summing up by the Project Director

The workshop will last 75 minutes, and evaluation will be through a brief paper evaluation.

Keywords: Appraisal of GP teachers, EURACT, Framework for CPD of teachers

WS-058

Tips on Managing Students in your Rural Practice

Christos Lionis¹, Janko Kersnik², Zalika Klemenc Ketis³, Gunta Ticmane⁴, Lars Agreus⁵, Elizabeth Swensen⁶, Jose Manuel Lopez Abuin⁷

¹Clinic of Social and Family Medicine, School of Medicine, University of Crete, Greece

²Department of Family Medicine, Medical Faculty, Maribor and Ljubljana University, Slovenia

³Department of Family Medicine, Medical Faculty, University of Maribor, Slovenia

⁴Department of Family Medicine, Riga Stradins University, Latvia

⁵Department of Neurobiology, Care Sciences and Society, Karolinska Institutet, Sweden

⁶EURIPA Member, Norway

⁷EURIPA Chairman, Spain

Justification

Rural practice presents a valuable resource for teaching medical students key concepts of family medicine for practicing medicine in general, i.e. comprehensive, holistic and patient oriented medicine. By teaching one to one in rural practice settings, students can gain skills and attitudes needed for future doctors.

Content

The workshop entitled "Tips on Managing Students in your Rural Practice" with participants from at least five European countries, including Greece, Latvia, Norway, Slovenia and Sweden aims to present and discuss students' experiences across these distinct settings. It will focus on students' attitudes towards rural medicine and the exchange of different experiences in rural practice, through interactive discussions and small group exercises. Barriers for larger students' involvement in rural practice teaching will be identified. In addition, formative assessment tools and feedback methods will be presented. The role of clinical preceptors and tested students' programmes in rural practice will be discussed, while certain propositions will be summarized at the end of the workshop and future actions will be planned.

Keywords: rural practice, medical students, family medicine

WS-059

Balint Group Work-Reflective Practice in Action

David Watt, Ceri Dornan

Dr David Watt, President Balint Society UK, London-affiliated to International Balint Federation,

The workshop will consist of a Balint group, led by myself and a colleague, both very experienced, accredited International Balint group leaders. Depending on numbers, all the participants may be in the group, or some will participate in the group, and some observe the group.

Justification and interest

The relationship between GP/family doctor and patient is essential for the practice of holistic medicine. There is a need for a reflective space for health workers where they can think about and discuss these relationships, in a safe and confidential environment. The Balint group has provided such a space for more than 60 years. It can contribute to resilience in the practitioner which may help prevent burnout.

The workshop will be of interest to GPs/family doctors in primary care. Previous knowledge of Balint groups is not essential.

Participants at Wonca meetings may come from countries where there is little or no Balint work taking place and so we can provide an opportunity otherwise absent.

Learning goals

Participants will experience and understand a Balint approach.

Participants will have an increased understanding of some of the issues which may arise in doctor/patient relationships and how these can be thought about.

Participants will be encouraged to develop their reflective capacity.

Method

The workshop will be experiential, using the Balint model. Participants will be invited to participate in, or observe, a live Balint group. We will then encourage participants to examine the approach and reflect on the possible usefulness and limitations in their own work.

Expected impact on participants

The Balint approach is a powerful way of exploring relationships. Participants will become aware of the importance of considering both sides of a relationship, including the emotional impact, within the contained and safe framework of Balint work.

Keywords: reflective practice, group work, education, psychology, relationships, resilience

WS-060

Starting your Own Balint Group

David Watt, Ceri Dornan

Dr David Watt. President, Balint Society UK, London- affiliated to International Balint Federation

This workshop will compliment my other workshop-Balint Group-Reflective Practice in Action.

Its aim is, through presentation and group discussion, to help doctors to found new Balint groups, either in areas where there is already Balint activity, but more particularly, in countries where no Balint groups exist. Wonca meetings, as in the past, are a place where doctors from many countries get together, and may access the work of the International Balint Federation.

In the UK, I work with many doctors graduated in countries without Balint work, and it appears there is a real appetite for the discussion of the doctor/patient relationship in all medical communities-for instance a Chinese Balint society has been founded in the last 2 years!

Through discussion and information sharing, I hope to be able to help participants proceed from a desire to be in a Balint group, to a position where they feel able to start one in their own community, with international support if needed through the International Balint Federation. Founding a new group, particularly in an area where reflective practice may not be fully part of medical practice, is daunting and depends both on the enthusiasm of the participants, but also on gaining institutional recognition/support. We can also help participants to access all the theoretical knowledge and experience they may need.

The desired outcome is a spread in reflective practice internationally, through the use of Balint Groups.

Keywords: Balint, group work, education, reflective practice, international co-operation.

WS-061

Developing WONCA CPD Standards: Engaging the WONCA Europe perspective

Victor Ng¹, Allyn Walsh²

¹Division of Professional Development and Practice Support, College of Family Physicians of Canada

²McMaster University Department of Family Medicine

Justification

Wonca's Working Party on Education has a focus on developing useful tools to enhance family medicine education around the world. Since 2012, a checklist of essential experiences for medical students in a family medicine placement and the WONCA Global Standards for Postgraduate Family Medicine has been developed by the Working Party. Since then, ways to use these standards to enhance the family medicine training have been under discussion.

Currently, one main focus of the WONCA Working Party on Education is the development of a set of Global Standards for Continuing Professional Development (CPD) to offer guidance on learning after the completion of a postgraduate training program. CPD is crucial to any family physician/general practitioners' career as a means to maintain and enhance competency and to facilitate a culture and expectation of lifelong learning. A strong commitment to CPD is quickly becoming an expectation of family physicians in many jurisdictions by our stakeholders including patients and physician licensing bodies. WONCA standards may provide a useful advocacy tool to engage with such agencies.

Content:

A short presentation of a draft version of the WONCA Global CPD Standards will be delivered. Similar to the WONCA Global Standards for Postgraduate Family Medicine, these CPD standards are largely based on the framework developed by the World Federation for Medical Education. Participants will break into several groups for interactive discussions to discuss and share their perspectives on various aspects of the draft document. The discussions and ideas generated will help to ensure that the WONCA European perspective is recognized and incorporated into the WONCA Global CPD standards.

Keywords: Family Medicine, Education, Continuing professional development

WS-062

Enriching the clinical dialogue by the aid of a conversational response model

Carl Edvard Rudebeck¹, Maria Yngvesson², Helena Bäckström², Henrik Nelson², Bertil Isaksson², Viktor Skobe³

¹Dep. of community medicine, Tromsø university, Norway and Research Unit Kalmar county council, Sweden

²The Dep. of primary care, Kalmar county council, Sweden

³Slottfjärdens Health Centre, Kalmar, Sweden

Justification

Patient-centeredness provides a structure for the consultation that counteracts the non-reflected dominance of biomedicine in the doctor-patient interaction, but the method does not tell about the dialogue as such. The Kagan-Wretmark (1979) response model distinguishes four dimensions of conversational responses; listening/not listening, explorative/non explorative, affective/cognitive and frank/glossing over, and includes also a few concrete advices that helps the doctor stay open end receptive. Integrated into the clinical repertoire through training and supervision, the response model helps the doctor guide the conversation on to a level where it finds its own dynamics, involving both patient and doctor in spontaneous interaction. Here, the doctor's spontaneity is the realization of the involvement in the patient's predicament. The danger of spontaneity is its being taken over by the doctor's self-interest. The doctor needs an active self-awareness to prevent this from happening. Detachment is also necessary for the doctor to take responsibility and pursue the tasks of the consultation in a structured way. Involvement and detachment go together (McWhinney 2000)

The authors have developed and practiced a course concept aiming at GP trainees, where the response model is built in into a GP context. We want to share our experiences with European colleagues, also inviting to a broader

discussion about education initiatives in the area.

Content

1. Presentation of the response model mainly by illustrating it by video-recorded interaction – 15'
2. Practicing the response model over a non-sensitive theme in groups of three and discussing the experience within the group – 20'
3. General discussion about the response model – 15'
4. What do we as educators do, and what could we do, to help medical students, trainees, and GP specialists become really good at interacting with their patients – 10' in the groups and 15' in plenary

Keywords: quality of doctor-patient interaction, training model, the doctor's self-awareness

WS-063

Graphic Medicine a valuable method of reflection for patients, clinicians, teachers and trainees

Linda Miller¹, Niro Amin¹, Fleur Navey¹, Rowena O'Brien¹, Stephanie Drymiotou¹

¹Sands End Health Centre, London, UK

²Queenstown Road Medical Practice, London, UK

³The Randolph Surgery, London, UK

⁴St Mary's Hospital, Imperial College, London, UK

⁵St Georges Hospital, London, UK

Justification; Graphic novels by patients and doctors are becoming increasingly popular. Reflective practice is recognised as a necessity for professional development throughout medical careers and for improving patient safety. The workshop will examine how additional insights can be gained from examining patient graphic novels and how graphic methods can be used to reflect on consultations, ethical dilemmas and teaching creatively. Creativity helps relieve stress.

Content

The workshop will consist of a brief introduction about reflection and its importance for professional development. Clinical governance structures within the UK require doctors and nurses to demonstrate reflection for appraisal and revalidation. Not all clinicians find it easy to document their reflection in writing. Graphic methods offer an alternative.

Workshop participants will be invited to share their experiences of reflective practice; for example how often they use reflective practice, what cases they tend to reflect on.

A short introduction to graphic novels, their structure, methods used and what makes them different from other forms of narrative will follow. Examples from patients, doctors, students and teachers will be introduced to demonstrate features of graphic novels e.g. structure, colour, size and metaphor.

Participants will then have an opportunity, in small groups, to reflect on a recent significant clinical encounter, experience as a patient, student or teacher and experiment with documenting this in a graphic form.

Small group facilitation will be by a multidisciplinary team from various settings and career stages, faculty and trainees. Three facilitators are doing postgraduate study/research in the Medical Humanities with the University of London. All have used graphic methods to reflect on their work.

Further resources will be supplied so that participants can develop their graphic reflection methods and share with others in their workplace.

Participant feedback will be collected.

References

"The Bad Doctor" Ian Williams, "Moms Cancer" Brian Fine, "Cancer Vixen" Marisa Acocella Marchetto

Keywords: Ethics, Education, Patients, Reflection, Graphic Medicine, Medical Humanities

WS-064

Using the arts in general practice/family medicine education: experiences and way to go ahead?

Mehmet Akman¹, Mladenka Vrcić Keglević², Hrvoje Tiljak³, Pemra Cöbek Ünalın¹

¹department of family medicine, Marmara university school of medicine, Istanbul, Turkey

²Foundation for the Development of Family Medicine, Zagreb, Croatia

³department of family medicine, A. Stampar" School of Public Health, School of Medicine, Zagreb, Croatia

Justification and Aim

Arts-based medical education was implemented for more than two decades to enhance aspects of professionalism including empathy, altruism, compassion, and caring toward patients, as well as to hone clinical communication and observational skills. Looking at the literature resources, family medicine has always been involved because of its deep roots in the provision of the contextually rich and patient-centred care. The aims of this workshop are to address the questions "Do we need arts-based education for general practitioners (GP) and if we do, what is theoretical and conceptual framework and what pedagogical tools can be used?"

Content

A panel of experts will be the GP's educator already incorporating arts into their teaching modules. The personal examples of using visual arts, poetry, prose, drama and films in "hard-to-teach" clinical competencies such as compassion, altruism, and empathy will be presented. It will be followed by the small-groups discussions on; a) the ideas how and when to introduce arts in everyday GPs teaching, b) ideas for the development of international research in the arts and medicine, based on the expert presentations and participant's personal experiences.

Conclusions

The workshop will allow participants to become familiar with the theoretical rationale for introducing arts exposure into GP's education; to participate in international dialogue identifying overlapping interests; to identify opportunities for collaborative educational and research projects in evaluation of arts-based curricular innovations as well as other aspects of the interface between the arts and medicine.

Keywords: Art, postgraduate medical education, family medicine training

WS-065

Preparing trainees and their trainers for the GP care of the future: working with 'Entrustable Professional Activities' in GP training

Paul Van De Vijver, Kees Van Der Post, Marcel Reinders, Mirjam Nijvelt

Huisartsopleiding Nederland, Postbus 20072 3502 LB Utrecht, the Netherlands

In the Netherlands an updated National Curriculum is being developed that aims to guide both learning in daily practice and at the training institute. The training program for General Practice typically lasts 3 years and mainly consists of workplace learning, supervised by an experienced GP. One day a week trainees receive formal education from teachers at their training institutes.

The curriculum is built around seven 'key-competencies' (cf. CanMEDS) and, in addition, ten essential 'themes' in General Practice, which describe key domains of activities. Examples of themes are 'Care of the acutely ill patient', 'Care of the elderly patient', 'Care of the patient with psychological problems' and 'Preventive care'. Currently, for each of the ten themes 'entrustable professional activities' (EPAs) have been identified, using a Delphi-like procedure. As our curriculum aims at preparing GP trainees for 'GP care of the future', some of the EPAs involve activities which are not yet fully adopted into the 'average' General Practice. For the development of our profession, it is highly important that GP trainees and GPs work (and learn) together to incorporate these activities in their daily practice. GP training institutes should facilitate such collaborative learning.

Content

In this workshop, we will first give you an introduction into the value of working with EPAs. Next we'll provide you with an overview of our EPA's and let you identify EPAs that are relevant for your own daily practice and that are 'challenging activities' for both trainees and experienced GPs. Finally, we'll share ideas about just how the

collaborative learning of GP trainees and trainers can be stimulated and organized.

Keywords: education, GP training, EPA

WS-066

Movie Clips to Teach Medical Professionalism: from emotions to reflection and attitudes. A Faculty Development Workshop

Pablo Gonzalez Blasco¹, Olgun Goktas², Graziela Moreto¹, Rosana Irie¹

¹Sobramfa- Medical Education and Humanism, São Paulo, Brazil

², Uludağ University Family Health Center, Bursa, Turkey.

Emotions play a specific role in learning attitudes and behavior. Although technical knowledge and skills can be acquired through training, it is impossible to refine attitudes, acquire virtues, and incorporate values without reflection. Learning through aesthetics –art, literature, humanities- stimulates a reflective attitude in the learner. Cinema, as well, is capable of portraying a tremendous spectrum of attitudes required for building professionalism. Cinema is the audiovisual version of storytelling. Movies provide a narrative model framed in emotions and images that are also grounded in the everyday universe. They offer a quick and direct teaching scenario in which specific scenes point out important issues and emotions are presented in accessible ways.

Fostering reflection is the main goal in the cinematic teaching set. The purpose is not to show learners how to incorporate a particular attitude, but rather to promote their reflection. Reflection is the necessary bridge to move from emotions to behavior. As the audiovisual resources are permeating our current culture, opportunities for teaching with cinema are well suited to the learners' environment. Those "intangibles" issues difficult to teach and comprehended in professionalism could be endorsed through the cinema education methodology. The authors have developed the Movie Clip Methodology for more than fifteen years and want to share their experience. The learning goals are to understand the systematic strategy for preparing movie clips for teaching and how to use it for helping students to learn reflective practice. We expect an interactive discussion with the audience and a pleasant scenario to better understand how movies help in promoting professionalism.

Contents and Methods

1. Introducing presenters and asking the audience about their own experience in using cinematic teaching (20')
2. Showing movie clips. (20')
3. Getting feedback from the audience. (20')
4. Showing additional clips and generate themes identified by participants (20')
5. Summarizing: (10')

Keywords: Cinema, Professionalism, Reflective Practice, Medical Humanities, Faculty Development, Medical Education.

WS-067

Theatre of the Oppressed Workshop

Austin O Carroll, Patrick O Donnell
North Dublin City GP Training Programme

JUSTIFICATION: August Boal created Theatre of the Oppressed. He defined a power dynamic based on monologue rather than dialogue; a relation of domination and command that prohibits the oppressed from being who they are and from exercising their basic human rights. One of the ethical duties for doctors is to advocate on behalf of their patients. This duty is founded in the reality that many patients are in a disempowered position in relation to medical and social institutions and doctors who are in a more empowered position can advocate on their behalf. The dynamics of power and disempowerment due to oppression are complex, potent, ubiquitous and yet often submerged from our consciousness. On the North Dublin City GP Training Programme (which trains doctors to work in areas of deprivation and with marginalised groups) we use Theatre of the Oppressed to explore the concept of oppression and how to stand up to oppression/advocate on behalf of those who are disempowered.

CONTENT: The workshop will initially start with a number of movement; sound and interactive theatre exercises to help participants engage with theatre physically. Then participants will be split into groups asked to share stories of oppression that they have encountered as doctors or patients, or which they have observed occur for their patients. Each group will pick one story to dramatise. They will be helped develop the drama which will be then shown to the audience. Theatrical techniques will be used to engage the audience into participating and exploring the nature of oppression displayed in the story and how to counter that oppression. The workshop will finish with a short discussion about oppression.

Keywords: Ethics/Medical/Education

WS-068

Workshop on Addressing the Inverse Care Law: Innovative teaching on working in areas of deprivation and with marginalised groups

Austin O Carroll¹, Patrick O Donnell², Fiona O Reilly¹, Suzanne Barror¹, Cathy Cullen¹, John Latham¹, Louise Malone¹, Anne Macfarlane², Neasa McDonagh¹, Ming Rawat¹

¹North Dublin City GP Training Programme

²Partnership for Health Equity

JUSTIFICATION: It is known that people from lower socio-economic groups have shorter life expectancies and higher burdens of multi-morbidity. Yet the ratio of GP's to patients in areas of deprivation in Ireland is 1:2500, versus 1:1600 nationally. This confirms the Inverse Care Law as described by Tudor Hart. It is also known that marginalised groups have the worst health indices of all, and often have difficulty accessing primary care. This presentation describes two linked educational initiatives: an undergraduate teaching programme seeking to create awareness of these health inequities and the new North Dublin City GP Training Programme designed specifically to train GPs to work in areas of deprivation and with marginalised groups.

CONTENT: The design of an undergraduate module for teaching medical students about health inequities and working with marginalised groups will be described. Interactive cases and clinical dilemmas form the basis of this work. We will then speak about the GP training programme and its unique curriculum that includes (i) a focus on social medicine throughout (ii) using Mindfulness Based Stress Reduction and Balint groups to avoid burnout (iii) advocacy and professionalism training (iv) working on Special Interest posts in prisons, homeless, migrant and drug treatment services. The scheme champions the contact hypothesis, an educational theory proposing that stereotypes can be shattered by meeting people from marginalised groups. The first cohort of trainees on this scheme graduated in 2014. Videos of trainee feedback on the special interest posts will be shown. Results of written feedback from these registrars will also be presented. This programme had a direct impact on the GP trainees, but also on training across Ireland. The Irish College of General Practitioners requested that a Social

Medicine module for the national curriculum be created by this training scheme. We feel the models described could be replicated elsewhere.

Keywords: primary care, education, socioeconomic factors, accessibility of health services,

WS-069

Developing a Scientific Network for Young General Practitioners: Opportunities and Obstacles – the Danish experience

Ulrik Bak Kirk, Mads Dannesbo, Christina Svanholm, Gazelle Maghsoudi, Karolina Lewandowska

Forum for Young General Practitioners (FYAM), Denmark

Background

Since 2012, the Forum for Young General Practitioners (FYAM) in Denmark has conducted member-oriented campaigns with the aim to stimulate commitment and activity amongst its members. The main goal of the campaign in 2012 was daily supervision.

In 2013, FYAM introduced its research campaign with an intention to strengthen the knowledge of and interest in Primary Care Research.

In 2014, FYAM launched its quality campaign introducing quality circles (QCs), small groups of 6 to 12 GPs and GP trainees who meet at regular intervals to consider their standard practice.

The aim of this workshop is to share the Danish experiences about developing a Scientific Network for Young General Practitioner, including the use of concept campaigns to attract and involve members, to motivate other GP trainees to either organize their own national network or how to enhance commitment and activity in existing ones.

Outline

Firstly, FYAM will briefly run through its organizational features and the three concept campaigns mentioned above.

Secondly, FYAM will break the participants into groups and have them contemplating on actual opportunities and obstacles for developing a national scientific network for Young GPs, how to design the perfect campaign and sharing best practices about involvement of members nationally.

Thirdly, FYAM will ask the participants to dot evaluate the shape of the scientific network for Young General Practitioners in their respective countries.

This will be a nice mix of short presentations about the Danish experience together with a lot of interaction in groups about how to attract and involve GP trainees (in organizational work) across Europe.

Collaborating Groups and Length of Workshop

This workshop is done in collaboration with the Beyond Europe as well as the Quality Group within the Vasco da Gama Movement.

Keywords: Network, Young General Practitioners, Opportunities, Obstacles, Member-oriented campaigns

WS-070

Providence for a pilot program: A new class for medical students named 'Being Young, Staying Young'

Yesim Uncu¹, Züleyha Alper², Zehra Dağlı³, Canan Tuz⁴, Pınar Topsever⁵

¹Department of Family Medicine, Uludag University, Bursa, Turkey

²Department of Medical Education, Uludag University, Bursa, Turkey

³Department of Family Medicine, Ankara University, Ankara, Turkey

⁴Department of Family Medicine, Başkent University, Ankara; Turkey

⁵Department of Family Medicine, Acıbadem University, Istanbul, Turkey

Justification

Healthy lifestyle is a cornerstone of non-communicable disease prevention. In order to get older in a healthy way, youth should get the knowledge of staying healthy and it is known that lifestyle habits can be transferred into professional practice. Understanding the importance of healthy lifestyles as well as the adoption of active sports habits is especially important for students of Medical Schools, who will be knowledgeable managers of the future and architects of health. Not only is important for medical students to understand the skills of healthy life styles, also it is essential to bring up them as a role-model for the society in terms of their own lifestyles.

Various studies have shown the efficiency of a well-defined and structured education of lifestyle medicine. For this reason, we thought that preparing a healthy lifestyle module for medical schools is good point to start.

Aim of the workshop:

- We want to exchange different experiences on physical activity and healthy lifestyle habits of medical students between participants.
- We expect to found a working group to develop a program for healthy lifestyle for a medical school curriculum among the audience.

Content

The workshop will start with a small presentation of the literature about medical students and healthy life style. After summarizing the method of the workshop, feedback will be accepted for the format. The group will be divided in 4 small groups. Each group will work on a different topic (see below). In the last part all groups will make a presentation and all groups will work on a draft healthy lifestyle module in order to be used as a pilot program at medical schools.

TOPICS

1. Defining the goal of integrating the lifestyle module and the main topics
2. Determining stakeholders and infrastructure
3. Debate on students participation

Keywords: healthy life style, medical education, physical activity

WS-071

How to remain patient-centered while using Electronic Health Records (EHR)

Cédric Lanier, Melissa Dominicé Dao, Noëlle Junod Perron

Division of primary care, Geneva University Hospitals, Geneva, Switzerland

Justification:

Electronic health records (EHR) are now widely used in outpatient medical settings.

The EHR has shown to improve decision support and implementation of Evidence Based-Medicine, to improve the sharing of medical information and to reduce medical errors. The patients seem to readily accept the EHR even if there are few concerns about confidentiality.

However, some authors have shown a negative impact on the doctor–patient interaction. For example, EHR:

- Increases the moments of silence
- Decreases the doctor-patient interaction
- Decreases the interest for psychosocial problems of the patients

The doctors also experience difficulty remaining patient-centered while using the computer during the clinical encounter.

Content:

The goals of this workshop are to:

- 1) Understand that EHR changes the doctor-patient interaction.
- 2) Share the difficulties related with the use of EHR and review expert recommendations
- 3) Practice skills to help remaining patient centered while using EHR

This workshop will begin with a global discussion which will allow participants to report their experiences and difficulties related to the use of EHR.

Then, participants will observe and comment short videos of different styles of use of EHR in the clinical encounter Based on participants' observations, organizers will describe the experts' recommendations on how to use EHR in a patient-centered way.

Breaking into small groups for a role play, participants will practice segments of a general practice encounter with a computer, trying to integrate the discussed recommendations.

Groups will join again to share their experiences and comments regarding the role play.

Keywords: Electronic Health Records (EHR), patient-centered, communication skills

WS-072

Professional Identity Formation in medical education: implications for teachers

Pieter Barnhoorn, Chris Walinga

Leiden University Medical Center, department of Public Health and Primary Care, Leiden, the Netherlands

Justification:

Recently the new concept of 'Professional Identity Formation' has been added to the professionalism discourse. The concept of Professional Identity Formation complements the concepts of professionalism and professional behaviour by incorporating transformative aspects in education. Doctors not only need to behave professionally (focus on professional behaviour) or have the right character traits (focus on professionalism), they need to become professionals (focus on Professional Identity Formation. This new perspective may have important implications for medical education. This workshop will explore both the essential differences between the concept of Professional Identity Formation and the concepts of professionalism and professional behaviour and what are the implications for learning and educational design.

Content:

First we will discuss our experiences with professionalism and professional behaviour in small subgroups. The most important aim of the discussion is that participants become aware of which place these concepts have in our medical education practice. Then we will present a brief overview of the theory of Professional Identity Formation and how it complements the concepts of professionalism and professional behaviour. Hereafter we will discuss the implications of this new concept for learning and educational design. We will round up with a discussion and formulate ideas and practical plans how we can embed these plans in our daily practice.

Keywords: professional identity formation; professionalism; professional behaviour; medical education

WS-073

Experience based learning during the family medicine clerkship: Are you experienced?

Chris W. Walinga, Pieter C. Barnhoorn, Marieke H. de Jong

Department of Public Health and Primary Care, Leiden University Medical Center, Leiden, The Netherlands

Justification:

Burnout has a high prevalence among interns and can lead to illness, non-attendance or even quitting medical school. Factors associated with burnout are high workload, feelings of failure, impressive patient cases and exposure to unprofessional behaviour. Burnout itself again can give rise to unprofessional behaviour.

Experience based learning is a method that can facilitate discussing experiences among interns during clerkships that may lead to burnout and helps them to reflect on, analyse and learn from these experiences.

The method of experience based learning is challenging for both student and teacher. Students are often not familiar with concepts of active listening and easily step into common pitfalls. Teachers need skills to oversee and facilitate the process, encouraging students to be active listeners.

Introduction of experience based learning during clerkships supports discussion of professional behaviour and may prevent burnout and provide tools for future career.

Content:

First participants will discuss their own experiences in small subgroups to form ideas on how learning from practice is implemented in different medical schools throughout Europe.

Subsequently the principles of experience based learning and the learning goals we have formulated for our family medicine clerkship will be presented concisely. Also a short video recorded at our department will be presented followed by the outcomes of an evaluation survey held under our interns.

Finally, again in subgroups, participants will have the opportunity to practice skills needed in the role of teacher or intern. A real case, based on the experience of one of our interns, will be subject of discussion.

Keywords: experience based learning; medical education; professional behaviour; professional burnout;

WS-074

Genetics on Primary Care

Sara Almeida Magalhães, Susana Reis Gonçalves, Sónia Lima Costa

Department of USF Ponte, Guimarães, Portugal

Justification and interest of the workshop:

According to some studies Primary health care providers (PCPs) are uncertain about Genetic knowledge not only because of lack of confidence but also because of absence of guidelines to screen for genetic risks.

Besides the rising demand for genetic health care, education and training in basic genetics is still very low. PCPs require training for the refinement of specific skills such as family history-taking and use of referral guidelines.

Undoubtedly, family history represents a strong risk factor in many diseases and PCP's are the most well positioned doctor to provide it, however it is important to know what types of family clues on family history-taking are needed to chase.

Do you know that 10% 1 of consultations have genetic aspect? Mostly multifactorial disease like cancer and cardiovascular disease have genetic component. How important is the reproductive hemoglobin disorder? A referral to a genetic service can cause undue stress and anxiety for the patient and his/her family. So it is essential to know what cases really worth this submission. Management of low- and moderate-risk patients and support of families with/ at risk of genetic conditions are duties of primary care setting. The Primary Health Care is the gateway to the health-care system, so family physicians should provide more information about Genetics.

Methods Practical workshop through images of some syndromic characteristic and genetic clues of family history on Primary Health Care.

Expected impact on the participants Participants will learn basic knowledge about genetic clues to referral for Genetic Services and interpret some pictures as syndromic. Providing self-confidence and sensitizing on genetic fields in order to change their clinical attitude at primary care.

1 Acheson et al, Clinical genetics issues encountered by family physicians, September 2005, Vol. 7, No. 7

Keywords: Genetic, counselling, Primary Health Care

WS-075

the family's syndrome with psychodrama and sociodrama techniques

Hadiye Küçükkaragöz¹, Tolga Nasuh Aran²

¹Deü Education Institute Family Counseling And Education Department

²Meb Counselor

According to the family's syndrome theory some diseases, accidents and deaths are caused by the intergenerational transfer of some issues unresolved.

our grandparents's life can directly affect us decades later. We are links in a chain of generations, unconsciously affected by their suffering or unfinished business until we acknowledge the past. Schutzenberger says the name the Ancestors Syndrome.

Unresolved trauma has afflicted a family through an event such as murder, suicide, death of a mother in childbirth, early death of a parent or sibling, war, natural disaster, emigration, or abuse.

this workshop in psychodrama and sociodrama techniques will be used.

we have a small presentation about ancestor syndrome and Schützenberger and techniques.

maximum of 22 people will be working with.

Everyone should participate actively in the work of the group

Keywords: Syndrome, Family, Constellation, Transgenerational

WS-076

Red Roses Writing about then Learning from Encounters With Patients

Alec Logan¹, Matt Burkes², Deborah Swinglehurst³, Khairat Al Habbal⁴, Janice Crofts⁵

¹Dept of General Practice, University of Glasgow, Scotland, UK

²Dept of General Practice, University of Brighton, England, UK

³Dept of General Practice, Univeristy of London, UK

⁴American University of Beirut Medical Center (AUBMC), Lebanon Department of Family Medicine

⁵MRCGP, GP and educationalist, Lanarkshire, Scotland, UK.

KEYWORDS clinical consultation; narrative; reflective writing; professional practice

Red Roses is a series of twenty reflective vignettes, by eight UK family doctors, based on real clinical encounters with their patients spanning a period of twenty years. Part of a wider collection of writings taken from The Good GP Training Guide (Eds. A. Logan and M. Burkes. RCGP Publications, 2014). The vignettes illuminate the mystery and intimacy of clinical encounters in general practice, and the therapeutic value of personal doctoring.

The vignettes vary in style from levity to tragedy, encompassing anger, hope, despair and optimism along the way. The stories are unfailingly honest.

At WONCA Europe 2014 in Lisbon our Workshop focussed on Reading and Reflecting.

At WONCA Europe 2015 in Istanbul our emphasis changes to Writing and Reflecting. Participants should write their own personal vignette, and submit to authorial team in advance. To aleclogan@dial.pipex.com

We shall choose texts for discussion at Workshop.

At WONCA World 2016 Rio de Janiero we plan to run a workshop combining Reading and Writing around Red Roses. Perhaps with a Plenary – The General Practitioner as Witness. What is a Sinus?

At our Istanbul workshop, we shall discuss reflection on practice and consider the potential educational value of reflective writing as part of professional practice. We shall work with real examples. Written by participants. In small groups we shall discuss topics such as: international comparisons in practice; the nature of decision making in primary care; how the role of family doctor differs from the role of specialist; ethical dimensions of caring for patients; conversations with patients.

The workshop will conclude with participants in each small group identifying learning outcomes and sharing these within a closing plenary. This workshop will be of interest to family doctors, medical students and educationalists.

Alec Logan

Keywords: clinical consultation; narrative; reflective writing; professional practice

WS-077

Training clinical communication skills with simulated patients; sharing the Acibadem University experience

Pinar Topsever, Sirin Parkan, Demet Dinc, Efe Onganer
Acibadem University, Istanbul, Turkey

At Acibadem University School of Medicine, teaching basic clinical communication skills (e.g. history taking, physical examination), as well as, advanced communication skills (e.g. breaking bad news, managing difficult patient encounters, initiating behaviour change) is organized by simulated patient encounters in the advanced clinical simulation center, mainly within the first three years of undergraduate medical education. The aim of this workshop is to share experiences about training programmes using simulated patient encounters, discussing methods of recruitment, training of simulated patients, principles of developing simulated patient scenarios with colleagues, in the light of the constructive feed-back of medical students and simulated patients.

Keywords: simulated patients, medical education

WS-078

The role of training in a hospital setting during vocational training for General Practitioners in Europe

Johan Buffels, Eveline Boogaerts
Department of Public Health and Primary Care, KU Leuven, Leuven, Belgium

Introduction.

Recently we performed a survey among national delegates of the European Academy of Teachers in General Practice/Family Medicine (EURACT) about training in a hospital setting during the vocational training for future general practitioners (GPs). Data from 19 European countries show that any vocational curriculum for general practitioners/family doctors after Basic Medical Education (BME) contains a period of in hospital training. Little comparative work was found about the objectives, the outcomes and the assessment of this kind of education. Research question.

What are the properties of the training in a hospital setting for future GPs during their vocational training in different European countries?

Methods

A survey was sent by e-mail to all available national delegates of the EURACT board. The questionnaire addressed the following questions. Minimal and maximal duration of in hospital training for future GPs, definition of the learning objectives, assessment of the trainees, rotation between the different disciplines, and involvement of the GP faculty.

Results

The properties of the training in a hospital setting for future GPs show a large degree of variation between the European countries. The results will be presented as an introduction for a workshop at the WONCA Europe Conference 2015.

Proposal

To create a workshop during the WONCA Europe Conference 2015, in order to share experiences and to set priorities for a further research agenda about training in a hospital setting for future general practitioners/family doctors.

Keywords: hospital setting, vocational training, general practitioner, family doctor

WS-079

ICPC-3: Progress toward a new version of the International Classification of Primary Care

Ferdinando Petrazzuoli¹, Nicola Buono², Thomas Kühlein³

¹Department of Clinical Sciences in Malmö, Centre for Primary Health Care Research, Lund University, Malmö, Sweden

²Via Tartari

³Universitätsstraße 29

SUBJECT: Progress made toward ICPC-3

JUSTIFICATION: ICPC has become a standard classification tool to support primary health care in many countries. Where used, it has provided invaluable and previously unavailable data about the content and process of primary health care. But we have seen significant changes in the content of primary health care since its introduction, especially in the areas of multimorbidity and management of risk factors for disease. WICC has begun a major revision of ICPC, focused on preserving the simplicity and clinical utility of the classification while adding new components and concepts that capture the new content of primary health care.

CONTENT: We will include a mix of presentations and participatory sessions, with audience questions encouraged at any point.

Session 1: What is ICPC, and why is it so useful in general practice/primary care?

Session 2: Why ICPC-3?

Session 3: What are the main goals for the work on ICPC-3 (what do we need to make better)?

Session 4: What is the working process we are using to make ICPC-3, and what have we done so far (demonstration and participation).

PRESENTATION TYPE: WORKSHOP.

A mixture of short presentations (15 min each plus questions) and demonstration/participation (30-45 min). The overall session is best described as a workshop. We request a 90-minute session as a minimum, would prefer a 2-hour session if available.

Our main goals are:

(1) to help participants understand ICPC and the changes we plan to make

(2) to stimulate interest in using ICPC

(3) to actively participate in suggesting priorities for change, and ideas about how we can work more effectively to create the new version

Keywords: multimorbidity, management of risk factors, diseases

WS-080

Ethical dilemmas in General Practice- a workshop

Manfred Maier¹

¹Dept. General Practice, Centre for Public Health, Medical University of Vienna, Austria

²Wonca Working Party on Ethical Issues in General Practice

INTRODUCTION:

Since its foundation in 2000, the “Wonca Working Party on ethical issues in General Practice” regularly organizes symposia and workshops on clinical situations of everyday practice involving ethical dilemmas.

Goals:

It is the aim of the workshop to present recent situations involving ethical dilemmas as they occur regularly in General Practice / Family Medicine and to discuss their background and possible consequences for the patient, his/her family, the physician and the society in general,

METHOD:

The workshop will start with short presentations by the participants of situations demonstrating ethical dilemmas. The participants may then agree to select specific situations out of those presented, will split into small groups and will discuss the following issues using the examples selected:

1. The patient’s history and other factors, which resulted in the development of the particular ethical problem presented
2. The possible consequences of the situation for the patient and the physician
3. Possible solutions
4. What are the basic ethical principles demonstrated and challenged by this situation?

Expected outcome:

At the end, the results of the small group discussions will be presented to the audience. It is the goal of this workshop to increase the awareness for the relevance of ethical standards and attitudes as applicable to future medical graduates and General Practitioners and for influences upon these standards.

Time Frame:

The workshop will last 75 minutes.

Keywords: ethics, dilemmas, General Practice

WS-081

Clinical Research Methodology Workshop

Firdous Jahan

Department of Family and Community Medicine (FAMCO), Oman Medical College, Oman

Justification

An understanding of research is essential for all family physicians. A number of clinical research studies highlights the need for greater participation in research by physicians. Physicians face a variety of barriers with regard to participation in clinical research. Barriers to participation include lack of time, lack of resources, trial-specific issues, communication difficulties, conflicts between the role of clinician and scientist, inadequate research experience and training for physicians, and sometimes a scientifically uninteresting research question, among others. Strategies to encourage physician participation in clinical research include adequate training, research questions that are in line with physician interests and have clear potential to improve patient care, and regular feedback. This workshop aims to train clinician's about an essential elements of research methodology.

Contents

It begins with a broad overview of the clinical research and good practice in medicine. Subsequent sessions provide a stepwise guide to undertaking a research project, from posing a hypothesis through to writing the paper. The workshop has a strong interactive focus, and a mixture of topics such as Steps in the development of a research proposal, Setting hypotheses and formulation of objectives, Types of variables and scales of measurements, Types of research designs, Data Analysis, How to write manuscript and get your research published.

At the end participants will have gained a basic understanding of:

- Research Proposal
- Research Question
- Research Design
- Type of Data and Analysis
- Writing Manuscript

Practice Session

After an interactive power point presentation, small groups will be invited to write a proposal out line and present in front of participants for feedback.

Keywords: Research methodology, design, hands on practice, family medicine

WS-082

Workshop on Current status, issues, barriers, challenges and way forward for Primary Care Research globally and in Europe

Waris Qidwai¹, Mehmet Ungan²

¹Aga Khan University, Karachi, Pakistan

²EGPRN & WONCA Europe

Justification:

Primary Care Research is required to improve clinical services at primary care level. Data and scientifically sound interventions at primary care level are required to improve health of communities. Currently primary care research is gaining strength and attention of primary care practitioners and policy makers. We wish to conduct this workshop to look at current status, issues, barriers, challenges and way forward for Primary Care Research globally and in Europe.

Lead Persons: Waris Qidwai, Chair, WONCA Working Party on Research

Content:

Introduction..... 10 minutes

Seven groups to discuss Primary Care Research Strategies to improve Primary Care Research and come up with recommendations.... 30 minutes

Recommendations to be presented to larger group.....25 minutes

Summary/ Conclusions.....10 minutes

OBJECTIVES: To look at Primary Care Research Strategies to improve Primary Care Research

Strategy:

1. Participants will be identified and invited to represent seven WONCA regions
2. Ideally, a minimum of three participants per regional group will be identified
3. An overview will be given at the start of the workshop
4. Group work will involve dividing participants into seven groups. Each group will identify a moderator and a repertoire.
5. Each group will present to full group followed by discussion
6. Proceedings of presentation and discussion will be recorded
7. Conclusion will summarize the workshop deliberations
8. A manuscript based on proceedings will be published with all participants as contributors

Keywords: Primary Care; Primary Care Research; Family Medicine

WS-083

Research by New and Future GPs Incorporating the 2015 Vasco da Gama Movement Junior Researcher Award

Peter A Sloane¹, Persijn Honkoop¹, Harris Lygidakis¹, Ivana Babic¹, Ana Luisa Neves²

¹Vasco da Gama Movement (VdGM)

²European General Practice Research Network (EGPRN)

Justification

Since 2011, the Vasco da Gama Movement (VdGM) has promoted science among junior general practitioners who combine research with patient care. In our workshop we aim to provide an opportunity to discuss relevant research topics in small groups of people who are interested in similar topics.

In addition, we will award outstanding careers and ideas with the Junior Researcher Award. The award honours the best research idea of GP-trainees or junior GPs with up to 5 years working experience after graduation. The auditorium is invited to learn from junior champions in research. This workshop sets the stage for bringing together junior researchers and/or trainees, senior researchers with outstanding expertise and interested GP trainees to learn from each other in order to promote future careers combining general practice research and training. Linking senior and junior generations in general practice research is expected to promote exchange of ideas, methods and opportunities for funding and collaboration. Through this workshop European GP-trainees and junior GPs may become enthusiastic about a future lifetime career in research and practice.

Content

The workshop will contain two parts. In the first part we will divide the audience into small groups based on themes of interest. Thereby, people who are (interested in) doing in similar fields of research meet and can actively build a network and participate in knowledge transfer. In the second part three finalists selected by an international jury will present both their ideas for future research and their personal career. Every presentation will be followed by a discussion. In the end we will announce the final winner.

Keywords: Research, VdGM, Junior Research Award, EGPRN

WS-084

A collaborative framework for European Primary Care Clinical Trials: first experiences

Catherine Friderieke Enters-Weijnen¹, Diederick E. Grobbee², Richard Hobbs³, Paul Wallace⁴, Nicolaas J De Wit², Stéphane Heijmans⁵, Miguel A. Munoz-Perez⁶

¹Primary Care Research, Julius Clinical, The Netherlands

²Julius Center for Health Sciences and Primary Care, UMC Utrecht, The Netherlands

³Department of Primary Care Health Sciences, Oxford University, United Kingdom

⁴NIHR, CRN, London, United Kingdom

⁵Research Link, Linkebeek, Belgium

⁶IDIAP Jordi Gol, Barcelona, Spain

Objective

Clinical trials in general practice care are necessary to guarantee the development and implementation of new therapies for the population at large. As pharmaceutical companies and legislation concerning research become more international, studies will need to increase in scale and scope, often spanning multiple countries. This will require to increase the international collaboration among primary care physicians aligning best practices related to drug research in general practice with colleagues from around the globe.

Methods

Important insights to implement clinical trials in the primary care setting more successfully will be presented during an interactive workshop. Various specialists in this field will share their experiences in collaboration among both academic and commercial European research organizations and networks. Quality issues, operational

insights, innovation and the added value of consortia will be illustrated with a number of ongoing collaborative studies. There will be ample room for questions and sharing of experiences among the participants.

Results

Participants can apply knowledge gained from this workshop to improve both the quality and the impact of their research involvement in daily practice. This workshop will be a platform where key researchers from different countries exchange experiences and facilitate the further development of an international collaborative framework to co-ordinate primary care trial activities across Europe.

Conclusions

Internationalization of clinical trials in the primary care setting can be rewarding and provides additional insights and learnings. International cooperation and collaboration between primary care research networks and academic consortia will facilitate this process.

Keywords: clinical research, collaboration, international, research network, primary care, drug research

WS-085

Writing for publication - meet the Editors!

Jelle Stoffers¹, Hans Thulesius²

¹Department of Family Medicine, Maastricht University, Maastricht, the Netherlands; & European Journal of General Practice

²Department of Family Medicine, Lund University, Malmö, Sweden; & Scandinavian Journal of Primary Health Care

Writing for publication - meet the editors! A workshop by editors of the European Journal of General Practice and the Scandinavian Journal of Primary Health Care.

Hans Thulesius (hansthulesius@gmail.com) is the National Editor for Sweden of the Scandinavian Journal of Primary Health Care. Jelle Stoffers (ejgp-jstoffers@maastrichtuniversity.nl) is the Editor-in-Chief of the European Journal of General Practice (EJGP), the official scientific journal of Wonca Europe.

BACKGROUND: Peer reviewed medical journals are important media for the publication of articles relevant to Primary Health Care and General Practice/Family Medicine, such as research papers, reviews of literature, clinical lessons, and opinion papers. They are the means to disseminate original research results and educational information, discuss available evidence and share experiences. However, many colleagues find writing and submitting a scientific paper a challenge.

OBJECTIVE: To provide participants with information about preparing a manuscript for medical journals.

Audience: Authors interested in research or medical writing and with little or no previous experience in publishing. More experienced authors are welcome to join this workshop to share their experiences.

METHODS: The workshop has the format of an interactive presentation. It focuses on the preparation and submission of research papers. Topics discussed are the basic structure, language and presentation of research papers, and common errors and how to prevent them. Furthermore, we address issues like: How to write a good Abstract? What is an informative Title? What should a Cover Letter look like? In addition, the peer review process is discussed. Optional topics: choosing the right journal, (dis)advantages of open access journals, authorship and potential conflicts of interest, or the organisation of your writing project.

Expected RESULTS: Participants will have received basic knowledge and practical advice (“tips & tricks”) on how to prepare an appropriate manuscript to be published as a research paper in a peer-reviewed medical journal.

Keywords: writing, publishing, medical journal, peer-review, research



AUTHORS/REVIEWERS:

<http://mc.manuscriptcentral.com/ejgp>

READERS/USERS:

<http://informahealthcare.com/gen>

Ejgp-istoffers@maastrichtuniversity.nl

AUTHORS/REVIEWERS:

<http://www.manuscriptmanager.com/sjphc/>

READERS/USERS:

[Sjphc.org](http://sjphc.org) or

<http://informahealthcare.com/toc/pri/31/3>

hansthulesius@gmail.com

(C) Stoffers & Thulesius

Optional figure, to draw attention to this workshop

WS-086

Integrating a Research Career into Practice

Eugene Yee Hing Tang¹, Victoria Welsh², Hannah Fox¹, Camille Gajria¹, Rakesh Modi¹

¹Institute of Health and Society, Newcastle University

²Research Institute for Primary Care & Health Sciences, Keele University

In an ever-changing primary care structure, it is now recognised by future General Practitioners (GPs)/Family Physicians (FPs) that primary care can offer the individual ample opportunities to expand their career horizons. Research in primary care is growing. Although there are a number of different avenues that both primary care trainees and early career family physicians could take to get into research, this is not always made abundantly clear to interested individuals. The aim of this interactive session is to highlight opportunities available and also to discuss research ideas with colleagues, including peer review and feedback.

Format

- Brief presentation on how GPs/FPs at all stages can get into research as well as the benefits and challenges one might face
- To split off into groups of 3 to think of a “research idea” relevant to primary care. This will then be presented to the rest of the audience in a one minute time slot
- Feedback will be given to each group by the audience/panel members regarding the research idea.

Keywords: Research, Portfolio Career, Academia

WS-087

Recruiting healthy volunteers to clinical and epidemiological studies and receiving personal consent according to international and national regulations

Mumtaz M Mazıcıoğlu¹, Neşe Yeniçeri²

¹Erciyes University Faculty of Medicine Kayseri Turkey

²Muğla University Faculty of Medicine, Department of Family Medicine Department

Any comment about the situation of clinical and nonclinical situation in the field of Family Medicine must be based on comprehensive and well constructed trials. The fundamental contribution of these trials can be interpreted as providing basic scientific knowledge together with the opportunity of inter-parameter cause and effect analysis. Both type of these analysis are needed for effective consultation, prevention, therapy and rehabilitation practice of family physicians. No need to emphasise the power of self produced scientific knowledge for your own practice which would discriminate us; the family physicians from other disciplines. Both local or nation wide or international efforts to produce new scientific knowledge can be accelerated and empowered by easily accessible and useful international collaboration without any grant from any institution. A workshop constructed on certain research scenarios in which obtaining regulatory permission in accordance with international ethical principles together with a clear and strong consent procedure may contribute a lot for researchers in primary care. Critical evaluation of local and international regulations and ethical principles may be a significant base for our future.

Keywords: Research, primary care, ethics, regulations

WS-088

Staying young: empowering general practitioners and family doctors to reinvent their careers using the Theory of Optimising Professional Life

Lesley M Piko¹, Karen Flegg²

¹ACT Medicare Local Ltd

²WONCA Editor

Justification: This workshop builds on a similar workshop at Wonca Europe 2014 which highlighted the diverse and challenging career pathways available to family doctors. We will be following Australian research into how family doctors shape their careers and participate in primary health care. Data for that study comprised interviews with thirty GPs plus 2,255 survey responses and a new career theory occupation specific to family doctors was reported: the Theory of Optimising Professional Life. While they come from different generations and work in different social and cultural contexts, most doctors experience a need to reinvent their careers over time. This workshop brings together an international group of family doctors to reflect on their careers, share lessons learnt and explore how individuals adapt when faced with new challenges. The Theory of Optimising Professional Life provides a tool to guide doctors in developing their own long-term careers.

Content: The workshop, led by two facilitators, will include example career path stories and round-table discussions where participants will be expected to reflect on their own career path both past and future. Workshop participants will be given a framework to explore career development strategies and illustrate a variety of roles and career trajectories. This framework can be used to help family doctors understand issues they have in their career and empower them to sustain their interest over time and meet their personal needs for self care and income. This workshop offers a problem-focused approach to resolving career issues, an approach which has been found to help family doctors integrate work and life events and to influence family doctors' career satisfaction in general practice.

Keywords: career pathways, career mobility, career development

WS-089

Do the women doctors have the equal opportunities for practice, research and leadership in family medicine in Europe?

Nil Tekin¹, Amanda Barnard², Amanda Howe³, Zorayda Leopanda⁴

¹Department of Family Medicine, Narlidere Residential and Nursing Home, Izmir, Turkey

²Rural Clinical School, Australian National University Medical School, Canberra, Australia

³Norwich Medical School, Norwich, UK

⁴Family and Community Medicine, University of the Philippines Manila, Philippines

Theme of the workshop: While the women doctors in the increasing number in Europe prefer family medicine, whether equal opportunities are provided to women for clinical practice, research and leadership or not is still discussed. Women can face with various barriers for clinical practice, research and leadership. It is known that various differences among the European countries are in question. At this workshop, opportunities provided to family physicians, barriers inter-countries differences will be discussed and solution strategies will be developed.

Learning OBJECTIVES: Presenting a general view about whether equal opportunities are provided to women family physicians in clinical practice, research and leadership in Europe or not, and ways of solutions for differences among countries and barriers.

20 participants from different countries. Women are particularly encouraged to attend.

Workshop limited to 20

Method 90-minute workshop

Part A- 1 hour interactive tutorial

The opportunities provided to women family physicians in family medicine practice, research and leadership in Europe and barriers will be discussed.

Topics are clinical practice, research and leadership.

The facts that increasingly more women doctors prefer family medicine, general view of opportunities and barriers as a woman family physician, showing the differences in various countries for woman family physicians

Part B: 30 minutes small group work session

Creating opportunities equally in all European countries and common solution strategies to overcome barriers will be discussed.

Expected RESULTS: The awareness of participants about barriers for gender equality in clinical practice, research and leadership as woman family physicians in Europe will increase and solution strategies will be created.

Keywords: 1- Woman family physician 2- Clinical practice 3- Research 4- Leadership

WS-090

Primary care as a strategy to tackle health inequity in Europe

William Wong¹, Sara Willems², David Blane³, Patrick O'donnell⁴

¹The University of Hong Kong

²Ghent University

³University of Glasgow

⁴University of Limerick

Background

Tackling inequities in health is a central policy commitment of most European countries. While many drivers of health inequities lie outside the healthcare system – education, employment, etc – it has long been recognised that health services can play an important role in either reducing or widening health inequities (1,2). Barbara Starfield has reminded us utilizing an effective primary care system is the key to ameliorate health inequities and improve the health of within a country's health system (2)

Goals

The main aim of this workshop is to highlight the potential of primary health care to reduce inequity in health. The workshop will give an overview of health inequity in Europe, with examples of how European and national programs focus on tackling inequity in health. There will be group discussion on the specific role of primary care in tackling health inequity, with reflection on some promising national and local initiatives.

This workshop will enable the participants to:

- Understand trends in health inequity across Europe and European primary care systems;
- Reflect on the role of primary care in reducing health inequity;
- Consider specific actions that can be taken to improve health equity, based on experience in different countries

Outline of workshop

- 1) Brief introduction to the Health Equity Special Interest group (SIG)
- 2) Plenary presentation on the current landscape of Health Equity in Europe, including results from the QUALICOPC study: How equitable are European primary health care systems?
- 3) Small group discussion on the problems, limitations and good practices of primary care in tackling health equity in the participants' countries
- 4) Defining "lessons learned" and wrap-up

References

- 1) WHO (2008). World Health Report - Primary Health Care <http://www.who.int/whr/2008/en/>
- 2) Starfield B, Shi L, Macinko J. Contribution of primary care to health systems and health. *Milbank Q* 2005; 83: 457-502

Keywords: health equity, Europe, primary care

WS-091

Quality Circles at a Glance – Use of Antibiotics in General Practice

Peter A Sloane¹, Christina Svanholm¹, Ulrik Bak Kirk², Adrian Rohrbasser²

¹Vasco da Gama Movement (VdGM)

²European Society for Quality and Safety in Family Practice (EQuiP)

Justification

Quality Circles, also called “peer review groups” are commonly used in primary care in Europe to reflect on and improve the standard practice over time. They represent a social intervention that may have the power to change clinical practice and facilitate the professional development of Primary Care. Controlled studies, reviews and other studies have shown positive behaviour change for those involved. There are currently an ongoing EQuiP study across Europe on “why” Quality Circles seem to be effective. The purpose of this workshop on Quality Circles is to make trainees and general practitioners get a glimpse of a method to increase focus on quality of care in cooperation with specialists from secondary care. The aim with this specific topic is that each participant will return to their own practice with greater awareness and knowledge about the use of antibiotics.

Content

- 1) The workshop will imitate a Quality Circle and the participants will be divided in to groups of 12 (ideally 6 trainees and 6 GPs)
- 2) The topic will be “Use of Antibiotics”
- 3) Two specialists will open the workshop with a short presentation on the topic and afterwards the groups will go through case-material from their own practice
- 4) Subsequently, cases and misc. material will be discussed in plenum with input from the specialists in plenum

Keywords: "Quality Circles", "Peer Review Groups", standards, quality, antibiotics

WS-092

Developing Resources to Facilitate Change Management in General Practice

Peter A Sloane, Claire Marie Thomas, Christofer Patrick Reichel, Yusianmar Mariani, Canan Tuz

Vasco da Gama Movement (VdGM)

Justification

The task facing general practitioners/family doctors is growing more challenging by the day due to changing and growing clinical demands and expectations, together with tighter economic conditions. Therefore, GP/FDs will have to find ways of doing more with the same - or even less - resources. Change is in order but, while doctors often recognise inefficiencies and challenges in current working practice, many will recognise frustration of not knowing where or how to start trying to tackle it!

#FMChangeMakers are a group of young family doctors from across the world, working together to generate and collate resources to empower their colleagues to engage in positive change management.

Content

Short oral presentation introducing the #FMChangeMakers Project and its origins at last year’s VdGM preconference in Lisbon.

Short presentation updating on the activities and progress of the first year of this exciting movement, highlighting it’s presence on social media.

Small Group Work to further explore our 4 flagship themes, with each group tackling a different theme: -

Professional Networking and Collaboration

Communication Skills & Patient Empowerment

Primary Care Focused Evidence & Guidelines

Image & Policy in Family Medicine

In the small groups participants will be asked to: -

Share their experiences in relation to the theme and impact on their practice

Explore barriers/challenges that may prevent change or progress

Identify resources and support mechanisms that may enable them to engage in and instigate change processes

The groups will then reconvene and share the outcomes of their discussions, reflecting on the potential of Family Doctors to engage in change processes at local/national and international levels and how this could impact upon patient care.

Finally we will invite interested participants to sign up to join a work theme should they desire to support the project: Join the #FMRevolution with #VdGMChangeMakers!

Keywords: #FMChangeMakers, Family Medicine, resources, collaboration, change management

WS-093

Quality in my practice. How do I start?

Piet Vanden Bussche¹, Andrée Rochefort¹, Piet Vanden Bussche², Andrée Rochefort³

¹EQuIP

²department of primary care UGent Belgium

³Irisch Collega of General Practitioners Dublin Ireland

A lot of people talk about Quality. GPs deliver quality, patients are entitled to quality and the government or the insurers expect quality. It is thought to be clear for everybody what it means. But it is different for everyone involved.

It is very important to make more explicit what quality means when you talk about it. A lot of experts tried to formulate a definition. What aspects are involved? But the mean message is that you have to define it yourself, for your own practice/ within your own organisation. How can we define quality in our own practice or organisation. And how can this effect the work we are doing?

In an interactive way participants will reflect on the topic. Define the quality for themselves and the group they are working in. Get insight in what quality is all about and be able to formulate a mission statement for their own organisation.

Target group for this workshop are people who want to learn the basics of quality improvement and how to work with it in their own practice or organisation. It will be practice based and daily work oriented. We want to limit the group to a maximum of 20 participants.

Keywords: Quality, general practice, practice based

WS-094

A Workshop on Significant Events in General/Family Practice (Primary Care): Analysis of the Good-The Bad-The Ugly

David G Moores, Bonnie Dobbs

Dept. Family Medicine, University of Alberta

BACKGROUND: Much of the research into health services quality and safety reflects the hospital or acute care environments. Primary Care, where the vast majority of clinical interactions occur in any health system (White et al), has depended on data, processes and perspectives that reflect the acute care/institutional reality. While there are parallels in the error/mistake/blame cultures between primary, secondary and tertiary care an important first step is to open the “black box” of errors, near-misses/crashes, misadventures and poor quality in family/general practice.

AIM: This workshop will provide an overview of the Quality and Safety in Primary Care programme in the Department of Family Medicine, University of Alberta. Participants will be introduced to the UK based “Safety in Primary Care” teaching modules by TVC. The aim is the development and enhancement of significant event analysis skills.

METHOD: Short presentations and small group work will focus on significant events, as identified by participants and supplemented with those from family medicine residents (registrars) during their clinical educational experiences Literature-based characteristics of family/general practice significant events will prepare participants for their small group work.

RESULTS: The development of educational objectives for quality and safety learnings and processes in primary care is an important first step. Changing the culture from one of reacting to such occurrences to anticipating them coupled with the dissemination of learnings is key to changing our culture

CONCLUSIONS: Significant Event Analysis in family/general practice (primary care) is essential and more encompassing of quality and safety issues when compared to Critical Incident Reporting and Analysis (hospital/acute care focus). Primary Care Quality and Safety is an emerging focus for postgraduate education programs in Canada. The sharing of information derived from this focus will advance the understanding of the unique issues in family/general practice quality and safety.

Keywords: quality, safety, significant event analysis

WS-095

Infection prevention in general practice; an unbridgeable gap between theory and practice?

Masja Loogman, Stijn Van Den Broek, Margriet Bouma

dutch college of general practitioners

Justification

Worldwide, there is an urgent need for reducing dissemination of infections associated with healthcare, in order to prevent the spread of pathogens. This includes the prevention of infections in general practice, where the prevalence of MRSA and other multiresistant bacteria is increasing and the health care workers even can be challenged with outbreaks of Ebola or highly pathogenic avian influenza.

In the Netherlands, the Dutch College of General Practitioners is developing a guideline infection prevention for general practitioners. The recommendations in this guideline are based on generally accepted principles. However, there's a big gap between the ideal situation in terms of infection prevention and the current situation in general practice.

Bottlenecks are the lack of support because there is little scientific evidence on the effectiveness of measures on infection prevention in general practice, some recommendations are time costly or not implementable in daily routine, some influence the contact between doctors and their patients, general practitioners do not experience many infections in their practice due to their own actions or interventions.

Organisation of the workshop

- Introduction
- Filling in a short questionnaire on the application of the main topics of infection prevention in the own practice
- Discussion in small groups on the results of the questionnaire (importance of the topics, bottlenecks in the implementation, possible solutions)
- Presentation of the main results in each group
- Plenary discussion

Results

The participating GPs are aware of and feel more prepared to deal with the problems of infection prevention in their practice.

The ultimate goal is to endorse quality promotion of health care which is safe for patients, health care workers, others in the health care setting and the environment, and to accomplish these goals in a cost-effective manner.

Keywords: infection, prevention, quality, recommendations

WS-096

Health inequalities related to socio-economic status: how primary care may reduce them

Hector Falcoff¹, Sara Willems², Piet Vande Bussche², Isabelle Dupie¹

¹Société de Formation Thérapeutique du Généraliste, Paris, France

²Department of family medicine and primary health care, Ghent University, Belgium

Primary care may contribute to increase health inequalities related to socio-economic status (SES) when the « inverse care law » operates, ie when the availability of good primary care varies inversely to the need for it in the population served. At the opposite, primary care may contribute to reduce these inequalities by delivering equitable care.

Learning goals.

- 1) Clarify the concepts: health inequalities, health inequalities related to SES, equity of health care...
- 2) Understand how primary care can increase or reduce these inequalities.
- 3) Identify patient SES informations important to register in the patient medical record, and understand the contribution of these informations to guide the consultation.
- 4) Understand how to improve the equity of primary care.

Methods.

- 1) Presentation of the concepts and mechanisms connected with health inequalities related to SES.
- 2) Small groups of 5-6 participants will work on the detailed narrative of a low SES patient with negative outcomes:
 - a. what could have been done, when, and by whom, to modify the outcomes;
 - b. what skills primary care providers, and particularly GPs, would have needed to act in this way;
 - c. what modifications of the practice organisation would have been necessary.
- 3) The groups will present a summary of their reflection.
- 4) An EQuIP expert will propose a synthesis.

Expected impact on the participants.

To motivate the participants to:

- 1) work on this topic;
- 2) adapt care to specific social groups needs
- 3) register systematically a limited number of SES standardized data on the patients' records, in a time efficient

way;

4) introduce stratification by social groups when measuring quality indicators;

5) implement plan-do-check-act projects to improve equity and to demonstrate the benefit for the patients and the practice.

Keywords: health inequalities, equity, patient medical record

WS-097

"Keep the Flame" Avoiding burnout and promoting happy doctors

Dimitrios Alepidis, Veronika Rasic, Alexandra Tsipou, Ivana Babic, Emna Zarrad

Vasco da Gama Movement

BACKGROUND:

The modern life style and the expansion of technology set constant pressure to doctors to work at the limits of their abilities. This may cause long-term exhaustion and diminished interest in work, commonly known as burnout, or to trigger other medical conditions related to stress. Burnout has been assumed to result from chronic occupational stress (e.g., work overload), and its symptoms are similar to those of clinical depression. Although it is widespread, burnout is not recognized as a distinct disorder, in the DSM-5, but it is included in the ICD-10, and can be found under Problems related to life-management difficulty.

Work/life balance is an important factor to consider as a preventive measure and it is often over looked in the education process. To take care of our patients we first need to know how to take care of ourselves.

OBJECTIVE:

If we consider burnout as a lifestyle induced disorder, raising awareness on this topic, may help young doctors to change their views on the subject and to reorganize their lives to reduce stress, promoting a happier and healthier life.

DESIGN:

The workshop will begin with a short PowerPoint presentation about burnout, its causes and its early signs (8min). After which the participants will be divided into small groups (6-8 persons) and they will have 5 rounds of 8min intervals (total 40min) discussing the issues of:

1. Motivation to be a GP
2. Motivation in their personal lives
3. Recognizing problems relating to everyday work
4. Ideas and techniques for stress management
5. Finding personal strong/weak points and how to use them in a creative way.

Finally, will be presented some examples of doctors that have found interesting ways to manage their work/life balance.

Keywords: Burnout, quality of life, happy doctors, lifestyle

WS-098

How can we make clinical decision support systems effective in general practice?

Derk L Arts, Henk C Van Weert

Department of general practice, Academic Medical Center, Amsterdam, The Netherlands

BACKGROUND: Clinical decision support systems (CDSS) have been around for many years but their effectiveness on patient related outcomes has yet to be proven. We studied the effectiveness of a CDSS in general practice and evaluated what barriers and facilitators influenced it's use in daily practice. This workshop will expand on those findings.

AIM: To identify and describe key elements that can make CDSS effective in primary care. Participants will get a better understanding of the possibilities of CDDS. The discussion outcomes will be used to formulate requirements that the ideal CDSS should meet to be effective in general practice.

Contents: The workshop will consist of a short presentation concerning the design and functions of the system we developed and tested in the Netherlands. We will start a group discussion in which we will discuss several topics that determine CDSS effectiveness: contents (what type of recommendation is best suited for CDDS), presentation (how should recommendations be displayed), timing (how can we integrate a CDSS in the GP's workflow) and other requirements (i.e. the ability to turn off alerts for certain patients). At the end of the workshop we will present our findings and compare them to what was discussed during the workshop.

Outcome: Participants will have gained knowledge and ideas from colleagues in the field and will have an understanding of how CDDS in general practice could be improved. Ideas and concepts will be summarized at the end of the workshop to create a short overview of key features and requirements that were discussed.

Keywords: decision support, general practice, improvement, guidelines, system, health informatics

WS-099

Patient safety in primary care: get started

Isabelle Dupie¹, Andree Rochfort²

¹Société Française de Therapeutique du Généraliste

²Irish College of General Practitioners

4.5% of hospital stays, in France were caused by adverse events (AEs). Over half of those AEs can be considered preventable.

Even if most of studies fail to estimate the incidence of adverse events in primary care, we know that patient safety is an issue as important in primary care than in hospitals.

It's time now to get primary care teams involved in risk management programs.

Learning goals

- 1) Integrate the definition of an AE in primary care
- 2) Experiment reporting AEs
- 3) Learn how an AE analysis can be performed in a group

Method

1. Clarify the definition of an AE

2. Presentation of the case of Mrs C. a frail 90 year old lady coming back home from hospital.

The facilitators explore several questions:

- o What is the adverse event in this story?
- o What are the dysfunctions?
- o What are the immediate and latent causes?

o Which barriers play a role? Which have failed?

3. Participants are invited to recall an AE occurred in their own practice.

4. The participants are split into groups of 3. Each participant tells his/her story. The other 2 participants listen. After discussion, each participant writes on a post-it note:

o what was the risk for the patient in the story

o the feeling(s) he/she had when telling their experience

o the feeling(s) he/she had listening to the others' story.

5. Facilitators pick up the stickies and read the feelings experienced while telling and while listening. The results are gathered on a paper-board

6. Participants discuss the results and give their reactions and opinions

Expected impact on the participants

- Discover that it is not so difficult to tell and discuss adverse event stories
- Motivate to enter in a current practice of sharing and analysing
- Engage into positive safety culture

Keywords: safety culture, adverse event, primary care

WS-100

Access, cost and quality: testing the 'iron triangle' of primary healthcare

Greg Irving¹, Sietse Wieringa², Luisa Pettigrew³, Stephanie Kumpunen⁴

¹University of Cambridge, Cambridge UK

²Queen Mary University, London, UK

³London School of Hygiene and Tropical Medicine, London, UK

⁴The Nuffield Trust, London, UK

Justification

Access, cost and quality – it is often said that in health care you can improve one or possibly two of these variables, but that this improvement must come at the expense of the third. For example, you could make health care cheaper and improve access but this will result in a reduction in quality of the care provided. Alternatively, you could improve access and the quality of care but this will come at increased cost. This 'iron triangle' makes an assumption of dependence between these three essential components of healthcare - but does relationship always hold true and if does (or does not) what are the implications for the future of primary care?

Content

The workshop will begin with a short presentation raising questions about what is actually meant by access, cost and quality in the context of primary care. Participants will then be invited to discuss healthcare policy decisions in their country and whether any trade-offs have taken place in relation to delivering access, cost and quality. High quality system level evidence from WONCA Europe member states will be used to support this debate. We will then empirically 'test' the iron triangle by comparing access, quality and primary health care spending and ask participants to consider the consequences of the findings for the future of Primary care in their own country.

Every year at the WONCA conference, Luisa Pettigrew, Greg Irving, Stephanie Kumpunen and Sietse Wieringa, Family Physicians and researchers with an international scope, explore a complex economic concepts and how they affects primary health care.

Keywords: Primary care, access, cost, quality

WS-101

Quality Indicators for Family Practice

Zekeriya Aktürk¹, Ebru Yılmaz²

¹Department of Family Medicine, Atatürk University, Erzurum, Turkey

²Sivas Akıncılar District State Hospital

The term "Quality" has an important impact in the life of family physicians. Different terms and concepts are in use: "Quality standards", "Quality control", "Total quality management", "Continuous quality improvement".

In this workshop we will present about the quality-related terms and discuss especially the use of indicators in family practice. With the contribution of participants we will define different indicators (infrastructure indicators, process indicators, clinical indicators, and outcome indicators) to be used by family physicians.

Keywords: quality, EQUIP, indicators, family practice

WS-102

How does coding support the key tasks of the GP and improve patient care?

Ilkka Kunnamo¹, Karen Kinder², Ferdinando Petrazzuoli³, Fernando Alonso Lopez⁴, Angel Ruiz Téllez⁵

¹Duodecim Medical Publications Ltd., Finland

²Bloomberg School of Public Health, Johns Hopkins University, USA

³Centre for Primary Health Care Research, Lund University, Malmö, Sweden

⁴semFYC, Spain

⁵CYMAP Ltd., Spain

JUSTIFICATION: Defining the key functionalities of electronic health records supporting the work of the GP was identified as a priority for the WONCA Working Party on eHealth (WWPeH) in a member survey. A wish for closer collaboration with the WONCA International Classification Committee (WICC) has been expressed by many WONCA members. An essential requirement of IT support for clinical care is accurate and complete coding of data. In the workshop we will address these expectations and show examples from 3 countries, followed by discussion on how coding should be used and developed.

CONTENT:

Ilkka Kunnamo (WWPeH): Introduction - coded data supporting clinical care (10 min). Benefits include support of clinical decisions and improved patient safety via decision support, automation of routine tasks, care coordination across the primary care team and specialized care, caring for the whole population by identifying care gaps and promoting equity, communicating with and empowerment of patients by sharing data and knowledge, and improvement of the quality of care by supporting professional development via analysis of process and outcome. Figure 1 shows the cycle of coded data flow in the care of individuals and populations.

Karen Kinder: Identifying high risk patients in NHS UK (10 min)

Angel Ruiz Téllez, Spain: Is it possible to promote excellence in general practice via computer-assisted coding? (10 min)

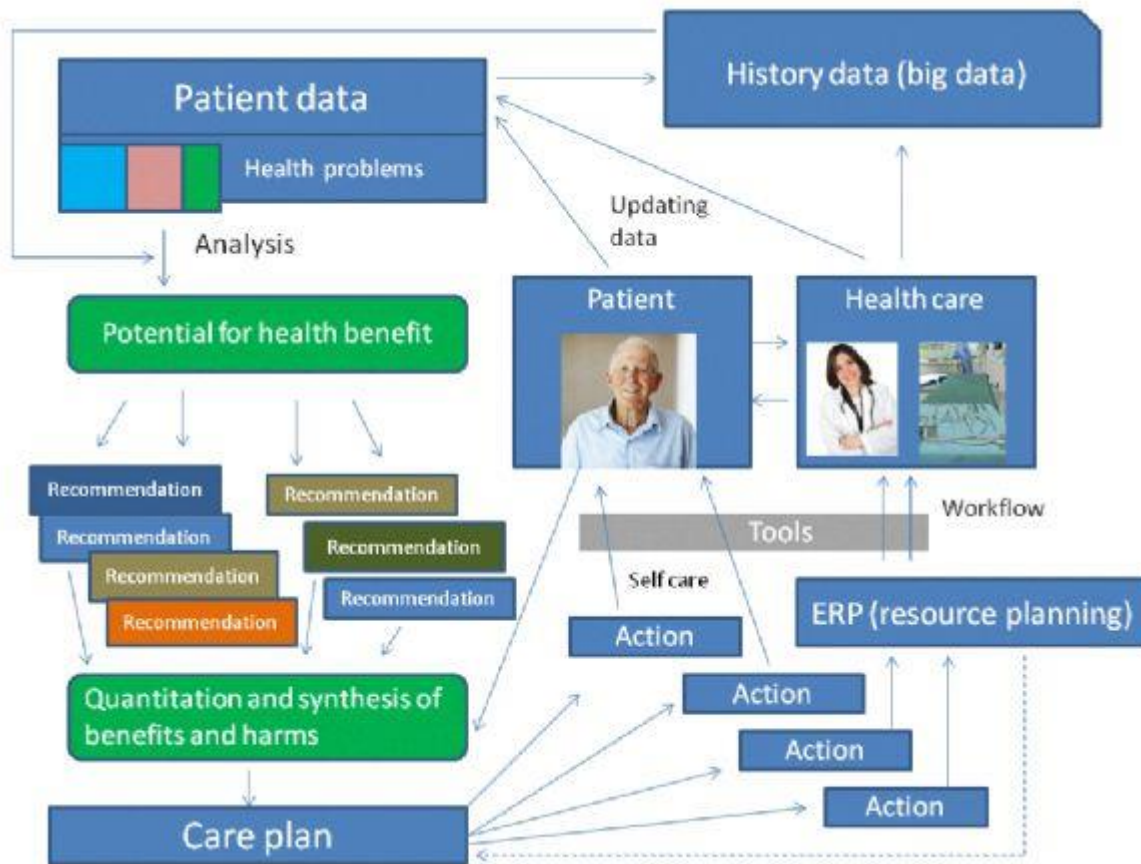
Ferdinando Petrazzuoli (WICC): The future of ICPC: parallel development (ICPC 3), inclusion in ICD-11 or mapping to SNOMED CT? (10 min).

DISCUSSION: one group for each presentation, facilitated by the presenters (20 min)

Reporting and agreement on the next steps (15 min)

The conclusions of the discussions will be published on the WWPeH website.

Figure1



Cycle of coded data flow in the care of individuals and populations

WS-103

Health Literacy: Finding the right words for better health

Fatma Goksin Cihan¹, Dursun Cadirci², Didem Kafadar³

¹NE University Meram Medical Faculty, FM Department, Konya, Turkey

²Harran University Medical Faculty, FM Department, Sanliurfa, Turkey

³Bagcilar Training and Research Hospital, FM Department, Istanbul, Turkey

Justification:

Health literacy(HL) is the degree to which individuals have the capacity to obtain, process, and understand basic health information and services needed to make appropriate health decisions. Besides basic literacy skills, HL requires knowledge of health topics. People with limited HL often lack knowledge or have misinformation about the body as well as the nature and causes of disease. Without this knowledge, they may not understand the relationship between lifestyle factors such as diet and exercise and various health outcomes. Inadequate HL may result in patient violence against health care professionals as they can misunderstand the interventions.

Health literacy affects people's ability to:

- Navigate the healthcare system, including filling out complex forms and locating providers and services
- Share personal information, such as health history, with providers
- Engage in self-care and chronic-disease management
- Understand risks

Compared to those with adequate HL, patients with limited HL have decreased ability to share in decision-making

about prostate cancer treatment, lower adherence to anticoagulation therapy, higher likelihood of poor glycemic control. Properly assessing the literacy level of individual patients or groups may avoid problems in clinical care and research. HL is fundamental to quality care, and relates to safety, patient-centered care, and equitable treatment. Self-management and HL have been identified as cross-cutting priorities for health-care quality and disease prevention. The purpose of this workshop is to discuss HL and its outcomes, share experiences and find common solutions to improve the health knowledge level in society.

Content

The definition and affecting factors will be explained by Dursun Çadircı.

Assessing methods and instruments will be introduced by Didem Kafadar.

Outcomes and reflections of HL to family medicine and quality of health will be discussed by Fatma Goksin Cihan.

Experiences, new approaches and research proposals will be discussed by all of the participants.

Keywords: Health literacy, quality, violence

WS-104

Electronic primary care guidelines: Experiences of translation and adaptation in different settings

Rabia Kahveci¹, Ilkka Kunnamo², Nicole Dekker³, Roman Schlager⁴, Duygu Ayhan Baser⁵

¹Department of Family Medicine, Ankara Numune Training and Research Hospital, Ankara, Turkey

²Department of General Practice, University of Helsinki, Helsinki, Finland

³Guideline Development Group Domus Medica vzw, Antwerpen Belgium

⁴Institute of General Practice and Family Medicine, University of Witten/Herdecke, Witten, Germany

⁵Department of children adolescence woman reproduction health, Kocaeli Public Health Directorate, Kocaeli, Turkey

BACKGROUND: There is increasing interest in Clinical practice guidelines (CPGs) development methods. CPGs are mostly developed by 3 methods in all over the world; named as; adoption, de novo and adaptation. The adaptation approach is getting more popular as it provides opportunity to less resource use with more context-specific recommendations.

Workshop PURPOSE: The aim of this workshop is to illustrate translation, adaptation and dissemination experiences of electronic primary care guidelines (EPCG) in different settings and to explore joint efforts for improving primary care guidelines (PCGs) as well as define how knowledge-sharing could serve this purpose.

Workshop Target Audience: Guideline developers, primary care physicians, institutions working in guideline development and/or dissemination

Workshop Description: Adaptation of guidelines is the systematic approach to considering the use and/or modification of (a) guideline(s) produced in one cultural and organizational setting for application in a different context. Most high quality evidence originates from developed countries, but may not be applicable to developing countries, and the development of guideline is expensive, time-consuming, and requires certain expertise. Consequently, adaptation can be used as an alternative to de novo guideline development and adoption. In this workshop EPCGs, their development and the dissemination process will be presented (IK). This will be followed by presentations from Belgium (ND) and Germany/Austria (RS) summarizing their experiences in using these guidelines, the translation process and the process of guideline adaptation. DA and RK will present description of ADAPTE, its worldwide use and the unique strategy Turkey has recently developed for adaptation of EPCGs, based on ADAPTE. The session will continue with an open discussion with speakers about how these activities could be taken further in order to increase use of PCGs and to have better, high quality adapted guidelines in each setting. The audience will be asked for their contribution with questions and comments.

Keywords: Guideline Adaptation, Guideline Development, Electronic primary care guidelines, ADAPTE

WS-105

Professional resilience of female family doctors during lifecycle transition events

Alice Shiner¹, Amanda Howe¹, Jessica Watson², Noemi Doohan³

¹Department of Population Health and Primary Care, Norwich Medical School, University of East Anglia, Norwich, UK

²School of Social and Community Medicine, University of Bristol, Bristol, UK

³Ukiah Valley Medical Centre and University of California, Davis, California, USA

""Justification""

This workshop relates to a project being undertaken on behalf of the WONCA Working Party on Women and Family Medicine (WWPWFM). It will form part of a global qualitative research project to determine the factors involved in maintaining the professional resilience of women primary care doctors during times of lifecycle transition, such as marriage, parenting, and caring for aging parents. These issues are related to keeping doctors in the workforce, and shed light on the needs of male doctors as well.

""Content""

The workshop will begin with presentation of key findings from a literature review on women family doctors' professional resilience during lifecycle transitions, followed by a summary of the data gathered during discussions between delegates at three previous workshops regarding this topic. Workshop participants will then be asked to discuss the issues raised, particularly considering their level of agreement with the conclusions reached during the previous workshops. The workshop will end with a plenary session to identify agreed common themes regarding challenges to resilience by lifecycle events, and the strategies and solutions that can help maintain resilience. The output of the workshop will be recorded in order that it can be used to identify themes for further exploration within the qualitative interviews and focus groups in the WWPWF research project.

Keywords: Resilience, Transition, Gender

WS-106

Curiosity & Complexity in Primary Care and Health Education. A Complexity SIG workshop

Joachim Sturmberg¹, Carmel Martin², Jim Price³, Bruno Kissling⁴

¹Newcastle University - Australia

²Trinity College - Ireland

³Brighton & Sussex Medical School - UK

⁴private practice

Presenters: Bruno Kissling, Carmel Martin, Jim Price, Joachim Sturmberg

Curiosity is something we observe with admiration in young children. It is the driver for exploration, learning and knowledge generation, an approach many of have been deprived off since medical school days with its root learning and protocol driven approaches. Here we want to explore the nature of curiosity and how it can enhance our thinking and acting. Systems and complexity science techniques offer an opportunity to use curiosity in a highly productive way for the benefit of our patients and our own satisfaction with work.

The workshop will take participants on a journey to explore:

- The notion of 'curiosity'? Participant activity – in threes – "How would you define curiosity"? "Why is it important for students and practitioners of medicine?" - facilitated by BK/JP
- The concepts of 'complexity' and complexity sciences - short presentation by JP
Brief overview of complexity thinking, models of complexity in health/healthcare/education (?JP)

Workshop outline

- On your own - Pick a problem currently facing you in your own clinical / educational / managerial role. Concentrate on what makes YOU curious about the issues? What/who are you 'curious' about? Why might this be?
- Group discussion - How can we apply complexity and curiosity to medical education a) at undergraduate level b) at postgraduate level?
- Group discussion - Can General Practice be reformulated to represent THE worldwide model for medical education and practice to ensure doctors remain interested in both the 'art and science' of diagnosis and care?
Q&A

Keywords: complexity, clinical care, medical education

WS-107

The Impact of Gender on Everyday Practice

Sara Rigon¹, Yusianmar Mariani², Nina Monteiro², Patrick Reichel³, Luís De Pinho Costa², Ana Nunes Barata⁴, Sara Belinchon⁵, Hassoune Hanim⁶

¹GP Specialist, Bologna Italy

²GP Trainee, Portugal

³GP Specialist, Vienna, Austria

⁴GP Specialist, Lisbon, Portugal

⁵GP Specialist, Madrid, Spain

⁶GP Specialist, Marseille, France

Justification:

Since ancient times Medicine in western countries has been dominated by white men while women were limited to more subordinated and caregiving positions, culturally more acceptable and socially convenient. Despite ongoing challenges, nowadays there are more female physicians than ever before in history and men nurses are not an awkward exception anymore.

Along with these changes come questions on whether gender influences the practice of medicine - in what ways? Does gender of the healthcare provider impact on patients? Do patients have different expectations from female and male physicians? If a patient prefers one over the other could this be considered gender discrimination? And where to go from there?

By raising the issue of gender we aim to start a discussion and inspire colleagues to abandon the anachronistic female-versus-male perspective and embrace a new attitude of understanding and collaboration for a gender blind Health Care profession. We hope to drive the primary health care community to break free of old paradigms and rethink its structure towards a future of equal opportunities and professional success regardless of gender.

Content:

The proposed activity will include:

- short presentation on gender roles and stereotypes in modern society and their translation into the working world and the health care profession
- working groups: participants will have the possibility to discuss in groups upon the impact of gender in everyday practice from different points of view: patients' perspectives and expectations, potential gender discrimination, career and leadership opportunities, collaboration among colleagues, and more.
- Report back and final discussion

Keywords: gender, health professionals, primary care, professionalism, gender medicine

WS-108

The hard art of clinical decision making in General Practice

Alessandro Menin, Giorgio Visentin
Csermeg, Italy

Justification: Following the Donald (Raj) R. Woolever article "The Art and Science of Clinical Decision Making" the Authors thought that every day physicians face difficult decisions when they advise the patient on the best treatment to follow and assist the patient in end-of-life care. There are many paths to a clinical decision, and what works well for one physician may not work well for another. The purpose of this workshop is to provide an opportunity to exchange views on this issue to discover the thought processes that help us to improve the patient care.

Content: The workshop will begin with a brief presentation of the topic with some practical examples accompanied by references from Evidence-based medicine, scientific literature, and material drawn from Medical Humanities as verses of poetry, short stories and aphorisms. Most of the time will be devoted to discussion in small groups that will have to confront on some guiding questions. Will cover topics of ethics and scientific method, intuition and experience, learning and shared decision making, technology and humanity. Some facilitators will help groups to channel their ideas to produce a report that will be discussed in plenary.

Keywords: Decision making, Medical Humanities, Experience, Intuition, Evidence-based medicine, Patient care

WS-109

Addressing sexual health consultations in primary care

Ruth Muñoz Maya¹, María Dolores Bernal Peinado², Elvira García Martín³

¹CS Don Paulino García Donas, Alcalá de Guadaíra. AGS Sevilla-Sur, Andalusia, Spain

²CS Nuestra Señora de la Oliva, Alcalá de Guadaíra. AGS Sevilla-Sur, Andalusia, Spain

³CS Utrera Sur, Utrera. AGS Sevilla-Sur, Andalusia, Spain

In 1975, WHO defined sexual health as "the integration of the somatic, emotional, intellectual and social aspects elements of the sexual being, in ways that are positively enriching and enhancing personality, communication and love". Sexual health is an essential part of global health concept, both at an individual and community level, as it has social and interpersonal involvements. It appears at every level in WHO definition of health: physical (physical limitations restricting sexual activity), psychological (self-concept, attitude and aptitude towards sexuality) and social (beliefs, myths, taboos, sexual variability).

Most of the work concerning sexual health is addressed to women, focusing primarily on birth control – becoming a gender bias-, and STD. This means setting aside sexual identity, sexual experience and other issues or variants of normality that could appear among our patients, including pharmacologic secondaries.

Being consistent with this definition of sexual health, family doctors have an important role in detecting and solving sexual problems. Therefore, training for sexuality is needed, since sexual alterations influence on and may be influenced by the different life cycles and family dynamics.

In addition, sexual attention is affected by the beliefs and prejudices of the doctors themselves and the society where health assistance takes place. In fact, many doctors in our area refuse to give advice on birth control because of religious beliefs; even more, if we talk about other issues of the sexual sphere.

There are also studies that show that the refusal of doctors to talk about sexual problems with their patients is greater than wished, since it has been seen that patients feel more confident and grateful when the physician begins this conversation.

Then, we find interesting evaluating the concept of sexual health that doctors have in our area and which issues are usually treated in case of performing any intervention.

Keywords: sexuality, sexual health, sexual dysfunction, interview, clinical skills

WS-110

Affirmations as a tool to help patients move towards behavioural changes

Anneli Rätsep, Ruth Kalda

Department of Family Medicine, University of Tartu, Estonia

Aim of the workshop.

After the workshop the participants

- 1) will be aware of affirmations as one of the micro skills in motivational interviewing (MI)
- 2) will be able to make affirmations for patients who seem unmotivated.

Often in primary care consultations patients need to make decisions related to their health. Increasing patient self-efficacy and providing patient centred care are the core skills of family physicians. MI is a counselling approach applicable in family physician's busy schedule. MI is used to help a patient make or get ready for positive changes in behaviour. Open questions, reflective listening, affirmations and summary are micro skills of MI consultation style while combined with MI spirit.

Affirmations are statements made by physician in response to what clients have said and are used to empower a patient by helping them recognize their strengths and see themselves more positively. Affirmative responses or supportive statements evoke patients to talk about behavioural changes and move in the direction of positive changes, no matter how big or small the changes will be. By offering positive affirmations, patients' confidence (or self-efficacy) can be built. To be effective, affirmations must always be genuine and congruent.

In the interactive workshop participants can practice selecting and making affirmations which may help patients to recognize their strengths.

Keywords: Motivational interviewing, affirmations, behavioural change

WS-111

Music therapy: A Hands-on Session for Biofeedback

Elena Benigni

Family Medicine Department of Accademia Shoho

Justification:

Music Therapy (MT) is the clinical and evidence-based use of music interventions to accomplish personalized goals with individuals, groups or families who seek to optimize their quality of life and improve their physical, social, emotional, and spiritual health and wellbeing. Nowadays we can monitor the effect of the music interventions by heart rate variability (HRV) analysis and in the meanwhile, generate a personalized music directly from the patient's HRV. MT is currently being utilized in various situations such as analgesia, sleeping disorders, anxiety, and infertility.

Content:

After a brief introduction on music therapy and its role in family medicine throughout the world, we will have participants recording their HRV with electrodes for the following sessions: baseline conditions, with irritating videos, HRV music biofeedback, and under meditation. The collected HRV data will be analyzed and we will discuss the possible future applications in family medicine.

Keywords: heart rate variability, music therapy, biofeedback

WS-112

Reverse innovation - re-engineering primary care

Sinan Mir, Joanna Thorne, Rakesh Modi

Royal College of General Practitioners, London, England

Focus on key emerging issues in primary care and explore how poorer resource settings have overcome these obstacles and the feasibility of implementing such interventions in the UK and Europe.

For example:

- Mental health: health "houses" in tanzania, china and iran that integrate mental health services seamlessly with primary care
- Chronic care models: Project connect in Zambia aimed at reducing patient no shows in clinic and a more streamlined efficient service pathway (Subsequently take up by Aids clinics in Alabama)
- Health workforce: community health worker model hugely successful in brazil, india, peru, haiti and wales(!)
- Health information: The rapid expansion of mobile health (or mhealth) in developing countries has created innovation hubs in Kenya, Uganda, South Africa, Rwanda where mhealth campaigns are transforming rural healthcare through improved data collection, disease surveillance, post-discharge surveillance, health promotion, diagnostic support and remote patient monitoring.
- Leadership and governance: polio eradication/compulsory leadership training for health managers in brazil

Focus on areas where European primary care can learn the most from developed countries including: remote healthcare, skills substitution, creative innovation, use of mobile technologies in healthcare, decentralisation of management, social entrepreneurship

Keywords: reverse innovation, global health, knowledge sharing

WS-113

SMARTER PLANET SMARTER HEALTHCARE, e-Health

Zelal Akbayin¹, Charilaos Lygidakis², Ulrik Bak Kirk³, Raquel Gomez Bravo⁴, Peter A. Sloane⁵

¹Hurriyet ASM, Istanbul, Turkey

²Bologna, Italy

³EQUIP, Copenhagen, Denmark

⁴SemFYC, Spain

⁵VdGM & ICGP, Dublin, Ireland

Introduction

E-Health is a relatively recent and broad term encompassing implementation of means of information and communications technology in the health and healthcare sectors for clinical, research, educational, service delivery, and administrative purposes. For the first time, technology is enabling the emergence of a new global mindset in interaction and collaboration among institutions, health professionals and providers, healthcare users and entrepreneurs. While e-Health has the potential to deliver high-quality and cost-effective solutions for diverse population needs in Primary Healthcare, address ever growing consumer demand, and improve health and healthcare in underserved areas and low- and middle-income countries, it still faces important challenges, such as interoperability and scalability.

Aim

Our workshop aims to provide a networking and experience-sharing platform, enabling participants to outline resources and present solutions they have used in their own circumstances and contexts. It will also provide a platform for participants to seek potential partners and opportunities.

Methods

The session will begin with a series of small presentations, outlining available resources that can be used for the

development of innovative applications, and showcasing the impact of examples of e-Health implementation on healthcare. To inspire participants, examples of challenges and areas in need of disruptive applications will be outlined. Participants will be invited to present an insight into their own solutions from a multi-perspective viewpoint. Finally, we will facilitate matchmaking of participants with the objective of encouraging them to form partnerships in developing cross-border technology services or participating in European projects.

Expected Outcomes

Participants will have the opportunity to reflect on the impact of e-Health on their own practice and the lives of their patients, and harness ideas on the feasibility of potential solutions and available resources. The session will also provide participants with a powerful networking opportunity that will facilitate knowledge sharing and the development of new partnerships.

Keywords: e-Health, m-Health, Computer-Assisted Instruction, Social Media, Technological Innovation, Telemedicine

WS-114

Approach to the patient with abnormal blood cell count in primary care

Leonor Troni¹, Vanessa Carvalho², Ieda Paula²

¹UCSP Torres Vedras, ACES Oeste, Portugal

²USF Cynthia, ACES Sintra, Portugal

Justification of and interest in the workshop

Complete blood cell count (CBC) is one of the most common laboratory tests in medicine. 10% to 20% of results are reported as abnormal. Therefore, it is in every clinician's interest to have some understanding of the specific test basics as well as a structured action plan when confronted with abnormal CBC results

This workshop will discuss abnormalities of the complete blood count (CBC), highlighting the work-up and management of patients at primary care level along with indications for referral.

It is an interactive session whereby participants will discuss the red flags in CBC through different case scenarios and they will learn new tips for identifying hidden diagnosis behind an abnormal CBC.

Learning goals

At the end of this workshop, participants will be able to:

- know the limitations of reference ranges for the CBC
- improve history taking and clinical examination
- address frequently encountered conditions associated with CBC abnormalities including anemia, thrombocytopenia, leukopenia, polycythemia, thrombocytosis, and leukocytosis.
- determine the role of medication
- know indications for referral.

Methods

The workshop is designed to be interactive with questions built into the program. There will be brief overview of the theme, case-based interactive discussion, role playing and video playing. In the end there will be a summary and 'action plan' to promote competency in hematological disorders

Expected impact on the participants

Help the nonhematologist recognize when a subspecialty consultation is reasonable and when it may be circumvented, thus allowing a cost-effective and intellectually rewarding practice

Keywords: Blood cell count, management, primary care

WS-115

What's in a name? General Practice or Family Medicine?

Carl Steylaerts¹, Berk Geroglu²

¹WONCA Europe

²Izmir Tepecik Training and Research Hospital, Family Medicine Clinic.

In this workshop, we use the technique of the Iceberg Model of Sohail Inayatullah to understand the resistance against changing names, even if they mean almost the same thing.

In his model, Inayatullah discovered 4 layers, hence the name Causal Layered Analysis:

1 The Litany – a complaint or a series of complaints, sometimes creating a politics of fear

2 Social Causes – that can explain the complaints; often detected by academics, who then formulate a remedy

3 Deeper level: discourse/worldview with a stakeholder level, the ideological, civilisational and epistemological level

4 Myths and beliefs, metaphors and collective archetypes

The remedy offered by academics is often failing for they didn't look at the deeper levels.

We will try to demonstrate this in this workshop, offering a classic black-and-white discussion and an alternative one, aimed at the future.

General Practitioner or Family Physician? This workshop is part of a series of workshops aimed at introducing Futuristic Thinking as evidence based as possible.

Keywords: Future; family medicine; general practice;

WS-116

Who to inform? How to manage the cancer diagnose?

Özden GÖKDEMİR¹, Ülkü Bulut², Olgu Aygün³, Seval Yaprak¹, Hadiye Küçükkaragöz⁴, Dilek Güldal¹

¹Dokuz Eylül University, Medical Faculty, Family Medicine Department, İzmir, Turkey

²Balçova Public Health Center, İzmir

³Karabağlar Family Health Care Center, İzmir

⁴Dokuz Eylül University, Institute of Education Sciences, İzmir, Turkey

"Bad news" has been defined as any information which adversely and seriously affects an individual's view of his or her future; whether news is bad or not can only be in the eye of the beholder. "Cancer diagnosis" is one of them. To manage patient and caregiver is one of the responsibility of General Practitioner/Family Physician. The primary therapy of the patients whom diagnosed as cancer is a team work of GP/FP, psychiatrists, surgeons, medical oncologists and/or radiation oncologists. However, in the longer term, in clinical practice follow-up of outpatient who does not know diagnose could cause many difficulties. Therapy delays, communication problems, especially in advanced stages of the cancer are main obstacles. Structure of breaking bad news may change depending on the age, sex but mostly it is a cultural issue both of the patient and doctor. Breaking bad news well is an essential skill for all doctors, however the question is "who to inform?" "how to inform" and "to what extend to inform"

Methods

We will use an interactive approach for this workshop. Presenters will alternate clinical cases and more theoretical points as medical and the legal parts. Some caregivers don't want the patient to inform and some patients do not want to inform their families. To manage this issue by protecting time and legal points motivational interviewing techniques will be held during the workshop.

The incidence of patients who are diagnosed "cancer" are growing higher. GPs should not avoid from "breaking bad news", this seems to be a part of daily practice. The topics are

1. Physicians recognize themselves
2. Understand the Patient
3. How to approach different types of the patients
4. Ethical and legal issues

The results will be presented as a declaration.

Keywords: breaking bad news, cancer diagnose, follow-up of cancer patients

WS-117

How to Prepare For A Pandemic – PREPARE PG Course, Part I

Zalika Klemenc Ketis¹, Anna Stavdal², Mehmet Ungan³

¹Department of family medicine, medical school, university of maribor

²Oslo university department of family medicine

³Ankara university school of medicine department of family medicine

Infectious diseases contribute to high morbidity and mortality across the globe due to their nature of spreading through populations and due to varied susceptibility of individual patients. Mass vaccinations, public health measures, general awareness in keeping hygienic measures, modern diagnostics and treatments made a progress in infectious disease control and management. Many infectious diseases became officially eradicated or localised. However, in a globalised community any outbreak in any region of the world is actually an outbreak of the doorstep of any country or any practice. International travel needs less than 24 hours to ship pathogens around the globe. Large migrations due to war conflicts or economic reasons bring nearly forgotten infectious diseases which can be spread among new populations. Besides this, absence or low vaccination rates in these migrating groups present a public threat in the countries with longstanding control over infectious diseases. Preparedness to act in an outbreak of an infectious disease with a potential to spread quickly among the population served. Family physicians in many countries present the first line clinicians who might face a challenge of emerging outbreak of an infectious disease which can evolve in an epidemic or even a pandemic. Recent history tells us how quick a stable situation in infectious disease control can break down. This course will bring some key information on how to approach these challenges from human and biomedical perspective. The participants will have the opportunity to learn from experts in the field of anthropology, microbiology and family medicine and to discuss primary care role and responsibility in infectious diseases control and possible pandemic.

Keywords: Pandemic

WS-118

How to Prepare For A Pandemic – PREPARE PG Course, Part II

Ronnie Moore¹, Zalika Klemenc Ketis², Anna Stavdal³

¹Department of family medicine

²Department of family medicine, medical school, university of maribor

³Oslo University Department of family medicine

Infectious diseases contribute to high morbidity and mortality across the globe due to their nature of spreading through populations and due to varied susceptibility of individual patients. Mass vaccinations, public health measures, general awareness in keeping hygienic measures, modern diagnostics and treatments made a progress in infectious disease control and management. Many infectious diseases became officially eradicated or localised. However, in a globalised community any outbreak in any region of the world is actually an outbreak of the doorstep of any country or any practice. International travel needs less than 24 hours to ship pathogens around the globe. Large migrations due to war conflicts or economic reasons bring nearly forgotten infectious diseases which can be spread among new populations. Besides this, absence or low vaccination rates in these migrating groups present a public threat in the countries with longstanding control over infectious diseases. Preparedness to act in an outbreak of an infectious disease with a potential to spread quickly among the population served. Family physicians in many countries present the first line clinicians who might face a challenge of emerging outbreak of an infectious disease which can evolve in an epidemic or even a pandemic. Recent history tells us how quick a stable situation in infectious disease control can break down. This course will bring some key information on how to approach these challenges from human and biomedical perspective. The participants will have the opportunity to learn from experts in the field of anthropology, microbiology and family medicine and to discuss primary care role and responsibility in infectious diseases control and possible pandemic.

Keywords: Pandemic

WS-119

Educational Family Health Center Integrated to an University Implementation and Research Center

Kurtuluş Öngel¹, Gülseren Pamuk¹, Güney Aktaş²

¹İzmir Katip Çelebi University, Faculty of Medicine, Department of Family Medicine

²İzmir Katip Çelebi University, Health Implementation and Research Center

Year 1997... The first year that I began to Family Medicine specialist programme. Family Medicine was developing in our country. In the medical specialty exam; I would choose this speciality programme as the first and only choice with observing international practices. 3 years of the residency programme was passing through all the processes of hospital rotations...

Year 2010... Related with the decisions taken by the Board of Medical Specialties; half within three years of the Family Medicine residency programme was left to the main department. Extracting departments and clinics are configuring their own clinics. However, many of the clinics can't configure space for clinical applications to this structure because of different reasons. As known; family medicine residency training are given with a curriculum including clinical rotation and field training by the academics in European Union countries. This education in our country, in order to implement without deviation from the normal way, educational health centers were established integrated to Izmir Katip Celebi University Health Implementation and Research Center with difficulties along... What is our trouble?

Keywords: Family health center, education, rotation

WS-120

Family Medicine Residency Training in Primary Care Settings: Family Health Centers for Teaching

Tolga Günvar¹, İsmail Hamdi Kara², Serap Çiççili³, Okay Başak⁴

¹MD, Associate Professor of Family Medicine – Dokuz Eylül University Faculty of Medicine, Department of Family Medicine – Izmir

²MD, Professor of Family Medicine, Duzce University Faculty of Medicine, Department of Family Medicine – Düzce

³MD, Associate Professor of Family Medicine – Marmara University Faculty of Medicine, Department of Family Medicine – Istanbul

⁴MD, Professor of Family Medicine – Adnan Menderes University Faculty of Medicine, Department of Family Medicine – Aydın

Background

Family medicine residency training consists of three basic pillars: Rotations in hospital and other health care facilities, educational activities in family medicine departments and training in primary care settings. Between 1985 and 2011, formal residency training was consisted only of hospital rotations. With the rapid growth of family medicine departments in universities and clinics in research and training hospitals since 1995, educational activities of departments have increasingly been an important part of residency training. In 2011, with the acceptance of new core curriculum by TUK (Specialty Board in Medicine) obligatory rotations were decreased to 18 months. After a long term effort, necessary regulatory changes have been made to enable residency training in primary care.

Although valuable contributions have been made by Turkish Association of Family Physicians (TAHUD), Turkish Board of Family Medicine (TAHYK) and Academy of Family Medicine residency training in primary care settings is still needed to be discussed and clarified.

This workshop is aimed to discuss residency training in primary care settings with multi-dimensionally.

Methods/Program

- Presentation: Family Medicine Residency Training in Primary Care Settings (Okay BAŞAK)

- Group Works:

- o Group 1: Methods of Education and Assessment in Family Medicine Residency Training in Primary Care Settings

- o Group 2: Potential Problems in Family Medicine Residency Training in Primary Care Settings: How Do We Balance Education and Patient Care?

- o Group 3: Perspective of Primary Care Physicians, Integration of Academy to Primary Care Setting
- Group Presentations
- Discussion

WS-121

Family Medicine Practice Beginning And Population Assessment Guideline

Aysel Bařer¹, Giray Kolcu²

¹řemikler Family Medicine Centre no. 7 in Karřıyaka, İzmir

²Ulurmak Family Medicine Centre no. 12 in Karatay, Konya

In family medicine practice, there might be changes of duty for several reasons or Family Physicians can be assigned to newly opened Family Medicine Centres. Both the physician and the patients are affected negatively by such adaptation period in the family medicine branch where the relation between the physician and the patient is quite intensive. Moreover, not causing the patients to suffer during transition periods is also important in terms of the sustainability of healthcare services quality. A physician who has started to serve for a new population should become familiar with that population soon. Physicians should adapt to the population and become familiar with that population with an appropriate model in order to facilitate and accelerate such process.

We aimed to compile a guideline which will ease the orientation of the physicians started to family medicine practice to their population.

What about sharing your knowledge and experiences in this matter with us and contributing to our guideline?

Keywords: Family Medicine, Demography, Guideline, Quality

COURSES

Course-001

All About Inhalers

Jaime Correia De Sousa¹, Svein Høegh Henrichsen², Ioanna Tsiligianni³

¹Associate Professor Community Health, School of Health Sciences, University of Minho, Portugal

²IPCRG representative for WONCA-Europe. Oslo, Norway

³Asites Rural Practice and Clinic of Social and Family Medicine, University of Crete, Greece

A workshop presented by the INTERNATIONAL PRIMARY CARE RESPIRATORY GROUP (IPCRG)

Metered dose aerosol inhalers (MDIs) and powder inhalers are the basis of the bulk of treatment for asthma and COPD, It is important to choose the right inhaler to provide optimum medication delivery.

This workshop will include the use of metered dose aerosol and powder inhalers. Poor inhaler technique is a common cause of failure to achieve therapeutic control in asthma therapy, and much can depend on the type of inhaler prescribed as well as its actual use.

Keywords: Inhaler, MDI, asthma, COPD

Course-002

Spirometry Made Easy

Miguel Román Rodríguez¹, Jim Reid²

¹IB-Salut. Balearic Health Service, Palma de Mallorca, Spain

²University of Otago, Dunedin, New Zealand

A Workshop presented by the INTERNATIONAL PRIMARY CARE RESPIRATORY GROUP (IPCRG)

Spirometry is an essential component of adequate respiratory workup. It is able to differentiate between obstructive and restrictive respiratory disease, as well as recognise the difference between asthma and COPD. This workshop will include basic physiology and cover the “art” of obtaining accurate spirometry, technique, common spirometric patterns, and issues leading to errors.

Keywords: Spirometry, asthma, COPD

Course-003

How to start and manage insulin therapy in primary care - PCDE Workshop

Mehmet Sargin¹, Frances Xavier Cos²

¹Department of Family Medicine, Diabetes Division, Lütü Kirdar Kartal Training and Research Hospital, Istanbul, Turkey

²CAP Sant Marti de Provençals Unit of Ensayos Clinics – University of Barcelona -Institut Investigacio Universitari Atenció Primaria Jordi Gol, Barcelona, Spain

PURPOSE: It is well known that insulin therapy is a difficult point in the treatment of Type 2 diabetes. Patients as well as health professionals (nurses and GPs) might not feel comfortable with this therapeutical option, though often necessary when T2DM people live longer and hence are in need for more advanced and complex treatment plans. In the past decade, we were seized by an “algorithm storm” of hyperglycaemia treatment schemes. The European Association for the Study of Diabetes (EASD), the American Diabetes Association (ADA), the National Institute of Clinical Excellence (NICE) and a lot of other (inter)national medical associations have published their guidelines including insulin algorithms based on the best evidence available. Despite differences, all algorithms largely agree to recommend when and how to start with an Insulin regimen.

METHOD: This is a 2 hours workshop that through a case discussion would like to introduce the most common

difficulties when considering Insulin as a therapy option. The idea is to answer practice based questions regarding insulin therapy following a pedagogical model focused on clinical situations. How to recognize patients who need insulin (at diagnosis of type 2 diabetes, as a stepwise approach with worsening glucose control, and during an acute process). What kind of insulin molecules do we have available on the market? What are their differences and how to use them? What is the best and easiest way possible to start insulin therapy?

EXPECTED OUTCOMES: After this workshop the attendees will: know the indications for initiation of insulin therapy (who?); know how to initiate insulin therapy (how? Initial dose, titration, etc.); know how to follow up a patient on insulin (glycaemic target values, combination with other hypoglycaemic therapy options, side effects: hypoglycaemia, weight gain etc.); know red flags for referral (emergencies).

Keywords: insulin therapy, dose titration, initiation, follow-up

Course-004

A glance to the treatment options of osteoarthritis: old and traditional, new and challenging

Ülkü Sur Ünal¹, Sabah Tüzün², Serap Çifçili¹

¹Department of Family Medicine, Marmara University, Istanbul, Turkey

²Department of Family Medicine, Dr. Lütfi Kırdar Kartal Training and Research Hospital, Istanbul, Turkey

Justification

Vast part of the primary care patient population consists of patients with osteoarthritis. In a study conducted in Turkey; knee, hand and total osteoarthritis prevalence is reported as 5.351%, 1.11% and 8.42% respectively. As treatment options, there are painkillers used as symptom modifiers. But in recent years, new treatment options are tried to be developed for osteoarthritis and physical exercises are proved to be effective for patients to reduce the pain. In this workshop, the aim is to improve the physicians' knowledge about the new treatments for osteoarthritis and review the drug therapy and the physical exercises that can be suggested to the patients interactively.

Content

The session will start with a brief presentation about diagnostic criteria and traditional treatment options of osteoarthritis. Then each participant will be given an abstract about new treatment options of osteoarthritis and be asked to read them in 10 minutes. Afterwards these new treatment options will be discussed in terms of which of them can be applied and may be helpful as symptom or disease modifier. In the second part, the physical exercises offered for osteoarthritis will be reviewed in the light of current evidence, which can be suggested to the patients to perform. There will be mats for each participant who is willing to learn the exercises with the workshop moderators, serving the purpose of learning the exercises. The workshop will come to an end with a brief summary and asking the participants to give feedback.

Keywords: osteoarthritis, drug therapy, rehabilitation

Course-005

Panic attacks... the 10 minute solution

Enda Murphy, Patrick Paddy Halligan, Kandan Loganathan
Health Service Executive, Ireland

Cognitive Behaviour Therapy (CBT) is the best evidenced based approach recommended by the National Institute for Clinical Excellence (NICE) in the treatment of anxiety and panic attacks.

CBT is ideally suited to GP and Primary Care practice as it provides a proven method of psychological therapy that can be easily learned and applied within the constraints encountered in today's health care service.

Therefore, panic attacks can easily treated by GP's with a simple combination of low intensity CBT interventions and support.

This presentation aims is to introduce to GP's a low Intensity CBT skills programme, which was developed in Ireland and has been very successful in providing appropriate interventions for the treatment and management of panic attacks in primary care

Participants are invited to bring along case histories for discussion regarding diagnosis and treatment with the author both at and after the workshop.

Keywords: Panic Attacks, CBT, Cognitive Behaviour Therapy

Course-006

Insertion of the levonorgestrel intrauterine system in family practice

Zeynep Tuzcular Vural, Işık Gönenç

Haydarpaşa Numune Training And Research Hospital Family Medicine Department

Justification: The levonorgestrel intrauterine system (LNG-IUS) is a reliable and effective contraceptive method with many non-contraceptive benefits. The LNG-IUS offers the advantage of reduced menstrual bleeding (both in duration and amount) and lowers the risk of anaemia, ectopic pregnancy, and PID. The LNG-IUS has been successfully used in the treatment of menorrhagia, dysmenorrhoea, and endometriosis. Studies show that it is a safe method with few side effects. The LNG-IUS can be used up to 5 years before replacement. Insertion can take place at any time during the menstrual cycle providing the woman is not pregnant. It is the duty of the family physician to provide individuals with suitable contraceptive methods and apply them. However, many primary care physicians/family physicians are intimidated with the idea of applying the LNG-IUS because it requires skills which differ from applying a copper IUD.

Content: The objective of this workshop will be to learn/revise insertion techniques for the LNG-IUS and remember practical issues concerning insertion such as sterile insertion techniques, contraindications, necessary equipment for insertion and patient preparation. Before insertion, a bi-manual examination and sounding the uterus is necessary to determine the uterine position and the depth of the uterine cavity. Methods will include bi-manual examination and sounding the uterus on a pelvic model and insertion of the LNG-IUS. Participants will also discuss their experience with the LNG-IUS.

Keywords: levonorgestrel intrauterine system, contraceptive method, insertion, LNG-IUS

Course-007

Insertion of copper IUD's in family practice

Işık Gönenc, Zeynep Tuzcular Vural

Haydarpaşa Numune Training And Research Hospital Family Medicine Department

Justification: Copper intrauterine devices (Cu IUD) are small, "T-shaped" devices inserted into the uterus to prevent pregnancy. They are safe, effective, and long lasting contraceptive methods with few side effects. The copper T 380 A can be used up to 10 years before replacement. Insertion can take place at any time during the menstrual cycle providing the woman is not pregnant. It is the duty of the family physician to provide individuals with suitable contraceptive methods and apply them. However, many primary care physicians/family physicians are intimidated with the idea of applying the copper T 380 A because it requires equipment and insertion skills.

Content: The objective of this workshop will be to learn/revise insertion techniques for applying the copper T 380 A and remember practical issues concerning insertion such as sterile insertion techniques, contraindications, necessary equipment for insertion and patient preparation. Before insertion, a bi-manual examination and sounding the uterus is necessary to determine the uterine position and the depth of the uterine cavity. Methods will include bi-manual examination and sounding the uterus on a pelvic model and insertion of the copper T 380 A. Participants will also discuss their experience with IUD's.

Keywords: Copper intrauterine devices, contraceptive methods, insertion

Course-008

Myths, Misconceptions and Facts on Contraception

Vera Pires Da Silva¹, Sara Rigon², Ula Chetty³

¹GP Resident at USF Ramada, Lisboa, Portugal

²GP, Bologna, Italy

³GP, Glasgow, Scotland

Justification:

It has been proven that contraception can save lives and does improve health. However, contraception is also commonly associated with myths and misconceptions, leading to misunderstandings amongst women regarding its uses and benefits. It is important for doctors to be aware of patients' beliefs concerning contraception in order to better understand patients' fears and provide counseling for each woman to choose the most appropriate contraceptive method.

Contraception can be an issue for health professionals as well. One of the commonest concerns amongst GPs regards inserting contraceptives devices, as IUD's and implant and the required technical skills which may lead to a specialist or a more expert colleague referral. Therefore, it is equally important to address doctors' fears and misconceptions towards contraceptive technical skills.

This workshop aims to approach myths and misconceptions on contraception and oppose them with facts based on evidence for both patients and doctors.

Content:

During the workshop we will initially address some common myths and misconceptions on contraception; for example "contraception makes people fat", "contraception causes infertility", "contraception leads to ovarian cancer" and many others. Participants will subsequently have the opportunity to discuss and share their experiences based on knowledge and their professional practice.

Finally to disprove the common misconception that inserting contraceptive device requires specific technical ability we will demonstrate these simple procedures. Participants will have the opportunity to practice on three-dimensional medical simulator devices (which mimic female anatomy). Colleagues should leave the workshop with a better understanding of patients' concerns on contraception and new confidence on implant and IUD insertion.

Keywords: Contraception, Women's Health, Primary Care Health Physicians

Course-009

Basic Ultrasonography Course: Method and Practice of Ultrasonography in Primary Care

Erdoğan Yavuz¹, İsmail Hamdi Kara², Mehmet Halis Tanrıverdi³, Bahri Yıldız⁴

¹1st Family Healthcare Center, Rize, Turkey

²Düzce University Faculty of Medicine Department of Family Medicine, Düzce, Turkey

³Dicle University Faculty of Medicine Department of Family Medicine, Diyarbakır, Turkey

⁴Uludere State Hospital Şırnak, Turkey

Primary care physicians are discovering the value of ultrasound visualization in quickly assessing, diagnosing, and determining treatment options for their patients at the point of care. There is a growing expectation among patients that the diagnosis and management of their symptoms and disease are primarily addressed in their physician's office. This expectation leads physicians to seek better diagnostic tools in their daily clinical routine. We aimed to present a training course for this purpose.

This course is planned as a one-day work including theoretical and practical training. Our proposed course schedule is as follows:

09:00-09:15 Fundamentals of diagnostic ultrasonography- Erdoğan Yavuz

09:15-10:00 Oral presentation: Introduction to Thyroid Ultrasound - İsmail Hamdi Kara

10:00-10:45 Oral presentation: Introduction to Abdominal Ultrasound- Mehmet Halis Tanrıverdi

10:45-11:30 Oral presentation: Introduction to Pelvic Ultrasound- Bahri Yıldız

13:00-14:00 Practical training: Thyroid Ultrasound - İsmail Hamdi Kara-Mehmet Halis Tanrıverdi-Bahri Yıldız

14:00-15:00 Practical training: Abdominal Ultrasound- İsmail Hamdi Kara-Mehmet Halis Tanrıverdi-Bahri Yıldız

15:00-16:00 Practical training: Pelvic Ultrasound- İsmail Hamdi Kara-Mehmet Halis Tanrıverdi-Bahri Yıldız

Keywords: ultrasonography ultrasound primary care

Course-010

Difficult to Manage Asthma

Umut Gök Balcı¹, Arzu Yorgancıoğlu², Jaime Correia De Sousa³, Kurtuluş Öngel⁴, Ümit Aydoğan⁵, Dursun Çadirci⁶, Fatma Gökşin Cihan⁷, Hüseyin Elbi⁸, Yasemin Şimşek⁹, Seda Coşkun¹⁰

¹Department of Family Medicine, Tepecik Research and Training Hospital, İzmir, Turkey

²Department of Chest Diseases, Medical Faculty, Celal Bayar University, Manisa, Turkey

³Department of Community Health, Life and Health Sciences Research Institute, School of Health Sciences, University of Minho, Minho, Portugal

⁴Department of Family Medicine, İzmir Katip Celebi University, İzmir, Turkey

⁵Department of Family Medicine, Gulhane Military Medical Academy, Ankara, Turkey

⁶Department of Family Medicine, Harran University Faculty of Medicine, Sanliurfa, Turkey

⁷Department of Family Medicine, Necmettin Erbakan University, Faculty of Medicine, Konya, Turkey

⁸Department of Family Medicine, Celal Bayar University, Manisa, Turkey

⁹Department of Family Medicine, Tepecik Research and Training Hospital, İzmir, Turkey

¹⁰Department of Family Medicine, Ankara Research and Training Hospital, Ankara, Turkey

Difficult to manage asthma is asthma that either the patient or the clinician finds difficult to manage. A patient with difficult to manage asthma has daily symptoms and regular exacerbations despite apparently best treatment. Most of the healthcare professionals don't know a lot about how to review that kind of patients and the possible causes for this situation. Moreover, there are some problems about referring these patients. This course aims to gain systematic and a practical approach to primary care and

other community healthcare professionals about difficult asthma management. Course is planned as a half-day work including theoretical and practical training. Proposed course schedule is as follows:

09:00 – 09:20 What is IPCRG ?
09:20 – 09:40 What is asthma ?
09:40 – 10:00 Asthma treatment
10:00 – 10:20 Childhood asthma
10:20 – 10:40 BREAK
10:40 – 11:00 Difficult to manage asthma
11:00 – 11:20 Asthma around the world
11:20 – 11:40 Asthma in Turkey
11:40 – 12:00 Case studies

Keywords: Asthma, management, primary care

Course-011

Domestic violence. Good practice in training the trainers to deal With family violence in primary health care

Lodewijk Pas¹, Gene Feder², Sylvie Lo Fo Wong³, Carmen Fernandez⁴, Raquel Gomez⁵

¹Academic Center General Practice, Leuven University, Leuven, Belgium

²Centre for academic primary care, School of Social and Community Medicine, University of Bristol, United Kingdom

³Radboud university medical center, Dept. Primary & Community Care, Unit Gender & Women's Health

⁴SEMFyC, Gerencia Regional de Salud de Castilla y Leon, Valladolid, Spain

⁵Semfyc, Madrid, Spain

AIMS:

Demonstrate good practices training strategies followed by an exchange on how to achieve international dissemination of effective training.

METHODOLOGY:

Background of training methodology and practical exercises will be provided. Presentations will alternate with an equivalent time with practical exercises from different international training projects.

Programme:

9.00-9.45. About teaching, learning and its effects on family violence care. Leo Pas (Belgium).

Essential elements of an effective training methodology will be summarised. It will highlight using an interactive experience based learning exercises and show how principles of gaming can be used for attitude building.

9.45-10.35. Increasing identification and referral in primary care of women experiencing domestic violence: the IRIS model. Gene Feder (University of Bristol, UK).

The IRIS training and support programme for family practices, based on a randomised controlled trial, has now been commissioned in 32 areas in the UK. It has also informed the ongoing European Daphne-funded IMPLEMENT project, coordinated by WOMEN AGAINST VIOLENCE EUROPE (Austria). Training exercise: how to ask about family violence.

10.35-10.45 coffee break

10.45-11.35 Training responding in daily practice. Sylvie Lo Fo Wong, Toine Lagro-Janssen (Nijmegen University, NI).

Keywords: IRIS

Course-012

Introduction to Homeopathy

Günnur Şerife Başar¹, Levent Hekimoğlu²

¹Homeopathy Association, Istanbul, Turkey

²Bursa İhsaniye Family Practice Center, Istanbul, Turkey

The topics

The short history of Homeopathy, its principles and efficacy

What is Homeopathy? Why is it named like this?

The basic principles of Homeopathy

Who developed homeopathy

The first clinical trials

What is health? What is cure?

The difference between chronic and acute diseases

Homeopathic remedies

Homeopathic Literature

The safety and efficacy of homeopathy

Homeopathy is a natural treatment using natural principles leading a total cure of organism by means of natural substances. Homeopathy is a holistic treatment acting not only on physical level but also on emotional and mental levels of organism. The main principles of homeopathy were developed by a German physician namely Dr. Samuel Hahnemann approximately 250 years ago. He claimed that the cure should be rapid, gentle, permanent and without any side effect.

Homeopathy treats every human being as a unique organism not as a sum of separate organs and tissues on contrary of conventional medicine. The homeopathic remedies are produced according to those principles and it acts each level of human organism in deeper levels as well as physical level.

They produce symptoms in healthy subjects and cure those symptoms when they are observed in a diseased state. That's why it is called "similar cures similar". But the aim is not to suppress the symptoms as it is done by conventional medicine, on contrary they strengthen the organism, the optimum balance and cure is reestablished in the body through the knowledge of disease and symptoms in the same way as Nature does.

Usually the homeopathic remedies are easy to use and harmless even when they are wrongly prescribed. That's why homeopathy is the best known and largest used alternative medicine all over the world. It is recognized by WHO as well as by health authorities of Turkey recently.

Keywords: homeopathic

Course-013

Short Pediatric Musculoskeletal Examination Technique in Primary Care: PGALS (pediatric Gait, Arm, Leg, Spine)

Demet Merder Coşkun¹, Özge Keniş Coşkun², Evrim Karadağ Saygı²

¹Haydarpaşa Numune Education and Training Hospital, Family Medicine clinic, Istanbul, Turkey

²Marmara University Faculty of Medicine, Department of Physical Medicine and Rehabilitation, Istanbul, Turkey

AIM:

Clinical studies has showed that musculoskeletal system was the least examined body system in pediatric patients in both primary care and emergency setting. This studies also showed that health care workers were in lack of knowledge and confidence on pediatric musculoskeletal examination. Lack of konowledge and confidence on this issue has been emphasized that due to lack of resources about this issue in textbooks, undergraduate and postgraduate medical education. This workshop was designed to increase the knowledge and skills of primary health care workers on pediatric musculoskeletal examination.

Content:

In the beggining of the workshop all participants will be asked to complete the questionnaire which assesses their level of knowledge and competence about pediatric musculoskeletal examination. After a given brief presentation about importance of pediatric musculoskeletal examination in primary health setting, all participants will be asked to share their experiences in this regard. Afterwards another brief presentation about pediatric musculoskeletal development and follow up visits in primary care will be performed. Then the short pediatric musculoskeletal examination technique pGALS (pediatric Gait, Arm,Leg, spine will be shown practically. All participants will be asked to practice the technique. Applicability of the technique in daily practice will be asked to be evaluated by all participants. In the end of the workshop all participants will be asked to complete the questionnaire which assesses the impact of the workshop to their level of knowledge and competence about pediatric musculoskeletal examination.

Keywords: Pediatri, kas-iskelet sistemi, muayene becerisi, pGALS

BRITES

BR-001**Self-care in diabetes mellitus, a challenge in primary care**

Firdous Jahan

Oman medical college

Justification:

In the Arabian Gulf countries, we are facing a huge challenge with a increase in the prevalence of diabetes. In 2000, the age-adjusted prevalence of diabetes among Omanis aged 30–64 years reached 16.1% compared with 12.2% in 1991. Diabetes treatment and its complications will soon consume most of its national health care budget. To prevent serious morbidity and mortality, diabetes treatment requires dedication to demanding self-care behaviors in multiple domains, including food choices, physical activity, proper medications intake and blood glucose monitoring

Content:

Oman has one of the best primary care services in the world. I have been working more than 3 years now in Oman. One thing which is very distressing is that Omani patient do poorly with self-care in diabetes. We have started a group discussion with our patients and their relatives once a month.

This helped us somehow but how can we change the perception and motivate our patients to take care of themselves?

Keywords: diabetes mellitus, self care, primary care

BR-002**Primary Care of Adults with Intellectual and Developmental Disabilities**

Ian Casson

Department of Family Medicine, Queen's University, Kingston, Canada

Justification:

I find it challenging to accomplish high quality primary health care for adults with intellectual and developmental disabilities (also known as learning disabilities in the United Kingdom) in my family practice. Communicating effectively, obtaining consent, accomplishing adequate physical exams, even recognizing those with mild or borderline intellectual disabilities - these are among the issues that take extra time, assistance, and, probably, systematic approaches to solve. Guidelines¹ are available but seem hard to implement.

Content:

I would appreciate the opportunity to discuss these and other issues in the care of adults with intellectual and developmental disabilities with family physicians from other countries to better understand the issues and possible solutions.

Keywords: intellectual developmental disabilities, family practice, adults

BR-003**Chronic Patient Management in General Practice**

Anbreen Slama Chaudhry

Medical Education & Training Services, Fribourg, Switzerland

Patients suffering from chronic diseases often need to visit their general physician. The care of chronic patient is complex due to the presence of several concomitant illnesses, numerous treatments, and the need to coordinate care with other specialists.

How to be performant in the care of chronic patients, within a limited time frame, a set of issues to be discussed, keeping an essential time for physical examination, prescription time, and taking notes or filling the patient record time? How to maintain a quality patient-doctor relationship along with best practices? Management of the time in the consultation is a key issue, as well as managing its structure.

Planning the issues to be discussed and allowing patients to express their concerns might help. The specificity of chronic diseases is that major part of the care is provided by the patient himself. Therefore, Patient Education seems to be interesting in many ways: it allows patients to understand better the disease they are living with, to accept it and to make better health choices. It empowers them to lead their lives with (despite) their chronic conditions, and enhance their abilities of self-care. Patient Therapeutic Education needs to be provided in a collaborative way along with a nurse, other care takers, and must be integrated to the community the practice is serving, in order to better understand patient's needs. How to conciliate general physician's position of manager (working with efficiency) and educator (working with pedagogy)?

Keywords: Chronic Diseases, Patient Education, General Practice

BR-004**Clinical inertia in family medicine**

Valerija Bralic Lang

Private Family Physician Office affiliated to University of Zagreb, School of Medicine, Zagreb, Croatia

By definition, clinical inertia is failure of a health care provider to initiate or intensify therapy when indicated. Studies are mostly conducted in the USA and Canada, and in Europe in Spain and the Netherlands. They all showed widespread clinical inertia, with the percentage ranging from 30% to 68%. Clinical inertia has been assigned to both patient and physician characteristics. Some studies have linked clinical inertia to medication non-adherence, provider judgement, number of chronic conditions, severity of hypertension, and problems related to the implementation of guidelines. However, the number and complexity of factors associated with clinical reasoning within the decision making processes especially in primary care calls for a critical review of the concept. Are we inert each time when we fail to treat to target or when we prescribe without concordance with guidelines? How to make a decision in the context of uncertainty which is inherent in the practice of medicine? When is inaction appropriate? Is clinical inertia a patient- or physician-centered problem or a problem of health care systems? Do we need help?

Keywords: clinical inertia, family medicine

BR-005**Self-care in diabetes mellitus, a challenge in primary care**

Ruth Muñoz Maya

CS Don Paulino García Donas, Alcalá de Guadaíra. AGS Sevilla-Sur, Andalusia, Spain

Not long ago, an insulin dependent diabetic patient came to our consultation with bad controls of his glycemic levels. We had been barely raising insulin levels in the past five years. We then asked about diet, weight, infections, exercise, glycemic control chronology... As a result of the interview, we insisted on diet and modified insulin doses. After few consultations and quite increased doses of insulin, glycemic levels remained high. It seemed that our patient wasn't lying about his life regime - that was fine- but there was still something wrong. Our patient is in his sixties, with higher education, began insulin dependence fifteen years ago, he has no doubt about treatment and is a responsible person with good family support. He never fails his nursing consultations. What can be wrong then?

Asked again about treatment, we realized that he clearly understood how to inject insulin, but didn't rotate properly the injection places. As a result, little nodes of lipohypertrophy had appeared in his abdomen. We found them during physical examination.

After starting a proper rotation, he achieved better glycemic controls and we could diminish insulin doses again.

I think that within the self-care of diabetic patients, there is much more to teach than diet, exercise or foot care. They should know how to auto-explore other potential complications of treatment. Lipodystrophies appear even when rotations are done well in long term insulin dependent patients. It modifies insuline absorption and so does with glycemic levels, even causing serious hypoglycemia. Teaching our patients to detect lipodystrophies can improve glycemic controls and support their insuline treatment management.

Keywords: diabetes, insuline, lipodystrophy, glycemia

BR-006**Medically Unexplained Symptoms.... Treatment of Health phobias in GP Clinical Practice**

Enda Murphy

Health Service Executive, Ireland

Health phobia's and medically unexplained symptoms are one of the most frustrating consultations for GP's in practice today. This presentation will introduce a new approach developed in Ireland to change the recurring nature in these types of consultations providing a beginning, middle and end to the whole process.

Keywords: Medically Unexplained Symptoms, health phobia, CBT

BR-007**Cardiovascular Risk assessment in Hypertensive patients in primary care**

Aml Ahmed Salama

Faculty of Medicine, Family Medicine Departement, Menoufia Unversity,Egypt.

Different risk assessment tools are available to estimate the patient's 10-year risk of developing cardiovascular disease (CVD). It should be used to identify high-risk people for primary prevention. In hypertensive patient risk assessment is very important to identify the treatment options to prevent or minimize complication of the disease. Risky patients as patients with family history of ischemic heart diseases, diabetes, renal diseases and hyper-lipidmia are major contributors which should be assessed for every normal or hypertensive patient. In the primary care setting, prevention is the first aim, which could be primary prevention of the disease throughout modification of modifiable risk factors as hyper-lipidmia and smoking. Secondary prevention includes early detection for proper management and tertiary prevention which includes prevention of complications. The calculation of risk depends on the presence of risk factors as age, smoking, decreased HDL, micro-albuminurea and family history of ischemic heart diseases. End organ damage includes cardiac, Nephropathy, Peripheral arterial disease, Retinopathy and Stroke or transient ischaemic attack. According to risk assessment patients should be classified as high, middle and low risk for cardiovascular complications. Non pharmacological management of hypertension as well as medication have equal impotence in controlling hypertension and it's complication. How to educate your patient regarding his diseases, risk reduction and importance of management and follow up is the corner stone of primary care function and interest.

Keywords: Risk, Assessment, Cardiovascular, Diseases.

BR-008**Management in Primary Care**

Gerard Nguyen

Cabinet Marcel Monny Lobe, Soisy sous Montmorency, France

Rare Diseases are Rare and also Many. A specific disease by definition is rare and with 7000 Rare Diseases, the prevalence is 6 to 8% in the Community. Also Rare Diseases affect around 30 millions people in Europe. Few data exist to show the role and the effectiveness of Primary Care Practitioners. Some surveys have showed that Family Primary Care Practitioners (FPCP) played an important role in the care of Rare Diseases (RD).

FPCP see patients with Rare Diseases: 12.7 is the average number of patients with RD seen in Primary Practice. FPCP were the first to identify that « something is wrong » in 89% and established the diagnosis process in 54% of patients. They provided care in 56% of acute, 56% of continuous and 17 % of final care.

The new landscape of health care policy coming from the field of RD show some innovative issues. One of the most positive landmark is the multistakeholders cooperation in developing new tools, methodologies, procedures and frameworks in diagnosis, drug research and development, care, social services, networking and pricing and reimbursements of health technologies. FPCP Involvement is Rare.

FPCP manage common problems in real life and have a great experience of managing of many occurrence of extraordinary situations within the « patient and family centered » model. Their role in the care of patients with Rare Disease is fruitful for the physicians to access to innovative approaches, for the patients in their real life and for a community approach of care. FPCP are involved in the global patient care pathways. A call to action for an empowerment programme for an active role of FPCP will be proposed in the family ecosystem of care. Family Physicians remain the link between disease and patient centered concept of modern personalised medicine.

Keywords: rare diseases, diagnosis announcement, networking, reference centers

BR-009

Dealing with difficult situations in primary care

Camille Defranceschi

Cabinet Marcel Monny Lobe, Soisy sous Montmorency, France

Mr. M. 80 years old, with a history of ischemic heart disease and arrhythmia (AF under oral anticoagulant), chronic renal failure and COPD, complained of an increase in his dyspnea with a NYHA stage III, as well as a recent "orthopnea", an lower limb oedema and a limiting walking. Clinically, the patient had crackles at both lung bases, and major bilateral lower limb oedema

BNP was increased to 800 and Creatinin levels confirmed the worsen renal function. Mr M refused to be addressed in hospital and wished to be managed at home by his family physician.

- Do we insist by explaining and convincing Mr M to be hospitalised (hopefully in cardiology bypassing the emergency unit)?
- Are there some professional risks by managing at home?
- What is the optimal management organisation to set up?
- for the acute phase?
- for the follow up and rehabilitation phases?
- How could we rethink our practices?
- What do we advocate for an ambulatory management of difficult situations in Primary Care?

Keywords: difficult and complex ambulation management

BR-010

Anticoagulant Therapy in Primary Care

Vishal Mallusingh Baghele

Department of family medicine, Sir Ganagram hospital, New Delhi, India

Anticoagulant Therapy in Primary Care

In developing country like India, Primary care starts at primary health center (PHC) and they are mostly situated in villeges. Nearly 70 percent people live in villgaes. Refferal centres are much away from villages. Transport systems are also not good. Almost all PHC's have ECG facilities. So myocardial infarction can be easily diagnosed at PHC only. But due to lack of transport facilities, one can not even think of cardiac interventions. So anticoagulats are best agent to save life of patients in this situation.

I used anticoagulant streptokinase in MI patients during my village PHC's posting. Results were excellent. Reversal of ST segments had been seen. But at many PHC's, family physicians do not use anticoagulant due to lack of confidence. To improve health facilities at primary care, special traning regarding anticoagulant use to family physician should be given.

Anticoagulants are gold standard to prevent life in patients of MI at primary center in countries like INDIA.

Keywords: priamry care, family physician, anticoagulant.

BR-011

Primary Care Skill Mix PriSM

Paul Irving Brown

Stowhealth

Our project has transformed our traditional GP and Nurse primarycare model to a comprehensive team of health professionals working together under the leadership and guidance of the GP. This has addressed the lack of available GPs to meet demand; whilst improving the patient experience and reducing the financial costs of running the practice. Following detailed analysis of GP consultation activity in March 2014 we identified minor illness, physiotherapy, dermatology, paediatric and mental health as areas that could be delivered by a specialist other than a GP. Having spent time designing pathways and governance framework arrangements we set about recruitment and implementation.

The skill mix project involves the use of a Physiotherapist, Paediatric Nurse, Mental Health clinician and a Dermatologist who between them are providing equivalent of 18 hours of GP face-to-face clinical contact per week at a cost of 700 Euros per week. This represents an annual cost of 25,500 Euros based on 46 weeks. To deliver this service with a GP would equate to 4 GP sessions per week giving a saving to the practice of over 30,000 Euros per year, whilst at the same matching activity levels, excellent patient outcomes and helping us meet our recruitment needs. The concept of skill mix to help match supply with demand is not new in primarycare. Neither is the term consultant. However their application have always been an extension to the traditional model of delivering primarycare.

Our PRISM approach has been to turn this on its head, firmly establishing the GP as primarycare consultant, directing the care plan and utilising the skills of a much wider team of professionals. This encourages GPs to offer patients more specialist consultations that actually saves costs and improves the quality of diagnosis and referrals. In this respect we believe our findings are original.

Keywords: Primary care skill mix GP consultant acute pathways

BR-012

Using F1 technology to tackle obesity

Simon Victor Rudland

Stowhealth

Obesity is a problem that affects roughly a quarter of adults in the UK – and evidence suggests that these numbers are rising. Our experience with our Helping Health Change study with our partners at McLaren Applied Technology and Simply Health has allowed us to use Fomrula 1 technology applied to the human body using wearable devices. This has helped shape the way we empower many of our patients with weight-related conditions to make informed decisions based on accurate, factual evidence. The long-term aim is for this programme to inform the healthcare industry and demonstrate what can be achieved by bringing together diverse groups with different technical expertise to empower to people to lead an active and fulfilling life. I, as a General Practitioner would like to prescribe physical activity to my patients as the results are fantastic. How can we make this happen?

Keywords: Obesity, wearable technology, exercise, prescribed activity

BR-013

Hypertensive crisis in Primary Care

Lucio Giuseppe Granata

Specific Course in General Practice, Catania, Sicily, Italy

The finding of high blood pressure is a frequent cause of telephone medical advice or of urgent medical examination in GP's daily practice.

A large number of GPs usually manage this condition treating their patients with antihypertensive drugs, such as sublingual nifedipin, in order to obtain a quick hypotensive action.

Following the experts' opinion and literature, I am in disagreement with this procedure because it is isolated from the clinical context and because of adverse cerebral/myocardial/renal ischemia.

The correct diagnosis is the key to treat this condition appropriately.

Indeed, we should distinguish:

- 1) hypertensive emergency: hypertension with acute target organ damage (TOD);
- 2) hypertensive urgency: systolic blood pressure (SBP) >180 mmHg and/or diastolic pressure (DBP) >110, no TOD but symptoms presence (cefalea, anxiety, other);
- 3) severe asymptomatic hypertension: SBP>180 and/or DBP>110, no TOD, no symptoms.

The first circumstance must be treated immediately in the emergency department, while the other one can be managed in primary care in order to reduce inappropriate hospitalisation.

In the third case the purpose is to reduce BP in several days/weeks, as suggested by ESC guidelines, by:

- 1) starting a new therapy for "naive" patients,
- 2) verifying the compliance if already in therapy,
- 3) modifying dosage or adding new class drug,
- 4) a strict follow-up and screening for chronic TOD.

The goal in hypertensive urgency is to reduce BP in 24-48h (not in a few minutes) in order to reach the security level (<160 SBP, <90 DBP). Therapeutic strategies could be:

- 1) rest in a quiet room and give benzodiazepine if anxiety occurs,
- 2) oral ACEi (Ramipril 5-10 mg),
- 3) oral or i.m. Clonidine,
- 4) i.m. furosemide if volume overload is present,
- 5) follow the management of the severe hypertension

How would you deal with hypertensive crisis? Would you ask for specialist help?

Keywords: Hypertension, Hypertensive crisis, High blood pressure, Hypertensive urgency

BR-014**urgent cases in the primary care setting**

Patricia Mcwalter

king faisal specilaist hospital and reserach centre riyadh

I have experienced many challenges in dealing with urgent cases in our family medicine department. We are part of a large busy tertiary hospital, which accepts specialised cases from all over the country. In our primary care setting, we take care of more general cases as we see hospital employees and their eligible dependents, approximately 30,000 patients. When we need to transfer our patients to the emergency room for further management or admission, we are faced with some challenges. The ER is usually full because of limited capacity and also difficulty in finding beds for those needing admission. We therefore need to manage more urgent type situations than I would have been used to, when I worked back in the UK.

To address these challenges, the family medicine department has established a walk in clinic every day from 830am to 430pm and we try to manage as many patients as possible ourselves. There are 4-5 doctors and up to 10 nurses working there every day. We speak directly to the specialists about our more complicated cases and these patients can be seen in the walk in clinic by other teams, rather than going to ER. We also initiate therapy and organise investigations for patients prior to going to the Emergency Department, to ease the pressure on the ER staff. We have also established a fast track clinic in the evening run by the family physicians and less ill patients are transferred from ER to be seen here.

I have adapted to the challenges of urgent care management through good team work with my colleagues in our department and also close liaison with colleagues from other departments. A new ER department will soon open with greater capacity.

Keywords: uregent care, primary care, family physicians, emergency room

BR-015**Brite: Obesity Title: Tackling childhood obesity in Primary care**

Clare Wilson

Severn Deanery UK

One of the biggest challenges for me is to try to identify overweight children and address this in a sensitive way with them and their parents. There is the risk of alienation and causing offense versus the longer term health risks to the child and setting a pattern for life. I felt able to do this if a child was presenting with a weight or diet related issue but opportunistic discussion is difficult to initiate with few management options available to help. I took the opportunity to do a height and weight check on a child presenting with another issue, but how do you bring up the issue of obesity with a child and their parents and what resources do you have available to help support them?

Keywords: Brite Obesity childhood address solution

BR-016**Use of complementary medicine in geriatric population**

Firdous Jahan

Oman medical college

Justification:

This rise of the aging population has had an impact on the practice of medicine, as the unique needs of the elderly require the presence of a multidisciplinary and comprehensive medical approach. Complementary and alternative medicine (CAM) is growing very fast and the use of CAM in geriatric population as self-medication is rapidly evolving. CAM is a broad domain of healing resource to improve the quality of life and can be a valuable addition to the chronic pain management plan. CAM is mainly used as self-medication patients' own beliefs, and the wish for more control over one's own health.

Content:

Oman has one of the best primary care services in the world and having a special screening and follow up clinic for geriatric population. One problem we are facing that most of them they are using some kind of herb as traditional medicine. We have started taking history of CAM in our routine consultation and counseling them. This helped us somehow but how can we change the perception and motivate our patients not to take any medication without doctor's advice?

Keywords: Geriatric, complementary medicine, self medication

BR-017**Prevention in Elderly People: Challenges in Daily Family Practice**

Hakan Yaman

Department of Family Medicine, Akdeniz University, Antalya, Turkey

Family practice provides a family life-cycle approach and considers any special problem at any stage of the cycle. The post-parenthood and dissolution stages are challenging aging people and their families very much. Family physician play a crucial role while providing preventive and curative services and coordinative and advocacy tasks are also demanded during that period. This is an important challenge for the family physician, even (s)he is and "healing doctor" and has an "family-orientation" low resources, time demand, factors beyond the "office walls" are an impairment for concrete solutions. "Aging-friendly Primary Health Care" solutions need to be developed to overcome this challenges. Family physicians are in need of guidelines and tools and additional resources to help elderly people, who are in increasing demand of health and care services in community. Coordination between different stakeholders in community need to be established.

Keywords: Prevention, elderly care, family physician

BR-018

How can we establish positive communication with the caregivers in home care visits?

Hasan Hüseyin Şahin

Department of Family Medicine, Marmara University School of Medicine and Hospital, Istanbul, Turkey

In Family Medicine as we all know, one of our aims is providing a good care to homecare patients. Homecare has lots of difficulties for part of family medicine to make a qualified care. We make routine visits to most of our home care patients. We know that most of them are dependent to bed, have many limitations in daily life activities. In this case caregivers are our important partners during health care services. So family physicians need to communicate with caregivers instead of patients themselves. In Istanbul, Turkey; previous studies from our department shows that 96% of homecare patients have caregivers. 65% of them are living with their children; 19% with wife and at least one child; 12% with their spouses and only 3% alone. Of the caregivers 37% are their daughters; 35% are daughter in law; 16% are their spouses; 3% sons; 3% re formal caregivers. This situation takes us into another area of homecare. Beyond the patients, new difficulties that we face are to communicate with caregivers; to provide health education, and to make decisions together for the sake of the patient and maintaining proper condition. Other than physical examination of patients and treatment of illnesses, sometimes it becomes really difficult to understand the needs of the caregivers, making decisions together, speaking a common, clear but culture sensitive language. This becomes a time consuming procedure but on the other hand it is impossible to improve homecare despite the caregivers. Furthermore, we observed that time, confidence and good communication skills, which we can set up with self-education, regular and frequent visits and giving feedback and easy accessability of homecare unit, can be a solution to overcome these difficulties.

Keywords: home care, caregiver, family medicine, communication

BR-019

Elderly Care

Erdinç Yavuz

1st Family Healthcare Center, Rize

Primary care in Turkey has undergone a major change since 2010. Now, 21,750 Family Doctors serve the whole nation. The duties of Family Doctors are defined by legislations. According to these legislations they are required to have home-visits to their registered bedridden patients and file their medical records. These activities of family doctors are inspected every six months by authorities. We performed a cross-sectional study evaluating all bedridden patients over 65 years of age registered to eight family doctors working together in Rize 1st Family Health Care Center to evaluate demographic characteristics, main reason for their situation, their polypharmacy status, social support, mental status, incontinence status, number of home visits per month, action taken by family doctors each visit. A total of 29,479 people are registered to eight family doctors (min:3,071 max:3,938 for each family doctor) in our family health care center of whom 2,497 are ≥ 65 years of age (min:220 max:410 for each family doctor). A total of 93 bedridden patients were reported (min:3 max:24 for each family doctor). 46 visits to bedridden patients were filed (min:0 max:12 for each family doctor). Serebrovascular diseases (most frequently stroke), Alzheimer's disease and hip fractures were reported as the main diagnoses leading to being bedridden. Hypertension, type 2 diabetes and chronic obstructive pulmonary disease were common among bedridden patients. Polypharmacy is found to be an important problem. All of the patients were living with their relatives and the daughter or the daughter-in-law was the primary care giver. We will further discuss the role of family doctors in managing bedridden patients and lack of efficient coordination between professional caregivers. We think that management of bedridden patients constitute an important aspect of the elderly care and our discussion may give some insight of the mangement of these patients in Turkish primary care.

Keywords: bedridden elderly care primary care

BR-020**Drug- Food Interactions In Elderly People**

Canan Tuz

Ankara University, Ankara, Turkey

Population ageing is a worldwide phenomenon. Dietary substances, including herbal products and citrus juices, can perpetrate interactions with conventional nourishments. The elderly are at risk for drug–nutrient interactions because they use a disproportionate amount of prescription and over-the-counter medications, often have poor nutritional status, and often are instructed to take their medication with meals to increase adherence.

Age-related physiologic changes result in a functional decline of organ systems and homeostatic mechanisms. Body composition changes with age, resulting in an increase in total body fat and a decrease in total body water and lean mass in the elderly. Changes in protein binding also affect the distribution of medications in the elderly. A decrease in albumin concentration, due to age itself or chronic disease can result with problems on dosing of medications.

The aim of this brite subtitle is to explain the effect of food on drug disposition in the elderly like enteral formulas, dietary supplements, substances in diet used habitually like caffeine, ethanol and grape fruit juice. Another purpose is to identify the effect of medication on nutritional status in elderly. The medication consists of anticoagulants, antepileptics, antidepressants, antimicrobials, endocrin agents, gastrointestinal agents, Parkinson agents that are most commonly used by elderly people.

Keywords: drug-food interactions, elderly care, comorbidity, family medicine

BR-021**Elderly Care**

Guzel Discigil

Adnan Menderes University Department of Family Medicine and Department of Elderly Health, Aydın, TURKEY

AGING AND WISDOM: Do wrinkles pave the way to wisdom?

Healthy aging is among the most recognized interests of primary care. Furthermore family physicians generally coordinate the geriatric team which includes many disciplines. On the other hand gerontology is the study of the social, psychological and biological aspects of aging. It studies physical, mental, and social changes in people as they age, investigates the interface of normal aging and age-related disease, the effects of an ageing population on society, and applies existing knowledge to policies and programs. Philosophy of gerontology, importance of social care for elderly health and wisdom as an aging merit will be the focus of this session.

Keywords: aging social elderly care

BR-022
Elderly Care

Fatma Goksin Cihan

Department of Family Medicine, NEU Meram Medical Faculty, Konya, Turkey

Primary health care (PHC) must be accessible and “friendly” to persons of all ages. PHC centers are currently organized around an acute, episodic model of which does not meet the needs of especially older patients with chronic diseases. PHC centers need to be adapted to the needs of older populations. PHC practitioners should also be well versed in the diagnosis and management of the well-known four common conditions of older people: falls, incontinence, immobility and confusion. Family physicians should be aware that medical problems often present differently in older people. And they should not dismiss symptoms by simply attributing them to old age. All PHC center staff should receive basic training in age, gender, and culturally sensitive practices that address knowledge, attitude and skills, in core competencies of elder care. The administrative procedures should be adapted to the special needs of older persons, including older persons with low educational levels or with cognitive impairments. PHC should adopt systems that support a continuum of care both within the community level and between the community and secondary and tertiary care levels. Information on the operation of the PHC center, such as opening hours and registration procedures should be provided in an age-appropriate way.

Keywords: Primary health care, elderly care, coordination of care, prevention, family physician

BR-023
Elderly Care

Didem Kafadar

Department of Family Medicine, Bagcilar Training and Research Hospital, Istanbul, Turkey

Holistic Care In Elderly Patients:

Holistic modeling is one of the core competencies in the definition of Family Practice. It is explained as an activity, which emphasizes “physical, psychological, social, cultural and existential dimensions” of health problems. Equal recognition of all these dimensions is expected and the detection of influences of these to health/illness behavior and disease pictures are recommended. Some unexplained symptoms and conditions might be solved by this way. The holistic approach has been developed as a movement against the reductionist biomedical approach in the late century and was very promising since then, although it still lacks evidence on benefit/harm, utilization, applicability and feasibility. In the routine daily practice of family medicine with so many patients with different demands and in a limited time how can we approach our elderly patients who have many problems holistically? Elderly patients have health problems usually bounded to each other for example they may have chronic illnesses along with cognitive impairment and mobility disorders as well as social isolation. Even if one of the health problems is solved health status may not improve due to other unrecognized problems. A clear definition of holistic care in elderly people and a discussion on this concept in family practice may be useful. Utilizing different assessment methods and instruments to assess the health status of the elderly multidimensionally is one of the suggestions.

Keywords: holistic care, holistic approach, elderly

BR-024
Elderly Care

Mehmet Ungan

Department of Family Medicine, Ankara University, Faculty of Medicine, Ankara, Turkey
Studies on Care of Elderly in Family Practice: Are We in Need of A Research Agenda?

The share and demand of aging population is increasing in different European countries. Family practice is as the first point of care or gatekeeper intensely involved with the care of this special risk group. Issues like multi-morbidity, complexity, poly-pharmacy, frailty, disability, caregiver problems, family issues, low resources are frequently on the daily agenda of a family physician. Practicing guideline-based and evidence-based care is another challenge in family practice, because most trials are lacking data and therefore do not include recommendation for this age group.

Family practice needs to create its own evidence and therefore researchers in Family practice might in need of a guide, which provides a framework their studies. This Agenda might also help to prioritize certain research projects, which might be supported and/or funded.

Keywords: Aging, Family Practice, Elderly Care, Research

BR-025
Meditation Intervention for Chronic Disease Populations in Family Medicine

Elena Benigni

Department of Family Medicine, Accademia Shoho, Rome (Italy)

When I started to practice meditation, my goal was to dedicate a little more time to myself, but after a few months I was aware that I was discovering something very powerful, maybe one of the most effective procedure to feel better, physically, emotionally and socially. Furthermore, as I was improving my quality of life (my gastritis disappeared, I gave up smoking and noticed that I was having more free time). In this meantime I was wondering if I could expand this new knowledge in order to help my patients more and I was reviewing medical literature about. Surprising lots of studies demonstrate efficacy (especially for chronic disease) reducing symptoms. Then I started this new procedure with some "special" patients, principally those who are always complaining about something. Surprisingly, I discovered that meditation is pretty much well accepted by patients and for most of them, practicing 15 minutes per day, decreases their anxiety level, depression and chronic disease symptoms. GP doctors always face situation where the disease causes are multi-factors and we are often obliged to manage social, emotional and cultural situations, but do we ever try to speak with our patients about invisible things like their feelings?

we will demonstrate a practical group session, where participants could experience meditation their self. We want to stimulate discussions on the practicality and applicability of meditation among our patients population. In the end, we hope there will be proposals for researching and collaboration within family physicians from different countries to promote exercises in the daily clinical practice.

Keywords: Meditation, Chronic Diseases, Wellness, Complementary and Alternative Medicine, primary prevention

Promoting Health

Patient: Doctor, I don't feel well and I'm not sure why.



Doctor: I want you to meditate for 20 minutes, twice a day, exercise for at least 30 minutes a day, avoid processed foods, eat plenty of organic fruit and veg, spend more time in nature and less indoors, stop worrying about things you can't control and ditch your T.V. Come back in 3 weeks.

BR-026

How can we minimize the numbers of patients coming with fever to our clinic

Hayriye Kulbay Yuksel

HAYRIYE KULBAY

One of the most annoying and unnecessary task of my daily scheme in my clinic is dealing with the patients with fever. These patients are especially children. Parents are usually nervous and come in panic to the clinic. The fever is an emergency reason for them to come. They want to see me without an appointment and are impatient for waiting their turn. They want examination priority. When I ask how high their temperature is, some of them don't know what fever threshold is and consider normal levels as fever. When they bring the child with fever, they also bring other child/children to be examined for fever or signs. When I check them, usually they have no fever and no certain symptoms yet. It is a time consuming task in my clinic for a busy day. These fever related presentations hamper all other appointments. It causes me stress to manage time for others waiting for me. My solution for such situations are educating all adults who come with fever for themselves or their child/children for any reason. I especially focus on new mothers just after giving birth. I start conversation and give information about what to know about fever. How to measure temperature? How much temperature is fever? What to do when there is fever? How to control it? When to go to the doctor? What can be the accompanying symptoms for emergency? IF some of them come in the same way, I start to give information to them from the beginning again. Education initially takes time for me as well as taking care of all other reasons. Fortunately, as a result of my efforts, I get my reward. My patients have now stopped to come in panic for fever. My daily workload is markedly lowered compared with other colleagues.

Keywords: Fever, Emergency, Preventive Approach

BR-027**Social media as a tool for health promotion in adolescence**

Andrea Pighi

School of General Practice, region of Veneto, Vicenza, Italy

Health promotion is one of the main tasks of primary care and taking care of adolescents' health is one of the challenges of general practitioners; sometimes questioning their role and using new communication tools in order to intervene effectively on this population.

Adolescents usually are poorly geolocated and hardly contactable by health institutions. In fact, nowadays adolescents tend to engage with the community mostly virtually.

Social media and Web 2.0 are viable points of contact between the adolescents and health institutions; the potential of these tools are a resource that the general practitioner must learn to know and exploit.

This work will present the importance of using of social media as a tool for the prevention of mental distress and suicide among adolescents according to current scientific evidence.

In this age group, behaviors resulting from different degrees of psychological problems and not organic diseases are the major risk factors in terms of mortality and morbidity.

A website (www.thinkpositiveproject.it) and a page on Facebook (Think Positive Project) has been implemented in order to provide information and useful contacts to these subjects, to promote the fight against stigma and consequently bullying, cyberbullying, homophobia, racism and all kind of discriminations.

The Project aims at spreading common preventive messages with multimedia content of various kinds in a virtual community, so to encourage users to healthy and inclusive activities, and, trying to be light and ironic whenever possible, to promote "positive thinking". That is proven to be helpful in providing supports to people in critical times of their lives.

Keywords: Adolescents' behavior, Health promotion, Web 2.0

BR-028**Using Repellent as Mosquito Bite Protection: Solving Problem with the Problem**

Hardisman Dasman

Faculty of Medicine, Andalas University, West Sumatera, Indonesia

Mosquito has significant role as a vector various infectious diseases, such as malaria, dengue, chikungunya and yellow fever, especially in tropical regions. Female mosquito needs mammalian or human blood for maturing of its egg and while sucking human blood, mosquitoes also transmit parasites that will cause diseases in human. In order to protect from mosquito's bite, people has been used various strategies which include using burning, toxic spray, and electric repellents. Unfortunately, using the repellents cause new health problems such as respiratory disorders, cough and eye irritation. Moreover, the repellents also contain allethrin, the toxic substance that causes oxidative stress and cell damaged that leads to carcinogenic process. Allethrin will be released to the air from their smoke or spray. Even, our experimental study shows that that the electric repellent also had significant effect of oxidative stress due to it allethrin content. What is the best strategy as mosquito bite protection? Do we need to campaign to stop using mosquito repellents?

Keywords: Mosquito repellent, allethrin, oxidative stress

BR-029**Cancer screening in primary care**

Duygu Altıparmak

Department of Family Medicine, Marmara University Medical Faculty, Istanbul, Turkey

I think, raising awareness of my patients about increasing frequency of cancer is my responsibility as a family physician. If I can identify possible malignancy at an early stage during periodical health examinations then it will be possible for me to accomplish one of my main my mission in preventive medicine. In order to do that, family physicians should be able to do the cancer screening based on individual characteristics of each patient, in the same manner as they perform antenatal care and immunization. Incentives for cancer screening might a good tool to increase performance of family physicians in this field. Is there any positive/negative experiences with incentives for cancer screening ? What other measures can be taken to increase the cancer screening rates for whole population?

Keywords: primary care, cancer screening, preventive medicine

BR-030**Obesity**

Suzan Yazici

Department of Gerontology, Akdeniz University, Antalya, Turkey

Obesity is one of the major health problems. Even though several methods exist to handle obesity, we all know that obese patients who benefit from those methods are few. Especially the elderly obese patients have many unsuccessful experiences in losing weight which make them hopeless for future attempts. Interviews were conducted with elderly obese patients to see their attitudes towards losing weight and we have developed a long lasting, individual, program aiming steadily weight loss with low expectations. The implementation of the program is time consuming and needs sustainability. We have lost contact with some patients due to time restrictions. How can we achieve sustainability? Who should be leading such a program? Can the relatives be a part of the program? These are some questions we try to answer and want to discuss.

Keywords: Obesity, elderly, weight loss

BR-031**Integrating Smoking Cessation Practice into Daily Primary Care Routine**

Tevfik Tanju Yilmazer

Family Medicine Clinic, Tepecik Training and Research Hospital, Izmir, Turkey

Smoking is the leading preventable cause of premature death. Since smoking is a chronic addiction, family physicians are at a unique position to smoking cessation counselling. Encouraging smoking cessation is the most effective intervention family physicians can make to improve their patients' quality of life and increase their lifespan.

Yet I have always had a problem to fulfill the necessary steps in smoking cessation counseling during primary care practice with various reasons such as lack of time and/or lack of motivation of the patient.

I do have the common sense and experience to comprehend that combination of brief, empathetic and appropriate interventions and pharmacological therapies can help encourage smokers to quit smoking.

So I would like to learn if you had any intervention technique that just serves the purpose of smoking cessation during the busy daily schedule of the primary care health system.

Keywords: primary care, smoking cessation counseling

BR-032**Management of obesity in primary care: a mobile health service example**

Aykut Ardic

Department of Family Medicine, Sevket Yilmaz Training and Research Hospital, Bursa, Turkey

There are 16 family physicians who have started to part time educational program in Bursa in Turkey. We are supposed to be family practice specialists in six years. Turkish Ministry of Health supports the fight against obesity. The officials have sent pedometers to us and we have delivered them to the obese patients. The aim is encouragement of obese patients. There are several motivational reasons among obese patients to fight against obesity. Health is usually the second motivational reason. We have also detected accompanying depression with obesity in our patients. We will bring our experiences on obesity. Our results will probably be interesting for you. We would like to share the succes rates of the program.

Keywords: pedometer, obesity, motivation, HbA1c, depression

BR-033**Learning from Clinical Experiences**

Fikret Sipahioğlu¹

¹Istanbul University, Cerrahpasa Medical Faculty, Department of Family Medicine, Istanbul, Turkey

²Istanbul University, Cerrahpasa Medical Faculty, Department of Internal Medicine, Istanbul, Turkey

Breast cancer over age 75 is a challenge for clinicians. Most radiologists recommend to stop screening with mammography by that age, although for women with multiple risk factors including early menarche, late menopause, late pregnancy, hormone replacement therapy, lack of breast-feeding, family history, concomittant pathology of the endometrium, alcohol use and work at night time. the risk still remains. In undiagnosed cases, the clinical picture is mostly related with symptoms of metastatic bones, spontaneous fractures or severe back and ischiatic pain that persists. Fatigue, loss of appetite, depression and mild-moderate anemia may accompany the symptoms.

We suggest to keep on screening with clinical examination every three months and yearly breast MR for women over 75 with multiple risk factors for breast cancer and be alert on clinical signs.

Keywords: breast cancer, screening, elderly

BR-034**BRITE discussion group related to how practices around the globe address violence and poverty as part of patient presenting medical problems**

Patrick S Mcfarlane

Eastern Maine Medical Center Family Medicine Center and Residency/Clerkship Program

As.4 to.7 percent of all medical visits have underlying psychosocial foundations, and that much of that foundation is built on the experience of adverse childhood events and adult experience of interpersonal violence. This BRITE session will provide a forum to discuss what physicians in primary care think and do to address the issues of violence (micro and macro) in their practices and how they think about outcome with scholarly research and/ or practice improvement projects.

Keywords: Violence Primary care Screening Intervention Practice Improvement

BR-035**Genre violence in teenagers**

Diana Dominguez Jimenez

GP Trainee at the Health Centre of Estepa, Sevilla

About 90% of women older than 30 years in my area are treated with antidepressants and anxiolytics. Some women described herself "nervous", most of them if you dig you found marriage problems. But slowly the age of the women has been decreasing, and when I started talking about the origin of the anxiety, very often there were for issues with the partner, but if I kept digging I found problems of genre violence, not physical, but psychological and they were teenagers!.

I know is the best moment to empower them, to make them realize the situation so it don't go further, but I found more difficult to approach the topic with a teenager, you have to be very more careful and sensitive cause if you make a mistake most won't come back.

I started researching and it was amazing how the genre violence had increased in Spain in the last years. In other countries is happening the same? why is this change in society? How can we help teenagers to realize that some behaviors are not love (jealousy, prohibitions, controlling calls...) but an "aggression"?

Keywords: genre violence, teenagers, empowerment

BR-036**Violence in Health**

Nazan Karaoglu

Medical Education and Informatics Department, Meram Medical School, Necmettin Erbakan University, Konya, Turkey

Society and physicians seem to have a conflict about their understanding in respect to "meaning of being a doctor" resulting in violence against physicians. If medical education is aiming to serve society, then we should understand differences in perceptions of the role of doctors in society by studies in between the medical education community and society.

According to the interviews we made for a recent project it is obvious that although physicians know and believe the fundamentals of ethics they don't practice ethically or they could not show that they are practicing ethically to their patients and to the society? Society prefers good communication, empathy and honesty than medical knowledge. Patients don't want their doctors to be rude, unsmiling and unwilling to talk. They want to get answers to their questions without anger.

Of course violence cannot be accused and cannot be forgiven but we should understand why we are here now and then we can solve violence problem. "Who is a doctor? Who is a good doctor and who should be? Should be defined clearly by physicians and shared by society to rebuild trust and prestige.

Keywords: violence, professionalism, ethics, empathy

BR-037**The Reporting Obligations of Physicians**

Murat Altuntas

Sermet Family Medicine Center, Public Health Agency of Turkey, Isparta, Turkey

Home Healthcare is an innovative and fast-growing public service in my country. Have you ever encountered any kind of bruises in any part of the body of the patient at your Home Healthcare Practice. In case you encountered such a situation what would your reaction be?

Would you pretend not to see it or would you report with conscientious responsibility to judicial authorities for proper measures to be taken. As a health care worker, are you aware that you are expected to report such cases as they have to be taken into consideration by the crime authorities.

Keywords: Home Healthcare Practice, Violence, Denunciation, Judicial Authorities

BR-038**The Socioeconomic Divide and How it Effects EU Healthcare**

Veronika Rasic

Dom zdravlja Koprivničko-križevačke županije, Croatia

There are profound socioeconomic differences between counties in Europe. This divide comes in the form of political ideology, poor health policy, unavailable medical equipment and medication, low salaries, long work hours, large number of patients per doctor etc. These counties, like my own, are often under represented in EU decision making bodies and professional gatherings. The effect of these factors deeply impacts the everyday work of doctors and the health outcomes of their patients. They are also contributing to the current massive emigration of doctors from Croatia (about 1000 in the last year - roughly 5%) and other countries. The longer these issues are ignored and not given serious consideration it is very likely that healthcare in many countries will continue to deteriorate.

In Croatia an average GP sees between 50 and 100 patients, the bureaucracy is growing and badly managed, we have had multiple pay cuts, hospital strikes, we have yet to reach an agreement between the health ministry and doctors' syndicate, and the list goes on.

We need to start talking about these issues so that we can start finding solutions. But it is also important for counties on the other side of this socioeconomic divide to hear about what we are facing. Maybe together we can start to work on a brighter future for healthcare in all of Europe.

Keywords: health crisis, socioeconomic divide, EU health policy, general practice

BR-039**The Socioeconomic Divide and How it Effects EU Healthcare**

Elle Mall Keevallik

Department of Family Medicine, Tartu Ülikool, Estonia

There are profound socioeconomic differences between countries in Europe.

After the Soviet Union collapsed and Estonia became independent there was a big change in our health care system which totally reformed our primary care. GP`s were forced to work independently and most of them chose to work alone. Today we are moving towards group surgeries, but still we have 70% of GP`s working alone, which then offcourses leads to burnout. Doctors who are working alone don`t have the advantages their colleagues in group surgeries have. for example holidays, courses, trainings. They have to do more for the same money.

Today all European countries are struggling with ageing - patients are living longer, doctors as well. In Estonia we have in total 802 GP`s and 60 of those 802 are younger than 40 years old. This will lead to a catastrophe in next 10-20 years. Massive migration is the many reason this is happening. Reasons why doctors are going to other EU countries are the salary, better working hours, less patients per doctor and better founding from the Government.

We need to start talking about these issues so that we can start finding solutions.

Keywords: health crisis, socioeconomic divide, EU health policy, general practice

BR-040**Managing Chronic Communicable Diseases in Primary Care**

Abdul Hafiz Mohamad Gani

Department of Health, Federal Territory of Labuan, Labuan, Malaysia

Chronic communicable or infectious diseases like HIV, Hepatitis B and Tuberculosis are common cases seen in primary care clinic. In developing country like Malaysia where limited number of infectious disease specialists available and in some remote area, primary care physician plays an important role in managing these group of patients. In view of this current situation, I have decided to create an infectious disease unit in my own community clinic. This clinic consist of a dedicated team managing different aspects of infectious diseases from patient's education to secondary prevention (e.g. HIV counseling, contact TB screening, DOTS for TB and ART for HIV). The team runs by medical officers, paramedics and nurses. All of them have received proper training from the tertiary center. Any complicated cases will be referred to me for further evaluation and in some situation infectious disease specialist will be contacted for their expert opinion and management. I would like to share my personal experience and would like to know if there are other primary care physician whom management is different from what I have been practicing.

Keywords: Chronic Infectious Diseases, Managing, Primary Care

BR-041**The Socioeconomic Divide and How it Effects EU Healthcare**

Alexandra Georgios Tsipou

VdGM

Alexandra Tsipou -GREECE

General Practitioner in PHC-Athens

It is the holistic approach of a patient that persuaded me to become a GP. In Greece, nowadays, a few times we can allow ourselves this luxury: of time-less than 10 minutes for an overall examination in the ER. We are constantly constrained by economical targets and numbers when it comes to decide on how to manage a medical condition. If we have "overpassed " those figures, we are not permitted to prescribe medication, lab tests. In a night shift, people are queuing for hours, because triage cannot be done due to lack of doctors. It is the austerity measures that provoked all this irrational loss of jobs which led to the massive immigration of young specialists physicians.

Very often we have at our disposal only a few minutes to share with a patient who is receiving a life changing diagnosis. Social services are totally chopped off from the NHS. It is estimated that above 3 million of people are without medical insurance, and yet this number might be underestimated. Due to the disproportionate reduction in resources in General Practice that has taken place for the past 5 years, people cannot be managed locally, close to their homes- the PHC are either distant or cannot offer holistic centred care. And the list can go on.. According to the WHO the state of unhappiness is a severe unhealthy state to be. Here, both doctors and patients feel the same. If our vision is to focus on prevention, health education, treatment of disease, support our patients for their well-being, then our healthy policy makers should strive hard to engage such measures. Otherwise, we are facing an obvious failure to eradicate this humanitarian crisis.

Key words: Medical insurance- Austerity measures- doctor's immigration-Social services-unhappiness-humanitarian crisis

Keywords: doctor's immigration, humanitarian crisis, unhappiness, austerity

BR-042**How do we convert intuitive diagnoses into guidelines for mental health practice in the fledgling primary care centers in China?**

Kendall Anne Searle

Monash University, Melbourne, Australia

In China, where the primary care system currently in development, one-on-one, time with the patient remains limited and is often not private. In many western countries, the diagnosis of mental health conditions generally involves the use of a culturally validated and globally accepted questionnaire. These questionnaires, in their shortest form take 2 mins to complete but often take much longer and thus may not be considered in a standard consultation. Indeed, to establish the appropriate patient-physician rapport to determine the sensitive matters of mental health a longer consultation time is preferable.

In a time poor-setting, what approaches do other primary care physicians from other countries take to ensure that mental health is kept on the physician agenda (especially common mental disorders where somatic symptoms may be important indicators)? Is it possible that physicians intuitively make a preliminary assessment by patient profile (i.e. subconsciously bring together known behavioural and demographic risk factors for poor mental health to facilitate diagnoses)? If so, how can these invaluable insights be translated into a guideline for fledgling primary care doctors in China?

Keywords: Mental Health, China, Diagnosis,

BR-043

Primary Care Under Attack

Emrah Kirimli

Umraniye Merkez ASM, İstanbul, Turkey

During World Health Report, primary Health Care (Now More Than Ever) published at 2008 Turkey was in the middle of health in transition project of World bank. Family medicine program was one of the biggest part of transition project and primary care was supported. But after 2011 policies changed, direction of health care turned to hospitals. That is what we call primary care under attack.

Primary care system was under attack of privatization policies, medicalization and pharmatization. Particularly in Turkey, this comes with less investment to primary care, employee shortage, more hospital visits, increasing mortality&morbidity. So our unions, primary care associations and medical chamber is trying to change this situation. We did workshops, meetings, symposiums. We did strikes, joint actions, campaigns, commercial ads and etc. And we have a good experience against this sort of privatization issues and its effect on primary care.

We can see that this is not a specific problem for turkey. It is called health in transition and effects all countries and all primary care. NHS has the same problems (<http://www.keepournhspublic.com/index.php>). This is also a big issue for former eastern block countries or welfare countries like Sweden.

In this BRITE session we would like to learn from our colleagues and share our experience against government's privatization policies and attack on primary care. We want to create new collaborations for expand primary care influence on health care as it stated on WHO report Primay Care More Than Ever.

Keywords: Primary Care, health policy, NGOs

BR-044

Electronic Health Records

Erdinç Yavuz

1st Family Healthcare Center Rize, Turkey

Type 2 Diabetes Mellitus with its progressive nature and debilitating complications is one of the most difficult chronic diseases to manage. Different chronic care models were suggested for better diabetes care. Their common characteristic of these systems is that they all require advanced electronic information systems. We developed a follow-up chart with 16 main items to adress this necessity for an adequate and practical tool to help and guide the clinician to follow-up and monitor their diabetes patients. The chart also has "Diabetic foot evaluation form" and ready consultation forms as appendixes. This chart is planned to be integrated in Family Medicine Information Systems (AHBS) used currently by 21,750 family doctors in Turkey. The chart was prepared by using American Diabetes Association and Turkish Endocrinology and Metabolism Association (TEMMD) guidelines, two widely accepted and acknowledged guidelines in Turkey. A printed version is readily available. An electronic verison to be incorporated into information systems is yet to be developed. We postulate that such a powerful tool encompassing comprehensive properties of diabetes care may have a paramount role in management of diabetes in primary care and help better control of the disease.

Keywords: diabetes follow-up chart information systems primary care

Diabetes chart 2

Kontrol Tarihi:

Kontrol-I	Kontrol-II	Kontrol-III	Kontrol-IV
.. / .. / / .. / / .. / / .. / ..

Fizik Muayene

	kg	kg	kg	kg
1. Ağırlık				
2. Bel Çevresi (Hedef E<94 cm K< 80cm)	cm	cm	cm	cm
3. BMI (Hedef <25 kg / m ²) Normal Kilo = 18,5-24,9 / Aşırı Kilo = 25-29,9 / Obesite>30	kg/m ²	kg/m ²	kg/m ²	kg/m ²
4. Tansiyon Arteriyel (Hedef <130/80 mmHg; Proteinüri varsa < 125/75 mmHg)	mmHg	mmHg	mmHg	mmHg
5. Ayak İnceksiyonu (Ayakkabılar ve çoraplar çıkacak)	E H	E H	E H	E H
- Hastanın ayak şikayeti var mı?				
- Ayakta ülser var mı?				
- Parmaklarda şekil bozukluğu var mı?				
- Ayakta kızarıklık-şişlik var mı?				
- Nabızlar alınıyor mu?				
- Hasta kendi ayağının altını görebiliyor mu?				
- Ayakkabı uygun mu?				
Kontrol I :				
Kontrol II :				
Kontrol III :				
Kontrol IV :				

Glisemik Kontrol

	%	%	%	%
1. A1C (Hedef %6,5)				
2. Açlık Kan Şekeri (Hedef <70-120 mg/dl)	mg/dl	mg/dl	mg/dl	mg/dl
3. Tokluk Kan Şekeri (Hedef <140 mg/dl)	mg/dl	mg/dl	mg/dl	mg/dl
4. Varsa evde ölçülen kan şekeri değerlendirmesi	Min	mg/dl	mg/dl	mg/dl
	Max	mg/dl	mg/dl	mg/dl
	Ort	mg/dl	mg/dl	mg/dl

Renal

	µg/mg	µg/mg	µg/mg	µg/mg
1. ACR*				
2. eGFR** mg/dl/1.73m ² / 1.73m ²	mg/dl/1.73m ²	mg/dl/1.73m ²	mg/dl/1.73m ²	mg/dl/1.73m ²
3. İdrarda mikroalbumin çubuk testi				

*Ortalama Albumin İdrarda Konsantrasyonu (Normal <30mg/dl/1.73m²)**Glomerüler Filtrasyon Hızı (eGFR) (Normal >90 ml/dk/1.73m²)

Lipid Profili

	mg/dl	mg/dl	mg/dl	mg/dl
1. LDL (Hedef <100 mg/dl)				
2. Non-HDL (Hedef <130 mg/dl) (Total kolesterol - HDL Kolesterol)				
3. HDL (Hedef: E >40 mg/dl, K >50 mg/dl)				
4. Trigliserid (Hedef <150 mg/dl)				
5. Total Kolesterol (Hedef <200 mg/dl)				

Diabetes chart second page

Diabetes chart 3

Fizik Muayene

	kg	kg	kg	kg
1. Ağırlık				
2. Bel Çevresi (Hedef E<94 cm K< 80cm)	cm	cm	cm	cm
3. BMI (Hedef <25 kg / m ²) Normal Kilo = 18,5-24,9 / Aşırı Kilo = 25-29,9 / Obesite>30	kg/m ²	kg/m ²	kg/m ²	kg/m ²
4. Tansiyon Arteriyel (Hedef <130/80 mmHg; Proteinüri varsa < 125/75 mmHg)	mmHg	mmHg	mmHg	mmHg
5. Ayak İnceksiyonu (Ayakkabılar ve çoraplar çıkacak)	E H	E H	E H	E H
- Hastanın ayak şikayeti var mı?				
- Ayakta ülser var mı?				
- Parmaklarda şekil bozukluğu var mı?				
- Ayakta kızarıklık-şişlik var mı?				
- Nabızlar alınıyor mu?				
- Hasta kendi ayağının altını görebiliyor mu?				
- Ayakkabı uygun mu?				
Kontrol I :				
Kontrol II :				
Kontrol III :				
Kontrol IV :				

Title: "Physical Examination"

Diabetes Chart 4

Kontrol Tarihi:

Kontrol-I	Kontrol-II	Kontrol-III	Kontrol-IV
.../.../...	.../.../...	.../.../...	.../.../...

Konsultasyonlar

1. Son bir yıl içinde retinopati açısından değerlendirildi mi?	E	H	E	H	E	H	E	H
2. Son 6 ay içinde diş - dişeti muayenesi var mı?	E	H	E	H	E	H	E	H
3. Tıbbi Beslenme Tedavisi için diyetisyene referans edildi mi?	E	H	E	H	E	H	E	H

Kardiyovasküler

1. 10 yıllık koroner kalp hastalığı riski <small>http://www.tskg.org.tr/bolge-ve-ogrenci</small>				
2. Kardiyovasküler Riski Azaltmak için Kullandığı İlaçlar:				
Statın	E	H	E	H
Aspirin (80-150 mg) <small>10 yıllık KHK riski <math>\geq 10\%</math> olan hastalara önerilmez</small>	E	H	E	H
ACE-I veya ARB	E	H	E	H
Beta Bloker (Post MI)	E	H	E	H
3. EKG <small>Hastası 40 yaş veya DM hastası <math>\geq 75</math> yaş veya HT var ise</small>				

Öneriler

Kontrol-1	Kontrol-2	Kontrol-3	Kontrol-4
Sonraki Randevü .../.../...	Sonraki Randevü .../.../...	Sonraki Randevü .../.../...	Sonraki Randevü .../.../...

Konsultasyonlar

1. Hipoglisemi eğitimi ve eğitim materyali verildi mi?	E	H	E	H	E	H	E	H
2. Kullanılan ilaçların yan etkileri hakkında bilgi verildi mi?	E	H	E	H	E	H	E	H
3. İnsülin kullanıyorsa kalem eğitimi verildi mi?	E	H	E	H	E	H	E	H
4. Glukometre eğitimi verildi mi?	E	H	E	H	E	H	E	H
5. Evdeki glukometre ve laboratuvar karşılaştırılması yapıldı mı?	E	H	E	H	E	H	E	H
6. Tıbbi beslenme tedavisi eğitimi verildi mi?	E	H	E	H	E	H	E	H
7. Hipertansif ise tuz kısıtlaması önerildi mi?	E	H	E	H	E	H	E	H
8. Sigara içiyorsa sigara bırakma danışmanlığı verildi mi?	E	H	E	H	E	H	E	H
9. Gebelik olasılığı varsa gebelik öncesi danışmanlık verildi mi?	E	H	E	H	E	H	E	H
10. Stres eğitimi - Psikolojik Danışmanlık hizmeti verildi mi?	E	H	E	H	E	H	E	H
11. Egzersiz önerildi mi? Eğitim materyali verildi mi?	E	H	E	H	E	H	E	H
12. Ayak bakımı eğitimi ve eğitim materyali verildi mi?	E	H	E	H	E	H	E	H
13. Tedavi ve Randevu Kartı verildi mi?	E	H	E	H	E	H	E	H

Diabetes chart third page

Diabetes chart 5

1. Hipoglisemi eğitimi ve eğitim materyali verildi mi?	E	H	E	H	E	H	E	H
2. Kullanılan ilaçların yan etkileri hakkında bilgi verildi mi?	E	H	E	H	E	H	E	H
3. İnsülin kullanıyorsa kalem eğitimi verildi mi?	E	H	E	H	E	H	E	H
4. Glukometre eğitimi verildi mi?	E	H	E	H	E	H	E	H
5. Evdeki glukometre ve laboratuvar karşılaştırılması yapıldı mı?	E	H	E	H	E	H	E	H
6. Tıbbi beslenme tedavisi eğitimi verildi mi?	E	H	E	H	E	H	E	H
7. Hipertansif ise tuz kısıtlaması önerildi mi?	E	H	E	H	E	H	E	H
8. Sigara içiyorsa sigara bırakma danışmanlığı verildi mi?	E	H	E	H	E	H	E	H
9. Gebelik olasılığı varsa gebelik öncesi danışmanlık verildi mi?	E	H	E	H	E	H	E	H
10. Stres eğitimi - Psikolojik Danışmanlık hizmeti verildi mi?	E	H	E	H	E	H	E	H
11. Egzersiz önerildi mi? Eğitim materyali verildi mi?	E	H	E	H	E	H	E	H
12. Ayak bakımı eğitimi ve eğitim materyali verildi mi?	E	H	E	H	E	H	E	H
13. Tedavi ve Randevu Kartı verildi mi?	E	H	E	H	E	H	E	H

Diabetes chart page 4

Diabetes Chart 6

Diyabetik Ayak Değerlendirme Formu-I (Yılda Bir Kez)			Adı-Soyadı		Tarih	
Parmak Uçları						
ISI		HİDRASYON		ÖDEM		
SAĞ	SOL	SAĞ	SOL	SAĞ	SOL	
<input type="checkbox"/> Normal	<input type="checkbox"/>	<input type="checkbox"/> Normal	<input type="checkbox"/>	<input type="checkbox"/> Var	<input type="checkbox"/>	
<input type="checkbox"/> Sıcak	<input type="checkbox"/>	<input type="checkbox"/> Kuru	<input type="checkbox"/>	<input type="checkbox"/> Yok	<input type="checkbox"/>	
<input type="checkbox"/> Soğuk	<input type="checkbox"/>	<input type="checkbox"/> Terli	<input type="checkbox"/>			
Ayak Gövdesi						
ISI		HİDRASYON		ÖDEM		
SAĞ	SOL	SAĞ	SOL	SAĞ	SOL	
<input type="checkbox"/> Normal	<input type="checkbox"/>	<input type="checkbox"/> Normal	<input type="checkbox"/>	<input type="checkbox"/> Var	<input type="checkbox"/>	
<input type="checkbox"/> Sıcak	<input type="checkbox"/>	<input type="checkbox"/> Kuru	<input type="checkbox"/>	<input type="checkbox"/> Yok	<input type="checkbox"/>	
<input type="checkbox"/> Soğuk	<input type="checkbox"/>	<input type="checkbox"/> Terli	<input type="checkbox"/>			
Bacak						
ISI		HİDRASYON		ÖDEM		
SAĞ	SOL	SAĞ	SOL	SAĞ	SOL	
<input type="checkbox"/> Normal	<input type="checkbox"/>	<input type="checkbox"/> Normal	<input type="checkbox"/>	<input type="checkbox"/> Var	<input type="checkbox"/>	
<input type="checkbox"/> Sıcak	<input type="checkbox"/>	<input type="checkbox"/> Kuru	<input type="checkbox"/>	<input type="checkbox"/> Yok	<input type="checkbox"/>	
<input type="checkbox"/> Soğuk	<input type="checkbox"/>	<input type="checkbox"/> Terli	<input type="checkbox"/>			
Ayak						
RENK		NABIZLAR				
SAĞ	SOL	Dorsalis Pedis		Tibialis Posterior		
<input type="checkbox"/> Normal	<input type="checkbox"/>	SAĞ	SOL	SAĞ	SOL	
<input type="checkbox"/> Kızamık	<input type="checkbox"/>	<input type="checkbox"/> Normal	<input type="checkbox"/>	<input type="checkbox"/> Normal	<input type="checkbox"/>	
<input type="checkbox"/> Soluk	<input type="checkbox"/>	<input type="checkbox"/> Zayıf	<input type="checkbox"/>	<input type="checkbox"/> Zayıf	<input type="checkbox"/>	
<input type="checkbox"/> Siyanoze	<input type="checkbox"/>	<input type="checkbox"/> Alınmıyor	<input type="checkbox"/>	<input type="checkbox"/> Alınmıyor	<input type="checkbox"/>	
Parmak						
TIRNAK KESİMİ		PARMAK ARALARI MUAYENESİ		PARMAKTA DEFORMİZE		
1	<input type="checkbox"/> Düz	1	<input type="checkbox"/> Normal	1	<input type="checkbox"/> Var	
2	<input type="checkbox"/> Yuvarlak	2	<input type="checkbox"/> Masere	2	<input type="checkbox"/> Yok	
3	<input type="checkbox"/> Diğer	3	<input type="checkbox"/> Fungus			
		4	<input type="checkbox"/> Enfeksiyon			

Diabetic foot chart

diabetes follow-up chart 1

Diyabet Takip Formu

Hasta Bilgileri

Adı Soyadı:
Yaşı:
Mesleği:
Medeni Hali:
Çocuk Sayısı:
Adres:
Telefon: Ev
Gsm

Dosya No

Dosya Açılış Tarihi

Hasta Hikayesi

Kaç yıldır Diabetes Mellitus Hastası? yıldır

Kilo (kg)	Boy (cm)	Bel Çevresi (cm)	BMI (kg/m ²)

YENİ TANI

İnsülin kullanıyor mu?

 E H yıldır

Özgeçmişi :

Aldığı Tedavi :

1.
2.
3.
4.
5.
6.
7.
8.

Soygeçmişi :

Alkol kullanıyor mu? E H yıldırSigara kullanıyor mu? E H yıldır

Diyabetik komplikasyonlar :

Hedeflerin Sorgulanması

Hedefte ✓

Hedefte Değil ✗

Kontrol-I	Kontrol-II	Kontrol-III	Kontrol-IV
HbA1C:	HbA1C:	HbA1C:	HbA1C:
LDL:	LDL:	LDL:	LDL:
T.A:	T.A:	T.A:	T.A:

Diabetes follow-up chart front page

BR-045**Simplifying the Lives of Elderly**

Nur Sehnaz Hatipoglu

Konak 24 nolu ASM, Izmir, Turkey

Developments in medicine, reaching to effective medical departments by everybody easily, decline in birth rate, developments in treatment of chronic diseases, civilization and developments in technology enabled longer life time.

The elderly population increased as a result of long lifetime. The most increased group in elderly population is age of 85 and over. The rate of elderly over age of 65 to population in our country is 7.5% and expected to be over 8% in recent years.

Getting aged is a part of nature but it is important to continue this period in good quality. As years pass, the organs of the body also ages and loses some functions.

As a need of modern era, the developments in technology are mostly for young people but these developments don't address to elderly who have many changes both physically and mentally. The most important changes are decrease in hearing, visioning and motor functions.

Elderly can't go outside frequently like others and spend most of their time at home watching TV, reading and chatting with neighbours on phone. For these reasons the tools they use must be as basic and also functional as can be.

It is hard for elderly to mobilize easily and they want to communicate on screen, for this reason the keys, the screen and the letter size of the phones must be bigger than normal ones, and also sound and colors of the screen must also be accurate. The background must not be blue.

As technological development are very far for TV and their remote control devices are also very complicated, but elderly want very simple tools that don't mix their head like just big on off, forward backward keys. And also the colors of the screen should not weary the eyes and the sound must be accurate.

Keywords: elderly, simple tools, phones, remote contro

BR-046**Medical Law As a Routine Course in Medical Education**

Rabia Adeviye Aktas

Department of Family Medicine, Cumhuriyet University, Sivas, Turkey

As physicians we do a hard work, we put our lives on it, study hard, work hard, everything seems hard about being a physician. But if I was asked the hardest day of my career, I -with no hesitation- could say, it was the day I went to the court for a code white statement. Code white is an emergency code in Turkey, as in most other countries, pointing to an aggression or violence to health care workers. The day was the hardest, because I was a stranger in that world, my homeland was the hospital not the court; I felt completely defenceless. After the trial (the judicial process is still ongoing, though) I had enough time to think why it was so challenging. Now I know the answer: It is because of my lack of knowledge about law. I know nearly nothing about law but the truth is that a great deal of our work is directly related with law. For instance there are written regulations and codes on how a physician has to examine when giving a health certificate for a marriage, a driving licence, or a job application. I can give a lot more examples, the emergency cases, the prescriptions of addictive drugs, the blood alcohol tests, surgeries, the informed consents of the patients... These are all legally regulated conditions of our profession. In fact non of us has enough knowledge about the legal rules but we have to. We may even be breaking the law while believing it is absolutely true for our patient. Finally, my proposal is that medical law should be a routine course in the medical college educations. I do not mean forensic medicine or bioethics, what I mean is real medical law from real lawyers must be taught to medicine students.

Keywords: medical law, education of medicine, courses, forensic medicine, ethics

BR-047**The importance of getting out of the comfort zone: new experiences in different fields**

Carolina Martins Moreira

Serviço de Medicina Física e de Reabilitação - CHP, Porto, Portugal

Justification:

Nowadays, with a crescent number of physicians, the importance of each one different experiences is increasing. Our clinical practice will reflect our background context and it will be valued the most, as more different experiences we reached.

The capacity of adaptation is a requirement that makes the difference as new adventures and work experiences lead to new social tools, of utmost importance in our clinical practice.

In my short career I've spent a month doing medical voluntarism in Cabinda, Angola in 2009 and recently I've done an internship in aerospace medicine UTMB-Nasa in July 2014. Those were two incredible experiences in complete opposite fields that in different ways changed my medical point of view and my clinical practice.

Content:

Doctors that had an experience in different fields or in extreme situations would tell what did and learned from it and how it changed the way they see their medical work.

- Different medical approaches
- Capacity of adaptation in different medical fields
- Exchange of experiences

Keywords: adaptation, exchange, medical experiences

BR-048**Internationalization of GP/FM education: the Vasco da Gama Movement Exchange Programmes**

Sara Rigon

GP Specialist, Bologna Italy

Nowadays, globalization is a fact more than a point of view. We, as physicians, cannot afford to ignore the impact of such a pervasive phenomenon on health care systems and its consequences, starting from the increase in health professionals' mobility as well as patients' Moreover, globalization offers great opportunities to learn from one another and many universities around the world have been implementing the internationalization of their core curriculum, acknowledging the importance of intercultural competences.

What about GP/FM education? Do we see a need of internationalization of GP/FM education?

The Vasco da Gama Movement provides a range of exchange programmes for medical doctors specialising in GP/FM and junior GPs/FPs within five years of completing specialty training that offer the possibility to discover different primary care systems and educational environments. We want to share our experience and discuss the potential value of international education exchanges in GP/FM.

Keywords: general practice, family medicine, education, international educational exchanges

BR-049

Interprofessional Obesity Treatment

Susan Saffel Shrier

Department of Family and Preventive Medicine, University of Utah School of Medicine, Salt Lake City, Utah, USA

Addressing obesity in a clinical setting can be a daunting task. Obesity, like many chronic disease, require a comprehensive physical, psychological and social assessment to identify key factors contributing to weight management. There are obesity guidelines but they leave you with uncertainties on motivational interviewing, behavioral change, goal setting as well as techniques for dietary assessment. I would like to share our approach to these challenges through team based group settings and discuss options for effective obesity treatment.

Keywords: obesity, clinical approach, interprofessional teams

BR-050

Global health competencies

Emily Clark

Royal College of General Practitioners, UK

We believe it is essential that UK based healthcare professionals take advantage of opportunities to engage in global health. There are potentially great benefits to GP training and GP practice in terms of the personal and professional development of our healthcare workforce in their working and learning overseas, and in the integration of global health learning into the UK GP training curriculum.

Since the publication of Lord Crisp's report, Global health partnerships: the UK contribution to health in developing countries, steps have been taken to support healthcare professionals who wish to volunteer in developing countries. The Academy of Medical Royal Colleges in the UK has taken the lead on this. A set of benchmark competencies in global health, particularly focused on volunteering, are being developed. Furthermore, the many barriers and challenges faced by professionals are being recognized.

How do these compare to other countries and WONCA regions? Are competencies in global health really generic or are they country specific? We would be interested to hear from delegates from other countries and regions as to how these compare and discuss whether we have common ground as to what 'competency in global health' truly means. We would also be interested to hear whether primary healthcare professionals in different countries face similar challenges and barriers to being involved in global health as we face in the UK.

Keywords: Competencies in Global health

BR-051

Communication in Primary Care

Nazan Karaoglu

Medical Education and Informatics Department, Meram Medical School of Necmettin Erbakan University, Konya, TURKEY

Although it is obvious that communication is important to enhance patient outcomes, supports well being and satisfaction of both doctors and patients, effective in health care and cost effective it is no understandable why we still have problems in this area.

When we ask to doctors, beginning from the medical students, they know and they note that they believe in the advantages of effective communication but in practice patient see a different face of a doctor. It seems that the doctor who believes in good communication transforms to a new one who acts opposite. Unfortunately, physician-patient communication has frequently been judged to be inadequate although physicians claim that they communicate adequately.

I made some interviews with patients and with healthy individuals and with doctors (medical students, practicing physicians, residents and academicians). It was really very interesting to witness this paradox while I was listening their stories, experiences about patient doctor relationship. It is obvious that there is a misunderstanding and ambivalence about communication.

Many articles say that there is a need for formal communication education during medical education process and they note that medical educators should focus on teaching communication skills and the effects of physician behavior on patient outcomes. The literature also adds that "only a minority of medical students and physicians receive formal communication training using curricula that are proven to contribute to better patient outcomes. Communication skills should be taught widely by faculty with expert knowledge using standardized patients for uniform assessment and feedback".

I want to go further and want to claim that if doctors do not believe themselves that good communication is useful and internalize good behaviors patients understand it and patient doctor interview end with dissatisfaction. There is a need of research about understanding the roots of this ambivalence of doctors by qualitative studies.

Keywords: communication, physician, patient, medical education

BR-052

Electronic Health Records

Cemal Kavasogullari

Innovative Healthcare Solutions

In an age where we have direct access to a live feed from a connected webcam in a rainforest in Brazil, in an age where we are beaming wifi connection via automatic drones, it is beyond comprehension that we still struggle with simple access to meaningful medical health records. CALDICOTT principles in the UK involves the duty to "share information" as well as to protect it since 2012.

There still are ethical issues around the ownership and access to this sensitive information and only recently trends are moving towards allowing patient access to their medical health records in an easier and more intuitive way. This delay is also partially due to the resistance from ourselves, the medical community. But why the fear? Why are doctors afraid of patients having access to their very own records?

And from the technological point of view, why have we so far failed to create a successful system to allow efficient and secure sharing of information? Compatibility, storage, security and ownership are some of the main obstacles we have encountered.

Yet I believe this is not enough. Patient's should not only have merely "access" to their health records but also have the ability to create them. Connected health is on it's way and we have to position ourselves as GPs in the

best possible way to receive the forthcoming wave.

I would like to open to discussion a new idea that may solve some of this issues: Give patients the responsibility of their own health records. Let them hold, transfer, share and ensure the security of their own data in an electronic format. A new approach to an old way of handling medical records.

Keywords: EMR, electronic health records, personal health records

BR-053

Violence in Health

Vishal Mallusingsh Baghele

Department of family medicine, Sir Ganagram hospital, New Delhi, India

Medical violence is very serious issue now a days. Its raising issue in developing countries like India. We read news regarding this everyday. This is very common at primary health center where there is poverty, backwardness, lack of education and lack of security guards. In India doctors are being beaten everyday even at tertiary level. Strict laws has been made, but government is unable to protect doctors till today. Due to this, doctors are avoiding to go to primary health centres.

But medical violence can be prevented by making certain protocols, rules, strainghthing security of doctors etc. Proper health education should be given to the people. Information regarding medical violence should be added in medical education carriculum at undergraduate level.

Keywords: Developing countries, medical voilence, doctors

Broken glasses of hospital



Doctor was beaten badly by patient relatives



BR-054**A Good Enough Death (An Honourable Death)**

Riitta Anneli Heiskanen

Department of Public Health Services, Helsinki, Finland

Death and the meeting of the grieving family is one of the most difficult tasks of a physician. During my quite long practice (since 1970) in quite various fields of medicine (adult & neonatal reanimation, children's transport, adult & child psychiatry, general practice, school health) I have had time to analyze my behaviour as well as my colleagues'. Especially when I was young I was often put in the responsibility of confronting the family in these sensitive situations. This has probably marked my character as a physician most.

My parents died in 1981 & 2013 at hospital in quite similar medical conditions, but in opposite "holding" situations. My former husband died in 2013 at hospital; the way our daughters were not met at the death of their father was shocking. The general behaviour towards death has changed with the development of our societies and the widening of our knowledge; the discussion of the emotional impact has almost disappeared.

In Finland today we are not allowed to "simply" die; on the death certificate we must have a primary and a secondary diagnosis and the general conditions. This can often be very difficult to even the family practitioner.

A taxi driver told me the death of his grand-mother at the age of 102 during her siesta next to her grand-son; this made me think of one of my first reanimations, a lady of 104 years brought to the hospital for a cardiac arrest.

An oral presentation to give birth to a discussion of as well personal as general opinions on death and its confronting.

Keywords: death, emotions arousing, behaviour

BR-055**Informed Consent in Primary Care**

Yasemin Kılıç Öztürk

Izmir Tepecik Training and Research Hospital, Family Medicine Clinic, Izmir, Turkey

One of the most stressing things for me is to develop and have written consent for each management during my daily practices. Informed consent is one of the most important part of patient rights in clinical practice. As family medicine is a comprehensive discipline there is a wide range of managements in daily practice (injections to operative procedures...) We need so many different forms for each. I usually report on the database that "necessary information is given and approval is taken" and do not have written consent for basic interventions such as injections and vaccinations. I have a challenge that this may be a legal or an ethical problem. Do you have written consent forms for each different managements? How do you deal with such situations?

Keywords: approval, family medicine, daily practice

BR-056**How could psychotherapy lead to maintain weight after diet?**

Patrick Tabouring

Université du Luxembourg, Luxembourg, Luxembourg

Justification

It is doubtlessly as difficult to maintain the weight acquired by diet as to make it to lose the excessive kilos during the diet. The return to the initial weight, even its exceeding, is much more frequent than maintaining it. The patient as well as the GP risk to have a feeling of useless effort and to feel themselves so much more discouraged. It is important to remedy this situation, as obesity concerns a growing proportion of patients and causes problems to public health.

In addition, much of our obese patients feel a strong psychic suffering.

Content

I am working in a group practice with high share of obese patients due to the nutritional activities of my GP colleague. Despite the impressive results of her diet prescriptions, I was worried about the great number of returns to initial weight or even exceeding it. In view of the similar statements in public health, I ask the question why one does not reach continuous results.

Compared to other chronic pathologies (like fibromyalgia), where the identification of a particular psychopathologic profile has made extraordinary results, obtained by an adapted global and psychotherapeutic care, I'm questioning myself about the common psychopathologic patterns to obese patients and their expected benefic results by an appropriate psychotherapeutic model.

Following first interesting observations but in view of partly unsatisfactory results, I would like to exchange experiences with other GP's, hoping that their contribution would make possible a shared consensual improving in our future approach of obese patients.

Keywords: psychotherapy, obesity, suffering, consens

BR-057**Effect of Media on Health**

Yusuf Karayürek

Department of Family Medicine, Sevket Yilmaz Training and Research Hospital, Bursa, Turkey

Media affects our lives in all aspects including health. Diabetes Mellitus has been more commonly discussed on TV programmes than it has never been before in Turkey. For example, indications of oral glucose tolerance test (OGGT) during pregnancy is one of the items discussed on TV. I have observed that patients' behaviour have been significantly changed to do or not to do OGGT. I would like to discuss usefulness of OGTT during pregnancy and new trends on this topic among patients.

Keywords: oral glucose tolerance test, pregnancy, diabetes mellitus, media, television programmes

BR-058**Defensive Medicine in the Family Medicine**

Giray Kolcu¹

¹Selçuklu Community Health Center, Konya, Turkey

²Karşıyaka Community Health Center, İzmir, Turkey

³Department of Endodontics, Selçuk University, Konya, Turkey

⁴Department of Family Medicine, İzmir Katip Çelebi University, İzmir, Turkey

Defensive medicine practices are the medical practice deviations that physicians apply for the purpose of protecting themselves against malpractice lawsuits. There are two main forms of defensive medicine practices. Assurance Behavior (positive defensive medicine), being non-advantageous to the patient neither marginally nor medically, adds services for adverse events which may be resulted with medical malpractice litigations that are accepted by the service standards of the legal system. Avoidance Behavior (negative defensive medicine) is the behaviors that physicians perform in order to protect themselves from legal risks. Among these, actions are included such as rejection of the high-risk procedures and conditions, avoidance of invasive procedures and removing the high-risk patients from the list of operations.

This behavior is a matter of debate all over the world, and in various studies done regarding physicians, high rates were found. In our study we have shown this prevalence.

How about sharing your opinions on this behavior that vocationally puts physicians in a difficult situation, such as creating negative motivation on physicians, having negative impact on costs, giving damage to patient?

Keywords: defensive medicine, family medicine, malpractis

BR-059**Entering Diagnosis or Problems by Family Physicians in Electronic Health Records**

Adeel Nazir Ahmad

King Faisal Specialist Hospital and Research Centre Jeddah Saudi Arabia

As a family physician seeing patients presenting with various problems, not knowing their ongoing or past medical problems can have a major impact on their future management. With partial electronic health records, while documentation is still on paper, it becomes even more important to ensure physicians enter a diagnosis or problem (in the form of ICD9/10 code) in the electronic records.

In a new job, with no patients files and unable to see any recorded past medical history or recent patient presentations in the IT system, I had considerable difficulty in managing patients with multiple medical problems not being sure of their past medical history. I felt the need to initiate a performance improvement project to improve entering diagnosis and problems by family physicians. Lack of awareness of the importance of this, trying to find an appropriate ICD 9/10 code by the physicians and time consumed by multiple clicks involved in trying to navigate around the IT system has been a major obstacle. What would be the best way to address this issue? With everything being automated, do we need physician assistants to help with our electronic documentation while we concentrate on what we should do best, ie managing patients?

Keywords: diagnosis, problems, family physicians, information technology,

BR-060**Deprescribing to address polypharmacy and potentially inappropriate medication use in the elderly**

Katharine Ann Wallis

Department of General Practice and Primary Health Care, The University of Auckland, New Zealand

Polypharmacy is a leading risk factor for adverse drug reactions and avoidable adverse drug reaction hospital admissions. Polypharmacy is common in the elderly and becoming more common as people are living longer with more chronic conditions. Many medications that the elderly take are potentially inappropriate. Deprescribing is the process of tapering and withdrawing medications. Deprescribing is integral to optimal prescribing but there are many barriers to integrating deprescribing into medicine's culture of prescribing. Doctors may not think polypharmacy is a problem, or know which drugs to stop when and how; they may fear upsetting or offending the patient; they may find the process too time consuming; or they may fear poor outcomes or legal repercussions. I would like to hear your experience about deprescribing potentially inappropriate medication in the elderly. In particular, I would like to know what you consider to be the barriers to deprescribing and the factors that aid and abet you deprescribing in practice.

Keywords: Polypharmacy, adverse drug reactions, elderly, deprescribing

BR-061**Empowerment for solving problems with the patient**

Diana Dominguez Jimenez

GP trainee at the Health Centre of Estepa, Sevilla

One thing that shocked me the most when I started practicing, was that most of the time in primary care is that people was not asking me for health problems but for advice for matters in their daily life. That terrified me, because in the six year of university no one had prepared me for that. Sometimes I found myself wandering about how was I going to give advice in life if I still was asking also for them, and how was I suppose to do it not someone my age, but people that could be my parents.

I read a lot to learn how to manage that kind of situations, with my tutor learned some approaches to certain matters, etc.

After researching, trying, failed and learn how to elaborate a good relation of trust wit the patients, sometimes I don't wait for the patient to ask me, if the person is troubled I ask about, and surprisingly most seemed released, because the were worried not to trouble me with their personal stuff.

Along with my tutor and help for a psychologist friend of mine, we have elaborated a compilation of readings to give the patient, that can help in different situations, for reading at home. the they come again and we talk about thoughts, feelings, etc. while reading it and how apply the things learned in their life.

That method has been useful for us, but there could be so many ways depending of the abilities of the practitioner and the patient, that I think it can be very useful to have a discussion about aproaches and share resources about this topic.

Keywords: problem solving, patient empowerment

BR-062**Anticoagulation: To do or not to do? And how? That is the question!**

Ana Sofia Pena

USF Samora Correia, ACES Estuário do Tejo, ARSLVT, Portugal

We have tools (CHADs-VASC2, HAS-BLED) that help us to decide whether start or not anticoagulant agents in a patient. But this decision is not always straight and simple.

Nowadays there is an extended offer of anticoagulant drugs and we, as family physicians, are in a prime position to better start and manage this treatment.

We know the studies about these drugs, the advantages and disadvantages of each one and we have guidelines.

But we also have a lot of different patients and issues.

There are the politics, costs, patient's ability, medical conditions and financial status. We can know and trust or not in old and new anticoagulant agents, we can feel comfortable or not in prescribing them, we have poor and disabled patients, patients with comorbidities, with impaired kidney or liver function, we have otherwise healthy patients... We have a lot of different situations.

So, what to do in each one in what concerns to anticoagulation?

Keywords: anticoagulation, different patients, costs, ability, comorbidities

BR-063**From NASA to a Refugee camp - perspective from a Family Doctor**

Pedro Caetano

USF Nova Via - CHVNG, Porto, Portugal

Purpose of the activity - Share of experiences and different types of actions, backgrounds and roles from Family doctors.

Count - As a young doctor, I believe doctors should have the most experience possible in different backgrounds. As a resident doctor of family medicine, I had the opportunity to work in two of the most unique and extreme places in the world, that gave me another way to look at the world.

I had the chance to learn and practice in NASA and to see a place where the resources are almost unlimited and where innovation and research are a common in a daily basis. To participate in the course of Aerospace Medicine in Houston, provided by UTMB and NASA, was a way to look at the future and to see what medicine will be and how it can change in a few decades. As a future family doctor, I will not manage to treat and take care of patients that have been exposed to extreme conditions like microgravity, acceleration, ionization or pressure, but I can take advantage of the research that is being made and see which are the countermeasures that are being developed to combat some medical situations that are also common to a general practitioner work such as glaucoma, musculoskeletal conditions or fluid redistribution.

Luckily I had the opportunity to compare between two opposite worlds, values and to understand the needs of a large part of humankind. I had the chance to experience the daily life of a humanitarian doctor in MaeLa Refugee-Camp in Thai-Myanmar border with SMRU Oxford, and to give some humanitarian help the Burmese people.

Topics - Exchange of experiences and adaptability to different environments from Family doctors in different roles that played as family doctors around the world in a variety of fields.

Keywords: experience, space medicine, exchange, refugee camp, humanitarian work

BR-064

How to deal with complaints in primary care

Gabriela Cristina Elena Badea

Peartree Lane Surgery, Welwyn Garden City, UK

As a GP trainee, working in a multicultural society, I received a complaint from a patient. I felt very upset and after reading the letter I went straight to the notes to check my entry. I have also discussed with my senior colleagues and felt relieved that everyone agreed with my medical management.

It is very difficult to get a formal complaint, and this makes you question your knowledge and your skills. I was surprised that doctors do not talk about this openly, and there is no support to deal with a complaint. This can make you feel isolated, even when you did not make a medical mistake.

Patients coming from different backgrounds have different expectations from the healthcare system. How do we address this? What is your experience in dealing with a complaint and what is the complaint procedure in your practice?

Should we talk about this more openly?

I would like to share my experience in dealing with this complaint and I would be happy to get your views on this!

Keywords: complaint, expectation, healthcare system

BR-065

The “Big Data” Patient

Naldy Parodi López

Närhälsan, Västra Götaland, Sweden

Justification:

I am used to have many patients, most of them young people, who know exactly what kind of treatment they need. The potential disease is quite well known by them. When I ask the patient: How do you know that? Have you been with another doctor? I always hear: No, I read about it in the Internet. That answer surprises me frequently. A person who is well informed about how to handle a disease, what kind of laboratory tests we should order and where to be sent in order to have further investigation is always a challenge!

Content:

Meeting a patient who is almost sure about a diagnosis is not easy. Sometimes, they come with a list of symptoms and laboratory tests they need. The issue is that somehow my medical approach is conditioned by that suspected diagnosis and it is not easy to escape from that investigation line. Extra laboratory tests, more workload and wasting time is the result of that.

Is that defensive medicine? Yes, I think so. It is defensive medicine since I feel the pressure to exclude a disease because of a patient's newly acquired medical knowledge. The combination of not verified medical information on the internet and fear of illness brings negative consequences to patients increasing their anxiety and to the Healthcare System rising the cost.

However, there are some patients who are right. I met a 17 years-old women who wanted a derivation to a specific hospital for breasts operation. She had breasts deformity. I did not know the diagnosis but she illustrated me, tuberous breasts. This patient had already been in contact with the hospital which do plastic surgery for that condition and just wanted a medical derivation. That is a well informed “Big Data” patient!

Keywords: Internet, Healthcare System, Anxiety

BR-066**Pulse Measuring in Clinic**

Suat Sincan

Student Health Center, Ataturk University, Erzurum, Turkey

Dehydration is very important that patients with prediagnosis influenza especially. Therefore, I measure the pulse of every patient with pulse oximetry or digital sphygmomanometer for arm. Patients are often surprised to see hands on a device fitted electronically sounds. Everytime, I tell the patients with high pulse without fever that hydration is very important than drugs. Such patients are often told they can not get enough fluids. Only with measuring pulse oximeter, I would be directing the attention of the patients received adequate fluid. In this way, my patients become happy and satisfied and go to their sweet home as psychologically relaxed.

Keywords: Flu, pulse-oximeter, Hydration

BR-067**One country, two types of medicine**

Laura Montesinos Ramon

Centro de Salud Burjassot 1, Departamento de Salud Arnau de Vilanova-Llíria, Valencia, Spain

We have made an exchange in USA with the FM360^o program (VdGM) in 2015. We would like to tell European Family Medicine Doctors our experience in Chicago and in Plainville (Kansas), because it is one of the most interesting things we have ever done during our residency as a Family Doctor. The opportunity to stay in two different areas, the rural one in Kansas and the urban one Chicago, has given us a general view of the country and we have learnt a lot about the American medicine and the american culture. In the village everything goes slowly and the medical resources are less than in the urban areas. As well, the number and the kind of patients is different. In Kansas people are older than in Chicago, and Doctors there, know the patients, their families, their problems, the kind of life, this give rural doctors a lot of information of the patients and the relationship between patient and doctor in more fluid and close than in the city. With this experience we have learnt a lot about The American Health system as well. It is very different if we compare generally with our European health systems. The big part of the American system is private and managed by Insurance Companies, but nowadays things are changing, and we have had de opportunity to see this. Now, exists "Obama Care". This new system allows that people without money can access to the health system, sometimes with restrictions but they can have medical basic assistance. We recommended to others residents and physicians this experience, because gives you the opportunity to learn about other health system, compare it with yours, and teaches you to understand the best things of our health systems and to learn the things that can be changed or modify.

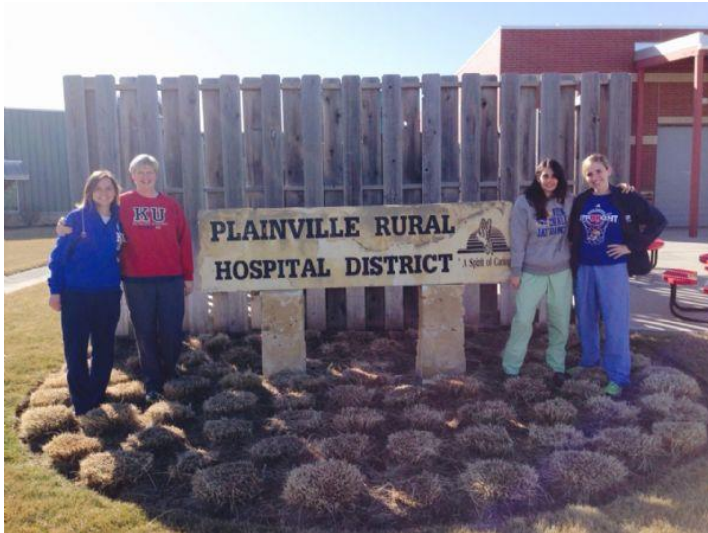
Keywords: Rural medicine, urban medicine, exchanges, health system

In Northwestern University



With Dr Clements in Feinberg School of Medicine, Northwestern University, Chicago

Rural Rotation in Plainville



This is a Picture with DR Brull in Rooks County Health Center

Urban Rotation in Chicago



This is a picture with Dr Sha and the family medicine residents in Erie Family Health Center, Chicago

BR-068

Using teledermatology effectively in rural Primary Care settings

Josep Vidal Alaball

EAP Artés, Gerència Territorial de la Catalunya Central. Institut Català de la Salut. Catalunya & semFYC Rural Working Group. Spain

It has been known for the last 2 decades that telemedicine provides better access to users in addition to reducing the waiting time between diagnosis in primary care and hospital.

In the Catalanian central region, two counties, Bages and Berguedà, have developed a teledermatology programme, which have had considerable success in reducing waiting lists while having wide acceptance among patients. This service is especially useful in rural areas where has been able to attend thousands avoiding unnecessary trips.

I would like to share my experience first as a manager implementing the teledermatology programme in 2010 and now working as a rural GP and actively using this service in my day-to-day work.

Keywords: Telemedicine, teledermatology, telehealth, dermatology, rural medicine

BR-069

Building up a Family Health Center

Nilgun Yapan Goral

12th Family Health Center of Sehzadeler County, Manisa, Turkey

I made a contract to settle 12th Family Health Center of Sehzadeler County at Manisa Province on 1st of December, 2015. After I signed the contract, first 3 months was a tough and costly period of finding a suitable property, construction and obtaining essential equipments required for an A class family health center unit. On 2nd of March I began working as Family Medicine Specialist. According to my contract I had to get at least 1000 patient registrations to my own unit during the first year. So I prepared brochures and arranged meetings to introduce our unit. While my similar colleagues have to make 60-100 outpatient examinations, I had only 10-20 on daily practice. By this way I could ideally perform recording my patients' informations, preventive medicine, screening programmes and personal consultations.

Keywords: Family Health Center, new family health unit,

12th Family Health Center of Sehzadeler County at Manisa



New Family Health Center

BR-070**Differences and similarities between the family medicine systems of Turkey and Spain**

Burcu Başaran

Department of Family Medicine, Marmara University, Istanbul, Turkey

I want to share my exchange experience with all family medicine practitioners. It was a very useful and enjoyable experience for me. I have spent two weeks there. First of all I had looked the site of Vasco De Gama, participating country link to choose the country, which I wanted to go. Then I choose the clinic. This was a very big chance for me, if it is possible everyone must try this experience. I offer everyone. If you join my BRITE session you will also learn lots of things about differences and similarities between the family medicine systems of Turkey and Spain.

Keywords: family medicine system, Turkey, Spain

BR-071**BRITE: Socio Economic Situations and Health Care**

Clare Wilson

Severn Deanery UK

Title: Working with prisoners

One of the hardest group of patients I work with in primary care is ex prisoners. They often arrive from prison with no health records and requests for medication with risk of addiction, they have huge often unaddressed health needs and precarious social situations. I end up booking follow up appointments to deal with these multiple issues but these are often not attended. If a prescription is issued I often only gave a week's supply of medication to ensure that the patient attends a further review. How do you tackle the varied physical and mental health needs of ex-prisoners often including drug dependency and how to you keep them engaged with their health?

Keywords: Prisoners, socioeconomic problems, health needs

BR-072**How Can We Diagnose Obstructive Sleep Apnea in Primary Care?**

Senem Buğdaycı

Department of Family Medicine, Marmara University, Istanbul, Turkey

Everyday i see many patients with chronic obstructive pulmonary disease, hipertension, coronary artery disease, etc. As it is well known many complications, mainly pulmonary and cardiac diseases are associated with Obstructive Sleep Apnea (OSA). We know how important OSA is. However, to diagnose it in primary care is not easy. Polysomnography is the gold standart diagnostic test but due to the need for qualified personnel and the limited number of sleep clinics, it is expensive and difficult to reach. There are several questionnaires for screening, but their sensitivity and specificity values are questionable. Therefore a screening tool is necessary for primary care patients, to identify who should undergo polysomnography, based on their clinical symptoms, their physical examinations, and their risk factors.

What is your opinion? How can we diagnose OSA in primary care?

Keywords: Obstructive Sleep Apnea, Diagnosis, Questionnaire

BR-073**Obesity follow-up in Primary Care**

Emre Yilmaz

Family Medicine Department, Marmara University Hospital Pendik Training and Research Hospital, Istanbul, Turkey

When I decided to do a clinical research on obesity, I saw that very few patients visit the outpatient clinic. Then I called patients and asked " why don't you come over your follow up?". Almost all of the patients said that they were failed with their eating habits and increasing physical activities of daily living. They also complained about that they tried to lose weight before many times and every time lost their motivations instead of losing weight. Well, what can you recommend to increase the motivation of the patient with obesity and to speed up the process of losing weight and what are your experiences on this subject ?

Keywords: obesity, follow-up, primary care

BR-074**Adulthood vaccines: Do we suggest to our patients and do they accept?**

Hülya Akan

Yeditepe University, Medical Faculty, Department of Family Medicine; İstanbul

Expanded Childhood vaccination program in Turkey covers over 98% of children and well accepted by parents; so it is one of the best good health practice in Turkey. On the other hand adulthood vaccination is comparatively new and current topic. Some recommendations have been changed or added recently. For example pneumococic vaccination recommendations have been changed; varicella and pertusis vaccines have been added. My personal experience is that very few physicians recommend vaccination to their adulthood patients regularly and have difficulty to follow up-to-date recommendations.

Another point is that even I regularly ask to my every patient about vaccination status and do recommend needed ones, I face with a strong resistance especially in elderly. I feel that the idea of " vaccination of adults " is strange in means of senses for them.

In this session I hope to share our experiences about difficulties in adult vaccination and how to overcome barriers and also I want share the new " Adulthood vaccination guideline" that during preparation I have been a part of working group.

Keywords: Preventive medicine, adulthood vaccination, vaccination

BR-075**Assessment Of Medical Practice in Low Prevalence Diseases In Primary Care**

Giray Kolcu

Ulurmak Family Medicine Centre no. 12 in Karatay, Konya

Knowledge amount has expanded around the whole world with the rapid development in medical science. Within such intense knowledge environment, medical practice in low prevalence diseases in primary care is getting more difficult each day.

We aimed to do knowledge exchange with you in order to develop a basic patient approach model for performing safe medical practice in low prevalence diseases.

What about contributing to our perspective towards low prevalence medicine in primary care by sharing your knowledge and experiences with us?

Keywords: medical practice, low prevalence diseases, basic patient approach model

BR-076

Safety Of Family Medicine Centres - Determination Of The Situation

Giray Kolcu

Ulurmak Family Medicine Centre no. 12 in Karatay, Konya

Family medicine practice has a structure where the patient and healthcare personnel are in close contact with each other and which is affected by the entire socio-cultural environment within its service location. In recent periods in which the criminal cases and cases of violation against healthcare professionals are being increased in healthcare facilities, the situation of family medicine centres is discussed often.

What about assessing the safety situations and measures to be taken in the family medicine centres with us?

Keywords: family medicine center, safety, violence

ORAL PRESENTATIONS

OP-001

Characteristics of the diagnosis of Violence against women in a Regional Health Service

Rosario Morales López¹, José Miguel Bueno Ortiz², José Jesús Guillén Pérez³, Celia Alshail López Blanco¹, José López González⁴, Sandra Jiménez Rejón⁵

¹Centro de Salud Cartagena-Oeste. Servicio Murciano de Salud

²Centro de Salud Fuente Álamo. Servicio Murciano de Salud

³Consejería de Sanidad Comunidad Autónoma Región de Murcia

⁴Centro de Salud Cartagena-Este. Servicio Murciano de Salud

⁵Centro de Salud La Unión. Servicio Murciano de Salud

BACKGROUND: Violence against women (VAW) is an important problem of Public Health. Primary Care (PC) is critical in its approach and the best place for early detection.

OBJECTIVE: To know more about VAW-PC cases.

METHOD: Design: Observational, descriptive, cross-sectional. The study was performed in Primary Care.

Population: Family doctors (FD) of a Regional Health Service (N=829). Selection Criteria: Systematic random sampling (n=263) (e) 5%, (p) 50%. FD Self-administered questionnaire related to their patients' medical diagnoses in the last 10 years. Variables: age, type of abuse, professional who has diagnosed the problem, existence of prior suspicion, number of medical consultations in the last year and consumption of psychotropic drugs. The statistical analysis SPSS 21.0. Approved by the Regional Clinical Research Ethics Committee.

RESULTS: Answers: 233 FP (88,59%).

Number of cases of VAW diagnosed per FD: 0: 44 FD (18.84%); 1: 54 FD (23.11%); 2: 64 FD (27.46%); 3: 38 FD (16.30%); 4: 18 FD (7.72%); 5: 11 FP (4.72%); 6: 2 FD (0.85%); 7: 2 FD (0.85%). Total: 415. Mean 1,78.

Detection: FD: 288 (70.1%); nurse: 26 (6.3%); Hospital emergencies: 26 (6.3%); social worker: 20 (4.9%); police: 20 (4.9%); Primary care emergencies: 16 (3.9%); Others: 15(3.6%)

Age of victims: 14-87. Mean: 50.

Number of consultations last year: 0-40. Mean: 8.

Treatment with Psychotropic Drugs: Yes: 268 (27.8%), No: 133 (33.2%).

Type of abuse: Physical: 267 (65%); Psychic: 290 (70.6%); Sexual: 4 0(9.7%); Economic: 60 (14.6%); Environmental: 18 (4.4%)

CONCLUSIONS: Each FD has diagnosed in last 10 years a mean of 1.78 VAW cases. The detection has been performed more frequently by FD without previous suspicion of VAW. The VAW victim's average age is 50 years, consulted on 8 times to their FD in the last year and consume psychotropic drugs. Mental and physical are the most frequent types of abuses suffered.

Keywords: Violence against Women, Diagnosis, Family Doctor.

OP-002

Knowledge, attitudes and skills of Polish physicians in management of domestic violence

Anna Krztoń-Królewiecka, Katarzyna Nessler, Monika Storman, Jolanta Majchrzak-Król, Izabela Jałowiecka, Anna Tarczyńska, Adam Windak

Department of Family Medicine, Jagiellonian University Medical College, Krakow, Poland

BACKGROUND & AIM:

Domestic violence is a significant worldwide problem. Domestic abuse is more prevalent among women seeking healthcare than in the general population. Healthcare professionals, especially family doctors, are potential sources of support for victims of domestic violence. The aim of the study was to analyze Polish doctors' knowledge, attitudes and skills in identifying and intervening in cases of suspected abuse.

METHOD:

A cross-sectional survey was carried out among 250 randomly selected doctors in Poland. The study tool was a translated and adapted for use in Poland version of developed and validated in the United States questionnaire PREMIS - Physician Readiness to Manage Intimate Partner Violence Survey. The anonymous questionnaire included five sections: respondents' characteristics, perceived readiness and knowledge, practical issues, actual knowledge and opinions. Descriptive statistics and Chi-square test were used for statistical analysis.

RESULTS:

The response rate was 52,4%. Every third respondent had a specialization in family medicine. The majority of respondents (72%) feel that they do not have sufficient training to assist individuals in addressing situations of domestic violence and 62% think that doctors do not have enough time to help patients with domestic abuse problem. Almost half of respondents (47%) faced or suspected domestic violence case in their practice. The plurality of doctors (87%) took some actions in the suspected case of domestic abuse, this was most frequently documenting the victim's injuries in patient's medical chart (85%). Lack of experience in suspected cases of domestic violence was more often declared by family physicians than other specialists (63% versus 40%, $p=0,013$).

CONCLUSIONS:

Doctors play an important role in addressing domestic violence, but their knowledge and behavior in the area seems to be not satisfying. The findings indicate a great need for a comprehensive training for physicians in domestic violence recognition and intervention.

Keywords: Domestic Violence, Health Knowledge, Attitudes, Practice, Physician's Practice Patterns

OP-003

Intimate Partner Violence (Mis)Perceptions of Turkish Men and Women

Hatice Kurdak¹, Yeşim Incecik², Nafiz Bozdemir¹

¹Çukurova University, Department Of Family Medicine

²Başkent University, Department Of Family Medicine, Seyhan / Adana

BACKGROUND & AIM: Over the past years, Turkey has been witnessing the devastating consequences of intimate partner violence (IPV). Relativeness and complexity in the perceived norms of violence may interfere with diagnosis. This cross-sectional study aims to determine IPV perceptions and experiences of men and women in primary care.

METHODS: Socio-demographic variables, IPV experiences and perceptions were investigated among the applicants of two primary care units from central Adana during one month. Of the 271 applicants, 38 were excluded. Surveys were conducted face-to-face and confidentially.

RESULTS: Of the enrolled, 70% were women. The women's mean age was 44.5±13.1 and men's was 47.0±14.9. Among participants 97.1% men and 26.2% women had their own income. Of the women 39.3% and of the men 51.4% had at least college education. All participants agreed that pushing, manhandling, hair pulling, kicking, dragging, beating, choking and threatening with knife are violence. The percentages of participants who did not acknowledge the other actions as violence are shown in Table-1. The highest misperceptions were on economical IPV. "Victims of IPV may have deserved it" statement found 41.7% supporter in both genders; 39.3% women and 44.3% men agreed on "violence is a private matter, not the business of others" statement. The percentages of participants who answered, "yes" to the sexual abstinence scenario and questions are given in Table-2. The IPV percentages and relations to the perception statements are given in Table-3.

CONCLUSIONS: Even tough IPV victims are mostly women; the percentages of men who experience IPV are remarkably high. The misperceptions about economical and sexual IPV are evident. We may assume that this may affect people's IPV acknowledgement, experiences and may interfere with diagnosis. Therefore understanding the IPV perceptions are essential for family practitioners who has a professional responsibility in comprehensive approach and holistic modeling while managing health problems.

Keywords: Intimate Partner Violence, Perception, Men, Women

The percentages of participants who did not acknowledge the actions as violence (Women's n= 163, men's n=70)

	Women n (%)	Men n (%)
Slapping	1 (0.6)	2 (2.9)
Throwing something	1 (0.6)	1 (1.4)
Humiliating	1 (0.6)	3 (4.3)
Forcing to sexual activity	1 (0.6)	0
Forcing into certain sexual position	1 (0.6)	0
Forcing to prostitution	1 (0.6)	0
Squeezing a body part	2 (1.2)	3 (4.3)
Insulting, swearing	2 (1.2)	2 (2.9)
Humiliating sexually	2 (1.2)	0
Forcing to watch pornography	3 (1.8)	1 (1.4)
Intimidating	3 (1.8)	2 (2.9)
Threatening to harm spouse or spouse's loved ones	3 (1.8)	2 (2.9)

Taking away spouse's earnings	5 (3.1)	1 (1.4)
Isolating from economic/spiritual support	19 (11.7)	9 (12.9)
Withholding or cutting back necessary household expenses	19 (11.7)	10 (14.3)
Hindering from or forcing to quit a job	50 (30.7)	19 (27.1)

Statistical analysis did not performed due to low numbers.

The percentages of participants who answered "yes" to the perception statements (Women's n= 163, men's n=70)

	Women n (%)	Men n (%)	p
Is sexuality duty in an intimate relation?	64 (39.3)	31 (44.3)	0.475
Scenario: If you have to be in sexual abstinence for a period of time due to a health problem, would you encounter any sort of problem with your partner?	48 (29.4)	6 (8.6)	0.001
Have you ever encountered a similar situation?	29 (17.8)	1 (1.4)	0.001

The overall IPV percentages and their relations to some of the perception statements (Women's n= 163, men's n=70)

IPV	Women n (%)	Men n (%)	p
At least once experienced physical or emotional IPV in lifetime	77 (47.2) β, δ	22 (31.4)	0.025
At least once perpetrated physical or emotional IPV in lifetime	43 (26.4) δ, γ	20 (28.6)	0.730
Physical in the last year (victim) \dagger	9 (5.5) γ	3 (4.3)	0.755*
Physical in the last year (perpetrator) \dagger	1 (0.6)	8 (11.4) γ	0.001*
Emotional (victim)	76 (46.6) $\alpha, \beta, \delta, \epsilon$	21 (30.0)	0.018
Emotional (perpetrator)	23 (14.1) α, ϵ	24 (34.3) γ	0.001
Economical (victim)	54 (33.1) α, β, δ	4 (5.7)	0.001
Economical (perpetrator)	1 (0.6)	11 (15.7) β	0.001*
Sexual (victim)	31 (19.0) β, δ	3 (4.3)	0.003
Sexual (perpetrator)	0	9 (12.9)	0.001*

α Significant relation to the "Is sexuality duty in an intimate relation?" question β Significant relation to the scenario question δ Significant relation to the "Have you ever encountered a similar situation?" question γ Significant relation to the "Victims of IPV may have deserved it" statement ϵ Significant relation to the "Violence is a private matter, it's not the business of others" statement *Fisher's Exact Test \dagger women's n=144 men's n=68

OP-004

Violence, Honor And Honor Crimes: The Vicious Cycle

P. Gamze Erten Bucaktepe¹, Vasfiye Demir², Ismail Yıldız³, Tahsin Çelepkolu², Leyla Erik Duman², Yeşim Cengiz Balyen², Nuriye Mete⁴

¹Family Medicine Department, Medical Faculty and Women's Research and Implementation Center, Dicle University, Diyarbakır, Turkey.

²Family Medicine Department, Medical Faculty, Dicle University, Diyarbakır, Turkey.

³Biostatistics and Medical Informatics Department, Medical Faculty, Dicle University, Diyarbakır, Turkey.

⁴Biochemistry Department, Medical Faculty and Women's Research and Implementation Center, Dicle University, Diyarbakır, Turkey.

BACKGROUND AND AIM

Violence against women is an escalating problem in the world. Despite the governmental policies, the number of women killed in the name of honour is growing each year. The underlying reason is portrayed to emerge from the perception that a dishonourable act by a woman brings shame to the family. This study focused on students to assess their attitudes towards violence, honour (ATH), and honour crimes against women (ATHCAW) and to investigate the relationship between these notions.

METHODS

The students (n=2370) were selected from Dicle University Faculties by stratified sampling method. Previously validated and reliable questionnaires, which queried the attitudes towards violence, ATH and ATHCAW were administered between February 15-March 31, 2014. All the data were analysed using SPSS 21.0.

RESULTS

The participants comprised 1088 (45.9%) females and 1282 (54.1%) males, with a mean age of 22.4±3.3 years. Eye-witnessing the violence was detected in 41.5% and being subjected to violence was found in 40.2% of the students.

The statistics revealed a positive correlation between being subjected to violence and both Machismo Scores (MS) ($r=0.100$, $p<0.0001$) and Acceptance of Violence Scores (AOVS) ($r=0.107$, $p<0.0001$).

The MS and AOVS of the students established positive correlations with the ATH ($r=0.292$, $p<0.0001$; $r=0.297$, $p<0.0001$, respectively) and the ATHCAW ($r=0.394$, $p<0.0001$; $r=0.437$, $p<0.0001$, respectively).

Some other factors effecting ATH and ATHCAW are found to be male gender ($p<0.0001$ and $p=0.001$); rural origin ($p<0.0001$ and $p=0.039$); father's education level ($p<0.0001$ and $p<0.0001$) and mother's education level ($p<0.0001$ and $p=0.003$).

CONCLUSION

Our study revealed a positive correlation between inclination to violence, ATH and ATHCAW. Violence, despite being an intractable social problem, could be solved by root cause analysis. Integrating methods for recognizing the underlying causes and terrible consequences of violence into the educational and social policies should be the first step.

Keywords: Violence, honor, honor crimes

OP-005

Deaths of fertile women from violence in Goiânia in 2013

Lara Louise Guimaraes Silveira¹, Rickella Aparecida Alves Moreira¹, Ana Luisa Franco Moura¹, David Carvalho Resende¹, Wallace Pinheiro Rodrigues¹, Lorena De Almeida Ribeiro Prudente¹, Gustavo Aguilar Alvarenga Amorim¹, Vinicius Bernardes Mendonça Damasceno¹, Ayssa Teles Abrao Trad³, Natalia Jacomo Auad⁴, Natalia Carasek Matos Cascudo¹, Camila Garcia De Souza²

¹Universidade Federal de Goiás, Goiás, Brazil

²Pontificia Universidade Catolica de Goias, Goias, Brazil

³Pontificia Universidade Catolica de Sao Paulo, Sao Paulo, Brazil

⁴Centro Universitário Municipal de Franca, Sao Paulo, Brazil

Background & Aim

Urban violence is an evil that plagues all communities living in urban centers. It covers any action that reaches the laws, public order and people. There are many causes of violence, such as unemployment, trafficking in general confrontation between rival gangs, lack of political influence, sexism, discrimination in general and many others. Although all causes cited, the most important of these is the poor distribution of income that results in the deprivation of education and better housing. All this vicious circle originates from the lack of conditions for a dignified life that makes people traverse illegal and criminal ways.

Method

It is a descriptive research carried out in the Health Information Division of the Department of Epidemiology of the Municipal Health Department of Goiânia-Goiás. It was used as a collection tool women from death certificates of childbearing age (10-49 years) living in Goiânia with the DATASUS data. The period of investigation corresponds January to December 2013.

Results

In 2013 471 women were killed at childbearing age, and of these 82 women (17.4%) died as a result of urban violence (here considered as homicide and car accidents). Deaths can urban violence together are the leading cause of death of fertile women in Goiânia cited above period.

Conclusions

Thus we can conclude that the mortality of the population goes beyond policies aimed just health care. It is very important that public policies about safety, sanitation, education and others are strengthened so that people get their basic right to health and life that is enshrined in the Brazilian constitution.

Keywords: Violence, fertility woman, deaths

OP-006

The motivation's wall

Silvia Membrilla Pastor, Maria Àntonia Requesens Catalan, Nuria Pérez Gutierrez, Maria Josefa González Irigoyen, Laura Illamola Martin, Annabell Torres Rodriguez, Esther López Gonzalo, Gemma Moreno Fernández, Jordi Juncosa, Maria Rosa Luna Gámez, Elena Ramos Corbella

CAP RAMONA VIA. EL PRAT DE LLOBREGAT

BACKGROUND

In recent years we are experiencing a constant discomfort in our care work. Dada the economic situation and cuts in health budgets there are difficulties in the organization and in compliance with protocols, lack of staff and saturation of the consultation do we present a high degree to burn out. This involves different decision-making from the direction of the health team with goals that fail to achieve the level of success they would like. It is not always easy to manage assistance well and optimize results. Demotivated staff. Address disappointed. Difficult empathy.

TARGET

Improve the motivation and welfare of the health team

METHOD

We decided change the messages received with negative tone for positive messages, acknowledgments, and any manifestation optimistic reflections on a positive way we think we can share with our colleagues.

Given the viral effect of Facebook we decided to share all that on a wall: the Motivation's wall. It hangs in the coffee hall to enhance the positive meeting.

At the beginning of the experience we spent a MBI (Maslach Burnout Inventory) test to determine the previous state of the participants.

The wall remains suspended for one month and after people again pass the test.

CONCLUSIONS

The numerical results (changes expected test score) are awaiting the final count. Subjectively we have seen signs of improvement in sharing more whiles in the coffee room which speaks about the wall and less comments in negative way like complaints. Daily reading of positive sentences, involving people outside the team who have felt attracted by the proposal (paramedical staff, staff from the hospital who attend on another floor of our center, etc) and working together have done carry out participatory team and changing to positive attitudes

Keywords: Motivation Burn out Facebook

OP-007

Evaluation of Prescription Requests in Primary Care: A Multi-central Study

Erdoğan Yavuz¹, Erol Yayla², Mehmet Ünlüsoy³, Tolga Vural⁴, Saide Eda Cebeci⁵, Ilker Boler⁶, Yasemin Karaşör Türker⁷, Serkan Özdemir⁸, Emrah Kırımlı⁹, Ekin Saba¹⁰, Yeşim Uncu¹¹

¹1st Family Healthcare Center Rize, Turkey

²2nd Family Healthcare Center Afyon, Turkey

³Mecitözü Family Healthcare Center Çorum, Turkey

⁴1st Family Healthcare Center İncirliova Aydın, Turkey

⁵Serdivan Family Healthcare Center Sakarya, Turkey

⁶Siyavuşpaşa Family Healthcare Center İstanbul, Turkey

⁷3rd Family Healthcare Center Düzce, Turkey

⁸İnönü Family Healthcare Center Trabzon, Turkey

⁹5th Family Healthcare Center İstanbul, Turkey

¹⁰2nd Family Healthcare Center Antalya, Turkey

¹¹Uludağ University Department of Family Medicine, Bursa, Turkey

Turkish primary care has undergone a drastic change starting in 2004. Now, 21,175 family physicians (FPs) provides health care at 6,756 family healthcare centers. Each FP has an average of 3,621 registered patients. In a previous study we analyzed a working day of a FP and we found out that more than a quarter of a FP's daily workload consisted of prescription requests of their patients (28%). We aimed to evaluate the characteristics of these requests in order to have a better understanding the reasons beyond such frequent requests and help physicians and healthcare decisionmakers to take necessary actions to alleviate this burden.

21 FPs from 19 different cities in Turkey participated in the study. The participants were asked to record number of prescription requests all day and the first 20 drugs requested from the patients each day and the characteristics of these requests in working days of a week.

Majority of the patients described their requests by showing the box of the drugs (36,6%). 34% of all prescription requests were with an exemption report issued at secondary or tertiary healthcare facilities. The patients with exemption reports most frequently requested drugs for essential hypertension, diabetes mellitus type 2 and chronic obstructive pulmonary disease; respectively. They have been using these drugs for an average of 4,14 years. Majority of the requests without an exemption report were found to arise from the patients' desire to continue the same drug once prescribed by a doctor for the same complaint (56%). The most frequent three complaints for these requests were stomachache, headache and abdominal pain; respectively. Of these requests 8,2% were off-label use and 17,7% of these drugs were used in an incorrect fashion.

An important portion of prescription requests to FPs arose from other healthcare facilities

Keywords: Prescription requests Turkish primary care

OP-008

Neurophobia; an Mthy or an Unpleasant Fact for Primary Care Physicians in Turkey

Bektas Murat Yalçın¹, Özlem Midik², Onur Öztürk³

¹ONDOKUZ MAYIS UNIVERSITY MEDICAL FACULTY DEPARTMENT OF FAMILY MEDICINE

²ONDOKUZ MAYIS UNIVERSITY MEDICAL FACULTY DEPARTMENT OF MEDICAL EDUCATION

³ATAKUM PUBLIC HEALTH CENTER

Background and AIM: Many primary care physicians are reported as they are not comfortable in situation which needs neurological knowledge or skills. This phenomenon is first described as “Neurophobia” which is explained as the fear of the neural sciences and clinical neurology that is due to the clinician’s inability to apply their knowledge of basic sciences to clinical situations. The aim of this study is to determine if there is a problem with the management of primary care physicians to patients who had neurological disorders.

Matherial and METHOD: This is a cross-sectional analytic study. A total of 384 primary care physicians who were attending the 5th, 6th and 7th meetings of the Family Practice Academy Research Days between May 2014 to April 2015 (They were held at Çanakkale, Ankara and Hatay) were included into the study. All of the participants answered a 16 question survey (Ten point Likert 1=mostly disagree, 10=mostly agree) comparing their general interest, favorability, professional confidence, perceived hardness of several subspecialties. They also ranked the most common neurological problems / diseases they encountered and their confidence of performing neurological physical examination.

RESULTS: Neurology is the second most disliked subspecialty (5.66 ± 0.8), second perceived hardest to practice (5.65 ± 2.6), and second subspecialty they feel unconfident in clinic (7.6 ± 0.9) (first subspecialty was oncology in all three items). The most frequent neurologic disorder they encounter was headache (7.7 ± 0.6) and the most frequent neurologic disorder they refer was paresis (8.72 ± 0.9). Most of the physicians stated that they (302, 79.0%) they didn’t feel full confident about to perform a neurological physical examination. Physicians stated that they mostly unable to perform a fundoscopic physical examination (345, 90.3%).

CONCLUSION: Neurophobia may be an important problem for primary care physicians. Neurology should be added to family medicine residence curriculum and this problem should be solved with rotations.

Keywords: Neurology, Neurophobia, residence education, family medicine,

OP-009

Brief interventions to prevent recurrence and alcohol-related problems in young adults following an alcohol-related event: a systematic review

Victoire Merz¹, Juliette Baptista¹, Dagmar M. Haller²

¹Faculty of medicine, University of Geneva, Geneva, Switzerland

²Adolescent and Young Adult Program, Geneva University Hospitals, Geneva, Switzerland

Background & AIM: acute alcohol intoxication is a major concern for public health in terms of somatic, psychologic and social risks. Whereas brief interventions addressing harmful alcohol use in adults admitted to emergency wards have been shown to be effective, interventions aimed at adolescents tend to be less conclusive. We put forward the hypothesis that young adults (18 to 24 y-o)(who share developmental characteristics with adolescents whilst receiving care in adult services) could benefit from interventions to reduce the recurrence of alcohol-related events and their consequences when admitted to emergency wards following alcohol intoxication.

METHOD: PRISMA guidelines were followed to conduct this review. We searched Medline, Embase, Cochrane and PsychINFO until March 2014. The retained articles had to fulfill the following criterias: randomised trials of brief interventions on young adults (18-24 years old) admitted to an emergency ward following an alcohol-related event. The main outcomes were the effect on alcohol consumption in terms of quantity and frequency, and the alcohol-related risks. A descriptive analytical approach was adopted.

RESULTS: four trials (n=618) were included, comparing a brief motivational interview with usual care (2 trials), personalised feedback or an educational brochure. In two studies motivational interview was significantly associated with a reduction in alcohol-use whilst two studies showed no effect. Successful interventions were either delivered at a distance from the event or included booster sessions. Motivational interview favoured a reduction in alcohol-related problems in all but one study. Benefits were sustained over twelve months.

CONCLUSIONS: the evidence is inconclusive but the most effective interventions include at least one therapeutic contact several days after the event. Further research should provide more guidance about effective interventions in this age-group, including the potential role family doctors can play in the follow-up of young people after an alcohol-related emergency admission.

Keywords: alcohol intoxication / prevention and control, early intervention prevention, primary health care

OP-010

Risk factors prevalence in adult Community Acquired Pneumonia in Primary Care in Spain (NEUMO-ES-RISK project)

Irene Rivero¹, Jacobo Pardo², Pablo Aldaz³, Diego Agustín Vargas⁴, Enrique Mascarós⁵, Esther Redondo⁶, Jose Luis Díaz⁷, Manuel Linares⁸, María José Fierro⁹, Ángel Gil¹⁰, Jesús Molina¹¹, Daniel Ocaña¹², Federico Martínón Torres¹, On Behalf Of Neumoexpertos¹³

¹Translational Pediatrics and Infectious Diseases Section Pediatrics Department, Hospital Clínico Universitario de Santiago de Compostela, Santiago de Compostela, Spain.

²Genetics Vaccines Infections and Pediatrics Research Group (GENVIP), Healthcare Research Institute of Santiago de Compostela, Santiago de Compostela, Spain.

³Member of the preventive infectious disease group PAPPs-SEMFYC. Primary Health care Center San Juan. Pamplona. Spain

⁴Versatile unit hospitalization, Hospital for High Resolution El Toyo. Public Sanitary Agency. Hospital de Poniente. Almería. Spain

⁵Health Care Center Fuente de San Luís, Hospital Dr Peset Health Department Valencia, Spain

⁶Preventive and Public Health Activities Group SEMERGEN. International Health Center. Madrid. Spain

⁷Primary Care Health Center, Guadalajara, Spain

⁸Infectious Diseases Group SEMERGEN. Fundación io.

⁹Primary Care Health Center El Olivillo. Cádiz. Spain

¹⁰Professor of Preventive Medicine and Public Health at the Rey Juan Carlos University. Madrid. Spain

¹¹Primary Care Respiratory Group. Health Care Center Francia. Fuenlabrada. Madrid, Spain

¹²Primary Care Respiratory Group. Health Care Center Algeciras, Spain

¹³NEUMOEXPERTOS group is composed by: F. Martínón-Torres; P. Aldaz, D. Vargas, E. Mascarós, E. Redondo, J.L. Díaz Maroto, M. Linares, M.J. Fierro, A. Gil, J. Molina, D. Ocaña

Background & AIM: Several lifestyle factors and comorbidities have been linked to an increased risk for Community-acquired pneumonia (CAP), although their prevalence has not been well documented. The aim of this study is to assess the prevalence and distribution of risk factors in primary care CAP.

METHOD: Retrospective observational study in adults with CAP at primary care in Spain between 2009-2013, using the National Surveillance System of Primary Care Data (BiFAP).

RESULTS: 28.413 patients. Mean age (standard deviation): 60.5(20.3) years. 51.7% males. Average prevalence of comorbidities was 71.3%, which increased with age, doubling the risk in males by the age of 75 (females 20% vs males 40%). From 55 years of age at least one risk factor (RF) was identified in 85.7% of cases: 1 RF(23.8%), 2RF(23.4%), 3 or more RF(38.5%). Major risk factors were: metabolic disease(27.4%), cardiovascular disease(17.8%) and diabetes(15.5%). According to gender: a) women= metabolic diseases(26.9%), depression(20.0%), anemia(15.8%); b) men= metabolic disease (27.8%), cardiovascular disease (20.5%), diabetes (17.9%). According to age: a) 18-25 years= poor dental hygiene(9.1%), smoking(8.0%), asthma(7.8%); b) 25-40 years= smoking(13.5%), poor dental hygiene(10.0%), anemia(7.1%); c) 40-55= smoking(20.9%), metabolic disease(17.7%), depression(12.0%); d) 55-70 years= metabolic disease(40.4%), smoking(18.3%), diabetes (17.9%); e) 70-85 years= metabolic disease(41.5%), cardiovascular disease(33.0%), diabetes(28.9%); and f) over 85 years= cardiovascular disease(39.3%), metabolic disease(27.5%), anemia(25.6%).

CONCLUSIONS: Prevalence of risk factors in adult CAP in primary care in Spain is high. Main risk factors associated are cardiovascular disease, metabolic disease and diabetes. CAP risk increases with age and doubles in males older than 75 years. Majority of CAP cases beyond 55 years of age associate at least 1 risk factor.

Keywords: Community acquired pneumonia, risk factors, Primary care

OP-011

Assessment of patients applying to emergency department in terms of primary care

Zehra Dağlı, [Burcu Gürhan](#), Bora Taylaner, Ayşe Selda Tekiner, Ayşe Gülsen Ceyhun Peker, Mehmet Urgan
Department of Family Medicine, Ankara University, Ankara, Turkey

OBJECTIVE: The study aimed to determine reasons of the patients applying to emergency department (ED), how often they used primary care and referral chain, and how much they really needed ED services.

METHODS: Patients who applied to a university hospital ED in October 2013 and February 2014 completed a questionnaire. Patients' health conditions were determined by family physicians (FPs) through triage color coding system. Descriptive statistics were given as mean±standard deviation and percentage. Chi-square test was used for differences between the groups. Any $p < 0.05$ was considered statistically significant.

RESULTS: Mean age of 87 patients (55.2% male, 44.8% female) was 39.11 ± 19.40 years. Majority of the participants had social security (89.7%) and 88.5% perceived their conditions urgent. The most common presenting reasons were "to receive health care urgently" (68.9%), "to be treated immediately" (44.8%). The patients would not apply to ED mostly "if the procedures were faster at daytime outpatient clinics" (36.8%), "if there were night outpatient clinics" (32.2%). The patients, most of whom were registered to a FP (82.8%), presented to ED most frequently for "their own will" (44.4%). While the patients were mostly content with ED service (89.7%), discontent patients mostly complained about "slowness of ED services" (62.5%). During triage, 89.7% of the patients were coded as green, 23.0% as yellow, and 3.4% as red. The differences between having a FP and the reasons for applying to ED ($p=0.567$), the situation of patients feeling themselves really urgent and triage color codes ($p=0.317$), and having a FP and triage color code ($p=0.501$) were statistically insignificant.

CONCLUSION: Although most of the patients' conditions were mild according to color coding, they perceived themselves really urgent. The patients neither used primary health care sufficiently nor considered FP as a part of referral chain.

Keywords: family physician, primary health care, emergency service

OP-012

Hemoglobin Levels Correlate Well with the Presence of Coronary Artery Disease

[Yusuf Cetin Doganer](#)¹, James E. Rohrer², Umit Aydogan³, Matthew E. Bernard², Cem Barcin⁴

¹Department of Family Medicine, Turkish Military Academy, Primary Care Examination Center, Ankara, Turkey

²Department of Family Medicine, Mayo Clinic, Rochester, Minnesota, USA

³Department of Family Medicine, Gulhane Military Medical Faculty, Ankara, Turkey

⁴Department of Cardiology, Gulhane Military Medical Faculty, Ankara, Turkey

Background & AIM: In the present study, we sought to identify the relationship between hemoglobin levels and the presence of CAD. Additionally, we evaluated the relationships of biochemical parameters to baseline clinical characteristics in patients undergoing coronary angiography (CAG).

METHOD: The study consisted of 356 consecutive patients referred for elective CAG. Exclusion criteria included a history of prior MI within last three months, presence of neoplastic disorders or any inflammatory diseases, or overt diabetes mellitus (DM). Blood samples for hematologic and biochemical parameters were collected on admission following at least 12 hours of overnight fasting. Patients were divided into four groups based on the quartiles of Hb (Quartile I < 13.50 g/dL, Quartile II 13.50-14.70 g/dL, Quartile III 14.71-15.74 g/dL, Quartile IV > 15.74 g/dL). Additionally, patients filled out a questionnaire of asking their brief medical histories and baseline characteristics.

RESULTS: The patients with older age ($p=0.008$), male gender ($p=0.007$), in Quartile I ($p=0.003$), in Quartile II ($p < 0.001$), in Quartile III ($p=0.011$), higher WBC count ($p=0.037$), lower platelet count ($p=0.049$), condition of current smoker ($p=0.030$), higher value of fasting glucose ($p=0.014$), estimated GFR < 60 (mL/min/1.73m²) ($p=0.004$) were more likely associated with the risk of the presence of CAD.

CONCLUSIONS: The present study revealed that lower quartiles of Hb levels were independently related to the presence of CAD in subjects who were referred to elective CAG. Hb levels, which can be measured easily in almost all medical centers, may be considered as a potential predictor for the presence of CAD in patients at high risk for CAD.

Keywords: Hemoglobin, Coronary artery disease, Coronary angiography

OP-013

Smoking and cessations habits of type 2 diabetic patients

Salih Eker¹, Burcu Dogan¹, Can Oner²

¹Family Medicine Clinic, Sakarya Training and Research Hospital, Sakarya, Turkey

²Department of Family Medicine, Bilim University, Istanbul, Turkey

INTRODUCTION:

Smoking is associated with an increased risk of cardiovascular events and death. Patients with diabetes who stop smoking lower the risk of death and cardiovascular events compared with those who continue to smoke. The aim of this study was to identify the smoking cessation interventions of diabetics.

METHODS:

Study was conducted between 01.11.2014-01.01.2015 from 125 sequential patient diabetes (75 female, 50 male) records of Sakarya Training and Research Hospital Family Medicine Clinic. For that aim type 2 diabetic patients were included to the study. Smoking habits and cessations interventions of patients were asked. Data was analyzed by SPSS 20.0

RESULTS:

Mean age of participants was 58,3±9,6 and mean disease duration was 10,3±6,6 years. 16% (n=20) of patients smokes and 33,6 % (n=42) patients was ex smokers, remaining 63 patients (50,4%) had never smokes. Current smoking patterns show significant difference according to gender of patients (p=0,000). 45% of current smokers was female, and 72% of patient who had never smokes was female. On the other hand 28,6% of patients who quit smoking was female and 71,4% was male.

Mean smoking time of patients who quit smoking was 25,4±12,4 years, and mean cigarette count was 22,5±14,7. Ex smokers patients' mean cessation time was 13,1±11,8 years. Half of the ex smokers quit smoking before the diagnose of diabetes (n=21). 11,2% (n=5) of ex-smokers took professional help, and 1 of them use nicotine bands and 1 of them use varenikline.

CONCLUSION:

It was found that every 1 in 5 diabetics currently smokes. As tobacco use increases the cardiovascular event risks of diabetic patients, all of the diabetics should be encouraged to quit smoking. But the professional help in ex smokers patients was vey low. So professional help to quit smoking must be provided to diabetic patients.

Keywords: Smoking, type 2 diabetic patients, habits

OP-014

Evaluation of Diabetic Patient Care Quality in Primary Care

Selcuk Mistik¹, Ulku Elif Demir¹, Sinan Demir²

¹Erciyes University Medical Faculty, Department of Family Medicine, Kayseri, Turkey

²Erciyes University Medical Faculty, Department of Internal Medicine, Kayseri, Turkey

AIM: Diabetic patients are a big group of primary care patients. However, optimal patient care has not been achieved. The aim of this study was to evaluate all of the factors which may affect the quality of diabetic patient care in primary care.

METHOD: Diabetic patients who were being followed and treated in 36 Family Medicine Centers were included in the study. A questionnaire of 65 questions including demographic data, history and physical examination of the patients, and laboratory findings were filled out by family physicians.

RESULTS: Of the patients, 10% were type1 and 90% were type 2 diabetic patients. The mean age was 56. The ones diagnosed at primary care were 18.5%. The use of oral antihyperglycemic medicine was very common (83.9%). Metformin was the most common oral antihyperglycemic medicine used (74.2%) either alone (40.6%) or in combination with other antihyperglycemic medicine (33.6%). Forty four percent were using insulin. In the last 6 months, 84.7% had measured HbA1c values, where the mean value was 7.3. More than half of the patients had HbA1c values higher than 7% (53.5%). Eighteen percent were smoking. Twenty one percent had influenza vaccine and four percent had pneumococcal vaccine. Thirty percent had diagnosed hypertension and 24 percent had diagnosed coronary artery disease. Acetylsalicylic acid was used by 43 percent of the patients. Sixty four percent had eye examination, and 25% had neurologic examination. Fifteen percent of the patients reported hypoglycemia. Thirty percent were obeying their diets. Thirty four percent of the patients were regularly exercising. The mean Body Mass Index was 31.

CONCLUSIONS: The results of this study demonstrated us that there are many uncontrolled properties of the diabetic patients, including the glycemic control, smoking cessation, vaccination status, diet, and exercise which could be managed in primary care.

Keywords: diabetes, patient care, primary care

OP-015

Undiagnosed cognitive impairment, health status and depressive symptoms in patients with type 2 diabetes

Paula Koekkoek¹, Geert Jan Biessels², Minke Kooistra¹, Jolien Janssen¹, Jaap Kappelle², Guy Rutten¹

¹Julius Center for Health Sciences and Primary Care, University Medical Center Utrecht, the Netherlands

²Department of Neurology, Brain Center Rudolf Magnus, University Medical Center Utrecht, the Netherlands

Background and aim

Type 2 diabetes is associated with cognitive impairment. We aimed to examine whether undiagnosed cognitive impairment in patients with type 2 diabetes is associated with a reduced health status and depressive symptoms.

Method

225 primary care patients aged ≥ 70 years with type 2 diabetes were examined, both at their homes and at a memory clinic, for undiagnosed cognitive impairment (dementia or mild cognitive impairment [MCI]). Dementia and MCI were defined according to internationally accepted criteria. Questionnaires assessing health status (SF-36, EQ-5D and EQ-VAS) and depressive symptoms (CES-D) were filled out. Health status and depressive symptoms were compared between patients with and without cognitive impairment.

Results

Patients with cognitive impairment (n=57) showed significantly lower scores on the SF-36 on six out of the eight domains, on the physical and mental summary scores, and on both the EQ-5D and the EQ-VAS scores. CES-D scores were significantly higher in patients with cognitive impairment (9.2 ± 7.1 versus 12.7 ± 8.5 ; $p=0.009$). Depression (CES-D ≥ 16) occurred almost twice as often in patients with cognitive impairment (RR 1.8; 95%-CI: 1.1-3.0).

Conclusions

Undiagnosed cognitive impairment in patients with type 2 diabetes is associated with a reduced health status and more depressive symptoms. Detection of cognitive impairment in type 2 diabetes patients identifies a vulnerable group of patients that could benefit from integrated and tailored treatment.

Keywords: type 2 diabetes mellitus, cognitive impairment, health status, depressive symptoms

OP-016

Evaluating the Relationship Between Body Mass Index, Lipid Profile and Clinical Parameters in Heart Failure Patients

Fatma Gonul Dogan¹, Didem Kafadar¹, Irfan Sahin², Mustafa Hakan Dinckal²

¹Department of Family Medicine, Bagcilar Training and Research Hospital, Istanbul, Turkey

²Department of Cardiology, Bagcilar Training and Research Hospital, Istanbul, Turkey

Background & AIM: Heart failure(HF), due to new treatment methods and increasing population of the elderly, is a more often medical entity. Dyslipidemia is a risk factor for coronary artery disease (CAD) and hypertension plays a role in development of HF. It is suggested that dyslipidemia further effects HF and response to treatment. In our study, we aimed to evaluate the body mass index(BMI), body composition analysis and lipid profile of HF patients. METHOD: 120 patients (82 men and 38 women) with ejection fraction (EF) 40% or less were involved.

Sociodemographic features, comorbidities and functional capacities according to NYHA classification were asked, class IV patients were not included. BMI and body composition were analyzed with Tanita BC 418, laboratory parameters in the last month were evaluated retrospectively.

RESULTS: The mean age was 63.3 and 46.6 % of the patients were elderly, 65 and over. Most of the patients were in NYHA class II(52.5%). In women, body fat ratio and trunk fat ratio were significantly higher than men ($p<0.001$, $p=0.001$ respectively). In patient group with EF between 40% and 30%, the patients with higher fat mass and BMI ≥ 30 were significantly more than patients with EF less or equal to 30% ($p=0,036$, $p=0.013$ respectively). In men, in the higher EF(40-30%) group, BMI and the mean muscle mass were significantly higher than those in the lower EF(<30%) group ($p=0.018$, $p= 0.017$).

CONCLUSIONS: We found that EF is better in patients with BMI ≥ 30 . Fat and muscle mass may have protective effects on EF. We think that body composition may have a protective effect on cardiac function in chronic heart failure patients as it is proposed in obesity paradox. In follow-up of chronic heart failure patients this must be kept in mind and may be an alerting signal for worsening of EF.

Keywords: Heart failure, Body mass index, Dyslipidemia

OP-017

The Prevalence and Awareness of Metabolic Syndrome among the Healthcare Professionals Working at First-Step Health Centers in the Southeastern Anatolia Region in Turkey

Tahsin Çelepkolu¹, Pakize Gamze Erten Bucaktepe¹, Hatice Yüksel², Yılmaz Palancı³, Sercan Bulut Çelik⁴, Hüseyin Can⁵, Ahmet Yılmaz¹, Veysel Kars¹, Gökhan Usman⁶, Necmi Arslan¹, Arzu Evliyaoğlu Taşkesen⁷, İlknur Aslan⁸, Özgür Erdem⁹, Ata Akıl¹⁰, Erkan Kıbrıslı¹, Bayram Başdemir¹¹, Mehmet Halis Tanrıverdi¹

¹Dicle Üniversitesi Tıp Fakültesi Aile Hekimliği Anabilim Dalı, Diyarbakır

²Dicle Üniversitesi Tıp Fakültesi Biyokimya Anabilim Dalı, Diyarbakır

³Dicle Üniversitesi Tıp Fakültesi Halk Sağlığı Anabilim Dalı, Diyarbakır

⁴Batman Merkez 11 Nolu ASM, Batman

⁵Katip Çelebi Üniversitesi Tıp Fakültesi Aile Hekimliği Anabilim Dalı, İzmir

⁶Adıyaman Üniversitesi Tıp Fakültesi Aile Hekimliği Anabilim Dalı, Adıyaman

⁷Yenişehir 11 Nolu ASM, Diyarbakır

⁸Çınar Devlet Hastanesi, Diyarbakır

⁹Kayapınar 9 Nolu ASM, Diyarbakır

¹⁰Dicle Üniversitesi Tıp Fakültesi, Kardiyoloji Anabilim Dalı, Diyarbakır

¹¹Yenişehir 7 Nolu ASM, Diyarbakır

AIM: Metabolic syndrome (MetS) is a cluster of established cardiovascular risk factors for diabetes mellitus and cardiovascular diseases. MetS has become a growing public health problem since 1/3 of adults in Turkey and in the world are under risk. We aimed to investigate the prevalence and awareness of MetS among the healthcare professionals working at first-step health centers in the Southeastern Anatolia Region in Turkey.

METHOD: The universe of the study included a total of 4,800 healthcare professionals working at first-step health centers in 8 provinces of the Southeastern Anatolia Region in Turkey and of these, the participants were sampled from each province. The participants were administered a data form including sociodemographic characteristics and items related to attitudes and awareness of MetS and the prevalence of MetS among healthworkers was assessed using IDF 2005 guidelines.

RESULTS: A total of 493 healthcare professionals participated in the study and 390 participants completed the survey. The prevalence of MetS was found 19.5%. The prevalence among physicians was 40% and this rate was statistically significant when compared to the rates for other professions(7.8). Of 493 participants, 385 (78.1%) were working at Family Health Centers and 108 (21.9%) at Public Health Centers. The participants included 304 (61.7%) women and 189 (38.3%) men. Mean age was 39.76 \pm 8.71 years for the participants with MetS and 33.21 \pm 7.71 years for the participants without MetS. MetS was present in 7.5% of women and 32% of men and in 20.4% of married participants and 7.1% of unmarried participants.

CONCLUSION: The regulations enacted by the Turkish Health Ministry regarding MetS, particularly the ones enacted as of 2010, have led to positive outcomes for the community. Nevertheless, healthcare professionals should be more sensitive about MetS both for themselves and for the other members of the community applying to them for healthcare service.

Keywords: Metabolic syndrome, healthcare professional, first-step health center, prevalence, awareness

Table 1: The sociodemographic characteristics of all participants and answers of several awareness questions
n:493

Characteristics	n (%)
Gender	
Female	304 (61.7)
Male	189 (38.3)
Age	34.60 ± 8.57
Working Institution	
Family Health Center	385(78.1)
Public Health Center	108(21.9)
Occupation	
Physician	196 (39.8)
Non-physician	297 (60.2)
Education Status	
High School	87 (17.7)
Academy	89 (18.1)
University	317 (64.2)
Smokers	145 (29.4)
Alcohol users	43 (8.7)
Never measured blood pressure	9 (1.8)
Never measured blood glucose level	45 (9.1)
Never measured HDL- Chol level	60 (12.2)
Never measured TG level	71 (14.4)
Never measured waist circumference	115 (23.3)

HDL-Chol: High Density Lipoprotein Cholesterol, TG: Triglycerid

Table 2: Comparison of sociodemographic characteristics between Metabolic Syndrome (METs) existence

Characteristics	MetS Var	MetS Yok	Toplam (n=390)	p
Age	40.2±7.76	32.9±8.75	34.38±8.46	=0.000
Gender				
Female	22 (8.7)	231(91.3)	253 (100)	=0.000
Male	54 (39.4)	83(60.6)	137 (100)	
Occupation				
Physician	55 (36.2)	97 (63.8)	152 (100)	=0.000
Non-physician	21 (8.5)	227 (91.5)	248 (100)	
Working Institution				
Family Health Center	59 (19.2)	249 (80.8)	308 (100)	=0.749
Public Health Center	17 (20.7)	65 (79.3)	82 (100)	
Education Status				
High School	5 (7.2)	65 (92.8)	70 (100)	=0.002
Academy	8 (12)	58 (88)	66 (100)	
University	63 (24.8)	191 (75.2)	254 (100)	
Marial status				
Married	67 (23.6)	217 (76.4)	284 (100)	=0.004
Non-married	9 (8.5)	97 (91.5)	106 (100)	
Total	76 (19.5)	314 (80.5)	390 (100)	

OP-018

Control of the very older patient with High Blood Pressure

Pedro Alejandro Gonzales Flores, Pablo Rubinstein Aguñin, Monica Pons Querol, Silvia Sanchez Casco
Catalan Health Institute, CAP Les Fontetes, Cerdanyola del Vallès, Barcelona, Spain

OBJECTIVES

1. To determinate the degree of control in patients with High Blood Pressure (HBP) who had > 80 years old.
2. To determinate the kind of treatment for the patient very older
3. To determinate the comorbidities of the very older people with HBP

METODOLOGY

Descriptive an retrospective study of HBP patients of the CAP Fontetes (Cerdanyola del Vallès). We chosen 80% of all hypertensive patients. As good control was < 140/90 as indicated in the ICS guide and 150/90 (guide of the EHS). The main comorbidity was diabetes, the target injury organ: Microalbuminuria and hypertrophy of left ventricle and established CV disease: heart disease, kidney failure, stroke, and peripheral artery disease. The results were processed using the SPSS system version 4.0

RESULTS

Prevalence of hypertension was 46.3% (727 of 1570 people). We chosen 583 HBP patients (80.2%). 174 were older than 80 years (29.8%). The main treatments were: ARA II 96 diuretics (16.47%), ACE diuretic 93 (15.95%), ACEs 81 (13.89%), ARA II 46 (7.89%), Diuretics 34 (5.83%) and other 116 (19.90%). The degree of control following the guides of the ICS was 53.4% (93) and using the guide of the SEH 78.1% (136). Diabetes was present in 49 (30,6%). TIO: 9 Microalbuminuria (5.17%) and 5 left Ventricular hypertrophy (2.87%). Established CV disease: heart disease 32 (18.39%), Renal Failure chronic 31 (17.81%), AVC 17 (9.77%) and arterial disease 8 (4.59%)

CONCLUSIONS

1. Control of HBP in patients older than 80 was 53,4% vs 62,1% in younger than 80
- 2 Microalbuminuria was the main TIO and Cardiopathy was the main CVD. Diabetes was present in 30,6%
3. There are many different treatments for very elderly people.
3. The degree of control was 53,45% and 78.1% according to the guide used (ICS vs EHS) to having significant difference (p = 0.01)

Keywords: European Hypertension Society, Catalan Health Institute, Degree of control of High Blood Pressure

OP-019

Relationship between anxiety and depression with asthma control at urban setting of Kuala Lumpur

Dayangku Hayaty Awg Dzulkarnain¹, Mohazmi Mohamad²

¹Department of Family Medicine, Universiti Putra Malaysia, Serdang, Selangor, Malaysia

²Department of Family Medicine, University Malaya, Kuala Lumpur

INTRODUCTION: Asthma is a common medical condition in primary care.. Anxiety and depression are believed to have close association with poor asthma control. Historically, asthma has been considered a psychosomatic illness in which psychological factors play an important role in initiating and exacerbating symptoms of airway obstruction. The aim of this study was to determine association of anxiety and depression with poor asthma control at University Malaya Medical Centre.

METHODS: A cross- sectional study was carried out among 128 patients attending primary health care clinic and asthma clinic at University Malaya Medical Centre, Kuala Lumpur between April to June 2011. They were recruited via convenient sampling. The questionnaires that were used in this study consisted of four sets of self-administrated questionnaires (demography, asthma background, Asthma Control test (ACT) and Hospital Anxiety and Depression Scale (HADS). Analysis was performed using SPSS 18.0. This study is sub analysis from a study on "Prevalence of depression at urban setting of Kuala Lumpur"

RESULT: The overall response rate was 93.3% The mean age of respondents was 45.6±19 years, majority was Malay (57%), Female (71.9%), Married(63.3%), Monthly income <RM1500 (46.9%), Received secondary education(36.7%), Working (56.3%) and Non- smoker(89.1%).A univariate analysis had shown a significant association between depression with gender, income, occupation, education level and Asthma Controlled Test(ACT) whereby anxiety had shown a significant association with Asthma Controlled Test (ACT) only. The final fitted model of multiple logistic regressions found that none of the factors associated with depression had statistically significant but anxiety has remain statistically significant with Asthma Controlled Test (ACT).

CONCLUSION: There was no significant association between depressions with poor asthma control. This might be due to small sample size which is not big enough to show a significant association. Anxiety has a statistically significant association with poor asthma control.

Keywords: Anxiety, depression, asthma

OP-020

Sharing our experience on a chronic heart failure programme carried out in a Primary Care Setting

Daniela Florentina Pruteanu, Noelia Pastor Gradoli

Quart de Poblet Health Care Centre

BACKGROUND AND AIM: to assess a programme of integrated care (primary - specialized care) in the patients with advanced chronic heart failure (ACHF) (NYHA III and IV) from our health care centre (HCC) in the period 2012-2014.

METHOD: The programme included all the patients with ACHF from our HCC and consisted in planned home visits performed by nurses and GPs, aiming to improve patient's management and to avoid acute events and unnecessary emergency calls and hospital admissions. Evaluated variables: gender, age, number of months within the programme, number of ER visits 1 year before and after the inclusion in the programme, number of hospital admissions 1 year before and after the inclusion, family support, associated diagnoses, place of death if appropriate, number of planned home visits, quality care standards (echocardiography study performed), use of home hospitalization unit (HHU).

RESULTS: N=58 patients; mean age: 85 years; 67.2% women; 76% NYHA III. Mean number of months in the programme 13.3. In most of the patients (86.2%) the main care giver was a family member. 22.4% used HHU services. 46.6% associated anxiety/depression. In 84.5% of the patients an echocardiography was performed via fast referral visit (collaboration with specialized care). Mean number of hospital admissions: 1.53 before inclusion; 0.83 after inclusion; Mean number of ER visits: 4.52 the year before inclusion and 2.02 after the inclusion. 58.6% died (out of which 53% of them at home). Mean number of monthly planned home visits was 1.16 for the nurses

and 1.6 for the GP.

CONCLUSIONS: Our programme achieved an important reduction of the ER visits and of hospitalizations, which means a better management of preventing acute events. There was a good collaboration between primary and specialized care (HHU, cardiologist). Good quality of care standards achieved. Patients' end of life in home environment in a large proportion.

Keywords: Chronic heart failure, planned home visits

OP-021

A double-blind randomized, placebo controlled trial of the effect of Vitamin D3 supplementation on long term glycemic control

Shaheen Chowdhury, Gift Norman, Carolin Elizabeth George

Bangalore Baptist Hospital, Bangalore

Introduction and justification:

Diabetes is responsible for a major share of the burden of chronic disease worldwide. It has been postulated that the islet cell reactivity and inflammation in T2DM is responsible for the progressive nature of the disease.. In this context, the role of Vitamin D is being explored in view of its modulation of inflammatory pathways which comprise key events in T2DM progression. In addition in the Indian context particularly, Vitamin D deficiency appears to be an endemic problem.

OBJECTIVES:

To study the effect of adding Vitamin D3 supplementation to the therapeutic regimen on the long term glycemic control in type 2 diabetes patients.

METHODS:

This randomized double-blind placebo controlled clinical trial was conducted with 85 type 2 diabetic participants. The vitamin D-group (n = 44) and the placebo group (n = 41) were matched for gender, age, sunlight exposure and HbA1c at the baseline. The vitamin D-group received 60,000 IU vitamin D3 once a month for 3 months whereas the placebo group (n = 42) received a matching placebo.

RESULTS:

One hundred and sixteen participants were randomly assigned into two groups. Post attrition 85 subjects (with no difference in baseline characteristics) were analysed. Mean Hb1Ac increased at the end of 3 months in the placebo group (p value - 0.021) whereas the Vitamin D group did not show a statistically significant increase (p value - 0.090)

CONCLUSION:

Three months of Vitamin D3 supplementation to T2DM patients appeared to arrest the progression of the natural course of disease.

Keywords: Vitamin D, Type 2 diabetes mellitus

Baseline comparison between placebo group and Vitamin D group

Parameters	Vitamin D N =44	Placebo N =41	p value
Hindu religion	39	35	0.623
Mean age	54.6	53.87	0.927
Male	26	25	0.859
Urban	24	23	0.886
Hypertension present	26	22	0.614
Smoker	4	3	0.766
Duration of diabetes	5.55	3.61	0.011

Mean sunlight exposure in hours	2.48	2,58	0.228
Baseline HbA1c	7.23	7.17	0.125

Effect of Vitamin D supplementation in Diabetes mellitus patients

Groups	N	Vitamin D HbA1c baseline	Vitamin D HbA1c after 3 months	p value	N	Placebo - HbA1c baseline	Placebo - HbA1c after 3 months	p value
All	44	7.23 +/- 0.4682	7.66 +/- 1.41	0.090	41	7.17 +/- 0.3849	7.43 +/- 0.83	0.021
Age < 60 yrs	25	7.35 +/- 0.464	7.81 +/- 1.78	0.209	25	7.17 +/- 0.363	7.56 +/- 0.892	0.012
Age >60 yrs	19	7.08 +/- 0.437	7.32 +/- 0.613	0.108	16	7.16 +/- 0.428	7.23 +/- 0.709	0.681
Male	26	7.14 +/- 0.50	7.35 +/- 0.652	0.151	25	7.16 +/- 0.406	7.472 +/- 0.850	0.053
Female	18	7.38 +/- 0.385	7.95 +/- 2.04	0.241	16	7.18 +/- 0.3618	7.36 +/- 0.8276	0.238
Diabetes < 5 yrs	25	7.228 +/- 0.4748	7.612 +/- 1.76	0.281	31	7.17 +/- 0.374	7.416 +/- 0.75	0.035
Diabetes > 5 yrs	19	7.25 +/- 0.471	7.58 +/- 0.799	0.069	10	7.17 +/- 0.437	7.48 +/- 1.09	0.324

OP-022

Health care procedures involved in the cardiovascular diseases follow-up in general practice: data analysis from the ECOGEN study

Hélène Carrier, Ludovic Casanova, Pierre André Bonnet

Department of general practice, University of Aix-Marseille, Marseille, France

Background. The chronic follow-up of cardiovascular diseases is rarely studied in primary care.

The French classification of medical procedures of the Assurance Maladie can't describe the real nature of care procedures involved in general practice consultations. The objective of the ECOGEN national study was to describe the content of these consultations.

Aims. To describe the care procedures involved during cardiovascular diseases follow-up in general practice and to categorize these procedures.

Method. Multicenter, observational cross-sectional national study, conducted in 128 general practice offices.

Between December 2011 and April 2012, 54 investigating residents collected consultation data, using the International Classification of Primary Care (ICPC-2). Cardiovascular diseases were selected within the consultation results database. A descriptive analysis of care procedures was done.

Results. Cardiovascular diseases in general practice included in average 2.29 care procedures. The most frequent procedures were the drug treatment (82.85 % of cardiovascular consultation results), and the partial clinical examination (68.01 % of cardiovascular consultation results). Among all the involved procedures, 51.86 % were diagnostic procedures and 41.28 % were therapeutic procedures.

Conclusion. During the follow-up of cardiovascular diseases in general practice, several care procedures were performed or planned. Therapeutic and diagnostic procedures were the most frequent. Preventive process and coordination process were minor.

Keywords: General practice, Cardiovascular diseases, Classification, Care procedures

OP-023

Hypoalbuminaemia and cancer diagnosis in primary care: a case-control study

Samuel William David Merriel¹, Fergus Hamilton¹, Deborah Sharp¹, Robert Carroll¹, Willie Hamilton²

¹Centre for Academic Primary Care, University of Bristol

²Medical School, University of Exeter

Background & Aims

Earlier cancer diagnosis improves treatment and survival rates. Hypoalbuminaemia (albumin <35g/L) is associated with poorer cancer prognosis and treatment outcomes in secondary/tertiary care patients. No studies have yet been performed exploring the relationship between low albumin and a new diagnosis of cancer.

The primary aim was to determine if adult patients with a new diagnosis of cancer in primary care have hypoalbuminaemia in the 12 months prior to diagnosis. A second aim was to explore whether hypoalbuminaemia is associated with a diagnosis of particular cancer types.

Methods

A case-control study of 243,730 adult patients in primary care was performed on data extracted from the DISCOVERY database. The main outcome measure was a diagnosis of cancer, including the type of cancer. Relevant past medical history of conditions affecting albumin levels (liver dysfunction, nephrotic syndrome, chest or abdominal trauma, sepsis or heart failure) and demographic data were also extracted.

Descriptive statistics, chi-square and t-tests, were used to summarise albumin levels and baseline characteristics of participants. Unadjusted and adjusted logistic regression analyses were performed. Positive predictive values (PPV) for cancer diagnoses were calculated.

Results

Patients with a diagnosis of cancer were similar in age and gender to those who did not have cancer. Mean albumin levels were significantly lower in patients with a cancer diagnosis compared to controls (39.89g/L vs 41.35g/L, $p < 0.0001$). The adjusted analysis showed patients with hypoalbuminaemia were more likely to be diagnosed with cancer within the next 12 months (OR 1.68 95% CI 1.58, 1.80). The PPV was 13.8% (95% CI 13.7%, 13.9%). Hypoalbuminaemia was associated with an increased risk of diagnosis of a number of different cancer types.

Conclusions

Hypoalbuminaemia is associated with an increased risk of subsequent cancer diagnosis. GPs should consider a possible diagnosis of cancer in their differential diagnosis for a low albumin.

Keywords: Primary Health Care, Neoplasms, Hypoalbuminemia

OP-024

Proposal of a Primary Care follow-up protocol for management of patients with Stable Coronary Artery Disease diagnosis

Joana Ribeiro¹, Luis Santos², Tiago Adrega², Bruno Oliveira¹, Patrícia Morgado¹, José Santos²

¹Unidade de Cuidados de Saude Primarios Aveiro I, ACES Baixo Vouga

²Department of Cardiology, Centro Hospitalar do Baixo Vouga, Aveiro

BACKGROUND: Coronary Artery Disease (CAD) is a common condition in patients accompanied by Family Physicians (FP) and is the most important cause of morbidity and mortality in the world.

The observation of patients diagnosed with stable CAD is often performed in parallel between Primary and Secondary Health Care and many with hospital discharge after stabilization.

It is therefore essential that the FP is informed about the condition and accordingly prepared for appropriate clinical management of these patients. For these reasons, we propose a clinical protocol to improve clinical practice excellence in this setting, and adapted to the Primary Care reality.

AIM: I. Standardization of care in patients with stable CAD with up-to-date evidence; II. Decrease disease and economic burden; III. Foster collaboration between Primary and Secondary Care.

METHODS: We evaluated the international guidelines with more scientific impact and performed additional literature search on stable CAD. The information was organized and adapted in consonance with Primary Care challenges. The project was carried out with the help of Cardiology and FP experts. Finally, it has been proposed for presentation to FP of the hospital referral area.

RESULTS: an integrator document was conceived, directed to FP, proposing decision-making flow charts designed to guide the clinical judgment, and consists of seven main points: I. Patient information and education and emphasis of therapeutic compliance; II. Clinical monitoring (symptoms, physical examination, drug's iatrogenesis, concomitant diseases); III. Lifestyle modification and control of risk factors; IV. Control of comorbidities (namely vaccination); V. Pharmacological management (ischemia and event prevention); VI. Analytical, electrocardiographic and stress testing management; VII. Red flags for hospital referral.

CONCLUSION: The existence of protocols adapted to the reality of Primary Care underpin a valuable resource to optimize medical performance and ensure excellence of care for patients with stable CAD.

Keywords: Stable Coronary Artery Disease; Primary Care; protocol; clinical management; follow-up; guidelines.

OP-025

An Evidence-Based 'Screening' Toolkit for Mental Health Disorders in Seniors

Bonnie M Dobbs¹, Diane C Mcneil², Anita S Saini², David G Moores¹

¹Dept. Family Medicine, University of Alberta

²Promotion, Prevention & Community Initiatives, Provincial Addiction and Mental Health, Alberta Health Services

BACKGROUND: Mental health disorders in seniors often go undetected. In answer to repeated calls to improve the detection of mental health disorders we have developed a Toolkit for the early identification of the four most common mental disorders (anxiety, dementia, depression, and substance [alcohol] misuse).

AIM: To create a standardized, user-friendly Toolkit to assist health care professionals in the primary care setting in the early identification of anxiety disorders, dementia, depression, and alcohol misuse in seniors.

METHOD: A series of systematic literature reviews were conducted, for each of four mental health disorders. The reviews focused on extracting data relevant to the accuracy of the tools for identifying the mental health disorders in the primary care setting (e.g., psychometric properties of sensitivity, specificity, etc.) compared to a gold standard (e.g., DSM-IV-TR, ICD, etc.). Tools with the best psychometric properties for identification were selected. An independent expert panel provided validation for the tools selected. Consensus group conferences were held with primary care health care professionals to obtain feedback on the ease of administration, scoring, and patient uptake.

RESULTS: Eight tools were identified: one for anxiety, two for dementia, three for depression, and two for substance (alcohol) misuse. All tools met a number of criteria including a high degree of accuracy in identifying those with and without the disorder, ease of administration (e.g., short, easy to score), and being non-proprietary. Both a paper and web-based version of the Toolkit were developed, with both versions available at no cost to health care professionals.

CONCLUSION: The availability of an evidence-based Toolkit to assist health care professionals in the primary care setting for the early identification of seniors with anxiety, dementia, depression, and/or an alcohol misuse problem represents a significant step in earlier detection of these disorders with anticipated improvements in outcomes in the senior population.

Keywords: senior's mental health, primary care, toolkit

OP-026

HIV indicator condition-guided testing to reduce the number of undiagnosed patients and prevent late presentation

Ivo Joore¹, Derk Arts¹, Marjan Kruijer¹, Eric Moll Van Charante¹, Suzanne Geerlings², Jan Prins², Jan Van Bergen¹

¹Department of General Practice, Academic Medical Center, University of Amsterdam, Amsterdam, Netherlands

²Division of Internal Medicine, Department of Infectious Diseases, Academic Medical Center, University of Amsterdam, Amsterdam, Netherlands

Background and Aim Recent guidelines advocate accelerated provider-initiated HIV testing by general practitioners (GPs). The European Centre for Disease Prevention and Control recommends offering an HIV test to individuals who display HIV related diseases. The National Institute of Health and Care Excellence guideline recommends performing 'routine HIV testing' among all 15- to 59-year-olds where HIV prevalence exceeds 2 in 1000. We aimed to identify the number of patient consultations in six general practices in the south-east of Amsterdam, and the incidence of HIV indicator conditions reported in their medical files prior to diagnosis. **Method** A cross-sectional search in an electronic general practice database. We used a case-control design to identify those conditions most associated with an HIV positive status.

Results We included 102 HIV cases diagnosed from 2002 to 2012, and matched them with 299 controls. In the year prior to HIV diagnosis, 61.8% of cases visited their GP at least once, compared to 38.8% of controls. In the five years prior to HIV diagnosis, 58.8% of HIV cases had exhibited an HIV indicator condition, compared to 7.4% of controls. The most common HIV-related conditions were syphilis and gonorrhoea. The most common HIV-related symptoms were weight loss, lymphadenopathy and peripheral neuropathy. During this period, average HIV prevalence among 15 to 59-year-olds increased from 0.4% to 0.9%.

Conclusions This study revealed many opportunities for HIV indicator condition-guided testing in primary care. As yet, however, HIV indicator conditions are not exploited as triggers for early HIV testing. In April 2015, a comparable study will be performed in a larger primary care database that is representative for the Dutch general population.

Keywords: case-control studies, general practice, HIV Infections/prevention & control, HIV Infections/epidemiology, Primary Health Care

OP-027

Proposal of a Primary Care follow-up protocol for management of patients with Atrial Fibrillation diagnosis

Joana Ribeiro¹, Luís Santos², Tiago Adrega², Patrícia Morgado¹, Sofia Madanelo³, José António Santos²

¹Unidade de Cuidados de Saúde Primários Aveiro I, ACES Baixo Vouga

²Department of cardiology, Centro Hospitalar Baixo Vouga, Aveiro

³Unidade de Saúde Familiar Santa Joana, ACES Baixo Vouga

BACKGROUND: Atrial Fibrillation (AF) is a common condition in patients accompanied by Family Physicians (FP) and is a paramount cause of morbidity and mortality.

The observation of patients diagnosed with AF is often performed in parallel between Primary and Secondary Health Care and many with hospital discharge after stabilization.

It is therefore essential that the FP is informed about the condition and accordingly prepared for appropriate clinical management of these patients. For these reasons, we propose a clinical protocol to improve clinical practice excellence in this setting, and adapted to the Primary Care reality.

AIM: I. Standardization of care in patients with AF with up-to-date evidence; II. Decrease the disease burden; III. Foster collaboration between Primary and Secondary Care.

METHODS: We evaluated the international guidelines with more scientific impact and performed additional literature search on AF. The information was organized and adapted in consonance with Primary Care challenges. The project was carried out with the help of Cardiology and FP experts. Finally, it has been proposed for presentation to FP of the hospital referral area.

RESULTS: an integrator document was conceived, directed to FP, proposing decision-making flow charts designed to guide the clinical judgment, and consists of five main points: I. Patient information and education and emphasis of therapeutic compliance; II. Clinical monitoring (symptoms, drug's iatrogenesis, concomitant diseases); III. Anticoagulant therapy (CHA₂DS₂-VASc, HAS-BLED, drug selection); IV. Rate and rhythm management; V. Red flags for hospital referral.

CONCLUSION: The existence of protocols adapted to the reality of Primary Care underpin a valuable resource to optimize medical performance and ensure excellence of care for patients with AF.

Keywords: Atrial Fibrillation; Primary Care; protocol; clinical management; follow-up; guidelines.

OP-028

A Study of Reliability and Validity For the Turkish Version of Dizziness Handicap

Metin Canbal¹, Gülsüm Duyan², Sevsen Cebeci¹, Hanefi Kurtaran³, Ismail Arslan⁴

¹Department of Family Medicine, Turgut Ozal University, Ankara, Turkey

²Department of Social Services, Turgut Ozal University, Ankara, Turkey

³Department of Otolaryngology Head and Neck Surgery, Turgut Ozal University, Ankara, Turkey

⁴Department of Family Medicine, Ankara Education and Research Hospital, Ankara, Turkey

OBJECTIVE: Dizziness is one of the most frequently seen unresolved diseases in primary health care. Regardless of its reason or characteristics; effects of dizziness in patients' daily life are very significant. This study is planned to adapt the Dizziness Handicap Inventory to Turkish and to use it in practice; an inventory which can be used to determine the alterations in the life qualities of the outpatients or inpatients consulted with the dizziness complaint.

METHOD: 178 patients were included in the study, who was admitted to Turgut Ozal University Medical Faculty Otorhinolaryngology and Family Physician polyclinics with dizziness complaint for last 1 month. Half Configurative Interview Form and Dizziness Disability Inventory (BEO) were used as data collection means.

RESULTS: BEO; consists of 25 clauses which determine the aggravating factors associated with dizziness and shakiness and also the emotional and functional results of vestibular system diseases. Inventory consists of 3 sub-inventories, intended to determine physical, emotional and functional effects of the vestibular system diseases. All of the sub-inventories have high inner-confidence and their Cronbach Alfa values are between.67 and.82. Also the Cronbach Alfa values of the sub-inventory groups were similar with the general inventory.

CONCLUSION: The findings obtained from the study show that; this inventory can be used on dizziness patients in our country, and it has satisfactory validity and reliability coefficients. We think that, by using this inventory, dizziness complaint and its effects on life quality can be monitored with more objective criteria.

Keywords: dizziness, life quality, inventory

OP-029

Can patients accurately estimate their cardiovascular risk?

Irmı Zarına İsmail¹, Wai Khew Lee², Su May Lee³, Ee Ming Khoo³, Mimi Omar⁴, Harmy Mohdyusoff⁵, Subashini Ambigapathy⁶, Sitizaleha Suleiman⁷, Juwita Shaaban⁸, Nurfarhana Zaidi³

¹Department of Family Medicine, Faculty of Medicine and Health Sciences,Universiti Putra Malaysia, Serdang, Selangor, Malaysia

²Sabah Health Department, Ministry of Health, Malaysia

³Department of Primary Care Medicine, Universiti Malaya, Faculty of Medicine, Kuala Lumpur, Wilayah Persekutuan, Malaysia

⁴Selangor Health Department, Ministry of Health, Malaysia

⁵Faculty of Medicine, Universiti Sultan Zainal Abidin, Terengganu, Malaysia

⁶Perak Health Department, Ministry of Health, Malaysia

⁷Melaka Health Department, Ministry of Health, Malaysia

⁸Department of Family Medicine, School of Medicine and health Sciences, Universiti Sains Malaysia, Kelantan, Malaysia

Background and Aim

The global burden of cardiovascular disease (CVD) remains critically high. Approaches to target those at highest risk have been recommended. Yet, both patients and doctors have been found to be poor in estimating cardiovascular (CV) risk. This study aimed to determine if patients attending primary care could accurately estimate their CV risk.

Methods

This is a cross sectional study conducted in nine primary care clinics chosen conveniently from five regions in Malaysia in 2014. All patients aged 35 years and above who had CV risk assessment performed in the past year were invited to participate. Those with known CVD were excluded. A face-to-face interview was conducted using structured questionnaire to collect data on patients' sociodemography, blood pressure, lipid profile, smoking status and their perception of their individual CV risk. The 2008 Framingham risk score was used to calculate the actual 10-year CVD risk, which was classified into low (<10%), moderate (10-20%) and high (>20%) risk.

Result

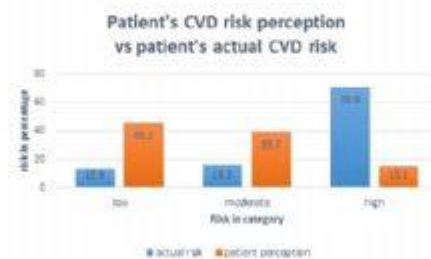
We recruited 1094 participants. Mean age was 57.2 years (SD 9.8). There were 37.4% males and 60.9% had diabetes. There were 776 participants in the high risk group. Of these, only 112 (10.2%) perceived themselves as being at high risk. The remaining 664(60.9%) underestimated their risk. Factors associated with underestimation of risk were being natives (AOR: 6.413, CI: 3.513, 11.703), foreigners (AOR: 7.348, CI: 2.499, 21.602), having a family history of CVD (AOR: 2.596; CI: 1.492, 4.516) and those with higher BMI (AOR:1.050; CI:1.005,1.098).

Conclusion

An alarmingly high number of patients attending primary care clinic underestimate their CV risk. This mismatch between perceived and actual risk indicates over optimism and may lead to poor compliance to treatment and lifestyle changes.

Keywords: Cardiovascular risk, estimation, primary care.

Figure 1: Patients perceived CV risk and patient's actual CV risk.



It displays the distribution of patient's actual CV risk to the patients' perception of their CV risk

Sociodemography of the respondents

Table 1: Socio-demography of the respondents

Demographic data		Frequency (%)
Mean Age ± SD (years)		57.23 ± 9.81
Mean Income ± SD (RM)		1824.34 ± 2112.09
Mean body mass index ± SD (kg/m ²)		28.02 ± 13.17
Gender	FEMALE	685 (62.6)
	MALE	409 (37.4)
Ethnicity	MALAY	559 (51.1)
	CHINESE	234 (21.4)
	INDIAN	161 (14.7)
	BUMIPUTERA	112 (10.2)
	OTHER	28 (2.6)
Smoking	NO	909 (83.1)
	YES	185 (16.9)
Diabetes	NO	429 (39.2)
	YES	665 (60.8)
Hypertension	NO	253 (23.2)
	YES	840 (76.8)
Family history of Stroke	NO	929 (84.9)
	Yes	165 (15.1)
Family history of cardiovascular disease	NO	936 (85.6)
	YES	158 (14.4)

This displays the socio and demography data of the respondents

Table of factors that determine patients to under estimates their CVD risk

Factors determining patients who underestimate their CVD risk

Exploratory variables	AOR	P value	df	95% Confidence interval	
				Lower	Upper
AGE	.983	.206	1	.958	1.009
INCOME	1.000	.295	1	1.000	1.000
Body Mass Index	1.050	.031	1	1.005	1.098
Diabetes	-	-	-	-	-
No	.829	.609	1	.405	1.700
Yes	-	-	-	-	-
SMOKER	-	-	-	-	-
No	1.617	.156	1	.833	3.142
Yes	-	-	-	-	-
Gender	-	-	-	-	-
Female	.647	.090	1	.392	1.070
Male	-	-	-	-	-
Ethinity	-	-	-	-	-
Malay	.715	.344	1	.356	1.432
Chinese	.844	.628	1	.425	1.675
Indian	6.413	.000	1	3.513	11.707
Natives	7.348	.000	1	2.499	21.602
Foreigner	-	-	-	-	-
Family with stroke	-	-	-	-	-
No	.753	.355	1	.412	1.374
Yes	-	-	-	-	-
Family with CVD	-	-	-	-	-
No	2.596	.001	1	1.492	4.516
Yes	-	-	-	-	-

These are the factors that affect patients that under estimates their CVD risk; being natives, foreigners, higher BMI and having family with CVD

Table of Patient's accuracy of estimation

Table 2: Accurate estimation of high CV risk by patient

Patient's perception	Actual risk	
	High (n)	Low/ moderate(n)
High	112	54
Low/ Moderate	664	264

This displays the number of patients who under estimates their CVD risk.

OP-030

Cognitive Impairment in Post Ischemic Stroke

Hardisman Dasman, Akmal Irsyadi Iswan, Syarif Indra

Faculty of Medicine, Andalas University, West Sumatera, Indonesia

BACKGROUND: Cerebrovascular accident or stroke is one of the global health problems. The awareness on stroke increases because the problem often appears as a result of other degenerative diseases which have high prevalence. In Indonesia especially, the prevalence of stroke is considerably high, which is 12.1 per-1000 inhabitants. Moreover, if stroke patients survives, especially in ischemic stroke; they often have both physical and cognitive impairment. Despite the prevalence of stroke in Indonesia is high, there is lack of information about post stroke cognitive impairment. This study was conducted to measure the incident of post stroke cognitive impairment and explore its contributing factors.

METHOD: Cross sectional study design was conducted in two hospitals in West Sumatera Province: Djamil Hospital (public) and Ibnu Sina Hospital (private). We examined 81 post ischemic stroke patients with onset >3 months at neurology polyclinic. We recorded patients' demographic data, blood pressure, lipid level, history of diabetes and smoking. We used MoCA-Ira (Montreal Cognitive Assessment Indonesian-version) for assessing cognitive impairment.

RESULT: The age average of patients is 59 years (SD+8.7, min-max:50-83) and the average score of MoCA-Ira is 21 (SD+4.2). Based on MoCA-Ira score, the incidence of post stroke cognitive impairment is 63%. There is significant different of cognitive impairment between low and high education level of patients ($p<0.05$) and age below and over 60 years old ($p<0.05$). There are high proportion of cognitive impairment in patients with history of smoking, diabetes mellitus, hypertension and dislipidemia; however there is no significant correlation ($p>0.05$). Also, there are no difference of cognitive impairment incidence between male and female patients ($p>0.05$).

CONCLUSION: The incidence of cognitive impairment in post ischemic stroke is considerably high. Age and education which is related to degenerative process and activity of the brain affect on the possibility of the impairment.

Keywords: cognitive impairment; post-ischemic stroke

OP-031

Vascular and metabolic disease risk and inter-arm blood pressure difference in adults: a descriptive study in a population-based sample

Pinar Topsever¹, Sabah Tüzün², Emrah Kırımlı⁶, Serkan Özbakış⁵, Senem Aslan³, Tolunay Demirdamar⁴, Erhan Sayalı⁷

¹Department of Family Medicine, Acıbadem University School of Medicine, Istanbul, Turkey

²Department of Family Medicine, Kartal Lütfi Kırdar State Hospital, Istanbul, Turkey

³Esenyalı Family Health Center, Pendik, Istanbul, Turkey

⁴Gazi Mahallesi Family Health Center, Sultanbeyli, Istanbul, Turkey

⁵Recep Sağlık Family Health Center, Gaziosmanpaşa, Istanbul, Turkey

⁶Ümraniye Merkez Family Health Center, Ümraniye, Istanbul, Turkey

⁷Kadıköy 3 Nolu Family Health Center, Suadiye, Istanbul, Turkey

Introduction/AIM: Vascular disease risk can go unidentified for long in undifferentiated, asymptomatic individuals in the general population, accounting for missed preventive care opportunities and high cerebro-and cardiovascular disease (CVD) burden. Little is known about levels of inter-arm blood pressure in the general population, as well as, its association with cardiovascular -cardiometabolic risk and disease cluster. The aim is to assess the level of systolic inter-arm blood pressure difference (SIAD) in adults stratified by age and gender (primary outcome) and to investigate whether there is a threshold value for SIAD associated with an increase in vascular-metabolic disease frequency (secondary outcome).

METHODS: This cross-sectional, descriptive study will be conducted in a population-based sample, representative

of the adult population of two districts in Istanbul (Gaziosmanpaşa and Ümraniye) stratified by age and gender (calculated with single sample size formula with a significance threshold of <0.05 , a power of 80% and a 95% CI). Randomly selected individuals (18-60 years) from the population registries of family doctors will be invited to the family health centers for screening. Consenting individuals fulfilling inclusion criteria (no aortic coarctation or aneurysma verified by eHR) -after assessment of sociodemographic and health-related information- will undergo 2 consecutive blood pressure measurement on both arms with a calibrated two-arm Riester Sphygmomanometer device according to JNC7 standards. Participants grouped according to $SIAD \geq 20$ mmHg and diastolic $IAD \geq 10$ mmHg as elevated vascular-metabolic risk (primary outcome parameter) will be compared to their counterparts with IAD below the threshold values for related vascular-metabolic health risks (secondary outcome). Results preliminary results will be presented during the conference.

Keywords: cardio-metabolic risk, inter-arm blood pressure, threshold

OP-032

Application of the STOPP/START Criteria to a group of Complex Chronic patients in Primary Care

Jose Pascual Tormo¹, Juan Carlos Salazar¹, Fernando Javier Elias¹, Juan Ignacio Saenz¹, James Diego Ettinghausen¹, Cruz Villar¹, Inma Sanchez²

¹Palafrugell Primary Care Center. Palafrugell, Girona. Spain

²Research Department. Hospital of Palamos. Palamos, Girona. Spain

BACKGROUND & AIM

The objectives were: a. To determine the percentage of chronic complex patients with at least one inappropriate prescription according to the STOPP/START (S/S) criteria. b. To readjust the medication in a cases group and compare results with a control group during one year. c. Measure the adherence of patients to the changes applied.

DESIGN: Longitudinal, prospective, cohorts comparative study. One Primary Care Center. Period: 2013-2014. Selection: both genders, age 65 and older, labeled chronic complex patients. Randomized in cases and control groups in a 1:2 ratio. Variables: Age, sex, group, number of applicable criteria, changeable criteria, modified criteria and maintained criteria at the end of the study. Statistical analysis: univariate descriptive for categorical and continuous variables and bi-variate for means comparison. CI: 95%

RESULTS: Target population: 1332 people. People included in study: 153. Cases: 51. Controls: 102. Cases and controls with at least one S/S criteria: 78%. Number of readjustments made: 39. Changes maintained at the end of the study: 86%. Cases with at least one criteria at the end of the study: 58%. Controls with at least one criteria at the end of the study: 81%.

CONCLUSION: We found a high percentage of patients with inappropriate prescription of chronic medication (78%) according to S/S criteria. There was a significant difference between application of these criteria and the usual clinical practice reflected by a decrease of the percentage of patients with S/S criteria in the cases group (78 to 58%) after a year while a similar percentage in the control group (78 to 81%). We observed good adherence to the recommendations with 86% of the changes maintained after a year.

Keywords: STOPP/START criteria, Inappropriate prescribing, Primary Care.

OP-033

Coronary Artery Patients' Perceptions about Their Health and Disease

Buket Eylem Doğan¹, Dilsad Save²

¹Siyami Ersek Thoracic and Cardiovascular Surgery Training and Research Hospital, İstanbul

²Marmara University, School of Medicine, Department of Public Health

Background & Aim

Coroner artery disease is the first cause of mortality and morbidity in the World. Community awareness and public knowledge about he disease is essential components in control of the disease and treatment benefits. This qualitative study aimed to explore and understand coronary artery disease patients' perceptions about their disease and needs and also experiences about health services, health seeking behavior and issues about their satisfaction with health service.

Method

The study was carried out with participation of randomly assigned 52 patients aged 40-65 who were being treated in coronary artery disease units in a thoracic and cardiovascular surgery training and research hospital in İstanbul. A qualitative data collection method indepth interview was conducted in 30-45 minutes and all of them tape recorded. Before the interview data was gathered about patient's demographic and social characteristics, risk factors, disease status and taking medicines with short questionnaire.

Results

The interviews with participant indicated that there was lack of information about cardiac disease and preventive measures against this disease. Patients stated that they needed more explanation about their disease and ongoing treatment procedures. The most important issues about patient satisfaction were expressed as patient intensity, communication problems with health personel, difficulty about legal procedures in prescription, to be followed by different physicians and lack of confidence about diagnosis and treatment procedures. Patients complain about patient intensity in outpatient services, burden of long waiting times and short duration of examination. They told that the physician only gives medicines, neither talk with themselves nor examine carefully. Patients also told that they wanted to be examined by the same physician, and found boring to give same knowledge to different doctors. Most of the patients regarded themselves as " half-man/women" after heart attack even they have passed succesfull operation.

CONCLUSION:

Raising knowledge and awareness for cardiovascular disease in public is needed.

Keywords: qualitative study, indepth interview, patient perception, cardiovascular disease

OP-034

Blood pressure values are not compatible with medication adherence in hypertensive patients

Aysegul Uludag, Erkan Melih Sahin, Hasret Agaoglu, Selen Gungor, Yusuf Haydar Ertekin, Murat Tekin
Department of Family Medicine, Canakkale Onsekiz Mart University, Canakkale, Turkey

In management of hypertension maintaining the medication adherence with treatment is as important as starting treatment. Studies have shown that the majority of patients taking medication do not reach their target values. This study aimed to investigate the relationship between the patient medication adherence and blood pressure values and reflection to general well-being.

METHOD:

The study included 259 primary hypertension patients applying to the outpatient clinic. The patients with blood pressure measurements completed the medication adherence self-efficacy scale-short form 13 and the WHO-5 Well-Being Index. A Holter device was attached and 24-hour blood pressure monitoring was completed.

RESULTS: The mean points for medication adherence scale was 28.2 ± 9.3 [0-39] and mean WHO-5 points were 13.7 ± 4.6 [4-25] for patients. Clinical mean systolic blood pressure was 140.0 ± 12.6 and diastolic 84.8 ± 9.0 mm Hg, while 24 hour mean blood pressure was systolic 119.5 ± 10.6 and diastolic 73.3 ± 8.1 mm Hg. While there was a negative correlation between medication adherence scale scores and clinical systolic blood pressure ($r = -0.171$; $p = 0.006$), there was no correlation with other blood pressure readings. There was no correlation with WHO-5 score and clinical readings, though there was a positive correlation between ambulatory mean systolic and diastolic blood pressure ($r = 0.141$; $p = 0.023$ and $r = 0.123$; $p = 0.049$, respectively). There was a positive correlation between the patients medication adherence scores and WHO-5 scores ($r = 0.141$; $p = 0.023$).

CONCLUSION:

It was observed that the scales used in the study did not add benefit to hypertension monitoring. When clinicians assess medication adherence of patients they should benefit from objective blood pressure measurements and not scales.

Keywords: medication adherence, hypertensive patients, well being, ambulatory blood pressure, treatment

Keywords: Patient adherence, hypertension, well-being

OP-035

Eye Health – A Priority for GP's

Waqar Shah¹, Annette Dinnall²

¹Royal College of General Practitioners

²UK Vision Strategy

Introduction

Sight loss is common among older people and can affect their general health and wellbeing. The Royal College of General Practitioners (RCGP) have selected eye health, with a focus on ageing and sight loss, as a clinical priority.

Dr Waqar Shah, RCGP Clinical Champion for Eye Health, is working with the RCGP and UK Vision Strategy team to deliver this priority by driving a programme of work to improve GP confidence in diagnosing eye conditions earlier and to support patients with sight loss.

Method

A survey was sent to 50,000 members of the RCGP to establish levels of awareness of GPs and primary healthcare teams around managing the eye health of their patients and the needs of their patients with sight loss.

Results revealed that many GPs in the UK were not confident in detecting early signs of major eye diseases and welcomed further training and support.

Results

Sight loss in Older People the essential guide for general practice was created to help GP's and practice staff

increase their knowledge and awareness of the particular sight issues facing older people, reduce preventable sight loss amongst ageing patients and provide more effective management of eye conditions. The guide has been accredited by the RCGP and sent to every UK GP practice.

An online survey conducted in January 2015 to gather GP practice staff feedback on the guide showed that:

- 78 % either 'strongly agreed' or 'agreed' that the guide improved their knowledge of sight loss in older people
- 65% stated the guide would have a 'major' or 'moderate' level of impact on the care they provide to patients with sight loss

Conclusion

The guide was found to be very useful to GPs and will be promoted and disseminated at key GP and primary care conferences across the UK.

Keywords: eye health, GP's, sight loss

OP-036

Quality of life in patients with primary knee osteoarthritis

Taher E. Abd Elstaar¹, Aml Ahmed Salama², Heba Gamal Esaily³, Samer Ali Bolty⁴

¹Prof. of Orthopedics, Department of Orthopedics, Faculty of Medicine, Menoufia University, Menoufia, Egypt.

²Lecturer of Family Medicine, Department of Family Medicine, Faculty of Medicine, Menoufia University, Menoufia, Egypt

³Lecturer of Physical Medicine and Rehabilitation, Department of Physical Medicine and Rehabilitation, Faculty of Medicine, Menoufia University, Menoufia, Egypt.

⁴Resident of Family medicine, Faculty of Medicine, Menoufia University, Menoufia, Egypt.

OBJECTIVES:

To assess the quality of life in patients with primary knee osteoarthritis

BACKGROUND:

Osteoarthritis (OA) is the most common degenerative joint disorder and a major public health problem throughout the world. OA of the knee is a major cause of mobility impairment, which has an unpredictable and negative impact on health and quality of life.

Subject and METHODS:

A cross sectional analytical study involving (116) patients with primary knee osteoarthritis, who were admitted to outpatient clinic of rheumatology and orthopedic in Menoufia university hospital during the period of the study. Patients were included if they had radiographic evidence of hip or knee OA. Quality of life (QoL) in those patients was assessed through The OAKHQOL questionnaire contains 43 items and describes QoL in five domains: physical activities (16 items), mental health (13 items), pain (4 items), social support (4 items), social functioning (3 items); and 3 independent items. Each item is scored on a scale from 0 to 10.

RESULTS:

This cross sectional study was conducted on 116 of patients with primary knee osteoarthritis, (74.1%), of them were females and (25.9%) of them were males. The mean of age of the studied population was 51.37±8.85.

As regarding KHOAQOL score, a statistical significant correlation was reported with duration of the disease. Age, sex, BMI, Site of OA and use of drug regularly constituted no statistical significant difference in their KHOAQOL score.

The study shows significant positive correlation of BMI of patients and their physical activity parameter of KHOAQOL.

CONCLUSION:

The perception of quality of life is negatively affected by the duration of the disease, while age, sex, site if disease unilateral or bilateral and socioeconomic stander constituted no significant correlation. The study reported also that performing daily physical activity is affected by BMI of the patient.

Keywords: Quality, Primary, knee, Osteoarthritis.

Demographic Data of the studied group:

Demographic character	Total N =126	
	No	%
Sex		
-Male	30	25.9
-Female	86	74.1
Age of patients Mean \pm SD	51.37 \pm 8.85	
Marital status		
Single	0	0
Married	105	90.5
Widow or widower	7	3.4
Divorced	4	6
Residence		
-Semi-urban	53	45.7
-Urban	62	53.4
-Rural	1	0.9
Socio-economic score		
-Low	18	15.5
-Middle	41	35.3
- High	57	49.1

Effect of patients characters on their KHOAQOL score

Pt parameter	KHQOL total score* Mean \pm SD	Test of significance t test	P value
Age			
< or = 50 year (N=52)	52.85 \pm 11.55	1.63	0.105
> 50 year (N=64)	49.35 \pm 11.4		
Sex of the patient			
Male (N=30)	49.67 \pm 13.03	-0.633	0.494
Female (N=86)	51.36 \pm 11.03		
Duration of the disease			
< 5 years (N=36)	55.09 \pm 11.8	2.67	0.008*
> or = 5 years (N=80)	49.04 \pm 11		
Site			
Unilateral knee OA (N=51)	52.3 \pm 12.57	1.14	0.225
Bilateral knee OA (N=65)	49.83 \pm 10.65		
Management			
Drugs only (N=52)	51.28 \pm 11.363	0.071**	0.932
Drugs and physiotherapy at home (N= 61)	50.55 \pm 11.81		
Drugs and exercises(N=3)	52.09 \pm 13.69		
Drugs			
On need (N=98)	51.73 \pm 11.66	1.54	1.79
Daily (N= 18)	46.48 \pm 10.07		
BMI			
Normal weight (N=2)	33.48 \pm 0.00	2.59**	0.079
	52.61 \pm 11.78		
	50.87 \pm 11.36		

Obese (N=23)			
Overweight (N=91)			
Living Alone (N=3)	53.48±0.8	0.388	0.669
Not alone (N=113)	50.85±11.69		
Living stander High (N=57)	49.65±11.74		
Middle (N=41)	53.19±10.89	1.22**	
Low (N=18)	49.76±12.25		0.297

* *p* value < 0.01 ** *f* value of Annova testing. • The normalized scores of KHOAQOL vary from 0 (worst) to 100 (best possible HRQoL). As regarding KHOAQOL score, duration of the disease constituted statistical significant difference as the mean of the score in less than five year duration of disease group were 55.09 ± 11.8, while that of more or equal than five year duration of disease group were 49.04± 11. Age, sex, BMI, Site of OA and use of drug regularly constituted no statistical significant difference in their KHOAQOL score

Correlation of duration of osteoarthritis and KHOAQOL* parameters of the studied group:

Parameters	Duration of the disease	R	P value
Physical activity	-0.353	0.000**	
Pain	-0.189	0.42	
Mental health	-0.63	0.5	
Social functions	0.117	0.211	
Social Support	-0.178	-0.056	

* Knee Hip Osteoarthritis Quality Of Life. ***P* value < 0.001 High statistical significant positive correlation is detected between duration of the disease and physical activity parameters of KHOAQOL (*P* value < 0.001), while duration of the diseases constituted no statistical significant correlation with pain, mental health, social function and social support parameters of KHOAQOL

OP-037

Hypocortisolism is frequently overlooked and misdiagnosed as psychiatric or other disorders

Sergey Surkov¹, Sergey Surkov², Iballa Castro¹

¹Institut Català de la Salut, ABS Camps Blancs, Sant Boi de Llobregat (Barcelona), SPAIN

²Optima Salud, Barcelona, SPAIN

Hormonal disbalances are presented in many patients of all ages but widely overlooked if presented initially as psychic complaints. Patients with a variety of psychiatric disorders including addictions were found to have signs and symptoms of mild to moderate hypocortisolism that seems to be commonly misdiagnosed clinical condition if we make a review of the literature.

Cortisol plays a key role in physical and mental well-being and serves as the barometer of the hypothalamic-pituitary-adrenal axis (HPA), which regulates and controls responses to stress. Modern way of life continuously maintains all of us under stressful situations so many family doctors should managed with considerable pool of patients with depressions, posttraumatic stress disorder (PTSD), addictions, all are conditions with evidence of HPA dysregulation.

Low cortisol may be one of several maintaining factors in the illness but once hypocortisolism has developed it may itself lead to all that symptoms of PTSD or depression and represent an important maintaining factor in illness chronicity.

Patients with mild to moderate cortisol insufficiency are for the most part relegated to receiving a psychiatric diagnosis when, in fact, the hormonal disorder is represented. Many emotional symptoms of hypocortisolism are tagged as psychiatric disorders.

When the presented primary symptoms fit the diagnosis of depression doctors are urged to treat these patients with antidepressants and if patients responds to that treatment it reduces even more chances to diagnose an underlying hormonal disbalances that can be treated.

There are strong suggestions that hypocortisolism may be of clinical relevance and an appropriate comprehensive examination should be made in order to correctly diagnose it specially in cases of psychiatric disorders.

By correcting underlying cortisol or other hormonal impairments, many patients improved, with some patients having a total reversal of psychiatric symptoms.

It's reasonable to evaluate and treat hormonal insufficiencies prior to psychotropic medication.

Keywords: Cortisol, misdiagnosis, stress

OP-038

Detection of psychosocial problems by practice nurses in routine diabetes consultations: are patients ready?

Anneke Van Dijk, Loes Van Bokhoven, Job Metsemakers, Trudy Van Der Weijden, Jacques Van Eijk
Maastricht University, CAPHRI School for Public Health and Primary Care

Background and aim.

Because of a high prevalence of depression in diabetes patients and its adverse impact on complications, screening for depression is recommended in routine diabetes care. For the implementation of psychosocial self-management support in diabetes care, practice nurses were trained to identify patients with psychosocial problems. The detection rates appeared to be strikingly low. Therefore, we examined patients' readiness to discuss psychosocial problems with practice nurses during diabetes consultations in Dutch family medicine.

Method.

A mixed methods design was used within an experimental study evaluating a psychosocial self-management approach integrated in routine diabetes care. In-depth interviews were conducted with type 2 diabetes patients (n=12) with psychosocial problems. Based on a qualitative content analysis of patients' current experiences and perspectives on integrated care, a structured questionnaire was designed to further explore the findings among a larger group of patients (n=205). The questionnaire included 14 items measuring patients' agreement with statements about diabetes care and the role of the practice nurse therein.

Results.

The qualitative part of the study showed that patients viewed a diabetes consultation primarily as a biomedical check-up. They did not perceive discussion of psychosocial well-being as an integral part of diabetes management. The quantitative part showed that younger patients were more open to discussing psychosocial problems with the practice nurse than patients over 65. Patients' openness to discussing psychosocial problems was not significantly associated with the practice nurses being trained in the psychosocial self-management approach.

Conclusions.

Patients see practice nurses primarily as specialists regarding the biomedical management of diabetes. Although patients seemed to support the ideal of integrated care, they did not expect a discussion about psychosocial problems in diabetes consultations. The incorporation of systematic detection of psychosocial problems in diabetes care requires endeavours to make patients acquainted with the new role of the practice nurse.

Keywords: Primary care nursing, Diabetes mellitus type 2, depression

OP-039

Is computer-mediated family medicine a feasible project? Theoretical, methodological and practical dimensions

Pnina Besserglik¹, Izhak Gilat², Irit Kuppferberg²

¹Tel Aviv university

²Levinski College research departement

Current studies and surveys show that the feasibility of computer-mediated (CM) medical services has to be examined closely from medical, organizational, economic, and ethical points of view. Supported by a grant given by the Israeli Organization of Family Doctors, the current qualitative and quantitative study aimed at exploring the characteristics of CM doctor-patient encounters from the participants' perspectives. The qualitative stage was guided by the principles of data and method triangulation. Data collection comprised CM naturally-occurring doctor-patient encounters and doctors' and patients' personal stories focusing on meaningful stories related to the research aim. Following the qualitative stage, a quantitative questionnaire was administered to patients. The results show that patients' were satisfied with the choice of the CM channel. In the paper, we will highlight the theoretical, methodological and practical aspects of the study. Specifically, we will present and interpret the main findings of the qualitative and quantitative stages and focus on the advantages of CM family-medicine (e.g. documentation, time saving, anonymity and convenience) and its limitations (e.g. lack of physical examination and personal touch).

Keywords: COMMUTER-MEDIATED COMMUNICATION DOCTOR-PATIENT ENCOUNTER FAMILY-MEDICINE

OP-040

Perceptions of self-management in primary care: a cross-sectional survey study

Irene Bos Touwen¹, Jaap Trappenburg¹, Elke Tijhuis¹, Marieke Schuurmans¹, Niek De Wit²

¹Department of Rehabilitation, Nursing Science & Sports, University Medical Center Utrecht, The Netherlands

²Julius center for health sciences and primary care, University Medical Center Utrecht, The Netherlands

Background & aim

Chronic care and self-management support is increasingly provided in primary care settings. Primary care physicians and nurses have their own perceptions of self-management support and which patient will be successful in performing self-management. These perceptions will guide their decisions regarding the extent to which a patient is exposed to self-management. This study aims at increasing our understanding of the perceptions of general practitioners and practice nurses on providing self-management support. Furthermore, this study aims to identify patient-related factors that influence the success of self-management support as perceived by general practitioners and nurses.

Method

Between February and June 2014, a descriptive cross sectional survey was conducted in general practitioners and nurses working in primary care in the Netherlands. Data was collected through a self-administered online questionnaire.

Results

In total, 272 respondents completed the questionnaire (114 general practitioners and 158 nurses). The majority of care providers see their role in self-management support as coaching the patient. Most providers aim to give the patient responsibility for their health behavior and treatment. The three most frequently mentioned self-management activities were increase understanding of disease, establish common goals for treatment, and help patients take ownership in disease management. The perceived most important patient-related factors for successful self-management support were motivation (93.2%), knowledge of disease (82.6%), education level (80.4%), self-efficacy (77.2%) and patient-provider relationship (60.3%).

Conclusion

This study provides new insights in perceptions of primary care providers of self-management support in current practice and key patient-related factors influencing success of self-management support. Knowledge of providers' perceptions regarding self-management support can improve and support the implementation of self-management. Knowledge of patient-related factors that are perceived as facilitators or barriers for self-management provides insight in factors that influence care providers to support self-management to individuals.

Keywords: Self Care, Primary Health Care, General practitioners, (practice) nurses

OP-041

Effects of blood glucose regulation and comorbidity on quality of life in type 2 diabetic patients – A preliminary multicenter study

Bilge Sönmez¹, Burcu Kayhan Tetik², Engin Burak Selçuk², Feyza Bezirgan Sarıgüzel³, Ismail Hamdi Kara³, Ergün Öksüz⁴

¹Çerkeş State Hospital Family Medicine, Çankırı, Turkey

²Inonu University Department of Family Medicine, Department of family medicine, Malatya, Turkey

³Düzce University Department of Family Medicine, Department of family medicine, Düzce, Turkey

⁴Başkent University, Faculty of medicine, Department of family medicine, Ankara, Turkey

INTRODUCTION:

Diabetes Mellitus (DM) is a major health problem with increasing incidence, serious complications and impair the patient's quality of life (QOL). Aim of our study is considering effects of blood glucose regulation or comorbid conditions on QOL and diabetes specific QOL.(DQOL)

Material – METHOD:

Our study is planned cross-sectional in four provinces; Ankara, Malatya, Diyarbakir ve Duzce. Participants diagnosed with type 2 diabetes (T2DM) according to ADA criteria and who gave patient acceptance answered sociodemographic questionnaire, EQ-5D scale for general QOL and DQOL. Our study will be carried out in a total of 700 patients in four provinces, currently completed in Ankara and Duzce and we present preliminary study results.

RESULTS:

Mean age of 260 patients was 56.2 in Ankara and in Duzce mean age of 99 patients was 57.4 ± 8.2. Demographic data of the participants are presented in Table 1.

Average of HbA1c levels was found 8.0% (min = 4.2% - max = 15.6%, SD = 1.9). For 359 patients with EQ-5D scale was determined 25 different health status. Visual Analog Scale scores were negatively correlated with HbA1c levels ($r = -0.124$, $P = 0.018$). When DQOL subgroups compared according to HbA1c levels; DQOLA, DQOLB, DQOLC and DQOLD scores in the group with lower HbA1c (<6,5%) were 36.9, 36.5, 18.2 ve 3.4, respectively and same scores in the group with HbA1C over 6,5% were 36.2, 40.2, 15.1 ve 2.7, respectively ($p < 0,005$).

CONCLUSION:

T2DM is a disease that can deteriorate self-care and decreases quality of life. In management of chronic diseases, holistic and comprehensive approach of family physician can provide good patient compliance and this attitude promises improvement in quality of life.

Keywords: Diabetes, Comorbidity, Quality of Life

Ankara and the distribution of sociodemographic characteristics of their patients in the province of Duzce

PROVINCE	ANKARA (n, %)	DUZCE(n, %)	TOTAL(n, %)
Gender			
Female	154(59.2)	63(63,6)	217(60.4)
Male	106(40.8)	36(36.4)	142(39,6)
Educational status			
Illiterate	87(20.8)	22 (22.2)	109 (30.4)
Primary	111(42.7)	31(31.3)	142(36.9)
Junior high school	30 (11.5)	15(15.2)	45(12.5)
High school	21(8.1)	19(19.2)	40(11.1)
University	11(4.2)	12(12.1)	23(6.4)
Socioeconomic level (TL)			
Under minimum wage	33(12.7)	37(37.4)	70(19.5)
Minimum wage-1500	201(77.3)	52(52.5)	253(70.5)

1500-3000	26(10)	10(10.1)	36(100)
Working conditions			
Housewife	148(56.9)	42(42.4)	190(52.9)
Retired	82(31.5)	44(44.4)	126(35.1)
Worker	12(4.6)	8(8.1)	20(5.6)
Officer	18(6.9)	5(5.1)	23(6.4)
Smoking status			
Non-smoker	206(79.2)	76(76.8)	282(78.6)
<1 pack/day	26(10)	21(21.2)	47(13.1)
≥1 pack/day	28(10.8)	2(2)	30(8.4)
Body Mass Index			
Underweight (<18,5)	1(4)	4(4)	5(1.4)
Normal (18,5 – 24,9)	24(9.2)	35(35.4)	59(16.4)
Overweight(25,0-29,9)	109(41.9)	0(0)	109(30.4)
Obese (30,0 – 39,9)	117(45)	58(58.6)	175(48.7)
MorbidObese (≥40,0)	9(3.5)	2(2)	11(3.1)

OP-042

Relationship Between Obesity and Thyroid Functions in Adults

Ferhat Ekinci¹, Demet Merder Coşkun², Özgür Çağaç³, Hüseyin Yıldız⁴, Halis Yılmaz⁵, Arzu Uzuner⁶

¹Public Health Directory, Van, Turkey

²Haydarpasa Numune Education and Training Hospital Family Medicine Clinic, Istanbul, Turkey

³Salihli State Hospital Cardiology Clinic, Manisa, Turkey

⁴Malatya State Hospital Internal Medicine Clinic, Malatya, Turkey

⁵Sırnak Guclukonak State Hospital Family Medicine Clinic, Sırnak, Turkey

⁶Marmara University Medical School, Department of Family Medicine, Istanbul, Turkey

AIM: Obesity affects prognosis of many comorbid diseases negatively. The aim of this study was to investigate the relationship between obesity and thyroid functions.

METHOD: This observational descriptive study was conducted in outpatient clinics of a tertiary hospital in Istanbul, between 2011-2012. Consecutively selected 650 adults 19-65 years of age were recruited in the study. Thirty two patients who had previously thyroid disease were excluded from the study. Epidemiologic data have been collected by a questionnaire. Height and weight were measured, BMI was calculated and a blood test including thyroid function tests and lipid profile was performed. Participants were divided into three groups according to their BMI as normal weight (<20), overweight (20-24) and obese (≥25). Data was compared between the groups.

RESULTS: Data of 618 participants (53% female/47% male) was analyzed in this study. Mean age value was 43±15. There were 175 (28.3%) participants in normal weight, 242 (39.2%) in overweight and 201 (32.5%) in obese group. There was no statistically difference in terms of thyroid function levels, but there was a difference in terms of lipid profiles between groups. Atherogenic lipid levels (T.cholesterol, LDL and triglyceride) were higher and HLD levels were lower in overweight and obese group comparing with the normal weight group (p<0.05) but there were no statistically difference between overweight and obese groups (p>0.05).

CONCLUSION: This study is one of the few studies in the literature showing that there is no relationship between

obesity and thyroid function tests. On the other hand this study supports the common finding in the literature which is atherogenic lipid levels are higher in overweight and obese groups comparing with normal weight group.

Keywords: Obesity, Adults, Thyroid function tests

OP-043

Assessment of Vitamin D and Bone Mass Density Relation Among Adults Attending a University Hospital

Gökhan Eminsoy, Ali Ümit Geçkil, Altuğ Kut

Department of Family Medicine, Baskent University, Ankara, Turkey

Background & AIM: Vitamin D is an important component of bone metabolism. Mineralization of bones can be demonstrated using bone mass density (BMD) measurement. We aimed to show the relation of Vitamin D and BMD among adults attending a university hospital.

METHOD: The research is planned as a retrospective cohort study. Patients' files who applied to Baskent University Ankara Hospital between January 1st 2012 and December 31st 2014 were investigated for Vitamin D, BMD, calcium, phosphorus and parathyroid hormone. Patients with abnormal levels of calcium or phosphorus or parathyroid hormone will be excluded from the study. All data are recorded and analyzed using the SPSS software.

RESULTS: Out of 51 patients, 5,9% (n=3) was male while 94,1% (n=48) was female. The mean age of patients was found to be 57,9 years. 23,81 was the mean value of Vitamin D whereas average T scores of L1-L4 and femur neck were found to be -1,442 and -2,112 respectively.

CONCLUSIONS: We believe that there is a direct relationship between Vitamin D and BMD score despite no significant correlation found yet between Vitamin D and BMD scores among this limited number of patients. The study and data collection still continues.

Keywords: Vitamin D, BMD score, parathyroid hormone, calcium, phosphorus.

OP-044

Patient empowerment: a life changing practice or an illusion

Burcu Gürhan, Tuğrul Bıyıklıoğlu, Mehmet Urgan
Department of Family Medicine, Ankara University, Ankara, Turkey

BACKGROUND & AIM:

Patient empowerment has been on the focus of researchers working on patient education, chronic disease management, patient-centred medicine, e-health/tele-health interventions, health policy & administration for decades. In spite of a wide literature, there hasn't been a consensus over the core elements of empowerment and the proper way of integrating into health care system. The aim of this study is to: review literature regarding patient empowerment; identify related concepts and prerequisite qualifications; determine barriers & facilitators of implementation in real world health care settings; address issues concerning measurement of outcomes.

METHODS:

We conducted a search using key words "patient empowerment" in Web of Science (W.O.S.) database, through January 1960 to October 2014, among articles published in English. Non-health related topics were excluded in order to refine the search. Additionally, we searched web for related articles as an outside source.

RESULTS:

411 articles were extracted from database search and 36 additional were found on the web search. 8 articles were identified as duplicates and excluded. 439 articles were included in initial review. Based on title and abstract review and full text availability, a selection method was processed. 192 articles met the eligibility criteria and were included in detailed review.

CONCLUSION:

Current health care system is overwhelmed by the burden of chronic diseases. There is an urgent need for a paradigm shift. The concept of patient empowerment can answer the purpose but it is far from being well established. A consensus has to be built about the definition. Uncertainties regarding measurement of outcomes have to be clarified. Additionally, empowerment is not a stand-alone concept and related issues like self-management, health literacy, shared decision making and patient-centred medicine have to be taken into consideration. If we take necessary actions, health care system will come out of this crisis stronger.

Keywords: patient empowerment, self-management, chronic disease management, patient-centred medicine

OP-045

Lipid parameters are in relation with elasticity of great arteries in hypertensive patients

Claudia Iftode¹, Stela Iurciuc², Mircea Iurciuc², Ioana Padure³, Carmen Roman⁴, Iuliana Zarici⁵, Ioana Budiu⁶, Claudia Maria Stefanescu⁷

¹Cabinet Medical de Medicina Familiei Dr. Iftode Claudia

²Department of Cardiology, Victor Babes University of Medicine and Pharmacy Timisoara, Romania

³Cabinet Medical de Medicina Familiei Dr. Ioana Padure

⁴Cabinet Medical de Medicina Familiei Dr. Carmen Roman

⁵Cabinet Medical de Medicina Familiei Dr. Iuliana Zarici

⁶Cabinet Medical de Medicina Familiei Dr. Ioana Budiu

⁷Centrul Medical Dr. Stefanescu SRL

BACKGROUND:

With aging lipid parameters tend to modify. This represents a risk factor which is useful to monitor in Primary Practice. Arterial elasticity represents the opposite of the arterial stiffness. It shows how elasticity decreases with age.

Research question:

Can we establish a correlation between lipid parameters and the arterial stiffness in hypertensive persons?

METHOD:

We selected 120 hypertensive individuals aged 40 to 80 years. Cases with secondary hypertension were not included in the study. Lipid parameters of these individuals were measured using the Guideline for the Management of Hypertension (European Society of Cardiology / European Society of Hypertension). Pulse Wave Velocity (PWV) of the aorta has also been measured (as the gold standard for arterial rigidity) using an Arteriograph (Medexpert). We tried to establish a correlation between lipid parameters and PWV.

RESULTS:

We found the following results:

A) The PWV=9.29m/s, Standard Deviation (SD) = +/-1.94) and Total Cholesterol (TC) = 209mg/dl SD=+/-48.2, correlate linearly with Pearson index $r=0.481$.

B) PWV=9.29m/s and LDL cholesterol (LDLc)=116mg/dl +/-49.8, correlate linearly with Pearson index $r=0.505$.

C) Triglycerides (TG) = 148mg/dl SD=+/-121 and PWV correlate linearly with Pearson index $r=0.389$,

D) Also HDL cholesterol (HDLc) =48.1mg/dl SD=+/-12.9 and PWV negatively correlate with a Pearson index $r= -0.354$.

CONCLUSIONS:

Evaluating aortic stiffness and lipid parameters are useful in the evaluation of hypertensive patients with cardiovascular risk. Arterial stiffness measured using with an Arteriograph directly correlates with TC, LDLc and indirectly with HDLc.

Keywords: Lipid parameters, elasticity of great arteries, hypertensive patients.

OP-046

Dietary behaviour of Hindustani immigrants with type 2 diabetes mellitus

Cristina Sandu Blendea, Gertrudis Garcia Quezada, Marta Gamez Salvado, Judit Llussà Arboix, Eulalia Borrell Thio, Eva Muñoz Mata, Núria Montellà Jordana
Catalan Health Institute, Barcelona, Spain

Background and AIMS:

The Hindustani who migrate have higher prevalence of diabetes mellitus type 2 (T2DM) for their genetic predisposition, increased risk of central obesity, sedentary lifestyle, westernization and acculturation diet (rich in carbohydrates).

OBJECTIVE: To determine the characteristics of the diet and the level of metabolic control of Hindus patients with T2DM attended at primary care medical center.

METHODS:

Cross-sectional study design was used to evaluate T2DM patients over 18 years old, born in Bangladesh, India or Pakistan attended in the Sant Roc primary care center from Badalona (Spain). Pregnant women, terminally ill patients or with dementia were excluded. Evaluative parameters from clinical interview and review of medical records: demographic data, waist circumference, glycated haemoglobin (HbA1c) value, treatment of T2DM and 24-hour dietary recall. Carbohydrate distribution and type of diet (hypo/normo /hypercaloric) was calculated.

RESULTS:

Final sample: 82 patients. Women =22 %. The average age =48.5 years (SD± 8.7). Rural origin =48.8 %. Poorly controlled HbA1c = 50.6 % (13.6% with HbA1c > 10). The 3.8% of poorly controlled patients do not perform drug treatment. Central obesity in 56% of the total and 41% of those with BMI < 30. The 96.3 % consume home-cooked food. Vegetarians=4.9%. Proportion of nutrients: carbohydrates excess =62.2%; lipid deficit =89%; protein deficit = 31.7%. Only 3.7% patients distributed carbohydrate well throughout the day; 50% carry the main consume at night (dinner). Type of diet: 65.9% hypocaloric; 12.2% normocaloric. More than 50% do proper exercise.

CONCLUSIONS:

Hindustani diabetic patient is young, with central obesity and poor glycemic control. It has not given the phenomenon of acculturation. The waist circumference is more useful than BMI to assess obesity. Most patients perform improper diet: hycaloric diet with deficit of protein and lipids and excess of carbohydrates, poorly distributed throughout the day.

Keywords: Keywords: Diabetes Mellitus type 2, Food Habits, Emmigrants and immigrants

OP-047

The effects of structured follow-up from primary care during the cancer continuum. Study protocol of the GRIP-study

Jetje A.A. Perfors¹, Charles W Helsper¹, Anne M May¹, Elsken Van Der Wall², Niek J De Wit¹

¹Department of Julius Center for Health Sciences and Primary Care, University Medical Center Utrecht, Utrecht, the Netherlands

²Department of Internal Medicine and Dermatology, University Medical Center Utrecht, Utrecht, The Netherlands

Background & AIM: Due to the ageing population and improving treatment the number of cancer patients and cancer survivors is increasing. Policymakers, patients, specialists and GP's advocate a larger role for the primary care starting at diagnosis. The assumption is that this could stimulate integrated care, decrease costs and would better meet the patients' expectations. However, the effect of structured follow-up from primary care during the cancer continuum has not been studied yet.

The present study aims to evaluate the effect of structured follow-up from primary care in addition to usual care, on satisfaction with care and healthcare utilization for cancer patients treated with curative intent.

METHODS: We will conduct a multicenter, two-arm randomized controlled trial in The Netherlands. We will enroll 150 patients who will be treated with curative intent for either prostate-, breast-, lung-, colorectal cancer or melanoma. Further inclusion criteria are: age 18 years and older, a sufficient mastery of the Dutch language and a general practitioner (GP) who participates in the study. Control patients will receive usual care. The intervention arm will receive usual care and guidance by a GP and a primary care oncology nurse. First, a GP consultation follows directly after diagnosis to empower the patient for shared decision making (SDM). Hereafter, a minimum of five contacts with the nurse, including one home visit, will follow. Primary outcomes are: patient satisfaction and healthcare utilization. Secondary outcomes include quality of life, mental health, patient empowerment, SDM, sick leave and satisfaction with provided information. Measurements will be performed on specified cancer care milestones, within a maximum 1-year follow-up period.

CONCLUSIONS: This randomized controlled trial evaluates structured follow-up from primary care in addition to usual care. Findings from this study will inform stakeholders to design a framework for optimal follow-up for cancer patients, starting at diagnosis.

Keywords: "Oncology Nursing"[MESH], "cancer care", "cancer survivor"

OP-048

Integrating Palliative Care in Primary Care

Ana Nunes Barata

USF Amora Saudavel

BACKGROUND:

The need to increase the number of healthcare professionals involved in palliative and end-of-life care is a healthcare priority in developed nations. In 2050, WHO estimates that two billion people will be over 60 years old. Chronic diseases will be more prevalent and the main health burdens for older people will come from noncommunicable diseases. It is therefore important to develop and adapt Primary Care to this setting, preparing primary care physicians to provide good palliative care at patients' homes and relieving the uncertainty that these physicians sometimes feel about the best management option and their role when caring for a patient with palliative needs.

METHODS:

Revision of articles published on PubMed featuring the MeSH terms "Palliative Care" and "Primary Health Care".

RESULTS:

The 18 analyzed studies show that good palliative care provided by primary care physicians has several positive outcomes, including patients dying in their place of preference, improved patient education and better symptom management. Models where primary care providers look after the palliative patient have also shown to be cost-effective within the healthcare service.

CONCLUSIONS:

The work of primary care physicians is defined by a bio-psycho-social approach to the patient. The physician gets to know not only the patient, but also the patient's family, which means he is in a privileged position to provide adequate palliative care to the patient. This presentation's goal is to show some results of palliative care interventions carried out by primary care physicians and to stress the importance of integrating formal palliative care provision in the usual practice of a primary care physician, so as to provide a greater sense of comfort to patients.

Keywords: Palliative Care, Primary Care, home care

OP-049

Self-reported Hindering Health Complaints Of Community-dwelling Older Persons

Sophie C.e. Van Blijswijk, On Ying A. Chan, Anne H. Van Houwelingen, Jacobijn Gussekloo, Wendy P.j. Den Elzen, Jeanet W. Blom

Department of Public Health and Primary Care, Leiden University Medical Center, Leiden, The Netherlands
Background and aim

Proactive care for community-dwelling older persons targeting self-reported hindering health complaints might prevent a decline in function. To effectively offer proactive care, knowledge of which complaints hinder older persons most from day-to-day is needed. Therefore, the aim of this cross-sectional study was to acquire insight in the broad spectrum of self-reported hindering complaints of community-dwelling older persons, the association with functional outcomes, and the awareness of GPs concerning these complaints.

Method

Within the ISCOPE trial, participants (aged 75+) received the ISCOPE screening questionnaire. Answers to the open question "At the moment, which health complaints limit you the most in your day-to-day life?" were coded according to the ICPC-1-NL. We examined the prevalence and the association between the number of complaints and functional outcomes (Groningen Activities Restriction Scale [GARS], Cantril's Ladder, Mini-Mental State

Examination [MMSE], Geriatric Depression Scale-15 [GDS-15], and De Jong Gierveld Loneliness Scale [DJG]). Electronic patient registers (EPR) of 4360 participants were gathered and searched for the most reported complaints.

Results

In total 7285 persons participated (median age: 81.0 years [IQR 77.8-85.3], 38.6% males). 2379/7285 participants (32.7%) reported no complaints. The others reported 13,524 complaints (median 1, range 0-18). Most reported were problems with walking/standing (n=1609, 22.1%), pain (n=1515, 20.8%) and weakness/tiredness (n=620, 8.5%). In the EPRs these complaints were also mentioned in respectively 28.3%, 91.3% and 55.5%. A higher number of self-reported complaints was related to poorer scores on the GARS, Cantril, GDS-15, and DJG.

Conclusion

One third of the participants reported no complaints. Problems with walking/standing, pain, and weakness/tiredness were most reported, but often not found in EPRs. The number of complaints was associated with poorer scores on functional outcomes. GPs should ask about these complaints and their influence on daily life as a basis for proactive care.

Keywords: geriatrics, self-reported complaints, functional limitations

OP-050

Fear of falling

Lourdes Martin¹, M Victoria Castel², Angel Otero³

¹Dirección Asistencial Oeste, Gerencia de Atención Primaria, Madrid, Spain

²Centro de Salud Dr. Castroviejo, Madrid, Spain

³Departamento de Medicina Preventiva y Salud Pública, Universidad Autónoma de Madrid, Madrid, Spain

BACKGROUND AND AIM

Numerous studies analyze the risk factors associated with fear of falling. Many of them showed that fear is a direct consequence of the fall.

The aim of this study is to estimate the prevalence and associated factors of fear of falling on an urban population in Madrid.

METHOD

Cross-sectional study of the basal population of the "Peñagrande cohort". A semistructured survey was performed between June 2007 and June 2008. Two measures of fear of falling were used: direct question and Tinetti's FES scale.

Individuals over 65 years of age, living in the district of Peñagrande in Madrid. Was selected 814 subjects by means of a stratified random sampling.

RESULTS

A 73.3% response rate was achieved. Average age was 74.8 years with 48.5% of males. The prevalence of fear of falling was 56.9% when a direct question was used and 45.6% with Tinetti's FES scale. These figures reach 75.1% and 65.3% respectively in those who have suffered a previous fall (51.5% and 42.4% in those who have not suffered any). Fear increases with age, is more frequent in women, and in those living alone or with low incomes. It is associated to the diagnosis of depression, taking more than 4 drugs simultaneously, inadequate prescriptions or drugs, and the use of drugs with central nervous system activity. Fear of falling is associated to disability, functional impairment, obesity, frailty, and equilibrium disorders.

CONCLUSIONS

Fear of falling is highly prevalent among elderly subjects and has a strong correlation with multiple risk factors. It may trigger functional abnormalities and a decrease on physical activity. This could lead to a state of inability, dependence and institutionalization that may result in psychological and quality of life impairment. Fear of falling must be managed to prevent the development of such a "fear spiral".

Keywords: Fear of falling, depression, inadequate prescription

OP-051

Follow up of 167 INRs in elderly patients under anticoagulants: compliance of medical decisions with guidelines for overdosage management

Gerard Nguyen¹, Dominique Le Moul¹, François Sigwald³, Gladys Arbaud², Thérèse Postelnicu², Isabelle Penel³

¹Cabinet Marcel Monny Lobe, Soisy Sous Montmorency, France

²EHPAD Arpage Jacques Offenbach, Arpad, Epinay sur Seine, France

³EHPAD La Cerisaie, Montmorency, France

More than 1% of the total population in France are under treatment by oral anticoagulants using Vitamin K antagonists. Use, misuse, underuse and overuse are frequent. National guidelines of good practices for overdosage management by using INRs of patients under anticoagulants have been widely published. We underwent a survey of 167 INRs performed in 2 nursing homes in 18 patients over 80 years old under Vitamin K Antagonists during the last six months. All were asymptomatic of bleeds. The results were classified into 5 groups with the respective distribution: A (INR <2):38.92% (65/167), B (2 ≤ INR <3): 51.49% (85/167), C (3 ≤ INR < 4):9.58% (16/167,) D (4 ≤ INR < 6): 1.79% (7/167),E (INR ≥ 6):3/167. While INR ≥ 4, guidelines recommend to skip the intake of the prescribed dose, we found only 57.13% of compliance to guidelines (4/7 in group D). And while INR ≥ 6 we found 66.66% of patients having their treatment stopped and with the oral administration of 1 to 2 mg Vitamin K.

An overall of 15.6% of the patients > 80 years old had an overdosage with an INR > 3 knowing that the risk of bleeds in elderly patients remains high.

Our survey showed that half of the elderly patients having oral anticoagulants were well controlled with an INR between 2 and 3, In patients with asymptomatic overdosage, decisions in accordance with guidelines could be improved. Overdosage with an INR > 6 should be managed perfectly by applying systematically the national guidelines. Administration of oral vitamin K may be done by nurses while INR > 6 in case of non availability of the primary care practitioner for the decision.

Keywords: INR, anticoagulants, Vitamin K antagonists, elderly patients

OP-052

Reliability and Validity Study of Hwalek-Sengstock Elder Abuse Screening Test (H-S/East)

Nilgün Ozcakar¹, Akca Toprak Ergonen², Mehtap Kartal¹, Hakan Baydur³

¹Department of Family Medicine, Dokuz Eylul University Medical Faculty, Izmir, Turkey

²Department of Forensic Medicine, Dokuz Eylul University Medical Faculty, Izmir, Turkey

³School of Health, Celal Bayar University, Manisa, Turkey

Background & Aim

Elder abuse and neglect is an important social issue that is discussed worldwide. Its objective measurement is important for recognition and prevention. We aimed to determine reliability and validity of the Turkish version of the "Hwalek-Sengstock Elder Abuse Screening Test (H-S/East)" developed for determining of abuse or neglect in elderly.

Methods

H-S/East has 15-item, three-dimensional structure: direct abuse, characteristics of vulnerability, and potentially abusive situation. It's translated according to guidelines, experts evaluated for content validity and cultural adaptation then test-retest reliability was studied. WHOQOL-OLD.TR and Barthel Index was used for the relationship between H-S/East validity. Volunteered 252 elderly participants were visiting family health centers. Cronbach's alpha for internal consistency, exploratory factor analysis for content validity, chi-square test for construct validity and for discriminant ability was used. ROC curve was used for cutoff point, sensitivity, and specificity and under area are then calculated. SPSS 15.0 was used for analysis. Significance was p <0.05.

Results

The mean age was 73.4±6.4 and 58.3% was female. Approximately 54.8% married, and 90.9% used drugs

regularly. There's no significant differences according to gender in total and all three dimensions of H-S/East scale ($p>0.05$). In the test-retest reliability, ICC values for direct abuse, characteristics of vulnerability, and potentially abusive situation were 0.88, 0.73 and 0.80, respectively.

Cronbach's alpha for internal consistency H-S/East the total score was 0.741. Exploratory factor analysis was obtained 5 factors and explained variance was calculated 61.8%. According to self-report abuse, 11 items was obtained for the construct validity, and discriminant analyses used that correctly classified items was 94.8%. Cutoff value was 6, and sensitivity, specificity, and under area in the ROC curve were 76.9%, 96.2%, 0.938, respectively.

CONCLUSION: Turkish version of Hwalek-Sengstock Elder Abuse Screening Test can be used as a reliable, valid clinical tool for the assessment of elder abuse.

Keywords: Reliability and Validity, Elder Abuse, Screening Test

OP-053

Determining Social Support, Mental Health and Quality of Life in 65 Years and Older Home Care Patients

Emine Neşe Yeniçeri¹, Betül Battaloğlu¹, Mustafa Nuri Ceyhan², Deniz Aslan³, Cem Şahin⁴, Yasemin Ünal⁵, Birdal Yıldırım⁶

¹Department of Family Medicine, Muğla Sıtkı Koçman University Medical Faculty, Muğla Turkey

²Direction of Public Health, Muğla Turkey

³Home Care Unit, Muğla Sıtkı Koçman University Training and Research Hospital, Muğla Turkey

⁴Department of Internal Medicine, Muğla Sıtkı Koçman University Medical Faculty, Muğla Turkey

⁵Department of Neurology, Muğla Sıtkı Koçman University Medical Faculty, Muğla Turkey

⁶Department of Emergency Medicine, Muğla Sıtkı Koçman University Medical Faculty, Muğla Turkey

Background and AIM: Loneliness, low level of social support, lacking a valid caregiver, declining cognitive function have effects on morbidity, mortality and life quality in elderly. On the other hand, several elderly patients have both dementia and major depression. Major depression may be a risk factor or a comorbid disorder for dementia. It is difficult to distinguish cognitive impairment in dementia and major depression. Depression also effects quality of life. The aim of this study was to assess social support status, cognitive functions, depression and life quality of home care patients registered to Muğla Sıtkı Koçman University Training and Research Hospital Home Care Unit in Muğla province (Turkey). This study is a part of comprehensive geriatric assessment project conducted in this unit.

METHOD: In this cross-sectional study, social support is determined with Multidimensional Scale of Perceived Social Support. We also investigated social Networks like living marital partner, living offspring and siblings, other relatives or a care-giver, social relationships, sociodemographic factors and chronic conditions. We measured mental health using Geriatric Depression Scale and Mini Mental State Examination (MMSE). With MMSE, cognitive capabilities of the participants were evaluated such as orientation, attention, concentration, memory, calculation, language and praxis. For life quality investigation, we used World Health Organization Quality of Life instrument brief version (WHOQOL-BREF).

RESULTS: 143 elderly participated to the study. Average age was 82.1 ± 7.4 (Min:65, max:103). According to MMSE, 75.5% (108) of the patients had severe dementia, 16.0% (23) of them had mild dementia and 8.3% (12) were normal. 88.1% (126) had severe depression, 7.7% (11) of them had mild depression and 4.2% (6) had no depression.

CONCLUSION: In this study a high prevalence of depression and dementia were found. In the second step, these patients will have an advanced evaluation for dementia and depression and will be given treatment if necessary.

Keywords: elderly, social, support, mental, health, quality

OP-054

Elderly satisfaction with primary physician's health education in waiting room of pension bank: its causes and effect to institution image

Aria Kekalih¹, Fithriyyah Sha², Idqan Fahmi²

¹Community Medicine Department, Faculty of Medicine Universitas Indonesia, Jakarta-Indonesia

²Graduate Program of Management and Business – Bogor Agricultural University (IPB), Bogor-Indonesia

INTRODUCTION:

When health education program to recognize and prevent degenerating disease was considered important to elderly, a national pension bank in Indonesia set initiative to provide additional services in form of health education and consultation. Elderly community came and gathered regularly in pension bank at the first week of the month. Therefore, bank tried to optimize this momentum by performing health education and consultation program in the waiting room, cooperated with trained primary physician. This study investigates how elderly satisfy with the program and consider it important, and also how it might build positive image to the institution.

METHOD:

We investigated 342 elderly in 14 cities of bank branches in Indonesia who participated in health education and consultation program. We assessed their satisfaction level related to health education and its cause using SERVQUAL approaches. We also investigated how it would trigger individual willingness to spread word of mouth in promoting the health education program and the institution to other elderly, using standardized equation modeling (SEM) analysis.

RESULT:

Most of elderly satisfy and understood the health education content (90%) and considered this program as meaningful program (84%). Tangibles factor (educator and doctor performance) and reliability (delivery method of health education content) are the highest factor contributes to elderly satisfaction. Health consultation contributed more in triggering word of mouth to promote the program and institution (SEM $r=0.81$) rather than of health education (SEM $r=0.58$)

DISCUSSION:

Elderly value health education and consultation in pension bank as a satisfying and meaningful program to optimizing and creating quality time while queuing. Health educator performance, and also health content delivery method were considered important key factor to successful health education for elderly. This approach was also potential in building institution positive image

Keywords: health education, satisfaction, primary physician, elderly

OP-055

The Use of ICPC-2R to Intensify Diagnosis in Remote Primary Care of West Papua Province, Indonesia

Harry Allan Papendang¹, Trevino Aristarkus Pakasi²

¹Faculty of medicine Universitas Papua

²Division of family medicine, department of community medicine, Faculty of medicine Universitas Indonesia;

Background. Primary care (Puskesmas) in Indonesia used ICD-10 to classify diseases although it was difficult to prove in limited facilities. The ICPC was introduced to Puskesmas Malawili, in Sorong Regency, West Papua Province, in collaboration with the new medical school of West Papua and Universitas Indonesia. The study aimed to describe the experience of using the two classification systems in the remote primary care.

Method. The cross-sectional study, done in February 2015, was held in Kampung Malakabu where the Puskesmas visited monthly due to geographical constrain. As usual, doctors examined patients and classify the diagnoses using the two systems, first using the LB1 form (ICD-10) as reported by Puskesmas, and ICPC-2R. Then we compared the results.

Result. Eighty seven patients came for consultation. They were 46% male, 65.5% adults >18 years. Mean age of the adults was 34.3 years and children was 5.9 years. The most chief complains was coughing (ICPC code R74) followed by muscle pain (L18). The most three diagnoses were acute upper respiratory tract infection (R74),

muscle pain (L18) and stomach function disorder (D87). The data was compared with the February data of the Puskesmas Malawili, which classified the first three diagnosis as: acute respiratory tract infection, rheumatic, other diseases i.e gastritis. We found that the use of ICPC gave more precise diagnosis rather than filling the monthly report form based on ICD 10. For example, the use of upper respiratory infecton was more precise than acute respiratory infection, since the anatomical site was determined; rheumatic was often used to describe muscle or bone complains even though without laboratory confirmation, as in the LB1 form.

Conclusion. Although it's still too early, we concluded that the use of ICPC-2R gave more precise diagnosis as it was easier to implement, compared with using ICD-10.

Keywords: introducing, ICPC-2R, diagnosis, remote primary care

OP-056

Iron Supplement In Mild Anemic Pregnant Women: Are We Have An Option?

Adibah Hanim Ismail¹, Haniza Hashim², Juwita Shaaban³

¹Department of Family Medicine, Universiti Putra Malaysia, Serdang, Selangor, Malaysia

²Pendang Health Clinic, Kedah, Malaysia

³Department of Family Medicine, Universiti Sains Malaysia, Kubang Kerian, Kelantan, Malaysia

Background

The objectives of this study is to determine the effectiveness of weekly versus daily iron supplements among mild anemic pregnant women attending antenatal clinic at a Maternal and Child Health Clinic at East Malaysia

Methods

Randomized controlled trial was done over a six- month period. Seventy pregnant women at 12-20 weeks of pregnancy with Hb level of 9-11gm/dL were enrolled in this study. Patients were randomized equally into 2 groups. Patient in the daily group received 200mg of ferrous fumarate to be ingested daily, whereas those in weekly group received 2 tablet of 200mg of ferrous fumarate to be ingested once a week. Hemoglobin and serum ferritin level were taken at first visit and 8 weeks later.

Results

Majority (92.9%) of the participants were Malays and maternal age ranged from 16 to 42 years. Mean gestational age at baseline was 14 weeks. The response rate (RR) for both groups were 100%. The compliance was good in both groups and no adverse side effects were reported. At first visit, the haemoglobin and ferritin level in the daily group was 10.4g/l and 71.7µg/l and for weekly group was 10.5g/l and 79.4µg/l respectively. After 8 weeks of iron supplementation, the hemoglobin and ferritin level in daily group was 10.5g/l and 74.4µg/l and in the weekly group was 10.2g/l and 78.6µg/l respectively. Iron supplementation among mildly anemic women in either daily or weekly groups did not show any significant difference in the hemoglobin(p= 0.078) and ferritin levels(p= 0.933) after 8 weeks.

Conclusion

Pregnant women has an option to choose either 200mg ferrous fumarate daily or 400mg ferrous fumarate weekly for their anemic treatment.

Keywords: pregnancy, iron supplement, anemia

OP-057

Postpartum Depression and Mood Assessment of Mothers and Babies

Bilge Sönmez¹, Burcu Kayhan Tetik², Engin Burak Selçuk², Melek Kılıç³, Feyza Bezirgan Sarıgözel⁴, Ismail Hamdi Kara⁴, Ergün Öksüz⁵, Mustafa Agah Tekindal⁶, Mehmet Akif Terli⁷, Makbule Öztürk⁸

¹Çerkeş State Hospital Family Medicine, Çankırı, Turkey

²Inonu University Department of Family Medicine, Department of family medicine, Malatya, Turkey

³Republic Of Turkey Ministry Of Health-Child Adolescent Health Department, Ankara, Turkey

⁴Düzce University Department of Family Medicine, Department of family medicine, Düzce, Turkey

⁵Başkent University Department of Family Medicine, Department of family medicine, Ankara, Turkey

⁶Başkent University, Faculty Of Medicine, Department Of Biostatistics, Ankara, Turkey

⁷Kahramanmaraş province health Directorate Child Adolescent Health Department, Kahramanmaraş, Turkey

⁸Antalya province health Directorate Child Adolescent Health Department, Antalya, Turkey

Introduction and AIM:

Non-compliant interaction with baby can prevent the achievement of maternal role. The postpartum period is considered with increased risk for various mood disorders and women are the most vulnerable emotionally in this period. Mood disorders seen during this period affects not only mother and baby but also the rest of family with serious long-term consequences and it may take a life-time without treatment. In our study, we aimed to determine postpartum depression frequency in Turkey.

MATERIAL-METHOD:

Our study is cross-sectional descriptive; in Turkey's 10 provinces (Diyarbakir, Malatya, Ankara, Cankiri, Ordu, Samsun, Kahramanmaraş, Sanliurfa, Istanbul and Antalya) 3000 mothers in total within the first postpartum year will be held, study is completed in Cankiri, Istanbul and Antalya and preliminary study results are presented. Sociodemographic questionnaire, Edinburgh Depression Scale(EDS) and Maternal Attachment Scale(MAS) was administered. All data was evaluated in SPSS (Version 17, Chicago, IL, USA). Statistical significance was accepted as $\alpha = 0.05$.

RESULTS:

In our study there was a total of 256 mothers including 74 from Cankiri, 44 from Antalya and 138 from Kahramanmaraş. The mean age of participants is 27.43 ± 4.8 , 36% were primary, 29% high school and 29% were university graduates. 61% of mothers were housewives, 21% of civil servants, 8% of mothers were working in private sector. In 21% of mothers' the monthly income was below 1000 ₺, 32% has 1000-2000 ₺ and 12% has 4000 ₺ and over. 21,5% of mothers' EDS score was 12 and over. Average MAS score was found 99,4(SD:7,505).

CONCLUSION:

Identifying emotional problems in postpartum period early and providing necessary assistance and support should be considered in commission and scope of authority of family physician as the leader of patients' all health situations.

Keywords: postpartum, depression, maternal attachment

OP-058

Following up pregnancies in primary care; Are we adequate?

Ipek Tanyıldızı

Abdulkadir Konukoğlu Aile Sağlığı Merkezi, Gaziantep, Turkey

BACKGROUND: Following up pregnancy is the most important part of family medicine. Women can be prevented from complications of pregnancy by regular follow up and true manipulation. The aim of this study is to evaluate risk factors of pregnancy in primary care.

METHOD: Pregnant women who applied to our family medicine unit, between September 2012 and December 2014 and accepted informed consent, involved to the study. Their files were examined retrospectively. Risk factors according to pregnancy and effects of these risks after birth were determined.

RESULTS: 161 pregnant women were followed until their birth. 19.3% of pregnant women were more than 35 years, 28.6% of them were overweight and 49% had risk factors for pregnancy (Consanguinity(18%), thyroid diseases(11%) and Rh incompatibility(10%)). The mean hemoglobin value was 12.1g/dl at the beginning and 11.4 g/dl at the last visit. Mean value of 50-gram glucose challenge test (GCT) was 121.6 mg/dl. Birth average was 35 week (median=38 week). 88.8% of them were live birth and 11.2% were stillbirth or abortion and most of them concluded as cesarean delivery (58.4%). Pregnants whom ≥ 35 years old had significantly increased body mass index ($p=0.043$), systolic blood pressure ($p=0.028$). Also abortion or stillbirth, low birth week ($p=0.001$) and cesarean delivery ($p=0.02$) had mostly seen in these women. When serum glucose in GCT was more than 140 mg/dl, risk of prematurity ($p=0.034$) and postnatal morbidity were also increased ($p=0.049$).

CONCLUSION: Nowadays older age pregnancies and age related risks are increasing, so that complications of birth can be seen both in mother and baby. This can be avoided by regular following up pregnancies in primary care.

Keywords: primary care, pregnancy risks, preventive care.

Risk factors of pregnancy

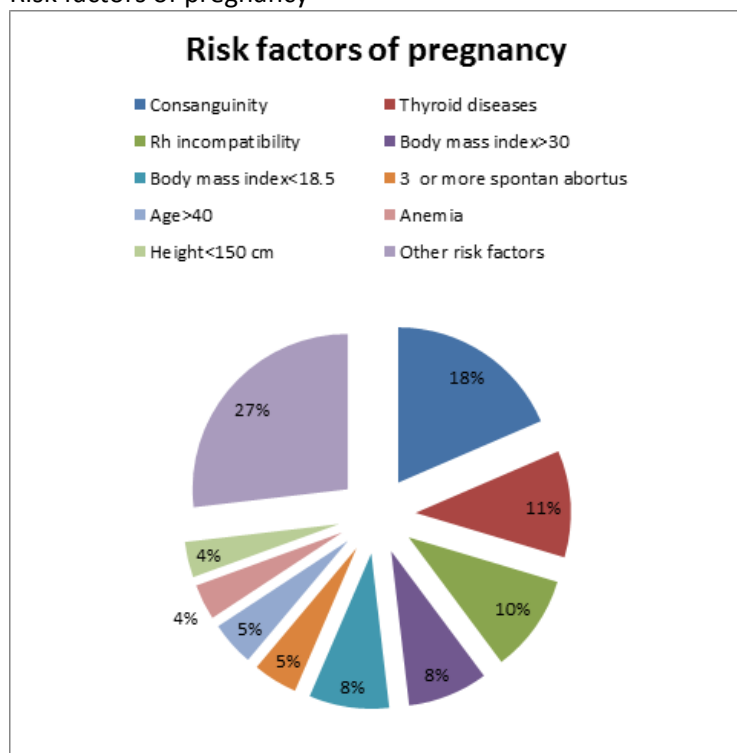


Table1: Body mass index (BMI) according to age of pregnant women

Age of pregnant women (n=161)	BMI			
	Underweight	Normal weight	Over weight	Obesity
17-34 years old n(%)	10 (7.7)	78 (60.0)	36 (27.7)	6 (4.6)
≥35 years old n(%)	0 (0.0)	16 (51.6)	10 (32.3)	5 (16.1)
Total n(%)	10 (6.2)	94 (58.4)	46 (28.6)	11 (12.2)

(BMI<18.5 underweight, BMI=18.5-24.9 normal weight, BMI=25-29.9 overweight, BMI>30 Obesity) (p=0.043)

Table 2: Systolic blood pressure according to age of pregnant women

Age of pregnant women (n=145)	Systolic blood pressure	
	<140 mm Hg	≥140 mm Hg
17-34 years old n(%)	120 (100.0)	0 (0.0)
≥35 years old n(%)	24 (96.0)	1 (4.0)
Total n(%)	144 (99.3)	1 (0.7)

(p=0.028)

Table 3: Birth week of pregnancy according to age of pregnant women

Age of pregnant women (n=161)	Birth week of pregnancy		
	<20 week	20-36 week	37-42 week
17-34 years old n(%)	11 (8.5)	7 (5.4)	112 (86.2)
≥35 years old n(%)	5 (16.1)	8 (25.8)	18 (58.1)
Total n(%)	16 (9.9)	15 (9.3)	130 (80.7)

(p=0.001)

Table 4: The way of delivery according to age of pregnant women

Age of pregnant women (n=161)	The way of delivery		
	Normal spontaneous delivery	Cesarean delivery	Abortion or stillbirth
17-34 years old n(%)	44 (33.8)	75 (57.7)	11 (8.5)
≥35 years old n(%)	5 (16.1)	19 (61.3)	7 (22.6)
Total n(%)	49 (30.4)	94 (58.4)	18 (11.2)

($p=0.029$)

Table 5: Birth week of pregnancy according to 50-gram glucose challenge test (GCT)

50-gram glucose challenge test (n=133)	Birth week of pregnancy	
	20-36 week	≥ 37 week
<140 mg/dl n (%)	7 (6.5)	101 (93.5)
≥140 mg/dl n (%)	5 (20.0)	20 (80.0)
Total n (%)	12 (9.0)	121 (91.0)

($p=0.034$)

Table 6: Postnatal morbidity according to 50-gram glucose challenge test (GCT)

50-gram glucose challenge test (n=133)	Postnatal morbidity	
	No problems	Existence of problems
<140 mg/dl n (%)	102 (94.2)	6 (5.6)
≥140 mg/dl n (%)	22 (88.0)	3 (12.0)
Total n (%)	124 (93.2)	9 (6.8)

($p=0.049$)

OP-059

Does unplanned home birth affect use and context of prenatal and postnatal care services

Binali Çatak¹, Can Öner²

¹Kafkas University School of Medicine

²Istanbul Bilim University School of Medicine

And adequate prenatal (PNC) and postnatal (PoNC) care services decrease infant and maternal mortality. Not only the quantitative features but also the qualitative features of these services are important and can be change according to social factors. In this study, it was aimed to evaluate these services given by family physicians at primary care level and by obstetricians at secondary and tertiary care levels in Istanbul in terms of quantity and quality in home delivery and hospital delivery groups.

The data of this study was derived from part of prenatal and postpartum care of an other case control study namely " Unplanned home birth and affecting factors". The "case" group consisted of 229 women who had "unplanned home deliveries" and "control" group (n=458) of women giving birth in hospitals.

15,6 % (n=27) of case and 3,4% (n=13) of control group do not receive any PNC, where as 4,0% (n=7) of case and 2,1% (n=8) of control group receive PNC only from family physician. Most of the women in both groups receive PNC form family physician and obstetrician (46,2% (n=80) vs 61,9% (n=239) respectively) (p=0,001).

39,9 % (n=69) of case group and 38,7% (n=149) of control group do not receive any PoNC, where as 50,9% (n=88) of case group and 35,3% (n=136) receive PoNC from family physician. The rate of PoNC receive from obstetrician was 9,2% (n=16) in case and 26% (n=100) in control groups (p=0,001).

When the PNC assessed quantitatively and qualitatively all parameters showed significantly difference between the case and control groups except cardiac auscultation. On the other hand receiving PoNC parameters only abdominal examination and bleeding control showed significant difference between two groups.

It was shown that the context of PNC and PoNC was show significant difference according to place of delivery.

Keywords: prenatal care, postnatal care, home birth

OP-060

An Evaluation of knowledge of Health Care Personnel, working in Primary Healthcare facilities, about Breastfeeding and Lactation Consultancy

Engin Burak Selcuk¹, Burcu Kayhan Tetik¹, Melek Kılıç², Bilge Sönmez³, İrep Karataş Eray⁴, Makbule Öztürk⁵, Mehmet Akif Terli⁶

¹Department of Family Medicine, Inonu University, Malatya, Turkey

²Department of Child Health, Republic of Turkey Ministry of Health, Ankara, Turkey

³Çankırı State Hospital, Çankırı, Turkey

⁴Ankara Atatürk Research and Training Hospital, Ankara, Turkey

⁵Department of Child Health, Antalya Public Health Directorate, Antalya, Turkey

⁶Department of Child Health, Kahramanmaraş Public Health Directorate, Kahramanmaraş, Turkey

WHO and UNICEF recommend breast-feeding babies exclusively for the first six months and continuing breast-feeding with adequate complementary food for up to two years of age. Training of breastfeeding, beginning especially after the 32th week of pregnancy, has been proven to increase the duration of breastfeeding, in many studies.

The aim of our study is to define the level of knowledge, attitudes and behavior of the healthcare personnel working in primary care facilities, about breastfeeding, in 10 cities of Turkey (Diyarbakır, Malatya, Ankara, Çankırı, Ordu, Samsun, Kahramanmaraş, Şanlıurfa, İstanbul ve Antalya). Our study is planned to be carried out with a total of 3000 healthcare personnel. In the current report preliminary study results of Diyarbakır, İstanbul and Antalya are presented.

MATERIALS-METHODS:

In the analysis of the data SPSS, Chicago, IL, Version 17 program was used. A value of p<0,05 accepted as significant.

RESULTS:

Some socio-demographic data of the participants are presented in Table 1.

The question "Which of the following is suggested for healthy generations?" is answered correctly as "the first 6 months of exclusive breastfeeding, continue breastfeeding with additional food up to 2 years" by a total of 394 (87.8%) participants, including 142 (87.7%) in Diyarbakir, 156 (82.5%) in Kahramanmaraş, and 96 (98.0%) in Antalya.

The answers to the question "What additional food would you recommend, if the mother's milk is insufficient" are given in Table 2.

CONCLUSION: Family physicians and healthcare personnel who provide continuous care should consider every application as an opportunity. We believe the family physicians may further improve the ratio of breastfed babies by providing the mother candidates in their population with breastfeeding training and information about problems that might be experienced possibly and how to deal with them through scheduled training sessions.

Keywords: Breastfeeding, Education, Health Care Personnel

Table 1:

CITIES	Age	Woman	Man	Family Physician	Midwife/ Nurse
Diyarbakır	33.8 ± 8.6	114 71.7%	45 28.3%	53 33.1%	107 66.9%
K.Maraş	35.2 ± 7.8	138 73.0%	51 27.0%	56 29.6%	133 70.4%
Antalya	40.9 ± 7.3	79 80.6%	19 19.4%	42 42.9%	56 57.1%
Total	36.02± 8.4	331 74.3%	115 25.7%	42 12.4%	296 87.6%

Socio-demographic data of the participants

Table2

CITIES	Water	Formula	Fruit juice/ syrup	Cow milk	Other	Total
Diyarbakır	3 1.9%	144 91.7%	1 0.6%	4 2.5%	5 3.3%	157 100.0%
K.Maraş	1 0.5%	174 92.2%	1 0.5%	8 4.2%	5 2.6%	189 100.0%
Antalya	0 0.0%	95 96.9%	1 1.0%	0 0.0%	2 2.1%	98 100.0%
Total	4 0.9%	413 93.1%	3 0.7%	12 2.7%	12 2.7%	444 100.0%

Foods recommended by health-care personel if breast milk is insufficient

OP-061

“Steps for Health”- interdisciplinary team physician- pre-school educator- parent

Laura T Comnea¹, Eugenia A Iorgulescu²

¹Private Practice Dr Comnea Laura

²MiniClub Condor Iorgulescu Eugenia

Background

The first admission of a small child in the community(nursery, kindergarten), induce concerns for parents, challenges for pre-schol educator, for doctor who take care of that collectivity. Regarding the baby: often, the child feels stress induced by the separation from his parents, contact with other children, rules. From studies and literature dedicated to the subject, they are large limits regarding optimal moment for entering the community of a small-child: 6 months (socially involved mothers) to 4 years.

Purpose

To present the impact of early collectivity over the neuro-psycho-motor development of the child

OBJECTIVES:

1. Neuro-psycho-motor development from 1 to 3 year of age
2. Impact of the early community admittance on the child's health
3. Interdisciplinary team training for optimal child care

Material and method

The authors present a retrospective observational study developed between 2011-2013.They folowed and compare three groups of 12 children(totally 36 children)

There were recorded:

- physical parameters- weight, height, cranial perimeter, dentition,
- neuro-psycho-motor development: walk, sight, hearing, speaking, behavior
- pathological,
- intervention methods in managing child reactions when he is separate from the parent
- the role of the informed consent of parents on first aid cases, parents counseling for immunisations, nutrition,
- daily physical exercises
- changes in the children's behavior.

The children were examined by the doctor weekly

All staff went through special training in:basic child care, first aid, elementary psychology of toddlers. Parents were involved in joint activities with their children

Conclusions

- 1.Small collectivities are ideal model to maintain an optimal health for children
2. As the child is younger when he enter in the community, the neuro-psycho-motor development are faster and the acquisitions more complex
- 3.The interdisciplinary team doctor- pre-schol educator-parent remain a solution, in order to obtain good results in raising and educating healthy young child.

Keywords: small child health (1-3 years), toddlers, interdisciplinary team, community

OP-062

Should I Supplement Vitamin D During Pregnancy? Frequency Of Vitamin D Supplementation Intake Among Pregnant Women in Ankara and The Related Affecting Factors: A Survey Study

Zeynep Sayın Dincer¹, Gökhan Dincer², Aybüke Demir Alsancak¹, Duygu Ayhan Başer¹, Zeynep Keskin¹, Aysu Duyan Çamurdan³

¹Department of Family Medicine, Ankara Numune Training and Research Hospital, Ankara, Turkey

²Department of Family Medicine, Ankara Training and Research Hospital, Ankara, Turkey

³Department of Social Pediatrics, Gazi University, School of Medicine, Ankara, Turkey

BACKGROUND AND AIM: In term of its effect on maternal and infant health, vitamin d deficiency is stil an important public health problem. The republic of Turkey ministry of health published a circular to improve maternal and infant health by preventing perinatal/maternal vitamin d deficiency. And it was suggested that all pregnant and lactating women be supplemented vitamin d per a day 1200U.

The aim of this study were to determine usage of rates vitamin d supplement among pregnant women living in city of Ankara and to examine the factors associated with this condition.

METHOD: The data of descriptive research were collected by a questionnaire form. A questionnaire was administered to all postpartum (in first mounth) women attending to well baby clinic in February- july 2015. The questionnaire form included open-ended and closed questions regarding the descriptive characteristics and about to intake of vitamin d during pregnancy. The questionnaire form was completed by individually.

RESULTS: Present we report the preliminary results but all results will be presented in 20th wonca conference. The mean age of the study population were 29,63(±5,395) years. The use of vitamin supplementation in pregnancy was 46,7%. And only 41.1% of these mothers had been proposed enough dose vitamin d (1200U). In the study, it was found the following as reasons for not taking vitamin D supplements: the lack of doctor's recommendation, to write harmful for pregnant women in medicine prospectus and to be at normal levels of vitamin D levels.

CONCLUSION: There many different opinions on about use of vitamin d supplement in pregnancy and that is one of the most important reasons influencing prenatal vitamin d intake. Future studies need to be conducted with larger samples before the findings can be accepted with a greater degree of confidence.

Keywords: Vitamin D, Pregnancy, Supplements,

OP-063

An qualitative evaluation of the prenatal in Brazil

Lara Louise Guimaraes Silveira, Rickella Aparecida Alves Moreira, Izabela Maciel Saraiva, Leila Medeiros Melo Faculdade de Medicina, Universidade Federal de Goiás, Goiás, Brasil

Background & Aim

Pregnancy, in most cases, has its evolution uneventful but requires special care. Objective prenatal counsel women from the beginning of pregnancy, seeking to ensure, at its end, the birth of a healthy child and ensure the maternal and neonatal well-being. The objective of this study is to evaluate the perception of mothers as prenatal care received, showing the greater significance factors among pregnant women and service.

Method

We conducted a qualitative analysis of the" whys" of anxiety and stress that permeate the pregnancy and postpartum in the PSF São Judas Tadeu Goiânia - GO, Brazil. This study was conducted through intensive direct observation by means of a semi structured interview.

Results

We observed the tendency of mothers to assess the care received based on the number of made appointments and tests. This fact hides possible failures in care, such as little humanization and the lack of additional information to pregnant women, which should be improved. For this humanization both pregnant and postpartum women as professionals need

to work with confidence, comprising not only the objective aspects of care. It is valid to point out that the lack of trust in professionals was one of the main complaints of the mothers.

Conclusions

We note that it is extremely important the humanization and payment of services rendered to pregnant and postpartum women. The improvement of care reduces anxiety, reflecting the health of the mother and her baby. The patient should be monitored holistically, attending to their physical and psycho-social conditions.

An intensification in the discussions between all professionals that work in different units is necessary and the mothers who attend there, raising the negative and positive points found by each in order to promote a payment of several problems, seeking in this way a solution more viable and effective.

Keywords: Prenatal, Pregnancy, qualitative evaluation

OP-064

how pregnancy effects women's biopsychosocial health?

Ferhat Ekinci¹, Bilge Turgut², Naciye Irmak², Doğukan Ali Angın⁴, Tevfik Yoldemir³, Arzu Uzuner²

¹Department of Public Health Directory, Van

²Department of Family Medicine, Marmara University, Istanbul, Turkey

³Department of Obstetric and Gynecology, Marmara University, Istanbul, Turkey

⁴Department of Obstetrics and Gynecology, Bigadiç Community Hospital, Balıkesir

AIM: Pregnancy is an important event for women. In our study we tried to determine biopsychosocial approach in pregnant women.

METHOD: The patients who applied to the Marmara University Department of Obstetric and Gynecology outpatients clinics were recruited in this study. During the interview participants have been asked to fill Beck depression scale, Hamilton anxiety scale, Los Angeles Loneliness scale and Multidimensional Scale of Perceived Social Support- MSPSS.

RESULTS: Two hundred fifty participants were full filled the scales. Of them mean age were 28,2±4,8. The mean of marriage year is 5,9 (1-22). Pregnancy week average was 31,4±4,8. Of them 84,8% were not working and 10,8 % were smoking. Of them 35,6% were the first pregnancy. According to Beck scale 12% of them have high risk for depression and referred to psychiatry clinics. Hamilton anxiety scale score high for 57,6% participants. The loneliness scale scores were increased with increasing Beck and Hamilton scale scores ($r:0,350 - p<0,001$; $r:0,173 - p<0,006$). Living with husbands family have significantly higher anxiety scores then living just with husbands. With increasing pregnancy week; there is no correlation with loneliness and social support scale scores ($p>0,05$).

DISCUSSION: Pregnancy is a life event which mostly ended with a newborn family member. Pregnancy is a special period for every women. High anxiety scores were detected in pregnancy. Not only in obstetric clinics but also in every clinics pregnant women should examine according to biopsychosocial approach.

Keywords: pregnancy, biopsychosocial approach, women health

OP-065

The effects of a structured education module on exclusive breastfeeding

Naciye Irmak, Arzu Uzuner, Burcu Başaran, Merve Telliöđlu, Sevim Aksoy, Serap Çifçili
Marmara univercity family medicine department, Istanbul, Turkey

BACKGROUND: “Exclusive Breastfeeding” (EBF) means that the infant receives only breastmilk during the first 6 months of life and is supported by the WHO

AIM: The purpose of this study, was to determine the effects of an antenatal and postnatal breastfeeding education module on EBF duration.

MATERIAL-METHODS: The participants of the study were pregnant women registered to a total of four family health centers selected based on their geographical accessibility. Pregnant women of one center formed the control group while others formed the intervention one. All of them were certified as “Baby Friendly” by the “Initiative” of Turkish Ministry of Health. The education module has been run in the university hospital Family Medicine department. Phone calls have been made on the second week after delivery to learn if any nipple problem had occurred. The mothers of the intervention group have been randomized into two groups to determine one group for reminder call and the other for routine follow up. All the participants including control group were called at the end of the postpartum 6th month to determine the rates of EBF.

RESULTS: A total of 132 mothers, 82 in intervention group and 50 in the control group were included in study. Statistically significant increase in the rates of EBF at the end of 6 months showed the effectiveness of the education module (%42,9 vs, %22,2, $p=0,001$). Early weaning rates were higher in the control group. ($18,5\pm 8,5$ vs, $15\pm 9,5$ week, $p=0,03$). The main reason of early weaning that reported by the mothers was “the insufficiency of the mother’s milk”. EBF were significantly associated with higher family income, previous positive breastfeeding experience, planned pregnancy, earlier discharge after delivery and high education level of the father. Bottlefeeding was the only independent factor that affected breastfeeding negatively. Fourth month recalls did not changed EBF rates.

CONCLUSION: Antenatal breastfeeding group educations can be an effective method to facilitate rather work in primary care.

Keywords: breastfeeding, exclusive breastfeeding, breastfeeding education

OP-066

Postpartum smoking behaviors and associated factors of mothers with 6-18 months old children

Sabire Ilke Ekim Yardım, Gamze Akyol, Tuğba Onat, Candan Kendir Çopurlar, Tolga Günvar, Dilek Güldal
Department of Family Medicine, Dokuz Eylül University, Izmir, Turkey

BACKGROUND&AIM

Smoking is still one of the biggest public health problems worldwide. Pregnancy is an important opportunity for quitting smoking. But smoking cessation during pregnancy has been recognized as a 'suspended' behavior because of the high postpartum relapse rates. The aim of our study is to investigate factors affecting smoking behaviors of women who have children 6-18 months age.

METHOD

Participants were mothers of children 6-18 months of age admitted to Dokuz Eylül University Pediatric Clinics. A questionnaire composed of demographic data and two scales of "self-efficacy" and "health locus of control". There were 288 participants. Data were analyzed by SPSS.15.

RESULTS

The mean age of participants was 30.28 ± 4.89 years. 157 participants smoke at least 1 cigarette during their lives and their husbands also more likely to smoke ($p=0.012$). 68.5% of the mothers whose husbands were smoking also were smoking before their pregnancy ($p=0.001$)

Among the 130 mothers who were smoking before their pregnancies 94 of them (72.3%) quit smoking as a result of their pregnancy. The main reason to quit smoking is the concerns about baby's health. After the birth of the child, eventually 56 of them (59.6%) started to smoke again. The main reason to start smoking is stress either about baby or life issues. Babies of the participants who returned smoking is significantly older than the babies of mothers who did not start smoking again ($p=0.011$).

Although educational status seemed to be an important factor to decide stop smoking during pregnancy ($p=0.001$) it is not related with the relapse of smoking.

Smoking behavior showed no association with self – efficacy and health locus of control scales.

CONCLUSION

Stress is an important factor for smoking relapse in mothers who quit during their pregnancies. Mothers tend to return smoking behavior as their babies grow.

Keywords: postpartum smoking, women, smoking behavior, smoking relapse,

Parental Beliefs and Practices Regarding Childhood Fever in Turkish Primary Care: A Multicenter Study

Erdoğan Yavuz¹, Erol Yayla², Saide Eda Cebeci³, Emrah Kırımlı⁴, Raziye Şule Gümüştakım⁵, Lütfullah Çakır⁶, Selami Doğan⁷

¹1st Family Healthcare Center, Rize

²5th Family Healthcare Center, Afyon

³Serdivan Family Healthcare Center, Sakarya

⁴Beykoz 5th Family Healthcare Center, İstanbul

⁵Sarıselviler Family Healthcare Center, Karaman

⁶Yenimahalle Family Healthcare Center, Ordu

⁷Bayraklı 4th Family Healthcare Center, İzmir

BACKGROUND: Fever is a very common problem in pediatric age and one of the most common reasons parents seek medical attention. However, in most of these visits nothing harmful is diagnosed. The literature indicates that parents demonstrated substantial fear of consequent body damage from fever if left untreated. We aimed to investigate beliefs, habits and concerns of Turkish parents regarding their children's fever.

METHODS: We performed a cross-sectional survey which was conducted as interviews in person by family physicians from April 2014 through June 2014 in family healthcare centers in nine different cities of Turkey. Parents with a child with fever aged between 0-14 years consecutively were interviewed by use of a questionnaire which consisted of 33 questions. The participants were asked questions about socio-demographic data, antipyretics and other interventions used to reduce fever before presenting to primary care center. Parental beliefs and practices concerning fever were also inquired.

RESULTS: A total of 205 parents participated in this study. During medical examination, forty-seven children (23%) had $>38^{\circ}\text{C}$ fever. Ninety-four parents (45.8%) measured fever with a thermometer prior to presentation. Only thirty-six parents (38%) used the thermometer correctly. Thirty-eight parents (18.5%) knew the correct temperature definition of fever for the measured site. A mercury-in-glass thermometer was the choice for most parents (78%) and preferred site was axillary region (85%). The fever was treated prior to arrival by 171 parents (83.4%). Paracetamol was the most frequently used antipyretic. Fifty-four parents (31.5%) failed to administer the correct antipyretic dose and seventy-three parents (42.6%) failed to give the antipyretics at proper intervals. One hundred and fifty-three parents (67%) believed that if not treated fever could cause convulsions.

CONCLUSION: We conclude that Turkish parents should be adequately educated regarding their conceptions and practices of their children's fever.

Keywords: Childhood Fever Turkish Primary Care

Table 1: Antipyretics used prior to admission to primary care center

paracetamol	84 (41%)
ibuprofen	73 (35.6%)
did not use any antipyretics	34 (16.5%)
paracetamol+ ibuprofen	12 (5.8%)
metamizole	2 (1%)

Antipyretics Frequency: n (Percent:%)

Table 2: Interventions to cure fever other than drugs

No methods other than antipyretics	69 (24.6%)
------------------------------------	------------

Wet towel	64 (22.8%)
Bathing with warm water	51 (18.2%)
Undressing	40 (14.2%)
Undressing + wet Towel	23 (8.2%)
Rubbing with vinegar	11 (3.9%)
Bathing with warm water + wet towel	9 (3.2%)
Rubbing with cold towel	5 (1.7%)
Bathing with cold water	3 (1%)
Others	5 (1.7%)

Interventions To Cure Fever Other Than Drugs Frequency: n (percent:%)

Table 3. Diagnoses of the children

Upper respiratory tract infection	60 (27.5%)
Non-specific (Possibly viral)	45 (20.6%)
Acute tonsillitis	38 (17.4%)
Acute sinusitis	16 (7.3%)
Acute otitis	14 (6.4%)
Acute bronchitis	13 (6%)
Acute gastroenteritis	9 (4.1%)
Normal examination	9 (4.1%)
Acute cryptic tonsillitis	9 (4.1%)
Urinary tract infection	5 (2.3%)

Diagnosis Frequency: n (Percent:%)

Table 4: Parents' beliefs and concerns regarding their children's fever.

158 (77%)	25 (12%)	22 (11%)
94 (46%)	51(25%)	60 (29%)
6 (3%)	178 (87%)	21 (10%)

Parent Knowledge About Fever No: n (%) Yes: n (%) I have no idea: n (%) Does treating fever mean curing the disease?No: n (%) Yes: n (%) I have no idea: n (%) Does fever have any good outcome?No: n (%) Yes: n (%) I have no idea: n (%) Does fever have any bad outcome?No: n (%) Yes: n (%) I have no idea: n (%)

Table 5: What worst would happen if fever is not treated?

Convulsions	153 (67%)
Meningitis	20 (9%)
Paralysis	18 (8.1%)
Meningitis + Convulsions	10 (4.5%)
I have no idea	7 (3.1%)
Meningitis + Paralysis	7 (3.1%)
Others	7 (3.1%)

What worst would happen if fever is not treated? Frequency (n) Percent (%)

OP-068

Frequency of Asthma and Atopy in Patients with Inflammatory Disease Compared to Celiac Disease

Fatma Yavuzylmaz¹, Şebnem Özdoğan², Nafiye Urgancı³, Ayşe Merve Usta³

¹Sisli Hamidiye Etfal Research and Training Hospital, Department of Pediatrics, Istanbul, Turkey

²Sisli Hamidiye Etfal Research and Training Hospital, Pediatric Pulmonary, Istanbul, Turkey

³Sisli Hamidiye Etfal Research and Training Hospital, Pediatric Gastroenterology, Istanbul, Turkey

OBJECTIVE: Increased incidence of atopy and asthma has been reported in autoimmune disease such as celiac diseases and inflammatory bowel disease (IBD). In this study we aimed to investigate the frequency of asthma and allergic disease in IBD compared to celiac disease.

MATERIAL-METHODS: The validated isaac questionnaire in Turkish was obtained from patients with celiac disease and IBD.

RESULTS: A total of 73 patients (20 with IBD and 53 with celiac disease) were involved. 52 % of patients were female and the mean age was 12.7±3.4 years. The prevalence of wheeze was 16 % at any time (15 % in IBD and 17 % in celiac disease), and 14 % for the last 12 months (10% IBD, 17 % celiac disease). The prevalence of allergic rhinitis was 35% at any time (40% in IBD and 30.2 % in celiac disease).

CONCLUSION: The frequency of asthma and allergic disease were similar in both children with IBD and celiac disease. Assessment in large number of patients is ongoing to determine the prevalence of asthma and allergic disease in patients with IBD compared to celiac disease.

Keywords: Asthma, Atopy, Inflammatory Bowel Disease, Celiac Disease

OP-069

A Study From İstanbul: Hydrocele Prevalence Rate in Term Newborns

Berrin Telatar¹, Yasemin Akın², Serdar Cömert³, Nilgün Güdücü⁴, Fatih Tarhan⁵, Kerem Özel⁶

¹İstanbul Bilim University, Medicine School, Family Medicine Department, İstanbul, Turkey

²Dr.Lütfi Kırdar Kartal Education and Training Hospital, Child Health and Diseases Clinic, İstanbul, Turkey

³Süleymaniye Obstetrics and Child Diseases Education and Training Hospital, Neonatology, İstanbul, Turkey

⁴İstanbul Bilim University, Medicine School, Gynecology and Obstetrics Department, İstanbul, Turkey

⁵Dr.Lütfi Kırdar Kartal Education and Training Hospital, Urology Clinic, İstanbul, Turkey

⁶İstanbul Bilim University, Medicine School, Pediatric Surgery Department, İstanbul, Turkey

Introduction and AIM: A hydrocele is an accumulation of fluid in the tunica vaginalis. One to 2 % of male neonates have a hydrocele. This study is planned to find incidence rate of hydrocele in term neonates.

MATERIAL-METHOD: This cross-sectional study was conducted with 3422 term male newborns in a Training and Research Hospital between 2001-2005 years. Urogenital examination of the babies was held by a physician experienced in this regard within the first 24 hours. Suspected cases were confirmed by ultrasonographic examination. Hydrocele cases were reevaluated one week later. Ongoing cases of hydrocele were sent to urology polyclinic. Follow-up of cases was carried out by this clinic or pediatric surgery.

RESULTS: 275 from 3422 newborn babies (8.0%) was found hydrocele. 181 of 275 patients diagnosed with bilateral hydrocele (65.8 %), 65 on the right (23.6 %) and 29 on the left (10.5%) hydrocele were detected. In 2001 incidence rate of hydrocele was 7.58 %, in 2002 it was 15.6 %, in 2003, 2004, 2005 it was calculated as 6.66 %, 7.29 %, 2.51 % respectively. Additional urogenital anomalies were detected in 13 patients (4.72 %). Only 3 patients had bilateral (23%) and 10 patients (77%) had one-sided hydrocele. Overall, 4 patients (30.7 %) had hypospadias, 9 (69.2%) had undescended testis. With one-sided hydrocele patients to be seen by the opposite side of the unilateral undescended testis cases was an interesting finding. Six of nine hydrocele cases had left undescended testis in opposite side and hypospadias in three.

CONCLUSIONS: Neonatal hydrocele cases were found higher frequency than expected. The majority of babies had bilateral hydrocele. Obliteration occurred more frequently on the right than on the left.

Keywords: Testicular hydrocele, Newborn, Prevalence

OP-070

Vitamin D deficiency was common in all patients at a Swedish primary care centre, but more so in patients born outside of Sweden

Sahar Sami Ayoob¹, Lennart Mossberg¹, Anna Nixon Andreasson²

¹Fornhojden health care center, Sodertalje- Sweden

²Division for Family Medicine, Karolinska Institutet, Huddinge, Sweden

BACKGROUND: The importance of vitamin D for different processes has been highlighted in the last decade after the discovery of the extra-skeletal vitamin D-receptor. Vitamin D deficiency might be a contributing cause for the increased risk for certain chronic diseases such as diabetes, cardiovascular disease, psychological diseases, immune dysfunction and increased risk for colorectal-, prostate-, and lung cancer. Due to differences in skin tones, types of food consumed and clothing, patients with a foreign background may have a higher risk of vitamin D deficiency.

AIM: To measure vitamin D levels in an unselected primary care population at a primary care center with a high proportion of patients who are born outside Sweden and to investigate the prevalence of vitamin D deficiency in patients at the primary care center and if the vitamin D levels differ between patients born in Sweden and patients born outside Sweden.

METHODS: Vitamin D levels were assessed in all patients aged 20 to 65 years visiting the primary care center, independent of cause of visit, for two weeks in January 2014. The difference between patients born in Sweden and patients born outside Sweden were calculated using logistic regression adjusting for gender and age.

RESULTS: Patients born outside Sweden had a statistically significant lower levels of vitamin D (mean 30nmol/L; SD16.8) than patients born in Sweden (mean 43nmol/L; SD 12.9SD, $p < 0,001$). Vitamin D deficiency was more common in patients born outside Sweden than in patients born in Sweden (63% vs 17%, $p < 0,001$).

CONCLUSION: Vitamin D deficiency was more common in patients born outside Sweden than patients born in Sweden. However, vitamin D deficiency and insufficient vitamin D-levels were common at the primary care center overall. Future studies are needed to investigate if the differences in vitamin D levels between patients born in Sweden and patients born outside Sweden are exacerbated during the summer.

Keywords: S-25(OH)D, utländskbakgrund, D-vitaminbrist, vitamin D-receptorn (VDR).

OP-071

Migraine headache among primary school children in a big city

Fatih Çiftçi, Hakan Demirci, Beyza Demirbaş, Ali Candar, Mehtap Gömleksiz

Department of Family Medicine, Sevket Yilmaz Training and Research Hospital, Bursa, Turkey

Background

Students living at the city center routinely have high degree of stress which is associated with migraine. We aimed to compare the frequencies of migraine in rural and urban part of the city.

Methods

This is cross-sectional, questionnaire-based study. Participants who had two or more headaches in the last 3 months were subjected to two preliminary questions and participants with at least one positive response were asked to perform the validated Identification of Migraine (ID Migraine™) test.

Results

A total of 418 primary school students were participated in the study. Migraine headache was suggested in 9.4% of students living at city center versus 4.6% of students living at rural area ($p < 0.000$). There were six students with migraine out of 19 students complaining from headache in rural area and there were 27 students with migraine out of 50 students suffering from headache in urban area.

Conclusion

The frequency of migraine is higher among students in urban area compared to rural area. Parents should be aware of the negative effects of living in city center on their children.

Keywords: Migraine; Prevalence; Primary school students; Rural; Urban

OP-072

Investigating blood hypertension in children and adolescents of a remote area

Constantinos Mihas¹, Maria Rifouna², Eleni Petropoulou², Panagiotis Andriopoulos², Andreas Katrapas¹, Aikaterini Mpahara¹, Anargiros Mariolis²

¹General Hospital-Health Centre of Kimi, Evia, Greece

²Health Centre of Areopolis, Mani, Greece

Background & AIM: It is internationally recognized that the prevalence of hypertension in younger people is higher than initially thought. In addition, it seems that it is a mark of early onset of adult hypertension. The aim of this study was to investigate this phenomenon in children and adolescents in a rural and remote area in a Mediterranean country

METHOD: The sample of our study consisted of 88 children (42 boys, 46 girls), age 8-18 years old who visited the Primary Health Care unit of Areopolis, Mani, Greece, a remote and rural area, in order to undergo a physical examination for health certificate that would be used for school purposes. All children participated to the study after the parents signed an agreement. Three blood pressure measurements were carried out; the mean values were recorded. The NHANES criteria were used for classification of hypertension (>95th percentile), adjusting for age and sex.

RESULTS: Eleven children (12.5%) were hypertensive, similarly distributed across three age categories (8-11, 12-15, 16-18). The prevalence of hypertension did not differ significantly between genders. (Boys: 9.52%, Girls: 15.22%, $p=0.420$), while it was significantly correlated with increased body weight (Prevalence in normal: 5.17%, prevalence in obese/overweight: 26.67%, $p=0.004$)

CONCLUSIONS: Although the sample of the study is not large enough, the primary results are alarming regarding the health status of children and adolescents in a rural area. The early recognition of the problem and the help of parents and the family physician might lead to lifestyle change and therefore, successful treatment of this concerning phenomenon.

Keywords: hypertension, children, remote

OP-073

Obesity in children who are transported from rural villages by bussing system

Yakup Akpınar, Hakan Demirci, Ali Candar, Fatih Çiftçi, Hayri Bozkurt

Department of family Medicine, Sevket Yılmaz Training and Research Hospital, Bursa, Turkey

PURPOSE:

Children living in villages are transported by bussing system to the nearest city center in Turkey. These children's nutritional needs are met by the state. In this study, we aimed to compare obesity between transported group and children living at the city center and fed by their families.

METHOD:

The universe of the study is the primary students aging 6-10 years in Buyukorhan district in Bursa. Height is measured when the child is standing and weight is measured when the child was wearing light clothing. Body Mass Index (BMI) was calculated as $\text{weight}/\text{height}^2$ (kg/m^2). Obesity was determined when $\text{BMI} \geq 95$ percentile.

RESULTS:

There were 107 boys and 121 girls in the study group. Number of children who transported by bussing system was 111 (group A) while 117 (group B) of the children were living in the city center. The average BMI of group A was 15.95 ± 1.59 , and the average BMI in group B was 16.72 ± 2.93 ($p = 0.016$). In total there were 16 obese children and 15 of them were composed of the children were living in the city center.

RESULT:

The prevalence of obesity in rural area in Bursa is 7%. The nutritional needs of children transported from the villages are provided by the state and obesity was quite rare in this group. Our study suggests that programmed healthy diet may protect children from obesity.

Keywords: obesity, children, bussing system, rural

OP-074

The prevalence of developmental delay among children aged 3-60 months in Izmir city center

Aylin Demirci, Mehtap Kartal

Department of Family Medicine, Dokuz Eylul University, Izmir, Turkey

Developmental delay is defined as delays in speech and language development, motor development, social-emotional development, and cognitive development. Worldwide, the prevalence estimations in pediatric population ranges between 5% and 15%. But in Turkey, there is no prevalence studies in primary care on developmental delay. The aim of this study was to determine the prevalence of developmental delay among children aged 3-60 months in Izmir.

A cross-sectional, descriptive research included 1514 children aged 3-60 months, who were at the 12 family health centers (FHC) for any reason in Izmir between November 1, 2013 and January 31, 2014. The questionnaire and age-specific ASQ-TR (Ages and Stages Questionnaire Turkish version) was administered in a face to face interviews by the researcher to the mothers.

The prevalence of developmental delay determined by ASQ-TR was 6.4% (95% CI 5.2-7.7). The prevalence for age groups changed between 3.3 and 12.1%. Significant relationship was found between developmental delay and maternal age, maternal-paternal education, socioeconomic status, comorbidities of mothers, diseases during pregnancy, types of birth and birth weights of children, postnatal diseases and duration of breastfeeding.

Identifying developmental delay in children earlier by administering a validated, reliable, parent-completed questionnaire as ASQ-TR and detecting risk factors for delay are crucial for primary care where their growth and development is monitored. By identifying developmental delay and referring to rehabilitation services earlier may help to improve their quality of life.

Keywords: Developmental delay, prevalence, ASQ, primary care

OP-075

Prevalence of Overweight and Obesity Among Turkish 6-15 Years Old School Children

Demet Merder Coşkun¹, Arzu Uzuner¹, Fatma Dindar¹, Hüseyin Akgün², Mücahit Eroğlu², Fırat Öz², Aziz Kaan Türkoğlu²

¹Marmara University Medical Faculty Department of Family Medicine

²Marmara University Medical Faculty

BACKGROUND: Childhood obesity is one of the most important community health problems which Family Physician to manage. The aim of this study is to assess the current prevalence of overweight and obesity among 6-15 years old school children in the province Istanbul Pendik district in Turkey.

METHOD: This is a descriptive, cross-sectional community-based study. Study was conducted in the 2013-2014 school year. A representative sample of 6-15 years old school children in the province Istanbul Pendik district was selected from the public schools by randomisation. Inclusion criteria was signed informed consent by parent, given date of birth data and presence in the school on the date of anthropometric measurements (including weight, height, waist circumference and mid-upper arm circumference) were done by researchers. The body mass index (BMI) was used as a measure of overweight and obesity in the children. Age-gender specific BMI z-score cutoff points of WHO-MGRS(2007) was used to determine the presence of overweight and obesity. According to the z-score $\geq 1SD$ - $<2SD$ was recognised as "overweight" and $\geq 2SD$ was recognised as "obesity".

RESULTS: Data of the 4246 participants was analyzed; 2135 (50.3%) were male and 2111 (49.7%) were female. Average age was 10.5 ± 2.4 . Prevalence of overweight was 23.4% (M=23.1%, F=23.7%) and obesity was 13.7% (M=15.6%, F=11.7%) respectively. The highest overweight rate was assessed in the age of 13 (26,7%) and the highest obesity rate was assessed in the age of 10 (18.8%) within age groups.

CONCLUSION: Our study showed that overweight and obesity is a serious problem with its high prevalence and comparing with the literature it can be seen that obesity prevalence among Turkish children is tend to increase through years. There is need for further community-based interventions and health policy against the increasing trend of obesity in Turkey.

Keywords: Childhood, school children, overweight, obesity, prevalence

OP-076

Cost of pediatric allergic rhinitis and its complications in Turkey

Ergün Öksüz¹, Simten Malhan², Bilge Sönmez³, Rukiye Numanoğlu²

¹Başkent University, Department Of Family Medicine, Faculty Of Medicine, Ankara, Turkey

²Başkent University, Faculty of Health Sciences, Ankara, Turkey

³Cerkes State Hospital Family Medicine, Cankırı, Turkey

Introduction

Sixty percent of rhinitis cases are allergic rhinitis (AR). AR affects up to 20% of adults and 40% of children. The prevalence of AR is 8.3% in pediatric age group in Turkey. The cost of treatment increases related to severity of the disease and comorbid conditions.

Purpose

The purpose of this study is to evaluate the cost of treatment of AR in the pediatric age group.

Methods

The "Cost of Illness" methodology developed by the World Health Organization was used in the calculation of cost of allergic rhinitis. The calculation based on average cost per patient annually from the perspective of payer (SSI). Costs of all medical services were calculated with Healthcare Applications Bulletin (HAB) of February 18, 2015 according to HAB Appendices 2B and 2C. Costs were converted to purchasing power parity (PPP) in 2014 in US dollars (\$) (\$1 = TL1.179). A sensitivity analysis was performed by using Monte Carlo Simulation for the uncertainty modeling (N= 5,000)

Results

The cost of outpatient treatment was calculated as \$108,4, hospitalization and intervention \$101.8, drugs and other medical supplies \$115.6, complication \$430.0 respectively per patient annually. The average annual direct cost of AR per patient was found to be as \$855.6. Standard deviation of the sensitivity analysis for model was \$596.8 (95% Confidence Interval \$ 841.1 - \$ 874.2)

Conclusion

It is found that the costs of medications account for 13.5%, the costs of outpatient care account for 12.6%, and disease-related complications account for 50.3% of the total cost of allergic rhinitis in the pediatric age group. Follow up treatment which significantly reduces symptoms and medication requirements in allergic rhinitis. It also effects direct cost of illness and loss of school day positively.

Keywords: Allergic Rhinitis, Pediatrics, Cost of illness

OP-077

Fetal growth parametres and sex importance

Joaquín Brea Aymerich¹, Blanca Ribot Serra³, Gemma March Jordi⁴, Susana Abajo Llama⁴, Francisco Josep Fargas Moreno⁴, Victoria Arijá Val², Josep Basora Gallisa²

¹Centro de Atención Primaria, Reus 4-Horts de Miro. Institut Català de la Salut.

²Unitat de Suport a la Recerca del Institut d'Atenció Primària Jordi Gol i Gurina. Institut Català de la Salut.

³Nutrición y Salud Pública. Universitat Rovira i Virgili

⁴Servicio de Atención a la Salud Sexual y Reproductiva. Institut català de la Salut

OBJECTIVE: The aim of this study was to evaluate whether there are differences between the fetal growth parameters and sex in children in our society with childbirths at term and normal weight.

METHODS: Retrospective longitudinal study in 5304 pregnant women who took her control pregnancy in primary cares Health Center, between 2007 and 2012, which had children with normal weight and term and all women had repeated ultrasound assessments to examine fetal growth.

We collected data from the ultrasound: crown-rump length (CRL), biparietal diameter (BPD), head circumference (HC), abdominal circumference (AC) and femur length (FL).

RESULTS: The boys had significantly higher means values in BPD, HC and AC than girls, mainly from the second trimester. We not found significant differences between the CRL or FL and the sex.

CONCLUSION: Healthy boys with term child births and normal weight have significantly higher mean values for BPD, HC and AC than girls. However, the differences are small and not known that may have a clinical impact and it is recommended to conduct studies to assess the clinical significance of these differences. Although these findings provide support for the use of sex-specific sonographic models as well as of sex-specific reference growth charts.

Keywords: fetal growth, parametres, ultrasound

OP-078

Nutritional Status, Healthy Eating Index and Eating Attitudes of the adolescents in Istanbul: A cross-sectional study

Binnur Bakır¹, Hülya Akan², Mehmet Akman³, Oğuzhan Zahmacıoğlu⁴, Osman Hayran⁵

¹Department of Nutrition and Dietetics, Faculty of Health Sciences, Yeditepe University, İstanbul, Turkey

²Department of Family Medicine, Medical Faculty, Yeditepe University, İstanbul, Turkey

³Department of Family Medicine, School of medicine, Yeditepe University, İstanbul, Turkey

⁴Department of Child and adolescence psychiatry, Medical Faculty, Yeditepe University, İstanbul, Turkey

⁵Department of Public Health, School of medicine, Medipol University, İstanbul, Turkey

Background & AIM: The aim of this study was to evaluate dietary quality of adolescents by using Healthy Eating Index (HEI) and to assess their eating attitudes by EAT-26 Eating Attitude Test.

METHODS: Eight schools; four primary schools and four secondary schools were randomly selected from the school list of official website of Istanbul Education National Directorate. 598 students who met the inclusion criteria included in the study, 24 hour dietary recalls were collected to calculate their HEI scores and eating attitudes were evaluated by EAT-26 Eating Attitude Test. Their weight, height and waist circumference were measured.

RESULTS: According to Healthy Eating Index scores, only two (0.3%) of adolescents had high quality diet, 379 (63,4%) had diet quality that needed improvement and 217 (36.3%) had poor diet. Regarding Eating Attitude Test scores, 513 (85.8%) had normal attitudes regarding eating behaviours.

CONCLUSIONS: Almost all of the participants needs either development or major changes in their eating behaviours. Interventions aiming high quality diet among adolescents are strongly recommended.

Keywords: adolescents, healthy eating index, eating disorders, dietary patterns, nutritional status

OP-079

Bronchiolitis Frequency And Factors Those Trigger Bronchiolitis Among Children Aged 0-14 years

Demet Yılmaz¹, Ilknur Demir¹, Dilek Toprak¹, Ibrahim Hakki Aktan²

¹Department of Family Medicine, Sisli Hamidiye Etfal Training And Research Hospital, Istanbul, Turkey

²Department of Pediatrics, Sisli Hamidiye Etfal Training And Research Hospital, Istanbul, Turkey

AIM:

In this study, we aimed to evaluate bronchiolitis frequency and factors those trigger bronchiolitis in children aged 0-14 years.

METHODS:

In this cross-sectional, descriptive study a questionnaire was performed to the parents of children aged 0-14 years who applied to Istanbul Sisli Hamidiye Etfal Training and Research Hospital Pediatric Polyclinics between December 2014 and March 2015. After recording sociodemographic features of the subjects the frequency of bronchiolitis, family history of bronchiolitis, asthma, history of allergic bronchitis, heating type of the house, hospitalization history because of bronchiolitis, mother's smoking status at home during pregnancy were evaluated. Data was assessed using Chi-square, T Test and frequency analysis in SPSS v20.0.

RESULTS:

Totally 100 children included the study whose mean age was $4,22 \pm 3,49$. Of the study group 49% (n=49) were girls and 51% (n=51) were boys. While 58% of our patients (n=58) had history of bronchiolitis, family history of asthma was present in 53% of them. In siblings of 38% children bronchiolitis, asthma or allergic bronchitis were present. While children who had bronchiolitis had a history of 43.1% sibling bronchiolitis history this relationship was not statistically significant ($p=0.217$). There was a significant relation between bronchiolitis and gender ($p=0.023$) as it was more prevalent in boys. Of children who had bronchiolitis had 58.6% family history of asthma, 43.1% history of smoking in the house. However no relationship was found between smoking at home, family history of asthma, heating type of the house and bronchiolitis in children ($p=0.186$, $p=0.249$, $p=0.324$ respectively).

CONCLUSION:

In our study, it was observed that most of the children had bronchiolitis. Although bronchiolitis is a multifactorial disease, in other studies it was carried out that smoking, family history and heating type of the house are risk factors. We believe that the researches with larger groups will highlight this relationship.

Keywords: bronchiolitis, cigarette, children

OP-080

Individualized treatment targets in type 2 diabetes patients: the Dutch approach

Huberta Hart¹, Anne Meike Boels², Rimke Vos², Guy Rutten²

¹Leidsche Rijn Julius Health Centers, Utrecht, The Netherlands

²Julius Center for Health Sciences and Primary Care, University Medical Center Utrecht, The Netherlands

Background and AIM: In different healthcare settings, the proportion of patients who achieve adequate cardiometabolic control is < 25%. We compared the proportion of cardiometabolic well-controlled type 2 diabetes mellitus (T2DM) patients according to a clearly defined, simple individualized approach as recommended in the Dutch guidelines versus the one-size-fits all approach, and investigated which factors are associated with good cardiometabolic control.

METHODS: Observational study, using routine data from electronic medical records of primary care T2DM patients. Data of the individualized (see below) and the one-size-fits-all approach (HbA1c ≤7% (53 mmol/mol), SBP ≤140 mmHg and LDL ≤2.5 mmol/l) were compared. Ordinal regression analysis was performed to determine which factors were associated with good cardiometabolic control.

RESULTS: Of the 890 patients (54.7% male, mean age 62.7 years), 31.8% were well-controlled according to the individualized approach, compared to 24.8% according to the one-size-fits-all approach. For patients aged ≥70 years, using more than metformin alone, a 27.3% increase for reaching the HbA1c target was observed. In patients ≥80 years 45.6% more of them achieved their SBP target of ≤160 mmHg. An LDL ≤2.5 mmol/l was achieved by 62.7% of the patients, with a 5.2% increase according to the individualized approach (67.9%). A higher BMI (odds ratio (OR) 0.97, 95% CI 0.95-0.99), insulin use (OR 0.45, 95% CI 0.33-0.62), and care avoidance (OR 0.17, 95% CI 0.05-0.55) were associated with a lower chance of reaching all treatment targets, the use of lipid-lowering medication (OR 1.39, 95% CI 1.04-1.85) increased that chance.

CONCLUSION: A clearly defined and relatively simple individualized approach might increase the percentage of patients with an overall good cardiometabolic control. Especially elderly patients may benefit from the individualized approach.

Keywords: type 2 diabetes, cardiometabolic control, individualized targets

OP-081

Prevalence of asymptomatic hypertension: A multicenter family practitioners' research

Hakan Demirci, Yakup Akpınar, Ali Candar

Department of family Medicine, Sevket Yılmaz Training and Research Hospital, Bursa, Turkey

AIM:

Hypertension is a well-known risk factor for cardiovascular disease. Effective management of high blood pressure is possible when the magnitude of the problem is documented. In the present study we aimed to investigate the prevalence of asymptomatic hypertension in Bursa.

METHOD:

One thousand thirteen subjects aged ≥20 years were randomly selected to estimate the prevalence of asymptomatic hypertension. Twenty family doctors participated in the study. Socio-demographic data was collected by personal interviews and blood pressure measurements were performed.

RESULTS:

The prevalence of hypertension was 25.8 % (n=261), of the total prevalence 71 % (n=186) were known cases, and 29 % (n=75) were newly detected cases. Sixty seven of the asymptomatic hypertension cases were stage 1, seven cases were stage 2, and only one case was stage 3. Based on the seventh report of the Joint National Committee (JNC VII) on high blood pressure, pre-hypertension was noted in 15.7 % (n=159) of the total.

DISCUSSION:

Prevalence of asymptomatic hypertension is 7.4%. Family doctors should periodically measure blood pressure because there are lots of persons with hidden hypertension.

Keywords: asymptomatic hypertension, family medicine, prevalence

OP-082

Vision screening for school-age children: an opportunity for early detection

Yusuf Haydar Ertekin¹, Murat Tekin¹, Aysegul Uludag¹, Sibel Cevizci², Erkan Melih Sahin¹

¹Department of Family Medicine, Canakkale Onsekiz Mart University, Canakkale, Turkey

²Department of Public Health, Canakkale Onsekiz Mart University, Canakkale, Turkey

Background & AIM:

Pediatric vision screening is planned to detect children with vision disorders which are amblyopia, strabismus, visual acuity and color blindness. Without early identify and control, children's vision disorders can lead to permanent vision loss and teaching difficulties. A common approach to early identifying and controlling of vision disorders in school children is vision screening by pediatricians or family physicians.

METHOD: This cross-sectional and descriptive design study was carried out in the autumn of 2013. Screening was performed by family physicians using the Snellen Eye Chart, and Ishihara and Hirschberg tests after a detailed preliminary training. The screening was conducted to identify visual acuity (VA), colour blindness (CB), amblyopia (AMB) and strabismus (STR).

RESULTS: The study involved 945 female and 1,004 male participants (total 1,949) with an average age of 8.9 for females and 9 for males, and 9 overall. The total prevalence of the screened ocular pathology was found to be 14.4 percent, while VA was detected to have a prevalence of 8.8 percent, CB 4.6 percent, AMB 5.6 percent and STR 2.3 percent, in order of frequency.

The regression analysis revealed three times the STR risk in premature and post mature children; while the risk of AMB was 345 times higher in people with VA and 6.8 times higher in people with STR. The risk of CB was found to be 2.3 times higher among those who had had a caesarean birth.

CONCLUSIONS: The USPSTF recommends vision screening for all children at least once preschool children to identify the presence of amblyopia or its risk factors. The results of our screening of school-age children lead us to the opinion that the preschool screening program is not sufficient, or that screening should be repeated at school age.

Keywords: Vision Screening, Family Physicians, Schools, Students, Prevalence, Cross-Sectional Studies

OP-083

Evolution of depressive symptoms in patients starting treatment with antidepressant drugs

Maria Candelaria Ayuso¹, Ignacio Párraga², Jesús López Torres¹, Susana Morena³, Francisco Escobar¹, Alejandro Villena⁴, José María Del Campo⁵, Joseba Rabanales⁶

¹Albacete Area IV Health Centre, Health Care Service of Castilla-La Mancha, C/Seminario 4, 02006 Albacete, Spain

²La Roda Health Centre, Health Care Service of Castilla-La Mancha, C/Mártires 63, 02630 La Roda, Albacete, Spain

³Hellín 2 Health Centre, Health Care Service of Castilla-La Mancha, C/Turbas de Cuenca 15, 02400 Hellín, Albacete, Spain

⁴San Clemente Health Centre, Health Care Service of Castilla-La Mancha, C/Ancha s/n, 16600 San Clemente, Cuenca, Spain

⁵Almansa Health Centre, Health Care Service of Castilla-La Mancha, C/San Juan s/n, 02640 Almansa, Albacete, Spain

⁶Cuenca Faculty of Nursing, University of Castilla-La Mancha, C/Camino de Pozuelo s/n, 16071 Cuenca, Spain

OBJECTIVE: To determine reducing depressive symptoms in patients who initiated treatment with antidepressants and analyze factors associated with treatment response.

MATERIAL AND METHOD

Design: Prospective longitudinal observational study.

Setting: Primary care of three health areas of Castilla-La Mancha.

Participants: 167 patients older than 18 who initiated antidepressant treatment.

Main measurements: intensity of depressive symptoms (validated 10-item scale Montgomery-Asberg Depression version), health status (CIAP-2 WONCA), consumed drugs, side effects, adherence (Morisky-Green) sociodemographic characteristics and other characteristics of participants.
Descriptive, bivariate regression and Cox statistical analysis.

RESULTS

The mean age was 53.4 years (SD 15.7). Through Depression Scale Montgomery-Asberg an average score at study entry 21.5 (9.3 SD) and 8.4 (SD: 8.1) at 6 months was observed. The proportion of patients who responded to treatment (50% reduction of the Montgomery-Asberg score) was 34.7% (95% CI 27.9 to 42.2) after six months, achieving remission (post-treatment score ≤ 9) of symptoms 28.7% (95% CI 22.4 to 36.0) of patients interviewed. By Cox analysis the variables related to the response to antidepressant treatment were the history of previous depressive disorders (HR:5,2), no previous use of antidepressants (HR:7,2), antidepressant treatment prescribed by family doctor (HR:4,1) and increased attendance at family medicine clinics (HR:1,2).

CONCLUSIONS

One third of patients treated with antidepressants responded to them after 6 months and more than a quarter showed remission of depressive symptoms. It was found that the variables related to the response to antidepressant treatment are the previous disease, history of previous antidepressant treatment, the doctor who prescribed and attendance.

Keywords: Antidepressive agents, Primary health care, Depressive Disorder

OP-084

Dietary compliance and awareness of primary care patients with dyslipidemia

Katarzyna Nessler, Anna Krztoń Królewiecka, Joanna Kwaśniak, Dominika Drwiła, Monika Pyzio, Sylwia Kopeć, Andre Brais, Adam Windak
Department of Family Medicine, Jagiellonian University, Krakow, Poland

BACKGROUND AND AIM:

Dyslipidemia is a metabolic disorder that affects many people worldwide and increases the risk of cardio-vascular disease and other serious clinical disorders. Appropriate, low-fat diet and increased physical activity are essential parts of prevention and treatment of dyslipidemia. The aim of our study was to assess awareness and compliance of proper diet among primary-care patients' suffering from dyslipidemia.

METHOD:

A cross-sectional survey with the use of an anonymous validated questionnaire was performed in 4 GP offices in Krakow from January to February 2015. The essential part of the questionnaire explored patients' diet patterns. Data on socio-demographic characteristics of the participants was also collected.

RESULTS:

The field workers asked 200 PHC patients over the age of 40 to take part in the survey, of whom 178 agreed to participate (response rate: 89%). The mean age of the respondents was 61.94 (SD=12.24), 69% of them were females. 56% of respondents were diagnosed with lipid disorders requiring dietary changes and 43% requiring medications. 74% of patients declared that they changed diet after being diagnosed with dyslipidemia. GP consulted the diet change with 72% of patients diagnosed with lipid disorders. Interestingly, healthier diet patterns were found among females and patients who prepare the meals themselves. The diet pattern did not correlate with the fact of receiving a diet advice from a GP or with the use of lipid-lowering drugs. Respondents diagnosed with dyslipidemia eat more servings of fruits than patients without these disorders ($p = 0.012$). The presence of lipid disorders did not correlate with the other elements of the diet.

CONCLUSIONS:

Despite the fact that patients believe they have changed the diet patterns after being diagnosed with

dyslipidemia - they are not on a proper diet. There is a need for research into effective forms of education for patients.

Keywords: dyslipidemia, diet, education, compliance

OP-085

Cardiovascular Features and comorbidity in patients diagnosed with hypercholesterolemia

Maria Candelaria Ayuso¹, Ignacio Párraga², José María Del Campo³, Joseba Rabanales⁴, Fernando Lago⁵, Juan Manuel Téllez⁶, José María Ferreras⁷, Susana Morena⁸, Francisco Escobar¹, Mariano Blasco⁹, José Jorge Pérez¹, Alejandro Villena¹⁰

¹Albacete Area IV Health Centre, Health Care Service of Castilla-La Mancha, C/Seminario 4, 02006 Albacete, Spain

²La Roda Health Centre, Health Care Service of Castilla-La Mancha, C/Mártires 63, 02630 La Roda, Albacete, Spain

³Almansa Health Centre, Health Care Service of Castilla-La Mancha, C/San Juan s/n, 02640 Almansa, Albacete, Spain

⁴Cuenca Faculty of Nursing, University of Castilla-La Mancha, C/Camino de Pozuelo s/n, 16071 Cuenca, Spain

⁵Sárdoma Health Centre, Health Care Service of Galicia, C/Baixada a Laxe 76, 36214 Vigo, Spain

⁶Albacete Area Vb Health Centre, Health Care Service of Castilla-La Mancha, C/Profesor Macedonio Jiménez s/n, 02006 Albacete, Spain

⁷Royo Villanova Hospital, Health Care Service of Aragón, C/San Gregorio 30, 50015 Zaragoza, Spain

⁸Hellín 2 Health Centre, Health Care Service of Castilla-La Mancha, C/Turbas de Cuenca 15, 02400 Hellín, Albacete, Spain

⁹Delicias Sur Health Centre, Health Care Service of Aragón, C/Manuel Dronda 1, 50009 Zaragoza, Spain

¹⁰San Clemente Health Centre, Health Care Service of Castilla-La Mancha, C/Ancha s/n, 16600 San Clemente, Cuenca, Spain

OBJECTIVE

To describe cardiovascular risk factors and clinical characteristics of patients diagnosed with hypercholesterolemia and to determine their cardiovascular risk and comorbidity.

MATERIAL AND METHOD

Cross-sectional multicenter study will be conducted at facilities of ten health centres in three of Spain's Autonomous Regions (Comunidades Autónomas). 358 adult subjects diagnosed with hypercholesterolemia and selected by consecutive sampling were evaluated. Sociodemographic variables, cardiovascular risk factors, lipid profile, cardiovascular risk (Score and Regicor), health problems (CIAP-2 classification), drug consumption and comorbidity were collected by the Charlson index.

RESULTS

The mean age was 58.6 years (SD: 9.8). 50.6% were hypertensive, 23.2% smoker, 17.6% and 41.6% obese diabetic. 29.6% had metabolic syndrome. 54.5% had a cardiovascular problem. 36.6% had 3 or more health problems. 29.4% had a high or very high cardiovascular risk (Score ≥ 5) and 27.9% Charlson index ≥ 3 . Comorbidity presented a statistically significant positive correlation with respect to the score ($r = 0.537$; $p < 0.001$) and Regicor ($r = 0.352$, $p < 0.001$). By multiple linear regression, the variables associated with greater comorbidity index were: age, use of more drugs, higher score index, more diseases, present a circulatory problem, endocrine, respiratory or genital.

CONCLUSIONS

More than half of the patients with hypercholesterolemia present a cardiovascular problem and about one third a high or very high cardiovascular risk. More than one third had 3 or more diseases. It has been found that in addition to the variables considered in calculating the comorbidity using the Charlson index, there are others that may be related to comorbidity in hypercholesterolemic subjects such as Score index, the presence of a circulatory problem, endocrine, genital or respiratory and the number of drugs consumed or diseases that have been presented.

Keywords: Comorbidity, Hypercholesterolemia, Primary Health Care

OP-086

Missionary work and health care provided by family physicians in late Ottoman and early Turkish period

Mumtaz M Mazicioğlu

Erciyes University Faculty of Medicine

BACKGROUND: Ottoman existence in Anatolia starts from 1288 by the successors of Seljuks and extended to Vienna until 1683. In the last period of Ottoman Empire in the; Europe, Balkan, Anatolia and the middle east parts of the empire there had been an intensive and extensive missionary activity which was led by education and health. Family physicians from United States of America moved to several parts of Ottoman Empire where they gave effective and altruistic health care in several facilities constructed by themselves. In 1914 there were 24 stations, 308 outstations, 209 missionaries, 1299 native laborers, 450 schools, 9 hospitals, 10 dispensaries which accounts the %25 of work done in whole world by American Board of Commissioners in foreign Missions.

METHODS: The medical work done in several hospitals belonged to different missions and family physicians who gave both in- and outpatient health care will be described in this presentation.

RESULTS: The work done by Dr Shephard (Figure 1) in Gaziantep/Turkey will be summarized as a template of the role of family physicians for non-muslim and muslim citizens of Ottoman Empire. Azariah Smith is the first physician East part of Ottoman Empire who arrived in 1842. In 1880 a medical school was founded with three lecturers and 12 students. Fred Douglas Shepard becomes the director from 1882 to 1914. Before his set-up in Gaziantep he takes a course for oral health with his wife also. At his first glance in Gaziantep he observes that osteopaths and fitotherapists were the two groups who serves in primary health care and there were no others.

CONCLUSIONS: Since the first school of medicine were founded in Ottoman empire in 1827 Gaziantep medical may be regarded as the first civil facility of medical education. Primary health care provided by this facility is still going on.

Keywords: Family physician, American board, Missionary work

Dr. Shephard



Dr. Shephard in operating room

OP-087

Abdominal obesity and incidence of cardiovascular events. A retrospective cohorts study

Juan Ignacio Sáenz¹, Fernando Javier Elias¹, Nino Abuladze¹, Inma Sánchez²

¹Palafrugell Primary Care Center. Palafrugell, Girona. Spain

²Research Department. Hospital of Palamos. Palamos, Girona. Spain

BACKGROUND & AIM

The objective was to analyze the association between abdominal obesity and the incidence of cardiovascular events in a Primary Care setting during five years.

DESIGN: Retrospective cohorts study. Four Primary Care Centers. Time period of analysis from 2008 to 2012. Selection criteria: both genders in the age range of 35 - 74 with no cardiovascular disease in 2007. Variables: abdominal perimeter (AP) in centimeters in the year 2007. Number of cardiovascular events between 2008 and 2012. Considering: myocardial infarction, angina, stroke, TIA, aortic dissecting aneurysm, peripheral arterial ischemia. Other: Age, gender, BMI, smoking, diabetes mellitus, hypertension, total cholesterol, HDL, proteinuria and sedentary lifestyle in 2007. Statistical analysis: proportion comparison, relative risk (RR), confidence interval of 95%. Limitations: Low AP documentation during the year 2007.

RESULTS: Assigned population: 93,000 people. People included in the study: 36,503. Women: 18,314 (50,2%). Men: 18,189 (49,8%). Average age: 49 years old (9,9). 1008 cardiovascular events in 5 years. Incidence: 2,8 cases per 100 people in 5 years. By gender: 3,8 cases per 100 men in 5 years (0,76 per year) and 1,8 cases per 100 women in 5 years (0,36 per year). For abdominal obesity 7311 people have been included. The RR is 0,94 (CI95: 0,76 – 1,15)

CONCLUSION: The incidence of cardiovascular events in this study is lower to the rate registered in Spain during the year 2004, which is of 1,40 cases per 100 men / year and 1,22 cases per 100 women/ year. The study did not find an association between abdominal obesity and incidence of cardiovascular events. We consider it desirable to increase the documentation of abdominal perimeter.

Keywords: Abdominal obesity, Primary care, cardiovascular disease

OP-088

Early and menopausal weight gain, and their relations with diabetes and hypertension International study on lifelong weight gain and manifestation of metabolic diseases

Imre Rurik¹, Csaba Móczár², Nicola Buono³, Iveta Vaverkova⁴, Pavlo Kolesnyk⁵, Thomas Frese⁶, Jarmila Mahlmeister⁶, Ferdinando Petrazuoli⁷, Enzo Pirota³, Tímea Ungvári¹, Zoltán Jancsó¹, Imre Rurik⁸

¹University of Debrecen, Debrecen, Hungary

²Irinyi Primary Care Health Center, Kecskemét, Hungary

³SNAMID (National Society of Medical Education in General Practice), Italy

⁴Slovak Society of General Practice, Slovak Medical Association, Bratislava, Slovakia

⁵Department of Family and Internal Medicine, Institute of Postgraduate Education and Undergraduate Training, Uzhgorod National University, Uzhgorod, Ukraine

⁶Department of General Practice, University of Leipzig, Leipzig, Germany

⁷Department of Clinical Sciences, Centre for Primary Health Care Research, Lund University, Malmö, Sweden

⁸EGPRN (European General Practice Research Network, Maastricht, The Netherlands)

Background

Previous research found relations between weight gain and metabolic diseases developed later. These studies covered only short periods, not longer than 4-8 years.

We aimed collecting decades long, often life-long anthropometric data for better comparison of this relation.

Methods

A retrospective international study was planned and organized to compare data of self-recorded lifelong weight

gain of persons between 60y-70y, to analyze its correlation with developed metabolic diseases, with special attention to women's weight gain around pregnancy, delivery and menopause within primary care settings in Germany, Hungary, Italy, Slovakia and Ukraine.

Results and discussion

There were 815 participants recruited, and 286 men/447 women of them presented completely all the required data. The weight and BMI of the whole study population increased till their seventies, less after their fifties. Changes over decades were higher among patients with hypertension than within "healthy" group. Weight increase in the first decades (20-30y by men, 30-40y by women) was a significant risk factor for the development of diabetes (OR=1.49; p =0.017;95%;CI:1.07-2.08). Significantly higher weight gains were recorded in the last decade before diabetes has been diagnosed. Among patients with diabetes and hypertension, both diagnoses were set up earlier, than by patients with one morbidity.

By females, weight increases around delivery and menopause correlated significantly with higher odds for the diagnoses of diabetes and/or hypertension, without significant correlations with the numbers of children.

Conclusions

Primary care physicians during their decade-long contact with their patients are expected to identify the weight gain of the patients still in their early decades and provide intervention, if necessary.

Keywords: diabetes, Germany, Hungary, hypertension, Italy, menopause, metabolic syndrome, obesity, primary care, Slovakia, Ukraine, weight gain

OP-089

Evaluation of cooccurrence prevalence of depressive symptoms and metabolic syndrome in patients applied Dokuz Eylul University Faculty of Medicine, Family Medicine department outpatient clinic

Ilyas Erken¹, Nilgün Özçakar²

¹ilyas erken

²nilgün özçakar

OBJECTIVE: Our aim is to evaluate the prevalence and cooccurrence of metabolic syndrome according to different guidelines and depressive symptoms in outpatient clinic of family medicine department to contribute the diagnosis and treatment period.

METHODS: Our cross-sectional study performed with informed participants applied Dokuz Eylul University Faculty of Medicine Family Medicine Department outpatient clinic in between 01.12.2013-01.04.2014. Questionnaire about demographical variables and Beck Depression Inventory scale used and performed by investigator with face to face interview. We diagnose metabolic syndrome according to The Society of Endocrinology and Metabolism of Turkey, National Cholesterol Education Programme ATP III and International Diabetes Federation guidelines. Data evaluated with SPSS 15.0 package program, p<0.05 is accepted statistically significant.

RESULTS: Our study was performed with 247 participants. The medium age 34.98±14.90 years, 60.6% of participants were female, 87.4% of high school and upper education level. We grouped the participants according to Beck depression inventory point; 73.9% minimum, 16.6% mild, 9.3% moderate, 0% severe. Elevated Beck Depression Inventory point causes rational increase prevalence of metabolic syndrome in 2 guidelines.(p<0.05)

CONCLUSION: As the severity of depressive symptoms increases there is an increased incidence of metabolic syndrome. Monitoring patients closer who have depressive symptoms by family physicians in primary care is important in terms of components of metabolic syndrome.

Keywords: Metabolic Syndrome, Major Depression, Depressive symptoms

OP-090

Prevalence and Associated Risk Factors of Tinnitus in Adults

Sevim Aksoy Kartcı, Çiğdem Apaydın Kaya, Yeliz Özendi

Department of Family Medicine, Marmara University, Istanbul, Turkey

BACKGROUND:

Tinnitus is very common symptom in primary care and have important implications for patients' quality of life. However, tinnitus substantially underdetected and undertreated.

AIM:

The aim of this study was to analyze the prevalence and associated risk factors of tinnitus among the patients who admitted to our family medicine outpatient clinic with any symptom.

METHOD:

This is a descriptive study. The patients ≥ 18 years old and being at least literate admitted to family medicine outpatient clinic of Marmara University during 2 weeks were included to the study. The patients admitted with acute tinnitus or otological complaints were excluded. A questionnaire which includes tinnitus handicap inventory, medical history, caffeine, alcohol and tobacco consumption, global health perception scale and Beck depression inventory were used. The questionnaire and scales were filled by the patients. For the analysis chi square test, student's t-test and multiple logistic regression analysis were performed.

RESULTS:

Totally 226 of 1091 patients who admitted during the study period were participated to the study. 74% were female, 26% were male. Mean age was 41 ± 1.26 . Among the patients 43.4% have tinnitus. 20% of the patients' depression score was ≥ 17 . The univariate analysis revealed that at the 0.05 level of significance the variables otologic and sinonasal conditions, noise exposure, hearing problems, weight gain, dizziness, gastroesophageal reflux, sensation problems, insomnia, joint problems, hypertension, drinking tea ≥ 2 cup, poor health perception and having depression symptoms to be significantly associated with tinnitus. Analyzing the risk factors for tinnitus, gastroesophageal reflux (OR:0.055; CI:0.009-0.333), otologic and sinonasal conditions (OR:0.143; CI:0.024-0.863), and having depression symptoms (OR:0.036; CI:0.003-0.512) were found to be a risk factor for tinnitus.

DISCUSSION:

We found that tinnitus prevalence among the patients admitted to our clinic was higher than the literature. Further studies should be done associated with the impact of the treatment of reflux and depression on tinnitus.

Keywords: tinnitus, symptoms, depression, hearing problems

OP-091

Healthy Ageing Through Internet Counselling in the Elderly (HATICE): design of a randomised controlled trial

Susan Jongstra¹, Miia Kivipelto², Sandrine Andrieu³, Edo Richard¹

¹Department of Neurology, Academic Medical Center, Amsterdam, The Netherlands

²Aging Research Center and Alzheimer Disease Research Center, Karolinska Institutet, Stockholm, Sweden

³Department of Epidemiology and Public Health, Toulouse University Hospital and Inserm U1027, F-31073, Toulouse, France

Background & Aim

Cardiovascular risk factors including hypertension, hypercholesterolemia, smoking, obesity, diabetes and physical inactivity are associated with an increased risk of both cardiovascular disease (CVD) and dementia. To reduce this risk among people of 65 years and older, more accessible prevention programs would be welcomed and self-management could be a powerful tool to this end. In this study we investigate the efficacy of an innovative interactive internet platform to optimise self-management of cardiovascular risk factors in older persons to reduce cardiovascular risk and prevent cardiovascular disease and dementia.

Methods

HATICE is a multi-national, multi-centre, investigator initiated, open-label blinded endpoint (PROBE), randomised controlled trial, with 18-months intervention and follow-up. Recruitment of 4250 people aged 65 years and older with an increased cardiovascular risk will take place in Finland, France and the Netherlands. The intervention group will use an interactive internet-platform supported by a coach to improve a healthy lifestyle. The control group will get access to a platform similar in appearance but without the interactive features and support of a coach.

Outcome

The primary outcome of the study is a composite score based on the difference between baseline and 18 months follow-up values of systolic blood pressure, cholesterol and BMI. Main secondary outcomes are improvement in estimated 10-year cardiovascular disease risk based on the Framingham cardiovascular disease risk score, incident cardiovascular disease, improvement of the number of measurable risk factors (blood pressure, BMI, cholesterol, glycated haemoglobin), improvement of the number of self-reported risk factors (physical exercise, diet), mortality, disability, cognitive decline, CAIDE dementia risk-score, depression and cost-effectiveness.

Conclusion

The growing use of the Internet among older persons allows for development of innovative strategies to improve cardiovascular risk management, which can be easily implemented on a large scale if effective.

Keywords: eHealth, Cardiovascular prevention, Aged

HATICE logo



Logo of the trial

OP-092

Internet-interventions targeting cardiovascular risk factors in older people: a systematic review and meta-analysis

Cathrien R Beishuizen¹, Blossom C Stephan², Willem A Van Gool³, Carol Brayne⁴, Ron J Peters⁵, Sandrine Andrieu⁶, Miia Kivipelto⁷, Hilikka Soininen⁸, Wim B Busschers¹, Eric P Moll Van Charante¹, Edo Richard³

¹Department of General Practice, Academic Medical Centre, University of Amsterdam, Amsterdam, The Netherlands

²Institute of Health and Society, Newcastle University, Newcastle, United Kingdom

³Department of Neurology, Academic Medical Centre, University of Amsterdam, Amsterdam, The Netherlands

⁴Department of Public Health and Primary Care, Institute of Public Health, Cambridge University, Cambridge, United Kingdom

⁵Department of Cardiology, Academic Medical Centre, University of Amsterdam, Amsterdam, The Netherlands

⁶Department of Epidemiology and Public Health, Toulouse University Hospital and Inserm U1027, F-31073, Toulouse, France

⁷Aging Research Center and Alzheimer Disease Research Center, Karolinska Institutet, Stockholm, Sweden

⁸Department of Neurology, University of Eastern Finland, Kuopio, Finland

Background and aim

E-health is expanding the possibilities for contemporary medicine. In view of the global ageing and pandemic of unhealthy lifestyles, there may be growing scope for innovative Internet-interventions that can address the increasing burden of cardiovascular risk and disease. Elderly people form an important target population because the reduction of cardiovascular risk appears effective until well beyond the age of 65. In this systematic review and meta-analysis, we aim to evaluate whether Internet-interventions to improve cardiovascular risk factor management in older persons can reduce the risk of cardiovascular disease.

Method

We systematically searched Embase, Medline, Cochrane and Cinahl from 1995 onwards for randomized controlled trials on Internet-interventions targeting cardiovascular risk factors in older populations with a mean age of at least 50 years. Outcomes regarding treatment effects on cardiovascular risk factors (blood pressure (BP), glycated haemoglobin (HbA1C), LDL-cholesterol, smoking status, weight and physical inactivity) and incident cardiovascular disease were pooled with random effects models, where possible.

Results

36 studies (12,157 participants) fulfilled eligibility criteria. 27 studies provided sufficient information to be included in the meta-analysis. In the intervention group, we found a small but significant reduction of systolic BP (-2.82 mmHg (95% CI, -3.97 to -1.67)), diastolic BP (-1.54 mmHg (95% CI, -2.23 to -0.85)), HbA1c (-0.23% (95% CI, -0.38 to -0.09)), weight (-1.59 kg (95% CI -2.48 to -0.70)) and physical inactivity (standardised mean difference -0.11 (95% CI, -0.21 to -0.01), but no effect on LDL-cholesterol. In studies with a short follow-up (<12 months) effects were larger than in studies with a longer follow up (≥12 months). There was no effect on cardiovascular events (2 studies).

Conclusions

The cardiovascular risk profile of older people can be improved using Internet-interventions, but the effects are modest and decline with study duration. There is currently insufficient evidence for an effect on incident cardiovascular disease.

Keywords: eHealth, cardiovascular prevention, aged

OP-093

A randomised controlled non-inferiority trial of primary care-based facilitated access to an alcohol reduction website (EFAR-FVG): Preliminary results

Roberto Della Vedova¹, Pierluigi Struzzo⁶, Donatella Ferrante⁵, Nicholas Freemantle², Charilaos Lygidakis³, Francesco Marcato⁵, Emanuele Scafato⁴, Francesca Scafuri¹, Costanza Tersar⁵, Paul Wallace²

¹Centro Studi e Ricerche in Medicina Generale, Monza, IT

²Department of Primary Care and Population Health, University College London, London, UK

³Movimento Giotto, Bologna, IT

⁴Istituto Superiore della Sanità, Roma, IT

⁵Department of Life Sciences, University of Trieste, Trieste, IT

⁶Centro Regionale di Formazione in Medicina Generale, Monfalcone, IT

Background & Aim

The effectiveness of brief interventions for risky drinkers by GPs is well documented. However, implementation levels remain low. Facilitated access to an alcohol reduction website offers an alternative to standard face-to-face intervention, but it is unclear whether it is as effective. This study evaluates whether facilitated access to an alcohol reduction website for risky drinkers is not inferior to the face-to-face brief intervention conducted by GPs.

Method

In a northern Italy region participating GPs actively encouraged all patients > 18 attending their practice, to access an online screening website based on AUDIT-C. Those screening positive underwent a baseline assessment with the AUDIT-10 and EQ-5D questionnaires and subsequently, were randomly assigned to receive either online counselling on the alcohol reduction website (intervention) or face-to-face intervention based on the brief motivational interview by their GP (control). Follow-up took place at 3 and 12 months and the outcome was calculated on the basis of the proportion of risky drinkers in each group according to the AUDIT-10.

Results

More than 50% (n= 3974) of the patients who received facilitated access logged-on to the website and completed the AUDIT-C. Just under 20% (n = 718) screened positive and 94% (n= 674) of them completed the baseline questionnaires and were randomised. Of the 310 patients randomised to the experimental Internet intervention, 90% (n = 278) logged-on to the site. Of the 364 patients of the control group, 72% (263) were seen by their GP. A follow-up rate of 94% was achieved at 3 months.

Conclusions

The offer of GP facilitated access to an alcohol reduction website is an effective way of identifying risky drinkers and enabling them to receive brief intervention. The study results will be available soon and we expect to be able to present these to the conference.

Keywords: Brief Intervention, Primary Care, Risky Drinking, Internet

OP-094

Healthy Life Style Behavior Among Turkish University Students: A Meta Analysis

Gülin Kaya, [Dilsad Save](#)

Department of Public Health, Marmara University. Istanbul, Turkey

Background & Aim

According to World Health Organization 70-80 percent of mortality causes from the diseases related with life style factors in developing countries and 40-50 percent in the developed nations. During the university education, students usually experience considerable changes in their lifestyle which often influence their health status in the following years. Therefore, it is necessary to assess their lifestyles and needs in order to give insights to health professionals for planning of health promotion activities for this population. Currently there is no Meta Analysis on Healthy Life Style among Turkish University Students. This study aims to systematically evaluate studies on Healthy Life Style Behavior of Turkish University Students

Method

Studies conducted in Turkey by using Healthy Lifestyle Behavior Scale (HLBS) were included to meta-analysis. The data were collected in Jan.-Feb. 2015 by using Google Scholar, PubMed database. Ten studies were included for analysis to assess weighted average mean values of HLBS. Subscales of the inventory -self-realization, health responsibility, interpersonal relationships, stress management, nutrition and exercise- were also analyzed. Random-effects model was used in all analyses and subgroup analyses for each examined outcome were also carried out.

Results

Total of 2932 students were included in the analyses. Age range was between 17-31 years old. Weighted average mean of HLBS was found to be $122,64 \pm 0,92$ presenting moderate level healthy behavior. Among the subscales the higher mean values were observed for self-realization. Responsibility for health and interindividual supportive measures whereas habitual exercise had the lowest means.

There was no statistically significant difference between girls and boys in terms of healthy behavior ($p=0,40$). The last grade students had significantly higher scores than those of first grades ($p=0,02$)

Conclusions

University life was found positive effect on students' healthy life style although it was not on the desired level. Health Promotion programs in this population were needed to be carried out.

Keywords: Meta-Analysis, healthy life style, university students, health promotion

OP-095

Be active to stay young! Our experience on physical exercise and well-being in aged patients from a Health Care Centre

[Daniela Florentina Pruteanu](#)¹, [Francisco Antón García](#)², [Carolina Mir Sánchez](#)², [Olga Maroto Delgado](#)²

¹Quart de Poblet Health Care Centre, Valencia, Spain

²Fuensanta Health Care Centre, Valencia, Spain

BACKGROUND AND AIM: to determine if physical exercise systematically practiced by a group of aged patients from a health care centre does improve their perception on their own health and well-being.

METHOD: we anonymously applied a questionnaire (adapted SF-12) about perceived health status, to a group of 54 patients, aged 65 and older. They have been practicing physical exercise for at least six months, 3 hours a week, supervised by a 67 year old "expert patient". The questionnaire assessed their health status as they perceive it in the present compared to what they perceived before starting the physical exercise programme.

RESULTS: the group included 48 women and 6 men. Mean age: 72.2 years old. Question (Q) 1 - in the present your health status is: good 37%; very good 33.3%; excellent 16.7%. Q2 - present versus previous (before programme) health status: the same 9.3%; better or much better 90.7%. Q3 - improvement in performing your daily activities: 96.3%. Q4 - since you have started exercise, your aches: are the same 11.1%; diminished 79.6%; disappeared 9.3%. Q5 what about your state of mind: it improved a lot 57.4%; it slightly improved 40.7%. Q6 - social life improvement: it improved a lot 55.6%, it slightly improved 42.6%. Q7 do you feel with more energy: absolutely true 51.9%; true enough: 38.9%. Q8 did your quality of life improve: absolutely true 51.9%; true enough 33.3%. Q9 how do you consider your global health status in a scale from 0 to10: before practicing physical exercise 6.31; after practicing physical exercise 9.09 (p=0.000, CI 2.20-3.36).

CONCLUSIONS: in our group of patients physical exercise practiced systematically improved their perception on well-being and also their social relationships, they felt more active.

Keywords: physical exercise, aged people, health promotion

Expert patient



Our "expert patient" a 67 year old widow with the group of patients practicing physical exercise

OP-096

Situations of undergoing screening tests for cancer prevention of family physicians in Ankara, Turkey

Selda Tekiner¹, Gülseren Lale², Gülsen Ceyhun Peker¹

¹Department of Family Medicine, Ankara University School of Medicine, Ankara, Turkey

²Meydan Family Health Center, Mut, Mersin, Turkey

AIM: Family physicians recommend and guide their patients to undergo screening tests for preventable cancer types. We aimed to determine physicians' self-screening rates.

METHOD: This is a descriptive cross-sectional study. Family physicians working at "Family Health Centers" in Ankara at the age of ≥ 40 years were included. A questionnaire was designed to define doctors' screening rates and it was completed face to face. The data were collected from 246 Family Health Centers between June 2013 and August 2013 and analysis was performed using SPSS version 15. Data were described as means and standard deviations (mean \pm SD) or medians and ranges. Comparisons of nominal variables were performed with the Pearson's chi-square and Fisher's exact test.

RESULTS: Of the participants 43% were between the ages of 46-50 years; 42.2% were female and 9.5% were family physician specialists while 90.5% were general practitioners. The rates of undergoing screening tests were: 8.6% for colonoscopy, 2.7% for fecal occult blood test, 60.0% for mammography, 41.1% for clinical breast examination, 60.0% for Pap smear. Having a colonoscopy ratio was 32.3% among doctors with a family history of colon cancer, and 6.9% among doctors without a family history ($p < 0.001$). Of the doctors 95.6% agreed with the necessity of undergoing screening tests, and 32.9% believed that family physicians should be responsible to ensure patients' undergoing screening tests. The ratio of "not believing about the responsibility of the patients' tests" was higher among general practitioners who didn't receive speciality education compared with the specialists ($p = 0.041$). The ratio of applying their own family physicians for screening tests was only 3.5%. The main reason for not undergoing screenings was "lack of time".

CONCLUSION: Family physicians had inadequate screening status for cancer. It is essential to draw physicians' attentions about cancer screening tests for themselves.

Keywords: cancer prevention, family physicians, screening

OP-097

Pneumococcal vaccination in primary care settings

Peter Vajer, Peter Torzsa, Ferenc Tamás, László Kalabay

Department of Family Medicine, Semmelweis University Budapest, Hungary

BACKGROUND:

Influenza and pneumococcal vaccination are important preventive care measures to reduce morbidity and mortality in high-risk groups. Pneumococcal vaccination has also been shown to have effects additional to influenza vaccination in preventing pneumococcal bacteraemia, particularly in high-risk groups. Despite recommendations for immunization there is evidence of poor coverage of high-risk groups.

OBJECTIVE:

The aim of this project was to show whether a campaign based in general practice is a practical and appropriate mechanism for increasing uptake of pneumococcal vaccine among high risk patients.

METHOD:

Every patient vaccinated with influenza vaccination was informed either by the nurse or by the GP about the importance of pneumococcal vaccination and was asked to fulfill a short questionnaire in 20 GP settings in Hungary during 2012/13 influenza vaccination campaign. Those who had been vaccinated by pneumococcal vaccine fulfilled a second questionnaire later on.

RESULTS:

4000 patients were involved in the study, 576 asked for prescription of pneumococcal vaccine, while 310 were vaccinated, 16,5% of the women and 11,6% of men (OR 1,67 CI 95% 1,37-2,04, $p < 0,001$), mean age 70,95 vs. 69,8 (OR 1,01; CI 95% 1,00-1,02; $p < 0,05$). In case the pneumococcal vaccination was offered by the GP the rate of asking for prescription was 33,6 vs offering by the nurse it was 8% (OR 6,33; CI 95% 5,23-7,67; $p < 0,001$), while the rate of vaccinated patients 17,7% vs 4,4%. The number of vaccinated patients from the year 2011/12 to 2012/13 was increased 6,32 folds ($p < 0,001$). The vaccination was refused because of the high price of the vaccine in 45%, 20% of the patients were vaccinated within 5 years, some were "afraid of the needle".

CONCLUSIONS:

A practice based campaign is an effective method of increasing uptake of pneumococcal vaccine by high risk groups. Offering pneumococcal vaccine by GP is more effective then by practice nurse.

Keywords: pneumococcus vaccination

OP-098

Yield of screening for atrial fibrillation in primary care during influenza vaccination in the Netherlands

Femke Kaasenbrood¹, Monika Hollander¹, Frans H Rutten¹, Leo J Gerhards², Arno W Hoes¹, Robert G Tieleman²

¹Julius Center for Health Sciences and Primary Care, University Medical Center Utrecht, Utrecht, The Netherlands

²Department of Cardiology, Martini Hospital Groningen, Groningen, The Netherlands

Background & Aim. Atrial fibrillation (AF) mainly affects older people, and it may remain asymptomatic. Practice guidelines recommend screening in community-dwelling persons aged 65 years and over. Single-lead electrocardiography would facilitate such screening. We wanted to assess the yield and feasibility of screening with such a device.

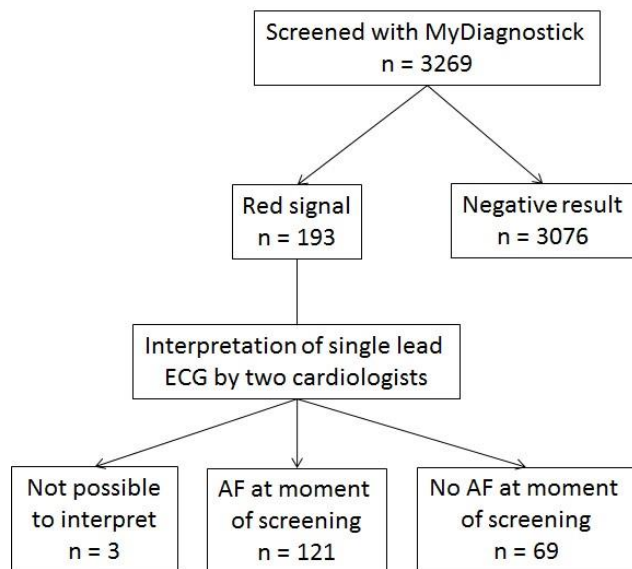
Methods. We used the MyDiagnostick to screen for AF in persons who participated in influenza vaccination sessions. The study was performed in ten Dutch general practices. In cases with a 'red light' a one-minute ECG registrations was analysed by two cardiologists. Data on comorbidity were assessed by scrutinizing the electronic medical files of the general practitioners. Multivariable logistic regression analysis was performed to establish the relation between patient characteristics and a novel screen-detected diagnosis of AF.

Results. In total 9,450 community-dwelling persons participated in the influenza vaccination, and 3,269 (34.6%) of them held the MyDiagnostick device. In total, 37 (1.1%) new, previously unknown cases of AF were detected. Prior TIA or stroke (odds ratio 6.05; 95% CI 1.93 to 19.0), and age (OR 1.09 per year; 95% CI 1.05 to 1.14) were independent predictors for a screen-detected diagnosis of AF. Of the 37 screen-detected AF cases, 2.7% had a CHA2DS2-VASc of zero, 18.9% a score of 1, and 78.4% a score of 2 or more. Thus, the majority of new detected cases should receive adequate stroke prevention with oral anticoagulant therapy.

Conclusions. Screening with an easy to use single-lead ECG device during influenza vaccination in Dutch general practices resulted in 1.1% new cases of AF. It was feasible to 'mass' screen for AF within a short duration of time.

Keywords: atrial fibrillation, screening, primary care

Flow chart of study



Baseline characteristics of individuals who held the MyDiagnostick divided in new screen-detected cases of AF, patients already known with AF, and a random sample of patients with no AF

	Newly detected AF with screening N = 37	Already known with AF and a red light with screening N = 84	Sample of patients with no AF* N = 220
Men (%)	21 (56.8)	49 (58.3)	101 (45.9)
Mean age (SD)	75.9 (8.6)	75.6 (8.3)	65.9 (12.4)
Hypertension (%)	24 (64.9)	55 (65.5)	95 (43.2)
Diabetes (%)	9 (24.3)	23 (27.4)	52 (23.6)
Heart failure (%)	2 (5.4)	18 (21.4)	2 (0.9)
Stroke (%)†	7 (18.9)	9 (10.7)	6 (2.7)
TIA (%)	3 (8.1)	10 (11.9)	1 (0.5)
VTE (%)‡	2 (5.4)	7 (14.3)	10 (4.5)
Peripheral arterial disease (%)	3 (8.1)	2 (2.4)	7 (3.2)
Prior myocardial infarct (%)	2 (5.4)	10 (14.3)	7 (3.2)
Coronary arterial disease (%)	1 (2.7)	5 (6.0)	15 (6.8)
Valvular repair (%)	0 (0)	6 (7.1)	1 (0.5)
CABG/PCI/PTCA (%)	2 (5.4)	14 (16.7)	19 (8.6)
COPD (%)	4 (10.8)	12 (17.1)	17 (7.7)
Renal disease (%)	3 (8.1)	11 (15.7)	8 (3.6)
Pacemaker (%)	0 (0.0)	4 (4.8)	2 (0.9)

* Sample of 220 persons unknown with AF and also sinus rhythm on the MyDiagnostick single lead ECG with screening during flu vaccination † Stroke is defined as ischaemic stroke or cryptogenic stroke not being an hemorrhagic infarction ‡ VTE = Venous thromboembolism, including history of pulmonary embolism and/or deep vein thrombosis

OP-099

Preventive Health care with simulations

Mateja Skufca Sterle, Uros Zafosnik, Antonija Poplas Susic
Community Health Centre Ljubljana, Slovenia

Background and AIM:

The purpose of this paper is to present a modern form of health education, whose main objective is a change in patients' lifestyle, thereby reducing the risk of morbidity. At the simulation center (SIM Center) of Community Health Centre Ljubljana we implement simulation in the prevention. By integrating simulation into preventive programs we want patients to achieve a faster and more reliable insight into probable consequences of their lifestyle, unless opted for a healthy lifestyle. The simulations are a much easier way of achieving insight than lectures. Through the process of learning and repetition of individual simulation the patients experience negative experiences, which will help them motivate to change their lifestyle. The main motivator and the therapeutic source is the distress of the negative experiences and the resulting self-help. Distress will be created with the help of professionally managed simulated experiences. For example, for smokers we use the simulator to achieve reduced lung capacity in a way that patients experience shortness of breath, which is the main characteristic of chronic obstructive pulmonary disease.

METHODS:

Preventive program includes patients who have already received preventive activity by a reference nurse and still have not made the lifestyle changes. We will try to motivate a change in lifestyle with the modern form of health education. Quality indicators that will be monitored: smoking cessation and weight loss.

Expected RESULTS:

We will achieve changes in lifestyle for at least 30% of participants in the prevention program.

CONCLUSION:

At the SIM Center of Community Health Centre Ljubljana we implement prevention programs with the help of simulations, whose main objective is a change in patients' lifestyle, thereby reducing the risk of morbidity. It is about learning from a crisis situation - positive learning from an unpleasant experience.

Keywords: simulation in the prevention, prevention, healthy lifestyle

OP-100

Characteristics of Dutch general practices participating in a cardiometabolic prevention program

Daphne Stol¹, Ilse Badenbroek¹, Suzanne Van Der Velden¹, Monika Hollander¹, Mark Nielen², Francois Schellevis², Niek De Wit¹

¹Julius Center, UMC Utrecht

²NIVEL

BACKGROUND: We presently conduct the INTEGRATE study, which aims to investigate the effectiveness and cost-effectiveness of a "Personalized Prevention Approach for Cardio-Metabolic Risk" (PPA CMR) and to assess determinants for participation and compliance. Tailored lifestyle intervention is part of the intervention. Experiences with multidisciplinary integrated care programs and motivation for preventive activities of participating practices are expected to affect the effectiveness of PPA CMR. The aim of this qualitative study was to determine the motivation for preventive activities in the participating practices as well as to determine possible impediments for successful implementation of PPA CMR.

METHOD: a survey among practices that participate in the INTEGRATE study.

RESULTS: Currently, data from 22 of the 38 participating practices are available. The practices consist of group-practices (36%), health care centres (32%), solo-practices (23%) and duo-practices (9%) distributed across the Netherlands. 82% of the practices are accredited by the Dutch college of GP's. All practices offer integrated care programs for diabetes, 91% also for COPD and 82% for cardiovascular risk management. Implementation of the PPA CMR intervention is performed by practice nurses in 73% of the practices. Practice nurses are well trained in giving lifestyle advice in 94% of the practices. The mean rating practices gave themselves for interest in prevention was 7.9 (on a scale of 10) and 7.7 for motivation for prevention. 27% of the practices indicated they were well informed about locally offered lifestyle interventions. Practices consider insufficient financing (64%) and limited availability of staff (59%) impeding factors for implementation of PPA CMR.

CONCLUSION: Participating practices are motivated and prepared for preventive activities and are experienced in working with integrated care programs. They are often not aware of the available lifestyle interventions in their area and consider staff shortage and inadequate financing as major obstacles for implementation of PPA CMR.

Keywords: prevention, cardiometabolic disease, general practice, implementation

OP-101

Primary Health Care Application and Coronary Risk Factor Management of Coronary Heart Disease Patients

Tevfik Tanju Yilmazer¹, Caner Çabuk¹, Kurtuluş Öngel²

¹Clinic of Family Medicine, Tepecik Training and Research Hospital, İzmir, Turkey

²Department of Family Medicine, Katip Celebi University, Izmir, Turkey

Background & AIM:

Coronary heart diseases are among the leading causes of mortality and morbidity globally. More than three quarters of deaths related to coronary artery diseases can be prevented by appropriate lifestyle adjustments that can easily be achieved through primary health care (PC). We aimed to question the presence and evaluate the effect of "primary health care coronary risk management" for coronary heart disease (CHD) patients.

METHOD:

The study has a descriptive cross sectional design. It was carried out between October 1st and December 31st 2014. The research population consisted of patients who were diagnosed to have CHD by coronary angiography. A questionnaire pertaining utilization of PC by the patients and the intervention of family physician involving CHD management was applied. Statistical analysis was made by stating the frequency of datum, chi-square, ANOVA and T-test for the ratios.

RESULTS:

The number of patients enlisted was 177 with 46 females (26%) and 131 males (74%) with an age average of 60.8 ±11.061 years. It was seen that 76.8% of patients had at least one comorbid disease with high blood pressure being the most frequent (58.2%). When the application to PC was questioned it was found to be 75.1% for CHD patients and the application was statistically significantly high for patients with a chronic comorbid disease (p=0.007). The majority of applications to PC was for represcription of medication (86.4%). It was noted that blood pressure assessment was 65.4%, testing the lipid profile 65.4%, glucose level determination 38.3%, questioning smoking 63.2%, diet recommendation 41.4% and exercise prescribing by the family physician were 44.4%.

CONCLUSIONS:

It was seen that CHD patients tried to make use of PC before their disease becomes manifest that might be mortal. So the opportunities to adjust life changes and management is vital and can be applied at PC.

Keywords: Primary health care, coronary risk factor management

OP-102

Mandala Health: transformation of habits from the cultivation and use of popular plants used as medicine

Fernando Erick Damasceno Moreira, Ubirajara José Picanço Miranda Junior, Fernando Ferreira Natal, João Ricardo Simczak Prates

Mobile emergency medical services, Federal District, Brazil

I bring here the description of a project developed in a basic health unit of the family - BFHU, in the village of West City, Goiás, Brazil. The BFHU located in a region called Village Mesquita is peculiar for its rural characteristics and african-dencendent. In this sense often is noticeable during the sessions the use of cultivated plants at home in various therapies. From this, it has become feasible to create a therapy space that brings a garden with vegetables for daily use and popular plants used as medicine. In this space, named as Health Mandala, there is the herbal cultivation brought by the community and thus it is possible, the discussion of how and why they are used, converging scientific and popular knowledge. In addition, the environment is conducive to discuss health promotion, especially with the focus on healthy eating habits.

The creation of this project came from the meetings with the group of hypertension and diabetes with members of the family healthcare team. At these meetings, the contribution of all was essential. The chosen design was based on the design garden mandala in the Brazilian Service of Support for Micro and Small Enterprises - SEBRAE, which proposes the integration of sustainable systems. The record of first impressions was made from the collection of opinions in the form of satisfaction questionnaire. The continuity of the project is motivated by the direct return of the works in the garden with the daily use of own cultivars of local culture. Project results are subjective and raised on a daily basis, allowing realize that it is possible to create an environment that enables the discussion and the transformation of habits from the cultivation and use of popular plants as medicine.

Keywords: Herb Mandala Habit

Health Mandala



Health mandala with some plants

OP-103

Hereditary Cancer: Approach by the Family Doctor

Mariana Anete Mira¹, Ana Sofia Pena¹, Ana Matos², Ana Paula Cardoso¹, Susana Rita¹

¹USF Samora Correia, ACES Estuário do Tejo, Portugal

²UCSP Benavente, Extensão Porto Alto, ACES Estuário do Tejo, Portugal

BACKGROUND & AIM: Most hereditary cancers have multifactorial origin, with the interaction of genetic and environmental factors. There are also diseases that increase the predisposition to cancer, such as Fanconi anemia, Ataxia telangiectasia, Neurofibromatosis, Tuberous Sclerosis, Von Hippel Lindau disease, Hemihypertrophy, Down Syndrome, among others. But only 5 to 10% cases of cancer have a well defined genetic transmission. Thus, the most common familial cancer syndromes are Adenomatous Polyposis of the Colon (APC), Hereditary Non-polyposis Colorectal Cancer (HNPCC), Hereditary Breast Cancer, Hereditary Ovarian Cancer, Medullary Thyroid Tumor, Li-Fraumeni Syndrome and Hereditary Diffuse Gastric Cancer.

METHOD: A detailed theoretical review of the European and American guidelines published between 2000 and 2014, for addressing these hereditary cancers was taken, as well as on the role of the family doctor in the whole process of diagnosis and monitoring of these families.

RESULTS: There are five alerts that must prompt the family physician to suspect of a familial cancer: several relatives in the first or second degree with the same type of tumor or relatable tumors, a rare form of cancer in two members of the family, a cancer beginning at a younger age than usual, bilateral tumors and synchronous or subsequent tumors. After the suspected diagnosis, the family doctor should send the family to a query of Medical Genetics and, if identified a situation of hereditary cancer, should apply prevention strategies according to the protocols already established and joint interventions in the various specialties, leading a multidisciplinary approach to these families.

CONCLUSIONS: The family physician is in a prime position to identify families at risk of these oncologic diseases, because it follows the various members of the family, with the aim of promoting health and detect the disease as early as possible, always applying possible traces.

Keywords: Hereditary cancer, American guidelines of colorectal and breast hereditary cancer, European guidelines of colorectal and breast hereditary cancer, genetic risk of cancer

OP-104

A comprehensive prevention program in Slovenia

Simona Repar Bornsek, Tonka Poplas Susic

Department of general medicine, Community Health Centre Ljubljana, Ljubljana, Slovenia

Background&AIM: Due to increasing morbidity and mortality from chronic non-communicable diseases and their complications a number of preventive programs have been implemented by developed countries in order to prevent or postpone their onset by timely lifestyle changes in people at risk.

METHODS: In 2011 in Slovenia a new concept of active screening of population on chronic non-communicable diseases was introduced. In model practices, all individuals over the age of 30 are invited to health screen. Depending on risk factors findings, they are advised on healthier lifestyle choices and changes in risky behaviour. Based on the results, each person is classified into one of 3 categories: healthy, healthy with risk factors and chronic patients.

RESULTS: In 2014, the Community Health Centre Ljubljana's 46 model practices performed 8,833 screenings, which revealed 774 new chronic patients (8.8%), 6,876 patients with risk factors (77.8%) and 1,183 patients without risk factors (13.4%). Among newly discovered chronic patients, most patients had hypertension and diabetes, followed by patients with COPD, depression and asthma.

CONCLUSIONS: Many patients do not respond to the preventive screening due to various reasons. Those with physical disability, social isolation or specific psychological problems are specially at risk for late recognition and onset of treatment. In order to reach this population, a preventive screening examination at the patient's home was implemented. The cooperation between a community nurse and a family physician team by entering the patient's home offers a better sense of the patient's living environment and habits and allows appropriate counselling on lifestyle changes in accordance with the patient's capabilities. In this way, the program of screening and early intervention can be offered to the most vulnerable groups of the population.

Disclosure: In Health Centre Ljubljana, management of patients at their home environment is a pilot project, supported by Norwegian finance mechanism program

Keywords: preventive program, screening, community nurse, at home treatment

OP-105

Determinants of Geriatric Adherence to Medications in Serse Elian City, Menoufia Governorate, Egypt

Aml Ahmed Salama¹, Abd Elrahman Abd El Fatah Yasin², Walaa Mohamed Elbarbary³

¹Lecturer of family medicine department, Faculty of medicine, Menoufia University, Egypt.

²Prof of clinical pharmacology Faculty of medicine, Menoufia University, Egypt.

³Residence of family medicine ministry of health, Egypt

BACKGROUND:

Adherence to therapies is corner stone of treatment success. Medication non adherence in geriatric patients leads to substantial worsening of disease, death and increased health care costs. A variety of factors are likely to affect adherence. Barriers to adherence could be addressed for each patient to deal with. **OBJECTIVE:** To assess the determinant factors of medication adherence in old patients live in their own houses. **METHODS:** This is a cross-sectional study. Sampling was done through systemic random sample chosen from family health records, then available elder persons included in the records were interviewed at their own homes. The study sample included (102) geriatric patients aged 70-85 years -old, living in their own homes in Serse Elian City, Menuofia Governorate. Information were collected from the prescription in the file of the patient and home visits were done to examine their daily drug consumption and their cognitive functions after their approval to participate. For each participant adherence scores were calculated based on observations of the participants' actual use of drugs and information in the prescription of the patients. Other data related to the patients demographic, functional, psychosocial and health complain were also fulfilled. The studied groups divided into adherent and non adherent to study the possible determinants of that adherence to their prescribed medication.

RESULTS: Males geriatric patients were found to be more adherent than females (64 % versus 36%). Functional complain, feeling loneliness, law perceived health, cognitive impairment and patients satisfaction of their management plane were found to be significant factors in restrict following the old patient to their prescribed drugs.

CONCLUSIONS: Medication non adherence is not a rare event in elderly patients and is associated with functional complains and cognitive impairment.

Keywords: Adherence, Geriatric, Medications

Demographic data as determinants of adherence in geriatric patients

	Group (1) Adherent Group (N=75) N (%)	Group (2) Non -Adherent Group (N=27) N (%)	Total N = 102 N (%)	X2 P value
Sex				
Male	48 (64)	11 (40.7)	59 (57.8)	4.4 0.03
Female	27 (36)	16 (59.3)	43 (42.2)	
Age				t test
Mean ± SD	74.59±3.8	73.37±3.8	73.69±3.8	1.53 0.12
Education	28 (37.3)	14 (51.9)	42(41.2)	2.48 0.47
Illiterate.	19 (25.3)	5 (18.5)	24 (23.5)	
-Primary - Secondary	16 (21.4)	6 (22.2)	22 (21.6)	
University	12 (16)	2 (7.4)	14(13.7)	
Occupation	22(29.3)		36 (35.3)	4.97 0.17
-No work	7(9.3)	14(51.8)	8 (7.8)	
-Unskilled worker	7(9.3)	1 (3.7)	8 (7.8)	
-Skilled worker -Employer	39(52)	1 (3.7)	50 (49.1)	
Socio-economic score	34(45.3)	8 (29.6)	42(41.2)	2.02 0.36
-High	15 (20)	7 (25.9)	22	
- Middle	26(34.7)	12 (44.5)	38	
- Low				

Mean of age of patients was 74.59±3.8 and 73.37±3.4 for the first group and the second group respectively. This was statistically not significant. Males constituted higher percentage of adherent group than females (64 % are male versus 36 5% females). Sex constituted statistically significant difference.. Education, occupation, living alone and socioeconomic stander constituted non significant difference in adherence of geriatric to medications.

Table (2): Patients characters as determinants of drug adherence in geriatrics:

	Group (1) Adherent Group (N =75) N (%)	Group (2) Non -Adherent Group (N=27) N (%)	Total N = 102 No (%)	X2 P value
Functional complain				
-IADL.				
⊗ Difficulty	23 (30.7)	16 (59.3)	39 (38.2)	6.87 <0.001
⊗ No difficulty	52 (69.3)	11 (40.7)	63 (62.8)	
-BADL.				
⊗ Difficulty	19 (25.3)	18 (66.7)	37 (36.3)	14.6 <0.001
⊗ No Difficulty	56 (74.7)	9 (33.3)	65 (63.7)	
				18.4 <0.001
Failed getting up	18 (24)	19 (70.4)	37 (36.3)	65 (63.7)
⊗ Yes	57 (76)	8 (29.6)		
⊗ no				
Psychosocial complains as:	4 (5.3)	4 (14.8)	8 (7.8)	2.46 (0.11)
-Depressed	71 (94.7)	23 (85.2)	94 (92.2)	
Yes				
No	9 (12)	11 (40.7)	20 (19.6)	10.4 (0.01)
	66 (88)	16 (59.3)	82 (80.4)	
-loneliness				
Yes	27 (36)	13 (48.1)	40 (39.2)	4.57 (0.03)
No	48 (64)	14 (55.1)	62 (60.8)	

-loss partner				
Yes	32 (42.7)	18 (66.7)	50 (49.1)	
No	43 (57.3)	9 (33.3)	52 (51.9)	
-law perceived health				
Yes				
No				
Health problems				
-One	27 (36)	9 (33.3)	36 (35.3)	
-Two	41 (54.7)	17 (63)	58 (56.9)	1.08 (0.58)
-Three or more	7 (9.3)	1 (3.7)	9 (8.8)	

Functional activity of the patients as Instrumental activity of daily living, Basic activity of daily living and failure in getting up constituted a highly statistically significant difference(p value <0.01) in adherence to medications Patients who had no difficulty in performing daily activity constituted higher percentage of adherent groups (69.3 %). Psychological complains as depressed mood shows no statistically significant difference (P value > 0.05) while forgetting events shows highly statistically significant difference (p value > 0.001). Number of health problem, having more than one chronic complains constituted no statistical difference among groups. Higher percentage of adherents group complains no loneliness which constituted statistically significant difference (P value < 0.05) while loss of partner shows no statistically significant difference (P value > 0.05). Sensation of law perceived health and satisfaction regarding their medication show statistically significant effect on adherence to medications (P value < 0.05)

Table (3): Person Correlation of patient's mini-mental status and adherence score to prescribed medications

Parameter	Adherence score
	r P value
Patient mini mental state	0.421 < 0.001
- Three items recall	0.138 0.168
- Clock drawing teat	

Mini mental state was measured for each patient, a score was given for each patient according to their ability to recall three word after sometime and their ability to draw a face of clock, three items recall score was positively correlated to the adherence score which constituted a statistical significant correlation while clock drawing score constituted non significant correlation to the total adherence score

Table (4): Medications parameters as determinants of adherence of geriatric patients to their medications:

	Group (1) Adherent Group (no=75)	Group (2) Non -Adherent Group (no=27)	Total No (%)	X2 p value
	No %	No %		
Price of the drug				
Cheap	14 (18.7)	7 (26)	21 (20.6)	
Faire	53 (7.2)	15 (55.5)	68 (66.7)	
Expensive	8 (0.1)	5 (12.7)	13 (12.7)	2.14 (0.34)
Number of prescribed drugs				
<=3	57 (76)	24 (88.9)	81 (79.4)	2.01 (0.15)
>3	18 (24)	3 (11.1)	21 (20.6)	
Health Insurance	39 (52)	11 (40.8)	50 (49)	3.23 (0.35)
-Governmental	11 (14.7)	8 (29.6)	19 (18.6)	
-primary care	25 (33.3)	8 (29.6)	33 (32.4)	
-private				

Medications parameters as price of the drugs, number of prescribed drugs, availability of drugs and presence of health insurance constitute no statistically significant effect on adherence to medications

OP-106

The contribution of therapeutic education in the empowerment of patient with cardiovascular disease. About an educative group intervention in South West area of France

Mélanie Afonso¹, Christine Quélier², Jean Louis Demeaux¹, Bernard Gay¹

¹Department of General Practice, Bordeaux University, Bordeaux, France

²Bordeaux School of Public Health, Bordeaux University, Bordeaux, France

Background and AIM: Many national programs have focused on the importance of therapeutic patient education in the management of chronic diseases. The need for a patient-centred approach is recognised to improve its empowerment. It's particularly true for cardiovascular diseases which are one of the leading causes of death in France with more than 180,000 deaths per year. Drug prescription alone doesn't often allow obtaining, a satisfactory impact on the health status of patients with cardiovascular risk factors. The research question is: how therapeutic education led to the empowerment of the patient? The aim is to analyse patient's abilities and to identify factors acting on empowerment.

METHOD: Qualitative study, conducted by semi-structured interviews with patients, doctors and educators involved in a series of educative group interventions conducted on the south west area of France, as part of the ETHICCAR study. Analysis of thematic content and identification of key topics.

RESULTS: The group intervention showed that the patients became aware about their power to act and their options in health. The acquisition of abilities was more various: some of them thought they had enough self-management; other had more or less difficulties daily maintaining it. The interviewed subjects suggested the need for a remote relay and express the wish for greater individualization of the care. This work also highlighted the factors limiting the participation and suggests a lack of enthusiasm for the creation of links between participants.

CONCLUSIONS: Therapeutic patient education seems a good initiative and increases the patients' confidence of their power to act. Further work will be necessary, in particular, around the concept of participation in order to let the patient ultimately achieving, empowerment to both individual, organizational and community levels.

Keywords: therapeutic education, empowerment, cardiovascular disease

OP-107

Effectiveness of seasonal influenza vaccination in diabetic patients: Systematic review

Ludovic Casanova¹, Patrick Villani², Pierre Verger³

¹Aix Marseille University, Department of general practice, Marseille, France

²Aix Marseille University, UMR_S912, IRD, 13006, Marseille, France

³INSERM, UMR912 "Economics and Social Sciences Applied to Health & Analysis of Medical Information" (SESSTIM), 13006, Marseille, France

Aims

The influenza virus is a major cause of morbidity and mortality in diabetic patients. The immunological effectiveness of seasonal influenza vaccination has been demonstrated in patients with diabetes type 1 and 2. However, diabetes is the only remaining major comorbidity not have a systematic literature review or meta-analysis on the efficacy of vaccination in terms of morbidity and mortality.

Methods

Systematic literature review about the effectiveness of seasonal influenza vaccination in diabetics respecting the PRISMA Statement. PUBMED and EMBASE databases were searched using the following equation: ("influenza vaccines" [MeSH Terms] OR "Influenza, Human" [MeSH Terms]) AND ("diabetes mellitus" [MeSH Terms] OR "diabetes" [All Fields]). According to the PICO process, the study populations should be composed of diabetics, intervention was seasonal influenza vaccination only, all types of design and all morbidity and mortality outcomes were retained.

Results

Two reviewers selected 120 articles with the title, 34 articles with the abstract to include nine studies in this literature review. There were 7 cohort studies, two case-control studies and no randomized clinical trial. Beyond the small number of studies found, we targeted three common boundaries to all studies: the use of direct criteria of judgement, bias vaccination (a priori difference of subjects choosing to vaccinate) and the absence of adjustment regarding the anti-vaccination pneumococci which shares the same clinical picture as influenza. The most recent study found differences in morbidity and mortality between the groups vaccinated and unvaccinated outside the epidemic period revealing the methodological limitations inherent in all observational studies.

Conclusion

To date there is no evidence of efficacy of seasonal influenza vaccination in diabetics and even less in diabetic subjects under 65 years.

Keywords: diabetes mellitus influenza vaccine Review

OP-108

Dengue notifications from emergency service

Gustavo Aguiar Alvarenga Amorim, Bianka De Oliveira Silva, Danielle Pulcinelli

Universidade Federal de Goiás

The Brazilian summer not only means beaches, but also an endemic dengue's period when there is an ascending notification number, although an incomplete or inefficient anamnesis provides unreal notifications.

The aim of this project was to classify the risk of the patients referred from the emergency service to the Family Medicine service in CAIS Jardim Guanabara III, Goiânia Goiás, Brazil; stratify the main differential diagnosis and question the notifications number veracity.

During the internship hosted in CAIS Jardim Guanabara III, from February, 2nd until March, 6th the students helped by their staff analyse the medical records.

In February 11 people was referred from de Emergency service, 63,64% were really dengue, 9,09 % acute gastroenteritis 9,09% urinary tract infection, 9,09% upper airway cough syndrome (UACS) and 9,09% follow up lost. During March first week, there were 8 notifications, 50,0% were dengue, 25,0% acute gastroenteritis, 12,5% urinary tract infection, 12,5% upper airway cough syndrome (UACS), and no follow up lost. The most commons symptoms were, by order, headache, myalgia, nausea, itch and retro-orbital pain. For the other the most commons symptoms were headache, fever, myalgia. The 8 patients really diagnosed with dengue were stratified: 66,68 group A; 16,66% as B; 16,66% C, zero D.

In conclusion, it is presumed that the dengue cases rates are higher in March and that those patients who did not attend the service are not dengue cases because they would not feel well without proper management. Therefore, there is a huge number of misdiagnosis in the emergency service, so is important so think if are the notification numbers provided to the prevention strategies real, there are notifications that are not dengue cases in the other hand there are also places were the notification are not fulfilled.

Keywords: dengue; notification; anamnesis

OP-109

The extent to which lifestyle and health behaviours of General Practitioners in the west of Ireland influences Health Promotion practices with their patients

Thomas Walsh, Pamela Healy, Aisling Egan, Maureen Kelly

, Western General Practice scheme, HSE West, Ireland

INTRODUCTION:

Doctors' health is important and can potentially impact on the health of patients.

Doctors practicing healthy behaviours counsel patients more frequently and effectively and serve as credible health role models. The aim of this study is to establish the lifestyle and health behaviours of GP's, their health promotion practices and determine if there is a relationship between the two.

Methods

This study is an anonymous, quantitative cross-sectional postal survey. Data were analysed using Gnu-PSPP.

Results

N= 91, 33% response rate. 75% (n=68) of GP's report they are in good health.

59% (n=54) comply with WHO recommendations for exercise. 5% (n=4) are current smokers, while alcohol is consumed on average 7 days per month. Only 59% (n=54) have their own GP and 62% (n= 56) receive the flu vaccine. 95% (n= 86) rate preventive counselling as important, with the majority of GP's counselling patients

about diet 82% (n= 75), exercise 78% (n= 71), and smoking cessation 81% (n= 74) daily.

GP's report high levels of confidence in their counselling practices. Up to 82% feel that their own behaviours impact on preventive counselling. As the BMI of GPs increases, the frequency of diet counselling decreases, $p=0.035$. Common barriers to health promotion were lack of time, compensation and patient interest.

Conclusions

GPs perceive themselves to be healthy, data suggests here is scope for improvement in GPs' self-care.

Most GPs believe preventive counselling is important.

GPs perceive that self behavior impacted strongly on their counselling practices.

GPs are confident in their ability to counsel patients and do so frequently.

Significant barriers to health promotion exist which need to be addressed to improve patient care.

Keywords: Health Promotion, General Practitioners

OP-110

Problems of Turkish Speaking Community In Accessing Healthcare in the UK

Cemal Kavasogullari¹, Ulvan Ozad⁴, Can Hazar³, Isabella Roiatti²

¹NHS Education Scotland

²NHS Lanarkshire

³Turkish Cypriot Healthcare Professionals Association

⁴Anglo-Turkish Healthcare Professionals Association

Background and Aim

There is a large Turkish speaking community (TSC) in the United Kingdom (UK) with estimated numbers ranging from 120.00 to 400.000. TSC has a diverse socioeconomic background ranging from refugees to pensioners with majority belonging to the low socioeconomic status. It is well documented that minorities or ethnic communities in the UK are less likely to have access to healthcare services or are worse at utilizing available healthcare resources compared to the native population. Various studies shown that TSC in the UK also belongs to this underserved group adversely affecting their health and wellbeing. With this review we aim to summarize the literature focusing on TSC in order to identify underlying common themes.

Method

Literature review. Research from year 2000 and onwards conducted in the UK has been extracted from online resources. 11 articles focusing on TSC and 36 articles on general ethnic and minority health has been identified and included in the review.

Results and CONCLUSIONS:

All research conducted on TSC in the UK unanimously conclude that TSC is disadvantaged in both accessing and utilizing NHS services. Language is expressed recurrently as an important barrier restricting access to healthcare. In a study conducted on the global inhaler technique, coordination and breathing was worse in Turkish speakers with poor English as only 17% had an adequate technique. In a stop smoking study, campaigns produced in Turkish language was found to be more effective in reducing smoking by 6.4%. There is a high demand for interpretation services among TSC during consultations creating a strain in limited NHS resources. Low socioeconomic class, inadequate access to healthcare services, worse physical well-being and poor integration of community are factors adversely affecting the quality of life of the TSC. Further research looking into ways of tackling these factors are required urgently.

Keywords: Turkish speaking community in the UK, ethnic health, problems in accessing healthcare

OP-111

What is the Health literacy of Students who entered for Medicine and Nursery Faculty in Dokuz Eylul University?

Candan Kendir Copurlar, Mehtap Kartal, Kürsad Akkaya, Inan Arslantas
Department of Family Medicine, Dokuz Eylul University, Izmir, Turkey

AIM: Health literacy (HL) is the degree of a person to gather, understand and interpret health information appropriately to improve personal health. It consists of understanding of prescriptions, chronic disease management, analytical decision making and usage of health system appropriately. According to data of "European Project", where Health Literacy Scale-European was used, adequate HL level in Turkey is %30.4. "National Action Plan to Improve Health Literacy", prepared in USA in 2013, emphasize the importance of health education of adolescents to increase HL in adulthood. This study aimed to determine HL levels of students who apply to medicine and nursery faculty in Dokuz Eylul University (DEU).

METHODS: This cross-sectional study was conducted in DEU in Izmir, Turkey. Participants were 585 students who applied to medical and nursery faculty in September, 2014. Response rate was 88% (n=515). REALM (Rapid Estimation of Adult Literacy Measurement) and NVS (Newest Vital Sign) tests, validated for Turkish by Ozdemir et al., were used and in addition to sociodemographic questionnaire and General Health Scale (GHS).

RESULTS: Of the participants 63.7% were female, 52% were starting medical faculty. The mean score of all participants for REALM, NVS were 61.2±3.2; 3.4±1.6, respectively. According to GHS, 7.5% of students had high risk for psychiatric disorder. According to REALM scale, 36.4% of the participants had limited HL while according to NVS scale, 30.2% had limited HL and 15.0% had inadequate HL. While REALM scores were higher in nursery students, NVS scores were higher in medical students.

CONCLUSION: In Turkey only limited number of studies defined HL and as known this is the first study focused on adolescents who will be future physicians and nurses. More studies should focus on HL of adolescents and more health promotion attempts should be done to increase HL in adolescent age for healthier adults in future.

Keywords: health literacy, adolescents, health promotion

Table 1.

	number	%
Faculty	Medicine 268	52,0
	Nusery 247	48,0
Gender	Male 187	36,3
	Female 328	63,7
Working/ Not working	Not working 511	99,2
	Working 4	0,8
Chronic Disease (n:514)	No 494	96,1
	Yes 20	3,9
Drug administration for chronic disease	No 499	96,9
	Yes 16	3,1
Hospitalization	Never 355	69,2
	Once 110	21,4
	Twice 31	6,0
	Three times and more 17	3,3
Administration for health service in a month	Once 410	87,8
	Twice 42	9,0

Three times	6	1,3
Four times and more	9	1,9

sociodemographic datas and usage of health services

Table 2.

		number	%
GSA (n:508)	<2	423	83,3
	2-3	47	9,3
	>3	38	7,5
REALM (n: 514)	45-60	187	36,4
	61-66	327	63,6
NVS (n: 420)	0-1	63	15,0
	2-3	127	30,2
	4-6	430	54,8

scores of scales

OP-112

Knowledge, attitudes and behaviors about breast self examination and mammography among female primary healthcare workers in Diyarbakır, Turkey

Ozgun Erdem¹, Izzettin Toktas², Kevser Ates Cigdem², Murat Koc³

¹Kayapınar Family Health Center Number 9, Diyarbakır, Turkey

²Kayapınar Society Health Center, Diyarbakır, Turkey

³Public Health Manager, Diyarbakır, Turkey

AIM: This study aims to determine the knowledge level of the female primary healthcare workers about breast cancer and to reveal their attitude and behaviors about breast self examination and mammography.

METHOD:

This cross-sectional study was conducted among female primary healthcare workers who work in family health centre. There were 407 female health professionals as the study population. Potential participants were informed verbal by phone and also nominally by e-mail about the aims of the study and then asked if they would agree to participate. The online questionnaire form was sent to all of the female primary healthcare workers. 91% (n=369) of female primary healthcare workers agreed to participate. The questionnaire consisted of three parts: socio-demographic characteristics, knowledge about breast self examination, and actual practice of breast self examination. SPSS for Windows Version 21.0 Statistical package was used in data analysis.

RESULTS:

The mean (SD) age of the female primary healthcare workers was 33,1 ± 6,8 (range, 20- 54 years). The other socio-demographic parameters are showed at table 1. There is a low correlation between age and knowledge level of healthcare workers r=0,144 (p=.005). The healthcare workers who practiced breast self examination had significantly higher knowledge level (p=.001) than those who had not (table 2). The respondents had high knowledge level of breast self examination; however, the knowledge level of breast cancer and mammography screen was low (table 3).

CONCLUSIONS: While the female primary healthcare workers in this study had adequate knowledge of breast self examination, this is not reflected in their attitudes and practices. The knowledge level and attitude of healthcare workers are important factors in the control of breast cancer. Emphasis should be laid on breast self examination in undergraduate and postgraduate courses for primary healthcare workers, as they are mostly involved in patient education.

Keywords: Breast self examination, Primary healthcare workers, Knowledge

Table 1. Sociodemographic characteristics of female primer healthcare workers according to knowledge level

	n	%	Median (Min –Max)	p*
Profession				
Midwife	181	49,1	9 (1-15)	0,026
Nurse	112	30,4		
Doctor	57	15,4		
Other	19	5,1		
Educational status				
High school	106	28,7	9 (1-15)	0,018
University	263	71,3	9 (1-15)	
Marital status				
Married	261	70,7	9 (1-15)	0,559
Single	108	29,3	9 (1-15)	
Age				
20-39 Y	303	82,8	9 (1-15)	0,234
>40 Y	63	17,2	9 (4-15)	
Experience of Professional				
<10 year	189	51,5	9 (2-15)	0,095
>10 year	178	48,5	9,5 (1-15)	
Personal history of breast problems				
Yes	32	8,7	9 (5-14)	0,796
No	334	91,3	9 (1-15)	
First degree relatives history of breast cancer				
Yes	7	1,9	11 (6-13)	0,796
No	358	98,1	9 (1-15)	
Second degree relatives history of breast cancer				
Yes	47	12,9	9 (5-15)	0,699
No	318	87,1	9 (1-15)	
Is your menstrual period regular?				
Yes	290	86,8	9 (2-15)	0,227
No	44	13,2	9 (2-14)	

* Significance for comparison performed by the Mann-Whitney U test (to compare 2 groups) or the Kruskal-Wallis H test (to compare >2 groups).

Table 2. Attitude and practice of female primer healthcare workers in BSE* according to knowledge level

	n	%	Median (Min –Max)	p**
Did you ever perform BSE?				
Yes	339	92,6	9 (2-15)	0,001
No	27	7,4	6 (1-14)	

How often do you perform BSE?				
Once in my life	16	4,8	10 (3-14)	0,197
Sometimes/When it comes to mind	218	65,1	9 (2-15)	
Regularly, every month	101	30,1	10 (5-15)	
When did you start BSE?				
<20 Age	32	10,1	9 (5-13)	0,363
20 Age	43	13,6	9 (4-14)	
>20 Age	242	76,3	9 (2-15)	
When do you perform BSE?				
Pre-menstruation	16	4,8	8 (4-12)	0,001
During menstruation	13	3,9	9 (6-13)	
Post-menstruation	268	81,0	10 (4-15)	
When there is a complaint	26	7,9	8 (2-12)	
Other	8	2,4	9 (3-11)	
Why did not you perform BSE?				
Absence of any symptoms	16	66,6	6,5 (1-12)	0,877
Anxiety	3	12,5	6 (6-12)	
Negative family history of breast cancer	4	16,7	6 (3-14)	
Other	1	4,2	9	
Have you ever had breast exam by a doctor?				
Yes	99	27,2	9 (4-15)	0,309
No	265	72,8	9 (1-15)	
Have you ever had screening mammography? (>40 Age)				
Yes	22	34,9	10 (4-14)	0,833
No	41	65,1	9 (5-15)	

* BSE: Breast Self Examination ** Significance for comparison performed by the Mann-Whitney U test (to compare 2 groups) or the Kruskal-Wallis H test (to compare >2 groups).

Table 3. The female primer healthcare workers' correct answers about knowledge of BSE*, breast cancer, and mammography

The questions about BSE	The ratio of correct answers	
	n	%
At what age should women start BSE?	184	49,9
How often a woman should do BSE?	323	87,5
Corralate with menstruation, When should BSE be done?	332	90,0
After menopause, when should BSE be done?	254	68,8
What is the most appropriate manual technique when doing BSE?	312	84,6
Proper technique for BSE knowing the right technique for BSE	340	92,1
How many minutes should spend to each breast when practise BSE?	137	37,1
What is the prevalance of breast cancer, currently?	104	28,2

In which age group the breast cancer is occurs more often?	188	50,9
In which quadrant the breast cancer is occurs most often?	166	45,0
Which type of nipple discharge should thought breast cancer?	171	46,3
At what age should women start mammography screening?	252	68,3
How often should women do mammography screening?	140	37,9

*BSE: Breast Self Examination

OP-113

Prevalence of condom utilization by female prostitutes in STD-HIV Comprehensive Clinic of Primary Health Service of Kosambi, Tangerang, Indonesia

Fika Ekayanti¹, Suherman Suherman², Risahmawati Tholib¹, Marita Fadhillah¹, Ayu Indriyani Munggaran¹, Dahniar Anindya¹, Fernaldi Angghada¹, Khoiron Muhsinin Putra¹, Sheila Inayatullah¹

¹Department of Community Medicine, State Islamic University of Syarif Hidayatullah, Jakarta, Indonesia

²Puskesmas Kosambi, Health Department of Tangerang District, Banten, Indonesia

Background and Aim

Sexually transmitted disease (STD) has set as the top ten reason of encounter in developing country. Condom utilization for preventing STD, is one of the community package program that was held by the ministry of health in Indonesia. The study aimed to describe the prevalence of condom utilization by female prostitutes within a previous week and the incident of STD's symptom.

Method

The cross sectional survey was conducted between Augusts to October 2014 in the STD-HIV Comprehensive Clinic of Primary Health Service of Kosambi, Tangerang, Indonesia. There were 95 samples that were selected by simple random sampling from the medical record of female prostitutes that worked in the prostitution area of Kosambi. Ten respondents was interviewed to identify their reason for using condoms.

Results

Age of respondents mostly were 18 years old (15 persons; 15.8%) and 14 persons (14.8%) were aged under 18. The level of education mostly in junior high school (60%). There were 36.8% of female prostitutes who always had their client used condoms, while 36.8% were seldom and 26.4% were not used it at all. From 95 respondents, 39 respondents (41.1%) had STDs. They were only 23% respondents who always use condoms, 41% seldom, and 36% never use condoms. The reason of interviewees to use condoms were afraid of getting sick (30% who always use condoms), forget or has got the medicine (30% who seldom use condoms), reduce the sexual excitement (40% who never use condoms).

Conclusion

The awareness of female prostitutes about the importance for using condoms were still low. It needs continuous intervention from health providers to gain attention from the high risk community in order to reduce STD incidences.

Keywords: Sexually Transmitted Disease (STD), condom, female prostitute.

Distribution of age of female prostitutes

Age of respondent (years old)	Volume (person)	Percentage (%)
15	1	1.1
16	6	6.3
17	7	7.4
18	15	15.8
19	6	6.3
20	7	7.4
21	9	9.5
22	4	4.2
23	6	6.3
24	7	7.4
25	3	3.2
26	4	4.2
27	4	4.2
28	5	5.3
29	4	4.2
30	2	2.1
31	2	2.1
33	1	1.1
37	2	2.1
Total	95	100

Distribution of educational level of female prostitutes

Level of Education	Volume (person)	Percentage (%)
Elementary School	23	24.2
Junior High School	57	60.0
Senior High School	15	15.8
Total	95	100

Condom Utilization

Condom utilization	Volume (person)	Percentage (%)
Always	35	36.8
Seldom	35	36.8
Never	25	26.4
Total	95	100

OP-114

Recognition of Core Elements of Medical Professionalism among Medical Students and Faculty Members

Firdous Jahan¹, Muhammad A Siddiqui²

¹Department of Family Medicine, Oman medical college sohar oman

²School of Health Sciences, Queen Margaret University, Edinburgh, UK

Background & Aims

The goal of the medical profession is to provide best care for the patients. Teachers' professional attitude effects the learner as they see their role models behavior and they follow the same. There are various factors contributing to professionalism which may allow the development of more effective approaches in promoting the quality of medical education. The aim of this study was to recognize core element of professionalism in medical students and faculty and to compare students' and faculty perception regarding professionalism.

Methods

The study comprised of a questionnaire survey of 109 students (44 Pre-clinical 5th year and 65 clinical 7th year) and 83 faculty members (17 basic sciences and 66 clinical) at Oman Medical College. Participants were invited for self-filled survey questionnaire in which core elements were divided - professional knowledge, professional skills and professional attitude and qualities essential for professionalism. Statistical analysis was performed using SPSS 20.v. Data were expressed in frequencies and percentages. Chi-square and Mann-Whitney U tests were used for comparative analysis.

Results

Response rate were 65.6% (109 of 166) among students and 75% (83 of 110) from faculty members. Response of professional skills and attitude among the student and faculty group was significantly different ($p < 0.001$). Updated knowledge and clinical competency response was appeared to be related in students' and faculty members ($p < 0.02$) and clinical and basic sciences faculty ($p < 0.001$). Students identified good communication skills (82.6%) and faculty staff identified updated professional knowledge (62.7%) as the single most important aspect of professionalism.

Conclusion

Both students and teaching faculty agreed that the top most professional elements are updated knowledge, good communication skills, and team work. However, faculty members need to encourage their students to improve their professional skills and attitude.

Keywords: Professionalism, medical students, faculty

OP-115

An Audit of Vaccination Status in a Cohort of Elderly Home Care Patients in Ankara, Turkey

Doğukan Doğruel¹, Mustafa Arslan Bircan², Münevver Tulunay³, Nisa Solmaz⁴, Feyza Çelik⁵, Cenk Aypak⁶, Hülya Yıkılkan⁷, Derya İren Akbıyık⁸, Süleyman Görpelioğlu⁹

¹Doğukan Doğruel

²Mustafa Arslan Bircan

³Münevver Tulunay

⁴Nisa Solmaz

⁵Feyza Çelik

⁶Cenk Aypak

⁷Hülya Yıkılkan

⁸Derya İren Akbıyık

⁹Süleyman Görpelioğlu

AN AUDIT OF VACCINATION STATUS IN A COHORT OF ELDERLY HOME CARE PATIENTS IN ANKARA, TURKEY

Doğukan DOĞRUEL¹, Mustafa Arslan BİRCAN¹, Münevver TULUNAY¹, Nisa SOLMAZ¹, Feyza ÇELİK¹, Cenk AYPAK¹, Hülya YIKILKAN¹, Derya İREN AKBİYİK¹, Süleyman GÖRPELİOĞLU¹

Dışkapı Yıldırım Beyazıt Training and Research Hospital, Family Practice Clinic

Aim

Vaccinations against influenza, pneumonia and tetanus reduce morbidity and mortality among older adults. We examined vaccination rates among elderly home-care patients.

Methods

This study is a quantitative data analysis with a cross-sectional design, comprising 212 patients aged 65 and older enrolled in Home Care Unit of Dışkapı Yıldırım Beyazıt Training and Research Hospital, Ankara, Turkey. Vaccination status were recorded by telephone interviews with the patients themselves or their caregivers.

Results

A total of 152 (71.7%) women, and 60 men (28.3%) were enrolled in study. The mean age of the patients was 80.1±6,7 years. Functional status of those patients were found to be: 77 (36.3%) dependent, 107 (50.5%) half-dependent, 26 (12.3) non dependent. The most prevalent chronic diseases were diabetes mellitus (30.7%), cardiovascular diseases (28.3%), chronic obstructive pulmonary disease (17%) and chronic renal disease (5.7%) respectively. Regular seasonal influenza vaccination rate in the last 3 years was 10.4%. One hundred sixty (75.4%) patients were not vaccinated against seasonal influenza in the last three years. There were only 7 patients who were vaccinated against pneumonia and 1 patient against tetanus. The most frequent reasons of not receiving vaccination include unawareness (57%), thinking it is not necessary (10.8), economic burden (%3.8) and concerns about side effects (2.4%).

Conclusions

Our have revealed that elderly patients and their family care givers do not have sufficient knowledge about immunization. Recognizing patterns of and barriers to immunization could have important consequences for health policy in home- care settings.

Key Words

Immunization, home care service, elderly

Keywords: Immunization, home care service, elderly

OP-116

Typology of general practitioners regarding their attitudes toward vaccination. Lessons from DIVA, a self-reported questionnaire

Luc Martinez¹, Fatoumata Fofana², François Raineri¹, Didier Duhot¹, Jean Luc Gallais¹, Guillaume Coindard¹, Didier Seyler¹, Benoit Arnould², Khadra Benmejahed², Béatrice Tugaut², François Denis³, Pascale Arnould¹

¹French Society of General Medicine

²Mapi, Lyon, France

³Department of Bacteriology and Virology, University Hospital, Limoges, France

Background & AIM: There is a gap between the vaccine coverage rate recommended and that achieved. General practitioners (GPs) play a key role in involving their patients into vaccination. This cross-sectional study aimed at creating a typology of GPs regarding their engagement in vaccination.

METHOD: We conducted an online survey among 9000 GPs registered in the mailing list of the French Society of General Medicine. GPs who agreed to participate filled in a form collecting their socioprofessional data. They were asked to complete the DIVA questionnaire for any of the disease they were assigned randomly (Tetanus, Pertussis, Measles, seasonal Influenza, Human Papilloma Virus infection or Pneumococcus infection). The DIVA questionnaire comprised 56 items divided into 7 domains (Disease characteristics and expected benefits, Vaccine properties, Information about vaccination, Practical and organizational aspects of vaccination, Adaptation to consultation context, GPs' individual experience and Engagement of the GP in vaccination). We conducted a three stages analysis: 1/multiple correspondence analysis on raw data; 2/ K-mean cluster analysis; 3/ hierarchical clustering on the first 20 clusters

RESULTS: The 1069 respondents were partitioned into 4 clusters according to their attitudes toward vaccination (very favourable, favourable, somewhat favourable and unfavourable). There was a decrease in domains' scores across the 4 clusters. GPs very favourable to vaccination (n=191) showed the highest scores for the 7 domains. Information about vaccination and GPs' individual experience act against vaccination among GPs unfavourable to vaccination (n=82). Disease characteristics and expected benefits favoured vaccination among GPs of the two intermediate clusters (favourable and somewhat favourable; n=796).

CONCLUSIONS: GPs who are very favourable to vaccination will remain favourable. GPs who are unfavourable are the most difficult to convince because their reluctance to vaccination relies more on belief than on evidence. Medical education should preferably target the two other clusters

Keywords: Vaccination, Attitude, General Practice, Physician's Practice Patterns, Questionnaires, Cluster Analysis

OP-117

Compliance of patients to recommendations of life-style changes related with cardiac risk factors: A multicentered cross-sectional study

Arzu Ayraller¹, Hülya Akan², Özlem Tanrıöver², Osman Hayran³

¹Public Health Institution of Turkey, Integrated Public Hospital, Sivas, Turkey

²Department of Family Medicine, Yeditepe University School of Medicine, İstanbul, Turkey

³Department of Public Health, Medipol University School of Medicine, İstanbul, Turkey

AIM: The aim of the study was to examine if the patients admitted to family health centers had any recommendations or counseling about cardiac risk factors before and if they had any whether they had complied to the recommendations.

METHODS: The study was conducted among adult patients admitted to randomly selected five different family health centers in İstanbul, Turkey. All patients included in the study completed a face-to-face questionnaire composed of socio-demographic variables, previous education or counseling about exercise, smoking cessation, healthy diet, hypertension, diabetic or cholesterol lowering diet, and compliance to these recommendations. Weight and length have been measured by family health doctors during out patient examination.

RESULTS: Total 948 patients, 672 women (70.9%) and 276 men (29.1%) were included in the study. Mean age was 42.64±14.35. Although high percentage of the patients declared that they had recommendation about cardiac risk factors at least once; the compliance rate of patients generally was low. The percentage of patients that had education/counseling was lower than patients that had taken only recommendation. In all sub groups, compliance was higher in patients that had recommendation and education/counseling compared to only recommendation or no recommendation at all (p<0.05). Table 1 and 2 show taking recommendation or counseling/education and compliance status both in general study population and also regarding established diagnosis regardingly.

CONCLUSION: In general, number of patients having recommendations regarding life-style changes is low in primary care even in specific diagnostic groups. The number of patients having counseling/education are even lower although it is clear that only recommendation is enough to make a life-style change; counseling and education increase the compliance of patients.

Keywords: Cardiovascular diseases, cardiovascular risk factors, life-style changes, patient compliance

Table 1: Patients who have taken recommendation and counseling/education against cardiovascular risk factors and status of compliance

	Recommendation Number (percentage) N=948	Education /Counseling Number (percentage) N=948	Compliance N (%) N=948
Exercise Yes	397 (41.9)	179 (18.9)	198(20.9)
Smoking cessation Yes	211 (22.3)	87 (9.2)	81 (8.5)
Weight reduction Yes	198 (20.9)	101 (10.7)	86 (9.1)
Anti-Diabetic diet Yes	142 (15.0)	102 (10.8)	91 (9.6)
Cholesterol lowering diet Yes	117 (12.3)	86 (9.1)	99 (10.4)
Anti-Hypertensive diet Yes	101(10.7)	68 (7.2)	63 (6.6)

Table 2: Patients who have taken recommendation and counseling/education against cardiovascular risk factors and status of compliance regarding specific diagnosis

	Recommendation Number (percentage)	Education /Counseling Number (percentage)	Compliance N (%)
Hypertension n=217			
Regular exercise	129 (59.4)	55 (25.3)	43 (19.8)
Cigarette cessation	39 (17.9)	19(8.8)	21(9.7)
Weight reduction	56 (25.8)	37 (17.0)	19 (8.8)
Anti-Hypertensive diet	83(38.2)	55 (25.3)	52(23.9)
Diabetes n=172			
Regular exercise	110 (63.9)	47 (27.3)	42 (24.4)
Smoking cessation	40 (23.3)	19 (11.0)	21 (12.2)
Weight reduction	56 (32.6)	34 (19.8)	19 (11.0)
Anti-Diabetic diet	109 (63.4)	73 (42.4)	70 (40.7)
Obesity N=130			
Regular exercise	72 (55.4)	32 (24.6)	25 (19.2)
Smoking cessation	35 (26.9)	19 (14.6)	19 (14.6)
Weight reduction	68 (52.3)	32 (24.6)	25 (19.2)
Hypercholesterolemia N=148			
Regular exercise	94 (63.5)	36 (24.3)	17 (12.9)
Smoking cessation	37 (25.0)	16 (10.8)	18 (12.1)
Cholesterol lowering diet	77 (52.0)	53 (35.8)	66 (44.6)

OP-118

Barriers to the provision of smoking cessation assistance: a qualitative study among Romanian family physicians

Catalina Panaitescu¹, Mandy Moffat², Sian Williams³, Hilary Pinnock⁴, Melinda Boros⁵, Cristian Sever Oana¹, Sandra Adalgiza Alexiu¹, Ioanna Tsiligianni⁶

¹Family Medicine Solo Practice, Bucharest, Romania

²Division of Medical and Dental Education, University of Aberdeen, Aberdeen, UK

³International Primary Care Respiratory Group, London, UK

⁴Allergy and Respiratory Research Group, Centre for Population Health Sciences, University of Edinburgh, Edinburgh, UK

⁵Psychotherapy Solo Practice, Bucharest, Romania

⁶Agia Barbara Health Care Centre, Crete, Greece, Department of General Practice, University Medical Centre Groningen, University of Groningen, Groningen, The Netherlands

BACKGROUND:

Smoking cessation is the most effective intervention to prevent and slow down the progression of several respiratory and other diseases and improve patient outcomes. Romania has legislation and a national tobacco control programme in line with the World Health Organization Framework for Tobacco Control. However, few smokers are advised to quit by their family physicians (FPs).

AIM:

To identify and explore the perceived barriers that prevent Romanian FPs from engaging in smoking cessation with patients.

METHODS:

A qualitative study was undertaken. A total of 41 FPs were recruited purposively from Bucharest and rural areas within 600 km of the city. Ten FPs took part in a focus group and 31 participated in semistructured interviews. Analysis was descriptive, inductive and themed, according to the barriers experienced.

RESULTS:

Five main barriers were identified: limited perceived role for FPs; lack of time during consultations; past experience and presence of disincentives; patients' inability to afford medication; and lack of training in smoking cessation skills. Overarching these specific barriers were key themes of a medical and societal hierarchy, which undermined the FP role, stretched resources and constrained care.

CONCLUSIONS:

Many of the barriers described by the Romanian FPs reflected universally recognised challenges to the provision of smoking cessation advice. The context of a relatively hierarchical health-care system and limitations of time and resources exacerbated many of the problems and created new barriers that will need to be addressed if Romania is to achieve the aims of its National Programme Against Tobacco Consumption.

Keywords: smoking cessation, qualitative study, family physicians, barriers, health system influences, Romania, Framework for Tobacco Control

OP-119**Relationship of Decisional Balance and Self-efficacy in Obese and Overweight Patients in Dokuz Eylul University Faculty of Medicine in Izmir in Turkey**

Tugba Onat, Dilek Guldal

Department of family medicine, Dokuz Eylul University, Izmir, Turkey

In order to prevent obesity, it is crucial to change behaviors of eating and exercising. The process of changing behavior is difficult and various health belief models are used to explain the process. One of the widely used models, Transtheoretical Model (TTM), identifies the changing process through five steps: pre-intention, intention, preparation, action and maintenance, assuming increasing in self-efficacy and decisional balance in every step. Our study aims to investigate the relationship between stage of change with self-efficacy and decisional balance.

METHOD:

Our cross-sectional analytic study was done among adult individuals who had a Body Mass Index of 25 or higher. Besides the stage of change of the participants and demographic features, all participants received self-efficacy and decisional balance scales.

The data analyzed in SPSS 15 program and descriptive analysis, chi square, student-t and correlation tests are applied.

RESULTS

The ratio of people in action stage were higher among the women and among the ones who exercise than men and people who do not exercise ($p=0.000$, $p=0.032$); and no relationship with educational level, employment status, smoking, alcohol consumption or comorbidity diseases were found. A significant relationship was found between stage of change of participants and self-efficacy and decisional balance. It was found out that the ones who are in action stage have higher self-efficacy scores than the ones who are in intention and pre-intention stages ($p=0.000$); also negative scores in decisional balance are higher with the ones who are at pre-intention stage ($p=0.000$), and the positive scores are higher with the ones at action stage ($p=0.030$).

CONCLUSION:

A significant relationship was identified between the action stage of obese people with positive decisional balance and a high level of self-efficacy. This conclusion must be taking into account for any possible intervention.

Keywords: obesity self efficacy decisional balance stage of change

OP-120

Knowledge, Attitudes and Behaviors of Primary Care Clinicians About Periodic Health Examination Issues in Primary Health Care

Sinem Aydemir, Altuğ Kut, Fisun Sözen, Gökhan Eminsoy, Zeliha Özbakır
Department of Family Medicine, Baskent University, Ankara, Turkey

AIM: The goal of periodical health examination (PHE) is decreasing mortality and morbidity rates of people by identifying their risk factors and early symptoms of their curable diseases when they are asymptomatic. Family physicians have an important role with health counseling and early diagnosis of diseases due to their significant position in the primary care practice. There were no comprehensive study in Turkey to evaluate the knowledge, attitude and behavior of primary care clinicians in our country regarding PHE. The purpose of this study is to identify the knowledge, attitudes and behaviors of primary care clinicians about PHE.

METHOD: A stratified sampling method was used to select 629 family physicians from 7 geographical regions of Turkey. A questionnaire consisted of 29-questions was administered to family physicians to evaluate descriptive features, knowledge, attitudes and behaviors of primary care clinicians.

RESULTS: The mean age of family physicians was $41,91 \pm 7,81$ (27-66), 58,2% were men, 87,6% were married, 82,5% had at least one child. 19,4% of family physicians were family physicians specialist. 37,4% of them stated that they were educated about PHE and 55,3% of them have practiced PHE to the patients. PHE practice ratio was 4 times more in family physician specialist than others. When evaluating total knowledge, attitude and behavior questions family physicians in the Marmara region significantly gave correct answers than family physicians in the other regions. According to the logistic regression analysis, the only significant factor affecting the status of periodic health examination practice was being family medicine specialist.

CONCLUSION: According to the data gathered, family physician specialist had better knowledge, attitudes and behaviors than other family physicians. Supporting all family physicians, specialist or not, with screening tools which are standardized and relevant to community health needs, would ease performing PHE and make the primary care services better and sustainable.

Keywords: Periodic Health Examination, Primary Care Clinicians, Screening Guide

OP-121

Development counselling services on healthy nutrition and physical activity for primary health care workers in combating obesity

Nazan Yardım, Sabahattin Kocadağ

Public Health Institution, Ministry of Health

Turkey Nutrition and Health Survey was conducted by our Ministry (2010) the prevalence of obesity has been found 30.3% and 20.5 % in male and 41% in women over the 19 years old. Development of national action programs is recommended by WHO for prevention and control of NCDs.

One of the areas of intervention area is to take the necessary measures in primary health care services in Turkey Healthy Nutrition and Physical Activity Program (THNPA). In this context, a guideline has been developed for family physicians. In line with aim is to raise awareness of family doctors; to give consultancy about on healthy nutrition and physical activity by family health staff to the obese and overweight patients and also to contribute to the development of healthy eating habits.

A guideline was prepared for family physicians according to the THNPA Program by MoH. and distributed to all family physician. Information brochures were prepared in the basis the guideline to help them and family health staff. A inservice training will hold for family health stuff in the province by public health center.

Family health staff will make patient's height, weight, BMI and waist circumference and will be entered into the database before meeting with family physician; They will query dietary habits and physical activity status and will refer to the family physician.

Family physician will give walking program and healthy eating advice through out obesity and cardiovascular disease if not in the referral criteria according to the family physician guideline. They will also continue to follow for obese and overweight patients. In collaboration with dieticians in public health centers.

Insufficient data entry will be prevented with counselling services programme. It will be given counselling service which is very important in the combating obesity.

Keywords: primary health care, obesity, physical activity, counselling

OP-122

Low levels of vitamin D in nicotine dependence: May vitamin D replacement be useful in the treatment of nicotine dependence

Tijen Sengezer¹

¹Numune Research and Training Hospital, Ankara, Turkey

²Department of Psychiatry, Numune Research and Training Hospital, Ankara, Turkey

³Department of family Physician, Numune Research and Training Hospital, Ankara, Turkey

⁴Department of Family Physician, Katip Çelebi Üniversitesi Atatürk Eğitim ve Araştırma Hastanesi, İzmir, Turkey

⁵Department of Psychology, Üsküdar University, İstanbul, Turkey

"AIM: To evaluate vitamin D levels in individuals admitted to our hospital's "smoking cessation unit" and accordingly, to investigate the relation of vitamin D levels with tobacco dependence.

MATERIAL-METHOD: 72 cases between ages of 17-69 referring to smoking cessation unit were included in our study. Retrospectively; demographic data form the patients' files, Fagerström Test for Nicotine Dependence (FTND), Beck Anxiety Inventory Questionnaire (BAIQ), Beck Depression Inventory (BDI) forms were examined and levels of vitamin D were recorded. Whether the parameters conform the normal distribution or not is evaluated by Kolmogorov-Smirnov test. In statistical analyses; Mann-Whitney U test, Kruskal-Wallis H test, One way ANOVA were applied. $p < 0.05$ level was accepted as statistically significant.

RESULTS: Mean age of the cases was $46,5 \pm 12,3$ (17-69) years, 36 of them (50%) were female. The average years of smoking was $25,6 \pm 12,0$ (1-50) years, average daily cigarette use at admission was $21,1 \pm 9,7$ (2-60), average score of FTND was $6,2 \pm 2,4$ (1-10). A statistical significance was determined among sex groups by means of vitamin D levels ($p=0,003$). A low but statistically significant and inverse relation has been observed between vitamin D

levels and BDI score ($p=0,007$, $r= - 0.374$). Considering the year of smoking, height, weight, age, score of FTND and BAIQ; no statistical significance has been determined between these variables and vitamin D levels.

CONCLUSION: Tobacco use has a relation with low levels of 25(OH)D. Therefore, the evaluation of vitamin D levels in the routine examination of tobacco consumers, replacement of vitamin D if there is any deficiency and their exposure to daylight will be beneficial."

Keywords: tobacco, nicotine, vitamine D, smoking

OP-123

One day with your doctor: a pilot lifestyle intervention lead by General Practitioners

Martin Sattler¹, Raquel Gomez Bravo², Claus Voegele³, Monique Aubart⁴, Marie Barth⁵, Max Haag⁶

¹Martin Sattler Family physician, Luxemburg, Luxemburg

²Raquel Gomez Bravo, Family Physician, Luxemburg, Luxemburg

³Prof. Claus Voegele, Department of Psychology University of Luxemburg, Luxemburg

⁴Monique Aubart, Family physician, Frisange, Luxemburg

⁵Marie Barth, Family Physician, Mamer, Luxemburg

⁶Max Haag, GP trainee at University of Luxemburg, Luxemburg

Background & AIM: General Practitioners (GPs) typically promote lifestyle changes such as modifications in dietary habits, smoking, alcohol consumption and physical activity. According to the literature, brief interventions carried out by GPs can be effective.

The aim of this project was to improve the quality of the doctor-patient relationship and to enable GPs to function as role models, thereby empowering them to better promote behavioural changes.

METHOD: A pilot project was run on the World family doctor day (19 May) in Luxembourg, which involved a lifestyle intervention including doctors and patients, physical activity (Nordic Walking, Jogging), cooking and eating together.

The invitation was sent 1 month in advance by post to all GPs, shared by email and social Media with students, GP trainees and junior doctors. Patients were directly recruited by their doctors.

After the intervention, a brief survey was completed.

RESULTS: All 10 participants reported to be very satisfied. There were 6 male and 4 female participants (3 Doctors, 1 physiotherapist, 6 patients). The mean age was 50.5 years and the mean BMI 23.31 kg/m². Participants reported a mean frequency of engaging in physical activity 4.8 times/week, with a mean duration of 6.5h/week. They also reported to have on average 3 meals/day, consuming fruits and vegetables 3.8 times/day. Participants were used to cook at home (1.2 times/day) and eat in restaurants 2.8 times/month; only 20% indicated to eat fast food once a month. The majority of participants (80%) stated not to have been dieting in the past, with the remaining 20% specifying a low carbohydrate diet, restriction of alcohol, coffee, tea and smoking cessation.

CONCLUSIONS: Promotion of lifestyle changes could be even more successful, if GPs adopt a healthy lifestyle themselves. By doing so, they are in an advantageous position to become "role models" and encourage behavioural changes in their patients.

Keywords: lifestyle, exercise, nutrition

OP-124

The effects of menopausal symptoms in climacteric women on marital adjustment and sexual life

Zeynep Can Turhan¹, Fatma Goksin Cihan², Ruhusen Kutlu², Samil Ecirli¹

¹Konya Training and Research Hospital

²Konya Necmettin Erbakan University Meram Medical Faculty

Background and AIM: This study aims to evaluate the effects of menopausal symptoms in climacteric women on their marital adjustment and sexual life.

METHODS: In this cross-sectional study; socio-demographic data form, Menopause Symptom Rating Scale (MSRS), Marital Adjustment Scale (MAS) and Arizona Sexual Experiences Scale (ASEX) were applied to 400 married, climacteric women.

RESULTS: The mean age of participants was 50,2±6,47 and entering menopause age mean was 46,0±5,29. 46.2% of the participants (n=185) were under the age of 49. The averages of MSRS-SS (Somatic Symptoms) ($p<0,001$) and MSRS-US (Urogenital Symptoms) ($p=0,008$) scores of 49 years old and older women were significantly higher. The average of MSRS-SS scores of working women was statistically significantly higher ($p=0,015$). The averages of MSRS-SS ($p<0,001$), MSRS-PS (Psychological Symptoms) ($p=0,003$) and MSRS-US scores ($p=0,016$) of women with chronic diseases were statistically significantly higher. The mean of MSRS-US scores of exercising women was statistically significantly lower ($p=0,028$). The mean of MAS scores of women whose educational levels were primary school or below was statistically significantly higher ($p=0,001$). The mean of MAS scores of women who married by falling in love was statistically significantly higher ($p=0,027$). The mean of ASEX scores of women who were 49 years old or older was statistically significantly lower ($p=0,024$). While the mean of MAS scores of women with high menopausal symptoms was statistically significantly low ($p=0,001$); their mean of ASEX scores was statistically significantly high ($p=0,001$). The mean of ASEX scores of women with higher MAS scores was statistically significantly low ($p=0,001$).

CONCLUSIONS: Menopausal symptoms are identified as a problem closely concerning marriages and sexual lives of climacteric women.

Keywords: Climacteric period, marital adjustment, sexual life.

OP-125

Hormone replacement therapy of menopause (HRT) prescribed by young general practitioners in Gironde (France): knowledges, attitudes and practices

Shérazade Kinouani, Paul Nalet, Sylvie Duhamel, Jean Louis Demeaux

Department of general practice, University of Bordeaux, Bordeaux, France

Background & AIM: in 2014, hormone replacement therapy of menopause (HRT) is the most effective therapy to treat climacteric syndrome who alters the quality of life. Yet in the late 90s (the time of publication of the first results of the US study WHI), there has been a significant decline in France of his prescribing by gynecologists and general practitioners (GPs). Young doctors started their medical training when HRT has been widely criticized and today, the therapeutic benefit/risk ratio remains controversial. The aim of this study was to describe the knowledges, attitudes and practices of young GPs about HRT.

METHOD: an online cross-sectional survey was achieved in 2014, using a self-administered questionnaire. Locum GPs enrolled in an online forum in department of Gironde (France) were interviewed. Data were weighted during descriptive analysis.

RESULTS: 77 locum GPs were interviewed. The response rate was 14.6%. Locum GPs were not opposed to the prescription of HRT: the frequency of prescription was 61.6%, mainly by renewal. They were 8.7% to initiate it. Reluctances were reported in 62.2% of cases but they did not influence the prescription of HRT. Personal factors influenced weakly the prescription of locum GP. The proportion of prescription was more important if the practice of gynecology was more usual. A complementary training in gynecology was not associated with a greater frequency of prescription but was linked with a greater frequency of HRT cessation.

CONCLUSION: despite expressed reluctances and unclear scientific data, locum GPs remained in an "evidence-based medicine" approach about HRT, in compliance with known indications or contraindications.

Keywords: menopause, hormone therapy, locum general practitioner

OP-126

Ask women "family history of breast cancer" for person-centered approach of screening

Mehtap Kartal¹, Nilgun Ozcakar¹, Sehnaz Hatipoglu², Makbule Neslisah Tan¹, Azize Dilek Guldal¹

¹Family Medicine Department of Dokuz Eylul University, Izmir, Turkey

²Ministry of Health, 24th Family Health Centre, Izmir, Turkey

Background & AIM: Screening recommendations of physicians are important for women to raise awareness about their risk factors, and to promote appropriate screening behaviors. However, it seems challenging for primary care physicians (PCPs) balance between disease prevention and diagnosis-treatment. The aim was to describe physicians' breast cancer consultancy practice including family history, cancer prevention issues for the women they care.

METHOD: Data were collected as part of a cross-sectional survey about breast cancer risk factors, different risk perception measures, and screening behaviors of women. During face-to-face interviews 577 women completed the questionnaires. For breast cancer risk prediction, 5-year risk score ≥ 1.67 in Gail model, was considered as "increased risk".

RESULTS: Among women 49.9% reported that they visit PCPs for an annual examination during the year, and 36.1% had first degree relatives with cancer while 7.3% with breast cancer. According to Gail score 22.4% of the women were in increased risk group. Among cancer and breast cancer related characteristics of the women only a positive family history of first-degree relative with breast cancer was statistically significantly more in increased risk group ($p < 0.001$).

Although PCPs, compared to other physicians, asked more about family history of cancer ($p < 0.001$) and informed more about cancer prevention issues ($p < 0.001$) the women who visited them for annual examination, still they didn't ask 64.9% of these women their family history of cancer and didn't inform 73.6% about cancer prevention issues.

CONCLUSIONS: For PCPs cancer still seems to be a hard issue to discuss even with women visiting them for annual examination. Asking first degree relative with breast cancer can give PCPs the chance of determining women with increased risk, and support women's appropriate understanding of their risk in relation to their family history. This can support shared-decision making for the development of person-centered approach for breast cancer screening.

Keywords: breast cancer; prevention; family history; screening

OP-127

Vaginal Estrogens for treatment of vaginal atrophy: An evidence based review

Ana Margarida Pinho, Célia Gomes Silva

ACES Entre Douro e Vouga I Feira/Arouca, USF Famílias, Lourosa, Santa Maria da Feira, Portugal

Background & Aim

Vaginal atrophy or atrophic vaginitis, is an inflammation of the vagina due to the thinning, drying and shrinking of the tissues. Genital symptoms include dryness, soreness, irritation, discharge and dyspareunia. These symptoms are due to a lack of the estrogens and are more often after menopause.

Atrophic vaginitis has a negative impact on patient quality of life and sexual health. With early identification, treatments can improve these symptoms and reverse the physical changes.

The aim of this study is to review the available evidence on the efficacy of vaginal estrogens in the treatment of vaginal atrophy.

Method

A search for clinical practice guidelines, meta-analysis, systematic reviews, evidence-based reviews and clinical trials published between January 2010 and March 2015, in English, Spanish and Portuguese was performed using the MeSH terms: atrophy and estrogens. The Strength of Recommendation Taxonomy scale of the American Family Physician was used to assess the quality of the studies and the strength of the recommendation.

Results

Of the fifty articles found, only six fulfilled the inclusion criteria and were selected. These included three guidelines, two systematic reviews and one randomized controlled trial.

The guidelines recommended vaginal estrogens for treatment of vaginal atrophy in postmenopausal women. The systematic reviews found that vaginal estrogens effectively relieve common vulvovaginal atrophy-related complaints. The randomized controlled trial concluded that treatment with vaginal estrogens for 12 weeks improve sexual function in postmenopausal women with symptoms of vaginal atrophy when compared with a placebo.

Conclusions

Evidence from available studies suggests that local vaginal estrogen therapies are effective in relieving symptoms of vaginal atrophy (Strength of Recommendation B).

More studies are needed to establish tolerability of vaginal estrogens as well as the efficacy relative to other therapies.

Keywords: Atrophy; Vagina; Estrogens.

OP-128

Evaluation of Marital Adjustment And Psychosocial State Of Couples Undergoing Infertility Treatment

Sule Erayman¹, Fatma Goksin Cihan², Mustafa Basaran³

¹Family Medicine Clinic, Konya Training and Research Hospital, Konya, Turkey

²Department of Family Medicine, Necmettin Erbakan University, Meram Medical Faculty, Konya, Turkey

³Obstetrics and Gynecology Clinic, Konya Training and Research Hospital, Konya, Turkey

Background and AIM: Infertility treatment is a stressful and anxious course for attendant couples. During this process, both husband's and wife's stress level and interrelation may be adversely effected. This study is planned for investigating anxiety and depression symptoms due to infertility and probable problems in marital adjustment of infertile couples.

METHODS: In this analytical cross-sectional study, 101 infertile couples who admitted to Konya Training and Research Hospital IVF Center from July 2014 to January 2015, were included. A sociodemographic questionnaire, Marital Adjustment Scale (MAS), Beck Anxiety Inventory (BAI) and Beck Depression Inventory (BDI) were fulfilled by the participants.

RESULTS: The mean age was 28.0±4.8 for women and was 31.1±5.7 for men. BAI scores were found significantly higher in women (9.8±8.0) than men (7.2±9.2) (p=0.001). Similarly, BDI scores were significantly higher in women (p<0.001). There wasn't any significant difference between MAS mean scores of men (47.2±7.1), and women (48.9±6.0) (p=0.157). BAI scores were higher in 19.8% of women and 12.9% of men (p=0.183). According to BDI scores, 23.8% of women, and 8.9% of men had depression (p=0.004). MAS scores were low in 26.7% of women and 23.8% of men (p=0.627).

CONCLUSIONS: Infertility treatment may not lower the marital adjustment; it may bond couples to each other. The treatment process brings serious physical and emotional burden for couples, especially for the woman. Couples who have experienced physical and psychosocial problems about infertility treatment need health professionals' support. This support is important for couples' attendance to treatment, success of the treatment by raising the pregnancy rates, and public health.

Keywords: Infertility, marital adjustment, depression.

OP-129

{Assesment of Postpartum Depression Using The Edinburgh Postnatal Depression Scale In Fathers of The Children Born at Ankara University School Of Medicine Department of Obstetrics And Gynecology }

Gülşen Ceyhun Peker, Ayşegül Cömert Okutucu, Ayşe Selda Tekiner, Zehra Dağlı

Department of Family Medicine, Ankara University School of Medicine, Ankara, Turkey

Background and AIM: The aim of this study is to determine the rates and risk factors of post-partum depression in fathers.

METHODS: The study was carried out with 252 fathers who agreed to participate, at Ankara University School of Medicine Department of Obstetrics and Gynecology between April and June 2013. Two interviews were conducted; first at childbirth, and second at 6th week post-partum. Paternal depression was assesed with Edinburgh Postnatal Depression Scale (EPDS), Hamilton Depression Rating Scale (HAM-D) and Socio-demographic Questionnaire. We used a cut-off score of greater than 13 for EPDS.

RESULTS: Depression rates in fathers assesed with EPDS at 6th week postpartum was 5,6 %. Mean EPDS scores in the first and second interviews were 5,35± 4,29 and 5,85± 4,08 respectively. Factors that have an increasing effect on EPDS scores were determined as: Number of children, number of individuals living with the family, history of psychiatric disorders, unplanned pregnancies, marital conflicts and lack of social support. Fathers with higher incomes and/or without gender expectations scored significantly less on the EPDS.

CONCLUSION: Fathers should also be screened and if needed referred for postpartum depression especially in primary care. Further research with larger samples is crucial to determine the risk factors and screening policies as this could represent an important opportunity for public health intervention.

Keywords: Fathers, Depression, Postnatal

OP-130

Infertility and Biopsychosocial Approach

Ferhat Ekinci¹, Bilge Turgut², Dođukan Ali Angın³, Tefvik Yoldemir⁴, Arzu Uzuner²

¹Department of Public Health Directory, Van, Turkey

²Department of Family Medicine, Marmara University, İstanbul, Turkey

³Department of Obstetrics and Gynecology, Bigadiç Public Hospital, Balıkesir

⁴Department of Obstetrics and Gynecology, Marmara University, İstanbul, Turkey

AIM: Infertility is a life event that can cause psychopathological changes in women. The aim of this study was to evaluate depression, anxiety, loneliness and social support in infertile women.

METHOD: The female infertile patients who applied to the Marmara University Department of obstetrics and gynecology outpatient clinics were recruited in this study. All participants have been asked to fill Hamilton anxiety scale, Beck depression scale, University of California Los Angeles Loneliness Scale and Multidimensional Scale of Perceived Social Support-MSPSS.

RESULTS: A total of 141 infertile women; mean age value was 28.8 ± 4.7 ; mean marriage year was 5.7(1-18). Of the participants 16.3% were working. The infertility type was 79% primary, 21% secondary; median time of being infertile was 4.2(1-15) years. Men infertility rate was 10%, idiopathic infertility rate was 66%. The rate of the participants with previous treatment was 49.6%. Only three of the participants were taking psychiatric treatment. Nearly all of them were sharing their situation with their friends (92%). Seven percent of the husbands and 13% of their husbands' families showed incomprehension to the participants. According to Beck depression scale two participants and according to Hamilton anxiety scale 19 participants were referred to psychiatry clinic. Loneliness scale score was decreased with increasing year of marriage and monthly income ($r=0.32, p=0.004$; $r=0.23, p=0.006$). The loneliness scale score of whom living with her husbands' family were meaningfully higher than that of whom living only with their husbands ($p=0.010$). The social support increased with the increase of married years ($r=0.238, p=0.005$); there was no significant difference between year of marriage and perceived social support ($p>0.005$). Loneliness scale score was negatively correlated with perceived friend support and perceived family support ($r=-0.527, r=-0.373$) ($p<0.001$) and was positively correlated with anxiety and depression scale scores ($r=0.455, r=0.486$) ($p<0.001$).

DISCUSSION: Infertile women have less depression scale score than and nearly the same anxiety scale score with normal population. Family structure of the couple and social environment such as house, financial, physical conditions, social relations; affect loneliness scale score and perceived social support. Infertility is a clinical problem which should have been discussed by biopsychosocial approach.

Keywords: infertility, women, biopsychosocial approach

OP-131

Women's mortality rate in reproductive age from cervical cancer in Goiânia during 2013

Gustavo Aguilar Alvarenga Amorim, Natália Carasek Matos Cascudo, Lara Louise Guimarães Silveira, Ana Luísa Franco Moura, David Carvalho Rezende, Wallace Pinheiro Rodrigues, Lorena De Almeida Ribeiro Prudente, Vinícius Bernardes Mendonça Damasceno, Natália Jácomo Auad, Davison Rodrigues Lima Oliveira, Camila Garcia De Souza, Ayssa Teles Abrão Trad, Thiago Pimenta Alves
School of Medicine, Federal University of Goiás

BACKGROUND & AIM

This study is relevant because contributes with epidemiological data of mortality that may help elucidate which measures should be taken to decrease the death rate of women in reproductive age. The aim is to analyze the mortality rates from cervical cancer in the city of Goiânia among women in reproductive age during 2013.

METHOD

Cross-Sectional study using mortality data from cervical cancer, among women between 10 and 49 years old, during the year of 2013, in the city of Goiânia (state of Goiás, Brazil). The data was obtained from the Health Information Division of Goiânia's City Health Department (which provided information from the death certificates) and also women global mortality rates in Goiânia, available on the Database of SUS (DATASUS). The data collected was managed with Microsoft Excel 2010.

RESULTS

It was found that the death numbers from cervical cancer in Goiânia during 2013 among women in fertile age was 13, which represents around 2,76% of women global death rate in the same age group, throughout the same year in the city. It was also verified that cervical cancer represented 15,1% of the total amount of women who died from cancer at the location, which was the second higher level, staying behind only from breast cancer.

CONCLUSIONS

Cancer had a high mortality rate among women in the researched group and cervical cancer played a special role, being responsible for the second higher number of deaths. The challenges involved in the struggle against cervical cancer must be overcome. Changing this setting requires deeper intervention measures such as improving the extent of the Pap smear test. In addition, educational measures from the health professionals to the general public should be strengthened, emphasizing the importance of prevention and early treatment.

Keywords: Cervical Cancer, Neoplasms, Mortality.

OP-132

Once upon a time the COPD knowledge and prevention for children of 8 years (children´s story)

Lazaro De Castro Peral¹, Ana Cristina Menéndez López², Juana Jiménez Martínez³, Javier Arnés Acevedo², Francisca María Aceituno Villalba², Laura Ubeda Cuenca², María Dolores Bosque Mata², Sonia Falla Jurado², Alicia Sánchez Martínez², Alvaro Ruiz Risueño Montoya²

¹San Pedro del Pinatar Health Centre

²San Javier Health Centre

³Torre Pacheco Health Centre

BLACKGROUNDS AND AIMS:

This work is part of a series of studies aimed at Prevention and health education, which includes family, teachers and health professionals to aid in a prevention culture. For students in third grade school Las Claras del Mar Menor, we wrote a story about a great grandfather, "The World's Best Grandfather" who had COPD, which defined the disease, and described its symptoms, treatments and prevention measures. Then we asked several questions to see if they had learned anything from the story. We also wanted to know of any interest in students becoming doctors in their own future, as we had also asked to other primary age groups.

METHOD:

Cross-sectional study carried out on the total students in third grade (79). Questionnaire of 12 items. Statistical Analysis T-student, G-STAT 2.0 software, considered significant at $P < 0.05$.

RESULTS:

Sex: female 50.63 %, 49.37 % male, showed interest in becoming a doctor when they grow up 44.30 % (66.66 % girls and 33.34 % boys). Very good results in the test: 95.30 % correct. Regarding knowledge about COPD, definition, causes and symptoms: 97.47 % responded correctly after reading the story. Treatment: Correct inhalers 87.34 %, smoking cessation: 96.20 %. Relationship vaccine / illness 91.14 %. Reported having spoken of smoking in class 82.28 %, 83.54 % at home. From now on 97.47 % of children will remember advice to not smoke or drink alcohol.

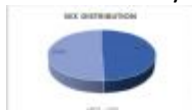
CONCLUSIONS:

1. - Promoting healthy habits from childhood, avoiding future addictions.
2. -. Giving children advice from parents about the risks of tobacco and explaining the benefits (breath, white teeth, no odors at home / car, fewer colds, saving money and, above all, to continue playing).

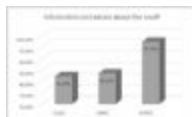
CHILDREN DON'T LIE.

Keywords: COPD, Tobacco, Preventive Medicine

Distribution by sex



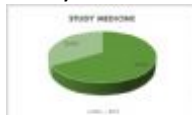
Information and advice



Knowledge about COPD



Study Medicine



OP-133

Sexuality Workshop: experience in a public school of a brazilian underserved area

Ana Rosa Murad Szpilman, Erivelto Pires Martins

Department of Public Health, Vila Velha University, Vila Velha, Brazil

BACKGROUND & AIM

A Sexuality Workshop was organized by the Vila Velha University Medical School Students, in a elementary education public school, in Espírito Santo State, in Brazil. It aimed to discuss and problematize with teenagers about sexuality, in order to reduce the teenage pregnancy.

METHOD

Reading and documental research on sexuality by the medical students were the first steps. Afterwards, the students contacted the school principal, pedagogues and teachers to present the workshop project. The workshops were based on the Conversation Circle Method, shared learning, in a group, facing each other, in order to collectively build knowledge. On october 2014, it was conducted, by the medical students, four recreational-pedagogical workshops with 133 eight grade teenagers, from 14 to 17 years old, with a qualitative and dynamic approach, exploiting data related to the individuals life experiences. The medical students determined the discussion themes based on the teenagers questioning: puberty and gender relations; Pregnancy Puerperium Cycle, Teenage Pregnancy and Contraceptive Methods; STD/AIDS prevention and Sexuality and Media. In order to guide the discussion, audiovisual materials were used: movies, images and photographs.

RESULTS

Considering subjective criteria, the students evaluation, demonstrate the intervention plan effectiveness, based on the teenagers speeches, such as: "now I understand", "Oh, so that how it is!", "Got it!", among others. The principal, pedagogues, teachers and employees were implicated, promoting reflections and discussions among them. It was not possible to involve the parents at this moment - the next research step focus.

CONCLUSIONS

The sexual orientation theme is extremely important, inherent to life, justifying its inclusion in the academic curriculum. It is expected that teenagers think about their behavior, learn about sexuality by understanding their bodies, use contraceptive and preventive methods decreasing the teenage pregnancy and the sexually transmitted diseases, reflecting and changing their attitudes.

Keywords: Health Education, Public Health, Sexuality.

Sexuality Workshop Image 1



The picture was taken during the workshop in the public school with the teenagers.

Sexuality Workshop Image 2



This picture was also taken during the Workshop with the teenagers.

OP-134

The Opinions of the Family Medicine Specialists Who Work in Family Health Centers in Ankara about the Training of Family Medicine Residents

Fulya Cesur Yağız, Metin Canbal, Sevsen Cebeci

Department of Family Medicine, Turgut Ozal University, Ankara, Turkey

OBJECTIVE: The objective of this study is to determine the opinions, perceptions and tendencies of the family medicine specialists about prospective family health centers employed for resident's training and the contribution process of the family medicine specialists to the residents concerned.

MATERIALS-METHOD: This study employed a descriptive research type. The universe of the study is 104 family medicine specialists who work in family health centers in Ankara. 84 of these family medicine specialists were reached by the researcher's phone calls, took their consents and sent the questionnaire concerned to the participants. The participation was voluntary and 40 of the 84 family medicine specialist returned the questionnaire and e-mailed back. The return rate of the questionnaire is 47%. The obtained data were analyzed in terms of frequency, correlation between variables and statistical differences, and then the findings were discussed. The qualitative data, on the other hand were analyzed by means of descriptive analysis.

FINDINGS: The participants seemed to be positive about training of the residents by specialist family physicians and they found it useful. They were found to be eager to share their knowledge and experiences but they indicated the difficulty of workload and patients' number. However, they had a self-confident and motivated profile in terms of working as a trainer in family health centers.

CONCLUSION: The information and awareness of the family medicine specialists should be enhanced and their workload and working hours should be revised.

Keywords: family medicine, education, training

OP-135

In-service training for family doctors: Croatian experience

Mladenka Vrcic Keglevic¹, Hrvoje Tiljak²

¹Mladenka Vrcic-Keglevic, Foundation for the Development of Family Medicine in Croatia, Zagreb, Croatia

²Hrvoje Tiljak, University of Zagreb, School of Medicine, A. Stampar School of Public Health, Department of Family Medicine, Zagreb, Croatia

Background & aims

Vocational, speciality training for family doctors (FD) in Croatia started in 1960. But, it has always been possible to work as a FD without ST. Facing the process of joining the EU, ST was intensified by the Project: "Harmonisation of Croatian Family Medicine with European standards introducing speciality training". The Project started in school year 2003/04 and the main aim was that all working family doctors (FD), younger than 50-years, should finish ST until 2015. Because that more than 1.500 FD are waiting for ST and many of them are experienced, the three ST schemes were introduced: Program A, full program for young doctors, Program B, partly in-service and Program C, almost completely in-service ST. All of them should pass the same type of final exam. The aims of this study were to investigate how many trainees and from which programmes finished ST during the period of nine-years.

Methods

The data on the number of trainees due to the ST programmes were obtained from the archive of Department of Family Medicine, Zagreb Medical School, and the organiser. The number of specialists in FM was obtained from the Croatian health statistic yearbook.

Results

During the nine-year period, 751 trainees finished ST, while it was planned to involve 1350 of them, 55.6% of achievement. The best results were achieved in the in-service Program C, 83.3% of planned number, than in Program B, (52.2%), and the less in Program A, only 50.0% of planned number. The percentage of speciality

trained FD in Croatia increase in almost 20%; in some Counties more and in others less.

Conclusion

The results clearly indicated that the best results are achieved at in-service Program C. Our experience in in-service ST could help those countries with a large numbers of FD not having ST.

Keywords: family medicine, speciality training, in-service training, Croatian experiences

OP-136

Community-teaching-service Interaction: analyses on Medical Education effects

Ana Rosa Murad Szpilman, Maria Elizabeth Barros De Barros

Department of Education, Espirito Santo Federal University, Vitória, Brazil

BACKGROUND & AIM

This ongoing research focuses on medical education politics and its dimensions, indicating an urgent need to change the methodology, its curriculum frameworks, in order to graduate doctors, who experience during its graduation process a public dimension in doctors-patients relationships. It was analyzed if the inclusion of medical students in Community-teaching-service Interaction Programs produce practices that emphasize a public dimension in doctors-patients relationships, creating a bond helping in the process of delivering health care.

METHOD

It was analyzed the medical educational process, based on the effects of Community-teaching-service Interaction programs over students conceptions and practices. The subjects interviewed were the program teachers and medical students, and public health unities users and professionals, where the students' internship happens.

PRELIMINARY RESULTS

As a result, from this early and continuous contact with these unities a series of changes and achievements in the teaching, with the team and community, and in the future doctor's formation were accomplished. It's notorious and evident the actualization, study and research demand by the team, conquered through the contact with the student. The community reports that the contact with the student provides a distinguished attention. To the student is enabled a contact with real daily situations connected to the medical practice and a formation towards the public health system, a working market possibility. Furthermore, the professionals graduated in this context, acquire a wider vision of a humanized attention in multidisciplinary team, discerning indistinctly each health categories row and their possible contributions.

PRELIMINARY CONCLUSIONS

Up to now, by analyzing the data already collected, we can infer that Community-teaching-service Interaction Programs may be the solution to graduate doctors who will assist their patients in a way that we will have more possibility to succeed with better lifestyle choices, improvement in treatment adherence and prevention on some chronic diseases worsening.

Keywords: Undergraduate Medical Education, Public Health, Delivery of Health Care.

Childcare



The students with the health workers in the public health unity participate on the delivery of health care for the assisted groups, like childcare.

Children's Day Party at the community assisted



The students participate in a variety of activities in the community assisted with the health workers. This is a Children's Day Party at the community assisted.

Educational Activity at Public School



The students perform activities, clinical and educational, on the public schools with the health care workers in the community assisted.

Intelligent Map



The students use a range of tools to help organizing the delivery of health care by the health workers in the community assisted. This is the Intelligent Map.

OP-137

What does the Hippokrates and Conference exchanges participants think about their experiences?

Juan María Rodríguez Martínez¹, Raquel Gómez Bravo², Anna María De Pedro Pijoan¹, Enrique Álvarez Porta¹, David Bottaro Parra¹, Ignacio Borque Roda¹, Adriana Helfmelt Minobis¹

¹SEMFYC

²Vasco da Gama Movement

Background & AIM:

The VDGM Hippokrates, 10 years old program, allows GP trainees and Junior GPs to discover Primary Care in different countries. One of the most popular exchanges is the Conference Exchange, of one week duration, organized in the context of a Congress.

The aim of this project was to collect information of those who took part in them.

METHOD:

A self administered questionnaire was sent online during 2012 to 2014 to all the colleagues who took part in a Spanish Conference Exchanges or Spanish colleagues who took part abroad. 66 answers were collected. Items: profile, likes and dislikes, ratification of the organization, accommodation, feedback in their own country and information to improve the program.

RESULTS:

Age: 25 to 40, mostly female. Countries: Portugal, France, Israel, Italy, Turkey, Romania, Latvia, Czech Republic, Austria, Netherlands, Poland, Croatia, UK, Spain and Ukraine. They receive the information through email or Facebook.

All of them recommend the experience.

The majority didn't receive any fund, but the organizing country offered free inscriptions to attend and most of them value with high standards the organization. Accommodation was provided by GP trainees and Junior GPs.

Even if the language it could be a barrier in some cases, the communication was effective and they liked the most to see how other GPs work and share their own experience. The short length of the exchange was a common complain and they suggested to add more activities in English to improve the program.

A high amount of them answered that they will share their experience back in their countries.

CONCLUSIONS:

Conference exchanges are very well evaluate and recommend and it is a magnificent way to spread the importance of Primary Care, to enrich the professional development and it should be consider part of the curricula.

Keywords: Exchange, GP, trainees

OP-138

Care Pathways Project - Training in mental health for Community Health Agents and Auxiliaries nursing technicians/ Brazil

Edelves Rodrigues, Renata Pekelman

Health Technological Education and Research Center/ GHC School-Hospital Conceição's Group, Porto Alegre, Brazil

Background and AIM: The Care Pathways project is one action of the national plan "Crack can be conquered" on the responsibility of the Ministry of Health, in partnership with the Oswaldo Cruz Foundation (FIOCRUZ) / RJ, Conceição's Hospital Group (GHC) / RS and Federal University of Rio Grande do Sul (UFRGS), Brazil. It involves the relationship between institutions of the National Health System/SUS, SUS Technical Schools (SUSTS), areas of Mental Health and Primary Care of the three federal entities and the Boards of Municipal Health Secretaries (COSEMS). Aims to provide training for all Community Health Agents (CHA) in Brazil and one auxiliary nurses (AN) for each family health team in mental health with emphasis on crack, alcohol and other drugs, totaling 290,760 students. **METHODOLOGY:** It's organized through a conductor Group, an Executive Coordination for its operation and implementation and Coordinations of Infrastructure, Communication, Academic, Educational and macro-regional. The latter articulated in 05 country's regions, ETSUS, COSEMS, Departments of Primary Care and Mental Health of States and support 27 States teams that articulate and execute the courses to CHA / AN. Counselors and tutors were selected among the SUS workers of Primary Care, Mental Health, trained and accompanied by educational coordination. **RESULTS:** Care Pathways started in May 2013 and to date has produced two educational materials, formation of 187 counselors, 2200 tutors and 270,000 ACS/ATENf. **CONCLUSION:** assessments were positive, counselors, trained tutors and CHA / AN showed the need to broaden the understanding of the issue and make possible the creation of a new look for attention to mental suffering in Primary Care. **Conclusion:** It is essential the incorporation of its method and theme in the training of Community Health Agents and Auxiliary Nursing Technicians promoted by SUSTS and include the formation process of these technical content.

Keywords: Health Education, Mental Health, Primary Care

OP-139

evaluation of medical students' attitudes towards the elderly

Hüseyin Elbi¹, Süheyla Rahman², Selim Altan³, Beyhan Cengiz Özyurt⁵, Sevnaz Şahin⁶, F. Sırrı Çam⁴

¹department of family medicine, celal bayar university, manisa, Turkey

²department of medical education, celal bayar university, manisa, Turkey

³department of medical ethics, celal bayar university, manisa, Turkey

⁴department of medical genetics, celal bayar university, manisa, Turkey

⁵department of public health, celal bayar university, manisa, Turkey

⁶department of internal medicine, division of geriatrics, aegean university, izmir, Turkey

AIM

In 2014, the seniors of Turkey reached to 8.0% of the population, increased from 6.7% in 2006. By 2050, it is projected that seniors will make up more than 20% of the population. Today, we should see the reality of an aging population begins to make itself felt especially in the economy and health care rather than think of it as a future phenomenon. The purpose of this study aims to evaluate the attitudes of medical students towards elderly at Faculty of Medicine of Celal Bayar University.

METHOD

This is a cross-sectional study carried out at Faculty of Medicine of Celal Bayar University in Turkey. Participants of the study were selected from 1070 medical students educated all classes of the faculty by stratified sampling.

Two surveys were carried out to assess students' attitudes toward the elderly and demographic questions were asked. The first was UCLA Geriatrics Attitude Scale designed to measure and compare primary care residents' attitudes towards older people. The second was Kogan's Attitude towards Old People Scale established to measure the attitudes of individuals towards older people.

RESULTS

There were 406 participants in the study. The age of the participants ranged from 18 to 27 years (mean 21.04 years); 60.8% of them were female. There were significant differences in the comparison of gender and classes for UCLA total score evaluation, but assessment of KOGAN total score there was significant difference for classes only ($p < 0,05$).

CONCLUSIONS

It was determined that the attitude toward the elderly was more positive for second and third classes; so a study program about the attitudes of students towards the elderly during the period of pre-graduation should encourage in the curriculum of the fourth and fifth years rotations where students studies at different outpatient and inpatient clinics.

Keywords: medical student, attitude, elderly

OP-140

Impacts and assessment of a method recruiting General Practitioners' supervisors by using GP trainees in the Parisian Region

Emna Zarrad, Gladys Ibañez

University Pierre and Marie Curie - Paris 6

Background and Aim

A health system based on primary care is more efficient and more equal. (WHO 1978) General Practitioners (GP) are the corner stone in such a system. Discovering and learning Family Medicine in GP's practice is fundamental and recruiting GP's supervisors becomes a real challenge. The aim of the study is to propose and assess a recruiting GP's supervisors' method, and its impacts.

Method

Interventional comparative non randomised study has been lead between the 20/09/2013 and 1/10/2014 with GP working in Parisian region. Two interventions have been compared: a "gold standard" method where all GPs received a postal letter and a "sensitization" method towards GP trainees who should participate by contacting (themselves or through another person) a GP they know who could possibly be candidate on becoming a GP's supervisor. Illustrative video have been created to help convincing GP.

Results

Among the 7 Parisian medical universities, 5 of them accepted the intervention. GP trainees filled 293 questionnaires and 132 (51.9%) GP have been suggested. Among the 132 GP selected in the study, 113 (85.6%) have effectively been contacted. Twenty (15.2%) of them were interested on becoming GP's supervisors and have been referred to a university's contact. The rate of recruitment by this method has been highly superior to the one given by the gold standard method ($p < 0.0001$). The success of videos (>6000 views on YouTube) showed the necessity of such tools. A website has been created to gather all those information, in one and dedicated place: www.devenirmsu.com.

Conclusion

It is probably recommended to anticipate, assess and spread all GP' preceptors' recruitment's methods in order to know better the efficiency of our actions in that field and allow us to pool them.

Keywords: GP' tutors preceptorship recruitment assessment method

OP-141

Family medicine training in Saudi Arabia: Are there any variations among different regions?

Kasim Mohammed Aldawood, Ammar R Abu Zuhairah, Amar H Khamis
University of Dammam

AIMS: The aim was to compare Eastern, Makkah, and Asir regions, and to assess various rotations based on residents' perception.

METHODOLOGY: This is a cross-sectional study. A questionnaire was developed by the investigator and validated by two experts. All residents, except R1 residents, were included. All data were collected by the investigator by direct contact with the residents. Statistical Analysis Used: Cronbach's alpha, analysis of variance, t-test, and univariate regression model as appropriate, were used. **RESULTS:** Reliability of the questionnaire was found to be 75.4%. One hundred and seven (response rate: 83.6%) residents completed the questionnaire. There were 51 (47.7%), 27 (25.2%), and 29 (27.1%) residents in the program in the Eastern region, Makkah, and Asir, respectively. The mean age was 29.1 ± 2.5 years; half of the residents were male, most of (83.2%) were married, and more than half (54.2%) of had worked in primary health care before joining the program. Overall, 45% of the residents perceived that they had achieved the training objectives. The highest rotations as perceived by the residents were psychiatry and otolaryngology while the lowest were orthopedics and ophthalmology. There were significant differences among the study regions with regard to the rotations in family medicine, internal medicine, orthopedics, general surgery, and emergency medicine. **CONCLUSIONS:** Overall, a good percentage of the residents perceived that they had achieved the training objectives. The rotations differed in the studied regions. Psychiatry and otolaryngology had the highest percentage of family medicine residents who perceived that they had achieved the training objectives while lowest was in internal medicine and obstetrics and gynecology. The highest rotations as perceived by the family medicine residents were psychiatry and otolaryngology while lowest were orthopedics and ophthalmology. Sharing of experience and further studies are needed to improve the program rotations.

Keywords: Clinical training, family medicine, postgraduate training, Saudi Arabia

OP-142

Factors affecting Family Medicine residents perception of achievement of training objectives

Kasim Mohammed Aldawood, Ammar R Abu Zuhairah, Amar H Khamis
University of Dammam

AIMS: To measure the association between number of patient encounters and training provided to residents, as well as the residents' perceived achievement of training objectives. **Settings and Design:** This cross-sectional study was done on Family Medicine residents in Eastern province, Makkah and Asir regions. **MATERIALS-METHODS:** A questionnaire was developed by the investigator and validated by two experts. All residents, except first year residents, were included. Data were collected by the investigator through direct contact with the residents. **Statistical analysis:** Cronbach's alpha, analysis of variance, t-test, and univariate regression model were used. **RESULTS:** Reliability of the questionnaire was found to be 75.4%. One hundred and seven residents (response rate, 83.6%) had completed the questionnaire. The mean age was 29.1 ± 2.5 years, half of the residents were male, most of them (83.2%) were married, and more than half (54.2%) of the residents had worked in primary health care (PHC) before joining the programme. Age and duration of work in PHC before joining the programme were significantly and positively associated with the outcome. In Family Medicine rotations, continuity of care, percentage of patients discussed, and number of trainers were associated with the outcome. On the other hand, percentage of patients discussed in different settings and opportunity for the residents to evaluate patients in an outpatient setting were among the factors affecting the outcome in the hospital rotations. **CONCLUSIONS:** Factors identified (age, duration of work in PHC, discussion, and opportunity to evaluate patients) might help residents, trainers, and decision makers in ensuring residents benefit from the different rotations. Further studies to link the effect of the identified factors on resident outcome and patient care are required.

Keywords: Clinical training, Family Medicine, postgraduate training, Saudi Arabia

OP-143

Balint 2.0: Bringing the World together through Virtual Balint Meetings for WONCA Doctors

Kyle Hoedebecke¹, Luis De Pinho Costa², Albert Lichtenstein⁴, Donald Nease, Jr.³

¹Wonca Polaris, Fayetteville, USA

²Vasco da Gama, Oporto, Portugal

³International Balint Federation

⁴American Balint Society

BACKGROUND: In September 2014, discussions emerged regarding an online international Balint initiative as a literature search did not produce any published results describing similar international web-based projects. Within hours of the initial post, a dozen representatives from the majority of the regional YDMs signed up to participate - namely the Vasco da Gama Movement, Polaris Movement, Waynakay Movement and The Spice Route. More recently representatives from AfriWon, the Al Razi Movement and The Rajakumar Movement have joined in. The group calls itself "Balint 2.0 Ambassadors": 2.0 references the application of technology while "ambassadors" touches on its international nature.

METHODS: 14 Representatives from all 7 WOCNA regions participating in monthly virtual meetings using Zoom in collaboration with 2 Balint Instructors from the International Balint Federation and the American Balint Society.

Results/CONCLUSIONS: The group has met monthly for 7 months and has worked out the majority of the technical issues which allow the group to function in such a virtual manner. This is the first Balint group of its kind and has shown that the virtual Balint setting is a possibility. The group hopes to share this journey of collaboration, learning, and deeper understanding so that others may take advantage of technology to perform their own similar groups. In addition to the great learning experience, this collaboration proves to better unite all WONCA regions and YDMs. Balint 2.0 Ambassadors are making a good example of a wider international view of breaking frontiers within the global world of Family Medicine, towards a new era for YDMs, young and future family doctors.

Keywords: Behavioral Health, Balint, Young Doctor Movements, Education

Example of Balint 2.0 Meeting



This is a screen shot of a recent monthly Balint 2.0 Meeting

OP-144

Asthma educational program (PAMA) in primary care. Randomised control trial (RCT). Results one year after implementation

Laia Lamarca Fornell, Xavier Flor Escriche, Silvia Álvarez Álvarez, Ainhoa Toscano Rivera, Belen Sanchez Rodriguez, Ingrid Pinilla Rodriguez, M Roser Sanchez Solias, Claustre Solé Brichs, Toni López Ruiz, Eva Fernández Alcantud, Sagrario Barcos San Andres, Silvia Penalva Guillamon, Natalia Peralta Garcia, Mónica Manzano Montero, Inmaculada Vega Manzano, Maria Úbeda Pastor, Sonia Labrador Martinez, Monica Rebollar Gil, Eulalia Villacampa Lavalle, Ana Domenech Borrás, M Mar Fraga Martínez, M Victòria Feijoo Rodriguez, Manuela Carmona Rabadan, M Pilar Martinez Martinez, C Eulalia Almendro Almendro
SAP Muntanya Barcelona Ciutat, Institut Català de la Salut, Barcelona, Spain

BACKGROUND AND AIM

Asthma prevalence has increased. International guidelines recommend follow-up visits to evaluate the impact of asthma and PAMA pretends to facilitate that.

We designed an intervention to improve disease control level and patient's quality of life, and the reduction of exacerbations and emergency visits.

METHODS

3 years long RCT, performed in 10 primary care teams, to evaluate PAMA which includes: patient education, asthma control test(ACT), explanation of inhalation systems, exacerbation symptoms and treatment action plan and revision of patient's technique.

RESULTS

Baseline

498 asthmatic patients included and randomized into 4 groups: I: PAMA application every 6 months: 124; II: every 12m: 120; III: every 18m: 115 and control group: usual management: 139.

Average ACT scoring was 20.9(SD 4.2) and global mini-AQLQ 5.7(SD 1.1).

47% patients didn't perform any follow-up visit in previous year. 663 follow-up visits were performed the year before costing 33119€. 485 visits due to exacerbations were performed costing 28851€.

First year

392 patients remain in the study: 84 (I); 98 (II), 100 (III) and 110 (control).

36% had intermittent asthma, 22.2% mild persistent and 35.7% moderate persistent versus 36.9%, 17.3% and 40% respectively at the beginning of study.

73.2% had controlled asthma versus 70.1% at the beginning of study. This difference is statistical significant in group III.

Average ACT scoring was 21.8(SD 4.1), and global mini-AQLQ 5.98(SD 1.05). Global difference for mini-AQLQ was statistical significant.

43.9% presented exacerbations versus 51.4% at the beginning of study. 890 follow-up visits were performed costing 40712€. 241 visits due to exacerbations were performed, valued in 19211€.

CONCLUSIONS

Patients maintain a good control and quality of life after a year. The percentage of patients with moderate persistent asthma was reduced.

The number of total exacerbations and the percentage of patients suffering exacerbations were reduced, with an associated costs reduction, too.

Keywords: Asthma, education, costs

OP-145

What medical students know about LGBT people and their health needs?

Ülkü Bulut¹, Dilek Güldal², Selin Bozdağ³, Demet Çelikkaya⁴

¹Balçova Community Health Center, Izmir, Turkey

²Dokuz Eylül University Faculty of Medicine, Family Medicine Department, Izmir, Turkey

³Kocaeli State Hospital, Kocaeli, Turkey

⁴Tepecik Education and Research Hospital, Izmir, Turkey

LGBT (or GLBT) are words' head letters, 'lesbian', 'gay', 'bisexual' and 'transgender'. There are no data to create a level about health of LGBT individuals because of less asking about sexuality during data collection. Homophobia among health professionals in working with LGBT patients, heterosexual assumptions, lack of knowledge, misunderstanding, such as excessive focus has been shown to cause barriers between patients and institutional personnel. In study we aimed to determine information about LGBT individuals and health needs, attitudes and behaviors of medical faculty sixth grade students.

METHOD: This research is a cross-sectional descriptive study. A questionnaire conducted to 134 Dokuz Eylül University Medical Faculty sixth grade students. Data collected with on-line survey and self fill out of questionnaire. Descriptive statistical analysis applied as well as the chi-square and t tests. SPSS 15.0 version used for statistical analysis.

RESULTS: In our study 49.3% of students were male. Mean age of students was 24.07 years. About their sexual orientation 3 student answered as gay, lesbian, asexual respectively. One student told that she did not decide yet. Two of them had LGBT person in their family, but 37.3% had LGBT friends. 39.6% of students told they had any source of information other than faculty. Most common sources were internet, committees and foundations. About taking detailed history 35.8%, about detailed physical examination 41.7% has not felt confident. 47.1% of students could not feel confident about taking care of LGBT patients in primary care. 65.7% of interns told they did not feel confident about taking care of LGBT patients.

CONCLUSION: Medical faculty education period should involve more detailed information about LGBT people for making students more confident about taking health care of their LGBT patients in primary care.

Keywords: LGBT, medical education, health care

OP-146

How to help to reduce the sitting time from Primary Care? The opinion of sedentary patients who are overweight

Elena Martínez Ramos¹, Carme Martín Borràs², Jose Manuel Trujillo Gómez³, Mercè Solà Gonfaus⁴, Eva Castillo Ramos⁵, Carlos Martín Cantera⁶, Dolors Rodríguez², Elisa Puigdomènech⁶, Angela María Beltran²

¹Primary Healthcare Centre, Vilanova, Institut Català de la Salut (ICS), Barcelona, Spain;

²Department of Physical Activity and Sport Sciences, FPCEE Blanquerna, Universitat Ramon Llull, Barcelona, Spain

³Primary Healthcare Centre, Cuevas del Almanzora, North Almeria Region, Spain;

⁴Primary Healthcare Centre, Les Planes, ICS, Barcelona, Spain

⁵Primary Healthcare Centre, Molí Nou, ICS, Barcelona, Spain

⁶Department of Medicine, Universitat Autònoma de Barcelona, Bellaterra (Cerdanyola del Vallès), Barcelona, Spain

Background and AIMS: The prolonged sitting time is a health problem that is increasingly more often in primary care consultations, especially in patients with overweight and obesity. Our main aim is to explore the opinion of these patients in relation with the expectations of help from Primary Care.

METHODS: Qualitative descriptive study conducted at three Primary Health Care centers from Barcelona. 23 patients with overweight or moderate obesity, aged 25 to 65 years, who reported sitting time for at least 6 hours a day participated in the study. Data was collected from 10 interviews (5 focal groups and 5 individual interviews) conducted by an expert moderator and an observer. Previously, informed consent was requested. All interviews were taped, transcribed and analyzed using. An analysis of thematic content was made using ATLAS. Ti programme and with triangulation analysis included.

RESULTS: A) Patients are unaware of the long-term risks of this behaviour for their health. Patients trust in Primary Health care professionals and believe that they are trained, for their knowledge and experience in detecting sedentary patients and educate them to reduce this behaviour. B) They believe that is more effective group education than individual advice in medical consultations. Patients prefer interventions through homogeneous groups (age and type of work). C) Patients considered important to monitor this behaviour from consultations and through e-mails, based on reminders, alternatives and questionnaires for comparing changes.ç

CONCLUSIONS: A sedentary lifestyle is an increasingly prevalent behavior. From Primary Health Care we can help to detect, educate and follow sedentary patients. Patient insights Were used to design an intervention to reduce sitting time within the frame of the SEDESTACTIV clinical trial.

The study is partially funded by Instituto de Salud Carlos III (PI11/01082).

Keywords: Overweight, Obesity, Sedentary behaviour, Sitting time, Primary healthcare, Qualitative research.

OP-147

Awareness of HPV-associated Oropharyngeal Cancers Amongst Scottish GP Trainees

Cemal Kavasogullari¹, Isabella Roiatti², Claire Vassie⁴, Richard Gilson³, Matthias Lechner⁴

¹NHS Education Scotland

²NHS Lanarkshire

³Research Department of Infection & Population Health, University College London, UK

⁴UCL Cancer Institute, University College London, UK

OBJECTIVES: HPV related oropharyngeal cancers (HPVROC) are increasing in the developed countries albeit the decreasing rates of smoking related oropharyngeal cancers. Furthermore, there is increasing evidence of the role of HPV in anal, and penile cancers. In view of this relatively recent developments we aim to examine and compare knowledge of risk factors and epidemiological trends of HPV-associated head and neck cancer amongst GP trainees in Scotland.

METHODS: An 11 point questionnaire was administered to GP trainees in Scottish training programmes via an electronic questionnaire. Self-rated level of knowledge of this topic was assessed using the Likert scale. Questions on risk factors, presentation, epidemiological trends and the association with HPV were included.

RESULTS: 60 questionnaires have been completed to date of which 38.3% were GPST1, 25% GPST2 and 26.7% GPST2 stage trainees. 60% of participants recognised HPV as a risk factor for OPC and 78% stated that they were aware of the increase in rates of HPV-associated OPC. 51% of respondents rated their knowledge as “average” with 32% as “poor or very poor” and only 18% as “good or very good”.

CONCLUSIONS: Preliminary analysis suggests a high level of awareness of the role of HPV in head and neck cancers among the Scottish GP Trainees. The characteristics of HPV associated OPC were less well recognised. Data is currently subject to validation in a larger cohort. Findings may suggest that further training may be necessary for GP trainees in Scotland and similar research to be carried out in other developed countries to assess levels of awareness on HPV associated OPC.

Keywords: HPV, oropharyngeal cancers, GP Training

OP-148

Bridging the cultural divide: Developing a structured academic CPD programme for Family Doctors, with a professional competence assessment

George Samoutis, John Howard

Department of Family Medicine, University of Nicosia, Cyprus

Background

A structured MSc FM academic programme of continuing professional development (CPD) designed and delivered for primary care physicians (PCPs) from a wide variety of background in Cyprus and the Eastern Mediterranean region, to orientate them to Family Medicine (FM). Uniquely, the clinically-focused first year Diploma level, provides a professional competence assessment, for which MRCGP(International) accreditation is intended. Many PCPs have no such opportunity for their CPD, nor to demonstrate their quality through an internationally recognised assessment of competence. Cyprus will introduce a primary care driven National Health System, which requires competent Family Doctors (FDs) for first contact and continuity of care with patients. WHO and WONCA have consistently proposed such a model. Many of the primary care workforce, in Cyprus and the Eastern Mediterranean, come from a variety of clinical backgrounds, without a formal orientation to FM.

METHOD:

The MSc FM is a modular academic CPD programme for such practicing PCPs. It is designed to be delivered in a user-friendly blended model of face-to-face and distance learning. University academic programmes traditionally

use assessment methods testing lower levels of Miller's pyramid. Professional competence assessments of FDs require methods testing higher levels. The assessment strategy ensures progression to research and teaching modules at Masters level, but the using modern assessment methods participants can demonstrate their quality against internationally recognised standards.

RESULTS:

The programme seems to successfully marry traditional university programmes with modern international professional competence assessment of FDs. It is currently being externally assessed academically by St George's Medical School, University of London, and for rigour of the competence assessment by the Royal College of General Practitioners.

Conclusions

The programme enables PCPs in the Eastern Mediterranean to undertake structured FM CPD, a FM competence assessment, and develop research and teaching skills to assist their contribution to the development of the discipline.

Keywords: Education CPD Competence

OP-149

Innovative Training for Undergraduate Students in Family Medicine, Faculty of Medicine, University of Gezira, Sudan 35 years Experience

Salwa Elsanousi Hussein Elnaeim, Emad Eldin Eljak Suleiman, Magda Elhadi Ahmed Yousif, Mohamed Elmoktar Saad Eldin

Department of Family and Community Medicine University of Gezira Faculty of Medicine Wad Medani Sudan

Background

Faculty of Medicine University of Gezira (FMUG) since its establishment in 1975 is adopting community based education, integration of basic, clinical and socio behavioral sciences, and problem solving approach. Primary Health Care Centre Practice and Family Medicine programme. (PHCCP and FM) is one of the courses aimed to enable the students to play an active role in the delivery of Primary Health Care (PHC) at the level of the family and linking of the families area to the nearby health centres. The programme implemented in collaboration with PHC Team in four semesters. Each student is assigned a family to visit every other week, with the objective of recognizing the health problems at the family level and to acquire the skills of responding to major health problems and solve them through a holistic approach. In addition, students work in small groups in primary health care units, and participate in health service delivery.

WHO has recently recommended establishment of family medicine departments in all medical schools, in order to expose and sensitize students to this field.

Objectives

To bring our thoughts and experiences in undergraduate training on Family Medicine at FMUG, share with others and to further develop our training.

METHODS:

1. Curriculum analysis of PHCCP and FM course
2. Presentation of results of evaluation researches that bring evidence based SWOT analysis of the programme and its effect on the students, families and the PHC providers.

Results

Most competencies conform with those required for the future FM Medicine doctors. The students attitudes towards Family Medicine was positive. SWOT analysis proved: implementation of this course is acceptable, and relationships between the partners do matter.

Recommendation: Continue training of the health care providers to train the students and involvement of the Family Medicine doctors in training of the students, and further researches.

Keywords: Undergraduate training, Family Medicine, Gezira, Sudan

OP-150

Report of Academics Activities Realized by Medical Students of the Firsts Period of PUC University at the Northwest of Goiânia

Lorena Nogueira Pacheco¹, Ana Lia De Oliveira Lima¹, Isabela Aniz Oliveira²

¹Department of Medicine, Pontifícia Universidade Católica de Goiás (PUC-GO), Goiânia, Brazil

²Department of Medicine, Universidade Federal de Goiás (UFG), Goiânia, Brazil

The medical school of Catholic University of Goiás (PUC-GO) is based on a methodology of problem-based learning, which aims to train doctors capable of an integrated, ethical and humane vision of the health-disease process. Therefore, the curriculum is developed based on theoretical and practical integrated axle and personal development axis. The project aims at training the student through direct contact with reality and with the current health policies, with the Unified Health System (SUS). In this regard, seeking an early integration with social reality and health services, the first period students are directed to carry out activities in the Northwest region of Goiânia, so they can get in touch with the needs of Northwest District health units and its strategic points. Activities were carried out in the School of Family Health Unit (UESF) in Vila Mutirão, in the Maternity Nascido Cidadão, in the House Seniors' residences in Vila Mutirão, at the Municipal Center for Early Childhood Education (CEMEI). Also in a state school in the region seeking effectuation of topics that were predefined by the professor Sandra Prudente and divided into the following areas: Thematic Area I, composed of the axes of acceptance and responsibility, bond, user autonomy, resolution, and permeability of social control and thematic Area II, composed of the clinical expansion axes, practical wisdom - scientific and popular knowledge, and local health education practices. To participate of these experiments was an enriching opportunity, as it created a bond between the population, staff and students. It also contributed to the process of health promotion and prevention, and to the learning process about the current health system, which changed the academics attitude.

Keywords: Public health, Medical School, Education, SUS

House Seniors'



Municipal Center for Early Childhood Education (CEMEI)



Municipal Center for Early Childhood Education (CEMEI)



Municipal Center for Early Childhood Education (CEMEI)



Municipal Center for Early Childhood Education (CEMEI)



Municipal Center for Early Childhood Education (CEMEI)



OP-151

Portfolio in postgraduate family medicine: experience from Saudi Arabia

Abdulelah Mutlaq Alqurashi, Saad Abdulrahman Alghamdi, Faisal Frahat, Almoutaz Alkhier Ahmed
National Guard Health Affairs

INTRODUCTION:

The health care system of Saudi Arabia has witnessed major changes since the early 1980s followed governmental commitment to the Alma Ata (USSR) declaration in 1978. One of the changes was the initiation of postgraduate training programs in family medicine. The Scientific Council of Family Medicine formed a committee to review and improve the program.

Objective of the study:

This study aims to assess residents' and supervisors' perceptions, experience and preferences about the use of portfolio in family medicine residency training program.

METHODOLOGY:

A cross-sectional survey conducted in family medicine residency training programs in the western region of Saudi Arabia including residents and supervisors using a validated self-administered questionnaire. All residents and supervisors at training programs will be invited. Total estimated number is 170 residents and 30 supervisors. The questionnaire includes information on participants' characteristics and questions to assess understanding the purpose and reasons for completing the portfolio. Questions are scored on a five point Likert scale. The questionnaires will be self-administered in the presence of the researchers for any inquires related to the questionnaire.

RESULTS:

One hundred and forty questionnaires were filled (70%). in supervisors group 66.6% filled the questionnaires and in the residents' group 70.06% filled questionnaires. The average score for resident's view of the portfolio was 3 while it was 3.6 in supervisors' group ($P < 0.05$). In the resident group the average score for ownership and motivation to use portfolio was 3.5 while it was 3.8 in supervisors' group (P). Average score for agreement on sections that should contribute to assessment of portfolio was 2.8 while it was 4.5 in the supervisors' group (P value < 0.0001).

CONCLUSION:

There is a need for cautious assessment of the family medicine training program. Improvement should consider residents point of views.

Keywords: Family medicine, Portfolio, Training program, Saudi Arabia

OP-152

Expectations of General Practitioner trainees from courses designed in congresses A family medicine national survey from Turkey

Canan Tuz¹, Demet Merder Coşkun², Fethi Sada Zekey³, Fikret Merter Alanyalı⁴, Berk Geroğlu⁴

¹department of family medicine, baskent university, ankara,turkey

²department of family medicine, marmara university, istanbul, turkey

³department of family medicine, ümraniye eğitim araştırma hastanesi, İstanbul, Turkey

⁴department of family medicine,tepecik eğitim araştırma hastanesi, izmir,turkey

Courses play an important role in training process of General Practitioner (GP) trainees. The aim of this study is to identify the needs of GP trainees on subjects and learning methods of courses designed in congresses.

This is a cross-sectional study which was held in 2014 during a national congress named “Family Medicine Research Days” which was organised twice a year. Fifty two volunteer GP trainees were involved in the study. They performed a 10-item-questionnaire including demographics and questions about which subjects and learning methods would they prefer in courses designed in congresses.

Demographic data reveals that %69.2 were female and %30.8 were male. The average age was 28.6 SD 3.21. The average duration of training in family medicine was 1.79 years.

Ninety eight point one percent of participants wanted to attend a course during a congress, 90.4% had already attended a course and 44.2% found it useful. The most preferred subjects were practical administrations about office management and internal medicine with the rates of %80.8 and %61.5 respectively. Only %11.5 of participants were eager to know more about small surgeal techniques. Seventy five percent of them wanted to have a practical assesment and %57.7 of them wanted to join a session performed by an expert on the subject. Fifty three point eight percent of them chose video or film presentation in learning while only 12 residents chose of peer group learning. %44.2 of them wished to become an expert in some sub-specialties like obesity threathment and social pediatrics.

According to this study, GP trainees need to have courses about practical administrations about office management and internal medicine which should be performed by an expert by the help of video presentations.

Keywords: gp trainee, education, vasco da gamma movement, courses

OP-153

GPs facing medical liability: from knowledge to current practice

Humbert De Freminville

Department of family physician, University of Lyon, France

Background & Aim. GPs in France are concerned by the medical liability, and worries about it. Law 2002-303 formalizes the medical liability and patients' rights. Law No. 2004-810 defines GP and scope. The main objective is to assess the knowledge and sources of information of GPs related to these laws. Secondary objectives are whether these laws have changed GPs practice on the information and the doctor-patient relationship.

Method. A descriptive quantitative survey was conducted in France in the Rhone Alpes main aerea. An email explaining the purpose of the study was sent to 2,362 GPs via the mailing list of URPS professional database. 299 physicians participated anonymously. Chi2 test, and Chi2 Cochran-Armitage Test were used.

Results. 47% of GPs know the law 2002-303, without link between knowledge and involvement of medical liability. There is no link between the knowledge of the law 2004-810 and proceeding. Professional insurances are the main source of information for GPs. 64% of GPs have not changed the way they manage the medical file. 69% say that these laws have not changed the doctor-patient relationship. GPs indicate more changing in medical record related to information to the patient and doctor-patient relationship when knowing these laws.

Conclusion. GPs have a poor knowledge of the laws governing their practice. Their main source of information is their business insurance. Knowledge of the laws with the analysis of medical malpractice complaints helps to know the main causes of disputes and prevent them.

Keywords: GPs, liability, law

OP-154

One country, two types of medicine

Laura Montesinos Ramón¹, Estefanía Pérez Nicolás², Jennifer Lynne Brull³, María Dolores Marco Macián¹, Alejandro Salanova Penalba², Deborah Smith Clements⁴, Julie Wood⁵

¹Centro de Salud Burjassot 1, Departamento de Salud Arnau de Vilanova-Llíria, Valencia, Spain

²Centro de Salud Fuente de San Luis, Hospital Universitario Doctor Peset, Valencia, Spain

³Rooks County Health Center, Plainville, Kansas, USA

⁴Department of Family Medicine, Northwestern University, Chicago, USA

⁵American Academy of Family Physicians

We have made an exchange in USA with the FM360^o program (VdGM) in 2015. We would like to tell European Family Medicine Doctors our experience in Chicago and in Plainville (Kansas), because it is one of the most interesting things we have ever done during our residency as a Family Doctor. The opportunity to stay in two different areas, the rural one in Kansas and the urban one Chicago, has given us a general view of the country and we have learnt a lot about the American medicine and the american culture. In the village everything goes slowly and the medical resources are less than in the urban areas. As well, the number and the kind of patients is different. In Kansas people are older than in Chicago, and Doctors there, know the patients, their families, their problems, the kind of life, this give rural doctors a lot of information of the patients and the relationship between patient and doctor in more fluid and close than in the city. With this experience we have learnt a lot about The American Health system as well. It is very different if we compare generally with our European health systems. The big part of the American system is private and managed by Insurance Companies, but nowadays things are changing, and we have had de opportunity to see this. Now, exists "Obama Care". This new system allows that people without money can access to the health system, sometimes with restrictions but they can have medical basic assistance. We recommended to others residents and physicians this experience, because gives you the opportunity to learn about other health system, compare it with yours, and teaches you to understand the best things of our health systems and to learn the things that can be changed or modify.

Keywords: Rural medicine, Urban medicine, Exchange, health system In Northwestern University



With Dr Clements in Feinberg School of Medicine, Northwestern University, Chicago

Rural Rotation in Plainville



This is a Picture with Dr Bull in Rook County health center

Urban Rotation in Chicago



This is a Picture with Dr. Sha and family medicine residents in Chicago in Erie Family Health center

OP-155

BenZoPrev: Prevalence of benzodiazepine prescription in Family Health Unit Famílias

Ana Margarida Pinho, Tânia Martins Dias, Adriana Rosas Relvas, Ana Palhares Delgado, Ana Sofia Azenha, Célia Gomes Silva, Jacinta Oliveira Vaz, José Nunes Sousa, José Pedro Águeda, Maria Miguel Sá, Nádia Fernandes Correia, Sara Generosa Almeida

ACES Entre Douro e Vouga I Feira/Arouca, USF Famílias, Lourosa, Santa Maria da Feira, Portugal

Background & Aim

Benzodiazepines are a class of psychoactive drugs used to treat anxiety, insomnia and other problems. Chronic benzodiazepine treatment can cause tolerance, physical and psychological dependence.

The prevalence of benzodiazepine consumption in population-based studies range from 2 to 10% in the adult population. 15 to 30% of the consumers are chronic users.

Therefore, is essential to understand the prescription habits and to aware the physicians for the rational use of benzodiazepines.

With this study we aim to determine the prevalence and the type of benzodiazepine prescription and to analyze the influence of sociodemographic characteristics, alcohol and tobacco consumption, psychiatric and neurological disorders in the users.

Method

A cross-sectional analytic study was performed. A random sample (n=1360) of patients aged 18 or older from the Family Health Unit Famílias was studied.

The relation between Benzodiazepine prescription and age, gender, profession, educational degree, alcohol and tobacco consumptions, number of encounters from 2011 to 2013 and psychiatric and neurological disorders was studied. Type and duration of Benzodiazepine prescription were assessed.

Results

Prevalence of Benzodiazepine prescription between 2011 and 2013 was 22,9%. The chronic use of this drug was 46,3%. Alprazolam was the most prescribed benzodiazepine. A quarter of users were consuming more than one benzodiazepine at the same time.

There was a positive correlation with female gender, old age, low education, unemployment or retirement, psychiatric and neurological disorders and greater number of encounters.

Consumption of alcohol and tobacco had a negative correlation.

Conclusions

The prevalence of benzodiazepine consumption was higher to that found in other studies.

Despite this, the prevalence of chronic use of benzodiazepine is in accordance with published results. The consumption was more frequent in women and increases with age.

The benzodiazepine consumption didn't have association with alcohol and tobacco consumption, so there wasn't an overlapping of dependencies.

Keywords: Benzodiazepine, Prevalence, Primary Health Care

OP-156

Hemodialysis Units and the characteristics that influence the access to them

Christinne Maymone Gonçalves¹, Robson Yutaka Fukuda², Ana Rita Barbieri³

¹Faculty of Health Sciences, Medicine, Federal University of Grande Dourados

²Health Secretary of Mato Grosso do Sul State, Brasil

³Faculty of Medicine, Federal University of Mato Grosso do Sul

o Background & Aim

Knowing the factors that influence the access to health services contributes to the planning of public policies better. The Chronic Kidney Disease - CKD requires effective measures for health equity. In Brazil, the number of patients in dialysis in 2011 was 91,314, and about 85% of treatments were paid by the Unified Health System - SUS. This study described the profile of patients in the Midwest state of Brazil related to the rates of Sensitive to Primary Care Hospitalizations (ICSAP) and coverage of the Family Health Strategy (FHS).

o Method

Descriptive Study conducted in 2011 that analyzed 4,475 High Complexity Procedures (APAC) for the 1,340 patients residents in 78 Municipalities of Mato Grosso do Sul, that did hemodialysis in any of 13 clinics distributed in 7 Municipalities of MS. We used BioEstat 5.0[®] and Spearman's coefficient, for the analysis.

o Results

More men did hemodialysis, 0.67 ratio, with a predominance of young adults with a mean age of 53 years, followed by 23.27% of elderly, white race were 44.69%. There were not significant correlations between people on hemodialysis with the ESF coverage neither than ICSAP' rates. There was a positive correlation between the ESF coverage and ICASP rate ($\rho = 0.2713$, $p = 0.0287$), i.e. the greater the coverage of the ESF more ICSAP' rate high.

o Conclusions

It was identified less proportion of seniors making hemodialysis than other countries. There was no correlation between hemodialysis and the coverage ESF and ICSAP rate. But it was found a correlation between increased coverage ESF with higher rates of ICSAP, ie, municipalities are not reversing ICSAP rates, an important indicator of the quality of the ESF, which raises the need to expand research in this area.

Keywords: Hemodialysis Units, Public Health, Health Services Accessibility

OP-157

The Impact of new roles for nurses and allied professionals on practice (MUNROS study)

Antoinette De Bont¹, Iris Wallenburg¹, Juliane Stahl³, Silvia Coretti⁵, Nina Berven⁴, Sinem Erinc⁸, Maarten Janssen¹, Marie Zvoníčková⁶, Tomasz Ludwicki⁷, Job Van Exel¹, Robbert Elliot², Christine Bond²

¹Erasmus University Rotterdam, Rotterdam, The Netherlands

²University of Aberdeen, Aberdeen, Scotland

³Berlin University of Technology, Berlin, Germany

⁴University of Bergen, Bergen, Norway

⁵Catholic University of Sacred Heart, Rome, Italy

⁶Charles University Prague, Prague, The Czech Republic

⁷University of Warsaw, Warsaw, Poland

⁸Economic Policy Research Foundation of Turkey, Ankara, Turkey

Background & Aim

European countries are extending the roles of nurses and introducing allied professionals to improve health care services. The MUNROS project will assess the outcomes of these changes in primary care and hospital care. The aim of this study, one of ten stages of MUNROS, was to explore new professional roles.

Methods

Two case studies in each of eight countries were undertaken in primary clinics and hospitals for three conditions: diabetes, breast cancer, acute myocardial heart infarction. Countries included: Czech Republic, Germany, Italy, Netherlands, Norway, Poland, Scotland and Turkey. The case studies included 160 semi-structured interviews with professionals and managers, and 600 hours of observation to explore how new roles are formed and allocated.

Results

Across the eight countries new roles for nurses and allied professionals developed in two directions. The first direction is specialization. The key examples are specialist nurses and specialist technicians. Delegated work is diverse and extensive. It includes screening, triage, diagnostic examination, the design of therapy and even high-risk therapies. The second direction is innovation of services. Key examples are a practice nurse, an out-patient-clinician or an advanced nurse practitioner. They provide new services to patients, such as a clinic for adverse drug effects or daily outreach support to patients.

We identified four patterns: 1) the traditional skill mix with physicians and nurses; 2) a highly specialized skill mix with specialized physicians, specialized nurses and specialized technicians, 3) an innovative skill mix with advanced roles for allied professions, and 4) specialized innovative skill mix that combines the specialized skill mix and the innovative skill mix.

Conclusions

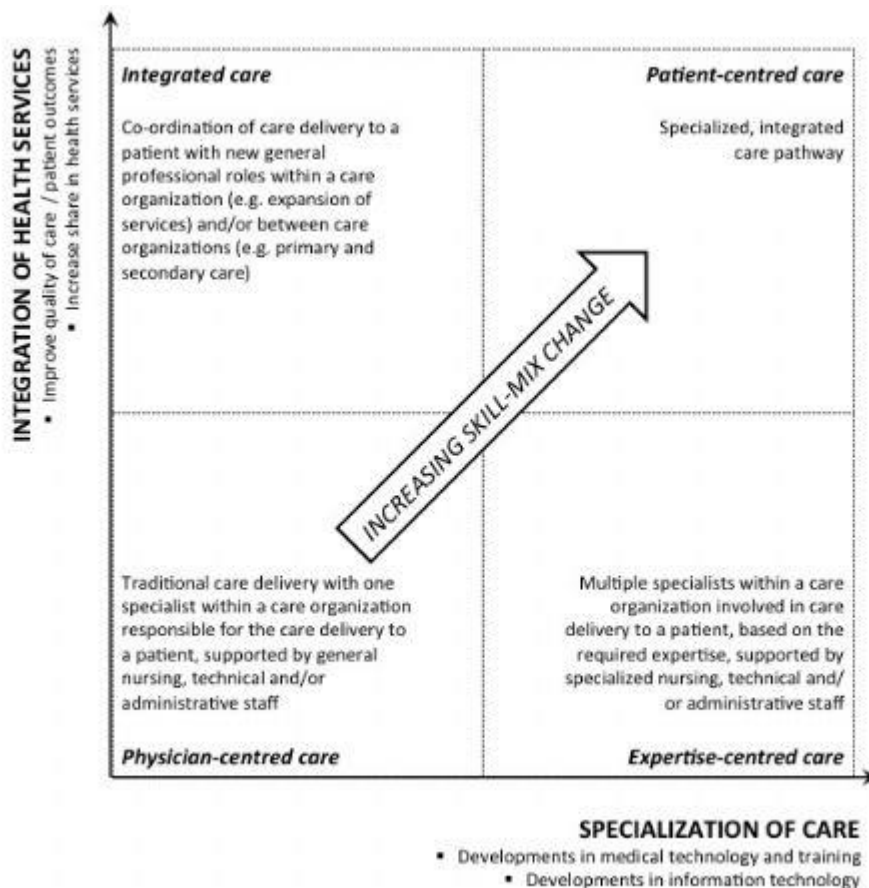
Changes in professional roles occur in all countries, but there is variation in the exact patterns observed.

Discussion

New professional roles increases competition between primary care clinics and hospitals over who coordinates care and who provides general care.

Keywords: integrated care, new professional roles, comparative study, Europe, skill mix

Patterns in skill mix



OP-158

Do structural aspects of health services contribute to reducing mortality rate by hypertension?

Ana Rita Barbieri¹, Crhistine Maymonne Gonçalves², Maria De Fátima Meinberg Cheade¹, Cleuzieli Moraes Santos³, Daniel Henrique Tsuha³, Cristina Souza¹, Kássio Costa Ferreira¹

¹Universidade Federal de Mato Grosso do Sul

²Universidade Federal da Grande Dourados

³Secretaria de Saúde de Mato Grosso do Sul

Background & AIM: The impact of chronic diseases on the countries' health services poses an important health issue. The surveillance, prevention and treatment of high blood pressure (hypertension), a disease with severe morbidity and mortality, can be performed in primary care, especially in the Family Health Units (USF), with good results. This study discusses the variables of coverage and structure of USF associated with rates of mortality caused by hypertension.

METHOD: Searches have been done in the Mortality Information System (SIM) and systems of primary care (SIAB) of 78 municipalities in the state of Mato Grosso do Sul, Brazil, with about 2.6 million inhabitants. The prevalence of the disease was calculated for three age groups: over 18 years, between 60 and 69 and above 75 years. The Pearson correlation allowed the analysis of the association of variables. The study was funded by FUNDECT and authorized by the Ethics Committee.

RESULTS: Municipalities with a larger number of patients treated by health teams, whether or not in the primary care units, presented higher death rate ($p < 0.025$). However, in a specific region with 17 municipalities and 1,056,932 inhabitants, association was seen between reduced mortality and USF coverage ($p < 0.001$). A negative correlation was also found between the rate of mortality caused by the circulatory system and the amount of physicians and other professionals, that is, the greater the number of these professionals, the lower rates of mortality by the circulatory system ($p < 0.046$).

CONCLUSIONS: Preliminary results of this study highlight the importance of a comprehensive coverage of Family Health Strategy as a policy to ensure the equity of the population's access to health services so as to reduce mortality by chronic diseases such as hypertension. Ongoing analyzes will examine the relationship between the distribution of services and morbidity/mortality.

Keywords: Public health, Equity, Health Access Accessibility, Family Health.

OP-159

Organisational reforms in Portuguese health care 2005-2015 – what impact on primary care?

André Biscaia¹, António Pereira², Sílvia Machaqueiro³, Luís Velez Lapão⁴, Paulo Nogueira⁵, Ana Rita Antunes³

¹Unidade de Saúde Familiar Marginal, ACES Cascais

²Unidade de Saúde Familiar Prelada, ACES Porto Ocidental

³Associação para a Cooperação e Desenvolvimento Garcia de Orta (AGO)

⁴Instituto de Higiene e Medicina Tropical – Universidade Nova de Lisboa

⁵Direcção-Geral da Saúde

Background and aim

Over the past years Portuguese primary health care (PHC) went through a number of important evolutions, including the design and implementation of new organisational structures, the reorganisation of PHC services and the decentralisation of decision-making.

One major health care reorganisation introduced Family Health Units (USF) – small multi-professional and self-organized teams of public administration employees with broad technical and organizational autonomy to take care of a defined population – and ACES (health centre groups) as the cornerstone of the 2005 PHC reform. The Local Health Unit (ULS) model was revived, aiming at integration of care through joint management of primary and secondary care in a specific area.

This reform movement brought a recently-emerging municipalisation trend, which introduces an organisational

and administrative decentralisation to municipalities.

Method

A literature search and review were performed using terms like “primary health care”, “family health units”, “reform”, “local health units”, “municipalities”. Resulting selected papers, legislative documents and reports since 2005 were reviewed.

Results

Overall, USFs have improved coverage and access to PHC, covering about 47% of the population at the end of 2014. The USF model was considered efficient. There are currently 418 active USFs and an average of 95 new applications are submitted each year.

Conversely, ULSs haven't had the intended impact on access, quality, continuity of care and financial efficiency as measured by indicators like waiting times, ratio nurses/doctors and number of avoidable hospitalisations. ULS are still dominated by the hospital partner inertia.

Conclusions

Although ULSs are seen as a “failed experiment”, USFs are widely regarded as a success concerning efficiency, access and proximity of care.

Having only officially been legally outlined in 2015, it remains to be assessed whether municipalisation of administrative competencies in Health will have a positive impact on local healthcare management, particularly PHC.

Keywords: primary health care, family health unit, health care reform, impact

OP-160

The Role of a Short Stay Unit in the Municipal Polyclinic of Mytishi, Moscow Region of Russia

Boris Valentinovich Agafonov¹, Lubov Kikot¹, Natalia Shevtsova¹, Lesca Cherise Hadley²

¹Moscow Region Clinical Studies Institute, Moscow, Russia

²John Peter Smith Hospital, Ft. Worth, Texas, United States of America

BACKGROUND: Twelve years ago, in accordance with the Russian Federation health improvement programs, the Short Stay Unit of the City Polyclinic at Mytishi was developed to provide effective and efficient care of the patients in the local area. This oral presentation will demonstrate the medical, economic, and social benefits of a Short Stay Unit when it is integrated into a primary care clinic.

METHOD: An overview of the Short Stay Unit will be described which will include the number of available beds, instruments and medical personnel. Common procedures as well as the most prevalent indications for stay will be presented.

RESULTS: The Short Stay Unit has resulted in a 40% decrease in general practitioners' hospital referrals. 96.5% of the patients were discharged with “improvements in health” or a “restoration to health.” 92% of patients were discharged “able to work.” 3.5% of the patients were discharged with no change in their condition. 8% continued their treatment at home under a general practitioner's supervision. No patients from the Short Stay Units have required a transfer to the hospital for the last 3 years. The Short Stay Unit costs 2.2 times less per day than the hospital with the same medical outcomes. Beds may be used by three patients through the day decreasing costs. The Social Insurance Fund which provides money for those who have short term disability saves money by having the patients return to work more quickly. Medications and services are free for the Short Stay Units in accordance with the Russian Federation state programs thus improving patient's satisfaction. Successes and challenges in implementing the short stay unit will be discussed.

CONCLUSION: Short Stay Units in Multispeciality Clinics may provide cost-effective care in a coordinated setting with high patient satisfaction.

Keywords: Clinic, Satisfaction, Outcomes, Health, Unit, Cost

OP-161

Managing Urinary Incontinence: The Difference Between Clinical Setting

Maliza Mawardi¹, Noorzurani Robson²

¹Department of Family Medicine, Faculty of Medicine and Health Sciences, Universiti Putra Malaysia, Selangor, Malaysia.

²Department of Primary Care, Faculty of Medicine, Universiti Malaya, Kuala Lumpur.

Background & AIM:

Women are known to develop urinary incontinence due to various reasons as compared to men. More than half of women in Malaysia with urinary symptoms have urinary incontinence. Affected women would seek medical attention especially from primary care physician in relation to their problem. Studies have shown that urinary incontinence could be managed successfully at the primary care level. This study was to determine and to compare the management of primary care physicians in the management of female urinary incontinence in different settings of their practice.

METHODOLOGY:

A multi-centered cross-sectional study was performed among all primary care physicians practicing in the government health clinics in Selangor, Malaysia and a hospital based primary care clinic in Kuala Lumpur Selangor using a self-administered questionnaire. Samples were collected conveniently in September 2012. Analysis was performed using SPSS version 21. Descriptive analysis and analysis of association were performed using chi square test. This study is a sub-analysis from a study on "The attitudes and practices of primary care physicians in the management of female urinary incontinence".

RESULTS:

Most primary care physicians were determined that female urinary incontinence could be managed at the primary care level. However, primary care physicians from the hospital based primary care clinic had demonstrated significant associations in majority aspects of management female urinary incontinence. This includes both investigation and treatment.

CONCLUSION:

More studies need to look into the aspect of reasons why physicians in the government health center had significant difference in managing female urinary incontinence at the primary care level.

Keywords: urinary incontinence, primary care physicians

OP-162

Health Policy of the Primary Health Care: an overview of family medicine in Macedonia

Kiril Soleski

Association of GP/FM of Macedonia

Introduction

Health systems centred on Primary Care represent a global objective and a clear way of evolution. A strong Primary Health Care (PHC) system results in a healthier population and may affect population health more than specialized services. Family medicine in Macedonia began to implement in 2009 starting specialist studies in family medicine. This process was supported by international grants. After this support has ended, it is important to keep up with the development and priorities.

Aims and methods

The aim of this paper is to analyze the current legislation and strategies for family medicine and to give proposals for its future development. Information about the situation was gathered from literature reviews and personal interviews.

Results

Data demonstrate that family medicine has been formally recognized and introduced in university curricula. The key areas of concern are lack of interest for specialization, atomization of practices, unsatisfactory payment systems, lack of academic infrastructure and unsatisfactory continuous professional development. On the other hand the Department of Family Medicine was established, specialization of family medicine and additional education for general practitioners has begun. Family Medicine is a fundamental part of primary care and many studies conclude that it should be organized into group practices or health centers. There is a hidden threat of bureaucratization, where health centers lose their basic functions. According to the Health Strategy, all doctors working in the family medicine service are supposed to have undergone specialization by the year 2020. A multilayered financing model must be used: containing a capitation coefficient based on the severity of illness, fee for service payment, payment based on quality indicators and specific program paying.

Conclusion

The position of family medicine in Macedonia is formally adequate, but a lot of effort will still be necessary to achieve the desired level of its recognition, functionality and quality.

Keywords: Family Medicine, Health Policies, Primary Health Care

OP-163

Strategy to improve the implementation of ecography in primary care

Lourdes Martin, Alejandro Abon, Pilar Garcia, M Luz Peralta, Maite Sanz, Francisca Rodriguez, Javier Roldan
Dirección Asistencial Oeste, Gerencia de Atención Primaria, Madrid, Spain.

Background and aim

As a diagnostic tool ecography increases the clinical performance of family doctors. It improves clinical decisions and enhances the satisfaction and confidence in the doctor to patient relationship.

To increase and improve the use of ecography in primary care.

To provide adequate training in ecography to family doctors.

Methods

Cross-sectional study with a management intervention performed in 14 rural and urban primary care centers of the western part of the Community of Madrid with an estimated population of 320000 inhabitants, between July and October 2014.

Structure of the interventional strategy:

1. Identification of trained doctors and those performing ecography on a routine basis.
2. Individualized working meetings on primary care centers with available ecography.
3. Follow-up and individualized support of the training program to doctors voluntarily involved in the project.

Results

Among ecography trained doctors 61% of them use the test regularly (more than 5 ecographies per year). During the first 6 months of 2014, a total of 524 ecographies were performed. After the intervention this figure raises to 846 on the same period of time. The yearly evolution and number of centers performing ecography is 513 in 2012 in 7 centers (average 73.2 ecographies/center/year), 960 in 2013 in 11 centers (average 87.2 ecographies/center/year) and 1426 in 2014 in 14 centers (average 102 ecographies/center/year).

Conclusions

Primary care support strategies and management training in ecography increase the number of ecographies performed at primary care centers. Since training in ecography is multidisciplinary, internal training management in primary care centers is crucial to improve the learning curve of ecography among family doctors.

Keywords: Ecography, training management, primary care

OP-164

Breast Cancer on the Internet: Quality of Information and Popularity of Turkish Websites

Ebru Yılmaz¹, Yusuf Üstü², Selçuk Yıldız¹, Sevim Öğülmüş¹, Mehmet Uğurlu²

¹Department of Family Medicine, Ankara Atatürk Training and Research Hospital, Ankara, Turkey

²Department of Family Medicine, Yıldırım Beyazıt University, Faculty of Medicine, Ankara, Turkey

Background and AIM: Use of the Internet is increasing and many patients are turning to the Internet to search for health related information. But the Internet has provided great opportunities for disseminating both accurate and inaccurate health information. Therefore we aimed to determine the characteristics of breast cancer related Turkish websites and whether more popular sites are of higher quality.

METHOD: The most popular search engines Google and Yandex were used to generate a list of websites about breast cancer. Top 100 sites per each search engine were recorded to analyze, which were returned in response to the query 'breast cancer'. Web sites were excluded from the analysis if they contained irregular information (eg, corporate advertisements, blogs), repetition or were inaccessible. Each selected websites was assessed using two qualified tools including Google PageRank for popularity and the LIDA tool for quality.

RESULTS: 67 sites were eligible for evaluation. 55,2% (n=37) of the sites were found to be individual. The author of the 36 sites (53,9%) was not clear. The mean of Google PageRank of the sites was 1,28. The mean of total score of LIDA tool was 54,6±14,7 and the mean of the reliability score was 17,5%±18,2. The LIDA values for reliability was poor. There was no significant correlation between the variables of LIDA tool and PageRank (p>0,05).

CONCLUSIONS: We tried to identify the current status of the websites by generally accepted particular quality tools. According to our study breast cancer related sites are unreliable. There is a need for the further studies that evaluating the effects of these information on the patients' health.

Keywords: Breast Cancer, Web sites, Quality

OP-165

Evaluation of efficiency and efficacy in the surveillance and monitoring of diabetes in primary health care - a Portuguese case study

Maria Castelo Gouveia, Maria Isabel Climaco

ISCAC, Quinta Agrícola - Bencanta 3040-316 Coimbra, Portugal

This study assesses the efficiency of Primary Health Care units monitored by a Group of Health Centers in a Portuguese region regarding the surveillance and control of diabetes under two perspectives: use of resources and clinical efficacy of services. The study uses the Value-Based Data Envelopment Analysis (DEA) method, combining a DEA additive model with Multi-Criteria Decision Analysis allowing the incorporation of management preferences.

Resources include the time devoted by doctors and nurses to the diabetic patients, the costs of medication, and complementary means of diagnosis and treatment prescribed. The outputs are the number of patients with consultation registers of weight and height, LDL cholesterol levels, blood pressure, requests for analysis of microalbuminuria levels, feet exams, oral antidiabetics and/or DPP-4 inhibitor prescribed (if necessary), antihypertension medication prescribed (if necessary).

The assessment of clinical efficacy has as inputs the outputs of the efficiency evaluation of services concerning diabetes surveillance and its expected clinical RESULTS: number of patients with BMI >18 kg/m² and <25 kg/m², LDL cholesterol levels ≤100 mg/dL (mmol/L), blood pressure <130/80 and HbA1c ≤ 8%.

The results of the efficiency models enable to identify the potential of reduction of the number of doctors or nurses taking care of diabetic patients in healthcare units and units that should assess diabetic patients more attentively to allow for more efficient medical care. Units having the best practices and services are identified, with impact on the clinical wellbeing of patients. However, there are efficient units with low efficacy and inefficient units with high efficacy.

This analysis helped decision makers to identify best practices, sources of inefficiency and gaps in relation to best practices, leading to unveil improvement opportunities.

Keywords: Diabetes, Data Envelopment Analysis, Primary Health Care, Efficiency

OP-166

Modelling Primary Care Reform Strategies

Joachim Sturmberg

Newcastle University - Australia

BACKGROUND: rising healthcare costs are perceived to be driven by the ageing of the population, increasing patient demands secondary to the medicalisation of everyday life, and new technologies and drug developments. Governments and funders alike favour financial incentives and disincentives as the tools to curtail the over use of medical services by patients and providers alike.

AIM: to assess the outcome of service utilisation changes on health service use and costs

METHOD: we built a model of the healthcare system based on Kerr White's "the ecology of medical care" framework. Based on consensus assumptions we modelled changes in people's health seeking and health service use individually and in combination to assess the impact on primary-care workload, secondary care workload and health professional provider costs, as well as their impact on the consumption of pathology and radiology services and prescribing.

RESULTS: the results of this modelling work will be presented at the meeting and its consequences for individual practitioners and the health system at large will be explored.

CONCLUSIONS: modelling health reform ideas prior to their implementation offers a way to engage all affected parties in the reform process. Greater transparency and participation in exploring the issues and their potential solutions will achieve more acceptable solutions to keeping healthcare systems financially sustainable.

Keywords: modelling, health system reform, primary care, health service utilization

OP-167

private or salaried practice: how do general practitioners make their choice? A qualitative research study in France

Shérazade Kinouani, Gary Boukhors, Baptiste Luaces, Bernard Plédran, Bernard Gay

Department of general practice, University of Bordeaux, Bordeaux, France

Background & AIM: in France, the primary health care system is largely based on the private practice of general practitioners. The number of general practitioners who had exclusively a private activity has decreased of 4.4% these last seven years, while the number of salaried general practitioners has increased. These trends could continue, at least until 2020, in spite of measures taken by French government or local communities to encourage young practitioners to choose private activity. The aim of this study was to explore the reasons determining choice between private or salaried practice among young general practitioners in Gironde (France).

METHOD: a qualitative study was conducted by semi-structured interviews with a purposive sampling of young general practitioners in Gironde between June 2013 and April 2014, until reaching saturation. Data were analyzed according to Grounded theory, after triple coding.

RESULTS: Through the 16 interviews led, multiple occupational factors were found, the first being professional interest. Their choice was not much influenced by the installation location (rural or urban). The occupational factors had to be consistent with their private (family or social) life. Young practitioners were attracted by health centers. They hoped a less intensive work rhythm, which would lead to a better quality of care, an easier access to team work or the possibility of advantages of the public area in general practice. They thought current incentives were not efficient enough, inaccurate and weakly known.

CONCLUSION: The problem of French medical demography could be resolved with incentives who take into account at a time the needs of population and the wishes of young doctors. A political effort must be made in order to give to the French universities enough resources to train and encourage the future general practitioners to the private practice. **Keywords:** general practice, private practice, qualitative research

OP-168

Implementation of the French patient safety program The first results of patient safety in primary care

Jean Brami, Bruno Bally, Laetitia May
Haute Autorité de Santé (HAS), France

Historically, the two seminal reports, "To err is human" and "An organization with a memory", were only concerned with adverse events occurring in hospitals, where the level of severity of harm is more important than in primary care, due to the greater use of invasive techniques. Arguably, however, the ambulatory environment is very different from the hospital environment. In particular, the number of encounters with patients is comparatively much higher. For example, in France there are one million consultations a day with GPs, making the likelihood of errors larger than in hospitals.

The French Government has launched a five-year program (2013-2017) in line with international recommendations, which includes the recommendation on patient safety adopted on 9 June 2009 by the European Union Council, which aims to promote the emergence and development of a safety culture that associates users and health professionals, and reduce preventable adverse events.

The Haute Autorité de Santé (HAS) - or French National Authority for Health - is one of the main intermediaries in the implementation of the actions defined in the program. These actions are structured around four axes: (1) patient information, the patient as co-actor in patient safety; (2) reporting of serious adverse events; (3) training, safety culture and support; and (4) innovation and research.

In order to evaluate the results of this program, a survey was conducted among GPs, nurses and pharmacists. The first results of this survey were presented at the 2011 WONCA conference in Warsaw. A second survey will be conducted at the end of 2017.

This seminar will present what is being done on patient safety in primary care in France at local and national levels to share with colleagues from other countries our experience and help building a European network on this very important topic.

Keywords: Patient safety, primary care, safety culture, France

OP-169

Trends in social inequalities in health during the recession: the example of diabetes

Ludovic Casanova¹, Adriana Martin De Vidales¹, Sebastien Cortaredona², H el ene Carrier¹, Pierre Verger²

¹Aix Marseille University, Department of general practice, Marseille, France

²INSERM, UMR912 "Economics and Social Sciences Applied to Health & Analysis of Medical Information" (SESSTIM), 13006, Marseille, France

OBJECTIVE

Social inequalities in health exist in the management of chronic diseases such as diabetes in France, as elsewhere. The recession that began in 2008 has led to increased income disparity. Has it also sharpened health inequalities? The aim of this study was to describe trends in these inequalities during this period through the example of diabetes.

METHOD

This analytic study used data from refund databases of the regional national health insurance fund (Provence-Alpes-C ote d'Azur region) and from socio-demographic databases of the national statistics office (INSEE) for 4 full years (2008 to 2011). It included individuals who had been reimbursed for 3 purchases of oral diabetes drugs during the previous year and evaluated the association between the median household income of each patient's municipality of residence and 7 indicators of diabetes monitoring and care. Using adjusted mixed logistic models, including an interaction term between time (number of years) and the median household income of the municipality, we examined the performance of the indicators for each year (i.e., whether the patient received the

care recommended that year). When the interaction term was significant, data were stratified by year.

RESULTS

The total number of patients with diabetes in the 941 municipalities of the PACA region varied by year from 142 055 to 164 929. Models showed that living in a town with a high or intermediate household income was significantly associated with better performance of the 7 indicators and that the interaction term was significant for 6 of them. The stratified analysis revealed that the effect of the municipal median income decreased significantly between 2008 and 2011 for 5 indicators: HbA1c, LDL-cholesterol, microalbuminuria, ophthalmoscopy, and endocrinology visit.

CONCLUSION

Social inequalities in health persisted between 2008 and 2011 in monitoring diabetes patients but appeared to be decreasing, despite the recession.

Keywords: Health Status Disparities Socioeconomic Factors Economics. Diabetes mellitus Secondary prevention Quality of health care

OP-170

Patient's Satisfaction in Primary Health Care, Bandung, Indonesia

Fedri Ruluwenta Rinawan, Nita Arisanti, Insi Farisa Desy Arya, Henni Djuhaeni, Guswan Wiwaha, Sharon Gondodiputro, Elsa Pudji Setiawati
Department of Public Health, Faculty of Medicine, Universitas Padjadjaran

Background

Patient satisfaction refers to the extent to which the patients perceived that their needs and expectations are met by the service provided. It means the best health outcomes that are possible given by the available resources should be consistent with patient values and preferences. Patient or client satisfaction is one indicator that can be used to determine whether the Health Care Provider will be a part of health insurance scheme. Universal health coverage in Indonesia was implemented in 2014 as well as in Bandung District.

This study assessed the level of satisfaction with quality of care received by patients attending a primary health care in Bandung District, Indonesia.

Method

This study was a cross-sectional study involving 486 patients in various type of primary health care in Bandung such as government primary health care (Puskesmas), private doctors, private midwives, and private dentistry. Adult patients were selected by cluster sampling. Respondent who met the inclusion criteria in each cluster was selected by consecutive sampling. Data were collected using 'Service quality' (servqual) questionnaire.

Satisfaction was measured by semantic differential scale from the following domains: tangibles, reliability, responsiveness, assurance and empathy.

Results

The result of this study showed that most of patient (72%) did not satisfy with the service provided in primary health care, specifically the patient did not satisfy with tangible (66.1%), reliability (57.5%), responsiveness (53.3%), assurance (47.5%) and empathy (59.3%). Dissatisfaction was expressed by most of patients attending government primary health care (Puskesmas).

For a country to achieve universal health coverage, several factors must be in place, including sufficient capacity of well trained, motivated health workers in providing the services to meet patients' needs. The government and private primary health care should make self-evaluation and improve the quality of health service.

Keywords: Patient, Primary Health Care, Satisfaction

OP-171

Effect of general practitioners' cooperative emergency care on hospital emergency department walk-in patients

Annemiek Bosch Van Nuenen¹, Dd De Jong¹, Frans Bongers², Johannes Mulder³

¹Isala Hospital, Zwolle, The Netherlands

²Hein Hogerzeil Stichting, Zwolle, The Netherlands

³Consultant Family Medicine. Zwolle, The Netherlands

BACKGROUND-AIM:

An increasing number General Practitioners' Cooperatives (GPCs) for primary emergency care are being encouraged to occupy a location next to the Emergency Department (ED) at hospitals with shared reception where walk-in patients are triaged to the most suitable form of emergency care. In this situation as a rule every walk-in patient is seen by the GPC triagist specialized nurse, unless clear acute ED treatment is required. Although this combined approach is presumed to be effective in financial and patient care terms, little research has been carried out into the effectiveness.

Method

This longitudinal, prospective study was performed at the Isala Hospital in Zwolle before and after co-location of GPC and ED in August 2013. Patient data were collected for all patients presenting at the GPC/ED during two four-month periods, before and after co-location starting December 2012 and December 2013. For walk-in patients the study registered the location of treatment, treatment times, diagnosis and costs.

RESULTS:

Walk-in patients at the ED before/after co-location: 757/303. Walk-in patients at the GPC before/after co-location: 324/855. Average Cost per patient at the ED before/after co-location: €1106/€1492. Average Cost per patient at the GPC before/after co-location: €108/€107. Median Treatment duration at the ED before/after co-location: 81/116 minutes. Median Treatment duration at the GPC before/after co-location: 27/31 minutes. In the period after co-location one patient had to be relocated from GPC to ED by the family doctor responsible for treatment. At the ED, during this second period a significant increase in cardiac problems and decrease in locomotor problems was identified. Extrapolating this to a year would suggest savings of one million euros a year.

CONCLUSIONS:

A significant drop in walk-in patients and costs was seen at the ED after co-location of GPC/ED and triage by GPC, with diversion of low complexity care to the GPC.

Keywords: Walk-in, Emergency Department, General Practitioners' Cooperative Emergency care, Family Medicine, health cost, prospective study

OP-172

Walk-in patient burden at Emergency Departments in the Netherlands in 2012

Annemiek Bosch Van Nuenen¹, Dd De Jong¹, Frans Bongers², Johannes Mulder³

¹Isala Hospital, Zwolle, The Netherlands

²Hein Hogerzeil Stichting, Zwolle, The Netherlands

³Consultant Family Medicine. Zwolle, The Netherlands

BACKGROUND-AIM:

Walk-in patients can be cost-ineffective if low complexity medical problems are treated at the relatively expensive ED instead of through General Practitioners' Cooperatives (GPCs) emergency care, which is well organized in the Netherlands.

An increasing number of GPCs are being located next to the Emergency Department (ED) at hospitals, with or without a shared reception where walk-in patients are triaged by the GPC to the most suitable form of emergency care. To establish a baseline of the walk-in burden the percentages of self-referrals in ED in the Netherlands in 2012 were assessed.

METHOD

This cross-sectional study was carried out by questionnaires at 95 EDs. The study year was 2012. The relationship

with proximity of a GPC and the effects of a shared reception/GPC triage were investigated. The influence of region, urbanization and distance to town center was also taken into account.

RESULTS:

Out of the 95 EDs, 69 (73%) responded. The average percentage of self-referrals was 28.7%. Highest level of self-referral was seen in the densely populated provinces of Noord-Holland, Utrecht and Zuid-Holland, with 40.6, 36.8 and 33.7% respectively. In the rural areas of Zeeland and Drenthe the level was lowest, at 3.2 and 5.8% respectively.

A GPC was situated at the ED in 44 EDs (64%), 9 (13%) of which had a shared reception and triage. With a shared reception ED walk-ins were 23%. With co-location but no shared triage, the percentage of self-referrals at the ED was 26%. Without co-location walk-in patients were 35%.

Urban EDs (situated in one of the 15 largest towns in the Netherlands) had 42% self-referrals, compared to 22% for smaller towns.

CONCLUSIONS:

There are significantly more walk-in patients in urban EDs compared to rural EDs. When there is co-location with a GPC, the walk-in figure drops significantly in this cross-sectional inventory study.

Keywords: Self-referrals, Emergency Department, General Practitioners' Cooperative, Walk-in patients

OP-173

The Avro City family medicine health center successfully setup at Duhok. Family Medicine in Northern Iraq: now more than ever. A joint Kurdish/Dutch initiative

Johannes Mulder¹, Rajab Hassan Sanaan²

¹Consultant Family Medicine/General Practitioner, Zwolle, Netherlands

²Directorate General of Health / Family Medicine program – Duhok / Iraq

BACKGROUND-AIM: Free primary healthcare is often centered around primary health care centers (PHCC). Key attributes of FM doctors, as distinguished from regular PHCC doctors, are implementing generalism (broad skills and ability to treat), continuity (returning to same doctor, medical records) and personal approach.

In 2013 we started the project "Family Medicine in Northern Iraq: now more than ever. A joint Kurdish/Dutch initiative" in which initial research into the problems was followed by an implementation program.

METHOD

One of the projects involved the creation of dedicated FM centers. Avro City family medicine health center (ACFM) was created for this purpose last year with Dutch GPs who introduced FM elements such as chronic disease protocols, patient record information system, open desk building design and waiting room with patient education and thorough patient communication skills. At ACFM there are 5 consultation rooms with three Dutch FM doctors and 2 local FM doctor trainees treating patients one at a time according to the Dutch FM history/physical exam SOEP (subjective, objective, evaluation, plan) with an electronic patient record system (EPRS) demanding ICPC classification. They are assisted by specialized FM nurses and laboratory staff who perform onsite diagnostics (eg EKG, Spiro) and laboratory testing (Hb1Ac, bloodwork) and patient planning with agendas for organized, individual FM consultation. Whole families are entered into EPRS with parameters like occupation and health risk factors. Furthermore patient referral is arranged when necessary.

RESULTS:

ACFM was successfully set up last year, in accordance with the FM implementation project guidelines adhering to the Dutch FM model. The main problems encountered were financial and organizational.

CONCLUSIONS: Implementation of first line healthcare for whole families in accordance with FM principles has effectively commenced and most set-up problems have been overcome.

Keywords: PHCC, Family Medicine, Health centers, Primary Care

OP-174

The use of teleconsultation to support the decision making process in the Brazilian Primary Care system
Lucas Wollmann, Milena Rodrigues Agostinho, Elise Botteselle De Oliveira, Luana Jonata Nunes De Moura, Erno Harzheim
Telehealth Network of State University of Rio Grande do Sul

Backgrounds & AIMS: The program TelessaúdeRS (Telehealth Network in the state of Rio Grande do Sul (RS), Brazil) aims at qualifying the practice of professionals of Primary Care (PC), assisting in making clinical and managerial decision. For this, it makes use of information and communication technologies for distance health-related activities. In March 2013, a toll-free telephone service was created to facilitate the task of PC professionals in real time by providing answers to the doctors and nurses through teleconsultations by phone, based on the best scientific evidence available, adapted to local needs and following the principles of the National Health System of Brazil.

METHODOLOGY: The service is available for doctors from all over Brazil's public PC system as well as nurses from RS. The teleconsultation starts when the professional calls for free the line: 0800 644 6543. After a first check to confirm the professional's registration number, the connection is passed on to a general practitioner (mainly family physicians) or to a nurse. The teleconsultant responds to questions in real time and If necessary the teleconsultant may require support from other specialists.

RESULTS: From March 2013 to March 2015, there have been 14.799 teleconsultations processed. As for the professional category of the callers, doctors accounted for 97.2%, and nurses for 2.8%. Among users having answered the satisfaction survey, 99% reported being satisfied or very satisfied with the service. 76% of referrals to other types of care were avoided from the total of teleconsultations initially requiring for a referral.

CONCLUSIONS: The system proved to be very useful tool since it provides a teleconsultation system with agility and good scientific evidence, of great assistance and managerial support for the Primary Care professionals. Developing a strategy to increase its use as well as integration of electronic records in health care is therefore essential.

Keywords: TeleHealth, Teleconsultation, Primary Health care.

OP-175

Primary Care Referrals And Communication Of Patients With Family Practitioners

Yasemin Kılıç Öztürk¹, Ayşegül Bayad¹, Yusuf Adnan Güçlü¹, Kurtuluş Öngel²

¹Izmir Tepecik Training and Research Hospital, Family Medicine Clinic, Izmir, Turkey

²Izmir Katip Celebi University, Faculty of Medicine, Department of Family Medicine, Izmir, Turkey

INTRODUCTION: Although referral system is widely used all over the world; unfortunately it is not a routine practice among the primary health care system in Turkey. Aim of the study is to investigate the referral status of patients admitted to a tertiary district hospital and their communication with their family practitioners.

METHODOLOGY: The study is conducted during october and september in 2014 at Konak District Hospital of Tepecik Training Hospital, which was formerly used as a delivery hospital. Face to face questionnaire is applied to patients older than 18 years.

FINDINGS: Four hundred and seven patients, 321 (78.9%) female and 86 (21.1%) male, were included in the study. Patients who never admitted to a primary care center was at a rate of 14.5% (n:59). Referral rate was 6.9% (n:28). Most of the referred patients were female (n:24; 85.7%). When communication of participants with family doctors was questioned; 311 (76.4%) of them described the condition; as "well" or "excellent". At least four times admission to health care centers was reported at a rate of 53.3% (n:15) among the referred patients. There was a significant difference between gender and self reported communication conditions of patients with their family practitioners'. Women reported their communication as "well" or "excellent" at a rate of 81.3% (n:261); while 58.2% among men. (p<0.001)

RESULTS: Referral rate was found to be very low. The rate of patients who never admitted to a primary care center was very high. Most of the patients have better manner about their communication with their family

practitioners'. Although female have a better communication with their family practitioners'. It may be due to the follow up visits for the 15- 49 aged women. Therefore, education of women about the primary care and referral systems may lead to increase referral rates.

Keywords: Primary care, referral, follow up, health care center

OP-176

Bolsa Família Program and the access to health of low income families of a city in the northeast of Brazil

Carla Santos Araújo, Aristóteles Homero Dos Santos Cardona Junior, Adam Das Almas Trancoso, Adson Gileade Cavalcante Do Vale, Artur Alves Da Silva, Camila Guedes Silva Pires, Eduardo Rafael De Lucena Costa Barbosa, Felipe Augusto Morais De Souza, Grace Evelyn Sarinho Gomes, Jéssica Tamires Souza Santos, José Everton Fagundes Da Silva, Luana Thaís Dos Anjos Leite, Láyla Moanna Araujo De Moraes, Michel Neri De Barros, Marcela Amorim Do Vale, Maria Eugênia Chaves Franca, Marília Branco Freitas, Nathia Maria Lorena Da Silva, Odara Ribeiro Miranda Caires, Raíssa Rocha De Holanda Vasconcellos, Stenio Wagner Sacramento Da Costa, Rafael De Abreu Maynard, Anderson De Almeida Pereira, Lino Martins De Oliveira Sobrinho, Davi Rios Do Nascimento
Federal University of Vale do São Francisco Foundation

Introduction

The Bolsa Família Program (BFP) is the largest government program of direct transfer of income in the world that aims to reduce socio-economic vulnerability of families whose income does not exceed € 22,00 EUR per capita per month. It is demanded that families fulfill requirements related to health and education to maintain the benefit, such as nutritional monitoring of children and school attendance. Programs focused on reducing socioeconomic and health inequity can positively impact on controlling diseases linked to poverty. Identify epidemiological data on health conditions of children can be important for evaluating program effectiveness in fulfillment of its goals. This research aims to evaluate the access to primary health care services among children and pregnant women of families that are BFP beneficiaries.

Results

There were 68 (41.97%) beneficiary families in the sample. There were 102 children between 0 and 9 years-old in those families. Among the analyzed children, 89.02% had an adequate body weight, according to the WHO Growth Standards. A satisfactory prenatal care was done in 95.96% of the pregnancies. Among the 36 2-years-old children of the sample, 86.11% were cared monthly by a Family Health Professional Team.

Methods

That was a quantitative-descriptive study, which used data from the Introduction to Integrated Infant Health Research, realized in the Jose e Maria's neighborhood (Petrolina, Pernambuco, Brazil) by the League of Family and Community Medicine of the Vale do São Francisco Federal University in 2014, 162 families were interviewed. The UNIVASF Ethic Committee has approved the study.

Conclusion

The study identified that the children have appropriate follow-up by the public health service and adequate weight, indicating absence of malnutrition and almost all of the women performed satisfactory prenatal care. These results are very positive, considering that the population studied is in the largest group of socioeconomic vulnerability in Brazil.

Keywords: Bolsa Familia Program, Cash Transfer, Brazilian Health Sistem

League of Family and Community Medicine from UNIVASF promoting a day of games with the children from the José e Maria's neighborhood



A member of the League of Family and Community Medicine playing with the children



OP-177

Correlation between the breath carbon monoxide levels and the period of smoking in nicotine addiction

Huseyin Can¹, Kaan Sozmen², Tijen Sengezer³, Yusuf Cem Kaplan⁴, Gokcenur Utlu¹, Alp Sener¹, Arzu Aybek Yilmaz¹, Olgu Aygun⁵, Zeynep Ay¹, Abdulkерim Damar¹, Burcak Bilgin¹, Yasemin Ceren Demirel¹, Halime Seda Kucukerdem¹, Hilal Ikbali Bilyay¹, Seyma Atsiz¹

¹Department of Family Medicine, Izmir Katip Celebi University, Izmir, Turkey

²Department of Public Health, Izmir Katip Celebi University, Izmir, Turkey

³Clinic of Family Medicine, Ankara Numune Training and Research Hospital

⁴Department of Pharmacology, Izmir Katip Celebi University, Izmir, Turkey

⁵Family Medicine Center, Izmir, Turkey

Background and AIM: Faulty measurements of CO may negatively affect the smoking cessation treatment. The exact measurement of CO must be performed within 1-2 hours after smoking. Here in our study, we aimed to investigate the relationship between the time elapsed since the last cigarette was smoked (TLC), and the amount of CO measured in the expiratory air (ExpCO) and the addiction levels of the smokers.

METHOD: This study had a cross-sectional design. Upon receiving the ethical approval, face-to-face interviews with the Fagerström test for nicotine dependence (FTND) were carried out with the participants. The amount of ExpCO of the participants was measured by the breath CO monitor. TLC of the participants were examined. The SPSS 15.0 for Windows statistics package program was used for the statistical evaluation of the data. $p < 0.05$ was considered to be significant.

RESULTS: 441 patients, of which 57.4 % were male, were enrolled in the study. Mean age of the patients was 43.2 ± 12.9 (range: 17-82), mean pack-years was 24.0 ± 16.4 (range: 1-100). TLC values in males were significantly lower than women ($p = 0.001$). A mid-level negative correlation was detected between ExpCO and TLC for both

sexes (M: - 0.434, p<0.001; F: - 0.535, p<0.001). FTND scoring showed 21.8% (n:96) of the participants had very high level of addiction, while 24.9% (n:110) had high and 22.0% (n:97) had middle-level of addiction. A significant positive correlation was showed between FTND score and ExpCO (E: 0.391, p<0.001; K: 0.471, p<0.001). CONCLUSION: Measures of breath CO levels later than 3 hours of smoking may yield lower results which may decrease the therapeutic compliance. Therefore accurate timing of measurement is crucial in the successful management of smoking cessation treatment and struggle with the tobacco addiction.

Keywords: Cigarettes, addiction, carbonmonoxide

OP-178
The Ecology of Care and it's Global Variants

Otto Pichlhöfer, Kathryn Hoffmann, Manfred Maier
 Medical University of Vienna

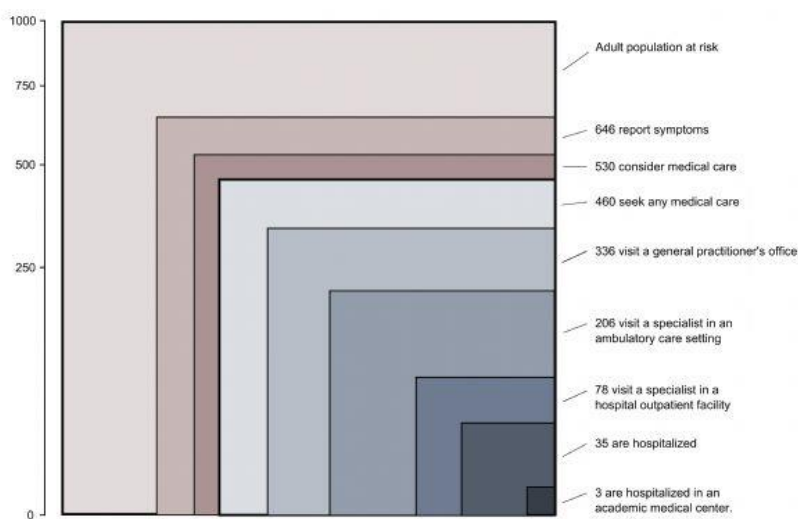
EOHCARE was a study designed as a CATI aided telephone survey of 3.500 Austrian individulas 16 years of age or older. The 35 item questionnaire assessed the utilization rates (UR) of health care services. We found very high URs especially at the secondary and tertiary care levels. The UR on the tertiary care level was four times of that reported by LA Green in 2001. A contributing factor to this overutilization and other week primary care functions — in the areas of continuity of care and coordination of care — is an unregulated patient access to all levels of care in Austria.

This presentation will review further international research that employed the “Ecology Model” of health care as originally proposed by K White in 1961. We will relate the various factors that contribute to the differences in URs at the different levels of care to health outcomes in a countrywise comparison.

Overall this work should contribute to a clarification of the role of Primary Care and clarify the factors that enhance its development under different health care systems.

Keywords: Primary Health Care, Ecology of Medical Care, Health Services Research

Ecology of Care in Austria



OP-179

Are there any differences in sick-leaves between rural and urban region in Croatia: a longitudinal study, 2001-2013

Vesna Tabak¹, Natasa Ban Toskic²

¹Family Practice „Dr. Vesna Tabak“, Breščenskog 3, Zagreb, Croatia

²Health Centre Zagreb-Centar, Martićeva 63a, Zagreb, Croatia

Background & aims

In Croatia, for more than six decades, people have recognised sick leave as a main right of employment, and it has been well regulated. Only family doctors keep the responsibility for sick leave certificate; each absence from the working place should be confirmed by the doctor's certificate. The survey on the trends of sick-leaves shown that the sick leave rates fell only slightly in fourteen-years with regional differences. This study is based on previous and it was carried out with the aim to investigate if there are any differences in the seek-leaves regarding rural, semi-rural and urban areas.

Methods

A study was observational and retrospective based on the official Croatian health insurance fund (CHIF) data. Annual number of patients on sick leave, the annual number of sick leave days, the average duration (in days) of sick leave per patient and the seek-leave rates were obtained for Croatia and separately for rural, semi rural and urban regions.

Results

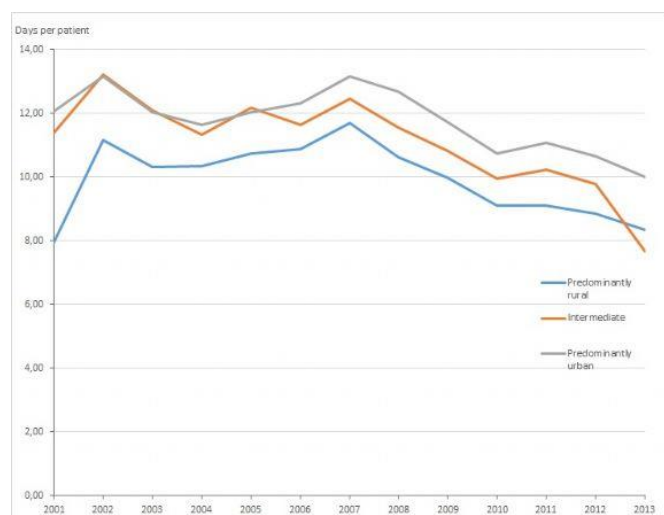
Total sick leave rate was varying between 3.3 in 2001 and 3.96 in 2007 and with decreased trend to 2.85 in 2013. The highest sick leave rate was in urban (3.87) and the lowest in rural areas (3.23). Moreover, the higher sick leave rates were perceived during whole observed period in urban, slightly lower rates in semi-rural and the lowest in rural areas. The number of sick leave days and the number of patients on sick leave, with some oscillations, remained the similar. The average number of sick leaves days per one patients was continuously higher in urban areas of Croatia.

Conclusions

During the observational period, the differences in sick leave rates and average number of sick leaves days per one patients were observed; they were always higher in urban than in rural areas.

Keywords: Sick leave, family doctor, urban and rural areas, Croatia

Average duration of sick leave per patient 2001-2013 (in days)



Health Indicators Among Young Adults in Two Workplaces in Southern Taiwan

Mei Chu Yenjean¹, I Cheng Lu², Mei Chu Yenjean³, Mei Chu Yenjean⁴, Shao En Sharon Yen⁵

¹Department of Occupational Medicine, E-Da Hospital, Kaohsiung, Taiwan, ROC

²Department of Family Medicine, E-Da Hospital, Kaohsiung, Taiwan, ROC

³School of Medicine for International Student, I-Shou University, Kaohsiung, Taiwan, ROC

⁴Department of Nursing, I-Shou University, Kaohsiung, Taiwan, ROC

⁵Department of Public Health, College of Medicine, National Cheng Kung University, Tainan, Taiwan, ROC

BACKGROUND: To explore health indicators including social and behavioral parameters among young adults in 2 workplaces in southern Taiwan.

METHODS: In accordance with the project of 2014 National Fitness Test, 652 young adults 23-34 years of age were recruited from workforce of an amusement park and a steel factory. All subjects completed physical fitness test (body mass index, 1 minute sit-ups, sit-and-reach, 3 minutes step test) and filled out the questionnaire, information of age, sex, monthly average income, education, marital status, hours of sleep in work days and off days, electronic media use, diet habit, smoking, betel nut chewing, self-rated BSRS-5 (5-item-Brief Symptom Rating Scale) score, happiness, healthiness and life satisfaction were collected with informed consent. The results of physical fitness test were further categorized into five grades of fitness according to the national norm provided by Administration of Sport of Ministry of Education of Taiwan. The predictors of psycho-social and physical fitness were explored by logistic correlation. All analyses were performed using SPSS software version 18.

RESULTS: There were significant difference in age, sex, monthly average income, education, marital status, hours of sleep in off days, hours of mobile phone use, smoking, betel nut chewing, self-rated BSRS-5 score, happiness, and healthiness between 221 subjects from amusement park and 431 subjects from steel factory. Predictors of higher BSRS-5 score included female (OR=3.85), less sleep hours in work days (OR=1.45 for every 1 hours less). Predictors of unhappiness included working in steel factory (OR=1.97), current smoker (OR=1.81). Predictors of overweight included male (OR=3.55), working in steel factory (OR=1.96). Predictors of poor 3 steps test result included working in amusement park (OR=1.72), monthly income less than 20,000 NTD (OR=2.63).

CONCLUSIONS: Health status of young adult in workplace is heterogeneous. Effort and resources in workplace health promotion should be tailored to their special needs.

Keywords: health indicator, young adults, workplace, physical fitness, BSRS-5 score

table 1

Table 1. Demographic data and psychosocial parameters of study subjects 23-34 years of age occupational groups

		Steel Factory (n=431)	Amusement Park (n=221)	p-value*
Age		29.52 (3.245)	27.60 (3.287)	<0.001
Gender	male	416(96.5%)	102(46.2%)	<0.001
	female	15(3.5%)	119(53.8%)	
Education	high school	90(20.9%)	21(9.5%)	<0.001
	university	340(79.1%)	200(90.5%)	
Marriage	married	315(73.1%)	186(84.2%)	0.005
	single	114(26.5%)	35(15.8%)	
	divorced	2(0.5%)	0(0.0%)	
Average monthly income (NTD)	less than 20,000	1(0.2%)	20(9.0%)	<0.001
	20,001 ~ 40,000	368(85.4%)	199(90.0%)	
	40,001 ~ 60,000	60(13.9%)	2(0.9%)	
	60,001 ~ 80,000	2(0.5%)	0(0.0%)	
Diet with late night snack	>=3 days/week	325(75.4%)	151(68.3%)	0.054
	<3 days/week	106(24.6%)	70(31.7%)	
BSRS-5(5-item Brief Symptom Rating Scale) score	0-5	393(91.2%)	168(76.7%)	<0.001
	6-9	33 (7.7%)	40(18.3%)	
	10-14	5(1.2%)	11(5.0%)	
	>=15	0(0.0%)	0(0.0%)	
Electronic media use: averaged hours/day	television	2.22 (1.401)	2.44 (1.652)	0.09
	computer	2.59 (2.274)	2.82 (2.299)	0.220
	mobile phone	3.34 (2.406)	4.34 (3.310)	<0.001
Sleep: averaged hours/day	workdays	6.77 (1.084)	6.69 (1.025)	0.348
	days off work	8.22 (1.414)	8.68 (1.761)	0.001
Self-rated health status	very healthy	36(8.4%)	10(4.5%)	0.003
	quite healthy	208(48.3%)	89(40.3%)	
	healthy	165(38.3%)	95(43.0%)	
	unhealthy	20(4.6%)	26(11.8%)	
Self-rated happiness	markedly unhealthy	2(0.5%)	1(0.5%)	0.012
	very happy	42(9.7%)	37(16.7%)	
	quite happy	200(46.4%)	110(49.8%)	
	happy	169(39.2%)	71(32.1%)	
	unhappy	18(4.2%)	3(1.4%)	
Self-rated life satisfaction	markedly unhappy	2(0.5%)	0(0.0%)	0.482
	very satisfied	35(8.1%)	22(10.0%)	
	quite satisfied	183(42.6%)	101(45.7%)	
	satisfied	184(42.8%)	86(38.9%)	
	not satisfied	24(5.6%)	12(5.4%)	
Smoking	markedly not satisfied	4(0.9%)	0(0.0%)	0.001
	never	284(65.9%)	177(80.1%)	
	current smoker	131(30.4%)	39(17.6%)	
Betel nut chewing	quit	16(3.7%)	5(2.3%)	0.02
	never	386(89.6%)	212(95.9%)	
	current user	29(6.7%)	6(2.7%)	
	quit	16(3.7%)	3(1.4%)	

*student t test for numerical variables, chi-square test for categorical variables

table 2

Table 2. Predictors of psychosocial parameters among young adults 23-34 years of age in 2 occupational groups in southern Taiwan.

	Odds Ratio			
	Higher BSRS-5 scores	unhealthy	unhappy	Unsatisfied about life
Occupation(ref = amusement park)		0.58	1.97	
Age (each increment of 1 year of age)			1.08	1.10
Male (ref =female)	0.26			
Monthly income(ref = less than 20,000 NTD)				0.30
Late night snack(ref = <3 days/week)		1.44		
Hours of sleep in work days(each increment of 1 hour)	0.69	0.78		0.85
Hours of computer use (each increment of 1 hour)	1.13			
Smoking(ref=nonsmoker)			1.81	

table 3

Table 3. Predictors of physical fitness parameters among young adults 23-34 years of age in 2 occupational groups in southern Taiwan.

	Odds Ratio			
	overweight	Poor 1 minute sit-ups result	Poor sit-and-reach result	Poor 3 minutes step test result
Occupation(ref = amusement park)	1.96			0.58
Age (each increment of 1 year of age)		0.93		
Male (ref =female)	3.55	2.21		
Monthly income(ref = less than 20,000 NTD)				0.38
Late night snack(ref = <3 days/week)		1.74		
Hours of computer use (each increment of 1 hour)		0.93		

OP-181**Methotrexate: We can do better. A novel approach to safer use of toxic medication**

Diarmuid Quinlan¹, Paul Ryan¹

¹Dr Diarmuid Quinlan, Dept of General Practice, University College, Cork, Ireland.

²Dr Paul Ryan, Dept of General Practice, University College, Cork, Ireland.

Background and AIMS:

Ireland has four times more methotrexate related deaths than England. Audit of my GP practice revealed methotrexate monitoring was both sub-optimal and non-compliant with new Irish Medicines Board(IMB) guidelines.

We undertook a multi-practice, interdisciplinary, patient focused, audit to make our entire town a safe haven for Methotrexate use.

METHOD:

We developed a patient held low cost "ALERT" card, educating and empowering patients.

We presented audit outcomes and "ALERT" card to 169 local GPs, 100 pharmacists and 25 hospital consultants, to inform, share and disseminate learning.

Engaged with GP software I.T. provider to embed safety notices for methotrexate.

Patients surveyed about perception of "ALERT" card.

Methotrexate AUDIT criteria:

For patients taking Methotrexate assessed whether

1. Blood testing BNF compliant.
2. Prescribing compliant with IMB guidelines.
3. Patient vaccinations compliant with national guidelines.
4. Patient education compliant with IMB guidelines.
5. Patient "immunosuppressed" prominently documented in the clinical record.

RESULTS: Impact and Improvements demonstrated:

-Appropriate (BNF recommended) blood testing: improved from 21% to 95% patients. Excessive blood testing curtailed, maintaining patient safety while reducing practice workload.

-Prescribing compliant with IMB guidelines: improved from zero to 65% patients.

-Vaccination status: improved from 63% to 85%.

-Patients surveyed; unanimously agreed "ALERT" card improved their understanding of methotrexate "It explains everything".

-Documented "immunosuppressed" improved from Zero% to 94%. Use of electronic "pop up alerts" increased from 7% to 30%. Local oncologist proposed "cross pollinating" "ALERT" card to patients receiving toxic chemotherapy medications.

CONCLUSION; Clear focus on patient empowerment, multidisciplinary collaboration, aligned with smart use of existing IT: This yielded significant audit proven, sustainable, improvements in patient safety. Electronic dissemination of both audit template and "ALERT" card facilitate easy, widespread dissemination and implementation.

Keywords: Methotrexate, Quality, Audit, Patient Safety

OP-182

Patient perceptions and expectations from primary health-care providers in India

Rashmi Ardey¹, Rajeev Ardey²

¹Dr Rashmi Ardey, Department of Family Medicine, Karuna Medical Center, Tkbd Extn, New Delhi, India

²Dr Rajeev Ardey, Department of Family Medicine, Karuna Medical Center, Tkbd Extn, New Delhi, India

INTRODUCTION: The study of patient satisfaction at the primary care level has been mostly neglected in India.

AIM: This objective of

this study was to assess indices of Patient Satisfaction at the level of the family physician which is usually the first point of contact

between the patient and the health-care system. MATERIALS-METHODS: This study was carried out at a Private Primary HealthCare

Center in a semirural area in New Delhi, by exit interviews in the form of a questionnaire from patients randomly selected

from people visiting the center during the study period. Statistical Analysis: Descriptive statistical analysis was carried out on

the data collected. RESULTS: The findings revealed that 83.58% of the patients were satisfied with the general experience and the

behavior of the health-care provider and 85.9% were satisfied with the treatment and care provided, only 65.5% were satisfied with

the physical environment of the clinic. However, the percentage of patients who would recommend the facility to their friends was

overwhelming (94.6%). CONCLUSION: These results show that private health-care providers are still the first choice for any form of

medical care. However, there was definitely a gap between the increasing expectations of the patients for more information, better

Patient-Provider interaction, more control over the treatment process and better amenities even at the Primary Care level. It is this

gap, which needs to be fulfilled to facilitate better utilization of Primary Health-Care Services in the community and reduce pressure

on tertiary care services in order to ensure Universal Health Coverage. This study would also help us understand the challenges for

Primary Care service providers, private and public, in a low socioeconomic urban setting.

Keywords: Family physicians, patient perceptions, primary care, primary health care

Overall rating of parameters of patient Satisfaction

General patient experience	Treatment and related information	Response of the paramedical staff	Physical environment	Overall experience
Weightage	Weightage	Weightage	Weightage	Weightage
15%	40%	15%	15%	15%

Being treated with respect and consideration interpersonal skills (93.8%)	Effectiveness of the treatment (88.2%)	Helpfulness and responsiveness of staff (83%)	Cleanliness of the waiting area (69%)	Overall satisfaction level (94.4%)
Confidence in the doctor	Explanation of the treatment plan (90%)	Willingness to listen to problems	Adequate and comfortable seating arrangement	Cost of treatment- (82.6%)
Waiting time (78.2%)	Explanation of the medication purpose (88.8%)		Availability of drinking water etc. (62%)	Chances of recommending the clinic (94.6%)
Satisfaction with the time given to patients- Female (91.36%) Male (90.36%)	Explanation of the purpose and necessity of tests required, if any (96%)			
Accessibility: Time taken to come to the clinic (82.25%)	Opportunity to ask questions (84.4%)			
Availability: Satisfaction with clinic timings (72.8%)				
83.58%	89.4%	83%	65.5%	90.5%

Overall care index

Conversion of ratings to numerical score

Excellent Very good Good Fair Poor

5 4 3 2 1

Conversion of measures to calculate overall performance index

Weighted scores of all parameters.

Criteria	General patient experience	Treatment and related information	Complaint management	Physical environment	Overall experience
Score	83.58%	89.4%	83%	65.5%	90.5%
Weighted score	12.53	35.79	12.45	9.825	13.575

OP-183

Enhancing quality in family practice: refreshing insight in skills and functioning of the Dutch GP

Stijn Van Den Broek

Dutch College of General Practitioners, Utrecht, Netherlands

Background & AIM:

Collecting and evaluating feedback about the way you are functioning as a doctor is mainstream during the education for GP's. Once the education is completed and doctors are practising as a GP this kind of feedback is less obvious. However it's a common belief and policy that continuous feedback and learning about one's functioning is necessary for keeping patient care professional and safe. The Dutch College of GP's developed a system of continuous feedback. "Self-Assessment, "Multisource feedback" and a personal development interview form essential elements of a medical appraisal of individual performance. The program that will be launched is called: 'Visitation Program for reregistration as GP'.

METHOD:

In 2011 a research and pilot for the evidence and experiences of doctor performance assessments had been carried out and the first experiences with 86 GP's were successful. Preparations to make a program available for all Dutch GP's have been made in 2013 by developing a form of multi-source feedback, which has been established in a second pilot. Also discussion leaders have been educated and evaluated. The last phase finished in December 2014 by developing and evaluating an infrastructure to implement this program.

RESULTS:

Based on international knowledge and experiences and evaluations of pilots, the visitation program was made as a compulsory item for reregistration as GP by the Dutch Registration Council of Medical specialists. From January 2015 all Dutch GP's can participate. During presentation the first experiences will be published.

CONCLUSION:

Medical appraisal of individual performance by Dutch GP's is a new item for reregistration as GP in Holland and enhances personal development and collaboration with colleagues in the interest of professional patient care. The Dutch Visitation Program made by the Dutch College of GP's provides a professional and self supporting, web-based system which can be used for years.

Keywords: functioning GP self assessment multisource feedback visitation program

OP-184

Do Primary Care Physicians Comply with ADA Guidelines in Diabetes Follow-up Visits?

Jihane Naous, Grace Abi Rizk

Department of Family Medicine, Saint Joseph University, Beirut, Lebanon

Background & Aim – Previous researches showed quality gaps in diabetic follow-up visits which might limit complications screening and risk factors control. This study measures physicians' adherence to guidelines to improve quality of care.

Method – All diabetic patients' medical files were retrieved from two Lebanese primary care centers. Eleven ADA-2013 guidelines were studied.

Results – There were one hundred and ten diabetics' medical files. The mean age of the patients was 62 years and the sex ratio 1. Physicians applied 5.1 ± 2.1 of the 11 studied guidelines. Regarding physical exam, blood pressure was taken in 75% of the visits, weight in 33% and the diabetic foot exam was done to 23% of the patients.

Concerning preventive measures, annual eye examination was ordered in 31% of the cases, influenza vaccine was recommended in 8.3%, aspirin was correctly prescribed in 80% and smoking status was documented in 58% of the files. As per laboratory exams, annual lipid profile was ordered in 75.5%, A1C in 1.31 ± 0.9 times per patient per year, creatinine in 63% and microalbuminuria in 52%. The mean of A1C was 8.03%, fasting glucose 163 mg/dl and LDL cholesterol 107.0 mg/dl. Microalbuminuria was detected in 54% of the cases. 73.5% of the patients had blood pressure $\leq 140/80$ mmHg, 28.2% had A1C $\leq 7\%$ and 45% had LDL cholesterol ≤ 100 mg/dl. There was no significant statistical relation between adherence to guidelines and achieving therapeutic target goals, while score adherence was higher when the visit was supervised by another physician.

Conclusions – Achieving target goals is a multifactorial process. Increasing awareness of the disease among diabetic patients could improve their compliance to the doctors' recommendations, while quality control of the visit and the file helps in full screening. Applying a check-list is likely to ensure a complete visit.

Keywords: Diabetes, guidelines, quality control

OP-185

Measuring transitional patient safety culture between general practice and hospital

Marije Van Melle, Henk Van Stel, Niek De Wit, Dorien Zwart

Department of General Practice, Julius Center for Health Sciences and Primary Care, University Medical Center Utrecht, Utrecht, The Netherlands

Background and AIM:

Patient safety is at risk when patients cross from one healthcare setting to the other. Precondition for improving the safety of these care transitions is a constructive safety culture between primary and secondary care. Aim of this study is to explore the perceptions of transitional patient safety culture among caregivers in general practice and hospital care.

METHOD:

We conducted a cross-sectional survey on patient safety in transitional care between Dutch primary care practices and hospitals. A digital questionnaire (TRACE) was dispersed in two regions, containing three hospitals and 62 general practices. The TRACE consisted of five dimensions: Collaboration, Transition, Freedom of feedback, Communication regarding incidents and improvement measures and Transitional patient safety. Items were scored on a 5-point Likert-scale

RESULTS:

189 healthcare professionals responded (response rate 33%): 65 from general practices and 124 from hospital. The data showed no strong dimensions -in which over 75% of respondents scored 4 and over. Moderate dimensions were "Collaboration" and "Freedom of feedback". Weak dimensions – in which over 50% of respondents scored 3 or less- were "Transition" (71% score 3 or less), "Communication regarding incidents and improvement measures" (85% score 3 or less) and "Transitional patient safety: (63% score 3 or less). These results

show that both general practice and hospital perceive mutual collaboration as suboptimal. The healthcare professionals acknowledge that things go wrong when patients transfer between general practice and hospital and vice versa. In addition, they rate overall transitional patient safety moderately which suggests room for improvement. Nonetheless, general practice and hospital do hardly communicate with each other about incidents and improvement strategies, even though they indicate feeling free to give and receive feedback.

CONCLUSIONS:

Patient safety culture is currently suboptimal. Especially mutual communication on incidents, risks and improvement measures should be stimulated

Keywords: Patient safety, Culture, transitional care

OP-186

Caring for patient safety between general practice and hospital

Leida Reijnders¹, Antoinette De Bont², Niek De Wit¹, Dorien Zwart¹

¹Julius Center for Health Sciences and Primary Care, University Medical Center Utrecht, Utrecht, The Netherlands

²Institute of Health Policy and Management, Erasmus University Rotterdam, Rotterdam, The Netherlands

Background

Transitions between general practice (GP) and hospital, such as discharge, referrals and medication continuity are identified as high-risk situations. Describing the differences in patient safety culture between GP and hospital is necessary for developing an intervention that improves transitional patient safety. This study aims to explore the experiences, perceptions and attitudes of healthcare professionals concerning transitional care and transitional patient safety.

Methods 14 focus group discussions on experiences, risks, solutions and the role of cultural differences regarding transitional patient safety were conducted with either general practitioners, or hospital care providers (n=105). Template analysis was used to analyze the data.

Results Both GPs and hospital care providers identified the same risks for transitional patient safety: delayed discharge letters, incomplete medication information and lack of communication in general. Overall, GPs didn't have sufficient knowledge of the working methods in hospitals and vice versa. Indeed, their working contexts differ substantially on patient populations, epidemiology of diseases and organizational structure. In contrast to the consensus about risks, GPs and medical specialists talked markedly different about patient safety incidents. While GPs focused upon specific incidents, hospital care providers merely focused upon generic problems. Where GPs' expressions indicated a personal approach, hospital care providers expressed a more managerial approach. In addition, our participants revealed difficulties in loyalty felt towards each other or to their mutual agreements on transitional care processes. Furthermore, the so-called no man's land between general practice and hospital, which actually characterizes transitional patient safety, was mentioned as detrimental to patient safety.

Conclusion

Both GPs and medical specialists identify the same risks, however, their working contexts as well as their attitude towards patient safety differs. We hypothesize that these differences affect loyalty to each other and broaden the no man's land between general practice and hospital. This complicates the improvement of transitional patient safety.

Keywords: patient safety (MeSH), continuity of care (MeSH), culture (MeSH), transitional care

OP-187

Reconciling medication between different healthcare levels

Alejandro Abon¹, Lourdes Martin¹, Carmen Plaza², Garcia Pilar¹, Peralta M Luz¹, Villimar Ana Isabel¹, Gangoso Ana¹, Dodero Javier², Barba Raquel³

¹Dirección Asistencial Oeste, Gerencia de Atención Primaria, Madrid, Spain.

²Dirección de Continuidad Asistencial, Hospital Universitario Rey Juan Carlos, Madrid, Spain

³Dirección Médica, Hospital Universitario Rey Juan Carlos, Madrid, Spain

Background and Aim

Medication mistakes are one of the leading causes of morbidity among chronic patients. These are frequently the result of treatment miscommunication between professionals at different healthcare levels.

The aim of this study is to implement a medication reconciling strategy between 9 primary care centers and their referral hospital.

Method

Nine rural and urban primary health care centers of the western part of the Community of Madrid and their referral hospital, University Hospital King Juan Carlos, were selected for the project. The electronic medical record and other tools such as the e-visit (online medical evaluation integrated in the electronic medical record) and the email were used to reconcile medication. The reconciling process was established both at admission and discharge during the month of March, 2015.

Results

Reconciling strategy at admission: using the electronic record, any doctor in the hospital may inform the liaison nurse about medical discrepancies. The liaison nurse is the person in charge of the communication between both healthcare levels. This information is passed to the primary care center where the family doctor clarifies the discrepancy by means of the specific reconciling e-visit.

Reconciling strategy at discharge: the doctor and nurse at the primary care center revise the hospital discharge report through their direct access to the hospital electronic record.

Conclusion

The reconciling medication strategy increases patient safety and decreases potential medication mistakes among different healthcare levels. Strategies like these are required as long as there is no shared medical record between different levels.

Keywords: Reconciler medication, health care levels, patient safety

OP-188

New type 2 diabetes guideline implementation at primary care in Ukraine: results, barriers and optimization

Victoria I Tkachenko

Shupyk National Medical Academy of Postgraduate Education

Background. New diabetes care guidelines was developed with our participation and approved in Ukraine since 2012. The content of primary diabetes care and quality indicators (QI) were indicated at first. The aim - to evaluate the quality of diabetes care, results and barriers of diabetes guidelines implementation. Materials and methods. We proposed complex data analyses, which included quality indicators monitoring, analysis of data from outpatient cards, statistical reports of medical facilities and survey of 536 general practitioners-GPs (using modified and validated GUIDANCE questionnaire) and survey of 459 diabetes patients with ADDQoI19 and DTSQ questionnaires (Bradley&Spleight, 2002). Statistical analysis - using Excell-2007, SPSS. Results. GPs'knowledge of diabetes guideline and adherence to its implementation in 2013-2014 are insufficient as quality of care, quality of life (AWI=-3,58±0,47points) and treatment' satisfaction (26,49±0,75points). The GPs'self-reported outcomes of diabetes care correlated to objective data from statistical reports and may be used during assessment. The 1st QI is development of local protocol that was barrier for GPs. We developed typical local protocol, it was approved by Health Ministry. The 2nd QI is percentage of patients with identified glycosylated hemoglobin, it was 8,84% in 2012, 12.2% in 2013 and remains low. The 3rd QI - percentage of admitted to hospital patients - increased from 8,66% in 2012 to15,01% in 2013. It can be explained by insufficient equipment of primary care, limitation in free laboratory tests, low economical level and low adherence of patients to self-management. The 4th QI is annual monitoring of patient' condition that is difficult to collect without electronic medical records. We developed a template for GP for collecting data, developed and implemented postgraduate course for GPs to optimize diabetes primary care. Conclusion. The quality is insufficient at early stage, the availability of laboratory tests at primary care and implementation of electronic medical records will improve.

Keywords: quality, diabetes primary care, guidelines implementation, Ukraine

OP-189

Prescribing quality in primary care physicians in Aktobe, Kazakhstan: a cross-sectional study

Lazzat Manbetzhanovna Zhamaliyeva¹, Mukhit Nauryzgalievich Turebayev², Akmaral Mukhanbetovna Altayeva², Aigul Sakariyevna Mussina³

¹Department of Continue Professional Development and Evidence Based Medicine, West Kazakhstan Marat Ospanov State Medical University, Aktobe, Kazakhstan

²Department of Family Medicine

³Department of Propedeutics of Internal Diseases

BACKGROUND: Adherence to principles of family medicine and evidence based rational prescribing increases the quality of health care and patient outcomes. In this study, the quality of drug prescription in primary care physicians in Aktobe city of Kazakhstan was assessed for the development of special education trainings. METHODS: a retrospective cross-sectional study was conducted to determine the current prescribing practice. Data of 480 randomly selected patients attending the primary care clinic in Aktobe were extracted from the manual medical records. The World Health Organization recommended indicators were used to evaluate the physicians' prescribing habits: the average number of drugs prescribed per encounter, the percentage of drugs prescribed by generic name, the percentage of encounters with an antibiotic and injections prescribed, percentage of drugs prescribed from an essential drug list. RESULTS: The median age was 37 years. Prescription analysis showed that the average number of drugs per prescription was 2.05. Assessment of prescribing indicators revealed over-prescribing of antibiotics among general physicians, basically for acute respiratory viral infections (31,5%). The percentage of encounters in which an injection was prescribed was 15.4%. The percentage of drugs prescribed by generic name was 36,4%. The

percentage of drugs prescribed from National Drug Formulary was 90.5%.

CONCLUSIONS: The results obtained in this study indicated non-rational prescribing. A larger study involving several clinics is warranted to assess the prescribing quality in primary care in Kazakhstan. We believe that the development of certain policies and continuous education is extremely important for quality drug prescription.

Keywords: primary care, quality indicators, prescribing practice

OP-190

Problem List: quality improvement of medical records in a Portuguese family health unit

Pedro Azevedo, Luís Pinho Costa, Cristiana Azevedo, Elisabete Castro, Sónia Moreira, Inês Souto
Unidade de Saúde Familiar de Fânzeres, Gondomar, Portugal

INTRODUCTION: Being central to the medical record, the Problem List highlights factors that can affect clinical management. However, its usefulness varies due to lack of consensus on the inclusion criteria, making it essential for teams to adopt a standardized approach that ensures data quality.

OBJECTIVES: Having observed criteria heterogeneity among our team, we've implemented a quality improvement cycle to increase the proportion of problems abiding by criteria meanwhile established by the team.

METHODOLOGY: We assessed the baseline proportion of criteria-abiding problems using a simple random sample of patients (May 2013). Criteria compliance was assessed by two reviewers and kappa statistic was calculated. For the next quarter year we delivered an intervention consisting of: weekly analysis of examples, individually and by the team; weekly training of the lists update on the electronic medical record software; c) daily screensaver reminding the criteria in use; d) always available PDF summarizing the criteria. In September 2014 we reassessed per the same methods used at baseline. We compared the proportions over time using the chi-square test. The quality standard (QS) was defined by team consensus: <70% insufficient, 70-79% reasonable, 80-89% good, ≥90% excellent.

RESULTS: 2101 problems were analyzed at baseline (352 patients, 48 ± 23 years; 57% women; κ inter-rater 0.83) and 2610 at reassessment (384 patients, 53 ± 24 years, 58% women; κ inter-rater 0.96). The proportion of criteria-abiding problems increased significantly (p <0.0002) from over 80% (QS: good) to over 90% (QS: excellent).

DISCUSSION: The intervention increased the proportion of criteria-abiding problems to levels of excellency, allowing for care of the highest quality and safety. The authors envision subsequent quality cycles aimed at assessing problems being under-registered, outdated, redundant or inappropriately coded according to ICPC-2.

Keywords: Medical Records, Problem-Oriented Medical Records, Computerized Medical Records Systems, Health Care Quality Assurance

OP-191

Using Information to Improve Coordination of Care

Karen Kinder, Craig Pollack, Klaus Lemke

Bloomberg School of Public Health, Johns Hopkins University, Baltimore, Maryland, USA

- **Background**

Patients with poorly coordinated care are likely to have more costly and lower quality health care due to factors such as excess utilization resulting from redundant investigations, potentially harmful missed drug-disease interactions, and lower patient satisfaction. Therefore, the identification of patients at risk of poor coordination is essential. This presentation will address the impact of information on improving coordination of care across the spectrum of the health care system.

- **Method**

The Johns Hopkins ACG® System includes four complementary coordination markers as well as a coordination risk score to systematically assess the risk of poor coordination of care. In combination, the markers can identify populations at risk for poor coordination which has implications for cost, quality, and performance assessment.

Studies have shown that when clinicians share patients with other clinicians more frequently, they are more likely to have referral relationships. A measure of patient sharing among physicians, termed “Care Density”, assesses the number of individual clinicians a patient sees and the degree to which those clinicians share other patients. The Care Density measure is based on the hypothesis that patients seen by clinicians who share patients more frequently have higher levels of communication and information sharing.

- **Results**

A recent study of the Care Density measure on 9,596 patients with congestive heart failure and 52,688 with diabetes demonstrated a significant correlation between lower inpatient costs and rates of hospitalization amongst those patients with high Care Density. Also, for diabetic patients with high Care Density, lower outpatient costs and higher pharmacy costs were found.

- **Discussion**

Through a better understanding of how patients are shared amongst clinicians, as well as identifying those patients at risk of uncoordinated care, coordination can be improved, rates of hospitalization reduced and potential cost savings achieved.

Keywords: Coordination, Continuity, Referrals, Health Information Technology

OP-192

Teaching Family Medicine Residents About Quality Improvement Practices Utilizing a Chronic Kidney Disease Co-management Project Involving Family Physicians and Nephrologists

Jerry W. Sayre

Mayo Clinic, Jacksonville, Florida, USA

Early identification and treatment of chronic kidney disease (CKD) allows for the provision of optimal patient care, slowing the risk of progression to advanced chronic kidney disease. Primary care physicians are the providers of the initial diagnosis, treatment, and referral, when necessary, for optimal patient care. Controversy and conflict occasionally exists among primary care physicians and nephrologists regarding the appropriate timing of these referrals. For example, recent clarification of CKD stages has not been uniformly accepted among all physicians. Another potential source of conflict has been gaps in the follow-up communication loops among the nephrologists, the referring physicians, and the patients. The Renal Physicians Association (RPA) has developed a validated communication toolkit to facilitate this process. Medical students are exposed to quality metric

concepts but have had little experience in developing and using quality improvement practices in patient care settings.

This project extends and uses the findings from a recent qualitative study of nephrologists and primary care physicians, involving the RPA CKD Toolkit, to introduce quality improvement practices to Family Medicine residents.

A pre-intervention survey is administered to assess residents' current knowledge of quality improvement processes. Family Medicine residents are given didactic instruction in quality improvement principles, followed by workshops involving experiential learning focused on identification and utilization of CKD toolkit items.

Residents then utilized this knowledge in communication with selected nephrologists, evaluating the potential utilization of quality improvement communication practices. Residents demonstrated their understanding of the quality improvement principles in CKD by verbal presentations to peers and core faculty.

This is proving to be a useful educational practice to train residents in both the methodological modalities of quality improvement and the usefulness of improved communication practices.

Keywords: quality, education, chronic kidney disease

OP-193

Validation of the Turkish Version of the Personal Feelings Questionnaire (PFQ 2): A measure for the tendencies to feel ashamed and guilty

Canan Tuz, Mehmet Ergun Öksüz

Başkent University, Family Medicine Department

Lewis (1971) in her contribution " Shame and Guilt in Neurosis" introduced that in shame the focus is on the global self, while in guilt the focus is on a specific behavior. In order to distinguish these emotions in various mental disorders quantitative assessment of shame and guilt using self-report questionnaires can help. One of the most popular questionnaires is Personal Feelings Questionnaire (PFQ 2) (Harder& Zalma, 1990) This study sought to validate a Turkish version of the PFQ-2.

A sample of 229 undergraduates completed the Turkish PFQ2. This study was conducted during March-April 2015 in Başkent University.

Factor analysis was performed to assess the underlying domain structure of the questionnaire and to evaluate validity, the degree to which each item is related to the hypothesized domain with which it is associated. The reliability was calculated by using Cronbach's alpha formula.

Based on clinical interpretations of a principal-components analysis, 2-domain structure was identified which included of Principle Component Analysis and Varimax rotation (Eigen Value ≥ 0.7). Scale with this nine domains expanded variance was %88.1. Item loadings were found between 0.465-0.853. The value of the scale was in level high reliability (Cronbach Alpha: 0.949). Subdomains were similar to the original survey as guilt and shame.

The PFQ2 exhibited satisfactory internal, and discriminant validity similar to the original American version. Moreover, the gender difference in shame and guilt was replicated.

This dispositional measure of shame and guilt was the first made available in Turkish and offers acceptable psychometric qualities.

Keywords: guilt, shame, validation, reliability, personal feelings questionnaire

OP-194

Real patient discussion at facebook. Did GP/FP curricula fits with daily cases

Emrah Kirimli¹, Özgür Akbaba², Cem Bilgiç³, Derya Yavuz⁴, Saide Eda Cebeci⁵, Erdiñç Yavuz⁶, Muhteşem Erol Yayla⁷, Tolunay Demirdamar⁸

¹Umraniye Merkez ASM, Istanbul, Turkey

²Beşiktaş 3 Nolu ASM, İstanbul, Turkey

³Beştepe ASM, Ankara, Turkey

⁴Yenimahalle Alacaaltı ASM, Ankara, Turkey

⁵Serdivan ASM, Sakarya, Turkey

⁶1 Nolu ASM, Rize, Turkey

⁷Mehmet Akif Ersoy ASM, Adana, Turkey

⁸Gazi ASM, İstanbul, Turkey

"Bugün bir hasta geldi" I had a patient today is a facebook group of Turkish family physicians. Where they discuss daily cases and ask to colleagues. Physicians add their current opinions and evidence about topic.

We investigated all case entries added through 2014 and cross checked if the cases are covered equally at board curriculum.

Our case discussion group consist of 678 physicians mostly family physicians and practitioners practicing as GPs and hospital specialists like radiologist, cardiologist, dermatologist etc and family physician academicians.

Practicing physicians comes with the patient and the question and people discuss on the topic, based on discussions, further investigations or new treatment options can be ordered. After these, case presenter discuss the progress of case. Minimum 2-3 cases added on daily base and all cases are answered in the same day. Discussions done by personal opinions bur are also supported by guidelines or current evidence.

This patient discussion group is all driven by daily routine and needs. In our presentation we will share discussion topics which were shared during 2014. We will sort topics of cases like Diabetes, arthritis, COPD etcç We will also present distribution of cases through medical topics like radiology, obstetrics, endocrine, pediatrics, infectious disease, orthopedics, respiratory, cardiology etc. Finally we will argue if it is in parallel with and covered by FP board curriculum and Turkish family physician textbooks.

Keywords: education technology, social media, peer learning, curriculum, professional education

Case shared by a FP



A daily case shared by a FP

Patient revisiting after discussions



Same patient after discussions

OP-195

Analysis of referrals from family doctors to Tallinn Children`s Hospital emergency room

Agne Liiskmann¹, [Helen Ling](#)¹

¹Tartu Ülikool

²Perearstikeskus Sinu Arst

³Pirita Perearstikeskus

Background and AIM: Tallinn Children`s Hospital (TCH) is the main provider and consulting hospital of specialised paediatric health care in Northern Estonia. The hospital has four emergency rooms (ER) with different profiles: internal medicine, otorhinolaryngology (ORL), surgery, and trauma ER.

The aim of this study was to evaluate quality of family doctors' referral letters, to determine the most frequent referral diagnosis and to compare our results of hospitalisation rate with the hospital's own statistics.

METHOD: We analysed retrospectively 397 referrals from family doctors to TCH internal medicine, ORL and surgery ERs in 1.01.-31.03.2014. We excluded referrals from other hospitals and specialities, and incompletely scanned referrals.

RESULTS: Out of 379 cases 39% (155 patients) were hospitalised, 61% (242 patients) were ambulatory. Hospitalisation rate was higher for those who were referred in all three emergency rooms: 55% in internal medicine (overall hospitalisation rate 21%, p-value >0.0001), 28% in surgery (15% overall, p-value 0.0034), and 13% ORL (7% overall, p-value 0.0155). Only 1.5% (7 letters) of the sample did not have a referral diagnosis. History of disease and physical findings were described on 83% and 75% of referrals, respectively. The overall health history is also important in paediatrics, but only 14% of the referrals described patient's previous development and/or vaccinations. The five most common referral diagnosis were as follows: otitis media 19% (77 cases), of those 65% were serous otitis media; pneumonia 14% (57 cases); bronchitis 7% (29 cases); appendicitis 6% (24 cases) and stomach ache 5% (19 cases).

CONCLUSION: Hospitalisation rate is greater among referred patients than overall. Quality of referral letters is quite good but improvements can be made in describing patients development and growing.

Keywords: Tallinn Children`s Hospital, family doctors' referral

OP-196

The use of Family Medicine by the Families: a qualitative study

Arzu Uzuner¹, Pemra Ünalın¹, Delican Oğuzhan², Ali Yapakçı², Aylin Altun², Sefa Semih Atal², Cemre Hilal Kesen²

¹Department of Family Medicine, Marmara University Medical School, İstanbul, Turkey

²Marmara University Medical School, İstanbul, Turkey

INTRODUCTION: Family Physicians are expected to provide a comprehensive and individualized primary health care service by a family and community based, holistic approach. In Turkey Primary Health Care is recently based on Family Medicine model. Do the families use the Family Medicine or how they use.

METHODS: This qualitative study is structured as focus group meetings with families. Nuclear or large families using different primary care centers in different cities were recruited in the study to reflect different opinions. The groups were formed by 6-9 participants and each focus group lasted 30 to 110 minutes. All the groups were audio taped and transcribed. Thematic analysis was performed based on the transcripts by all the researchers, by dual cross reading and by the final analysis in the whole group. An independent researcher contributed to the final assessment.

RESULTS: A total of 26 focus group meetings have been held in five different cities; 72 families (n=165) participated in focus group meetings. Mean age value of the participants was 40.3±17.2; 57.5% of them were female and 54% were educated <8 years. Main themes that emerged were; 1-Use of family medicine by the families; 2- Observations and comments related to the health care practice; 3- Prejudices about primary health care services; 4- Expectations of and suggestions for family medicine; 5- description a “normal family doctor”.

DISCUSSION: Families receive individually and limited services from family doctors; families are not aware of services that could be expected from family physicians. Families have perception that family doctors deal with more simple health problems than other doctors. Families with elder members and children use more family medicine, due to its easy accessibility. Gender can be a challenge for the doctor-patient relationship.

Keywords: family medicine, primary health service, use

OP-197**A qualitative exploration of the experience of living with epilepsy in the mid-west region of Ireland**

Jennifer Mullen, Ray O'connor, Breda Carroll, Gerard Garrett, Sinead Gavin, Grainne McNally, James Moloney, Toireas Moriarty, Ciara O 'riordan, Ciara O'sullivan, Gerald Wheeler
Department of General Practice, University of Limerick, Ireland

BACKGROUND:

Epilepsy is a chronic condition with associated biological and psychosocial effects. Epilepsy is unique because of the stigma and psychosocial burden associated with it.

Aims and OBJECTIVES:

The aim of our study was to evaluate the emotional and psychosocial impacts of living with epilepsy, as well as the role of culture and society which can affect an individual's experience and their approach to treatment.

METHODS:

This study adopted a prospective, qualitative design using Interpretative Phenomenological Analysis (IPA) methodology.

A purposive sample of 12 people with epilepsy was recruited from the registers of General Practices in the Mid-West region of Ireland. Semi-structured face-to-face interviews were conducted to talk about the personal meaning of living with epilepsy. Audio recordings were transcribed verbatim. Themes that emerged as representative of the content were then identified.

RESULTS:

Fear, of seizures, of rejection, of embarrassment and of stigma was a recurring issue. These perceptions had a direct negative effect on mental health.

There was an overlap between feelings of fear and perceived stigma, issues affecting compliance with medication, and perceptions regarding side effects and prescribing choices.

There was also a relationship between feelings of stigma, the perceived need for secrecy and concealment felt by some of the interviewed patients, and feelings of discrimination, both socially and in a work life context.

Many of the patients experienced feelings of guilt in a social context, and a perception of being a "burden" to their families. Many also stated that epilepsy affected them in forming relationships.

There was a general sense of limited independence, compounded by driving restrictions and a sense of frustration with perceived and real barriers to achieving academic and professional goals.

CONCLUSIONS:

Our study provides several insights into the emotional and psychological aspects of living with epilepsy.

Keywords: epilepsy, psychosocial, emotional, stigma, perception

OP-198

Analysis of the demand of the immigrant population in primary medical care

Maria Jose Agueros Fernandez¹, Alvaro Perez Martin², Jose Ramon Lopez Lanza³, Victor Ovejero Gomez⁵, Montserrat Gago Bustamante¹, Alfredo Avellaneda Fernandez⁴, Antonio Alonso Gonzalez², Cecilia Traspuesto Pascual², Isabel Muñoz Franco², Maria Antonia Gandara Revuelta¹, Ana Isabel Cano Gonzalez¹, Marta Gomez Valdes¹

¹Primary Health Center Zapaton. Torrelavega. Spain

²Primary Health Center Centro. Santander. Spain

³Primary Health Center Alisal. Santander. Spain

⁴Primary Health Center Los Carmenes. Madrid.

⁵Sierrallana Hospital. Torrelavega. Spain

Background & AIM: To analyse the characteristics of the medical assistance given to immigrants in a primary medical care centre.

METHODS: A descriptive transversal study of the immigrants attended to, for any reason, in an urban primary medical care centre during 2012. The average and standard deviation (in the case of normal distribution) was used for quantitative variables, and percentages for qualitative variables.

RESULTS: 601 immigrants were seen (12.9% of the total number), with an average age of 37.95 (SD 12.3), mainly female (77.7%), mainly of South American origin (63.9%), followed by immigrants from Eastern countries (28.6%) and Africans (5.5%). Consultations mainly took place on a Friday (22.6%); there were no home visits; the average number of motives for each consultation was 1.42. 38.4% had some kind of test or complementary treatment, 42.4% were referred to other departments, mainly gynecology (16.7%), blood tests (26%) and temporary sick leave (14.3%). If the causes are classified by CIPSAP-2, we obtain "X genitourinary illnesses" (27%), "XIII osteoarticular and connective tissue illnesses" and "VI nervous system and sense organ illnesses" (9.7%) By specialist department, gynecology/obstetrics (25.8%), trauma (17.6%), and pneumology (12%) were the most frequent. 55.5% received a prescription for an acute motive (anti-inflammatory medicine (37.9%), antibiotics (6.6%)), and 17.7% for a chronic motive (contraceptives (14.2%), pregnancy supplements (13.2%).

CONCLUSIONS: Attention given to the immigrant population represents a very small percentage for the total. The profile of the typical user is a young woman, of South American origin, seen mainly for a gynecological reason. There are no home visits. Almost half required treatment or tests following the consultation, mainly referral to another consultant or specialty. Very few required chronic medication.

Keywords: Immigrant, primary medical care, medical assistance

OP-199

Analysis of the control of the risk factors in diabetic patients. Are we really making it worse?

Alvaro Perez Martin¹, Maria Jose Agueros Fernandez², Jose Ramon Lopez Lanza³, Antonio Alonso Gonzalez¹, Patricia Noemi Aguilera Samaniego¹, Maria Teresa Garcia Gutierrez¹, Alfredo Avellaneda Fernandez⁴, Cecilia Traspuesto Pascual¹, Isabel Muñoz Franco¹, Maria Antonia Gandara Revuelta², Nuria San Miguel Martin¹, Carmen Huidobro Dosal¹

¹Primary Health Center Centro. Santander. Spain

²Primary Health Center Zapaton. Torrelavega. Spain

³Primary Health Center Alisal. Santander. Spain

⁴Primary Health Center Los Carmenes. Madrid.

Background&AIM: A comparative study of the degree of control of diabetic patients in primary medical care and in hospitals, comparing the degree of control and the attitude of the physicians.

METHOD: A transversal, descriptive study of diabetic patients selected from three primary medical care quotas (by order they appear on the list). In order to calculate a correct control, the values recommended by the ADA 2015 were used (blood pressure <140mmHg and <90 mmHg, LDL <100mg/dl). In order to assess renal failure, a <60 filtration rate was considered. For quantitative values, averages and standard deviations were used (in the case of normal distribution), and percentages were used for qualitative variables.

RESULTS: 98 subjects were selected. The characteristics of the patients are (primary vs. specialised), average age 72.66 vs 57.3; mainly females (50.6% vs 47.4%). The average values encountered were HbA1c 7.2 vs 8.4%, glycemia 143.1vs164.7, LDL 101.8 vs 108.5mm/dl, SBP 143 vs 139mmHg and DBP 75.6 vs 77.5mmHg, 54.5% vs 36.8% had a good control of their BP, 55.8% vs 55.6% of their cholesterol. With regards to treatment of high blood pressure, 54.5% vs 36.8% used monotherapy. For those that did not fulfill the objectives, in 77.8 vs 95.2% of the cases, the doctor did not carry out any further treatment for BP, and in 96.2% vs 97.4%, there was no further treatment for cholesterol.

CONCLUSIONS: The degree of control of blood pressure and cholesterol levels in diabetic patients is very deficient at both primary care level and at hospital level, and do not fulfill the recommendations given by the main international guides. Both levels make few changes to high-risk patients. Treatment should be intensified and therapeutic inertia should be avoided.

Keywords: Diabetes mellitus, risk factor, Primary Health

OP-200

Quality of life of women with breast cancer: Middle East perspective

Ghufran Jassim

Department of Family and Community Medicine, Royal College of Surgeons in Ireland, Bahrain

PURPOSE: The objective of this study is to describe the quality of life of Bahraini women with breast cancer and its association with their sociodemographic and clinical data.

METHODS: This is a cross sectional study in which the European Organization for Research and Treatment of Cancer Quality of Life was administered to a random sample of 337 Bahraini women with breast cancer. Relevant descriptive statistics were computed for all items. The equality of means across the categories of each categorical independent variable was tested using parametric tests (ANOVA and independent t-test) or non-parametric tests (Kruskal Wallis and Mann Whitney tests) of association where appropriate.

RESULTS: Of the total sample, 239 consented to participation. Participants had a mean score for global health of 63.9 (95% CI 61.21-66.66). Among functional scales, social functioning scored the highest (Mean 77.5 [95% CI 73.65-81.38]) whereas emotional functioning scored the lowest (63.4 [95% CI 59.12-67.71]). The most distressing symptom on the symptom scales was fatigability (Mean 35.2 [95% CI 31.38-39.18]). Using the disease specific tool it was found that sexual functioning scored the lowest (Mean 25.9 [95% CI 20.23-31.60]). On the symptom scale, upset due to hair loss scored the highest (Mean 46.3 [95% CI 37.82-54.84]). Significant mean differences were noted for many functional and symptom scales.

CONCLUSION: Bahraini breast cancer survivors reported favorable overall global quality of life. Factors associated with a major reduction in all domains of quality of life included the presence of metastases, having had a mastectomy as opposed to a lumpectomy and a shorter time elapsed since diagnosis. Poorest functioning was noted in the emotional and sexual domains. The most bothersome symptoms were fatigability, upset due to hair loss and arm symptoms. This study identifies the issues that most need to be addressed in this Middle East society.

Keywords: Quality of life, Breast cancer, Women

OP-201

Presentation of respiratory symptoms prior to diagnosis in general practice: a case control study examining free text and morbidity codes

Richard Andrew Hayward, Ying Chen, Peter Croft, Kelvin Jordan
Keele University, Staffordshire, UK

Background and Aim

General practitioners can record patients' presenting symptoms by using a code or free text. We compared free text entries of breathless and wheeze symptoms with coded symptom information recorded prior to diagnosis of ischaemic heart disease (IHD), chronic obstructive pulmonary disease (COPD), and asthma using a case-control design.

Methods

The setting was eleven General Practices in North Staffordshire UK contributing to the Consultations in Primary Care Archive (CiPCA) database.

Cases with an incident diagnosis of IHD, COPD, or asthma in 2010 were matched to controls (four per case) with no such diagnosis. All prior consultations with codes for breathlessness or wheeze symptoms between 2004 and 2010 were identified. Free text of cases and controls were also searched for mention of these symptoms.

Results

592 cases were identified, 194 IHD, 182 with COPD and 216 with asthma. 25% of cases and 5% of controls had a prior consultation for breathlessness. Prevalence of a prior coded symptom of breathlessness or wheeze was 30% in cases, 6% in controls. Median time from first coded symptom to diagnosis among cases was 57 weeks. After adding symptoms recorded in text, prevalence rose to 62% in cases and 25% in controls. Median time from first recorded symptom increased to 144 weeks. The associations between diagnosis and prior symptom codes was strong: IHD OR 3.21,(2.15, 4.79); COPD OR 9.56,(6.74, 13.60); asthma OR 10.30,(7.17, 14.90).

Conclusions

There is an association between IHD, COPD and asthma diagnosis and earlier consultation for respiratory symptoms. Symptoms are often noted in free text by GPs long before they are coded. Free text searching may aid investigation of early presentation of long-term conditions using GP databases and are an important direction for future research.

Keywords: General Practice Electronic Health Records, Case-Control Study, Respiratory Symptoms, Early diagnosis, Chronic Obstructive Pulmonary Disease, Ischemic Heart Disease,

OP-202

"Risk factors of mortality in patients with chronic obstructive pulmonary disease"

Iris Nathalie San Roman Arispe¹, Ines Cruz Steve¹, Josep Montserrat Capdevila², Pere Godoy I Garcia⁴, Josep Ramon Marsal³

¹CAP Primer de Maig Lleida

²CAP Mollerussa Lleida

³Instituto Universitario de Investigación en Atención Primaria "Jordi Gol" Lleida

⁴Unidad Epidemiología Lleida en Generalitat de Catalunya

OBJECTIVE: To identify risk factors of mortality in patients with chronic obstructive pulmonary disease (COPD).

Design: A retrospective cohort study.

Location: Study on risk of overall mortality was carried out for the period 11/01/2010 – 10/31/2013 in diagnosed population of COPD in primary care in a Health (Lleida, Spain)

Participants: 2.501 patients older than 40 years with at least a spirometry in the 24 months prior to the beginning of the study were followed for 3 years.

Main measurements: The dependent variable was the overall mortality; and the independent: spirometric parameters, severity (GOLD) and clinical variables. Their association with mortality was analyzed by calculating the adjusted odds ratio using a non-conditional logistic regression model.

RESULTS: The average age of 2.501 patients at the beginning of the study was 68.38 years (SD=11.6) and the 74.97% of which were males. The 50.82% had a mild severity COPD, followed by the moderate (35.31%), severe (9.44%) and very severe (4.44%). The mortality rate for the all period was 12.55%. The variables of the predictive model were: age, sex, previous exacerbations, number of visits to the primary care, comorbidity, smoking, severity of COPD (GOLD) and influenza vaccination, with an ROC curve of 0.76.

CONCLUSIONS: The model, easy and quick to apply, would identify those patients at increased risk of mortality and who could benefit from preventive strategies to improve their survival.

Keywords: Chronic Obstructive Pulmonary Disease (COPD); Risk Factors; Mortality.

OP-203

(Elderly Healty Rotation: What Does Family Medicine Residents Think About?)

Olgu Aygün¹, Nilgün Özçakar², Mehtap Kartal²

¹İZMİR LOKAL HEALTH AUTHORITY, KARABAĞLAR 2 FAMILİY HEALTH CENTER

²DOKUZ EYLÜL ÜNİVERSİTESİ

AIM: As elderly population increase, care of elderly becomes more important in daily practice of family physicians. Their needs should be well known, properly assessed and managed. "Elderly health" training during residency is a new issue in Turkey, and first rotation is planned for residents in Dokuz Eylul University. The aim is determine the opinions of residents about their elderly health rotation in Narlidere Geriatric Care Center and Residential Home.

METHOD: The qualitative study included first 12 residents who had the rotation. Semi-structured in-depth interviews and descriptive analysis was performed.

RESULTS: Main themes: 1-Opportunities in the educational process in the elderly health rotation, 2-Challenges, and constraints experienced in the educational process 3-Recommendations regarding the educational process, 4-Tutorial characteristics, 5-Content and structuring of education.

Residents' statements:

"...Because they are both physiologically going backwards, and losing some advantages, renal function, etc... may

be something can be discussed on how to approach a group who are using an increasing number and types of drugs.”

“...It has sections where home care patients have more professional support. It is fine for it; I think it would be helpful...”

“...Alzheimer's patients were many. This group is the one that we didn't manage before...”

“...Some can be seen in outpatient clinic and shared but it's different with inpatient... How to flip side a patient, how their beds or, bedsides should be?”

“...However, a program should be made with relevant consultancy. Given tasks, what should be done or talked about the work-flow and theoretical lectures and also it could be more appropriate to plan the context and the schedule...”

CONCLUSIONS: Efficient training programs for residents about seniors' health needs in family medicine residency with interdisciplinary collaboration will make great contributions to improve their quality of life. There is a need for further studies for residents' perceptions and demands.

Keywords: ELDERLY HEALTH, ROTATION, GERIATRICS

OP-204

The prevalence of hypertension and obesity in children and adolescents is increasing in most countries with high and middle income

Giovanni Colucci¹, Enza Colucci¹, Paolo Motolese¹, Fabrizio Pastore¹, Fabio Robusto³, Paolo Vinci², Pietro Cirillo⁴, Vitantonio Colucci⁵

¹General Practitioners Asl Ta 5 Martina Franca, Taranto, Italy

²Pediatrician Asl Ta 5 Martina Franca, Taranto, Italy

³Mario Negri Sud-Santa Maria Imbaro's institue, Chieti, Italy

⁴Department of Nephrology Polyclinic Bari, Italy

⁵Engineer Martina Franca, Taranto, Italy

Adiposity is driving force for cardiovascular disease. **OBJECTIVES:** draw epidemiological profile overweight/obesity (S/O); define through Hypertension (IA), BMI (Body Mass Index), waist circumference (CV) how many children are to cardiovascular risk; identify children with urinary disorders (microscopic hematuria, proteinuria / microalbuminuria) correlate with S/O and IA; correlate children's physical inactivity with feeding. Enrolled 935 children (Martina Franca), average age 9.48 (SD = 1.02) 9.52 median age (MIN 6.51 – MAX 12.05). Are measured: blood pressure, BMI, CV, urinalysis to fresh, questionnaire on habits life (sports, sedentary lifestyle, food four daily meals). Data evaluated based on age and gender with cut-off of growth. In multivariate logistic regression Males were independently associated with S/O: M, OR: 1.517, CI: 1163-1979, p <0.01. We defined "prehypertension" blood pressure values 90th - 95th percentile, while "manifests hypertension" blood pressure \geq 95th. In logistic regression adjusted for age and sex, S/O with OR of 5.04 had hypertension. M (OR: 1.79, CI: 0543-2145, p: 12.46), age (for each year OR: 0.885, CI: 0638-1227, p: 12.46), S/O (OR: 5.041, CI: 2325-10931, p <0.001). S/O with OR of 3.47 had prehypertension. M (OR: 1.038, CI: 0593-1816, p: 0.90), age (for each year OR: 1.391, CI: 1053-1850, p: 0.02), S/O (OR: 3.469, CI: 1943-6194, p <0.001). Proteinuria / microalbuminuria is associated to hypertension and age. M (OR: 0.708, CI: 0389-1290, p: 12.26), age (for each year OR: 1.884, CI: 1378-2576, p <0.001), hypertension (OR: 4.946, CI: 1.838 - 13,314, p <0.0). Microscopic hematuria is weakly associated with hypertension and markedly with age. IA is correlated in logistic regression with abdominal obesity (OA) and not with S/O. OA (OR: 3.720, CI: 1237-11188, p <0.02). No correlation between S/O and have snack or breakfast, also sedentary activities and sports. Attention of General Practitioners, to correct lifestyle, can improve cardiovascular risk in childhood.

Keywords: overweight/obesity, hypertension, proteinuria / microalbuminuria, cardiovascular risk

OP-205

Tackling Problems in West Bank using Design Thinking during the International Development of Family Medicine in Palestine Course

Walid Tarda¹, Israa Alassa², Nawal Abusarhan¹, Lubna Alsaudi¹, Charilaos Lygidakis³, Paul Wallace⁴

¹Faculty of Medicine and Health Sciences, An-Najah University, Nablus, Palestine

²Primary Healthcare Beitlehem, Beitlehem, Palestine

³Vasco da Gama Movement

⁴University College London, UK

Background & Aim

The International Development Family Medicine Programme in Palestine West Bank (IDFMP) aims to support the development of Family Medicine (FM) in Palestine through training, academic exchanges and a leadership development. Its first initiative was a one-week course for the residents of the Palestinian FM specialty programme at the An-Najah University in Nablus in November 2013. Among the activities of the course, the participants analysed the issues of the Palestinian FM applying the Design Thinking methodology and explored potential solutions.

This presentation aims at providing a subset of the results of that session.

Method

Nineteen FM residents participated in the course and were divided into four groups. Following the human-centric Design Thinking methodology, each group brought into discussion a challenge of the Palestinian FM. First they interpreted the challenge, identified the stakeholders and defined the problem appropriately. Second, they brainstormed ideas and chose the most feasible ones according to the context and resources. Finally, they prepared presentations and prototypes of the solutions with the use of role-plays and storyboards.

Results

Among the problems noticed by the groups, there were the scarce time and continuity, the lack of medical records, the overwhelming patient expectations, and the sense that Family Doctors were not respected by patients and colleagues. By analysing the challenges, their processes and stakeholders, the participants brainstormed many ideas: train the other specialists on FM, establish joined meetings among doctors of all specialties, increase communication among the clinics, introduce a gatekeeping system, increase the training sites for FM, launch public information campaigns, and encourage the newly graduated doctors to join the specialisation.

Conclusions

The Design Thinking sessions helped the course participants clarify the needs of primary care in Palestine and how to overcome these by employing a Build-Measure-Learn loop.

Keywords: medical education, policy, internationality, specialization, vocational guidance

OP-206

Incidence and treatment of heavy menstrual bleeding in general practice - {Data from a dynamic cohort, the Netherlands}

Marian J. van den Brink, Anne Linde Saaltink, Feikje Groenhof, Marjolein Y. Berger, Yvonne Lisman Van Leeuwen, Janny H. Dekker

Department of General Practice, University of Groningen, University Medical Center Groningen, The Netherlands
BACKGROUND: Heavy menstrual bleeding (HMB) is a common problem in women of reproductive age. Less is known of the incidence of HMB in primary care and the treatment strategy used. Since the revision of the Dutch College of General Practitioners' (GPs) guideline on Vaginal bleeding in 2008, the levonorgestrel intrauterine system (LNG-IUS) plays a more prominent role and is recommended as an equal treatment option to oral medication.

AIM: To investigate the incidence and treatment of women with HMB in primary care and to compare this treatment with the Dutch guideline on Vaginal bleeding.

METHOD: Data from a dynamic cohort including 46.467 patients, derived from the Registration Network Groningen, The Netherlands was used. We selected women visiting the GP for HMB from January 2004 until January 2014. Data of medication prescription, number of visits and referrals were collected.

RESULTS: In a 10 year period, 881 women visited the GP with HMB as a new complaint. The mean incidence of HMB was 6.5 per 1000 women per year. In the three months following diagnosis, 46% of women were treated with hormonal medication, in 44% of cases no medication were started. Within one year of diagnosis, 15% of women were referred to the gynecologist. There was a significant decrease in the percentage of oral progestogens prescriptions during 10 years ($p < 0.05$), no trend was seen in the number of LNG-IUS prescriptions.

CONCLUSIONS: The incidence of HMB in this cohort was comparable to the incidence found in other studies. Women were treated most often with hormonal medication, mainly the oral contraceptive pill and oral progestogens. No significant increase in LNG-IUS prescriptions for HMB is seen in our study. Here is opportunity for improvement, since Dutch GPs are increasingly inserting the LNG-IUS for indications such as contraception in the past 10 years.

Keywords: menorrhagia, gynecology, therapy, levonorgestrel IUS, family practice

OP-207

"Attitude and Behaviour of Hospital Workers on Healthy Diet"

Dilek Kusaslan Avci, Huseyin Avni Sahin, Hatice Tuba Akbayram

Department of Family Medicine, Medical Faculty of Yuzuncu Yil University, Van, TURKEY

AIM:

The aim of study is to determine the healthy lifestyle behaviours of hospital workers employed in Yuzuncu Yil University Hospital, Van, Turkey.

METHODS:

A total of 431 hospital workers were included in the study in a university hospital in Van.

Research data were collected with a questionnaire covering; nutrition consuming frequency, nutrition consuming behaviour, general health condition, body height, body weight and blood pressure, alcohol and cigarette consumption, exercise and socio- demographic characteristics.

RESULTS:

Smoking more than 10 cigarettes a day among physicians, nurses, and other employees were 77.7 %, 76.0 % and 31.3 % respectively ($p: 0.000$).

Alcohol consumption among physicians, nurses, and other employees were 20.2 %, 9.8 % and 9.5 % respectively ($p: 0.011$).

Starting the day without having breakfast among physicians, nurses, and other employees were 73.2 %, 55.5 % and 41.1 % respectively ($p: 0.002$).

Skipping the meals due to not having time to eat among physicians, nurses, and other employees were 45.6 %, 36.7 % and 41.1 % respectively (p: 0.003).

Eating fast food daily among physicians, nurses, and other employees were 11.1 %, 7.4 % and 0% respectively (p: 0.000).

Eating fast food at least once a week among physicians, nurses, and other employees were 73.2 %, 51.2 % and 41.7 % respectively (p: 0.000).

CONCLUSIONS:

According to study results lifestyle and dietary attitudes of health care workers were not as desired. As they are the role model for the rest of the population more time and care should be given to understand the reasons, so they may improve their attitudes regarding healthy diet and lifestyle.

Keywords: Healthy Lifestyle, Behaviour, Nutrition, Obesity, Health Care Worker

OP-208

Screening for heart failure and COPD in frail elderly with reduce exercise tolerance or dyspnoea: a cluster randomized trial

Yvonne Van Mourik¹, Frans H Rutten¹, Loes C Bertens¹, Maarten J Cramer², Jan Willem J Lammers³, Johannes B Reitsma¹, Karel G Moons¹, Arno W Hoes¹

¹Julius Center for Health Sciences and Primary Care, University Medical Center Utrecht, the Netherlands

²Department of Cardiology, University Medical Center Utrecht, the Netherlands

³Department of respiratory medicine, University Medical Center Utrecht, the Netherlands

BACKGROUND: Heart failure and chronic obstructive pulmonary disease (COPD) often remain unrecognized in older individuals. It is unknown whether screen-detecting these diseases really impact the management. We evaluated the effectiveness of a screening strategy followed by management at the discretion of the own general practitioner (GP) in 'frail' community-dwelling elderly.

METHOD: Cluster randomized clinical trial.

'Frail', pragmatically defined as multimorbidity and/or polypharmacy, persons aged ≥ 65 years with complaints of dyspnoea or reduced exercise tolerance were eligible for inclusion. General practices were randomly allocated to a screening strategy consisting of history taking, physical examination, blood tests, electrocardiography, spirometry and echocardiography. An expert panel decided on presence or absence of COPD and heart failure, and in such a case further management was at the discretion of the participating GP. In the other arm GPs provided usual care, that is, symptoms-driven diagnosis and management. All changes in medication and health care use during the six months follow-up were extracted from the electronic medical files of the GPs.

RESULTS: In total 18 practices were randomized and 829 patients participated; 389 in the screening strategy (eight practices) and 440 in the care as usual group (ten practices). More patients in the screening strategy received a new diagnosis of heart failure or COPD compared to usual care (cumulative six months incidence 34% vs. 2%, and 17% vs. 2%, respectively). In new detected heart failure, provided recommendations of the expert panel on pharmacotherapy were adopted by the GP in 33 (44.6%) patients. This was 16 (45.7%) in newly detected cases of COPD. After six months, health care use was comparable between the two strategies.

CONCLUSION: Screening for heart failure and COPD in frail elderly with dyspnoea or reduced exercise tolerance resulted in many newly detected cases, but not in reduced health care use compared to usual care.

Keywords: heart failure, COPD, screening

OP-209

Mortality predictors of H1N1 influenza outbreak in 2015

Pratyush Kumar¹, Atul Gogia², Atul Kakar²

¹Department of Family medicine, Sir Gangaram hospital, Newdelhi,India

²Department of Internal medicine, Sir Gangaram hospital, Newdelhi,India

Background & Aim

Worldwide H1N1 pandemic has been associated with increase morbidity and mortality. In India, a recent outbreak of H1N1 influenza has posed a serious challenge for health services with rapid spread across various states causing panic among public. The present outbreak data correlates clinico-laboratory findings with mortality.

Method

In a prospective observational study at tertiary care centre in Northern India data was collected from 1st January 2015 to 28th February 2015 related to H1N1 mortality in all patients tested positive using real-time reverse-transcription polymerase chain reaction testing on nasopharyngeal swabs.

Results

Data of 151 patients were analyzed. Majority of patients were above 40 years (55%) and range from age 3 months to 85 years with 47.6% females. Comorbidity was seen in 52.9% (Type 2 diabetes mellitus - 23.8%, hypertension - 25.8%) of the patients. The time between onset of symptoms and hospitalization ranged from 1 to 25 days. Documented clinical features were fever - 96.6%, dry cough - 86.09%, productive cough - 13.01%, dyspnea - 80.7%. Management included oseltamivir and antibiotics if indicated along with 66.8% of the patients required oxygen support, 22.5% required intensive care, 14.5% mechanically ventilated and 8% maintained on non invasive ventilation. Mortality was 8.6% in which all the patient were above 40 yrs of age ($P = 0.018$) and 88.6% were male. Mortality correlated significantly with elevated s. creatinine ($P = 0.03$), thrombocytopenia ($P = 0.037$), hyperbilirubinemia ($P < 0.001$), raised serum aspartate transaminase ($P = 0.003$) and serum alanine transaminase ($P = 0.001$). High risk factors such as pregnancy, diabetes and hypertension didn't correlate with mortality significantly. Patients requiring oxygen, intensive care and mechanical ventilation correlated significantly with mortality.

Conclusions

The mortality rate in our study was 8.6%. H1N1 influenza patients with deranged hepatic and renal parameters had poor prognosis.

Keywords: H1N1, influenza, Mortality, Predictor,

OP-210

The association between parity and blood pressure in Korean women: Korean National Health and Nutrition Examination Survey, 2010–2012

Mi Ae Jang, Ji Ho Choi, Yeon Ji Lee

Department of Family Medicine, Inha University Hospital

Background & AIM: Pregnancy brings significant changes in women's cardiovascular system, but the association between parity and blood pressure has not been clarified. This study aimed to investigate the association between parity and blood pressure in Korean women using the 2010-2012 Korean National Health and Nutrition Examination Survey.

METHOD: A total of 8,890 participants aged 19 years and over were categorized into two groups according to menopause in this cross-sectional study. Multivariable adjusted logistic regression analysis was used to evaluate the association between parity and blood pressure.

RESULTS: With increasing number of births, systolic and diastolic blood pressures decreased in premenopausal women ($\beta=-0.091(p<0.001)$ and $\beta=-0.069(p<0.001)$ respectively) and systolic pressure decreased in postmenopausal women ($\beta=-0.044(p=0.028)$).

CONCLUSIONS: This population-based study showed that increasing parity was associated with decreasing blood pressure in Korean women.

Keywords: parity, blood pressure, menopause

OP-211

Trends in Statin Consumption and Cardiovascular Mortality in Croatia 2004 – 2012

Zeljko Vojvodic¹, Mladenka Vrcic Keglevic²

¹Zeljko Vojvodic, Family Practice "Dr Zeljko Vojvodic" Bijelo Brdo, Osijek, Croatia and Foundation for the Development of Family Medicine in Croatia, Zagreb, Croatia

²Mladenka Vrcic Keglevic, University of Zagreb Medical School, School of Public Health "Andrija Stampar", Zagreb and Foundation for the Development of Family Medicine in Croatia, Zagreb, Croatia

Background and aims

Prescribing of statins increased in all developed countries since 1995, growing at faster rates than other ATC groups. That rise was regarded desirable and beneficial, because of their unquestionable efficiency in controlling atherogenic dyslipidemia.

The aim was to research trends in statin therapeutic and financial consumption in the period from 2004 to 2012 as well as trends in cardiovascular mortality from 1980 to 2012.

Methods

Longitudinal, observational study, based on data on the use of statins, from Croatian Agency for Medicinal Products and Medical Devices, from 2004 – 2012, together with financial expenses (in EUR). Data on cardiovascular mortality in Croatia and several neighbouring countries were taken from the Croatian Health Statistics Yearbooks.

Results

Pharmaceutical consumption of statins increased from 28,1 DDD/TID in 2004 to 83.5 DDD/TID in 2012 (near 200%). The most frequently prescribed simvastatin and atorvastatin, rised at different rates - simvastatin 64%, atorvastatin 440% - from 8.8 DDD/TID in 2004 to 47.9 DDD/TID in 2010, with 50% drop in utilization rate in 2011 due to doubling of DDD for the C10 group.

Financial expenses for statins expanded at a rate of 53%, from 21.3 millions of EUR in 2004 to 32.4 millions of EUR in 2012. Their share in total drug expenses grew up from 4.25% to 4.87% in 2012.

As opposed to that, trends in standardized cardiovascular mortality, as well as mortality rates from ischemic heart disease and cerebrovascular disease continually declined in Croatia (and several neighbouring countries) since 1980s – from 551,65/100.000 to 351/100.000.

Conclusions

Utilization of statins in Croatia increased more than in any other therapeutic group, in the eight year period, while standardized cardiovascular mortality rates decreased in balanced linear mode.

Keywords: statin consumption, cardiovascular mortality, pharmaceutical spending

OP-212

Consumption of over-the-counter drugs in Croatia 2004 - 2013: longitudinal study

Alma Kurc Bionda¹, Darja Nelken Bestvina², [Zeljko Vojvodic](#)³

¹Alma Kurc Bionda, Family Practice "Alma Kurc Bionda" Đakovo and Foundation for the Development of Family Medicine in Croatia, Zagreb, Croatia

²Darja Nelken Bestvina, family Practice "Darja Nelken Bestvina" Osijek and Foundation for the Development of Family Medicine in Croatia, Zagreb, Croatia

³Zeljko Vojvodic, Family Practice "Zeljko Vojvodic", Bijelo Brdo, Osijek and Foundation for the Development of Family Medicine in Croatia, Zagreb, Croatia

Background & aims

Over-the-counter (OTC) drugs are medicines for use without a prescription from a healthcare professional, as compared to prescription drugs which may be delivered or sold only to consumers possessing a valid prescription. In many countries, OTC drugs are approved by regulatory agencies which ensure that they contain safe and effective ingredients that can be used without medical supervision. They are also the cornerstone of self-medication health care strategies. The aim of study was to investigate OTC drugs mostly used by Croatian population in period from 2005 to 2013.

Methods

Data on OTC consumption expressed in DDD/TID and as financial expenditure in Croatian kunas (HRK), were taken from annual reports of Croatian Agency for Medicinal Products and Medical Devices from 2005 to 2013.

Results

Trends in total OTC consumption, expressed in DDD/TID and in kunas, were increasing. During the observed period, the most used drugs were: acetylsalicylic acid, ascorbinic acid, vitamin B12, ibuprofen, paracetamol, bisacodil, oxymethazoline, betahistine, bromhexine and ginkgo biloba, all with increasing tendencies. The utilization of acetylsalicylic acid increased with the greatest rate, from 19.00 DDD/TID in 2005 to 57.24 DDD/TID in 2013, followed by ascorbinic acid, from 5.44 DDDs in 2005 to 10.22 DDD/TID in 2013 and vitamin B12, from 2.61 DDDs in 2005 to 9.13 in 2013. Consumption of ibuprofen (only 200 mg strength) also increased, switching the position on a rank list with paracetamol. Financial spending followed the trend of therapeutic.

Conclusions

Croatian population consumed OTC drugs in rather great quantities. The important questions are whether their family doctors are aware of this consumption and whether they take into account possible side-effects. It will be also interesting to investigate the role of health care professionals as potential generators of these trends.

Keywords: over-the-counter drugs, self-medication, pharmaceutical spending, Croatia

OP-213

Multidisciplinary approach to treating obesity in a community health centre

Milena Blaž Kovač¹, Igor Švab², Antonija Poplas Susič¹

¹Community Health Centre Ljubljana, Slovenia

²Medical university Ljubljana

Background

Obesity incidence continues to grow. The main problems of treatment is low success rate and the poor longterm sustainability of reduced weight after completed programme. The most successful methods include multidisciplinary approach, but they are often poorly evaluated. In urban health centre in Ljubljana a long-term programme has been developed by multidisciplinary team of doctors, nurses and physiotherapists.

Aim

The aim is to evaluate short and longterm outcome of the programme with regard to cardiovascular risk factors and to determine the associations with social and demografic factors, upon preserving in the programme and the maintenance of a lower weight after the programme has been completed.

Method

The programme included the 6 months weight reduction part and 18 months of the weight maintenance part. 397 participants were recruited by their GPs and data were collected after 24 months. Logistic regression was used as a method of determining the factors of success and SPSS for statistical analysis.

Results

346 participants have completed the introductory part and 123 have completed the full programme. In the introductory the average weight loss was 12% of the initial weight. The participants who completed the full programme lost 9,4% of the initial weight. The values of blood sugar, cholesterol, systolic and diastolic blood pressures were significantly reduced. ($p < 0,05$) The factors associated with staying in the programme are age over 50 (beta= - 0,6219, $p = 0,015$), lower educational levels (beta= 0,6430, $p = 0,029$), lower initial weight (beta= - 0,0089, $p = 0,10$) and higher weight loss (beta= 0,0363, $p = 0,064$) in the introduction.

Conclusions

The multidisciplinary approach to obesity treatment was effective for a selective group of people. The proportion of dropouts was relatively high but still low compared to similar programmes.

Programme supported Norway Grantis

Keywords: obesity treatment, primary health care, patient adherence

OP-214

Career pathways in family practice: A qualitative study of mid-career general practitioners

Lesley M Piko¹, Catherine Joyce²

¹Company Director, ACT Medicare Local Ltd

²Adjunct Associate Professor, School of Public Health & Preventive Medicine, Monash University and Senior Manager of Policy, Research and Service Innovation, cohealth

BACKGROUND & AIM: Career pathways can influence recruitment and retention of the general practitioner (GP) workforce, but there has been limited empirical investigation of career trajectories followed by GPs. We analysed qualitative data to describe the career development strategies used by GPs at the mid-career stage, and assessed the extent of fit with a 'portfolio' career model.

METHOD: This qualitative study used data from interviews with 99 mid-career GPs in Australia. We explored GPs' patterns of workforce participation and work activities, and the reasons for their choices about these.

RESULTS: GPs reported a range of ways in which they developed their careers at the mid-career stage. Most common was a 'depth' strategy, with four out of five GPs reporting at least one area of special interest practice.

Two thirds of GPs reported 'breadth' strategies, diversifying into other (non-GP) clinical and/or non-clinical work. Consolidation and maintenance of career were also prominent, and not necessarily mutually exclusive with 'depth' or 'breadth' strategies. Interestingly, nine out of ten GPs reported using more than one career development strategy, thereby highlighting the variation in GP career development.

CONCLUSIONS: Career development strategies adopted by GPs in our study are consistent with the 'portfolio' career model to some extent, illustrating a variety of roles and career trajectories. This research can assist with GP workforce recruitment by highlighting the diverse and challenging career pathways available. Similarly, professional organisations and practices can use the findings to support GP workforce retention. Planning for the GP workforce needs to take into account the amount of time GPs may spend in roles other than direct clinical service provision. Although increased non-clinical work may mean more GPs are required overall to meet demand for primary medical care, it also means more satisfied GPs who are likely to stay in the workforce longer.

Keywords: Career pathways, portfolio career, workforce

OP-215

Mental Health in Out-of-Hours Service – informing the future direction of services

Claire Collins¹, Marie T. O Shea¹, Pearse Finegan¹, Dorcas Collier², Margaret Curran², John Cunniffe²

¹Irish College of General Practitioners, Dublin, Ireland

²Caredoc, Carlow, Ireland

Background and Aim

In Ireland it is estimated that 90% of mental health problems are dealt with by the general practitioner while 10% are dealt with by specialised mental health services. Much research into mental health has focussed on psychiatry and emergency departments, with somewhat less focussed on primary care. Within primary care little is known about the use of out of hours GP service by people experiencing mental health difficulties. This study describes consultations that are related to mental health issues attending one large out of hours primary care service in the South East of Ireland.

Method

Data was collected via an anonymous extraction of retrospective data from the out of hours' electronic database. Using a pre-defined list of terms, data were extracted to identify the number of patients over a one year period who attended with a possible mental health condition.

Results

Using 37 pre-defined key words, a total of 12,431 relevant consultations were identified in 2013. Approximately 6% of the consultations were excluded as they referred to cases < 18 years. Overall 61.5% of consultations were in respect of females, the mean adult age was 55 years and 46.6% of adult callers personally made the call to the service. The priority of the consultation at reception was considered an emergency in 10.6% of cases, urgent for 35.5% of cases and routine for the remaining 53.9%. Further data will be presented describing the reason for the consultation and referral patterns.

Conclusions

The findings from this initial phase shed light on the numbers of mental health consultations resulting in referral. It also informed a second phase of the study to establish the patterns of use of out-of-hours GP services by people presenting with mental health difficulties and knowledge about their adherence to a mental health service referral.

Keywords: mental health, primary care, referral

OP-216

Determinants of patient's and doctor's delay in diagnosis of gastric cancer in the Netherlands

Yunus Arik, Charles Helsper, Nicole Van Erp, Niek De Wit
Julius Centre for health and primary care, UMC Utrecht, Netherlands

Background and Aim

An efficient diagnostic process is important for reducing disease burden for gastric cancer patients. Duration of this process and its determinants are unknown for the Netherlands.

We aim to assess the duration of the different phases of the diagnostic process, and determinants of delay in these phases, for gastric cancer patients in the Netherlands.

Method

A retrospective case series using routine care data of gastric cancer patients, available from the Primary Care Network Utrecht (PCNU) database. Based on these anonymous free-text and coded data, the duration of the phases of the diagnostic process (called T1 to T3) was assessed: T1 - onset of symptom(s) to first consultation with general practitioner (GP); T2 – first GP consultation to referral; T3 - referral to final diagnosis. Median durations and interquartile ranges (IQR) were calculated in days. 'Delay' is defined as the longest quartile of phase duration. Determinants of delay are assessed using multivariable logistic regression analyses. Possible determinants are: patient-, complaint-, disease- and consultation related variables.

Results

Patient files 51 patients were eligible for analysis. The median time from onset of symptoms to final diagnosis was 128 days (IQR 61-213). Median duration of time periods was, T1: 17 days (IQR 3 to 42), T2: 22 days (IQR 4 to 66), T3: 34 days (IQR 15 to 56). The only determinant for which a suspicion of an association with delay was found was psychiatric morbidity in T2 (OR 2.27, 95%CI 0.93-5.57).

Conclusion

Dutch gastric cancer patients face modest delay in primary and secondary care. The variation in duration of each phase, particularly in time to referral by the GP, is substantial. Since time from referral to final diagnosis was relatively long, increasing efficiency of the secondary care diagnostic process is likely to be the most effective intervention to reduce delay.

Keywords: Delay, gastric cancer, diagnostic process, diagnosis, primary care

OP-217

Well-being of older cancer patients one year after diagnosis: results from the KLIMOP cohort

Marjan Van Den Akker¹, Laura Deckx², Tine De Burghgraeve², Carine Van Den Broeke², Doris Van Abbema³, Frank Buntinx²

¹Department of Family Medicine, Maastricht University, Maastricht, the Netherlands

²Department of General Practice, KU Leuven, Leuven, Belgium

³Department of Medical Oncology, Maastricht University Medical Centre, Maastricht, the Netherlands

Background & AIM:

To study occurrence and evolution of depression, cognitive functioning, fatigue and loneliness the first year after diagnosis of cancer.

METHODS:

The Klimop-study is an ongoing Flemish-Dutch cohort study (N=1495) consisting of older cancer patients (≥70 years), older patients without a previous diagnosis of cancer, and younger cancer patients (50-69 years). Data include depression, fatigue, cognitive functioning, and loneliness at baseline and one-year follow-up.

RESULTS:

The evolution of most psychosocial problems was similar for older and younger cancer patients: an increase in

depression, slight worsening in cognitive functioning, and no clear change in fatigue. Compared to people without cancer, differences were small. The initially lower scores for loneliness among older cancer patients increased over one year until they reached the scores of older patients without cancer. Main risk factors for depression, fatigue and cognitive functioning after one year were changes in functional status and presence of the problem at baseline. For loneliness, we found an increased risk for people who were persistently fatigued, and people who became or were persistently impaired on cognitive functioning.

CONCLUSIONS:

Despite lower levels of loneliness at baseline, after one year of follow-up, loneliness was comparable for older people with and without cancer. It looks as if family and friends cluster around older cancer patients to comfort them. Within a year, however, this effect fades out and loneliness levels increase to a level that is comparable to persons without cancer. The same trend occurs in other psychosocial problems; over the course of one year after a diagnosis of cancer, cancer patients, young and old, face increasing levels of depression and increasing difficulties in cognitive functioning. Since the main risk factor for psychosocial problems was presence of the problem at baseline, this calls for regular screening and exchange of information between different health care providers.

Keywords: cancer, older patients, well-being

OP-218

Clinical characteristics of patients with acute coronary syndrome visiting ordinary outpatient clinic

Hiroaki Wakakuri¹, Akihiro Tanaka¹, Taro Saigusa¹, Makoto Suzaki¹, Sonoko Kirinoki¹, Naoko Onodera¹, Takashi Araki², Hideya Hyodo¹, Toshihiko Ohara¹, Makoto Kawai², Masahiro Yasutake¹

¹Department of General Medicine & Health Science, Nippon Medical School, Tokyo, Japan

²Department of Emergency and Critical Care Medicine, Nippon Medical School, Tokyo, Japan

[Background & Aim] ACS (acute coronary syndrome) patients presenting with typical chest pain are commonly referred to cardiologists, admitted to coronary care unit and receive timely coronary revascularization therapy. However, many ACS patients without chest pain initially see generalists and tend to be subjected to delay and/or underuse of optimal treatment. The aim of this study is to clarify the clinical characteristics of ACS patients who visit our outpatient clinic of general medicine.

[Method] Forty five consecutive patients diagnosed as having ACS in our department were reviewed in the period between November 1, 2011 and February 28, 2015. We divided the patients into two groups: the ambulance group (n=21) who were carried by ambulance and the walk-in group (n=24) who came on foot.

[Results] The ambulance group (age: 67±12, M/F:15/ 6) consisted of 13 ST-segment elevation myocardial infarction (STEMI), 5 non ST-segment elevation myocardial infarction (NSTEMI), 1 recent MI, and 2 unstable angina (UA) patients. The walk-in group (age: 63±13, M/F: 19/ 5) consisted of 10 STEMI, 6 NSTEMI, 6 recent MI, and 2 UA patients. A proportion of ACS patients with no chest pain was higher in the ambulance group than in the walking group (48% vs 38%). The chief complaint of ACS patients with no chest pain in the ambulance group included nausea (n=6), dyspnea (n=3), and cervical pain (n=1). Likewise, patients in the walking group complained nausea (n=5), dyspnea (n=2), headache (n=1), and back pain (n=1).

[Conclusion] Generalists should always bear in mind a possibility of ACS, especially when patients are presenting with acute onset of nausea and/or dyspnea, regardless of admission route: by walk-in or by ambulance.

Keywords: acute coronary syndrome, outpatient clinic, no chest pain

OP-219

What is 'valid' knowledge? Mindlines, philosophy and virtual networks beyond EBM

Sietse Wieringa

Queen Mary University

BACKGROUND: Evidence based medicine holds high the ultimate need to weigh the findings of research in light of considerations of patients values and clinicians' expertise [1]. However, how valid and useful answers to clinical questions are found during this process largely remains a black box. A better understanding of how clinicians value and incorporate evidence from research in their clinical methods, including the use of intuition, heuristics and reasoning is called for [2].

Important empirical evidence regarding the integration of evidence in clinical practice comes from an ethnographic study in 2004 by Gabby and le May [3]. They found that GPs seldom use explicit knowledge (such as clinical guidelines) in everyday practice. Instead they heavily relied on inexplicit, tacit knowledge, practical routines and past personal experiences shared with and influenced by colleagues, dubbed 'mindlines'.

METHODS-RESULTS: In a systematic review we analysed 340 papers published since 2004 on mindlines. We identified several philosophical sophisticated perspectives that fundamentally unpack many of the assumptions underlying the EBM paradigm. Where conventional EBM limits itself to frequentist reasoning trying to find a single knowable truth, mindlines present us with multiple realities, alternative ways of reasoning and the concept of useful knowledge being 'created' instead of 'translated' in contexts and communities.

By further studying mindlines in theory and in practice as for instance in virtual social networks we may be able to increase the array of tools we use to develop valid knowledge and find what lies beyond the current EBM paradigm.

Keywords: Knowledge management, guidelines, epistemology, virtual social networks

OP-220

The "Voices of the Street Project" examines prevalence of Hypertension and Diabetes Mellitus in poor communities of Jundiaí - Brazil

Luiza Breuel Luz, Daniel Rosa Amaral, Eduardo Sasaki, Carolina Alice De Camargo Valente, Bárbara Breda Stella, Ângela Eugênio Rizzato, Marco Aurélio Janaudis, Suzana Guimarães Moraes

Voices of the Street, Jundiaí Medical School, Jundiaí, Brazil

Background & AIM: The "Voices of the Street Project" is a voluntary extension project of the Jundiaí Medical School, Brazil, which aims to integrate students and community, leading to health promotion to underserved areas and the formation of humanized professionals. METHOD: In this work, the project was to evaluate the prevalence of diabetes mellitus (DM) and hypertension (HTN) in poor neighborhoods in Jundiaí. RESULTS: The application of a questionnaire was made with the population in the city of Jundiaí, which featured a sample of 210 people, including 114 female, 96 male, mean age of 51.14 years, with a variation of 18 to 83 years. The project analyzed the prevalence of these diseases in these two districts and found that 15.24 % of the participants have DM; 35.24 % 12.9% have hypertension and DM associated with hypertension. CONCLUSIONS: Based on the data collected by the project, we observed a high incidence of hypertension and diabetes mellitus in the city of Jundiaí. By contrast, compared to the difficulty in collecting municipal data from other sources, reinforces the performance of epidemiological questionnaires applied to activities. With hard numbers, we can act more effectively in communities. In addition to promoting health in these neighborhoods, there is the benefit to the volunteer student because he is current on the prevalent diseases as well as in the preventive approach to their future patients, with a differential in their training.

Keywords: Hypertension; diabetes mellitus; health education; quality of life

Diabetes



Hypertension



OP-221

Analysis of the smoking population. What is the perception of the usefulness of ICTs for smoking cessation?

Jose Manuel Trujillo Gómez¹, Laura Díaz Gete², Carlos Martín Cantera³, Mireia Fábregas Ecurriola⁴, Mónica Manzano Montero⁵, Lourdes Clemente Jiménez⁶

¹Institut Universitari d'Investigació en Atenció Primària Jordi Gol (IDIAP Jordi Gol), Barcelona, Spain

²Primary Healthcare Centre, La Sagrera, ICS, Barcelona, Spain;

³Primary Healthcare Centre, Passeig de Sant Joan, ICS, Barcelona, Spain

⁴Primary Healthcare Centre, La Marina, ICS, Barcelona, Spain

⁵Primary Healthcare Centre, Horta, ICS, Barcelona, Spain

⁶Primary Healthcare Centre, Santo Grial, SALUD, Huesca, Spain

Background and AIMS: Common interventions for smoking cessation are based on medical advice and pharmacological aid. Information and communication technologies (ICTs) may be helpful as interventions by themselves or as complementary tools to quit smoking. Determining the profile of the smoking population and knowing the perception of the utility of ICTs for smoking cessation who has the patients attended in Primary care we could elucidate the viability of an ICT intervention in smoking cessation in primary care.

METHODS: Descriptive observational study in 84 health centres in Catalunya, Aragon and Salamanca. We included by simple random sampling 1725 primary healthcare smokers aged 18-85. Through personal interview professionals collected Socio-demographic data and variables related with tobacco consumption, ICTs use and perception of the utility of ICTs for smoking cessation collected through face to face interviews. Data was analyzed by SPSS 17.0.

RESULTS: Smokers mean age was 45.5 years, 51.1 % were male. Participants were more likely to be married (63.5%), manual workers (59.5) and 52.5% had completed secondary education. Mean age of starting tobacco consumption was 17.2 years and the mean number of self-declared cigarettes smoked per day was 15.4. Half of the participants declared a low dependency on nicotine. 74.5% of participants declared previous attempts to quit smoking. Patients tended to live in a non-smoke-free environment; 84.4 % of the patients were users of ICTs. Web pages/Internet was the ICT most valued to help smokers in tobacco cessation, but overall confidence that ICTs

could help smokers to quit smoking is low.

CONCLUSION: The perception of the usefulness of ICTs to quit smoking by the participants is generally low and lower than expected, being higher in women, younger than 45 years old and users of each of the ITCs, being the most valued web pages / Internet.

Keywords: smoking cessation, information and communication technologies, primary health care, e-mail.

OP-222

Analysis of the smokers participants in a clinical trial based on the use of e-mail to stop smoking

Laura Díaz Gete¹, Jose Manuel Trujillo Gómez², Carlos Martín Cantera³, Carmen Castaño⁴, Ana María Gómez Quintero⁵, Jessica Sánchez Fondevila¹

¹Primary Healthcare Centre, La Sagrera, ICS, Barcelona, Spain

²Institut Universitari d'Investigació en Atenció Primària Jordi Gol (IDIAP Jordi Gol), Barcelona, Spain

³Primary Healthcare Centre, Passeig de Sant Joan, ICS, Barcelona, Spain

⁴Primary Healthcare Centre, La Alamedilla, SACYL, Salamanca, Spain

⁵Primary Healthcare Centre, Turo, ICS, Barcelona

Background and AIMS: Common interventions for smoking cessation are based on medical advice and pharmacological aid. Information and communication technologies may be helpful as interventions by themselves or as complementary tools to quit smoking. Our main aim is to know the profile of potentially participating smokers in smoking cessation interventions by email.

METHODS: We have made a comparison between participants in two studies realized in Catalonia, Salamanca and Aragón (Spain): A Descriptive observational study conducted in 84 health centres, which included by simple random sampling 859 primary healthcare smokers and a Randomized Controlled Multicentric Trial, which included 1060 smokers. Only were selected those smokers who had and checked regularly an E-mail account. Through personal interview health professionals collected Socio-demographic data and variables related with tobacco consumption through face to face interviews. Both Statistical analyses were conducted using SPSS, version 17.0 (SPSS Inc, Chicago, IL).

RESULTS: In total participated 1919 smokers. The mean age was 41.7 years (SD: 11.7), being mostly women (54.7%), married (63.2%) belonging to higher classes (70.4%), with an educational level in the TABATIC Trial lower than the Descriptive Study (77.9% vs 28.2%). Participants in the TABATIC Trial had a higher level of nicotine dependence, had previously made more attempts to quit smoking (3.1 vs 2.3) and had consumed more medication in them that Descriptive Study participants (44.1% vs 23.1%), being nicotine replacement therapy, gum and patches, most commonly used medication (15.7%). The environment of the participants was generally smoker.

CONCLUSION: Therefore, the profile of the potential participants in smoking interventions based on the e-mail are women, older, married, most favored social status, but with a lower level of education, greater nicotine dependence and a great number of previous attempts, which have consumed medications for quitting occasionally and whose environment was predominantly smoker.

Keywords: smoking cessation, information and communication technologies, primary health care, e-mail.

OP-223

Relation between a niche and postmenstrual spotting

Marjolein Dieleman¹, Judith Huirne², Hans Brölmann², Lucet Van Der Voet³

¹University Medical Center, Utrecht, The Netherlands

²VU University Medical Center, Amsterdam, The Netherlands

³Deventer Hospital, Deventer, The Netherlands

Background & Aim

A lot of women visit the general practitioner with menstrual problems. In women with a history of caesarean section (CS), the uterine scar may be the cause of menstrual problems. While the CS rate is increasing in most Western countries, the gynaecological side effects of this procedure are still poorly studied. Recently, some attention has been devoted to the presence of a niche at the site of a caesarean scar. A niche is defined as a triangular, anechoic area at the presumed site of incision. The main purpose of the SECURE-study (Scar Evaluation after Caesarean by Ultrasound REgistry) was to assess the prevalence and appearance of a niche, and to evaluate the relation with abnormal uterine bleeding.

Method

An observational prospective cohort study was performed between October 2007 and May 2009. All 225 women were consecutively included and examined with gel instillation sonohysterography (GIS) 6 to 12 months after CS to detect a niche. A questionnaire about the menstrual cycle was completed and women were asked to keep record of their bleeding pattern for a period of 2 cycles. As part of the follow up, the questionnaire will be repeated every year for the next 5 years.

Results

The presence of a niche could be demonstrated with GIS in 117 (56%) out of 209 women. In 16 women distension was insufficient for accurate assessment. The prevalence of postmenstrual spotting was 34% in the group of women with a niche compared to 15% in the group without a niche ($p=0.002$).

Conclusions

A niche can be seen in 56% of women with a caesarean scar. Postmenstrual spotting is significantly associated with the presence of a niche.

Keywords: niche, caesarean scar, postmenstrual spotting

OP-224

Satisfaction of patients attended in two different models of primary care in Spain and Portugal

Ricardo Enrique Reolid Martínez, María Flores Copete, Mónica López García, Pilar Alcantud Lozano, Milagros Azorín Ras, Francisco Escobar Rabadán, María Candelaria Ayuso Raya
Centro de Salud Zona IV. Sescam. Albacete. España

BACKGROUND & AIM:

Patient satisfaction can be important as a measure quality of care in acceptability terms to individual patients of different primary care organizational models.

The aim of the study is to know the degree of user satisfaction regarding the health care service in a Spanish health center(public, SESCAM) and another Portuguese(Unit of Functional Health).

METHOD:

Design: Cross-sectional study.

Setting: Primary Care.

Participants: 87 and 80 patients in Spain vs Portugal.

Main outcome measures: They were asked to respond the EUROPEP instrument,23-item validated and internationally standardized measure evaluations of general practice patients.

Other variables: age, sex, education level.

The collected data were coded and entered into a database using the SPSS 17.0 statistical programme. The analysis included a description of the variables, comparing both health center (Mann-Whitney U test).

RESULTS:

The mean age was 50.1 (SD:16.3) and 56,9 years (SD:17.0) in Spain vs Portugal ($p=0.011$); 56.3% and 61.2% were women, there were no statistically significant differences (NS) by sex. (84.3 and 73.7%) had primary or higher level (NS).

In general, Portuguese patients had more favourable opinion about the care they received. The most striking differences ($p<0,0001$) were found: telling them what they wanted to know about their illness (97,2 vs 81,7), helping to deal with emotional problems related to health status (94.5 vs 74.1);waiting time in the waiting room (74.7 vs 40,0).

With regard to questions assessing some professionalism aspects (confidentiality, helping to feel well, physical examination, knowing what he or she had done, preparing to expect from hospital care) and administrative ones (getting an appointment, getting through the practice or the doctor on phone) there were NS.

CONCLUSIONS:

Portuguese users of Unit Functional Health have shown a higher degree of satisfaction with the care provided compared with those who were attended in Spanish health center

Keywords: Patient Satisfaction; Models, Organizational; Primary Health Care.

OP-225

Cognitivate function assessment in relation with socio-demographic features and depression in geriatric patients: a community-based study

Ayşe Akay, Aysegul Uludag, Erkan Melih Sahin, Yusuf Haydar Ertekin, Murat Tekin, Selen Gungor, Zeynep Daglı, Semsettin Can Asar, Meryem Askın
Department of Family Medicine, Faculty of Medicine, Canakkale Onsekiz Mart University, Çanakkale, Turkey

AIM: to evaluate the socio-demografic features and depression relation with cognitive impairment in geriatric population.

METHOD:

The research was descriptive design. The population was established by 65 years and older people live in Kepez town of Çanakkale. In this region 1,200 geriatric people were living. These people were classified according to

gender and age and we aimed to reach 10% of whole geriatric population. The participants who lost sense of reality and declared not to submit the study were excluded.

A questionnaire including sociodemographic features was applied. Mini Mental Test (MMT), clock drawing test and geriatric depression scale-SF were also applied.

RESULTS:

Mean age was 72.8 ± 6.4 [65-91], total of 128 geriatric participants were included. Of 50.8% participants were female and 3.9% participants were evaluated at home visit.

Mini mental test mean score was 26.8 ± 3.9 [10-30]. Of 85.9% participants were normal, 9.4% mild cognitive impairment, 4.7% of had dementia. In clock drawing test 38.3% participants got score 4 and lesser, as having cognitive function impairment. MMT and clock drawing test were positively correlated (Kendal tau-b $r=0.363$; $p<0.05$).

There was no significant difference between mini mental test scores of male and females ($F=1.050$; $p=0.353$). In 85 years and older age group got significant low MMT scores than others ($F=9.951$; $p<0.05$). There was no significant association; retired and working individuals were significantly had higher MMT scores than unemployed ones. Significant higher MMT scores were associated with increased educational level and regular monthly income ($p>0.05$).

As the Geriatric depression test, 35.9% of participants were concordant with depression. MMT score and depression scale score were negatively related. (Pearson $r=-0.351$, $p<0.05$). Participants, depression risk, got significantly lower scores from clock drawing test and MMT ($t=4.065$; $p>0.05$ and $t=3.287$; $p<0.05$).

CONCLUSION: In the geriatrics; age, education level, working status and depression influence cognitive impairment.

Keywords: Geriatrics, cognitive function, socio-demographic function, depression, mini mental test

OP-226

The impact of vitamin D deficiency on cognitive functions in patients with type 2 diabetes mellitus

Cihan Fidan, Zehra Yeğın, Altuğ Kut

Departments of Family Medicine, Başkent University, Ankara, Turkey

AIM: Vitamin D insufficiency and deficiency is one of the major health problems in the world and in our country. Recently, vitamin D effects on diabetes and cognitive functions has been the subject to a lot of major research, but studies on this issue are still insufficient. Despite the studies made, still the effects on cognitive function of vitamin D deficiency in type 2 diabetic patients is not known exactly. This study aimed to investigate the impact of vitamin D deficiency on cognitive functions in patients with type 2 DM.

METHOD: 118 Type 2 DM patients with vitamin D deficiency were included as a subject group, and 118 Type 2 DM patients without vitamin D deficiency were included in the study as a control group. The cognitive functions of study groups were evaluated with Mini Mental Status Examination Test (MMSE). By this test, data were collected about the orientation, registration, attention, calculation, recall and language abilities of patients.

RESULTS: The mean age of the study subjects was 57.58 ± 7.14 years. 153 (64.8%) of the patients were female and 67 (35.2%) were male. One hundred and sixty-nine (71.6%) patients had diabetes for less than 10 years and 67 (28.4%) had diabetes for more than 10 years. Of these, 189 (80.1%) were using oral antidiabetic drugs, 17 (7.2%) were using insulin therapy, and 30 (12.7%) were using a combination therapy. Group 1 had a significantly lower vitamin D level than Group 2 ($17,19 \pm 6,52$ vs $39,89 \pm 11,85$; $p=0.00$, t-test). The total test score and subscore analyses based on the severity of vitamin D deficiency revealed no significant correlation between vitamin D deficiency and cognitive functions ($p>0.05$).

CONCLUSION: There was no significant correlation between vitamin D levels and cognitive functions of participants.

Keywords: Vitamin D, Diabetes Mellitus, Cognitive Impairment

OP-227

The necessity to thyroid ultrasound screening using TIRADS classification and Strain Elastography, in neighboring countries affected after Chernobyl radioactive disaster

Mihai Sorin Iacob¹, Mihai Ghiris², Sorina Saftescu², Madalina Gligor²

¹Department of Ultrasonography in Family Medicine, Timis Society of Family Medicine, Timisoara, Romania

²Department of Family Medicine, Advitam Medicis Medical Center, Timisoara, Romania.

BACKGROUND: Latest statistics, places Romania at a high level among EU countries in terms of morbidity and incidence of the thyroid diseases. In recent decades in Romania, after the nuclear accident at Chernobyl, especially in the Banat Mountains, where there are still incorrect disused uranium mines, we observe a clear increase over ten times of thyroid diseases predominantly because of multi nodular goiter and autoimmune thyroiditis. The prevalence of malignant thyroid nodules are growing, most being 80% papillary micro carcinomas. We tried to analyze this, using Power and Doppler Duplex ultrasound and then was made the Strain Elastography to identify tumors stiffness.

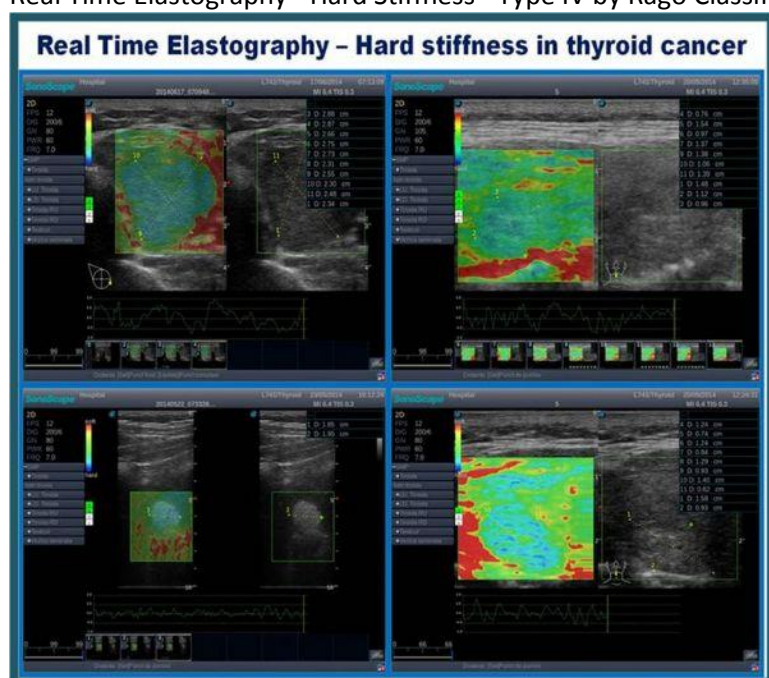
METHOD: We report a prospective thyroid ultrasound screening performed on 1169 adults with oncological risk factors, aged over 20 years, followed for two years, female gender sex ratio =3:1. As an initial diagnostic method, the Doppler Duplex ultrasound was the main investigation technique. We designed in our study an Ultrasound Scoring System for predicting thyroid malignancy. Each patient entered was stored into an electronic database in Microsoft Access, executed by us. For standardization and accuracy of reporting, we used TIRADS classifications by Russ and Strain Elastography scores by Rago et al.

RESULTS: Were found a total of 119 patients with diffuse diseases and 227 with benign and malignant thyroid nodules. The prevalence of thyroid diseases was 29.60%(95%CI:26.99%to 32.31%), with sensitivity 95.38%, specificity 94.78%, accuracy 94.95%, PPV 88.47%, NPV 97,99%, $p<0.01$. Then we did a comparative statistical analysis of our ultrasound methods used(ROC curve analysis, ANOVA $p<0.001$).

CONCLUSIONS: Ultrasonography proves to be a very efficient method with a high value in thyroid screening for the early detection of diffuse diseases and tumors of thyroid in asymptomatic stage with high prevalence, for diagnosis of vascular network in tumors and absence of elasticity in the nodule certifying malignancy.

Keywords: Thyroid ultrasound screening, Strain Elastography, TIRADS classification, Chernobyl radioactive disaster.

Real Time Elastography - Hard Stiffness - Type IV by Rago Classification in Thyroid cancer.



Thyroid malign tumor detected by ultrasound screening and strain elastography with hard stiffness.

Thyroid Ultrasound Screening Results analysis.

Disease		THYROID PATHOLOGY SCREENING			
Test	Present	n	Absent	n	Total
Positive	True Positive	a= 330	False Positive	b= 43	a + b = 373
Negative	False Negative	c= 16	True Negative	d= 780	c + d = 796
Total		a + c = 346	b + d = 823		
Sensitivity	a/ a + c	= 95.38 %	95% CI: 92.60 % to 97.33 %		
Specificity	d/ b + d	= 94.78 %	95% CI: 93.03 % to 96.19 %		
Positive Likelihood Ratio	Sensitivity/ 100 - Specificity	= 19.25	95% CI: 13.63 to 24.44		
Negative Likelihood Ratio	100 - Sensitivity/ Specificity	= 0.05	95% CI: 0.03 to 0.08		
Disease prevalence	a + c/ a + b + c + d	= 29.60 % (*)	95% CI: 26.99 % to 32.31 %		
Positive Predictive Value	a/ a + b	= 88.47 % (*)	95% CI: 84.79 % to 91.53 %		
Negative Predictive Value	d/ c + d	= 97.99 % (*)	95% CI: 96.76 % to 98.86 %		
Accuracy	a+d/ (a+c)+(b+d)	= 94.95 %	95%CI: 93.72 % to 95.81 %		

Ultrasound screening results were very good with sensitivity 95.38%, specificity 94.78% and accuracy 94.95% which supports making these ultrasound techniques to the exposed population in risk areas.

OP-228

Assessment of excessive alcohol consumption and unit for AUDIT test in primary care

Fernando Leiva Cepas, Esperanza María Romero Rodríguez, Adriana Cabello Chanfreut, José Cuevas Cruces, Joao Miguel Madeira Martins, Javier López Moreno, José Ángel Fernández García, Luis Ángel Pérula De Torres Teaching Unit of Family and Community Medicine of Córdoba, Andalusian Health Service, Junta de Andalucía, Spain

AIMS: To assess the prevalence of opportunistic manner of heavy drinking and alcohol dependence syndrome (ADS) in patients presenting to primary care centers (PCC). Evaluate effectiveness of temperance "brief advice".

Design: open, type "before-after" evaluation of the effectiveness of a preventive intervention quasi-experimental study

Location: Multicenter. Health Centers National Health System.

MATERIAL-METHODS: Health Centres held in the National Health System, including as participating doctors and nurses. For an alpha error of 5% and an accuracy of 3% and a rate of 50%, would be included in the study 1200 patients between 14-90 years of age, of both sexes. Will be invited to participate to all members of the Spanish Society of Family and Community Medicine (SEMFyC) and professionals from a random sample of health centers in the region. Once established their intention to participate, shall complete a logbook data collection (which also includes social morbidity data and an AUDIT questionnaire) to be offered to patients who met the inclusion criteria. Descriptive and inferential statistics (P <0.05 bivariate and multivariate analysis) will be made.

Applicability: through the results of this study are intended identifying patients having risk consumption to intervene from the standpoint of small tip if evaluating its effectiveness in alcohol detoxification by AP; likewise aims to involve the Health Administration to value the problems of alcohol consumption in a Mediterranean culture like ours.

Ethical and legal aspects: the protocol will be submitted to the Research Ethics Committee of Cordoba 1 September 2014. Participants informed consent and the processing of data will be requested in accordance with the Data Protection Act

Keywords: Excessive consumption of alcohol, AUDIT, brief Council.

OP-229

A Cluster Randomized control trial to evaluate complementary feeding strategies through dietary diversification in infants in developing country

Aziz Abdul Rehman Jiwani¹, Zulfiqar Bhutta²

¹department of family medicine, aga khan university, karachi, pakistan

²department of paediatrics, aga khan university, karachi, pakistan

Back ground: Transition from exclusive breast feeding to the complementary feeding poses many challenges as the demand of nutrients for optimum growth and development increases steadily. The question; would the food based strategy through education be enough to provide a wide variety of micronutrients for the treatment of anemia and growth or addition of micronutrient is required?

METHOD: A prospective community-based randomized controlled efficacy trial in a representative urban population of Karachi was conducted. Infants and mothers were enrolled and placed in three groups - defined as Nutr Education (Nutr Edu), Oral iron supplementation (OIS) and Multiple micronutrient fortification (MMF). A cohort of 451 infants (177 in group Nutr Edu, 141 in group OIS and 133 in MMF) were followed for three months (till the end of treatments).

RESULTS: This trial demonstrated that MMF significantly improved the iron status. Mean Hemoglobin level improved significantly between the groups to 10.30 gm/dl (95% CI; 10.02, 10.58) in MMF vs. 9.87 gm/dl (95% CI; 9.61, 10.12) in the Nutr Edu at the end of trial. There was an overall improvement in rate of anemia with significant reduction in anemia [relative risk (RR) of 0.81 (95 % CI; 0.68, 0.97)] for MMF compared with nutrition education alone and RR of 0.84 (95 % CI; 0.71, 1.00) of OIS compared to Nutrition education alone. The improvement in weight gain over the period of trial was significant as the mean monthly weight gain increased by 300 gm in the group MMF as compared to 240 gm (P= 0.014) in the Nutr Edu group and the mean monthly WAZ scores improved significantly by 0.12 in MMF as compared to 0.04 in Nutr Edu group.

CONCLUSION: Along with iron other micronutrients may be needed to improve nutrient intake, iron absorption, and growth in infancy

Keywords: infant, anemia, malnutrition, Complementary feeding,

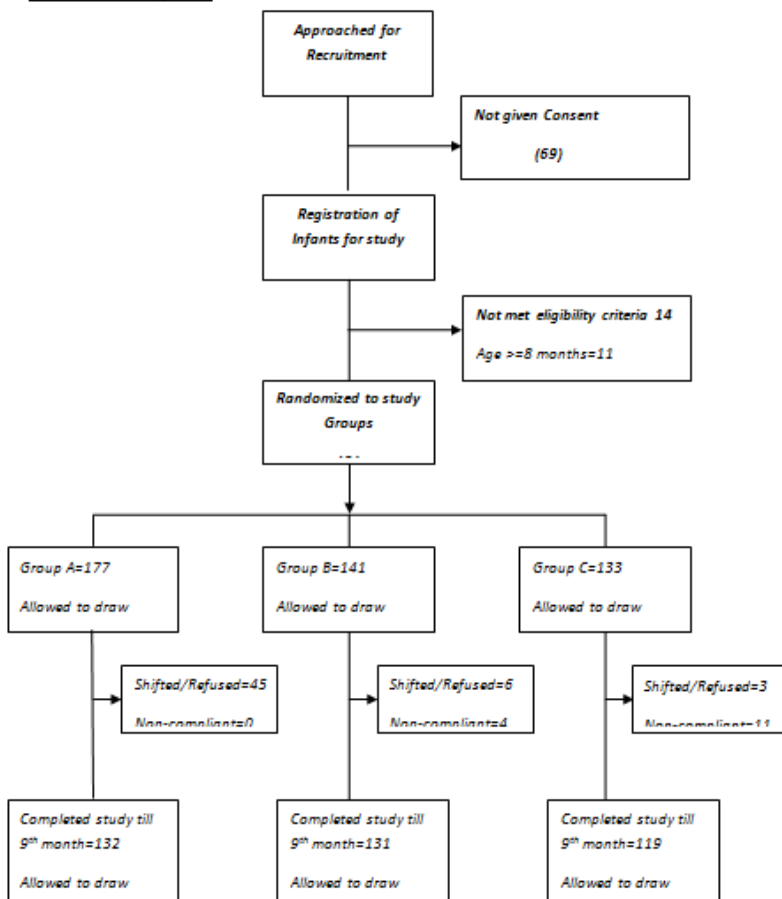
Baseline demographic status

Baseline characteristics: Demographic.

		Group <i>Nutr Edu</i>		Group <i>OIS</i>		Group <i>MMF</i>		Total	
		(n=177)		(n=141)		(n=133)		(n=451)	
		Count	% (Column)	Count	% (Column)	Count	% (Column)	Count	%
Gender	Male	86	48.6	77	54.6	68	51.1	231	51.2
	Female	91	51.4	64	45.4	65	48.9	220	48.8
Age at the time of registration (months)	< 6	33	18.6	32	22.7	32	24.1	97	21.5
	6	118	66.7	85	60.3	73	54.9	276	61.2
	7	26	14.7	24	17	28	21.1	78	17.3
	Mean age (SD)	6.49 (0.58)		6.42 (0.66)		6.48 (0.732)		6.46 (0.65)	
Vaccination	Yes	133	75.1	106	75.2	99	74.4	338	74.9
Received BCG	No	44	24.9	35	24.8	34	25.6	113	25.1
Received 3 doses of DPT	Yes	90	50.8	70	49.6	48	36.1	208	46.1
	No	87	49.2	71	50.4	85	63.9	243	53.9

Consort

Consort diagram



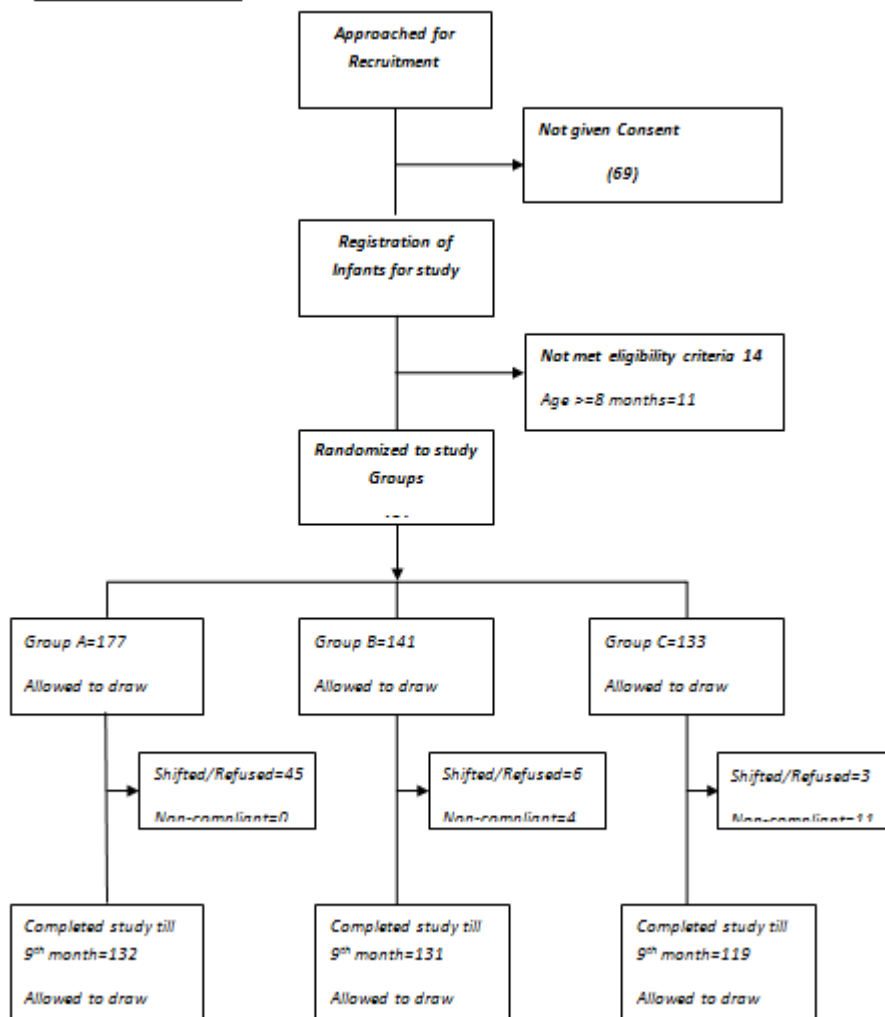
Change in Hemoglobin status

	Group	N	Mean	SD	95% Lower	95% Upper	p-value
Change in Hemoglobin level (End line - Baseline)	Nut Edu	83	-.25	1.16	-.51	-.005	0.007
	OIS	71	.21	.95	-.006	.44	
	MMF	72	.24	1.23	.04	.53	
Change in Ferritin level (End line - Baseline)	Nut Edu	58	-27.77	54.36	-42.06	-13.47	0.164
	OIS	62	-10.75	37.51	-20.27	-1.22	
	MMF	49	-20.41	54.46	-36.05	-4.76	

Change in Hemoglobin status over the period of trial

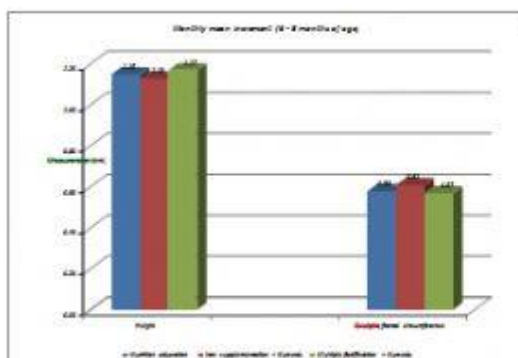
Mean monthly change in Z scores

Consort diagram

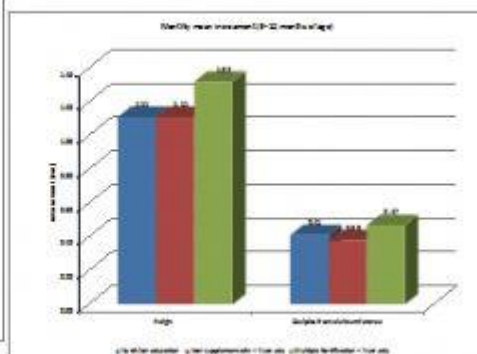


Mean monthly increment in anthropometric measurements

A



B



C

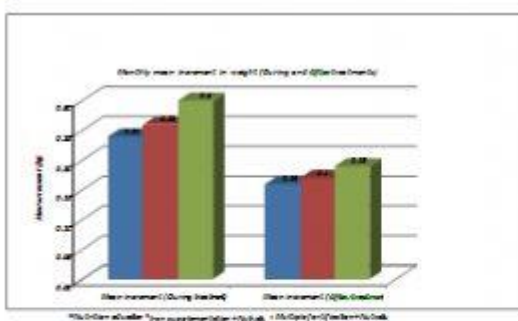


Figure 3 Mean monthly increments in anthropometric measurements for height and OFC during the trial (A), during the follow up period (B). Mean monthly increment in weight during and after the trial (C).

OP-230

Prevalence and antibiotic susceptibility pattern of urinary pathogens isolated in urine cultures from patients of a Primary Care Health Unit

José Carlos Da Silva Russo, Bruno António Covelo De Almeida, Ana Margarida Romão, Sara De Sousa Rocha
Unidade de Saúde Familiar Descobertas, Belém, Lisboa, Portugal

Background & AIM: Urinary tract infections (UTI) are one of the most common bacterial infections and its treatment is often started before the urine culture result. Knowing the local prevalence and antibacterial susceptibility pattern of the microbial agents helps choosing the empirical treatment of UTIs. This is particularly important in context of increasing antimicrobial resistance. This study aims to characterize the prevalence and antimicrobial susceptibility pattern of the urinary pathogens isolated in urine cultures performed in laboratories located in the area of influence of a Lisbon Primary Care Health Unit (USF Descobertas) requested by this unit's physicians.

MATERIAL-METHODS: The authors carried out a descriptive, cross-action and observational study. Sample: All positive urine cultures requested by USF Descobertas' physicians performed between 11.01.2009 and 10.31.2012 to all patients with 18 years of age and older.

RESULTS: The authors had access to the results of 213 positive urine cultures, 75.1% of which were from women, and 66.2% belonged to individual aged ≥ 65 years old. Nine different bacterial strains were identified, being *E. coli* the most frequent (77.5%) followed by *P. aeruginosa* (7.51%) and *Klebsiella* spp. (7.04%). Ampicillin was the antibiotic that showed higher resistance to *E. coli* (41.8%) followed by Trimethoprim/Sulfamethoxazole (27.0%). Norfloxacin and Ciprofloxacin showed resistance in 20.6% and 19.4% of *E. coli* strains, followed by Amoxicillin/Clavulanate (15.8%). *E. coli* resistance to Fosfomicin and Nitroforantoin was 1.2% and 3.0%.

CONCLUSIONS: The antimicrobial prevalence found in this study is similar to the ones described by other authors. Fosfomicin showed the best level of activity against *E. coli*, which makes it the best therapeutic option in empirical UTI treatment in these patients. Other option with low resistance is Nitroforantoin. The associations Trimethoprim/Sulfamethoxazole and Amoxicillin/Clavulanate, as well as quinolones, must be used with caution according to the resistances found in this study.

Keywords: Drug Resistance, Microbial; Urinary Tract Infections

OP-231

ACE Inhibitors or ARBS - Evidence on mortality in hypertensive diabetics?

Paula Mendes¹, Vítor Portela Cardoso²

¹USF Maxisaúde, ACES Cávado I, Braga, Portugal

²USF Gualtar, ACES Cávado I, Braga, Portugal

Background and AIM: Angiotensin converting enzyme (ACE) inhibitors and type II angiotensin receptor antagonists (ARA) have been used in hypertensive diabetics. However, the results of studies have been contradictory relative to the effect of cardiovascular preventing. Our aim was review the evidence on ACE inhibitors or ARA with regard to mortality or occurrence of major cardiovascular events in these patients.

METHOD: We conducted a research of meta-analyzes (MA), systematic reviews (SR), randomized clinical trials (RCT) and clinical practice guidelines (CPG) in the data sources National Guideline Clearinghouse, Guidelines Finder, Canadian Medical Association Practice Guidelines, Cochrane, DARE, Bandolier, Medline, DGS and RMP Index, published between 31/08/2009 and 31/08/2014 in Portuguese, Spanish, English and French languages. We used the MeSH terms: "Diabetes Mellitus" AND "Hypertension" AND "Angiotensin-Converting Enzyme Inhibitors" OR "Angiotensin Receptor Antagonists". The strength of recommendation taxonomy scale was used for the allocation of levels of evidence (NE) and strength of recommendation (SR).

RESULTS: Of 478 articles obtained, 13 met the inclusion criteria (5 MA and 8 CPG). A Cochrane MA showed that

ACE inhibitors significantly decreased mortality from all causes by 16% (NE 1) and Nakao's MA concluded that this class decreased the risk of myocardial infarction (NE 1). Recently, Cheng's MA found that ACE inhibitors significantly decreased mortality from all causes by 13%, cardiovascular mortality by 17%, myocardial infarction by 21% and heart failure by 19% (NE 1). ARA only decreased risk of heart failure. There was no consensus among the CGP, although most recommend ACE inhibitors or ARBs as first line.

CONCLUSIONS: The effects of ACE inhibitors or ARA appear to be different in mortality and cardiovascular events, although there are few head-to-head studies. The evidence found consistently favored the use of ACE inhibitors as first option in preventing morbidity and mortality in this population (SR A).

Keywords: Diabetes Mellitus, Hypertension, inhibitors of angiotensin converting enzyme, angiotensin receptor antagonists

OP-232

Increase in palliative sedation and reasons in cancer patients in Dutch general practice 2005-2014

Gé A Donker, Christel E Van Dijk

Sentinel Practices, NIVEL Primary Care Database, Utrecht, The Netherlands

Background

Little is known about the quantity and reasons for use of palliative sedation in cancer patients in general practice and the reason to apply palliative sedation when a request for euthanasia was pending.

Aim

To gain more insight into the reasons for palliative sedation at the end of life, also when a request for euthanasia was pending in cancer patients in Dutch general practice.

Design and setting

Dynamic cohort study using registrations and questionnaire data of Dutch GPs.

Method

Trends and reasons for use of palliative sedation in cancer patients were analysed using multilevel analyses in the years from 2005 until 2014 in the Sentinel Practices of NIVEL Primary Care database.

Results

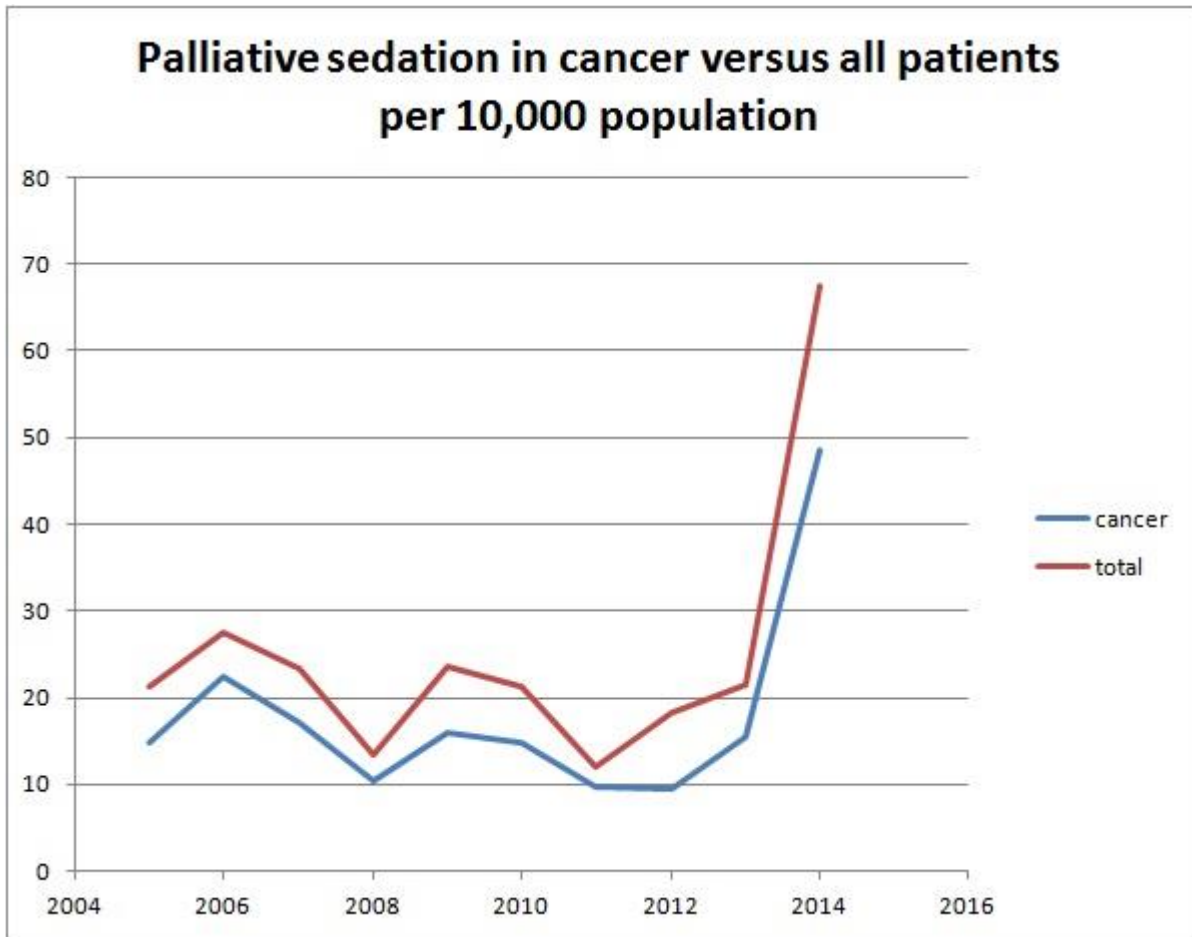
From 2005–2014, 220 cancer cases dying after palliative sedation were reported from 62 general practices. The incidence of palliative sedation increased in 2014 threefold compared to the nine years before ($P < 0.001$). Patient involvement in decision making before the start of palliative sedation (91%) was less frequently present in patients with delirium and in older patients (≥ 75 years, 87%) than in the group < 75 years of age (94%, $P < 0.05$). Pending euthanasia requests were present in 20% of cases; the choice for palliative sedation in these cases was: rapid progression of the disease and/or short life expectancy (55%), preference of patient and/or relatives (23%), adequate communication impossible (17%).

Conclusion

Palliative sedation showed a threefold increase in 2014 compared to the nine years before. There is no indication that palliative sedation is performed to avoid euthanasia.

Keywords: Palliative sedation, cancer, general practice, end of life, euthanasia

Palliative sedation in cancer versus all patients per 10,000 population



Incidence of palliative sedation in cancer versus all patients in Dutch general practice in 2005-2014 per 10,000 population

OP-233

Depression Prevalence Among Elderly People Aged 65 Years And Above in Izmir

Ergun Akyol, Mehtap Kartal

Department of Family Medicine, Dokuz Eylul University, Izmir, Turkey

AIM: With the increase in senile people population, diseases that are specific to this population are becoming more important. Especially in senility depression among psychiatric diseases comes forward. In this research, it was aimed to determine the depression prevalence among elderly people aged 65 years and above, excluding dementia.

METHOD: This cross-sectional descriptive study was carried out by face to face interviews and by conducting surveys with 771 elderly people who are stratified according to their age. Patients who couldn't be able to cooperate due to consciousness changes, hearing and speaking loss are excluded from the study. Evaluation has been achieved with Geriatric Depression Scale Short Form, Daily Life Activities Scale, Mini Mental State. Statistical analysis has been defined with numbers and percentage. Chi square and T tests were used and $p < 0.05$ was considered significant.

RESULTS: In this study that we searched for the depression prevalence among 771 elderly people who aged 65 years and above. 134 patients who had dementia were excluded from the study, as dementia and depression has similar symptoms. Statistical data through 637 patients revealed depression prevalence as %15.2. For patients whose ages between 65-74 it is stated as %10.9; whereas it is % 20.3 for patients who are above 75. Increased age ($p=0.001$), being single ($p < 0.001$), living alone ($p < 0.001$), low education level ($p < 0.001$), presence of diabetes ($p=0.010$), osteoporosis ($p=0.002$) increased depression risk in the study population.

CONCLUSIONS: It is obvious age is an important risk factor for depression. However, there are also social and health issues that can be interpreted as risk for elderly depression. Primary care physicians have to be more attentive about these risk factors and be more companionable about effective treatment of depression in elderly population they care for.

Keywords: Depression, Elderly, Primary Care

OP-234

Variation in primary care requesting patterns for laboratory tests: physician, practice or patient factors? A cross sectional study

Sharon Louise Cadogan¹, John Patrick Browne¹, Colin Patrick Bradley², Mary Rose Cahill³

¹Department of Epidemiology and Public Health, University College Cork, Cork, Ireland.

²Department of General Practice, university College Cork, Cork, Ireland

³Department of Haematology, Cork University Hospital, Cork, Ireland

BACKGROUND: It has been estimated that 30% of patient encounters in Primary Care result in a laboratory test being requested. The volume of test requests rise annually by 3-6% despite a similar level of morbidity in the population. However, requesting patterns vary greatly between primary care physicians. The aim of this research is to identify the factors associated with higher requesting patterns.

METHODS: Cross-sectional analysis of routine laboratory data on serum immunoglobulin (Ig) test requests by 486 GPs in the South of Ireland. Data were extracted for 2013 using Cognos Impromptu software to interrogate the Health Service Executive's APEX laboratory system. Data extracted include physician level (gender, years of experience, college medical training obtained from, trainer GP status), practice level (urban/rural, practice type, size of practice) and patient level factors (gender, age, location). Using stata v12, multilevel Poisson regression analysis were performed to identify the factors associated with higher laboratory requesting patterns.

RESULTS: In 2013, over 18,000 Ig tests (IgA, IgG and IgM) for approximately 6,000 primary care patients in the South of Ireland. Primary care physician factors appear to have the strongest association with higher requesting patterns for tests. Male physicians' (OR: 1.3; 95%CI: 1.21-1.40), having a medical degree from a local university (OR: 1.53; 95%CI: 1.41-1.66), having a rural practice (OR: 1.45; 95%CI: 1.02-2.06) and the physician's years of experience (OR: 1.01; 95%CI: 1.005-1.01) were all positively associated with higher requesting patterns (p-value <0.05).

CONCLUSIONS: Physician level factors appear to have the greatest effect on laboratory requesting patterns. The design of future interventions aimed at optimizing laboratory use in Primary Care should consider these factors.

Keywords: laboratory testing, demand management, health services research, pathology, primary care physicians

OP-235

Shared clinical decision making: a Saudi Arabian perspective

Ali Alhaqwi

King Saud ben AbdulAziz University for Health Sciences, Riyadh, Saudi Arabia

OBJECTIVES: To determine preferences of patients regarding their involvement in the clinical decision making process and the related factors in Saudi Arabia.

METHOD: A cross-sectional study conducted in a major family practice center in Riyadh, Saudi Arabia, between March and May 2012. Multivariate multinomial regression models were fitted to identify factors associated with patients preferences.

RESULTS: The study included 236 participants. The most preferred decision-making style was "shared decision-making" 135/236(57%), followed by "paternalistic" 67/236(28%), and "informed consumerism" 34/236(14%). The preference for shared clinical decision making was significantly higher among male patients and those with higher level of education, whereas paternalism was significantly higher among older patients and those with chronic health conditions, and consumerism was significantly higher in younger patients (18-35 years old). In multivariate multinomial regression analysis, compared with the consumerism group, the shared group were more likely to be males [Adjusted odds ratio (AOR) = 2.71, 95% CI 1.23-5.97, p=0.014] and dyslipidemic (AOR = 2.92, 95% CI 1.03-8.25, p=0.04), and the paternalism group were more likely to be younger (AOR=13.14, 95% 1.03-9.54, p=0.04) and dyslipidemic (AOR=4.10, 95% CI 1.38-12.14, p=0.011).

CONCLUSION: Preferences of patients for involvement in the clinical decision-making varies considerably. In our setting, underlying factors that influence these preferences identified in this study should be considered and tailored individually to achieve optimal treatment outcomes.

Keywords: Clinical decision making, consultation, health education, patient centeredness

OP-236

Do Chronically Sick Children Differ From Their Peers Psycho-socially?

Seval Yaprak¹, Özden Gökdemir¹, Ülkü Bulut³, Yunus Emre Okudan², Dilek Güldal¹

¹DOKUZ EYLUL UNİVERSİTY/ MEDICAL FACULTY / FAMILY MEDICINE DEPARTMENT

²SULEYMAN DEMİREL UNİVERSİTY / MEDICAL FACULTY / CARDIOLOGY DEPARTMENT

³BALCOVA HEALTH CENTER / IZMIR

BACKGROUND

Chronical diseases are long term diseases that are expected to last for three months or more. The number of children with chronical diseases has increased due to developments in medicine. As chronical diseases require long term treatments, it decreases the quality of life. People face many physiological and psychological changes especially in their childhood and teenage years. The purpose of this study is to determine if there are differences between children who have chronical diseases and who don't with their emotional states and their relationship with their environment.

METHOD

Children of ages between 4 and 11 who have applied to pediatrics polyclinics were included in our case-control study. Children who do not have any of the identified chronical diseases either with a complaint less than 10 days or no complaint were included in the control group. A questionnaire about demographic features and strengths and difficulties questionnaire applied to the parents (SDQ). The questionnaire results were analyzed with SPSS 15 program; also descriptive tests and hypothesis tests were applied.

RESULTS

125 children were included in case and 125 children were included in control groups; and there weren't any differences observed between the two groups regarding age, gender and the closeness with their caregivers. Regarding SDQ total score, and peer relations subgroup score, there were statistically significant difference between the groups ($p=0.034$ and $p=0.015$). There was no significant difference between the groups considering the impact on life.

CONCLUSION

In our study it was observed that children with chronical diseases had problems with their peer relations.

Keywords: chronical diseases, peer children, psycho-social status

OP-237

Health Promotion Behaviours and its correlation with Self-Efficacy Perceptions among Postgraduate Students'

Emine Küpeli, Sevgi Özcan, Nafiz Bozdemir

Department of Family Medicine, Çukurova University, Adana, Turkey

BACKGROUND and AIM: Self-Efficacy is a person's belief in his/her ability to complete a future task or solve a future problem. Bandura identifies four factors (Experience, Modelling, Social Persuasion, Physiological Factors) affecting self-efficacy.

The aim of this study is to evaluate postgraduate students' health promotion behaviours and its correlation with self-efficacy perceptions.

METHOD: The sample population was composed of 338 postgraduate students from institutes of science, social and health of Çukurova University. The data was collected by an anonymous questionnaire, Health Promotion Lifestyle Profile-II (HPLP) scale, and Self Efficacy scale.

RESULTS: Of the 51.5% postgraduate students were male. The mean age was 32.6 ± 5.2 years. The mean score of HPLP scale was at middle level (129.3 ± 18.3), the highest score was taken from spiritual growth subscale and the lowest one was taken from physical activity subscale. Significant relation was found in nutrition ($p=0.012$) and spiritual growth ($p=0.003$) between males and females. Participants indicated their parents (59.5 % mother and 24.9 % father) as role models for lifestyle behaviours. The mean score of Self Efficacy Scale was at middle level (57.6 ± 7.0), the highest score was taken effort subscale and the lowest one was taken from social self efficacy subscale. The 25-29 age group has low social self efficacy score compared to the other age groups ($p=0.001$).

Correlation analyses indicated that "willingness to initiate behaviour", "persistence in the face of adversity", "ability to deal with others effectively" subscales were significantly associated with health-promoting lifestyle. Correlation values were given in table 1.

CONCLUSIONS: Family physicians should be take into account the self efficacy during the healthy life behaviours counselling. Appropriate interventions to enhance perceived self efficacy will be increase the effectiveness of counselling. Also, the importance of parents as role models should be used to increase awareness and motivation.

Keywords: Health promotion, self efficacy, family physician, postgraduate student

Table 1. Correlation Analyses Between Self Efficacy Scores and the Health Promotion Lifestyle Profile Scores

	Willingness to initiate behaviour	Willingness to expend effort in completing the behaviour	Persistence in the face of adversity	Ability to deal with others effectively	Self Efficacy (Total)
Health Responsibility	-0.208**	0.000	0.214**	0.207**	0.038
Physical Activity	-0.132*	0.036	0.234**	0.166**	0.097
Nutrition	-0.123*	-0.035	0.196**	0.174**	0.033
Spiritual Growth	-0.264**	-0.182**	0.468**	0.297**	0.040
Interpersonal Relations	-0.323**	-0.077	0.414**	0.291**	0.010
Stress Management	-0.131*	0.011	-0.327**	0.182**	0.103
Health Promotion Lifestyle Profile (Total)	-0.279**	-0.069	0.408**	0.313**	0.068

* $p < 0.05$, ** $p < 0.01$

OP-238

"{" Efficacy of Rapid Antigen Test and Proper Use of Antibiotics in Acute Tonsillopharyngitis Cases "}"

Tuğba Beyazcicek¹, Nejat Demircan¹, Ibrahim Etem Pişkin², Funda Ekimci Deniz¹, Ayşe Semra Demir Akça¹, Fatma Güven², Raşan Bulut¹

¹Department of Family Medicine, Faculty of Medicine, Bulent Ecevit University, Zonguldak, Turkey

²Department of Pediatrics, Faculty of Medicine, Bulent Ecevit University, Zonguldak, Turkey

INTRODUCTION AND AIM: Acute tonsillopharyngitis (AT) is one of the most frequently observed conditions encountered particularly by primary care physicians and pediatricians in outpatient setting. Inappropriate and excessive use of antibiotics increases treatment cost and risk for resistance development, and causes drug related side effects in patients. In this study, we aimed to determine frequency of GAS infection in cases with AT, sensitivity and specificity rates of rapid antigen test, and use of antibiotics.

MATERIAL-METHOD: Results of throat culture and rapid strep test (RST) in totally 693 patients who presented to pediatric outpatient clinics and pediatric emergency service in our hospital between September- December 2014 with symptoms and findings of AT were reviewed retrospectively. The study sample was divided into three groups as Group1 (0-3 years old), Group2 (4-15 years old) and Group3 (>15 years old).

RESULTS: Beta hemolytic GAS growth was detected in throat cultures of 18% (n=109) of 693 patients. There were statistically significant differences between age groups regarding growth in throat cultures ($p < 0.05$). According to comparison of the results of rapid antigen test with throat culture, sensitivity of rapid test was determined as

84%, specificity was 96%. Out of 109 patients with positive cultures, 97 (89%) were prescribed antibiotics, whereas 12 (11%) were not, HST results in 75% of these patients (n=9) were negative. Eighty of the 584 patients (13.6%) with negative culture results were prescribed antibiotics.

CONCLUSION: Rapid antigen test is valuable for the diagnosis and treatment of GAS in patients with AT owing to its high specificity. However, it is recommended to follow the result of throat culture in order to prevent inappropriate antibiotic use.

Keywords: Tonsillopharyngitis, rapid antigen test, group A streptococcus, children

OP-239

Daily workload and service profile of family physicians in Turkey: A snapshot of one-day work

Erdoğan Yavuz¹, Erol Yayla², Emrah Kırımlı³, Uğur Bilge⁴, Sercan Bulut Çelik⁵, Hatice Füsün Demirtaş⁶, Okay Başak⁷

¹1st Family Healthcare Center, Rize

²5th Family Healthcare Center, Afyon

³Ümraniye Family Healthcare Center, İstanbul

⁴Eskişehir Osmangazi University Department of Family Medicine

⁵11th Family Healthcare Center, Batman

⁶Siyavuşpaşa Family Healthcare Center, İstanbul

⁷Adnan Menderes University Department of Family Medicine, Aydın

BACKGROUND: Turkish primary care has undergone a drastic change starting in 2004 with a small city northern Turkey. The implementation of family medicine into primary care has been completed in 2010. Now, 21,175 family physicians (FPs) of whom 1,048 with post graduate training provides health care at 6,756 family health centers. Each FP has an average of 3,621 registered patients. Although almost five years have passed since the transition period has ended with the last city's incorporation to the system, little is known about the workday of a Turkish primary care doctor.

OBJECTIVES: The aim of the study is to determine the daily workload and to analyze the content of workload, to describe the service profile of FPs working in primary care in Turkey.

MATERIALS-METHODS: The study design is descriptive and cross-sectional. A total of 39 FPs from different provinces of Turkey volunteered to participate in the study. The date of 16th July which was Monday was chosen as the study day. Two surveys, one inquiring the demographic properties of FPs participated and a second encounter form with 43 items inquiring all aspects of FPs' workload were filled by the participants. 29 FPs responded and returned with survey forms. One report was excluded because lack of adherence to instructions. As a result 28 FPs from 17 different cities were enrolled into the study. The gathered information was used to form a database from where all descriptive statistical analyses were performed.

RESULTS: A total of 1,215 visits were reported. The average daily workload of FPs participating in our survey was 45.7 ± 16.8 visits. Mean age of the patients was 40 ± 25 years. Of these patients, 59.8% were female and 40.2% were male. 92.5% of all patients were family physicians' own registered patients while 7.5% of them were guests. A total of 1,610 RFEs were reported. We categorized them as prescription requests (451, 28%), clinical complaints (447, 27.8%), preventive medicine services (436, 27%), administrative reasons (161, 10%) and other reasons (115, 7.2%). Essential hypertension, dyspepsia and diseases of musculoskeletal system were the most common diagnoses in prescription requests. Sore throat, cough and pruritis were the top three clinical complaints. On 84 occasions (7%) FPs ordered a laboratory test for their patients. 16 patients (1.3%) had X-Ray imaging. 43 patients (4%) were referred to a hospital after clinical evaluation.

CONCLUSION: Our results suggest that FPs in Turkey are under severe pressure. Prescription requests account for an important percentage of this workload. Measures should be taken to lessen this burden. A nation-wide randomized morbidity and workload survey may elaborate more insight.

Keywords: Turkish primary care, Family physician, workload

Table 1: Characteristics of family physicians (n=28)

Table 1: Characteristics of family physicians (n=28)

Characteristic	Number(%)
(1) Practice area by province	
Western	13 (46.5)
Northern	8 (28.5)
Central	5 (18)
South-eastern	2 (7)
(2) Sex	
Female	14 (50)
Male	14 (50)
(3) Age	
30-39 years	17 (60)
40-49 years	10 (36)
50 years or more	1 (4)
(4) Number of years in practice	
0-9	6 (21.5)
10-19	16 (57)
≥ 20	6 (21.5)
(5) Size of practice group (number of FPs working together)	
Small practice group ≤ 2	1 (4)
Medium practice group 3-5	13 (46)
Large practice group ≥6	14 (50)
(6) Specialization	
Yes	27 (96)
No	1 (4)
(7) Numbers of patients seen on study day	
< 30	6 (21)
30-60	15 (54)
>60	7 (25)

Table 2: Distribution of RFEs

Table 2: Distribution of RFEs

RFE Category	n (1610)	%
1. Clinical complaints	447	27.8
2. Prescription requests	451	28
3. Preventive medicine services	436	27
4. Administrative reasons	161	10
5. Other	115	7.2

Table 3: Clinical complaints of patients

Table 3: Clinical complaints of patients

RFE	n (441)	ICD-10 code
Sore throat	98 (22%)	J02
Cough	49 (11%)	R.05
Pruritus	37 (8.3%)	L.29.9
Dyspepsia	36 (8%)	K.30
Fever, unspecified	34 (7.6%)	R.50.9
Rash and other nonspecific eruption	27 (6%)	R.21
Low back pain	28 (6.2%)	M.54.5
Pain in a joint	27 (6%)	M.25.5
Myalgia	23 (5.1%)	M.79.1
Rhinorrhea	17 (3.8%)	J.34.8
Malaise and fatigue	16 (3.5%)	R.53
Headache	16 (3.5%)	R.51
Constipation	11 (2.5%)	K.59.0
Sneezing	10 (2.2%)	R.06.7
Diarrhea, gastroenteritis and colitis of nonspecific origin	8 (1.8%)	A.09.9
Dizziness	4 (0.9%)	R.42

Table 4: The diagnoses in prescriptions requested from patients

Table 4: The diagnoses in prescriptions requested from patients

DIAGNOSIS	n (754)	(%)	ICD-10 Code
Essential (primary) hypertension	175	22.9	I10
Dyspepsia	81	10.6	K30
Diseases of musculoskeletal system and connective tissue	80	10.4	M0-99
Non-Insulin-Dependent Diabetes Mellitus	68	8.9	E11
Mood(affective) Disorders, Neurotic, stress-related and somatoform Disorders	59	7.7	F30-F48
Diseases of the skin and subcutaneous tissue	48	6.2	L00-99
Hyperlipidemia	42	5.4	E78.5
Chronic ischaemic heart diseases	28	3.6	I25
Hypothyroidism, unspecified	18	2.3	E03.9
Hyperplasia of prostate	17	2.2	N40
Vitamin B12 deficiency anaemia	15	1.9	D51
Headache	13	1.7	R51
Cerebrovascular disease, unspecified	12	1.5	I67.9
Acute nasopharyngitis	12	1.5	J00
Chronic obstructive pulmonary disease, unspecified	11	1.4	J44.9
Epilepsy	10	1.3	G40
Gonarthrosis (osteoarthritis of knee)	9	1.1	M17
Benign paroxysmal positional vertigo	9	1.1	H81.10
Constipation	9	1.1	K59.0
Venous insufficiency (chronic) (peripheral)	9	1.1	I87.2
Allergic rhinitis, unspecified	7	0.9	J30.4
Asthma	6	0.78	J45
Heart failure, unspecified	3	0.4	I50.9
Periapical abscess without sinus	3	0.4	K04.7
Insulin-dependent diabetes mellitus	2	0.26	E10
Unspecified acute lower respiratory infection	2	0.26	J22
Urinary tract infection, site not specified	2	0.26	N39.0
Acute conjunctivitis, unspecified	2	0.26	H10.3
Acute tonsillitis, unspecified	2	0.26	J03.9

Table 5: The list of preventive medicine services

Table 5: The list of preventive medicine services

Category of service	n (436)	Percentage(%)
Follow-up of women	122	28
Follow-up of children	84	19.2
Vaccination + follow-up of babies	56	12.9
Follow-up of babies	45	10.3
Follow-up of pregnant	37	8.5
Vaccination + follow-up of babies	37	8.5
Follow-up in puerperal period	24	5.5
Family planning services	13	3
Vaccination + follow-up of children	10	2.2
Obesity screening	8	1.9

Table 6: List of administrative RFEs**Table 6: List of administrative RFEs**

Category of service	n (161)	Percentage (%)
Sportsmen health certificates	56	34.7
Pre-employment health certificates	38	23.6
Health certificates requested for unclassified reasons	30	18.7
Health certificates requested for exemption of contribution fee	27	16.8
Health certificates for driving licenses	5	3.1
Pre-marriage health certificates	5	3.1

Table 7: RFEs listed under "Other" category**Table 7: RFEs listed under "Other" category**

Category	n (115)	(%)
Requests for laboratory tests	40	34.8
Consultations	32	27.8
Injections	27	23.4
Dressings and wound care	16	14

OP-240

Urinary Incontinence In Women and The Effects on Overall Health, Psychosocial and Sexual Life

Kubra Can, Nilgun Ozcakar

Family Medicine Department, Dokuz Eylul University, Izmir, Turkey

Background & Aim

Urinary incontinence(UI) is defined as involuntary leakage of urine that leads to social and hygienic problems. UI is common among women; leads to sexual and social disadvantages besides being a medical problem which cause deterioration of quality of life. Our aim was to determine the frequency of urinary incontinence in women applying to primary care, to investigate the effects on overall health, psychosocial and sexual life and to draw attention to the reasons for not seeking medical help.

Method

In this descriptive cross-sectional study a questionnaire was used including socio-demographic characteristics, ICIQ-SF(Incontinence Questionnaire Short Form), FSFI(Female Sexual Function Index) and EORTC QLQ-C30(European Organization for Research and Treatment of Cancer Quality of Life Questionnaire)version 3.0. Past medical history, family history and obstetric-gynecological history is taken about UI and risk factors, habits, additional diseases were asked. SPSS 16.0 was used for descriptive statistics, chi-square, t-test and ANOVA. $p < 0.005$ was considered statistically significant.

Results

Mean age was 49.42 ± 15.64 (N:422). Frequency of UI was 36.0% and only 50.5% of UI subjects seek medical help. Mean score of ICIQ-SF was 12.20 ± 4.71 (min=4.00, max=20.00); 31.8% of participants reported that they had UI with cough or sneeze. Mean age of incontinent and continents were 60.85 ± 11.42 and 42.99 ± 13.93 . Frequency of UI increased by age($p=0,000$) and by the number of vaginal delivery(76.0% of women give birth 4 and more had UI)($p=0,000$). Also a statistically significant relationship was found between coughing and constipation with UI(respectively, $p=0,000$, $p=0,000$). EORTC QLQ-C30 general health scores were lower for UI ($p < 0.000$).

Conclusions

UI is common in women and major proportion of incontinent women considers this as a part of being woman and getting older, so they don't seek medical help. So family physicians should take care of the incontinent women more in primary care to increase health quality.

Keywords: Urinary incontinence, women, quality of life

OP-241

Characteristics of patients making serious inhaler errors with a dry powder inhaler and association with asthma-related events in a primary care setting

Janine Anne Marie Westerik¹, Victoria Carter¹, Henry Chrystyn², Anna Burden¹, Samantha Thompson¹, Dermot Ryan³, Kevin Gruffydd Jones⁴, John Haughney⁵, Nicolas Roche⁶, Federico Lavorini⁷, Alberto Papi⁸, Antonio Infantino⁹, Miguel Román Rodríguez¹⁰, Sinthia Bosnic Anticevich¹¹, Karin Lisspers¹², Björn Stållberg¹², Svein H Henrichsen¹³, Thys Van Der Molen¹⁴, Catherine Hutton¹, David B. Price¹

¹Research in Real-Life, Cambridge, UK

²Independent Inhalation Consultant, Bingley, UK

³Woodbrook Medical Centre, Loughborough, UK

⁴Box Surgery, Box, UK

⁵Academic Primary Care, University of Aberdeen, UK

⁶University Paris Descartes, Cochin Hospital Group, Paris, France

⁷University Hospital, Florence, Italy

⁸University of Ferrara, Italy

⁹Italiana Interdisciplinare per le Cure Primarie, Bari, Italy

¹⁰Son Pisa Primary Care Health Centre, Palma de Mallorca, Spain

¹¹University of Sydney, Australia

¹²Uppsala University, Sweden

¹³Langbolgen Legesenter, Oslo, Norway

¹⁴University of Groningen, the Netherlands

OBJECTIVE: Correct inhaler technique is central to effective delivery of asthma therapy. The study aim was to identify factors associated with serious inhaler technique errors and their prevalence among primary care patients with asthma using the Diskus dry powder inhaler (DPI), reportedly associated with the fewest errors of the DPIs.

METHODS: Historical cross-sectional study (2011–2013) using the iHARP database, which includes patient- and healthcare provider-reported questionnaires from 8 countries. Patients with asthma were observed for serious inhaler errors by trained healthcare providers as predefined by the iHARP steering committee. Multivariable logistic regression, stepwise reduced, was used to identify demographic and clinical factors associated with ≥ 1 serious errors.

RESULTS: Of 3681 patients with asthma, 623 (17%) were using a Diskus (mean [SD] age, 51 [14]; 61% women). A total of 341 (55%) patients made ≥ 1 serious errors. The most common errors were the failure to exhale before inhalation, insufficient breath-hold at the end of inhalation, and inhalation that was not forceful from the start. Factors significantly associated with ≥ 1 serious errors included asthma-related hospitalization the prior year (odds ratio [OR] 2.07; 95% confidence interval [CI], 1.26–3.40); obesity (OR 1.75; 1.17–2.63); poor asthma control the prior 4 weeks (OR 1.57; 1.04–2.36); female sex (OR 1.51; 1.08–2.10); and no inhaler technique review the prior year (OR 1.45; 1.04–2.02).

CONCLUSIONS: Poor inhaler technique is an ongoing problem. Patients with evidence of poor asthma control should be targeted for review of inhaler technique even when using a device thought to have a low error rate.

Keywords: Asthma therapy, cross-sectional, Diskus inhaler, multinational, primary care

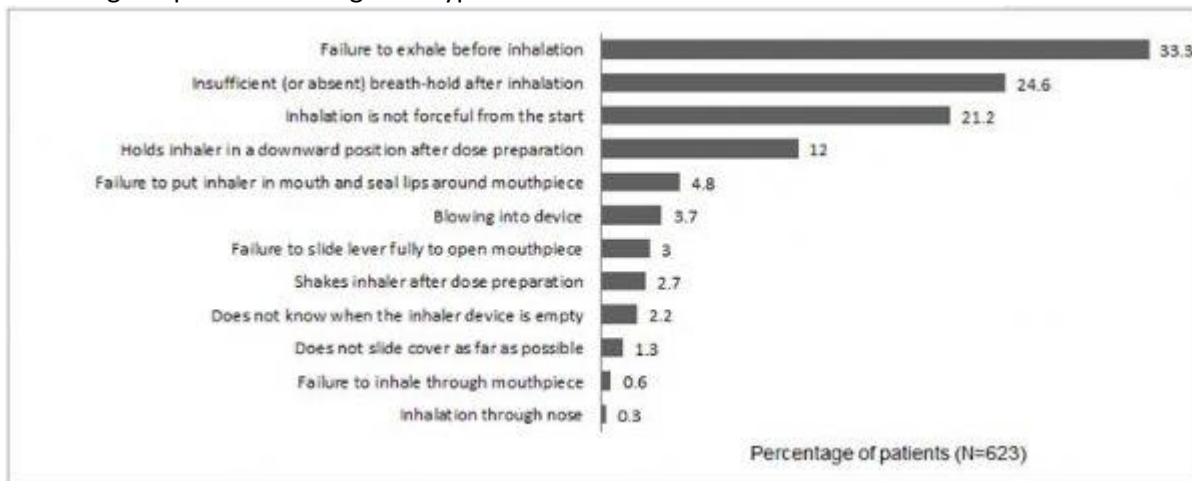
Demographic and clinical factors associated with making ≥ 1 serious error vs. 0 (multivariable results)

Table 1. Demographic and clinical factors associated with making ≥ 1 serious error vs. 0 (multivariable results)

	Reference category	Category	Odds ratio (95% CI)	P-value	Overall P-value
Sex	Male	Female	1.51 (1.08–2.10)	0.017	
BMI	Underweight / Normal weight	Overweight	1.18 (0.80–1.74)	0.401	0.024
		Obese	1.75 (1.17–2.63)	0.007	
Inhaler review	Yes	No	1.45 (1.04–2.02)	0.027	
ATAQ	Well-controlled / Mediocre control	Poor control	1.57 (1.04–2.36)	0.031	
Inpatient admission or ED attendance	0	≥ 1	2.07 (1.26–3.40)	0.004	

Abbreviations: ATAQ, Asthma Therapy Assessment Questionnaire; BMI, body mass index; ED, emergency department

Percentage of patients making each type of serious inhaler error with the Diskus



OP-242

Frozen shoulder: treatment with corticosteroid injections without and with distension or wait and see, a randomized controlled trial

Satya Sharma, Anders Bærheim, Alice Kvåle

Institute of Global Health and Primary care, Section of General practice, University of Bergen, Norway

“Objective”: To find out whether treating adhesive shoulder capsulitis (frozen shoulder) by injections with corticosteroid and distension is more effective than treating with corticosteroids alone or treatment as usual in a primary care setting. “Design”: A prospective randomized intention to treat study. “Setting and subject”: All 105 recruited patients were randomized to one of three groups: Group 1 received intra-articular corticosteroid injection; group 2 received in addition sodium chloride as distension varying from 8 ml to 20 ml, while group 3 was control group. Thirty five patients in group 1 and 34 patients in group 2 received four injections each within the time frame of 8 weeks. All patients were assessed on the 1st visit, and at the 4th and 8th week with Shoulder Pain and Disability (SPADI), Numerical pain rating scale (NPRS) and range of motion (ROM). Postal assessment was repeated at 1 year for SPADI. “Results”: Out of the 216 patients referred for the study, 146 met the inclusion criteria, 40 patients declined to participate. There were no statistical significant differences between group 1 & 2 in SPADI, NPRS and ROM at baseline, at 4 weeks, 8 weeks or 12 months. There were statistically significant differences when comparing group 1 & 3 and group 2 & 3 at 4 and 8 weeks for SPADI ($p<0.01$; $p<0.001$), NPRS ($p<0.01$) and ROM ($p<0.01$ for lateral rotation), but not at 12 months. Comparison in outcomes between group 2 & 3 was slightly better than between group 1 & 3, but not clinically significant. “Conclusion”: Intervention by corticosteroid injection is better than “wait and see” policy in adhesive shoulder capsulitis in the short term. There was no statistical significant difference in outcome with intra-articular corticosteroid injection with distension compared to corticosteroid alone.

Keywords: Shoulder capsulitis, frozen shoulder, Corticosteroid

OP-243

Evaluation of Screening and Risk Factors for Breast and Cervix Cancer in Rize, 2011

Özden GÖKDEMİR, Mehtap Kartal

Dokuz Eylül University, Medical Faculty, Family Medicine Department, İzmir, Turkey

BACKGROUND & AIM: Gynecological cancers are the biggest cause of mortality and the morbidity after breast cancer for women. Early diagnosis has an important role for women's health. The aim of is to evaluate results of the screening program for breast and cervix cancer and related risk factors.

METHOD: It's a descriptive study that is based on the database of Cancer Early Diagnosis, Screening and Education Center in Rize at 2011 when its second year of the population-based screening program. The screening results and the common risk factors of breast cancer and cervix cancer have been evaluated. The database includes socio-demographic characteristics (age, marital and education status), risk factors for breast cancer (smoking habits, oral contraceptive, hormone replacement therapy, family history of breast cancer, family history of other cancers, the age of menarche, the age of menopause and, number of labor, breast feeding), cervix cancer (the age of coitus).and results of screening for breast and cervix.

RESULTS: In 2011, 1249 women were screened either or both for breast and cervix cancer. Their mean age was 47.0 ± 9.9 (Range:26-73 years). Of the women 98.6% were married, 63.3% educated in primary-secondary school. The mean age of marriage was 19.5 ± 3.8 (Range:10-32 years) and mean age of menopause was 46.9 ± 6.1 (Range:21-60 years). Number of breast USG, mammography, and smear applied for screening were 1064, 978 and 1249, respectively and the results other than normal that needed to be followed up or referred to general surgery clinic and/or gynecology clinic were 144 (13.7%), 56 (6.7%), 11 (0.9%), respectively.

CONCLUSION: Although population-based screening program is ongoing its second year, there is a need for

facilitated accessibility and enhanced appropriate motivation with reliable information resources so that the program can work effectively, efficiently for promotion of healthy behavior.

Keywords: screening, public health, breast cancer, cervix cancer, risk factors

Table 1 Sociodemographic characteristics of women screened

Table 1 Sociodemographic characteristics of women screened

		Screening for Breast cancer				Screening for Cervix cancer	
		USG		MMG		Smear	
		n	%	n	%	n	%
Age groups (years)	<35	577	54.3	0	0	717	57.5
	35-44	366	34.4	250	25.6	407	32.6
	>44	120	11.3	727	74.4	124	9.9
	Total	1063	100.0	977	100.0	1248	100.0
Marital status	Single	12	1.1	11	1.1	1	0.1
	Married	1052	98.9	967	98.9	1248	99.9
	Total	1064	100.0	978	100.0	1249	100.0
Education	Illiterate	203	19.1	251	25.7	256	20.5
	Literate	106	10.0	122	12.5	122	9.8
	Primary-secondary school	675	63.4	567	58.0	795	63.7
	Lycee-University	80	7.5	38	3.9	76	6.1
	Total	1064	100.0	978	100.0	1249	100.0

Table 2 Risk factors of women screened

Table 2 Risk factors of women screened

		Screening for Breast cancer				Screening for Cervix cancer	
		USG		MMG		Smear	
		n	%	n	%	n	%
Smoking status	Current smoker	182	17.1	145	14.8	209	16.7
	Former smoker	49	4.6	33	3.4	53	4.2
	Never smokers	795	74.7	762	78.0	944	75.6
	Unknown	38	3.6	37	3.8	42	3.4
	Total	1064	100.0	977	100.0	1248	100.0
Oral contraceptive	Yes	205	19.3	184	18.8	249	19.9
	No	858	80.6	792	81.0	998	79.9
	Unknown	1	0.1	2	0.2	2	0.2
	Total	1064	100.0	978	100.0	1249	100.0
Hormone replacement treatment	Yes	52	4.9	46	4.7	59	4.7
	No	1010	94.9	929	95.0	1188	95.1
	Unknown	2	0.2	3	0.3	2	0.2
	Total	1064	100.0	978	100.0	1249	100.0
Family history of breast cancer	Yes	153	14.4	134	13.7	167	13.4
	No	910	85.6	843	86.3	1081	86.6
	Total	1063	100.0	977	100.0	1248	100.0
Family history of cancer	Yes	499	47.0	470	48.2	580	46.5
	No	563	53.0	506	51.8	667	53.5
	Total	1062	100.0	976	100.0	1247	100.0
Age of menarche (years)	<14	6	0.6	9	0.9	8	0.6
	14-17	506	47.7	481	49.3	583	46.8
	>17	549	51.7	485	49.7	655	52.6
	Total	1061	100.0	975	100.0	1246	100.0
Number of labor	<1	181	17.1	223	22.9	231	18.6
	1-4	818	77.1	696	71.4	962	77.1
	>4	62	5.8	56	5.7	54	4.3
	Total	1061	100.0	975	100.0	1247	100.0
Breast-feeding	Yes	989	93.0	908	92.9	1184	94.8
	No	73	6.9	68	7.0	63	5.0
	Unknown	1	0.1	1	0.1	2	0.2
	Total	1063	100.0	977	100.0	1249	100.0
The age of marriage	<14	716	67.5	613	62.9	835	67.0
	14-17	316	29.8	331	34.0	398	31.9
	>17	28	2.6	30	3.1	13	1.0
	Total	1060	100.0	974	100.0	1246	100.0
Screening results	Healthy	904	86.3	777	93.3	1223	90.1
	Needs follow up/referral	144	13.7	56	6.7	11	0.9
	Total	1064	100.0	978	100.0	1249	100.0

OP-244

Promoting Risk Factor for Pulmonary Tuberculosis Treatment in Manado City

Henry Palandeng¹, Joy Zeekeon², Margareth Sapulete¹, Gideon Tombokan³

¹Department of Community Medicine, Faculty of Medicine, Sam Ratulangi University

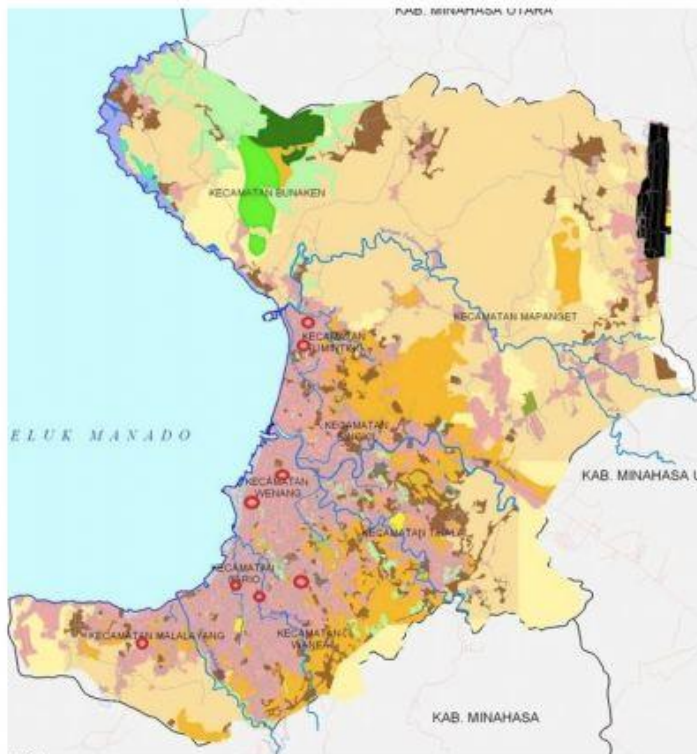
²Health Service Department of Manado City

³Medical Student at Faculty of Medicine, Sam Ratulangi University

Pulmonary tuberculosis (TB) is an airborne disease caused by *Mycobacterium tuberculosis*, which can infect healthy individuals who breathe in infected air. Although promoting risk factors for patients with Tuberculosis is something that health workers should do, there is a new problem during the diagnostic and therapeutic developments that is the Multi-drugs Resistant Tuberculosis (MDR-TB). MDR-TB is the biggest problem of the prevention and eradication of TB's. Data from MDR-TB Polyclinic RSUP Prof. Dr. R. D. Kandou in 2014 showed that there were eight pulmonary TB patients who developed MDR-TB. The purpose of this research is to know the overview of pulmonary TB patients' risk factors in developing MDR-TB in Manado in 2014. This research is a descriptive research. Both primary data from questionnaires and secondary data from MDR-TB Polyclinic were used as instruments for this research. The secondary data obtained during April-December 2014 showed that there were eight MDR-TB patients who live in four different districts in Manado City. This research shows about description of risk factors for patients with Multi Drug Resistant Tuberculosis in Manado City, it can be concluded that some elements in the MDR-TB prevention programs such as health education and supervision taking medication should be repaired because the priority is prevention rather than cure of patients. Also it can be concluded that evaluation need to be done in many aspects, but mainly focusing on the educative, informative, and communicative aspects of the health officers in giving the patients a healthcare. Patients must be given a clear understanding as well as motivation from the health officers to comply with the treatment regimen. Periodic evaluation of the pulmonary TB control and prevention of MDR-TB in the city of Manado for the success of the treatment in accordance with the ISTC (International Standards for Tuberculosis Care) is very important.

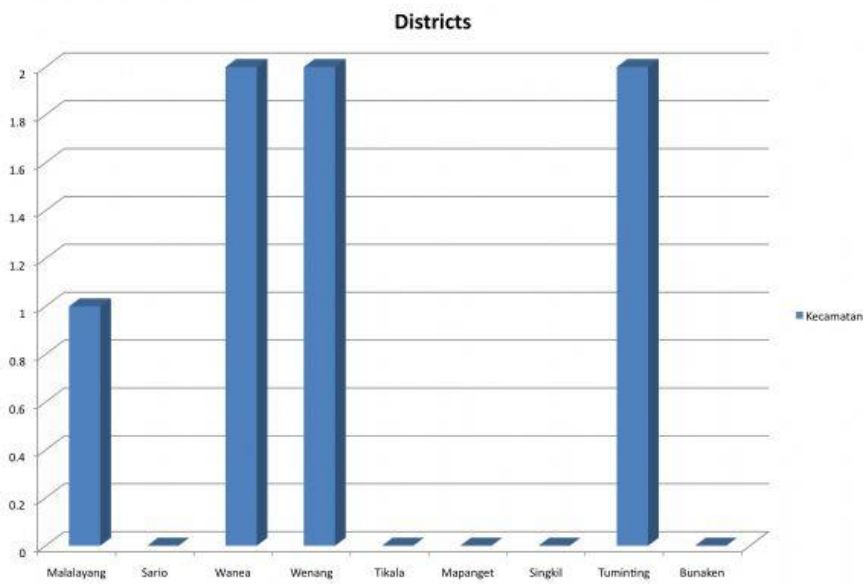
Keywords: Pulmonary TB, risk factors, MDR-TB

Figure 1



Map Distribution of Respondents by Research Area

Figure 2



Distribution of Respondents by Location

Table 1

Answers	%
Yes	28.6
No	71.4
Total	100

Distribution of Respondents Opinions About Health Officer Explanation Regarding Tuberculosis

Table 2

Answer	%
Yes	71.4
No	28.6
Total	100

Distribution of Respondents Opinions About Health Officer Explanation Regarding Tuberculosis

Table 3

Answer	%
Yes	57.1
No	42.9
Total	100

Opinions Distribution of Respondents Regarding Health Officer Inquire Progress In Tuberculosis Treatment On Every Visits

OP-245

Validity and Reliability Test of Risk Assessment for Coronary Heart Disease in Indonesia Community Setting: Preliminary Study

Marita Fadhilah¹, Melia Fatrani Rufaidah¹, Irvan Fathurrohman¹, Riza Mawaddatar Rohmah¹, Raka Prazasta¹, Aliefa Asyifa¹, Muhammad Zulhafdy³, Witri Ardini², Fika Ekayanti¹, Risahmawati Tholib¹

¹Department of Community Medicine, Syarif Hidayatullah State Islamic University, Jakarta, Indonesia

²Department of Clinical Nutrition, Syarif Hidayatullah State Islamic University, Jakarta, Indonesia

³Department of Ophthalmology, Syarif Hidayatullah State Islamic University, Jakarta, Indonesia

Background and Aim

Recently, prevalence of coronary heart disease in middle low-income countries is increasing. Therefore, prevention of coronary heart disease is urgent and in Indonesia still there is no standard of risk assessment for coronary heart disease. This study aims to measure validity and reliability of risk assessment for coronary heart disease in Indonesia community setting.

Method

This study was a cross sectional study and conducted on April 2015 at Cinere district, Depok, West Java Province, Indonesia. We involved 30 respondents, over 30 years old consecutively. Respondents were asked to fill questionnaires and were examined blood pressure, total cholesterol and fasting blood glucose. We modified 8 items risk assessments of Framingham risk score and examined those tests. For statistical analysis we computed Spearman correlation to predict validity and Cronbach's alpha coefficient to measure reliability of this instrument.

Results

The predictive validity was lower for 3 items; test of diabetes, family history of coronary heart disease and patient history of HDL (Spearman correlations = 0.09; 0.03; and 0, respectively). For others of 5 items; age, test of fasting blood pressure, test of total cholesterol, smoking and gender (Spearman correlations = 0.79; 0.66; 0.35; 0.19 and 0.17), the predictive validity was moderate to good. In general Cronbach's alpha coefficients were moderate to good ($\alpha = 0.47-0.63$).

Conclusion

This study shows vary validity (from lower to good validity) and provides reliable risk assessment for coronary heart disease in Indonesia community setting.

Keywords: validity, reliability, risk assessment, coronary heart disease

OP-246

Attitudes Of Medical Faculty Towards LGBT Individuals

İnan Arslantaş¹, Kemal Mustan¹, Neşe Yeniçeri², Dilek Güldal¹

¹Department of Family Medicine, Dokuz Eylul University, Izmir, Turkey

²Department of Family Medicine, Sitki Kocman Univeristy, Mugla, Turkey

INTRODUCTION:

Primary determinants of physicians' attitudes towards LGBT individuals (LGBTs) is the medical education and the attitudes of medical faculty (MF). We aimed to determine the attitudes and behaviours of MF.

METHODS:

A cross-sectional study was conducted among the MF of Izmir Dokuz Eylul University (DEU) and Mugla Sitki Kocman University (SKU). A questionnaire including demographic data, involment to LGBT health in medical education and health services was applied to participants besides Hudson-Ricketts Homophobia Scale (HRHS). Questionnaires were given to MF and collected later to avoid labeling. Our aim was to reach at least 50% response rate. All data analysis were performed using SPSS (version 15.0).

RESULTS:

144 volunteer MF with mean age of 47,30 (SD: \pm 6,81) were included; 82.6% of them were from DEU and 44.4% of them were women. 72.9% of them were from clinical departments and 30 of them from surgery; as 27.1% of them were from non-clinical departments. 73.6% of all MF didn't have previous education and 86.1% don't educate students on LGBT health. 80.6% of MF reported that LGBTs rarely or never consults them. 91.7% of MF believed that LGBT health issues were not discussed during medical education. 56.9%, 57.6% and 66% of MF believed that LGBT patients, students and MF were discriminated, respectively. MF mean HRHS total score was 82,69 (SD: \pm 27.73). MF place of employment ($p<0.001$), sex ($p=0.006$), department ($p=0.01$), previous education and educating students about LGBTs ($p=0.001$ and $p<0.001$, respectively), consulting frequency for LGBTs ($p=0.005$), believing that LGBT patients, students and MF are discriminated ($p=0.027$, $p=0.002$ and $p=0.025$, respectively) were significantly related to MF HRHS score.

CONCLUSION:

According to our study results, MF homophobia levels are found high and related with sex, department, education and seeing LGBT patients.

Keywords: LGBT, Hudson-Ricketts Homophobia Scale, homophobia, medical faculty, attitude, education

OP-247

Homeless HepCheck: Screening for Hepatitis C (HCV) of the Homeless in Dublin Ireland

Carol Murphy¹, Anjali Patel², Gordana Avramovic², Austin O Carroll³, John Lambert³

¹Trinity Collage

²Mater misericordiae Hospital

³Universtiy collage Dublin

Background & AIMS: An estimated 160 million people are infected with HCV globally. In Ireland, 20,000-50,000 are HCV positive, with government statistics reporting 79% of infections from sharing contaminated injecting equipment. Many homeless people injecting drugs in Dublin attend the 'Safetynet' homeless services, a primary care network providing medical/nursing services. Historically HCV treatment was not offered unless they fulfilled strict criteria ie drug free with stable accommodation. We decided to offer opportunistic HCV screening to 1000 homeless through the Safetynet services in collaboration with the Mater Misericordiae University Hospital (MMUH); and track them through their linkage to secondary care.

METHODS: Recruitment is open to all attending Safetynet services. A blood test or oral swab for HCV is required. Patients are medically/socially assessed prior to hospital referral. Qualitative and quantitative data are collected on those HCV positive, and questionnaires conducted on 10% of those tested.

RESULTS: To date 127 people (82 male and 33 females) have enrolled; 27 previously screened as HCV positive, with 7 engaged in specialist care. Fifteen newly identified HCV + were referred to Infectious Disease Clinic, with 8 attending appointments.

Sixteen participants, aged 20-47 years completed the questionnaire. 56% reported poor to fair health, with issues including: HIV co-infection, dental problems and asthma. Eight reported engagement in GP practice. Reasons for non-engagement included 'illicit drug use' and 'not interested'. Eight (50%) respondents were homeless due to addiction issues 'drug taking'. Four (25%) of these reported 1st injecting drugs under the age of 18, with 11 (69%) injecting after the age of 21.

CONCLUSION: Preliminary data illustrates homeless people have poor states of health. Lack of stable accommodation impedes engagement with medical services. Despite indicating interest in treatment 50% failed to attend appointments. Active outreach and a creative approaches to providing appointments are needed.

Keywords: HCV, homeless, PWID, HCV treatment

OP-248

Testing times ahead: a systematic review of interventions aimed at improving laboratory testing in primary care

Sharon Louise Cadogan¹, John Patirick Browne¹, Colin Patrick Bradley², Mary Rose Cahill³

¹Department of Epidemiology and Public Health, University College Cork, Cork, Ireland.

²Department of General Practice, University College Cork, Cork, Ireland

³Department of Haematology, Cork University Hostpital, Cork, Ireland

BACKGROUND: Laboratory testing is an integral part of day-to-day primary care practice underlying approximately 70% of diagnoses and treatment decisions. Research suggests that a large proportion of requests are avoidable. The aim of this systematic review was to comprehensively search the literature for studies evaluating the effectiveness of interventions for improving general practitioners (GPs) use of laboratory tests.

METHODS: PubMed, Cochrane Library, Embase and SCOPUS (from inception to 09/02/14, updated November 2014) were searched. Study designs considered included: systematic reviews, randomised controlled trials (RCTs), controlled clinical trials (CCTs), controlled before and after studies (CBAs) and interrupted time series analysis (ITSs). The population of interest were GPs. Interventions aimed to improve laboratory testing in General Practice were considered. The outcome of interest was volume of tests. Quality and risk of bias was assessed using a modified version of the EPOC Data Collection Checklist and Quality Criteria for studies with a control group (RCTs, CCTs and CBAs) and ITSs studies.

RESULTS: In total, 6,166 titles and abstracts were reviewed, followed by 87 full texts. Of these, 11 papers were eligible for inclusion in the systematic review (four RCTs, six CBAs and one ITS study). Interventions included education, feedback, guidelines, education with feedback, feedback with guidelines and changing order forms. Quality of studies varied with seven having a low risk of bias, three with unclear risk and one with high risk of bias. All but one study found significant reductions in volume of tests following the intervention, with effect sizes ranging from 1.2% to 60%. Due to heterogeneity, results could not be meta-analysed.

CONCLUSION: Feedback and education (including guidelines) based interventions proved most effective for changing GP requesting behaviour. However, the quality of some of the included study designs and the inclusion of various different tests between studies should be considered.

Keywords: laboratory testing, Health Services Research, demand management, interventions, education

OP-249

The attitudes of the Health Management Students in Selcuk University about the law 4207

Esra Meltem Koç, Fatma Özlem Yılmaz, Musa Özata, Rabia Kahveci
General Directorate of Health Research, Minisy

OBJECTIVES: In Turkey, 23% of all death arises from tobacco-related illnesses. 'National Tobacco Control Program' had developed in Turkey by the Ministry of Health (MoH) in 2009 with amendment of Law 4207 in 2008. All closed places became smoke-free with the Law 4207. The National Media Campaign has been initiated with the slogans "Smoke Free Air-Zone" (SFAZ) for raising public awareness. The ratio of smoking consumption decreased from 33,4% to 27,1% between 2008 and 2010 with this campaign.

Health managers are one of the important milestones in that campaign for being an implementer and an example to the community. The aim of our study is to determine the tobacco related health knowledge, smoking patterns, attitudes, quit attempts/successes and the barriers to quitting smoking reported by current smokers of students at the Department of Health Management in a university in Turkey four years after the application of SFAZ.

METHODS: In this study we used a questionnaire with 33 questions, developed by researchers and Fagerstrom Nicotine Dependent Test to obtain the addiction level of the smokers. We applied these instruments to 244 students.

RESULTS: 38% of the students were male and 62% of them were female. 86 % of the students had never smoked, 3% were ex-smokers and 11 % were current smokers. 5,2% of females and 19,3% of males are smoking. 87,5 % of smokers think smoking habit is harmful. 12,5% of smokers say that they have never thought whether cigarette is harmful or not. 41,4% of the student agree that the law 4207 was generally adopted.

CONCLUSION: Only a few studies concerning the thoughts of health managers about the Law 4207 have been made after National Tobacco Control Program in our country. So, our research has an importance to highlight this subject and increase the awareness about the company.

Keywords: smoking, health management, attitudes, tobacco control program,

OP-250

Evaluation of Care Burden, Anxiety and Depression Levels in Caregivers of Home Care Unit Patients

Dursun Çadirci¹, Gülayşe Tiyek², Erhan Yengil³

¹Department of Family Medicine, Harran University, Şanlıurfa, Turkey

²Department of Home Care Unit, Şanlıurfa Mehmet Akif İnan Training and Research Hospital, Şanlıurfa, Turkey

³Department of Family Medicine, Mustafa Kemal University, Hatay, Turkey

BACKGROUND & AIM:

Home care units are founded for care and follow-up of patients with chronic diseases. The number of people in need of care service has risen in our country, where the elderly population has gradually been increasing. Caregiving process is a difficult one for both the bedridden patients receiving care and caregivers who fulfils the patient's needs. Besides, caregiving leads to a significant burden for families.

The purpose of this study was to evaluate levels of anxiety, depression and care burden in caregivers of home-care patients.

METHOD:

A total of 86 caregivers in Sanliurfa Research Hospital Home-Care-Unit, participated in the study between February-March 2013. Sociodemographic Data Form, Zarit Caregiver Burden Scale(ZCBS), Beck Depression Inventory(BDI), Beck Anxiety Inventory(BAI) were applied.

Those who had BDI scores of 17 and over were considered to have depressive symptoms; those who had BAI scores of 8 and over were considered to have anxiety symptoms.

RESULTS:

Sociodemographic characteristics of the patients and caregivers were given in Table1. Distribution of the patients' diseases are presented in Figure1. Mean caring duration was 6.4 ± 6.4 years. The patients were cared by mostly their mothers(23.3%) and spouse(20.9%). The mean BDI of our study group was 9.9 ± 7.7 , BAI was 10.9 ± 8.0 , ZCBS was 57.9 ± 18.1 . Caring duration was correlated with BDI and ZCBS however there was no correlation with BAI. The age of caregiver was correlated to both BAI and BDI. ZCBS was positively correlated to BDI and BAI.

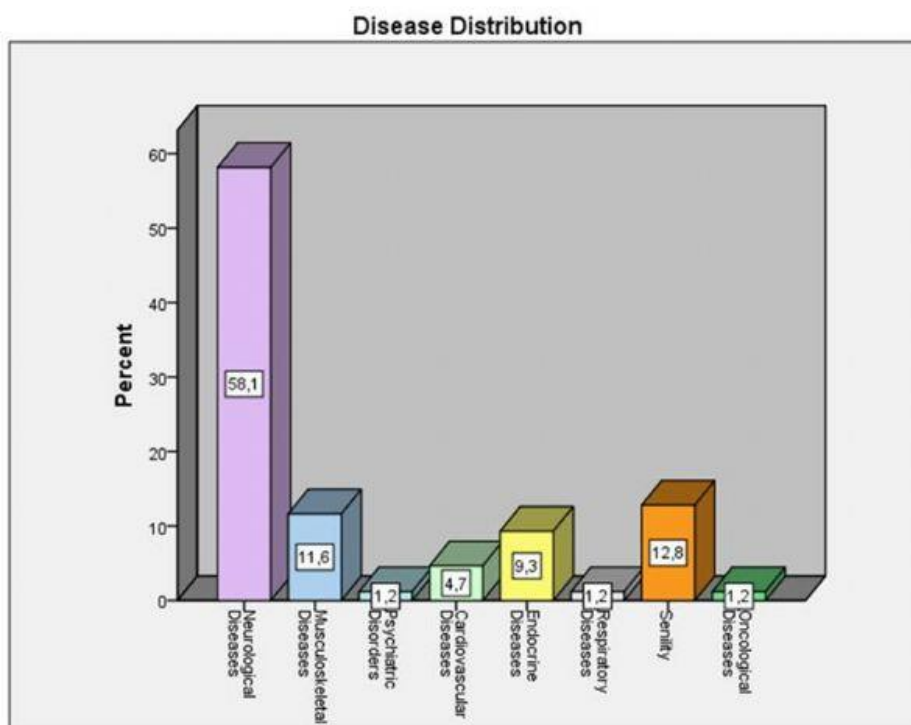
CONCLUSION:

In the present study, the burden level of the caregivers was found to be severe however the anxiety level was mild. The depression level was observed below the cut-off point. The burden level was significantly correlated to depression and anxiety levels.

None of the authors has any proprietary or financial interest in conception and design of this study.

Keywords: Caregiver burden, depression, anxiety, home care.

Figure 1



Distribution of the patients' diseases.

Socio-Demographic Characteristics of the Caregivers and Patient

Patients	Mean ± SD	Min- Max
Age (Year)	68.2±17.7	19-95
		Number(%)
Gender	Female	53 (61.6)
	Male	33 (38.4)
Caregiver	Mean ± SD	Min- Max
Age (Year)	42.1±16.3	17-82
		Number(%)
Gender	Female	75 (87.2)
	Male	11 (12.8)
Marital Status	Single	21 (24.4)
	Married	55 (64.0)
	Other	10 (11.6)
Education	None	27 (31.4)
	Literate	8 (9.3)
	Primary	32 (37.2)
	Middle	7 (8.1)
	High	9 (10.5)
	University	3 (3.5)
Job	Unemployed	81 (94.2)
	Private Sector	1 (1.2)
	Self-Employment	1 (1.2)
	Professional Caregivers	3 (3.5)

OP-251

The Effects of Preoperative Counseling Service on Anxiety

Elif Gürakar, Hadiye Küçükkaragöz, Azize Dilek Güldal

Department of Family Education and Counseling, Dokuz Eylül University, İzmir, Turkey

It is known that people who claim concerns before surgical intervention about the surgery, have hard time accommodating themselves, go through more psychological issues, feel anger and regret after the surgery and their perception of pain increase. The worries of the hospitals attendants also increase the worrying level of the patient. The objective of our study is to determine the effects of counseling and training given to patients and their attendants on preoperative anxiety level and postoperative pain level.

METHOD:

This randomized controlled trial was done with patients who were going to have lumbar spine surgery and their attendants. As data collecting tools; a) State Trait Anxiety Inventory, b) Patient Info Form, c) Hospital attendant's Info Form", d) "Postop Evaluation Form" were used. The people who had high state anxiety scores were excluded from the study. "Preoperative Anxiety Psycho-Training Program" was applied to experiment group. These tools were applied to both experiment and control groups both at admission and pre-operation; experiment group also received information about counseling and operation besides relaxation techniques. The data was evaluated using SPSS 15 program.

RESULTS: Mean trait anxiety scale scores of the control group on admission and preoperatively were 44.0 and 48.9 in order; and the scores of the experiment group were 46.3 and 42.0. There was significant difference in preoperative scores of control and experiment groups. between ($P=0.000$). A positive correlation was observed between the concern levels of the patients with their attendants both within control and experiment groups and these results were found out to be statistically significant ($p=0.001$). Post-operative pain levels of the experiment group were found out to be lower than control group ($P=0.000$).

CONCLUSION: Receiving preoperative counseling and training lowers the concern levels of the patients and their attendants as well as helping them to cope with post-operative pain.

Keywords: family counseling, preoperative and postoperative anxiety, training program, pain

OP-252

Mortality by Cause According to Age Group Between Women in a Brazilian Metropolis

Ana Luísa Franco Moura, Gustavo Aguilar Alvarenga Amorim, Lara Louise Guimarães Silveira, David Carvalho Rezende, Wallace Pinheiro Rodrigues, Lorena De Almeida Ribeiro Prudente, Vinicius Bernardes Mendonça Damasceno, Natália Carasek Matos Cascudo, Camila Garcia De Souza, Ayssa Teles Abrão Trad
School of Medicine, Federal University of Goiás, Goiânia, Brasil.

Although Brazilian's population life expectancy has increased, cancer, chronic degenerative diseases and deaths due to external causes such as homicides and suicides have stood out among the leading causes of death.

This study aimed to identify the main causes of death according to age groups analyzed, establishing a relationship between the incidence of a particular disease and the age group most affected by it.

The method used consisted of the collection and interpretation of data obtained from 485 death certificates of women at childbearing age (10 to 49) living in Goiânia - GO, Brazil, in 2013. All data collected were obtained from DATASUS site using the descriptors "Death", "Women", "Reproductive Age" and "Age Group Second Chapter CID-10."

There have been 10 deaths of women between 10 and 14 years, of which 40% corresponded to external causes of morbidity and mortality. The records of 27 women between 15 and 19 pointed also to external causes, accounting for 48.1% of cases, and neoplasms and endocrine, nutritional and metabolic diseases, both with 11.1%. In 82 women aged 20 to 29 years, the causes of death that stood out were external causes, with 51.2%, and cancer, with 11%. In 126 women aged 30 to 39 years, there were 27% of cases of cancer, 19% of cardiovascular diseases, 19% of external causes and 8% of digestive diseases. Finally, the main causes of causes of

death that attacked the 240 women between 40 and 49 years were neoplasms, 31.7%, circulatory diseases, 24.2%, and external causes, 12.5%.

From the results obtained, it was possible to highlight cancer and deaths from external causes as the most important assumptions on mortality of women at childbearing age in the city of Goiania - GO.

Keywords: Women; age; mortality.

OP-253

A PICTURE OF EJGP

Mladenka Keglević¹, Ilyas Erken², Dilek Güldal³

¹Crotia

²Sinop

³Dokuz Eylul University Medical School Family Medicine Dept İzmir Turkey

INTRODUCTION

Physicians are willing to publish their work in prestigious journals, either because they want to climb career paths or they want to enlighten other people by sharing what they found. On the other hand academic career The implementation of research findings into practice has become increasingly recognised as a major priority for researchers, research funders and policymakers over the past decade [1-3]. It is known that there are disparities among researchers in publishing their work. Gender, career, country are claimed as the reasons of this disparity. Although peer review system is established against this problem, there is problem within the system. For example, some of the reviewers are much more stringent than others, leading to an unfair final decision, i.e., some submissions (i.e., papers or applications) with better quality are rejected. We aimed to picture the EJGP articles before and after indexing in SCI.

METHOD

Since EJGP indexed in SCI at 2009, we examined the journal between 2005-2014. All articles are investigated according to the first author's country, type of the article, topic and research method, authors affiliation with WONCA or journal reviewers and editors. All data before 2009 compared with after 2009. SPSS 15 is used for data analysis.

RESULTS

370 articles were examined in ten years. 39.7% was before SCI. 25.2% was from Netherlands, 13.3% UK, 6.0% Ireland, 5.4% Belgium, 5.4% Germany. The rest 44.7% was from 35 countries. 26 countries out of 40 were European countries. 47.8% of authors were affiliated with WONCA and related networks. 19.2 % of the articles had an author who was a practicing GP. 23.5% of articles had multinational authorship. The number of articles owned by the authors who have WONCA affiliation did not increase after the journal was indexed in SCI ($p>0.05$).

CONCLUSION

There are some problems on the distribution of the articles that are published in EJGP.

Keywords: EJGP, publication, bias

OP-254

Use of antidepressants and age: a comparatively high risk of suicide attempts but not of suicide among the young

Hugo M Smeets¹, Fabian Termorshuizen¹, Marco P Boks², Eibert R Heerdink³

¹Julius Center for Health Sciences and Primary Care, University Medical Center Utrecht, Utrecht, The Netherlands

²Rudolf Magnus Institute for Neuroscience, Department of Psychiatry, University Medical Center Utrecht, Utrecht, The Netherlands

³Division of Pharmacoepidemiology & Clinical Pharmacology, Utrecht Institute of Pharmaceutical Sciences, Utrecht, The Netherlands

Objectives Since 2003, the United States Drug and Food Agency (FDA) issued a number of advisory warnings regarding a possible causal link between antidepressants (ADs), often prescribed by general practitioners and suicide behaviour, especially among young persons. We investigated the rates of (fatal) suicide attempts associated with ADs at different ages.

Methods By linking insurance claims registered in the Achmea Health Database and the death register of Statistics Netherlands (2001-2011), rates of (fatal) suicide attempts were estimated during episodes of AD use and intermittent episodes of no use over a broad age range.

Results For 232,561 patients with at least one AD prescription after >1 year of no use, 590 suicides and 2,939 suicide attempts were registered. During episodes of use compared to episodes of no use, the rates of suicide (8.5 vs. 3.1/10,000 pyrs.) and suicide attempts (68.8 vs. 28.1/10,000 pyrs.) were significantly higher. For suicide attempts, the Rate Ratio (RR) during AD use compared to no use decreased from 3.62 among those aged <24 years to 1.86 among those aged >60 years (P for interaction *age x episode*<0.001). A similar age dependency was observed when restricting use of ADs to SSRIs or to the later years (>5 years) after the first registered AD. For suicide, no statistically significant age dependency of the HR was established (P=0.9063).

Conclusions Episodes of AD are indicative of high suicide behaviour risk, especially at young age. At young age, use of ADs may be less effective for prevention of suicide behaviour, which necessitates intense clinical monitoring.

Keywords: Antidepressants, Suicides and suicide attempts, Prescription policy

OP-255

Current and future use of point of care test (POCT) in the U.S. primary care physicians

Augustine Jungmoon Sohn, John Hickner, Fasika Alem

Department of Family Medicine, College of Medicine, University of Illinois at Chicago, Chicago, IL, U.S.A.

Background and AIM: Point of Care Test (POCT) has been used in the United States for several decades for diagnosing and monitoring acute and chronic conditions. Recently there has been an increased interest in POCT because of technological advances. There have also been suggestions that POCT could improve disease outcomes for certain chronic diseases. The aim of this study is to study the use of POCT and perceived benefits and concerns of POCT among U.S. primary care physicians.

METHOD: 405 U.S. primary care physicians were electronically surveyed about their use of POCT for diagnosing and monitoring illnesses and for reducing referrals for specialty care and hospital admissions. We asked about frequency of as well as benefits and concerns of using POCTs.

RESULTS: The top 10 conditions physicians reported using for diagnosis are diabetes, UTI, strep throat, influenza, pregnancy, anemia, infectious mononucleosis, anti-coagulation, acute cardiac condition and lipid disorders. The 10 most frequently used POCTs are: urine leukocytes or nitrite, urine pregnancy test, throat swab for Group A streptococci, fecal occult blood, blood glucose, nose/throat swab for influenza, hemoglobin, INR, HbA1c and white blood cell count. More than half of U.S. primary care physicians use or would use more than 15 kinds of POCTs at least weekly. The perceived benefits of POCT are immediately available result and physician and patient

satisfaction. Perceived concerns are accuracy of the tests and cost.

CONCLUSIONS: POCTs are commonly used by U.S. primary care physicians. Physicians believe POCT can improve quality of patient care with immediate diagnosis and monitoring and by decreasing referral for specialty care and hospital admission. With the technical improvement and decreased cost of POCT, they could be the game changer for improving primary care practice in the U.S.

Keywords: point of care test (POCT), primary care physician, United States

OP-256

The study of evaluation of patients' perception towards physicians with Heybet-Physician Related Health Care Perception Scale

Meryem Heybet¹, Oğuz Tekin², Rabia Kahveci¹, Adem Özkara³

¹Department of Family Medicine, Ankara Numune Trainin and Research Hospital, Ankara, Turkey

²Department of Family Medicine, Ankara Trainin and Research Hospital, Ankara, Turkey

³Department of Family Medicine, Hitit University Medical Faculty, Çorum, Turkey

BACKGROUND: In recent years the increase of violence against physicians has become a very important problem which is threatenning the peace of community. The purpose of this study is to evaluate the perception of patients to physicians and to determine the sociological and medical reasons which are forming the background of perception, with using the “Heybet – Physicians Related Health Care Perception Scale”.

METHODS: Our study was carried out with “Heybet – Physicians Related Health Care Perception Scale” in Ankara Numune Training and Research Hospital, Sıhhiye Local Polyclinic Family Medicine and Akyurt Polyclinic Family Medicine. 284 non-medical staff in the range of 18-65 years were included who accepted to participate the study. We measured sentences by 5 fold Likert scale. We analyzed data by factor and reliability methods in SPSS 13.00.

RESULTS: The effect of education on being knowledgeable about the medicine as a job factor was significant. Thoughts about violence against physicians have been found to be higher in rural areas. The patient – doctor relation factor is affected by thoughts about violence against physicians, comply to rules of hospital, trust and respect factors. This result was found to be statistically significant ($P<0,001$).

Thoughts about violence against physicians is affected by being knowledgeable about the medicine as a job, comply to rules of hospital, trust and respect factors. This result was found to be statistically significant ($P<0,001$).

CONCLUSIONS: It is observed that improving the skills of communication between the patient and physician, increasing the knowledge about medicine as a job reduce the thoughts about violence against physicians. Also improving the physical conditions of the healthcare institutions and the increased perception of trust in physicians decrease the thoughts about violence against physicians. To this end, policies should be produced and the community should be educated in communication.

Keywords: Phsyician persepction of patients, violence against physicians, patient-doctor relation

OP-257

Interprofessional cancer care: Who should get access to the personal electronic health record? An explorative study

Dominik Johannes Ose¹, Martina Kamradt¹, Eva Winkler², Joachim Szecsenyi¹, Ines Baudendistel¹

¹University Hospital Heidelberg, Department of General Practice and Health Services Research; Heidelberg, Germany

²National Center for Tumor disease (NCT), Ethics and Patient-Oriented Care; Heidelberg, Germany

BACKGROUND: A patient-controlled “personal electronic health record” (PEPA) is under development within our project. As a subset of PHRs, the web-based PEPA would enable patients to access, maintain and manage (including access management) a secure copy of their PHI integrated from various HCPs’ primary systems. Within the PEPA concept, patients are understood as active partners who manage their PHI across settings as one prerequisite for a more active role in their health care. The aim of our study was to explore perspectives of patients and HCP’s in terms of access management to a web-based PEPA.

METHODS: Overall 10 semi-structured focus groups were performed collecting views of 3 prospective user groups: patients with colorectal cancer (n=12) and representatives from patient support groups (n=2), physicians (n=17), and non-medical HCPs (n=16). Data were audiotaped, transcribed verbatim and thematically analysed.

RESULTS: Patients overall like to share their personal health information with others. Give general record access especially to GPs or in case of an emergency were discussed issues. Share their patient-controlled record with family members like spouses or trusted persons was central to patients, e.g. in instable phases of chronic illness or in case of an emergency. However, the opportunity to withdraw access was wished. Physicians from different health care settings wished to have full access to all information included in order to make appropriate treatment decisions.

DISCUSSION: Patients are willing to share their personal health information with HCPs and others like family members. Managing the access to a PEPA and its data gives patients the chance to take on an active part in their health care. A PEPA could facilitate information exchange among health care process participants and could enhance continuity of care. Giving access to family members could become relevant for instable situations in chronic conditions or in case of an emergency.

Keywords: patient empowerment, personal health record, patient-centred information technologie,

OP-258

evaluation of community empowerment program through competition among four non communicable disease early detection activities in east jakarta, indonesia

Dewi Friska¹, Aria Kekalih²

¹family medicine division, community medicine department, universitas indonesia

²epidemiology and biostatistic division, community medicine department, universitas indonesia

Background

Community Medicine Department Faculty of Medicine, Universitas Indonesia managed family medicine clinic which held community empowerment program named Family and Community-based of Diabetes Managed Care Program. One of the activities is Early Detection for Non Communicable Disease called Posbindu. This program starts from October 2012 regularly every month in 4 subdistricts areas (Kayu Putih, Cipinang, Rawamangun, Pisangan Timur) located in East Jakarta Indonesia. Since this Posbindu activities mainly run by the cadres and supervised by the staffs of Kayu Putih Family Medicine Clinic for a year, evaluation by having competition for better activities is needed

Aim

To evaluate Posbindu activity conducted by the community using competition method and to explore how the cadre appreciate this method

Method

The evaluation was done in September – November 2013 in Kayu Putih, Cipinang, Rawamangun, Pisangan Timur subdistricts. The evaluation criteria consist of the number of cadres attendance, number of people participated in early detection activities, concordance between activities and standard of procedure, reporting and administration also innovation idea for continuity of activity. The score was given by the clinic staffs for three months in a row. Besides that, the score comes from the education games. We conducted focus group discussion and interview cadres to explore their perspective and appreciation related to this competition

Results

The highest scores were in innovation idea for continuity of Posbindu meanwhile the lowest score were in number of people participated in early detection activities criteria which indicated things needed for further improvement. Cadres admitted that they are very enthusiastic about this appreciation, evaluation and competition program, especially for the feedback they received for further improvement and continuity of the activity.

Conclusion

Evaluation and competition for community empowerment program is needed as appreciation for the activities and making future plan for better improvement and continuity of the program

Keywords: appreciation, evaluation, community empowerment program, early detection, non communicable disease

OP-259

A Qualitative Study on Factors Influencing The Retention Rate of Methadone Maintenance Therapy (MMT) Among Clients In Tampin Malaysia

Faezah Hassan¹, Adibah Hanim Ismail¹, Irmis Zarina Ismail¹, Siew Mooi Ching¹, Norsiah Ali²

¹Department of Family Medicine, Faculty of Medicine and Health Sciences, Universiti Putra Malaysia (UPM) Serdang, Selangor Malaysia

²Tampin Health Clinic, Tampin District, Negeri Sembilan, Malaysia

BACKGROUND:

In 2005, Malaysia had adopted harm reduction approaches in the fight against HIV. Methadone Maintenance Therapy (MMT) is one of its measures which was first started in Tampin Health Clinic in November 2006. This clinic has been recognized by the World Health Organization as Asian model of best practice and Malaysian' best training centre for harm reduction.

One of the major challenges faced by all MMT centres is to retain illicit drug dependency clients in the program. Unfortunately, local literature on why clients remain in MMT is minimal despite it had been shown that MMT is beneficial.

Aim

To explore the factors that contribute to high retention rate in clients undergoing MMT in Tampin district.

METHODS:

Prospective qualitative study using focus group discussions (FGDs) and semi-structured in-depth interviews (IDIs). All sessions were audio-recorded digitally, transcribed in full and analyzed to look for emerging themes. Eighty four clients on MMT in Tampin District during the study period participated in this study.

RESULTS:

Few main categories of factors were identified. This includes personal, organizational, methadone impact and other factors. For personal factors, the clients described their awareness, spirituality, perceived changes in life, and fear had influence them to stay. The venue of MMT, staff' skill and attitude, numbers of clients, efficient system and other programs offered by the centre were mentioned as the organizational factors. The positive

effect of methadone on clients such as improved self confidence, appearance, physical, mental, family relationship, socio-economic status and acceptance by community also play a role. Low cost, easy accessibility and good support are among other factors mentioned.

CONCLUSION:

This study revealed several factors that influence the retention rate of MMT among the clients in Tampin which can be used to aid other Malaysian MMT centres to improve their clients' retention rate.

Keywords: methadone, retention rate, factors, Malaysia

OP-260

Do Primary Care Physicians Use Biopsychosocial Approach During Patient Interviews

Gökhan Şen¹, Tolga Günvar², Dilek Güldal²

¹Yenipazar Family Health Center, 5th Family Health Unit, Yenipazar, Aydin, Turkey

²Department of Family Medicine, Dokuz Eylul University Faculty of Medicine, Izmir, Turkey

OBJECTIVE: Biopsychosocial (BPS) model argues that the state of individual's health is in an interaction with the complex composition of the biological, psychological and social processes. Although, this model is the basic point of view of the family physicians, there is no sufficient data regarding with its reflection to daily clinical practice. One of the major reasons for this is the lack of enough, clear and objective criteria which are widely known and used to measure BPS performance of physicians. The aim of this study is to determine BPS performances of family physicians

METHOD: 40 Family physicians working in primary health care in Izmir participated in the study. Each participant made two consultations consecutively with two simulated patients who previously trained on two scenarios. Audiovisual recordings of these consultations were evaluated by three researchers by using a scale developed by Margalit and colleagues. The participants also evaluated their own performances with the same scale.

RESULTS: 80 patient-physician interviews were evaluated. While the physician participated in the study evaluated their own performance as biopsychosocial; the researchers evaluated the same performance as biomedical ($p < 0.05$). Participants showed mostly a paternalistic approach. There were no differences between two scenarios in terms of participants' and researchers' assessments of biopsychosocial performance. Consultations with longer total durations are more likely to be patient centered ($p < 0.05$).

CONCLUSION: The primary care physicians do not adopt a biopsychosocial approach in their practices. The reason for this may be the lack of education. To increase awareness on this issue; the processing of the issue satisfactorily in the medical school curriculum and, researches and studies on this topic in the future will shed light to physicians' perspective.

Keywords: The biopsychosocial approach, the patient-centered clinical method, the family physician.

OP-261

Determination of Olfactory Level in Eskişehir

Burcu Kökoku¹, Cemal Cingi², Uğur Bilge¹, İlhami Ünlüoğlu¹

¹Department of Family Medicine, Eskişehir Osmangazi University Medical Faculty, Eskişehir, Turkey

²Department of Otorhinolaryngology, Eskişehir Osmangazi University Medical Faculty, Eskişehir, Turkey

BACKGROUND: In our country population-based studies for olfactory dysfunction are lacking. The aim of this study is to evaluate the prevalence of subjective olfactory dysfunction and its risk factors in Eskişehir general population.

Design: Prospective descriptive study

METHODS: The Sniffin' Stick odor test was applied to 478 volunteers who were selected from among the patients and the relatives admitted health centers for any reason in Eskişehir.

RESULTS: We found that the mean the odor identification (OI) scores was 8.23 ± 2.37 in Eskişehir. There was no significant differences between males and females; and smoking status (smoking and not-smoking) according to odor identification scores ($p < 0.05$). Steroid usage also affected odor identification scores negatively. Accurate detection percentage was %85.1 for No:5 pen; and it was "banana". Accurate detection percentage was %82.6 for No:12 pen; and it was "fish". Although the garlic is a spice; and it is often used in society, knowing ratio for the garlic was found too low. Accurate detection percentage for the garlic was detected as %7,1. This situation may be considered as the odor contained in the pen and the odor of garlic which is well known in Turkish society was not similar enough.

CONCLUSIONS: In older subjects, odor values decreased. Steroid usage also makes the odor identification scores to be decreased. Related to this finding, topical nasal steroids should be used when indicated absolutely. Perhaps, there is the need of revision for the garlic odor in the test Battery applied to Turkish People.

Keywords: "Sniffin' Sticks", odor, people, topical nasal steroid usage

OP-262

Rural practice and chronic morbidity, problems encountered and solutions. EURIPA investigation study

Jean Baptiste Kern¹, Donata Kurpas², Aymeric Henriot¹, Candan Kendir³, Dominik Marciniak⁴, Jane Randall Smith⁵, Jean Pierre Jacquet¹

¹Department of general practice, Joseph Fourier University, Grenoble, France

²Family Medicine Department Wroclaw Medical University, Poland

³Dokuz Eylul University Faculty of Medicine, Department of Family Medicine Izmir, Turkey

⁴Department of Pharmaceutical Technology, Faculty of Pharmacy, Wroclaw Medical University, Poland

⁵EURIPA, Powys, Wales, UK

OBJECTIVES The purpose of these survey was to find out problems encountered by European practitioners in rural and remote areas within their primary practice connected with care for chronic morbidity patients. Also, our purpose was to collect their opinions, and solutions already implemented or suggestions.

METHODOLOGY We did perform qualitative descriptive study with prospective data collection from 2nd February to 20th March 2015 by a web questionnaire (based on bibliographic data), with additive results coming from a workshop in April 2015 WONCA Rural meeting. The survey population consists of European rural general practitioners (GP) approached by EURIPA "chronic morbidity" working group.

RESULTS We collected 163 answers from 25 nationalities; the age of respondents was: 27-76 years old (med 47.5). The study group consisted of: 47% female respondents (IC95 39-54) and 53% male (IC95 45-60). The average age of women was approximately 45 years and men approximately 51. Pathologies most frequently encountered were diabetes 82% (IC95 76-87), cardiovascular diseases 81% (IC95 74-86) and rheumatism 71% (IC95 64-78). Main issues reported as problems were: –Patients and family non-compliance, issue of education, and reiterative consultations for unfounded claims. –Diseases and polyopathy owing to problems of screening, a high

prevalence, and the association of several pathologies with dependence and disability. –Practitioners and care pathway with mainly a lack of time for GPs, and a sensation of poor recognition of the practitioner involvement. – Health system and organization because of bureaucracy, poverty / problem of costs and the access to rehabilitation programs. –Practical difficulties linked with polymedication, stock shortages and problems of distance.

CONCLUSION To improve the practice of the European GPs in rural areas about chronic morbidities patients, practitioners must be aware of the difficulties about these main issues. It will allow to build a position paper that will be presented to health authorities and professionals.

Keywords: Chronic Morbidity Problems Suggestions Rural Practitioners

OP-263

"Radiological requests in primary care, use or abuse?"

Juana Jimenez Martinez¹, Ana Cristina Menéndez López², Lázaro De Castro Peral³, Fátima Ghandour Fabre¹, Encarnación Madrid Sánchez¹

¹Torre Pacheco EAST Health Center (VIII AREA, Murciano Health Service)

²San Javier Health Center (VIII Area, Murciano Health Service)

³San Pedro Health Center (VIII Area, Murciano Health Service)

Introduction

Although scans that use ionizing radiation a health risk, demand continues to rise. Being the most used simple radiography, representing approximately 89% of irradiation received

Objectives

1. Study radiological outcome determines whether a change in the therapeutic attitude.
2. Radiological analysis of the percentage of requests that meet the recommended indications.
3. Knowing what type of requests for plain radiography are the most frequent in our basic health area.
4. Knowing if a factor is that the medical examination applicant is the owner or a substitute.

Material and Methods

- Design descriptive, transversal, observational.
 - Subjects: over 14 years, six doctors quotas our district health.
 - Data Sources: History-OMI-AP, Selene software, referral sheet.
- Simple random sampling. Sample size 203 patients (IC 95%, 5% accuracy, 50% expected prevalence)

Exclusion criteria: not reside regularly 6 months prior to testing.

Inclusion criteria: Be over 14 years, having been indicated radiological examination during 2014.

- Qualitative variables: gender (male / female), center of origin (header / peripheral), reason for request (diagnostic / control), type of radiological examination requested (radiography, ultrasound, CT, MRI, mammography), urgent / routine, anatomic location (head, chest, extremities, spine), change in the therapeutic approach, requesting physician (holder / substitute) indicated.

Quantitative variable: age.

Data analysis: bivariate analysis, Chi square test (qualitative) and Student's t test and ANOVA (quantitative).

- Limitations: incomplete clinical history.

Conclusions

Requests for plain films are the most frequent (89.7%), chest and spine.

The therapeutic attitude changes in 29% of cases, 67% of requests being indicated.

83% of requests are made for diagnostic purposes.

46% to over 50 years, 20-30% unnecessary requests.

Doctors working in central header make more requests (40%).

Keywords: Radiology, Primary Care, Irradiation

OP-264

Do gifts from patients affect the doctor–patient relationship?

Ayca Karatas¹, Adem Özkara², Irfan Şencan¹, Ismail Kasım¹, Rabia Kahveci¹

¹Department of Family Physician, Ankara Numune Research and Teaching Hospital

²Department of Family Physician, Hitit University Çorum, Faculty of Medicine

BACKGROUND&AIM:

Some patients want to show their pleasure by giving gifts to their physicians and some of them want to provide privileges on doctor – patient relationship. The subject of receiving gifts is still controversial and there is not a certain rule. The aim of our study is to determine the attitudes of physicians about receiving gifts from patients and its impact on doctor–patient relationship.

METHOD:

We conducted a pilot study in a research and teaching hospital in Ankara. A 16 item semistructured questionnaire was administered to 60 physicians from surgical and internal departments. The essential topic was doctors' opinions about gifts coming from patients and their impact on doctor-patient relationship.

RESULTS:

60,3% of participants are female and 39,7% male. Giving gifts could affect the pre-treatment decision opion rate was 51,7%. They denied accepting gifts with monetary value. 66,6% of academicians and 36,5% of resident doctors expressed that they could accept reasonable gifts. 37,5% of specialists expressed that they could accept gifts for not to upset their patients. 11% of academicians, 25% of specialists, 12% of resident doctors expressed that they would never accept any gifts come from patients. 33% of academicians; 75% of specialists; 51,2% resident doctors expressed that their pre-treatment decisions colud be affected by the gifts.

CONCLUSION:

Yes, Gifts can affect doctors' opinions about patients and have impact on doctor–patient relationship. Most specialist and academician physicians feel receiving gifts are influential on decision making in patient encounter.

Keywords: Receiving gifts, doctor–patient relationship

OP-265

Reflection Of Malpractice And Recessive Medical Applications To Today's Doctors

Gokhan Demirkiran¹, Dua Sümeyra Demirkıran², Erhan Yengil¹, Pınar Döner¹, Cahit Özer¹

¹family medicine, Mustafa Kemal University, Hatay, Turkey

²forensic medicine, Mustafa Kemal University, Hatay, Turkey

INTRODUCTION:

In Retrospective studies, It is understood that medical malpractice lawsuits were gradually increased in our country. There is no specific law that establishes the legal responsibilities of physicians in the our Punishment and indemnity national law when problems occurs due to physician's malpractice.

Although, America and Some European Countries laws contains malpractice in national law and applies them, It is emphasized that the biggest problem is defensive medicine in this coutries in scientific articles.

Defensive medicine can be defined as shortly“ using diagnostic and therapeutic medical applications unnecessary and avoidance of high risk application which result as malpractice lawsuits to avoid the doctor's litigation and not to pay compensation.”

This study was conducted due to the lack of studies about medical malpractice and recessive medicine in our country. We aimed to investigate the impact of malpractice on physician and how it is reflected with recessive medicine.

METHODS

Questionnaire study is planned, the most common method used in this field, to investigate the recessive medical practice of physicians

Sociodemographic questionnaire form which include age, gender, professional year and branches, was prepared questions which mentioned in the literature and used in the former studies, prepared in the form of questionnaire and applied to physicians to measure and evaluate defensive medicine practices of Specialists and general practitioners.

Family physicians work in Antakya and Serinyol family centers and all physicians working in Mustafa Kemal University hospital were selected for the study. Physicians was planned to be reached between January-May 2015. Ethical approval was taken from the Mustafa Kemal University hospital.

Data will be evaluated using the SPSS program

RESULTS AND CONCLUSION

The assessment will be made with the Questionnaire results.

Keywords: Malpractice, Recessive medicine, primary care

OP-266

From advance euthanasia directive to euthanasia; a consistent wish?

Eva Elizabeth Bolt, Roeline Pasma, Dorly Deeg, Bregje Onwuteaka Philipsen

Department of Public and Occupational Health, VUmc Expertise Center for Palliative Care, VU University Medical Center

Background.

The most common advance directive in the Netherlands is the advance euthanasia directive (AED), in which people describe the situation in which they would want euthanasia. It can be questioned whether these AEDs remain valid over years because people might change their minds on euthanasia when they become ill and approach death. This study aims to 1) describe whether people with an AED are consistent in their preference for euthanasia, and 2) what factors influence whether people with a preference for euthanasia request for euthanasia.

Method.

Retrospective cross-sectional study of deceased members of two cohort studies: the Longitudinal Aging Study Amsterdam (LASA), representative for the Dutch older population (6% having an AED) and the Advance Directive Cohort (ADC) consisting of people with an advance directive (82% also having an AED). Their proxies received a questionnaire after death of the cohort members (LASA n=167; ADC n=159).

Results.

Of the 159 older people with an AED almost all discussed their wishes with their family physician at the time of writing. At three months before death, 85% remained consistent in their wish for euthanasia and 3% changed their mind; 42% requested their physician for euthanasia (compared to 5% of people without an AED); 15% died after euthanasia. In multiple regression analysis, being aware of the approaching death, having worries at the end of life and cause of death (frailty) were associated with a preference growing into a euthanasia request.

Conclusions.

People with an AED are consistent in their preference for euthanasia. This finding demonstrates the validity of AEDs as representation of the patient's preference. However, less than half of people with an AED request for euthanasia. Apparently, other factors influence whether a preference for euthanasia becomes relevant.

Keywords: euthanasia, advance directives, advance care planning

OP-267

Appropriate care in the last phase of life; an explorative study among patients and relatives

Eva Elizabeth Bolt, Roeline Pasman, Dick Willems, Bregje Onwuteaka Philipsen

Department of Public and Occupational Health, VUmc Expertise Center for Palliative Care, VU University Medical Center

Objective

Many people are in need of care in the last phase of life. However, the care they receive is not always appropriate. For instance, people can receive overly aggressive treatment or can have limited access to palliative care. The term appropriate care is often used by policy makers, but it is unclear what care recipients consider appropriate care. This study aims to identify what care is perceived as appropriate and as inappropriate in the last phase of life, for different conditions, from the perspective of patients and relatives.

Methods

An online survey with open questions. Participants were recruited through organizations for patients, older people and medical professionals. Answers were analysed after data-driven coding. Forty-five patients and 547 relatives described the care they received and described why this care was appropriate or inappropriate.

Results

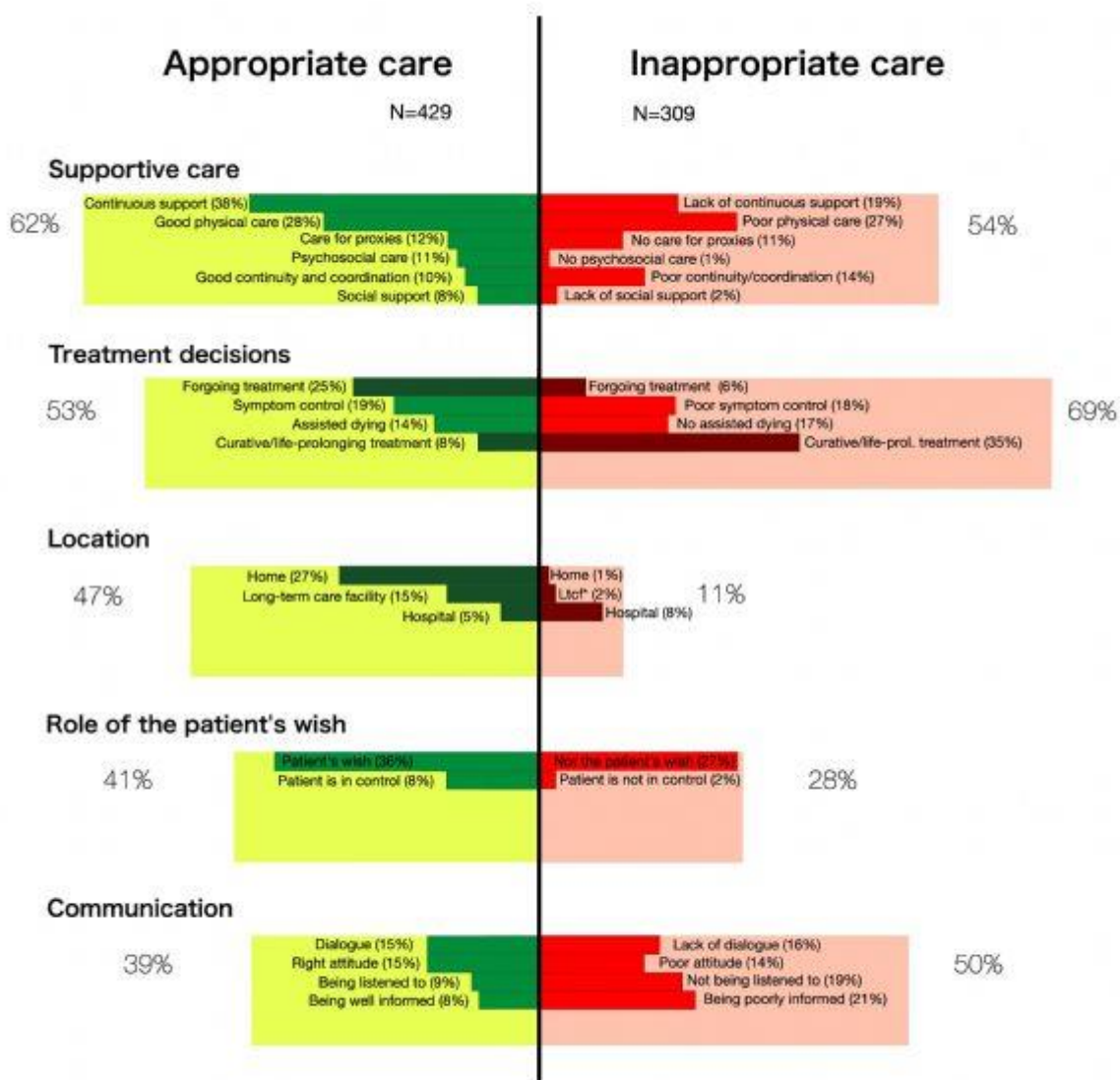
Respondents described more cases of appropriate care than inappropriate care. The cases of appropriate care were diverse, but all involved care in (one or more of) five dimensions; supportive care, treatment decisions, location, the role of the patient's wish and communication. Each of these dimensions was frequently described (39-62%). When care was inappropriate, this mostly involved inappropriate treatment decisions (69%; especially overtreatment was frequently described), and poor communication (50%; shortcomings concerning all aspects of patient-physician communication were described). There was considerable consistency in what was seen as appropriate and inappropriate care across different conditions. However, especially patients suffering from other physical diseases than cancer more often received inappropriate care.

Conclusion

From the perspective of patients and relatives, appropriate care in the last phase of life involves not only appropriate treatment decisions, but is seen as a much broader concept. By repeatedly checking whether the needs in all identified dimensions are met, inappropriate care can be prevented. Family physicians can play a key role in this.

Keywords: End of life care, appropriate care, patient perspective

Categories of appropriate (green) and inappropriate (red) care, categorized into five main dimensions



On the left, the frequencies in which the dimensions and categories were described in cases of appropriate care are shown (n=429). On the right, the frequencies in cases of inappropriate care are shown (n=309), directly next to the opposing category in appropriate care. If the category was identified both in appropriate and inappropriate care, the bar is dark. *Ltcf: long-term care facility.

OP-268

The experience of metastatic cancer: perceptions of the patients and the primary caregivers in a Middle Eastern community

Grace Abi Rizk, Remi Daou, Lara Bou Abdo

Department of family medicine, Saint Joseph university, Beirut, Lebanon

INTRODUCTION: Palliative care focuses on relief of suffering and improvement of the quality of life in patients with progressive life-threatening illness. In order to implement palliative care and promote the quality of end of life care, it is crucial to understand what quality of care means to the patients and their families. This study describes what patients with metastatic cancer and their caregivers consider to be the key elements of quality end-of-life care.

MATERIALS-METHODS: A descriptive cross-sectional study was conducted from July 2012 through April 2013, on metastatic cancer patients and their caregivers. Two questionnaires were administered to the participants in two major Lebanese university hospitals to assess their perspectives on the importance of each aspect of care. The questionnaire items were categorized in five domains (medical and nursing care, communication and decision-making, social relationships and support, meaningful existence, advance planning of care).

RESULTS: Seventy-one percent of patients and 85% of caregivers agreed to participate. The elements rated as "extremely important" most frequently by the patients and the caregivers were "to receive health care that is respectful and compassionate" (97.4% and 99% respectively) and "to have trust and confidence in the doctors looking after the patient" (93% versus 98% respectively). Significant differences in ratings of importance between patient groups and between patients and their caregivers were found for many elements of care.

CONCLUSION: In order to improve end-of-life care in Lebanon and to decrease "therapeutic obstinacy", palliative care units providing customized approaches must be implemented.

Keywords: Cancer, Caregiver, End-of-life, Importance, Palliative care, Patient

OP-269

The Partnership for Health Equity; A model for progress in tackling health inequities

Patrick O'Donnell¹, Anne MacFarlane¹, Suzanne Barror³, Fiona O'Reilly², Austin O'Carroll²

¹University of Limerick Graduate Entry Medical School

²North Dublin City General Practice Training Scheme

³Partnership for Health Equity

Background and AIMS:

This presentation will describe the Partnership for Health Equity (PHE); a unique collaboration between a university graduate entry medical school, a general practice (GP) training scheme and the Health Services Executive (the Irish National Health Service provider). The mission of the PHE is to address inequity in primary care with a programme of research, education, service provision and to inform health policy development.

METHODS:

We will explain the vision of the PHE and the programme of work to date. This includes (i) the development of several GP services for marginalised groups (ii) the conduct of research to explore access to and utilization of primary care by marginalised groups and in areas of deprivation (iii) the creation of an undergraduate and postgraduate teaching modules on social medicine, disability and cross-cultural working (iv) the creation of a forum to share findings and knowledge directly with policy makers so as to influence health policy in Ireland.

RESULTS:

Health inequity is recognised internationally as one of the main causes of multi-morbidity and premature mortality. This innovative partnership seeks to bridge the gaps between research, clinical practice, health policy and medical education when addressing health inequities.

CONCLUSIONS:

There are often significant differences between service providers, policy makers, researchers and educators in health. This can result in research taking place in isolation where findings are not translated into practice, also many problems identified in clinical practice are not researched and both educators and policy makers feel removed from the research and clinical work. This project has worked successfully to try and remedy these problems using a partnership approach. The PHE model could be replicated in other settings.

Keywords: partnership, health inequity, marginalised

OP-270

Experiences of suicide bereavement: a qualitative study exploring the General Practitioner's role

Mairead Nic An Fhaili, Nicola Flynn, Stephanie Dowling

Department of Research, South East General Practice Training Programme, University Hospital Waterford, Ireland

BACKGROUND: Suicide is a growing phenomenon of global concern. GPs are often on the front-line in responding to a suicide. They are called upon to support individuals and families in the aftermath of suicide yet there is a dearth of research, particularly from patients' perspectives, on how to provide optimal care for those grieving a suicide.

AIM: This study set out to improve GP management of suicide bereavement by exploring the lived experiences of individuals following loss by suicide, focusing on the GP's involvement in the grief process.

METHOD: A qualitative approach was adopted using focus group interviews. Suicide bereavement support groups were identified through a national suicide prevention charity. The groups were contacted by letter. Interested participants formed 3 focus groups in 3 different locations in Ireland to reflect urban and rural views. A total of 15 adults participated. Interviews were audio recorded, transcribed and analysed thematically using the framework method. Counsellors were provided after each focus group session for participants who required support.

RESULTS: The main themes emerging from the analysis were: need for acknowledgment – of the loss, and of the lived life of the deceased; the role of stigma in the aftermath of the loss – practical implications for the patient and the surgery; and the need for the proactive provision of direction and support during the grief journey. Participants felt the GP was ideally positioned in the community to cater for the needs of the bereaved and they highlighted the positive effects of compassionate listening by the GP.

CONCLUSION: Loss by suicide can result in prolonged, complex grieving generating specific patient needs. Stigma may function as a barrier to help seeking. Therefore the GP should consider initiating contact with the bereaved. Recommendations have been made to support GPs in the management of suicide bereavement.

Keywords: Suicide, Bereavement, General Practitioner

OP-271

Effects on Blood Pressure Control in Hypertensive Patients By Sending Daily SMS

Ferhat Ekinçi, Bilge Turgut, Mehmet Akman, Arzu Uzuner

Department of Family Medicine, Marmara University, Istanbul, Turkey

BACKGROUND: According to the World Health Organization non-compliance in long term medical treatments such as hypertension, diabetes and dyslipidemia causes serious problems on patients health and general economic benefits. The average compliance ratio for using antihypertensive medications is 64%. The aim of this study is to raise compliance for medical treatment in hypertensive patients by sending daily `sms`.

METHOD: This is a randomized controlled study. Participants were selected among patients of Marmara University department of family medicine outpatient clinics and randomized into sms and non-sms groups. In each group there were 30 patients after drop outs. While everyday an sms has been send to the patients in the sms group for two months, there was no intervention for the control group except routine care. One week ambulatory blood pressure measurements have been requested twice of all the patients to make evaluation and comparison at the first and the last visit. Medicine compliance was scaled by using Modified Morrisky Questionnaire.

RESULTS: A total of sixty patients who fulfilled the inclusion criteria were enrolled in the study: 45 were female, 15 male; mean age was 55+11; mean BMI was 30+5; mean number of tablets per day was 4+2.

In intervention group, average of Systolic Blood Pressure (SBP) was 149+7mmHg, Diastolic Blood Pressure (DBP) was 87+8mmHg at the first visit; and SBP 135+10mmHg, DBP 78+8mmHg after intervention. There was statistically significant difference between the first and the last visit measurements for SBP and DBP for the intervention group ($p=0,51$ for SBP, $p=0,57$ for DBP). No statistically significant difference has been determined in the control group. In intervention group one week ambulatory BP measurements averages differed between the first visit and the last visit (SBP 145+8mmHg/DBP 82+6mmHg; SBP 131+7mmHg/DBP 73+7mmHg; $p < 0,001$). Medicine compliance ratio was 36,7% for the control group, 96,7% for the intervention group.

CONCLUSION: Reminding taking antihypertensive treatment with daily sms is an effective method to control blood pressure and and to raise compliance.

Keywords: Compliance, antihypertensive, sms, blood pressure, hypertension

OP-272

Violence towards Physicians

Huseyin Avni Sahin, Zuhâl Çakmak, Gulnihâl Guvendi, Dilek Kusaslan Avcı
Yuzuncu Yil University, Family Medicine Department, Van

BACKGROUND: The aim of the study was to determine the prevalence of violence towards physicians from patients, relatives or any other person including verbal or behavioral threat, physical or sexual assault which constitutes a serious risk in health institutions.

METHODS: This study was conducted on physicians working in Van city. A 24-item questionnaire was used by researchers, including physicians' socio-demographic characteristics and data regarding violence. Data was evaluated by using IBM SPSS Version 22.

RESULTS: Of the 220 physicians 87 (39.5%) were female and 133 (60.5%) were male, 51 (23.2%) were general practitioners, 99 (45%) were research assistants and 70 (31.8%) were specialists. Out of 220 physicians 79.5% were exposed to one or more of violence types when they were on duty and 63.2 % stated that they were exposed to violence within the last year. Of the 175 physicians, 55 (31.4%) were report the violence case. Verbal violence was found to be most common types of violence with a 92.0% while physical violence was 32.6%. Male (81.9%) doctors, single (85.5%) doctors, general practitioners (92.1%) and physicians who were working in polyclinic (54.3%) are facing more violence and harrasment than the others.

CONCLUSIONS: Violence is a growing health concern and is not a well-known issue among physicians. According to our study results, physicians were subject to high rate of violence. In order to decrease the violence rates more care should be given to investigate the cases at workplaces and further studies should be accomplished.

Key words: Physicians, Violence, Turkey

OP-273

Mobbing towards Physicians

Huseyin Avni Sahin, Gulnihâl Guvendi, Zuhâl Çakmak, Dilek Kusaslan Avcı
Yuzuncu Yil University, Family Medicine Department, Van

BACKGROUND: Mobbing can be defined as a form of psychological harassment and terror arising from one or more person's unethical behaviour and leading to victimisation of the worker. Mobbing is a major occupational stressor and the leading problem of workers. The aim of the study was to determine the prevalence and types of mobbing towards physicians.

METHODS: This study was conducted on physicians working in Van city. A 33-item questionnaire was used by researchers, including physicians' socio-demographic characteristics and mobbing scale. Data was evaluated by using IBM SPSS Version 22.

RESULTS: Of the 209 doctors 80 (38.3%) were women and 129 (61.7%) were men. Fifty one (24.4%) were general practitioners, 88 (42.1%) were research assistants and 70 (33.5%) were specialists. Satisfaction rates of the physicians were 4.3% very satisfied, 25.8% satisfied and 69% unsatisfied. 93.3 % of the physicians stated that they were exposed to mobbing at least more than once during the previous six month. Male (96.1%) and single (93.9%) physicians, research assistants (97.7%) and physicians who were working in the university hospital (97.8%) exposed to mobbing more than the others. According to the study frequent mobbing types were; 67.9% of the physicians were blamed regarding irresponsible issues, 65.1 % of the physicians stated that their works were secretly controlled, 60.8 % of the physicians were faced to humiliating speech in front of others, 59.8% of the physicians believe that their work was regarded as worthless and insignificant by the others.

CONCLUSIONS: Mobbing is a growing health concern and is not a well-known issue among physicians. According to our study, physicians were also subject to high rate of mobbing. Mobbing has personal, social and institutional destructive effects. In order to cope with mobbing more care should be given and further studies should be accomplished.

Key words: Mobbing, Harassment, Physicians, Turkey

OP-274

Physical violence exposure and approaches in elementary school students' in Mardin

Betül Battaloğlu Inanç¹, Sema Çifçi², Vasfiye Bayram Değer²

¹Muğla Sıtkı Koçman University, Faculty of Medicine, Family Medicine Department

²Mardin Artuklu University, Health Higher School, Mardin.

AIM: This study was performed to determine the frequency of physical violence and to be exposed the opinion, attitude and behaviors of the primary education students about the physical violence.

MATERIAL-METHOD: All of the primary education schools were included the study at Mardin Province Center. Whole fifth and eighth class of the schools were chosen randomized and questionnaire was applied to 1351 students.

RESULTS: 50.6% of girls and 49.4% are boys. The mean age was 11.9, counts of people who lives their home was 7, average child count was 3 of the students. The 13.1% of the students were expressed that their mother was beaten by their fathers. The 42.6% of the students were exposed to violence even a time of all their whole life; the 30.7% of them were still exposed to violence from time to time.

The physical violence rate of the boys are more than the girls ($p<0.01$). The violence rate applied to children reduce with their classes, that they educated in ($p<0.01$), and fathers' educational situation advanced ($p<0.01$). Children exposed to violence higher that lives in their family in which present the domestic violence ($p<0.01$). The 15.7% of the students are still carrying on fight that includes physical violence, 5.0% of them consider that the violence is a solution.

CONCLUSIONS: The rate of the violence that exposed and considering the violence is very common. For that reason, inside of the basic health service supply; child exploitation and neglect attach importance for at primary, secondary and tertiary prevention studies, official and volunteer organizations must study together multidisciplinary for solving the problem, the programs must supported with legal arrangements and take part at government policies.

Keywords: Physical violence, primary education students, Mardin, risk factors

OP-275

Frequency of the childhood trauma in midwifery students

Betül Battaloğlu Inanç

Muğla Sıtkı Koçman University, Faculty of Medicine, Family Medicine Department

Background &AIM: In all societies and in each culture, past and present, violence has played a role in shaping our sociocultural evolution in Turkey. The analysis of the frequency of childhood traumatic events in midwifery students and the compare correlation with depression and anxiety traumatic events were aimed in this study.

METHODS: Self-report instrument was designed to evaluate abuse and neglect experiences of childhood and adolescence in the University of Mardin Artuklu Health School the Midwifery students. Childhood and adolescence lives evaluated childhood trauma questionnaire (CTQ). Depression and anxiety relates evaluated with the Beck Depression Inventory and the Beck Anxiety Inventory.

RESULTS: The students mean age were 21.4 ± 1.9 , CTQ points average was 35.8 ± 9.1 , Beck depression inventory average points was 13.7 ± 10.4 , Beck Anxiety Inventory average points was $19,8 \pm 12,7$. The CTQ total points was significantly associated between depression and anxiety. ($p<0,001$).

CONCLUSIONS: A growing body of evidence suggests that the developing brain organizes in response to the pattern, intensity and nature of sensory perceptual and affective experience of events during childhood. Threat

activates the brain's stress-response neurobiology. This activation, in turn, can affect the development of the brain. Indeed, the developing brain is exquisitely sensitive to stress. These results could indicate that previously experienced emotional and physical traumas has more relationship to anxiety and depression symptoms and this pathological position which is an expected result of the trauma.

Keywords: childhood trauma, childhood Trauma Questionnaire, Beck Anxiety inventory, Beck depression inventory, midwifery students

OP-276

Fear Of Exposure To Violence In Physicians

Kamuran Bahar Sandıkcı¹, Yusuf Üstü², Mert Muhittin Sandıkcı³

¹Çubuk 5th Family Health Center, Ankara, Turkey

²Yıldırım Beyazıt University, Department of Family Medicine, Ankara, Turkey

³Department of Plastic, Reconstructive Aesthetic Surgeons, Dışkapı Yıldırım Beyazıt Research and Training Hospital, Ankara, Turkey

INTRODUCTION: Violence against health care workers is an increasingly growing problem in our country as well as all over the world. The aim of this study is to investigate the relationship between physicians' fear of exposure to physical or verbal violence between physician, patient and the healthcare system, and the effects on examination and treatment.

METHODS: This cross-sectional study was conducted on 245 specialists and 256 residents from Ataturk Training and Research Hospital, and 216 specialists and 244 residents from Dışkapı Yıldırım Bayezid Training and Research Hospital. A questionnaire including 4 Likert scales and a total of 12 questions was applied to the participants between May 15, 2013 and June 15, 2013. The answers to the questionnaire were analyzed by using SPSS 15.0 software.

RESULTS: In our study, we found that the physicians have fear of exposure to violence independent of their gender, marital status, working branches, intense working conditions, and professional experience. According to the results of the study there is a significant relationship between fear of exposure to the verbal or physical violence and experiencing a negative communication with patients and/or relatives ($p < 0.05$). The physicians stated that they finish examination of the patient primarily and move away from the patient, when they experienced fear of exposure to violence, regardless of their working branches or professional experience. The rates of confirmation of the items "I tolerate negative responses of patients towards healthcare workers due to their psychological conditions." ($p = 0.011$), "I believe I devote adequate time to the difficult patients" ($p = 0.018$), "I think, healthcare communication applied in the hospital is adequate." ($p < 0.001$), by the physicians who do not have fear of exposure to violence were statistically significant.

CONCLUSION: Physicians' fear of exposure to violence is an important problem, because it may constitute an obstacle to fulfilling the requirements of the profession and reduce the quality of healthcare services, necessary measures should be taken.

Keywords: physical violence, verbal violence, communication, questionnaire

OP-277

Etiological Evolution in Chronic Renal Failure

Betül Battaloğlu Inanç¹, Sami Hatipoğlu², Nazmiye Özlem Harmankaya Kaptanoğulları³, Nurcihan Aydemir⁴, Derya Sıkar⁵, Nurgül Önder⁶

¹Muğla Sıtkı Koçman University, Faculty of Medicine, Family Medicine Department

²Dr. Sadi Konuk Training and Research Hospital, Department of Pediatrics, İstanbul.

³Dr. Sadi Konuk Training and Research Hospital, Department of Internal Medicine, İstanbul.

⁴Nilüfer Kültür ASM. Bursa,

⁵Düzce 6 No'lu ASM. İzmit

⁶Gaziosmanpaşa ASM, İstanbul.

OBJECTIVE: This study aimed to determine demographic characteristics and etiologies chronic renal failure patients' who applied to nephrology clinic.

METHODS: 232 chronic renal failure patients' files, demographic specialities and etiologies evaluated retrospectively, who applied to nephrology clinic at Dr. Sadi Konuk Training and Research Hospital between February 2005 and August 2006.

RESULTS: Patients were 52.6% women and 47.4% of the man. Mean ages' of 61.7 ± 13.4 years. In our study, patients were 37.9% diabetes, 24.6% hypertension, 6.5% chronic glomerulonephritis. Diabetic and hypertensive patients' mean age years were significantly higher ($p < 0.01$). Diabetes and hypertension were significantly higher in women than men. Diabetes duration was significantly longer in diabetic nephropathic patients' ($p < 0.01$). Mean age values were not statistically different in hypertensive nephropathic patients' ($p > 0.05$). There were no statistical difference in gender in hypertensive nephropathic patients' ($p > 0.05$). **CONCLUSIONS:** Before reaching chronic renal failure stage, diabetes mellitus and hypertensive patients should be screen carefully. Identification of the patients' and starting aggressive treatment is a gold standard.

Keywords: Chronic Renal Failure; Diabetes; Hypertension.

OP-278

Malnutrition Screening In Home Care Elderly Patients With Mini Nutritional Assessment

Oğuzhan Tezcan, Hülya Yıkılkan, Cenk Aypak, Derya İren Akbıyık, Süleyman Görpelioğlu
Department Of Family Medicine, Dışkapı Yıldırım Beyazıt Training and Research Hospital, Ankara, Turkey

BACKGROUND & AIM: Home care elderly patients can be vulnerable to malnutrition due to their biological, psychological and social characteristics. Mini Nutritional Assessment (MNA) is an effective and easy to use tool for malnutrition screening. The objective of our study was to investigate the prevalence of malnutrition and risk factors associated with malnutrition among the home care elderly patients.

METHODS: This was a descriptive study conducted in 2015 at Dışkapı Yıldırım Beyazıt Training and Research Hospital Home Health Care Center, Ankara, Turkey. Overall, 437 home care patients aged 65 and over, were included in our study. Patients were examined at home visits, blood samples were taken and anthropometric measurements [mid-arm circumference(MAC) and calf circumference(CC)] were performed. Full Mini Nutritional Assessment(18-item MNA) and Mini Nutritional Assessment Short Form(MNA-SF)(6-item MNA) were applied to all patients.

RESULTS: The mean age of the elderly was 78.8 ± 8.5 years. Of 437 patients 67.7%(296) were females, 32.3%(141) were males. Mean BMI of elderly women and men were found to be 25.1 ± 5.3 kg/m² and 23.7 ± 3.9 kg/m², respectively. Most presented comorbid diseases among home care elderly patients were arterial hypertension(68.2%), stroke(33%), diabetes mellitus(28.6%), dementia(26.1%), coronary artery disease(23.6%), congestive heart failure(19.2%), chronic obstructive pulmonary disease (COPD)(13.7%) and hip fracture(9.2%). According to MNA-SF, 121(27.7%) of the patients were malnourished, 179(41.0%) were at risk of malnutrition and 137(31.3%) had normal nutritional status. Whereas according to full MNA, 144(33.0%) of the patients were malnourished, 183(41.9%) were at risk of malnutrition and 110(25.1%) had normal nutritional status. Of all patients 34.5% had anemia, 45.6% had hypoalbuminemia and 56.4% had serum levels of vitamin B12 lower than 125 pg/ml.

CONCLUSION: In our study we found very high prevalence of malnutrition among the home care elderly patients. Nutritional status should be periodically screened in these patients. Performing MNA as a part of routine clinical practice will contribute both to detect and prevent malnutrition.

Keywords: Mini nutritional assessment (MNA), Malnutrition, Home care, Elderly, Screening

OP-279

Determination of children's growth, development and health problems in five different kindergarten in Artvin, Turkey

Vasfiye Güven¹, Mustafa Kürşat Şahin²

¹Department of Family Medicine, Medical Faculty, Ondokuz Mayıs University, Samsun, Turkey

²Canik Community Health Center, Samsun, Turkey

Background &AIM: School health services are services provided through the school system to improve the health and well-being of children and in some cases whole families and the broader community. These services have been developed in different ways around the globe but the fundamentals are constant: the early detection, correction, prevention or amelioration of disease, disability and abuse from which school aged children can suffer. This research has been performed between 1st of December and 25th of December 2013 to investigate the health and growth status of the students studying in five kindergartens placed in Artvin. **METHOD:** Refractive errors, dental and physical examination were carried out. The body mass indexes (BMI) of the students were calculated and evaluated according to the BMI tables and graphics of CDC (Centers for Disease Control). Data were analyzed using SPSS 22.0 package program. In the analysis, frequency and percentage from descriptive criteria were used. **RESULTS:** There were 140 (52.8%) male and 125 (47.2%) female students. The most common problems were decayed teeth 39 (14.7%), refractive errors 34 (12.8%) and ear problems 18 (6.8%), 14 (5.3%) genitourinary problems. 12 (4.6%) out of these students were underweight, 40 (15.4%) were overweight and 26 (10%) were obese. **CONCLUSIONS:** If decayed tooth, which is a common problem are determined and treated in early periods, teeth losses can be prevented. In addition treatment of the refractive error problems will increase the school performance of the students. Improvement of school health services is necessary for more healthy youths.

Keywords: school health, health screening, obesity

OP-280

Investigation Of Some Herbal Extracts' Cytotoxicities

Betül Battaloğlu Inanc

Muğla Sıtkı Koçman University, Faculty of Medicine, Family Medicine Department

OBJECTIVE: Completely using vegetable oils, non-chemicals and non-alcoholic ingredients, an anti-mosquito repellent, non-irritant for skin and environment, was planned to produce. As a first step, our aim was to investigate the renal cytotoxicity of these extracts which will be used as insecticides was aimed.

METHODS: The all-natural oils obtained from the market were used in 100% concentration.

Extracts were prepared, cytotoxicity tests were performed at Istanbul University Faculty of Pharmacy, Laboratory of Toxicology. Extracts were applied to rat kidney epithelial cells to determine the cytotoxicity with MTT test (3-4,5-dimethyl-tiazolil-2,5-difeniltetrazolium bromid).

RESULTS: 0.625% concentrations of 1st, 2nd and 3rd extracts' caused cell death in 93%, 89% and 89%, respectively. Their IC₅₀ doses -inhibitory concentration causing a 50% decrease in cell proliferation- were found 0.265%, 0.256% and 0.041%, respectively.

CONCLUSION: First of all, 'If it is herbal, it is safe to use' concept must be once more questioned, and they must be very carefully handled especially if these agents will be used for the humans. Under the IC₅₀ concentrations, the extracts were safe in our study. The repelling time of the extracts produced in these values must be investigated and this periods must be clear. Further studies should be performed in order to use these extracts as new insecticid agents with low toxicity on normal cells.

Keywords: Anti-mosquito repellent, natural, human

OP-281

Drug Administration Status Of Our Patients Aged 65 Years Old And Above In Our Region

Neslihan Erkuran¹, Sebahat Gücük², Selami Kara³

¹Golyuzu primary care center, Bolu

²Abant İzzet Baysal University Department of Family Medicine, Bolu

³Bahçelievler primary care center, Bolu

BACKGROUND & AIM: We aimed to evaluate the drug administration status of our patients aged 65 years old and higher whom registered to our office.

METHOD: Our study was conducted on 410 patients aged 65 years old and higher with their informed consents whom registered to our office via family practice system, by evaluating their reports retrospectively throughout June-July 2015. Demographic characteristics, smoking status, last used medicines, drug diversity, continuously using condition of the patients and diagnosis of their reports were recorded by examination. In case of the doctor transfer in the department of family practice, when registered patients are assigned to a new doctor, some personal information of the patients may not be transferred due to lack of informational update in the current system.

RESULTS: Our study was completed with 410 patients. Gender distribution of the patients was consisted of 46,3% male and 53,7% female. Average age was 73,72±7,05. In the section of personal information, educational status belong to 93,4% of patients and smoking status belong to 94,1% of patients were not recorded on the system. 26,3% of the patients had at least one diagnosed drug report. 60,7% and 21% of the report diagnoses were consisted from hypertension and diabetes respectively.

The most frequent reason for drug administration was hypertension with a rate of 62,9%. 49% of our patients had used painkillers regularly within last year. According to regular use of medication, while 14,1% of patients had been using 4 different medications, 12,7% had been using 5 different medications.

CONCLUSIONS: When the intensity on 2nd or 3rd stage health care services are considered, we are suggesting that the drug requirements and proper drug administration status of the patients within this age group should be evaluated carefully at first step and in every interview.

Keywords: Geriatrics, drug, efficacy

OP-282

Preventive measures taken by family physicians: How much do they care about their health?

Hülya Akan¹, Levent Hekimoğlu², Nurşah Özkan³, Arzu Uzuner⁴

¹Yeditepe University, Medical Faculty, Department of Family Medicine; İstanbul

²Public Health Institution of Turkey, 12th Family Medicine Center, Bursa

³American Hospital, Family medicine, İstanbul

⁴Marmara University, Medical Faculty, Department of Family Medicine; İstanbul

AIM: It is known that medical doctors have poor self health care and disadvantage to enter health systems and also neglect to take preventive measures for themselves. The aim of this study to explore effective and appropriate utilisation of the health system, involvement in appropriate personal health screening and practice of appropriate health promoting behaviours of family physicians

METHOD: A self-questionnaire has been prepared with the consensus of researchers after relevant literature regarding evidence based preventive medicine for adults and vaccination recommendation for health care workers. By mailing about 2200 family physicians have been reached and 307 have returned back.

RESULTS: Total 172 women (56.0%) and 135 men (44.0%) included in the study. Mean age was 40.35yrs (min 24 yrs and max 64 yrs). Mean of years in profession was 15.37 yrs (min 0.25 yrs max 35 yrs). Table 1 shows the answers regarding health status and health promoting behaviours, Table 2 shows vaccination status and table 3 shows health screening and use of health system.

Conclusion

Vaccination take up rates are low regarding international recommendations especially for mumps measles rubella, pertusis and varisella. Screening for cancer and cardiovascular risks are also low except cholesterol and blood sugar screening which is surprising that none of guidelines recommend routine blood sugar screening except

having high blood pressure. An important percentage of the group describes non healthy life style regarding smoking, diet, exercise and sleeping habits. It seems that family physicians should be motivated to take preventive health measures for themselves.

Keywords: family medicine, preventive medicine, health promotion, healthy life

Health status of family physicians included in the study regarding health promoting behaviours

Parameters	Answers N(%)
General health status	
Very good/good	124 (40.4)
Middle	154 (50.2)
Very bad/bad	29 (9.4)
Sleep status	
Very good/good	124 (40.4)
Middle	16 (5.2)
Very bad/bad	167 (44.4)
Chronic disease	
Yes	88 (28.7)
No	208 (67.8)
Healthy diet	
Yes	140 (45.6)
No	167 (54.4)
Regular Egzercise	
Yes	55 (17.9)
No	252 (82.1)
Overweight	
Yes	172 (56.0)
No	135 (44.0)
Ideal waist circumference	
Yes	142 (46.3)
No	165 (53.7)
Cigarette smoking	
Yes	78 (25.4)
No	184 (59.9)
Ex smoker	45 (14.7)
Regular alcohol use	
Yes	6 (2.0)
no	301 (98.0)

Health status of family physicians included in the study regarding health promoting behaviours

Parameters	Answers N(%)
General health status	
Very good/good	124 (40.4)
Middle	154 (50.2)
Very bad/bad	29 (9.4)
Sleep status	
Very good/good	124 (40.4)
Middle	16 (5.2)
Very bad/bad	167 (44.4)

Chronic disease	88 (28.7)
Yes	208 (67.8)
No	
Healthy diet	140 (45.6)
Yes	167 (54.4)
No	
Regular Egzercise	55 (17.9)
Yes	252 (82.1)
No	
Overweight	172 (56.0)
Yes	135 (44.0)
No	
Ideal waist circumference	142 (46.3)
Yes	165 (53.7)
No	
Cigarette smoking	
Yes	78 (25.4)
No	184 (59.9)
Ex smoker	45 (14.7)
Regular alcohol use	6 (2.0)
Yes	301 (98.0)
No	

Vaccination status of family physicians included in the study

Name of Vaccine	Vaccinated N (%)	Unvaccinated N(%)
Mump Measles Rubella	34 (11.1)	273 (88.9)
Hepatitis B	193 (62.9)	114 (37.1)
Tetanoz/diphtheria (td)	167 (54.4)	140 (45.6)
Pertusis	7 (2.3)	300 (97.7)
Varisella	8 (2.6)	299 (97.4)
Influenza	116 (37.8)	191 (62.2)

Health screening status of family physicians included in the study

Screening Parameters	Answers N (%)
Colon cancer screening	24 (7.8)
Yes	85 (27.7)
No	198 (64.5)
Not needed yet because of my age (<50 yrs)	
Cervical cancer screening for women	79 (45.9)
Yes	93 (54.1)
No	
Blood pressure screening	122 (39.7)
Yes	185 (60.3)
No	

Blood glucose screening	283 (92.2)
Yes	24 (7.8)
No	
Cholesterol screening	182 (59.3)
Yes	34 (11.1)
No	91 (29.6)
Not needed yet because of my age (<50 yrs)	
Ever admitted to her/his family physician	96 (31.3)
Yes	211 (68.7)
No	
Have a personal doctor for routine controls	39 (12.7)
Yes	268 (87.3)
No	

OP-283

Pulmonary Function Test Results of Workers Who Applied to Family Medicine Outpatient Clinic for Recruitment and Periodic Health Examination

Mehmet Özen, Hakan Akdemir

Antalya Training and Research Hospital, Family Medicine Clinic, Antalya, Turkey

Recruitment and periodic examination of workers is done by workplace physicians and family physicians. Beside history and physical examination, some laboratory tests are performed considering the profession and workplace environment. Among these tests, pulmonary function test (PFT) is an essential method for showing the affected lung function. In this study it is aimed to determine the effects on PFT values of workers' various characteristics. Data was collected retrospectively from Antalya Training and Research Hospital Family Medicine Outpatient Clinic registries and analyzed by SPSS.

In study group; 88.3% of 537 workers were male. The mean age was 40.1 ± 11.8 years. According to the body mass index (BMI) of workers, 30.2% were normal, 43.6% were overweight, 24.4% were obese. Of 430 workers didn't declare any illness and 19.9% had one or more chronic diseases. 14 workers had an obstructive lung disease. 12.0% of workers were exposed to dust in workplace and 52.5% never smoked, 35.2% currently smokers and 12.3% given up smoking. Regarding PFT results of workers, there was no statistically significant difference between men and women. There were statistically significant differences in FVC and PEF values of obese workers, in FEV1 and FVC values of workers who had employed as gardener or farmer, in FEF 25-75 values of workers who exposed to dust, in FEV1, FVC and FEF 25-75 values of workers who had chronic diseases, in FEV1 and PEF values of smokers and in all PFT parameters of workers who had respiratory complaints and pathological findings. PFT results could be affected by occupation, working duration, dust exposure at in the workplace, the presence of chronic disease, BMI and smoking status. Family physicians, when necessary, should perform PFT to workers who applied for recruitment and periodic health examination. If the test results are not normal the workers should referred to specialist.

Keywords: Occupational health, recruitment examination, periodic examination, pulmonary function test

OP-284

Assessment of Frailty in Geriatric Patients in General Practice

Didem Kafadar¹, Fatma Gönül Doğan¹, Serap Bilgiç Dalkıran¹, Burak Ayça², Ertuğrul Okuyan²

¹Department of Family Medicine, Bağcılar Training and Research Hospital, Istanbul, Turkey

²Department Of Cardiology, Bağcılar Training and Research Hospital, Istanbul

Background & AIM: Frailty defines the patient in terms of exhaustion, low activity, weight loss, gait speed and grip strength. If 3 or more criteria are present the patient is frail. Presence of 1 or 2 criteria is considered prefrail stage. In elderly and in females frailty is more common. We aimed to assess frail and prefrail stages in elderly patients.

METHODS: The study was carried out among voluntary patients with cardiovascular diseases who were admitted to family medicine and cardiology outpatient clinics in 2014. The patients performed the 10 meters walking test. Hand grip dynamometer was used to measure strength. BMI was measured. Weekly exercise was questioned. Stages of frailty were determined.

RESULTS: 62 patients, 25 (40.3%) women and 37 (59.7%) men were included. The mean age was 70.4 years. 33 patients (47%) had primary education. 29% had less than primary education. 30 patients had a history of smoking. Multimorbidities; mostly hypertension and diabetes were present in 57 patients. Walking speed was slower than 0.8 meter/seconds in 18 patients. Grip strength was low in 28 patients. Frailty score was 1 or 2 in 28 patients and they were considered prefrail. 9 patients with at least 3 criteria were frail. Men having neither of the criteria were significantly more than women ($p < 0.05$). Patients in 65-70 years group ($n=32$) with neither criteria were significantly more than patients >70 years ($p < 0.05$). 72% had 4 or more medications. There were no differences between the number of medications and frailty scores.

CONCLUSION: Frailty is seen in 10-25% of elderly people. Our findings are concurrent with literature. We have defined frailty in 14% of our patient group. In patients with multimorbidities, identifying prefrail stages in daily practice may prevent the patients from going into frailty. A multidisciplinary team involving general practitioners is needed to take appropriate measures for geriatric patients who are at risk of frailty to prevent further morbidities and increase their quality of life.

Key words: Geriatric patients, frailty, multimorbidity, general practice

OP-285

University Students Attitudes and Behaviors on Rational Drug use Knowledge, in Kütahya province

Yasemin Korkut, Berna Karabıyık

Department of Family Medicine, Dumlupınar University, Kütahya, Turkey

OBJECTIVE: The aim of this study is to determine knowledge-attitude behaviors of university students about rational use of drugs.

Materials and METHODS: A total of 100 participants included to the study, who accepted the via face to face communication method, at least 18 years old; in three months period (April-May 2014). All participants questioned for their knowledge-attitude behaviors on rational use of drugs. Descriptive statistics was used in order to evaluate the collected data.

RESULTS: The mean age 20.45 and 55% female, 45% were male was ill. 40% of participants is very important unless you contact a doctor, 46% of it only uses drugs given by the doctors, they use the drug according to the prescription of 67% reported that they retain 56% of the drug in appropriate circumstances. They use drugs that retain the remaining 62% for use in disease disease finished next, said two people said that they use those around the remaining drugs. Participants suggested that they use the drug until the time that 33% of physicians indicated that drug use of any herbal drug for treatment beyond 56%.

Conclusion: It is crucial and highly necessary to increase educational programmers on rational use of drugs

Keywords: Information, Medicine, University student

OP-286

Tobacco Use Among Medical Faculty Student

Mavişe Esra Ünüvar, Betül Benas, Osman Özdemir, Siddıka Büşra Korkmaz, Güzel Dişçigil
Department of Medicine Family, Adnan Menderes University Faculty of Medicine, Aydın, Turkey

INTRODUCTION AND PURPOSE: Tobacco use is a serious public health problem in terms of mortality and morbidity. In our study, we aimed to determine the smoking habits of a group of students who wanted to work in the field of health and preferred to study at Faculty of Medicine.

METHOD: We planned our study as cross sectional, analytic survey. After we got the required legal permits, we administered a questionnaire among all the medical faculty students studying during 2014-2015 Academic Year. In the questionnaire, we directed such questions as how long they have been using tobacco, why they use it and the situation of tobacco use in their families. 869 students volunteered for the study. The information we obtained through questionnaire were evaluated statistically.

FINDINGS: 965 students were studying at ADU Faculty of Medicine. 869 of them (90,5%) agreed to take part in the study. The average of their ages were 21,39 (18–29). 248 students (28,5%) used tobacco products, 220 students (25,3%) just tried them. Among their tobacco preferences, 397 students (45,7%) smoked cigarettes and 96 students (11%) used other tobacco products. While we detected tobacco use in half of their families (50,1%), close friends of a huge group (76,6%) were also using tobacco products. The average of tobacco product trial age was found as 16.4 (4-27). The average of regular use age was 18,48 (9-24). Among their reasons, we determined that curiosity was 66,8%, homemate or roommate use was 11% and the fear of being alone among friends was 4,8%. The period of their use was 1460 days. The reasons for continuing tobacco use were determined as; curiosity was 44,1%, other reasons were 40%, homemate or roommate use was 12,9% and high pressure for use was 5,9%. The number of regular users was 145 (67,8%). 101 students were smoking their first cigarettes in the first one hour after waking up in the morning. The number of cigarettes they smoke a day was 12.5.

RESULT: Tobacco use rate among ADU Medical Faculty Students was 28.5% (248). 67.8% of these users were regular users. Friends and family members of significant number of students were also using tobacco products. The mostly stated reason for tobacco use is curiosity.

Keywords: Medical Faculty Students, Tobacco Use, Tobacco Addiction

OP-287

Knowledge Levels Of University Students About General Health Insurance

Suat Sıncan¹, Kenan Taştan², Coşkun Öztekin²

¹Yakutiye Public Health Center, Erzurum

²Atatürk University Research Hospital Division of Family Medicine, Erzurum

Objective: According to General Health Insurance application; students over the age of 25 and students have no social security in their parents, should apply to the Social Assistance and Solidarity Foundations and should be made income test. The highest level of health insurance premiums is reflected those who do not make the income test. These may be the inability to benefit from health services due to debts. In this study, we aimed to investigate situation of making income test in university students.

Method: A verbal survey applied to university students who came to a family medicine unit in Atatürk University Family Health Center between March - June 2015.

Results: In this study, 1023 university students were evaluated, 772 women (75.4%), and 251 male (24.6%). The mean age of participants were 20.7 years (range: 17-39). 66 persons of participants (6.4%) made the income test, but 957 persons of participants (93.6%) did not. While making the test 881 (92%) of participants didn't know that you need to make an income test. 17 (26%) of the 66 students who made the income test, couldn't pass the test. So they must pay health insurance premiums itself but they don't do it due to become a student. 6 (32%) of these

17 participants said they admitted to health facilities, when they are sick, with the identity of others, because of the debt.

Discussion: University students don't know, they must make an income test. Therefore, the insurance premium debts are increasing. The increase in the number of those who have the income test, will increase the number of students who fail to pay the premium

In this situation, the physician - patient relationship, which will affect in a negative way, it can increase the number of health centers with someone else's identity applications.

Keywords: General health insurance, university student, the income test

OP-288

Acute Lymphoblastic Leukemia

Efsun Akin, Tolga Gunvar

Department of Family Medicine, Dokuz Eylul University, Izmir, Turkey

Introduction and OBJECTIVE: Acute lymphoblastic leukemia (ALL), is rapidly progressive and gets worse quickly if not treated. It is the most common cancer of childhood (%80). Although there is no visible reason in most cases; being male, white race, over 70 years old, a history of chemotherapy or radiotherapy, ionized radiation, exposure to toxic substances such as benzene and pesticides, having some inherited diseases such as Down Syndrome are potential risk factors for ALL. Easy bleeding with decreasing number of platelets, fever and infections with the non-availability of mature white blood cells, anemic symptoms such as fatigue, shortness of breath, easily exhaust arises with the lack of red blood cells. It often presents with non specific symptoms similar to those of benign conditions, leading to delays in the diagnosis and initiation of appropriate treatment. Primary care physicians should have a raised index of suspicion and explore the possibility of cancer in children who have worrisome or persisting signs and symptoms. In the full blood count, the number of leukocyte may be high, low or even normal. Anemia and thrombocytopenia mostly exists. Approximate number, changes in the shape and abnormal cells can be detected in peripheral blood smear.

CASE: 7 years of boy with no known illness, applies to the family physician with the symptoms of fatigue and cough, 3 weeks ago before applying to the DEU Pediatrics General Polyclinic. Antibiotics prescribed by the doctor and advised to come again after the end of antibiotics for the iron treatment for fatigue and paleness. Because of the increasing complaints of weakness, family refers to the Pediatric Emergency service. General physical examination showed no pathology other than common paleness.

Discussion and RESULTS: Cough, fever, weakness, sore throat symptoms are known as simple upper respiratory tract infection, but the relationship between the underlying initial phase of diseases and these symptoms must not be forgotten.

Keywords: anemia

OP-289

The importance of exercise physiology for obese patients followed by acupuncture treatment

Yılmaz Sezgin

Surmene State Hospital, Family medicine, Trabzon

INTRODUCTION: Activities such as walking, swimming, cycling and tennis supplying equate oxygenation of tissues is defined as aerobic exercise. The exercise must include at least 30 minutes a day, at least five days and a total of 150 minutes per week. The exercise, made regularly reducing insulin resistance, increasing muscles glucose utilization and fat oxidation play an important role in the treatment of obesity.

METHODS: This study was a retrospective case control study. The effects of exercise for obesity patients followed by acupuncture treatment were investigated. The patients who quadrated recommendations exercise or not separated two groups as cases and controls. Acupuncture treatment was applied as ear acupuncture once a month. Patients were invited for check in 15 days periods. Regular exercise was proposed all patients. The data belong to 15th day and 30th were evaluated by paired two sample test.

RESULTS:

15th day

All of the patients complying exercised were found reducing their weight (weight means from 98.60 ± 20.28 to 95.10 ± 19.91 , $n = 10$, $p = 0.004$). 55.5 percent of the patients not complying exercised were found reducing their weight (weight means from $99,61 \pm 18.49$ to 98.39 ± 18.44 , $n=18$, $p = 0.007$).

30th day

All of the patients complying exercised were found reducing their weight (weight means from 106.17 ± 20.64 to 100.33 ± 19.98 , $n = 6$, $p = 0.001$). 38.4 percent of the patients not complying exercised were found reducing their weight (weight means from $101,38 \pm 21.21$ to 99.23 ± 21.01 , $n = 13$, $p = 0.006$).

INCONCLUSION:

Aerobic exercise for obesity patients followed by acupuncture treatment provides more significant improvement to losing weight. we suggest that aerobic exercise for the energy consumption of the organism by carbohydrate utilization and fat oxidation should be applied.

Keywords: Exercise, Obesity, Acupuncture

POSTER PRESENTATIONS

P-0001

Degree of anticoagulation control in patients with atrial fibrillation in primary health care in Galicia, Spain

Daniel Rey Aldana¹, Sergio Cinza Sanjurjo², Andrés Sotojove Bernaldo De Quiros³, Isidoro Rivera Campos⁴, Benito Limeres González⁵, María Bustillo Jurado⁶, Carlos Moral Paredes⁷, Carmen Coladas Uria⁸, Carlos Piñeiro Díaz⁹, Esperanza Rodríguez Moldes¹⁰, Maria Del Carmen Pastor Gonzalo¹¹

¹centro de salud de a estrada, pontevedra, sergas, spain

²centro de salud de porto do son, a coruña, sergas, spain

³centro de salud de caldas de reis, pontevedra, sergas, spain

⁴centro de salud virxe da peregrina, pontevedra, sergas, spain

⁵centro de salud a doblada, vigo, sergas spain

⁶centro de salud lalín, pontevedra, sergas, spain

⁷centro de salud chandrexa de queixa, ourense, sergas, spain

⁸centro de salud o páramo, lugo, sergas, spain

⁹centro de salud narón, a coruña, spain

¹⁰centro de salud os mallos, a coruña, spain

¹¹centro de salud betanzos, a coruña, spain

Objective. To find out the degree of control in patients who undergo INR monitoring at health centres in the Autonomous Region of Galicia.

Patients and methods. Cross-sectional study conducted in patients over 65 years of age, diagnosed with Nonvalvular Atrial Fibrillation, who have been receiving anticoagulant therapy for more than one year. INR values were recorded for a minimum of 6 months and a maximum of 12 months. Good control was considered to be when the time in therapeutic range (TTR) was above 65% calculated using the Rosendaal method or 60% estimated by the number of controls.

Results. 511 patients were included, 53.0% women and a mean age (SD) of 77.8±0.6 years. 41.5% of the patients presented <60% of the controls performed within therapeutic range and 42.7% showed a TTR of <65%, calculated using the Rosendaal formula. A greater number of drugs (6.8±0.4 vs 5.7±0.3, p<0.0001), a greater prevalence of kidney disease (24.3% vs 17.0%, p=0.05) and a higher Has-Bled score (3.8±0.1 vs 2.5±0.1, p<0.0001) were observed in the group of patients with poor control.

Conclusions. More than 40% of the patients receiving anticoagulant therapy do not achieve the minimum time in therapeutic range to benefit from this treatment. The variables that influence poor control are kidney disease and a high risk of cerebral haemorrhage.

Keywords: Nonvalvular atrial fibrillation, Anticoagulation, Primary health care

P-0002

More than just nodules

Jorge Hidalgo¹, Giovanna Lovatón²

¹Hospital Mútua de Terrassa

²Consorti Sanitari de Terrassa

Clinical case

A 32 year old female patient with relevant medical history of thrombocytopenia at 20 years of age without medical supervision, depression treated with antidepressants for a short period and also an acute respiratory distress episode correlating with a diffuse bilateral alveolar hemorrhage 3 years ago that went under study without final diagnosis despite multiple medical procedures such as CT scan, bone marrow and bronchoscopy biopsy.

Familiar history of multiple sclerosis.

Consults in august of 2014 for one week of bilateral metacarpophalangeal pain, the physical examination consists in painful flogotic mobile nodules in her right hand.

Four days later besides anti-inflammatory medication reconsults for persistent pain and proliferation of thoracic and left knee nodules. With the presumption of inflammatory disease a rheumatology consultation is conducted. Laboratory Findings: Blood test showed bicytopenia, with negative acute phase reactants markers. Hand x-ray is conducted without any findings. Chest x-ray showed hilar enlargement suggesting adenopathies. CT scan with bilateral mediastinic and hilar adenopathies that confirmed previous x-ray. Finally, hand nodule biopsy showed granulomatous inflammatory non necrotizing tissue, compatible with sarcoidosis.

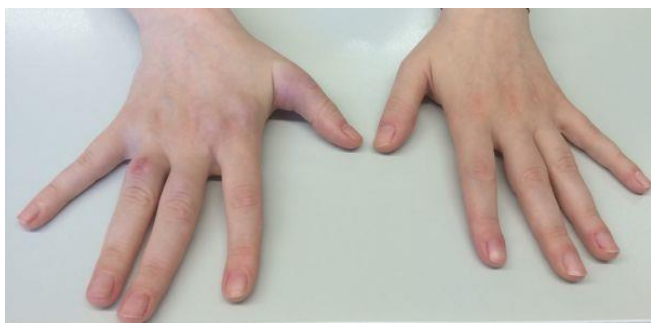
Conclusions: Sarcoidosis is a chronic idiopathic multisystem granulomatous inflammatory disease of unknown etiology its prevalence is 3-5/100000 habitants with the highest incidence at 25-40 years old.

Approximately 5% of cases are asymptomatic and incidentally detected by chest radiography. Systemic complaints of fever, anorexia and arthralgias occur in 45% of cases. Pulmonary complaints occur in 50% of cases, with symptoms like dyspnea on exertion, cough, chest pain and hemoptysis wich is rare.

The diagnosis is based on a compatible clinical and/or radiological picture, histological evidence of non caseating granulomas and exclusion of other disease of producing a similar histological or clinical manifestations.

Keywords: Sarcoidosis, nodules, granuloma

Comparing hands



First visit

First clinical signs



Hand nodules

Knee nodules



Second visit

P-0003

Type 2 Diabetes: Knowledge of the disease, impact of variables Sex, Years of Evolution and Academic Training on it

Jose Antonio PASCUAL Lopez¹, Pedro María Martínez López¹, Javier Aracil Fernández¹, Alfredo Pérez Carrillo¹, Concepción Martínez Delgado¹, María Ros Marín¹, María Dolores Vazquez García², Hebab Saas Bob Bachir¹, Francisco Javier Fernández Valero¹, Noelia Benítez Samuel¹, Juana Noelia López Pastor¹, Andres Egea Huertas¹

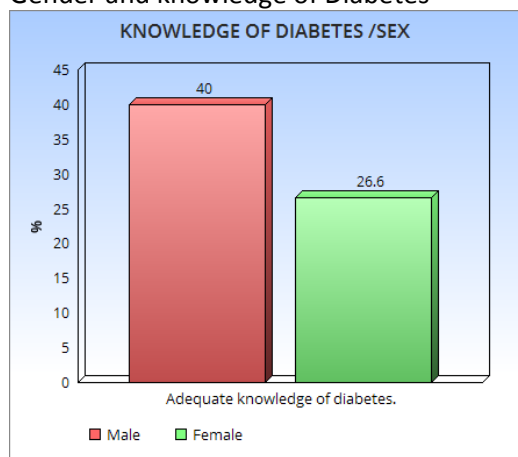
¹Centro de Salud de Calasparra. Gerencia del Noroeste. Servicio Murciano de salud. Murcia. Spain.

²Centro de Salud Barrio del Progreso. Gerencia Area VII. Servicio Murciano de Salud. Murcia. Spain.

- Objective: To determine the relevance of gender, years of evolution and level of education in diabetes control as well as knowledge of the disease in our diabetic population

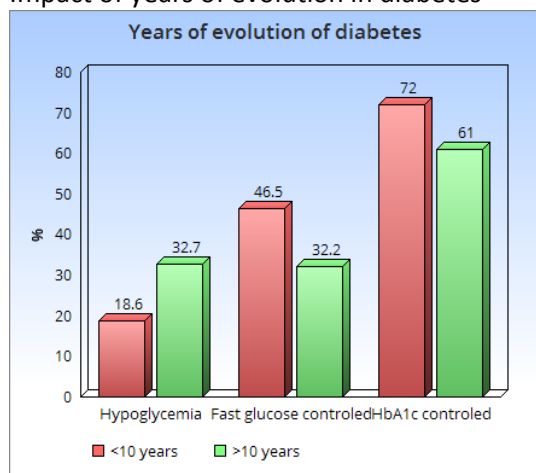
- **METHOD:** Quality assurance methodology. Rural Field. Simple random sampling. We collect biographical (sex, age, academic training and years of evolution), clinical and laboratory data, assess understanding of the disease using a validated test, adherence to treatment by Morinsky-Green test, family support and diabetes group membership. G-Stat statistical software. Chi-square.
 - **RESULTS:** Gender: homogeneous distribution of glycemic control, SBP, LDL, snuff consumption, family support and diabetes group membership. At least one hypoglycemia: 17.5% of men, 32.4% of women; three or more per year: 5% of men, 17.6% of women. Adequate knowledge of their disease: 40% of men, 26.6% of women. Years of evolution: fasting glucose controlled: 46.5% (<10 years), 32.2% (>10 years). HbA1c control: 72% (<10 years), 61% (>10 years). Existence of hypoglycemia: 18.6% (<10 years), 32.26% (>10 years). Therapeutic adherence: 69.8% (<10 years), 88.5% (>10 years). Academic training: HbA1c control: 66% (basic), 75% (secondary). SBP controlled: 56% (basic), 75% (secondary). LDL control: 41% (basic), 58% (secondary). Smoking: 14.5% (basic), 8.3% (secondary). Diabetes group membership: 3.2% (basic), 16.67% (secondary).
 - **CONCLUSIONS:** Gender is not a variable that generates many differences and according to our analysis none of them is statistically significant. In diabetics with over 10 years of evolution worsen glycemic control and the presence of hypoglycemia, but improves treatment adherence, being no statistically significant difference. Academic training (no-basic / secondary-university) shows important differences in favor of the second group in almost all aspects studied. The difference is significant in diabetes group members and probably would be others with a larger sample size
- Keywords: Type 2 Diabetes Mellitus, Sex Factors, Rural health center

Gender and knowledge of Diabetes



Gender is not a variable that generates many differences and according to our analysis none of them (even this one) is statistically significant.

Impact of years of evolution in diabetes



In diabetics with over 10 years of evolution worsen glycemic control and the presence of hypoglycemia

P-0004

Prurigo Nodularis And Autoimmune Polyglandular Syndrome (APS) Type II: A Case Report

Zeynep Polat¹, Hatice Gül Saęun², Sema Erdoęmuş¹, Zuhâl Saęlam¹

¹Department of Family Practice, İstanbul Medeniyet University Göztepe Training and Research Hospital, İstanbul, Turkey

²Department of Internal Medicine, İstanbul Medeniyet University Göztepe Training and Research Hospital, İstanbul, Turkey

BACKGROUND AND AIM

Autoimmune Polyglandular Syndrome (APS) is a combination of multiple endocrine and nonendocrine organ deficiencies with a rare incidence. 4 subtypes are defined. Type II APS is characterized by the obligatory occurrence of Addison's disease in combination with autoimmune thyroid diseases and/or with Type I DM. In primary care practice the components of APS which are thyroid disease and Type I DM are commonly observed. In this case report, a Type II APS case is presented in order to remind the management of this kind of combined disorders.

METHOD AND RESULTS (CASE)

A 75-year-old female presented to the Emergency department with fatigue, widespread itching and skin eruption. The patient had consulted to dermatology one week ago and diagnosed as scabies, topical medical treatment had been prescribed. The medical history revealed IDDM, hypotiroidism and vitiligo. The patient had hyponatremia and hyperkalemia (Na:127 and K:6.5 mEq/l). In differential diagnosis, Addison disease was considered. Basal serum cortisol was 7.6 ug/dl and ACTH was 65.7 ug/dl. Synacten test revealed serum cortisol was 14.6 and 13.6ug/dl at 30 and 60 min. respectively. Histopathologic evaluation of skin was consistent with "prurigo nodularis" which is common at autoimmune diseases. The patient was diagnosed with Addison disease and treated with 5 mg/day oral prednizolon. On the 3rd day of the treatment, the itching recovered and the patient was discharged with improving laboratory results as Na:135 mEq/l, K:5.5 mEq/l. For the time being she is under control having regular visits at Endocrinology Department.

CONCLUSIONS

In primary care practice, patients are longitudinally cared for. "Long-term following" of a patient with any chronic disease requires a comprehensive approach. We present this case to make a point of multi-endocrine disorders which we may possibly observe the symptoms independently and yet may misdiagnose in daily practice.

Keywords: APS, multi-endocrine disorder, itching, IDDM, hypothyroidism, vitiligo

Left Arm



Left Leg



P-0005

Heart Failure - Chronic Diseases and Depression in Hospitalized Patients

Ali Ramazan Benli¹, Neriman Cetin Benli², Ekrem Karakaya³, Ozkan Cesur⁴, Murat Koyuncu⁵, Hayriye Esra Ataoglu⁶

¹Department of Family Medicine, Karabuk University, Karabuk, Turkey

²Baglar Family Practice Center, Karabuk, Turkey

³Department of Cardiology, Karabuk University, Karabuk, Turkey

⁴Department of Pediatric Surgery, Karabuk University, Karabuk, Turkey

⁵Department of Emergency Medicine, Karabuk University, Karabuk, Turkey

⁶Department of Internal Medicine, Haseki Education and Research Hospital, Istanbul, Turkey

Objective: Heart failure is the most common and important disease. Diagnosis and treatment of heart failure developments in recent years. Depression is an important health problem due to effect on quality of patient life and increasing frequency of hospitalization and mortality. In this study, we examine hospitalized patient with heart failure and non-heart failure of chronic illness and their situation socio-demographic characteristics.

METHODS: We included 30 chronic heart failure of patients and 30 non-heart failure chronic diseases of patient at hospitalized in Internal Medicine Department for this study. Patients who have got psychiatric and neurological diseases is refused from this study. We used questionnaire of Beck Depression Scale of all of the patients.

RESULTS: There are depression in 22 patients with heart failure and 18 patients non-heart failure. We found no statistically significant difference between in each groups. We didn't find difference for patients aware survey or treatment disease. Limitation life moving is increased depression symptoms.

CONCLUSION: Hospitalizations are increased the incidence of chronic disease depression. Heart failure is not additional factor for depression. Physical activity of the patients will be beneficial improvement depression findings therefore physical activity of patients should have increased.

Keywords: Heart failure, Chronic diseases, Depression

Table 1. Heart Failure and Depression Frequency

		Heart Failure		p
		Yes n (%)	No n (%)	
Depression Frequency	Yes	22 (55%)	8 (40%)	0.273
	No	18 (45%)	12 (60%)	

P-0006

Who cure my diabetes? My friend and insulin

Kok Wai Kee

National Healthcare Group Polyclinics, Singapore

Chronic care management of newly diagnosed type-2 diabetes mellitus (T2DM) has always been a challenge. The importance of family or friends involvement usually overlooked. There is variable evidence on early insulin therapy in maintenance of pancreatic beta-cell function. This case report illustrated a patient in poor glycaemic control, without family support, achieved sustained good glycaemia with the help from a friend and after completed 1 year of basal insulin therapy.

NYS is a 50 year-old Chinese gentleman, a drifter, who presented with osmotic symptoms of hyperglycaemia. He has 3 siblings but not in good terms. He sleeps in public areas. He has a good friend who helps to buy food for him everyday. On diagnosis, random plasma glucose was 28.6mmol/L (514.8mg/dL) and HbA1c was 19%. He declined immediate hospital admission. He was started on oral hypoglycaemics and doses were titrated up to metformin 850mgTDS and glipizide 10mgBD. Combined care with nurses and dietician was done. Despite these, his HbA1c ranges 11.1-14.1%. Basal Insulatard was initiated with doses ranging from 8-12U ON. His friend helped in insulin

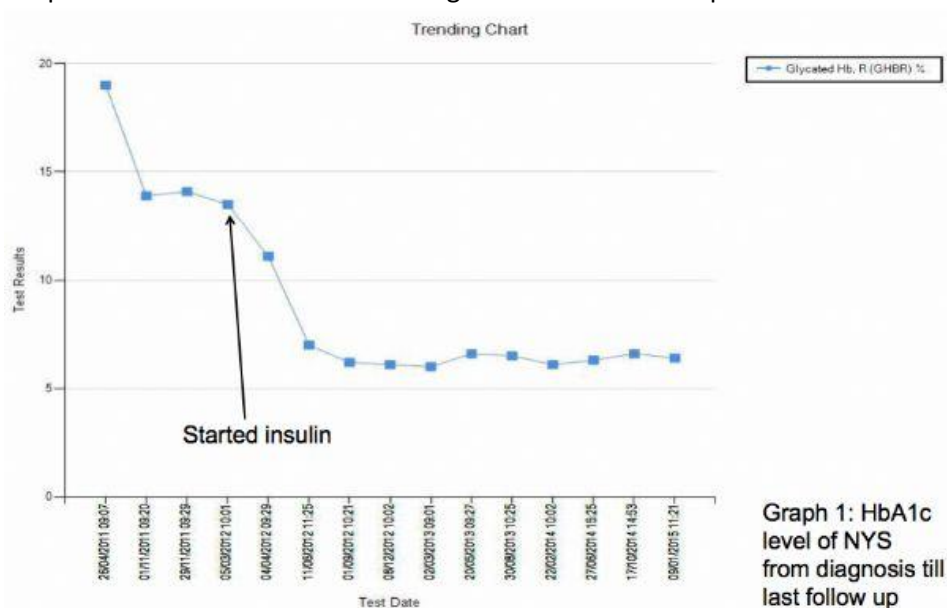
injection as patient was unable to perform himself.

A subsequent drop in HbA1c to 7% was achieved. Insulin was stopped after 1 year in view of good glycaemic control. Throughout 15 months follow-up period without insulin, his HbA1c was maintained at 6.1-6.5% with glipizide 5mg OM and metformin 500mg BD.

A combination of two hypoglycaemic agents and extensive lifestyle changes failed to achieve good glycaemic control. Basal insulin initiation with a possible reversal of pancreatic beta-cell dysfunction due to initial gluco-toxicity, managed to achieve sustainable good glycaemia. Despite poor family support, help from a close friend contributed to the major success. Further studies on early initiation of insulin for newly diagnosed diabetes with poor glycaemia, is needed to support the hypothesis of pancreatic beta-cell preservation.

Keywords: Insulin, Diabetes Mellitus, newly diagnosed, gluco-toxicity

Graph 1: HbA1c level of NYS from diagnosis till last follow up



Graph 1: HbA1c level of NYS from diagnosis till last follow up

P-0007

Frequency of Complications of Diabetes Mellitus typ 2

Albina Softic¹, Azijada Beganlic², Nurka Pranjić³

¹Public Health Center Gracanica, Gracanica, Bosnia and Herzegovina

²Public Health Scientific Institution Tuzla and Educational Family Medicine Center Tuzla, Tuzla, Bosnia and Herzegovina

³University of Tuzla Medical Faculty, Tuzla, Bosnia and Herzegovina

BACKGROUND: Diabetes mellitus type 2 is one of the leading causes of morbidity and mortality in the world. During the last decades diabetes mellitus typ 2 increasingly affects younger people, and it is a serious health's risk factor worldwide. Due to the complications of diabetes, it requires constant care for these patients.

AIM: The aim of this study was to determine the frequency of complications of type 2 diabetes mellitus among patients who were treating in Family Medicine Department, Public Health Center Gracanica.

METHOD: A retrospective cross-sectional study was conducted on patients suffering from type 2 diabetes mellitus for more than five years. The following parameters were: age, sex, duration of disease, smoking status, BMI and complications: nephropathy, retinopathy, CAD (coronary artery disease) and polyneuropathy.

RESULTS: Average age was 59.8 years. Average disease duration was 12.3 years. Of the total number of respondents females were 45% and 55% males. Smokers was 37.5%, former smokers was 25% and non-smokers was 37%. Obese subjects was 47.5%, 32.5% overweight and normal body weight subjects 20%. Nephropathy had 62.5% of respondents, retinopathy had 82.5%, CAD 45% and 72.5% polyneuropathy.

CONCLUSIONS: Complications of type 2 diabetes mellitus in patients are highly frequent. Due to the average age of the patients can be concluded that these patients will have a significantly reduced quality of life in the future and be a huge burden to the health system. Significant efforts are needed in the primary prevention of type 2 diabetes mellitus for future generations, and prevention complications in patients with new diagnosis of diabetes.

Keywords: diabetes, complications, nephropathy, polyneuropathy, retinopathy, CAD

P-0008

Impact of motivational counselling on treatment outcomes in primary health care patients with diabetes

Biljana Katic¹, Amela Vicanovic¹, Maja Racic², Bojan Joksimovic³

¹Primary health care Center Bijeljina

²Department of primary health care and public health, University of East Sarajevo

³Department of physiology and pathophysiology, University of East Sarajevo

BACKGROUND: Motivational counselling (MI) is a patient-centred counselling approach that actively engages patients and draws on their underlying readiness and motivation to change behaviour.

AIM: The purpose of this study was to determine the impact of motivational counselling on treatment outcomes in patients with diabetes.

METHODS: The study included 200 patients with diabetes mellitus registered in Primary Health Centre Bijeljina, Bosnia and Herzegovina. Before the study was conducted, the patients were allocated into two groups. The first group consisted of 100 patients who were included in three months long program of motivational counselling. The second group consisted of 100 participants who obtained patient education as a part of their regular care in family practice. The measures used to portray patient's treatment outcomes included fasting blood glucose level, HbA1c, blood pressure, cholesterol, body mass index and smoking status.

RESULTS: Statistically significant differences in fasting blood glucose level, HbA1c levels, blood pressure and serum cholesterol level were found between two groups, while statistically significant differences in body mass index and smoking status were not found between the groups at follow-up.

CONCLUSION: Diabetes as a chronic disease is complex, it demands not only the control of glycemia but the change of life habits that is often very difficult. The function of a doctor as an educator and motivator, is great and important, it demands constant learning, and the change of the doctors behavior for the better to achieve mutual satisfaction.

Keywords: diabetes mellitus, motivational counselling, primary health care

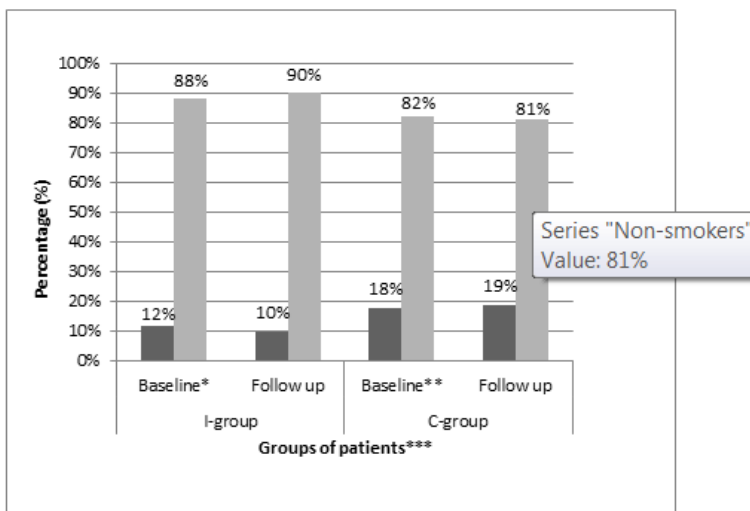
Table 1. Comparisons of blood glucose level, HbA1c and cholesterol in two examined groups of patients at baseline and at follow up.

Glycemic control	Reference values and chi-square test	Patient's health outcome				χ^2	p**
		I-group (N=100)		C-croup (N=100)			
		Baseline	At follow up	Baseline	At follow up		
Glucose blood level (mmol/l) N (%)	<6	19 (19)	25 (25)	7 (7)	8 (8)	77.765	0.001
	6.1-6.9	23 (23)	35 (35)	21 (21)	24 (24)		
	>7	58 (58)	40 (40)	72 (72)	68 (68)		
	χ^2 / p^*	6.607 / 0.037		0.381 / 0.827			
HbA1c (%) N (%)	<7	35 (35)	49 (49)	34 (34)	37 (37)	45.262	0.001
	>7	65 (65)	51 (51)	66 (66)	63 (63)		
	χ^2 / p^*	4.023 / 0.045		0.197 / 0.384			
Cholesterol (mmol/l) N (%)	<4.5	21 (21)	32 (32)	25 (25)	22 (22)	90.289	0.001
	4.6-5.9	34 (34)	40 (40)	32 (32)	29 (29)		
	≥ 6	45 (45)	28 (28)	43 (43)	49 (49)		
	χ^2 / p^*	6.728 / 0.035		0.730 / 0.694			

Table 2. Comparisons of BMI and blood pressure in two examined groups of patients at baseline and at follow up.

Body mass index and blood pressure	Reference values and chi-square test	Patient's health outcome				χ^2	p**
		I-group (N=100)		C-croup (N=100)			
		Baseline	At follow up	Baseline	At follow up		
Body mass index (kg/m ²) N (%)	<25	21 (21)	24 (24)	8 (8)	6 (6)	17.588	0.562
	26-29	47 (47)	51 (51)	55 (55)	53 (53)		
	≥ 30	32 (32)	25 (25)	37 (37)	41 (41)		
	χ^2 / p^*	1.223 / 0.543		0.528 / 0.768			
Blood pressure (mmHg) N (%)	<140/80	64 (64)	77 (77)	62 (62)	59 (59)	42.984	0.001
	>140/80	46 (46)	23 (23)	38 (38)	41 (41)		
	χ^2 / p^*	4.063 / 0.044		0.188 / 0.664			

Figure 1. Frequency of smoking in I and C-group of patients at baseline and at follow up



P-0009

Relationship between Diabetes Mellitus and Depression in Primary Care

Brenda Elizabeth Riesgo Escudero, Susana Elizabeth Riesgo, M Dolores García Moriano, Nuria Tuset Mateu, Esther Bracero Alonso, Lidia Evangelista Robledo, Antonio Carpintero Campos, Elena Pintado Outumuro, Davinia Blanco Cañas

Institute Catalán de la Salud, Barcelona, Spain

OBJECTIVE: To study the prevalence of depressive syndrome (DS) in patients with type Diabetes Mellitus2 (T2DM), to assess the associated determinants, and to determine whether the presence of DS affects the degree of metabolic control in T2DM.

MATERIAL-METHODS: Cross sectional study including 313 patients diagnosed with T2DM and registered in the eCAP database from a primary care center located in an urban area of the city of Barcelona, Spain.

VARIABLES: sociodemographic data, DS diagnosis according to DSM-IV, comorbidity (abbreviated Charlson Index), primary care consultations (doctor's or nurse's visits), laboratory parameters, self-monitoring, and adherence to treatment (AT) to oral antidiabetics (OA) based on pharmacy-prescription data.

Good adherence to treatment was considered when: Withdrawal of pharmacy $\geq 80\%$ of prescribed doses and good metabolic control: $HbA1c \leq 7\%$ AT.

RESULTS: The study included 313 diabetic patients with a mean age of 67.6 years (standard deviation [SD] = 10.6). The overall proportion of men was higher than women (53%), and the overall frequency of depressive syndrome was 26.2%.

It was observed that 64.6% of patients had a good glycemic control; 56.1% of them used self-monitoring test strips; 64.8% had a good TA; and 29.3% had a Charlson comorbidity index ≥ 3 .

With regard to visits, there were a mean of 12 visits/year to the doctor's office (P-value < 0.001), and a mean of 10 visits/year to the nurse's office (P = 0.001).

As for DS, the mean age of patients was 69.5 years with more than 10 years of evolution of T2DM. (P = 0.022); 48.1% were married; and 60.5% were uneducated.

CONCLUSION: There was a lower prevalence of DM in male patients with T2DM. Patients with DS were more likely women, attended the doctor's or nurse's office more frequently, had a longer disease progression, and were less educated.

Keywords: diabetes mellitus/depression/primary care

Table 1. Factors associated by the presence of depressive syndrome. Bivariate analysis. Rate (%) was measured sample (ED).

Depressive Syndrome	Yes (n=492)	No (n=961)	p value
Age	72,6 (11,8)	70,6 (11,9)	0,533
Men	174 (35,4%)	575 (59,8%)	<0,001
Medical attendance*	9,0 [9,00; 16,0]	7,00 [5,00; 13,0]	<0,001
Nursing attendance*	8,0 [7,00; 14,0]	8,00 [4,00; 11,0]	0,001
Years of evolution*	10,0 [6,25; 15,0]	8,00 [6,00; 11,0]	0,022
HbA1C Control	310 (33,6%)	613 (66,4%)	0,728
Insuline Therapy	109 (22,2%)	156 (16,2%)	0,006
Compliance oral antidiabetic	383 (77,8%)	805 (83,8%)	0,006
Charlson ≥ 3	111 (22,6%)	169 (17,6%)	0,021

In multivariate logistic regression analysis was only being male SD protective factor (OR: 0.15 95% CI 0.07 to 0.31) with a statistically significant association.

P-0010

I do not want amputation!

Özden Gökdemir¹, Hilal Heybeli², Iğın Yildirm Şimşir², Mehtap Kartal¹, Şevki Çetinkalp²

¹DOKUZ EYLÜL ÜNİVERSİTESİ TIP FAKÜLTESİ AİLE HEKİMLİĞİ ANA BİLİM DALI-İZMİR

²EGE ÜNİVERSİTESİ TIP FAKÜLTESİ DAHİLİYE ANA BİLİM DALI ENDOKRİNOLOJİ BÖLÜMÜ-İZMİR

The diabetic foot ulcers are the most morbid and mortal complications of diabetes. It occurs at a rate of % 25 in a life time. Having diagnosed with a chronic disease and the loss of organs due to its complications can cause psychological trauma, even an undiagnosed post-traumatic stress disorder (PTSD) that can effect success of treatment and lead life-threatening complications.

The 47-year-old woman who was diagnosed as type 2 diabetes admitted to a University Hospital with an open wound in the dorsal-lateral on left foot. She was using intensive insulin therapy and had an amputation six years ago (fingers of her right foot). She couldn't walk comfortably for the last 4 months due to development of Charcot joint. She was dependent for her daily activities. Her inversion, eversion, ankle flexion, and extension, abduction and adduction movements were limited. She was discussed at the diabetic foot council during her hospitalization at endocrine service. Tigecycline was used, however, council consisting of orthopedics, dermatology, endocrinology and infectious diseases specialists suggested abscess drainage and foot amputation. However, she refused the suggestion, became anxious and agitated when informed. Psychiatric consultation reported that she could test reality but she wasn't susceptible to any suggestion. Her probable diagnosis was PTSD. She was informed once again but refused the treatment, and discharged with medical treatment.

The family physicians should keep in mind that diabetic patients can experience also psychiatric problems such as PTSD along with serious complications like diabetic foot. Psychiatric problems can cause difficulty in management of diabetes and its complications. They have to be attentive about psychiatric issues in patients with complicated, difficult cases.

Keywords: amputation, post-traumatic stress disorder, diabetic foot

Wagner 4



P-0011

24 Hours Ambulatory Blood Pressure Monitoring in Primary Care

Laura Maldarytė¹, Kazys Simanauskas²

¹2nd year resident in GP/FM, Department of Family Medicine, Vilnius University, Vilnius, Lithuania

²GP specialist PhD MD, Vilnius University Hospital Family Medicine Centre, Lithuania

INTRODUCTION: Arterial hypertension - one of the risks of cardiovascular diseases. In Lithuania the mortality of them is 56,1% (2010ye). It is possible to minimise the diseases by detecting high arterial blood pressure and controlling it effectively changing the way of life or using antihypertensive drugs.

OBJECTIVES: To evaluate the benefit of 24 hours ambulatory arterial blood pressure monitoring, suspecting or

treating patients with arterial hypertension.

METHODS:

Study: Prospective cross-sectional study;

Population: Patients enrolled and followed in Vilnius University Hospital Family Medicine Centre, Lithuania;

Inclusion Criteria: suspected arterial hypertension or hypertension despite antihypertension treatment from June/2013 till November/2014;

Sample: Patients that met the criteria.

Type of source of data: Clinical records, arterial blood pressure monitoring results.

Statistical Analysis: SPSS 17, Microsoft Excel 2010.

RESULTS: 150 patients. Mean age 54,15 ($\pm 15,13$), 74 (49%) women. 78(52%) hypertension not diagnosed before monitoring, 28(35,9%) of them hypertension newly diagnosed.

The most often complaints - high arterial blood pressure (ABP) (33.6%), heart ache (31.5%), weakness (28.9%), no complaints (3,4%). Statistically significant correlation between complaints and treatment adjustment - only between high ABP and treatment adjustment (Spearman 0,371, $p=0.000$). The most frequent distribution of antihypertensive drugs after ambulatory blood pressure monitoring - ACF (49,3%), BBC (39,1%), CCB (31,9%). Cardiologists statistically significantly adjusted CCB, sulfonamide diuretics. Other drugs cardiologists and GPs adjusted statistically similarly. 3 (10,7%) newly diagnosed patients' AH was not treated - the change of life was recommended, 25 (89,3%) got antihypertensional treatment. For 17(68,0%) patients with newly diagnosed hypertension, the blood pressure was adjusted by GPs.

CONCLUSION: The results show that hypertension can be detected by 24 hours ambulatory arterial blood pressure monitoring. Many patients feel nonspecific signs. The hypertension adjustment between Cardiologists and GPs is similar.

Keywords: ambulatory blood pressure monitoring, arterial hypertension, antihypertensional treatment.

P-0012

A Rare Cause of Hypercalcemia: "Immobilization". A Case Report and Literature Review

Gülşah Elbüken¹, Bahadır Yazıcıoğlu², Onur Öztürk³, Mehmet Derya Demirağ⁴

¹Department of Endocrinology and Metabolism, Samsun Training and Research Hospital, Samsun, Turkey

²Department of Family Medicine, Samsun Training and Research Hospital, Samsun, Turkey

³Atakum community health center, Samsun, TURKEY

⁴Chief of Internal Medicine Department, Samsun Training and Research Hospital Chief, Samsun, TURKEY

Immobilization hypercalcemia (IH) mainly results from rapid bone turnover and may be seen after spinal cord injury or long bone fracture in particular in children and adolescents. The pathophysiology of this entity is entirely unknown. A-19 year-old, male quadriplegic adolescent was referred to our outpatient clinic by a family physician. At presentation he had some vague symptoms due to hypercalcemia including fatigue, nausea, vomiting, anorexia, constipation and dehydration. Laboratory investigations for hypercalcemia revealed low intact parathyroid hormone level, low 25-OH vitamin D, and high 24-hour urine calcium. He was diagnosed as having IH after all other causes of hypercalcemia were excluded. The pathophysiology of IH remains unclear. Treatment is directed towards lowering the serum calcium level. Up to date, intravenous hydration with isotonic saline, furosemide and salmon calcitonin have been the conventional therapies. Other treatment options include bisphosphonates (such as etidronate, zoledronate or pamidronate) or, an inhibitor of receptor activator of nuclear factor kappa-B ligand (RANKL), denosumab. IH is a rare cause of hypercalcemia. Physicians should be aware of this condition when seeing patients with restricted physical activity.

Keywords: Hypercalcemia, immobilization, quadriplegia

Biochemical parameters of the patient, before and after the treatment

Parameter	Pre-treatment	Post-treatment	Reference ranges	Unit
BUN	15	9.7	10-50	mg/dL
Creatinine	0.4	0.5	0.5-1.0	mg/dL
Calcium	13	9.7	8.6-10.2	mg/dL
Phosphate	3	3.9	3.5-4.5	mg/dL
Albumin	3.8	4	3.5-5.2	g/dL
ALP	76		<300	U/L
PTH	5.7		20-75	pg/mL
25-OHvit D	15		30-100	nmol/L
TSH	2.9		0.25-5.00	μIU/mL
ft4	1.32		0.88-1.72	ng/dL
Serum cortisol	12		7-29	μg/dL
Hb	9.6	12.0	13.2-17.2	g/dL
Hct	27.0	35.8	36-45	%
Leukocyte	6920	7400	3500-10000	/mm ³
Thrombocyte	315000	275000	148000-339000	/mm ³
MCV	84	81	85.6-100.0	fL
Ferritin	6		7-276.8	ng/mL
Vitamin B12	230		214-914	pg/mL
Folate	10		5.38-24	ng/mL
Urine calcium /24-hours	460		100-300	mg/day

BUN: Blood urea nitrogen, ALP: Alkaline phosphatase, PTH: Parathyroid hormone, Hb: Hemoglobin, 25-OHvit D: 25 hydroxy-vitamin D3, TSH: Thyroid stimulant hormone, ft4: Thyroxin, MCV: Mean corpuscular volume.

P-0013

Clinical evaluation of the risk of stroke in family medicine

Esad Alibasic¹, Enisa Ramic², Olivera Batic Mujanovic², Ahmet Tuzlak¹, Emir Alibasic³, Irma Ramic³

¹Department of Family Medicine, Primary Health Care Center Kalesija, Bosnia and Herzegovina

²Department of Family Medicine, Primary Health Care Center and Polyclinics Dr Mustafa Sehović, Tuzla, Bosnia and Herzegovina

³Medical Faculty, University of Tuzla, Bosnia and Herzegovina

INTRODUCTION: Stroke is a common a problem that has to be well evaluated and triaged in the practice of family medicine.

OBJECTIVE: To analyze the prognostic value of the ABCD2 scoring system for stroke occurrence after transient ischemic attack (TIA).

Patients and METHODS: ABCD2 scoring method includes following clinical conditions: Age, Blood pressure, Clinical Presentation, Duration, and Diabetes mellitus. The highest possible score is 7. The score is calculated as follows: years of Age > or = 60 [1 point]; Blood pressure > or = 140/90 mmHg [1]; Clinical features: one-sided weakness with or without speech disorder [2], or speech impairment without weakness [1]; the Duration of TIA > or = 60 min [2] or 10-59 min [1]; Diabetes [1 point]. The results of the clinical presentation of TIA (as defined on the basis of the criteria of the World Health Organization) were retrospectively compared with the results of the patient's discharge letters or findings of neurologists and the results of cerebrovascular imaging (CT and CD results) of the patients who had proven ischemic stroke.

RESULTS: Total of 60 patients were analyzed, of which 28 (46,6%) were women. The average age was 58. 12 (20%) patients were classified as high risk (ABCD2 score 6-7), 28 (46,6%) as moderate risk (ABCD2 score of 4-5), and 20 (33,3%) patients as low risk (ABCD2 score 0-3). The risk of stroke in following two days ranged from 1,6% in patients with a lower score, 5% in patients with moderate score and 8,3% in those with higher score.

CONCLUSION: Higher ABCD2 score is associated with a higher risk for the development of ischemic stroke during 2 days after occurrence of TIA. Patients at high risk need immediate evaluation and optimization of stroke prevention. Stroke occurrence after TIA is highly predictive by utilizing ABCD2 scoring method.

Keywords: transient ischemic attack, cerebrovascular disease, stroke

P-0014

Type 2 Diabetes Mellitus: Patient Characteristics at Initial Diagnosis

Lorraine Scanlon¹, Katie Murphy², Carthage Moran³, Colin Bradley², Joe Moran²

¹School of Medicine, University College Cork, Western road, Cork City, Ireland

²Department of General Practice, Western Gateway Building University College Cork, Western Rd. Cork City, Ireland

³Department of Medicine, University College Cork, Clinical Sciences Building, Cork University Hospital, Cork City, Ireland

Background and Aim: The incidence and prevalence Type 2 Diabetes Mellitus (T2DM) is increasing. Diabetes in General Practice (DiGP) is an educational forum for Irish General Practices aiming to improve their care of patients with T2DM. We investigated the characteristics of T2DM patients at initial diagnosis and whether patients cared for in DiGP practices had better glycaemic control (lower HbA1c) at the time of diagnosis than patients attending non-DiGP practices.

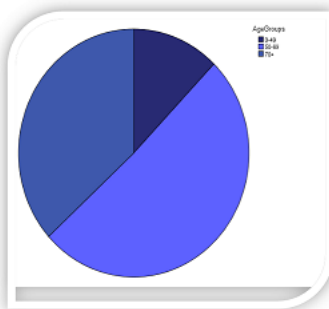
Methods: 22 General Practices from the South West of Ireland were recruited over a 6 week period, including 15 DiGP practices and 7 non-DiGP practices. A random selection of T2DM patients (N=460) were selected and their records were analysed. Demographics, smoking status, BMI (Body Mass Index) and HbA1c values at the time of initial diagnosis were recorded.

Results: Smoking status was recorded for 41% of patients, with 38% reported as current or ex-smokers and 62% reported as non-smokers. BMI was recorded in 47% of patients, with 10% of patient "underweight" or "normal" and 28% "overweight" and 63% considered "obese". There was a significant negative correlation between HbA1c at initial diagnosis and patient age ($r=-0.203$, $p=0.00$). There was a significant correlation between HbA1c at initial diagnosis and positive smoking status ($r=0.204$, $p=0.005$). There was no significant correlation between HbA1c at diagnosis and either BMI or DiGP membership.

Conclusion: HbA1c level at initial diagnosis is higher in younger adults diagnosed with T2DM. This highlights the need for increased diagnostic suspicion in this patient group. Positive smoking status is associated with higher HbA1c level at initial diagnosis, highlighting the need for increased awareness of T2DM in smokers. Membership of DiGP did not lead to earlier diagnosis of T2DM.

Keywords: General Practice, Type 2 Diabetes Mellitus, HbA1c

Figure 1.



Patient age group categories

Table 1.

Variable	All patients	Group 1 (DiGP Members)	Group 2 (Non-DiGP Members)
N	460	300	160
Age (years)			
Median	66	66	66
Mean	64.58	65.27	63.29
Range	27-92	31-90	27-92

Gender			
Male	271 (59%)	180	91
Female	189 (41%)	120	69
HbA1c (mMOL/MOL)			
Median	56	56	55
Mean	63.58	64.17	62.45
Range	36-158	36-158	40-157
Smoking Status recorded			
Total	189	157	32
Smokers	72 (38%)	59 (38%)	13 (41%)
Non-smokers	117 (62%)	98 (62%)	19 (59%)
Body Mass Index recorded			
Total	218	180	38
BMI <18.5	1 (<1%)	1 (<1%)	0 (0%)
BMI 18.5-24.9	20 (9%)	18 (10%)	2 (5%)
BMI 25-29.9	60 (28%)	49 (27%)	11 (29%)
BMI >30	137 (63%)	112 (62%)	25 (66%)

Demographic data including HbA1c, smoking status and BMI, divided into DiGP members and non-members.

P-0015

Gender differences in glycemic control among patients with diabetes mellitus

Larisa Gavran¹, Subhija Prasko¹, Olivera Batić Mujanović², Alma Alić¹, Ibrahim Gledo¹, Alen Omanović¹, Enisa Ramić², Esad Alimanović³

¹Family Medicine Teaching Centre Zenica, Primary Health Center Zenica, Bosnia and Herzegovina

²Family Medicine Teaching Centre Tuzla, Primary Health Center Tuzla, Bosnia and Herzegovina

³Primary Health Center Kalesija, Bosnia and Herzegovina

Background Many studies have shown that good glycemic control significantly reduces the risk of many complications of diabetes.

Aim of this study was to show how well our patients with diabetes mellitus approached the target values of glycemic control by gender.

Method For Four different groups of patient's members of the local Association of Citizens against diabetes in Zenica we organize one day training (from September to December 2014.) which aim was to educate them about the importance of proper nutrition as a first step in the treatment of diabetes. Before each session for all them body weight, body height, BMI, waist circumference (WC), postprandial blood glucose and HbA1c were measured. **Results** We educated 161 patients with diabetes, 59 (37%) men and 102 (63%) of women aged 10-88 years. BMI > 25 male compared to female had 42 (71%) vs. 70 (68%). WC ≥ 102 cm had 38 (34%) male and WC ≥ 88 cm had 80 (78%) female patients. Postprandial blood glucose > 10 mmol / L had 18 (32%) male patients compared to 29 (33%) female. HbA1c > 7% were 26 (44%) male patients compared to 44 (43%) female.

Conclusion This study shows a significant incidence of obesity in females and a high percentage of patients with poor glycemic control in both genders. We need more effective interventions in family medicine: advice on lifestyle changes and therapeutic treatments in order to offset the development of diabetic complications.

Keywords: education, glycemic control, gender

P-0016**Seasonal Variation in Clinical Remission of Primary Care Patients with Depression: Impact of Gender**Yusuf Cetin Doganer¹, Kurt B. Angstman², Tara K. Kaufman², James E. Rohrer²¹Department of Family Medicine, Turkish Military Academy, Primary Care Examination Center, Ankara, Turkey²Department of Family Medicine, Mayo Clinic, Rochester, Minnesota, USA

Background & AIM: The impact of seasonal variation on clinical remission in patients with depression has not been well studied. The hypothesis for this study was that the clinical remission rate would be lower in the winter comparing to the other seasons, specifically evaluated by gender.

METHOD: The study cohort comprised 2873 primary care patients with depression as a longitudinal retrospective chart review analysis. The sample was limited to patients who were continuing in care; drop outs were excluded from the analysis.

RESULTS: Multivariate logistic regression analysis of the independent variables for those participants who achieved clinical remission demonstrated that for the male patients, the season of diagnosis did not impact the rate of remission at six months while controlling for all other independent variables. For female patients, those that were diagnosed with depression in the fall had increased likelihood of six month remission compared to those patients diagnosed in the winter months (OR 1.300, CI 1.006-1.680, p=0.045) and the spring and summer patients were not significantly different in their outcome rates. When both genders were combined, the odds of remission at six months were not statistically significant for any season of diagnosis.

CONCLUSIONS: This study demonstrates that in patients who were continuing care, women who were diagnosed with major depression or dysthymia in the fall season have improved six month clinical outcome of remission compared to those women diagnosed in the winter, when controlling for demographic and clinical characteristics. This effect was not seen in men or when the genders were combined into a single cohort. The assessment of the seasonality effect on depression outcomes requires further long-term follow-up studies.

Keywords: Depression, seasonality, primary care

Table 1. Demographics and clinical features of primary care patients with depression, collectively and by six month remission status (defined as a PHQ-9 score <5).

Variables (%)	All patients (%) N=2,873	Remission (%) N=1,441	Non-Remission (%) N=1,432	p*
Age groups				<0.001
18-30 years	23.8%	20.7%	27.0%	
31-41 years	26.8%	28.8%	24.9%	
42-54 years	26.0%	25.3%	26.6%	
≥ 55 years	23.4%	25.2%	21.5%	
Marital status (Married)	54.6%	59.5%	49.7%	<0.001
Race (White)	93.6%	94.3%	92.8%	0.101
Depression severity				<0.001
Moderate	46.5%	53.1%	39.9%	
Moderately severe	35.6%	33.6%	37.6%	
Severe	17.9%	13.3%	22.5%	
Diagnosis				<0.001
First episode	50.3%	54.3%	46.3%	
Recurrent episode	40.0%	37.0%	43.1%	
Dysthymia	9.7%	8.7%	10.6%	
Treatment type (CCM)	80.7%	87.3%	74.0%	<0.001
Seasons				0.231
Spring	26.9%	26.9%	26.9%	
Summer	24.9%	24.9%	24.9%	
Fall	26.7%	28.0%	25.3%	
Winter	21.5%	20.2%	22.9%	

*Chi-square test

Abbreviations: CCM: Collaborative Care Management.

Table 2. Comparison of demographics and clinical features by gender and six month remission status (defined as a PHQ-9 score <5), for primary care patients with depression.

Variables (%)	Male (N=746)			Female (N=2,127)		
	Remission	Non-Remission	p*	Remission	Non-Remission	p*
Age groups			0.001			0.050
18-30 years	15.8	23.7		22.4	28.2	
31-41 years	28.6	23.9		28.9	25.2	
42-54 years	31.3	29.0		23.2	25.8	
≥ 55 years	24.3	23.4		25.5	20.8	
Marital status (Married)	66.0	54.6	0.001	57.3	48.0	<0.001
Race (White)	94.9	91.9	0.100	94.1	93.1	0.354
Depression severity			0.001			<0.001
Moderate	48.9	38.7		54.5	40.3	
Moderately severe	37.7	37.6		32.1	37.6	
Severe	13.4	23.7		13.3	22.1	
Diagnosis			0.048			0.001
First episode	60.2	52.2		52.2	44.2	
Recurrent episode	30.2	38.7		39.4	44.6	
Dysthymia	9.6	9.1		8.4	11.1	
Treatment type (CCM)	85.0	73.4	< 0.001	88.1	74.2	<0.001

Seasons			0.915			0.160
Spring	28.3	26.6		26.4	27.0	
Summer	25.7	25.0		24.6	24.8	
Fall	24.3	25.0		29.2	25.5	
Winter	21.7	23.4		19.7	22.7	

*: Chi-square test

Abbreviations: CCM: Collaborative Care Management.

Table 3. Multivariate logistic regression analysis for odd ratio of remission (PHQ-9<5) six months after diagnosis of depression in primary care patients, by gender differences.

Variables (%)	Male (n=746)		Female (n=2127)		All patients (n=2873)	
	OR (95% CI-Lower-Upper)	p	OR (95% CI-Lower-Upper)	p	OR (95% CI-Lower-Upper)	p
Age groups						
18-30 years	Reference		Reference		Reference	
31-41 years	1.689 (1.051-2.714)	0.030	1.346 (1.045-1.735)	0.022	1.413 (1.131-1.765)	0.002
42-54 years	1.457 (0.913-2.327)	0.115	1.135 (0.876-1.469)	0.338	1.194 (0.955-1.493)	0.120
≥ 55 years	1.441 (0.882-2.352)	0.144	1.474 (1.138-1.910)	0.003	1.440 (1.147-1.808)	0.002
Marital status (Married)	1.390 (0.998-1.935)	0.051	1.310 (1.089-1.574)	0.004	1.330 (1.134-1.560)	<0.001
Race (White)	1.523 (0.813-2.850)	0.189	1.108 (0.769-1.595)	0.582	1.205 (0.881-1.649)	0.243
Depression Severity						
Moderate	Reference		Reference		Reference	
Moderately-severe	0.743 (0.532-1.036)	0.080	0.640 (0.526-0.779)	<0.001	0.663 (0.560-0.784)	<0.001
Severe	0.420 (0.274-0.643)	<0.001	0.456 (0.355-0.586)	<0.001	0.444 (0.358-0.550)	<0.001
Diagnosis						
First episode	1.080(0.632-1.845)	0.778	1.402(1.023-1.922)	0.036	1.307(0.997-1.713)	0.053
Recurrent episode	0.661(0.377-1.158)	0.148	1.032(0.749-1.421)	0.846	0.925(0.701-1.219)	0.579
Dysthymia	Reference		Reference		Reference	
Treatment type (CCM)	2.214(1.510-3.246)	<0.001	2.576(2.030-3.270)	<0.001	2.471(2.020-3.023)	<0.001
Seasons						
Spring	1.246(0.812-1.911)	0.314	1.086(0.840-1.404)	0.530	1.118(0.898-1.393)	0.319
Summer	1.171(0.757-1.812)	0.478	1.136(0.875-1.476)	0.339	1.142(0.913-1.428)	0.244
Fall	1.028(0.663-1.594)	0.902	1.300(1.006-1.680)	0.045	1.237(0.992-1.541)	0.059
Winter	Reference		Reference		Reference	

Abbreviations: CCM: Collaborative Care Management.

P-0017

Treatment of a non-adherent patient with HIV/AIDS in a Primary Health Care setting in Brazil: a case report

Bernardo Lago Alves, Thadeu Felix Cariello, Marcele Paiva, Regina Ferreira, Rodolfo Deusdará
Department of Integral, Family and Community Medicine, State University of Rio de Janeiro, Rio de Janeiro, Brazil

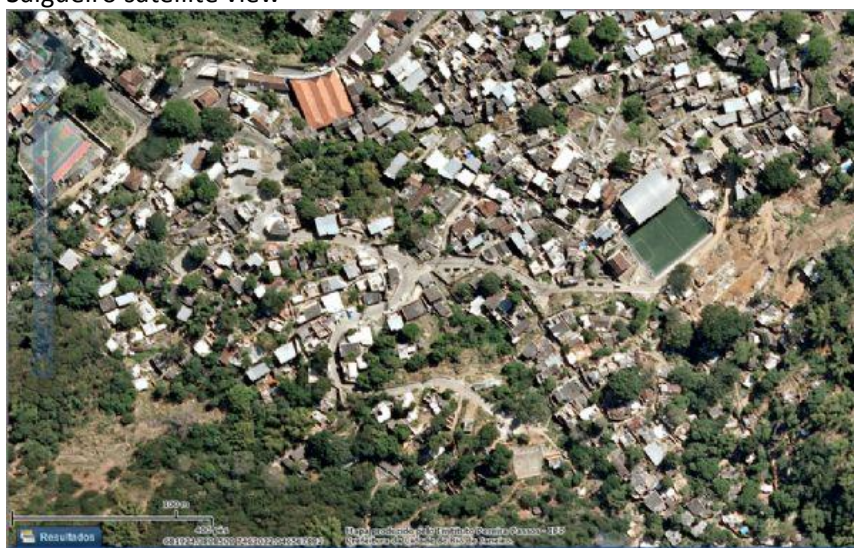
Background&AIM: HIV/AIDS treatment was, until recently, an infectologists-only field in Brazil. The ongoing improvements in the Brazilian Family Health Strategy, both in coverage and in qualification, has allowed general practitioners to start antiretroviral therapy (ART) and to conduct the care of non-complicated HIV-positive patients. Additionally, it has turned The Family Health Teams (FHT) into the prime actors for accessing and managing care of non-adherent HIV/AIDS patients. This presentation aims at describing one of such cases, the methods used and the many challenges that arised during this process.

Description&RESULTS: A 37-year-old patient complains to a community health worker of progressive weight loss and limb weakness. He refuses to go to the Family Medicine surgery, requesting a home visit by the doctor instead. During the visits, it is found that the he's HIV-positive, with multiple treatment drop-outs due to him being a former drug dealer, therefore not wishing to be seen in his current "sickly, useless" appearance by

neighbours which once feared him. The attending FHT decides to manage his case in the home setting, whenever possible, and with daily supervised administration of medication. While in the process of working out his adherence to the new ART scheme, the patient starts presenting multiple complications from opportunistic infections requiring referrals to emergency departments, where he's usually mistreated and counter-referred without adequate diagnostic investigation. After 1 year of treatment with the current FHT, he dies of pneumonia. **DISCUSSION:** The case illustrates how a patient-centered approach, flexible access and integral care (some of the cornerstones of efficient Primary Care) are vital for handling a patient with a chronic and potentially fatal disease. It also points out fragile knots in the current Brazilian public health network, especially weak integration with focal specialists, subpar emergency services and difficulties in obtaining adequate care for patients requiring hospitalization.

Keywords: HIV/AIDS in Brazil, HIV/AIDS in Primary Care, Brazilian Health System, Brazilian Family Health Strategy

Salgueiro satellite view



Salgueiro slum satellite photo - 2012. The patient's house is indicated by the yellow arrow, showing the difficulty of access to it

P-0018

Smoking cessation in patients with Chronic Obstructive Pulmonary Disease

Rosario Martinez Fuerte¹, Leticia Sierra Martinez¹, Natalia Sanz Gonzalez²

¹Valladolid Este Primary Assistance Gerency, Valladolid, Spain

²JCyL Primary Assistance Gerency, Valladolid, Spain

OBJECTIVE: Evaluating patients with COPD who take more than six months without smoking to boost the Quality of Clinical Practice Portfolio Services Primary Care community of Castile and Leon (SPAIN)

METHOD: The authors performed a descriptive cross-sectional study of patients with COPD and Smoking carrying more than six months without smoking, recorded in the medical record computer from the health center.

systematized were randomly selected 96 patients, to whom the record level of compliance was assessed in the clinical history information of healthcare activity: carry more than six months without smoking.

RESULTS: Of the 96 patients studied: 12 present record take more than six months without smoking and 84 are not registered. Representing a percentage of 12.5% of positive records.

In the population studied, the percentage of patients with smoking by age:

85-95years:4%

75-85years:9%

65-75years.14%

55-65years26%

45-55years:26%

35-45years:10.4%

25-35years:6%

15-25years:2%

Smoking among patients who take more than six months without smoking, we find the following distribution:

-85-95years:8.3%

-75-85years:8.3%

-65-75years:0%

-55-65years 41.6%

-45-55years:8.3%

-35-45years:25%

-25-35years:8.3%

CONCLUSIONS: Poor patient registry that carry more than six months without smoking. The percentage of smokers is higher in the age group between 45 and 65, which is 52%. Among smokers with registration carry more than six months without smoking, the highest percentage is found in the town ce 55 -65 years (41.6%), there is no record of having kicked the habit in children under 25 years. From these data we propose a **IMPROVEMENT PLAN IN CLINICAL PRACTICE** usual activities including primary care consultation registration classification and determination of abandonment phase in which the smoker (Pre-contemplation, contemplation or preparation is), appropriate treatment will be offered depending on the stage, and 2-up visits were conducted in smokers who have stopped smoking. This recorded in computer history.

Keywords: COPD, tobacco use, smoking cessation

P-0019

Atherogenic dyslipidemia and residual vascular risk

Esad Alibasic¹, Farid Ljuca², Olivera Batic Mujanovic³, Enisa Ramic³, Emir Alibasic⁴, Ahmet Tuzlak¹

¹Department of Family Medicine, Primary Health Care Center Kalesija, Bosnia and Herzegovina

²Department of Physiology, Faculty of Medicine, University of Tuzla, Tuzla, Bosnia and Herzegovina

³Department of Family Medicine, Primary Health Care Center and Polyclinics Dr Mustafa Sehović, Tuzla, Bosnia and Herzegovina

⁴Medical Faculty, University of Tuzla, Bosnia and Herzegovina

INTRODUCTION: Atherogenic dyslipidemia is an important factor in the development of macrovascular residual risk and is characterized by the reduced value of High-density lipoprotein (HDL) cholesterol and elevated triglycerides (TG). The residual vascular risk is an significant residual risk in development of macro and microvascular complications and is significantly associated with elevated TG and reduced HDL cholesterol.

CASE: Patient, 53 year old, suffering from type 2 diabetes, metabolic syndrome and arthritis urica, monitored by an outpatient clinic due to pathological findings in lipidogram, that were discovered during preventive laboratory testing, and showed a combined dyslipidemia: TG 4.1 mmol/L, cholesterol 7.4 mmol/L, Low density lipoproteins (LDL) 6.6 mmol/L, HDL 0.7 mmol/L. The status of the patient: abdominal-type obesity, typical xanthomatous changes visible on his eyelids. The therapy included Atorvastatin in dose of 40 mg, together with recommendation for lifestyle modification. Two months later, lab tests showed results as follows: TG 3.1 mmol/L, cholesterol 5.2 mmol/L, LDL 2.9 mmol/L, HDL 0.8 mmol/L. Then, Fenofibrate 250 mg, Rosuvastatin 20 mg and omega-3 fatty acids were included in therapy. After two months, the new lab tests were performed with following **RESULTS:** TG 1.8 mmol/L, cholesterol 4.3 mmol/L, LDL 2.5 mmol/L, HDL 1.5 mmol/L.

DISCUSSION: Numerous studies (PROCAM, PROVE IT-TIMI 22, TNT) have shown that elevated TG and decreased HDL cholesterol were independent cardiovascular risk factors, not depending on LDL cholesterol levels. Large prospective studies indicate that microvascular residual risk could be reduced using fibrates and that omega-3 fatty acids reduce macrovascular risk. Combined hypolipemic therapy resulted in a significant improvement in lipid profile in this patient.

CONCLUSION: Treatment with statins insufficiently reduces vascular risk attributed to elevated TG and reduced HDL cholesterol. Lifestyle modification, together with adding fibrates and omega-3 fatty acids to statin therapy showed improvement in the regulation of lipid parameters.

Keywords: atherogenic dyslipidemia, residual vascular risk, lifestyle modification, statins, fibrates, omega-3 fatty acids

P-0020

An Unusual Cause of Acute Chest Pain: Rib and Scapula Fracture Due to Cough

Hale ATEŞ¹, Ihsan Ateş², Bülent Bozkurt¹, Tarık Eren Yılmaz³, Adem Özkara³

¹Turgut Özal University, Department of chest disease, Ankara

²Ankara Numune Education and Research Hospital, Department of Internal Medicine, Ankara

³Ankara Numune Education and Research Hospital, Department of Family Medicine, Ankara

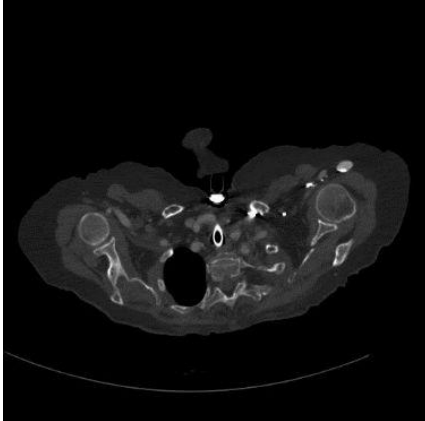
Cough is one of the most common symptoms of patients that seeking for medical help. Cough usually recovers without sequelae, but serious cough sometimes leads to complications such as pneumothorax and rib fractures. Fractures often occur after repeated mechanical stress due to chronic cough. In the literature, although chronic cough induced rib fractures are often cited, coexistence of rib and scapular fractures is mentioned rarely. In this case report, left scapula and left eighth rib fracture presenting with acute-onset chest pain presenting is going to be presented.

Keywords: Cough, Rib fractures, Scapula fractures

Figure 1-a: Rib fracture



Figure 1-b: Scapula Fracture



P-0021

Acute Renal Failure Due To Ethyleneglycol Poisoning

Ihsan ATEŞ¹, Nihal Özkayar², Nergiz Bayrakçı², Tarık Eren Yılmaz³, Fatih Dede²

¹Ankara Numune Education and Research Hospital, Department of Internal Medicine, Ankara

²Ankara Numune Education and Research Hospital, Department of Nephrology, Ankara

³Ankara Numune Education and Research Hospital, Department of Family Medicine, Ankara

Ethylene glycol (EG) poisoning can result in serious morbidity and mortality. It is used in construction of glass cleaners and antifreeze solution. EG rapidly absorbs after oral administration and peaks in the blood within 1-4 hours, its half-life is 3-5 hours.

When EG is drunk accidentally or with a suicide attempt, it is transformed into its active metabolites, and then metabolic acidosis, renal failure, hypocalcemia, oksalüri, central nervous system disorders and cardiovascular failure occur. Kidney failure is formed due to double crushing oxalate crystals, one of EG metabolites, accumulation in the distal tubule and collecting duct. We present a case with acute renal failure, metabolic acidosis, coma after drinking antifreeze accidentally.

Keywords: Acute renal failure, Ethylene glycol poisoning, Metabolic acidosis,

P-0022

Newly Diagnosed Primary Hypothyroidism Applicant With Massive Pericardial Effusion And Acute Renal Failure

Ihsan ATEŞ¹, Mustafa Kaplan¹, Nisbet Yılmaz¹, Tarık Eren Yılmaz², Adem Özkara²

¹Ankara Numune Education and Research Hospital, Department of Internal Medicine, Ankara

²Ankara Numune Education and Research Hospital, Department of Family Medicine, Ankara

Pericardial effusion (PE) seen in patients with hypothyroidism is associated with the severity of the disease. While PE is commonly seen in patients with myxedema coma and severe hypothyroidism, it is very rare condition (3-6 %) in patients with moderate hypothyroidism. Primary hypothyroidism resulting with acute renal failure is a rarely diagnosed condition. Although co-existence of ARF due to rhabdomyolysis and hypothyroidism is present in the literature, we did not encounter too many hypothyroidism cases associated with acute renal failure of unknown cause. In this case report, primary hypothyroidism case presenting with massive PE and ARF association which have not seen previously in the literature will be discussed.

Keywords: Acute renal failure, Pericardial effusion, Primary hypothyroidism

P-0023

Metabolic syndrome in type 1 diabetic patients with microalbuminuria levels

Burcu Dogan¹, Can Oner², Guneş Feyizoglu³, Nurdan Yoruk³, Aytekin Oguz⁴

¹Family Medicine Clinic, Sakarya Training and Research Hospital, Sakarya, Turkey

²Department of Family Medicine, Bilim University, Istanbul, Turkey

³Diabetes Nursing Department of Internal Medicine, Istanbul Medeniyet University Goztepe Training and Research Hospital, Istanbul, Turkey

⁴Department of Internal Medicine, Istanbul Medeniyet University Goztepe Training and Research Hospital, Istanbul, Turkey

INTRODUCTION: Metabolic syndrome is one of the main factors for development of diabetes mellitus and cardiovascular diseases. It was shown that early stage renal injury was developed in cases with metabolic syndrome. The aim of this study was to understand the role of metabolic syndrome in type 1 diabetic patients in urinary albumin excretion.

METHOD: Study was conducted between 01.02.2013-01.05.2013 from patient records of Istanbul Medeniyet

University Goztepe Training and Research Hospital Diabetes Clinic. Metabolic Syndrome was diagnosed as presence of at least 2 criteria below other than diabetes: waist circumference exceeds 94 cm in male and 80 cm in females, blood pressure above 130 mm systolic and 85 mm Hg diastolic pressure, triglycerid level exceed 150 mg/dl or hypertriglycemia treatment or HDL levels lower than 40 mg/dl for men or 50 mg/dl for women. The cohort composed of 262 type 1 diabetic patients (141 males and 121 females) attending the diabetes outpatient clinic. Mean age was 36,4±10,9 year (range: 17-74). All of the data were obtained from patients records. Data analyzed by SPSS 17.0. Comparisons between different groups were performed by unpaired t tests. Comparisons across categories were made using χ^2 . Correlations between variables of interest were performed by Pearson correlation.

RESULTS:

19,1 % (n=50) patients have metabolic syndrome. On the other hand 88,9% (n=233) patients have normal urine sample (<30 mcg mg/ creatinine), 8,7% (n=23) have microalbuminuria (30-300 mcg mg/ creatinine) and 2,4% (n=6) have albuminuria (>300 mcg mg/ creatinine). 24,1% (n=7) of patients with albuminuria have metabolic syndrome where as 18,4 % (n=43) of non-albuminuric patients have metabolic syndrome (p= 0,457).

CONCLUSION:

Our results showed that urinary albumin excretion was not elevated in type 1 diabetics with metabolic syndrome.

Keywords: Metabolic syndrome, type 1 diabetic patient, microalbuminuria

P-0024

Triglyceride/high-density lipoprotein cholesterol ratio and albuminuria in adult type 1 diabetics

Burcu Dogan¹, Can Oner², Aytakin Oguz³

¹Family Medicine Clinic, Sakarya Training and Research Hospital, Sakarya, Turkey

²Department of Family Medicine, Bilim University, Istanbul, Turkey

³Department of Internal Medicine, Istanbul Medeniyet University Goztepe Training and Research Hospital, Istanbul, Turkey

OBJECTIVES: Micro and macro vascular complications are common in diabetes. Lipid profile has also an important role in development of atherogenic vascular changes. Recent studies reveals that small LDL particles are more atherogenic than larger ones has determinative in atherogenesis. Serum triglycerides to HDL cholesterol ratio (TG/HDL) and small dense LDL negatively correlates. The aim of this study was to evaluate the effect TG/HDL on diabetic nephropathy in adult type 1 diabetics.

METHODS: Our study was carried out retrospectively in Istanbul Medeniyet University Göztepe Training and Educational Hospital between 2012-2013. The cohort composed of 248 type 1 diabetic patients (128 males and 120 females) attending the diabetes outpatient clinic. Mean age was 37,4±11,0 year (range: 17-74). LDL cholesterol, HDL cholesterol, TG levels, and urinary albumin levels were obtained from patients records. Statin user type 1 diabetics are excluded from the study. Data analyzed by SPSS 17.0. Comparisons between different groups were performed by unpaired t tests. Comparisons across categories were made using χ^2 . Correlations between variables of interest were performed by Pearson correlation.

RESULTS: There were 39 (15,7%) patients with albuminuria. Mean HDL cholesterol level was 56,62±32,54 mg/dl in normoalbuminuric patients and 51,61±12,69 mg/dl in albuminuric patients (p=0,345). On the other hand mean triglycerid levels were 106,44±86,19 mg/dl and 127,94±88,47 mg/dl in two groups respectively (p=0,156). The level of microalbuminuria and ratio was positively correlated (r=0,22; p=0,000). But the mean TG/HDL ratios of two groups do not show significant difference (2,76 vs 2,20; p=0,150).

CONCLUSION: This study showed that TG/HDL ratio do not show significant difference between albuminuria and normal albuminuria groups but the ratio positively correlated microalbuminuria levels.

Keywords: Triglyceride/high-density lipoprotein cholesterol ratio, albuminuria, type 1 diabetics

P-0025

Antidiabetic treatment in a cohort of primary care patients along 7 years

Francisca Rivera Casares, Sebastián García De León Chocano, Pilar Collar Pastor, Adela Briones Través, Silvia Pérez López, Almudena Blanes Monllor
Centro de Salud Fuensanta (Valencia)

Background

In recent years new treatments have been commercialized and therapeutic recommendations have been modified, changing the therapeutic profile of diabetics.

Aim

We intend to evaluate the changes in the treatment of a cohort of diabetic patients treated in a Health Center.

Method

We selected a representative sample of diabetics treated in 2010 and monitored over 7 years (3 years retrospectively and 4 prospectively, from 2007 to 2013) the drugs used, through the prescribing application of the electronic history.

Results

We included 316 cases with mean age of 72.6 years and 54.1% female.

The use of metformin changed from 48.4% to 65.4% of patients, sulfonylureas from 17.3% to 13.1%, glitazones from 1.6% to 2.1%, meglitinides from 13.7% to 16.9%, incretins from 1.3% to 38.4%, inhibitors of alpha-glucosidase from 8.2% to 2.5%, analogs of GLP-1 from 0% to 1.7%, NPH or mixed insuline from 19.9% to 15.6%, lente insuline from 5.9% to 19.8%, and fast insuline from 3.9% to 7.6%. No other antidiabetic drug was used. The proportion of patients without drug treatment in the cohort passed from 25.6% to 5.9%. The number of antidiabetic drugs increased from 1.2 to 1.8 per year ($p < 0.0001$). The number of drug changes performed remained almost constant at around 0.71 per year.

The use of antihypertensive drugs increased from 69.0% to 79.3%, hypolipemiant from 51.3% to 73.0%, and antiplatelet/anticoagulants from 25.7% to 33.8%.

Conclusions

With increasing age and years of evolution of diabetes, the use of insulin, metformin and incretins has increased, as the number of drugs per patient. The use of other cardiovascular risk factors has also increased.

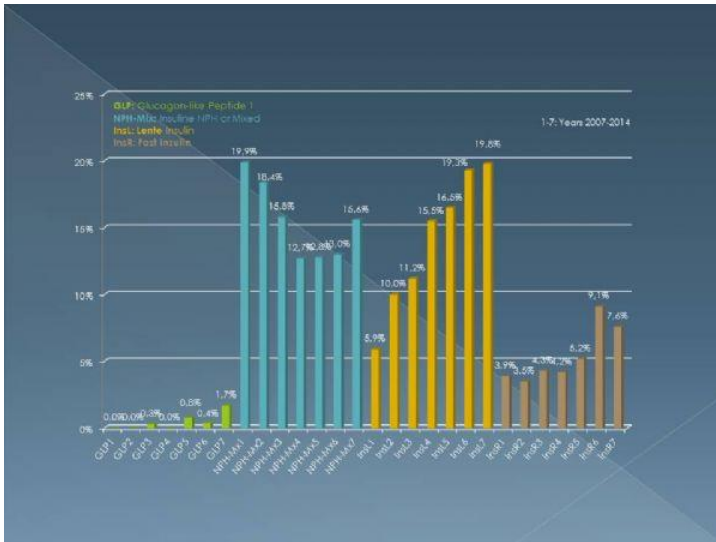
Keywords: Diabetes mellitus, Antidiabetic treatment, New antidiabetic treatment, Primary care



Use of oral antidiabetic drugs by year



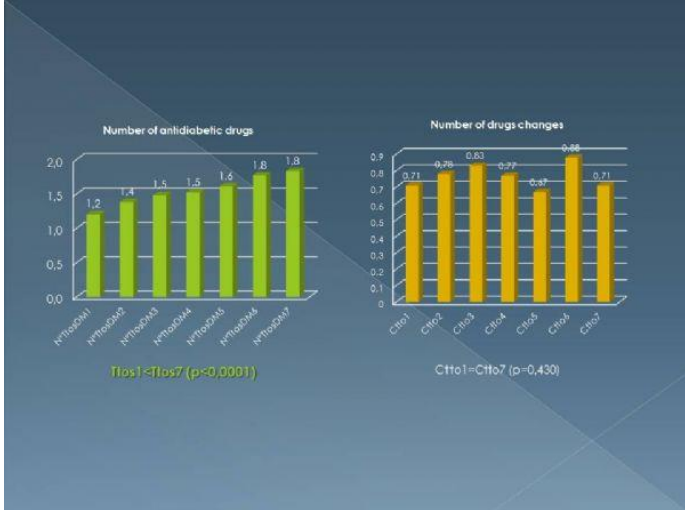
Use of parenteral drugs by year



Use of risk factor drugs by year



Number of antidiabetic drugs and number of drug changes by year



P-0026

7-year follow-up of a cohort of diabetics in a Health Center

Francisca Rivera Casares, Sebastián García De León Chocano, Pilar Collar Pastor, Adela Briones Través, Silvia Pérez López, Almudena Blanes Monllor
Centro de Salud Fuensanta (Valencia)

Background

It's challenging to reach an acceptable degree of metabolic control and cardiovascular risk factors in diabetics despite improved control processes.

Aim

To monitor long-term control processes performed in a Health Center, and results obtained.

Method

We selected a representative sample of diabetics in 2010 and tracked over 7 years (3 years retrospectively and 4 prospectively, 2007-2013) the process of care variables (consultations and tests) and results (blood pressure, LDL-cholesterol and HbA1c), development of target organ diseases and mortality.

Results

We included 316 cases with mean age of 72.6 years, 54.1% female.

The standard of one follow-up visit per year by the primary care doctor changed from 80.7% of patients up to 89.9%, 4 visits by nurse from 33.7% to 37.0%. Biannual eye fundus was performed to 37.0%. The completion of at least one annual lipid profile changed from 67.4% to 81.9%, one annual screening for renal function from 63.8% to 84.8%, and one annual HbA1c from 58.3% to 79.3%.

Patients with blood pressure below 140/80 mmHg changed from 56% to 64%, LDL-cholesterol below 100 mg/dl from 30% to 63%, and HbA1c less than 7%, from 62% to 54%.

58% of patients were smokers and an additional 7% stopped smoking. 52% were obese and an additional 15% came to be, while 16% had normal weight and an additional 14% went on to have it.

14% had ischemic heart disease at baseline and 6% was developed, 5% peripheral arterial disease and 4% developed, 8% diabetic retinopathy and 14% developed, 6% nephropathy and 21% developed. Mortality rate at 7 years was 22.8%.

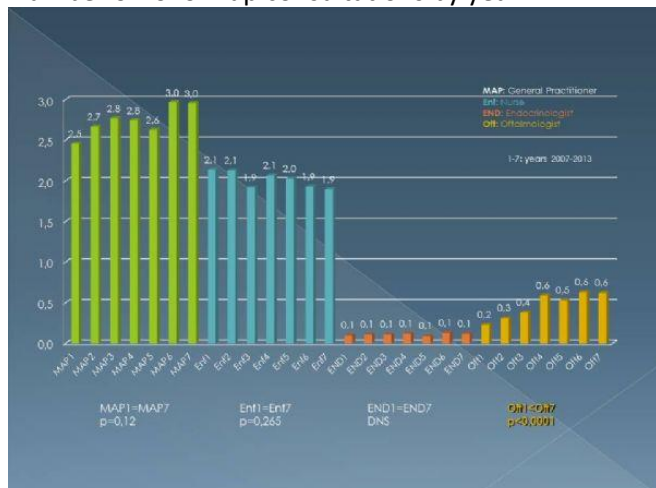
Conclusions

The improvement of control processes of diabetes continues to an improvement of control parameters except for HbA1c. It is necessary to assess the impact of process control in the degree of improvement in results, and the latter on comorbidity.

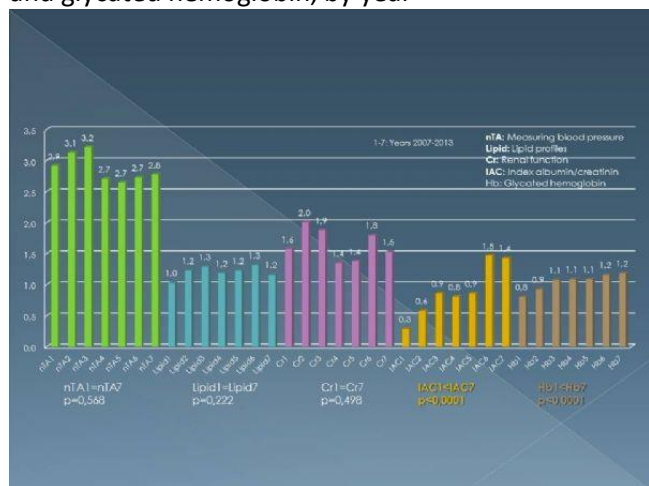
Keywords: Diabetes mellitus, Glycemic control, Primary Care, Cardiovascular risk factors



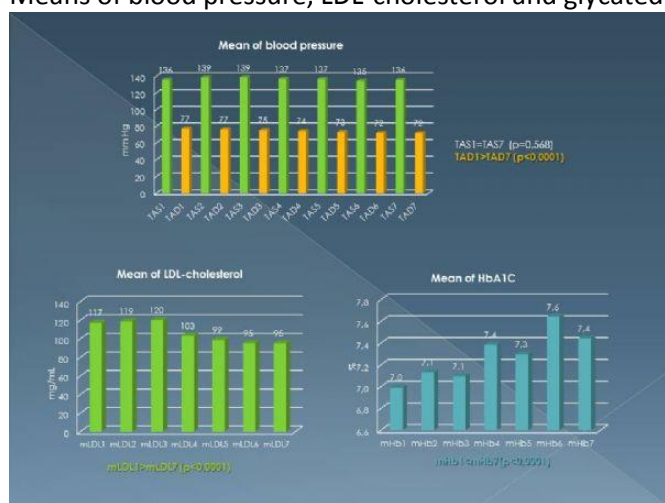
Number of follow-up consultations by year



Number of blood pressure measuring and determinations of lipid profile, renal function, Index albumin/creatinin and glycated hemoglobin, by year



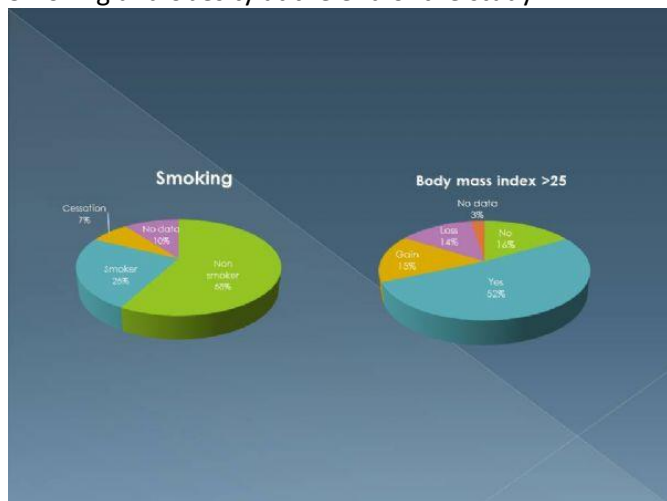
Means of blood pressure, LDL-cholesterol and glycated hemoglobin, by year



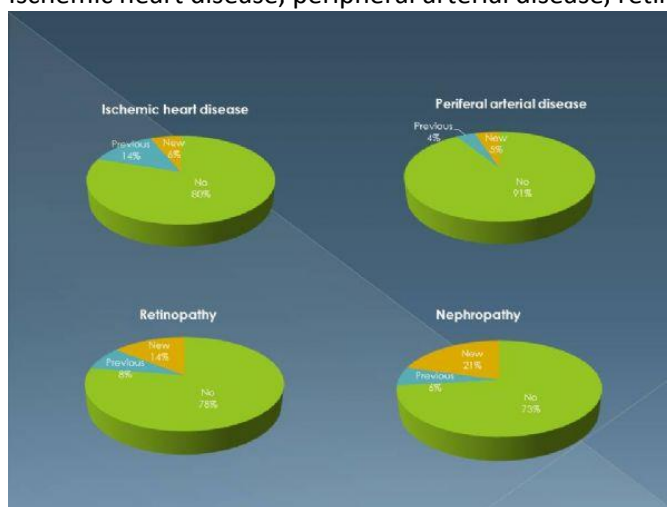
Proportion of patients with adequate blood pressure, LDL-cholesterol and glycated hemoglobin, by year



Smoking and obesity at the end of the study



Ischemic heart disease, peripheral arterial disease, retinopathy and nephropathy at the end of the study



P-0028

The Evaluation Of Metabolic Syndrome Frequency and Its Components In Newly Diagnosed Type-2 Diabetic Patients

Muhammet Oktay¹, Gulseren Oktay², Yusuf Haydar Ertekin³, Cemil Isik Sonmez⁴, Feruze Turan Sonmez⁵

¹Baglar Family Health Center, Tokat, Turkey

²Department of Family Medicine, Gaziosmanpasa University, Tokat, Turkey

³Department of Family Medicine, Canakkale Onsekiz Mart University, Canakkale, Turkey

⁴Department of Family Medicine, Duzce University, Duzce, Turkey

⁵Department of Emergency Medicine, Duzce University, Duzce, Turkey

BACKGROUND & AIM: We planned this study in order to identify the relationship between metabolic syndrome and its components and the frequency of it in untreated type- 2 DM patients and in patients with new diagnosis type 2- DM.

METHOD: In the study, 220 diabetic patients were questioned on weight, height, waist circumference, body mass index, fasting blood glucose, blood pressure, HbA1c, total cholesterol, triglycerides, LDL, HDL data, in addition to the components of metabolic syndrome in first-degree relatives.

RESULTS: In our study on new diagnosed type-2 diabetic patients, the frequency of metabolic syndrome (MS) was found 70.5%, according to National Cholesterol Education Program (NCEP), and 80% according to the International Diabetes Federation (IDF). The rates of MS by gender in women and men was 84.8% and 75.6%, respectively. Obesity was found as the most frequent MS component in all the first-degree relatives of the patients; parents, sisters, brothers and children.

CONCLUSIONS: Waist circumference was found to be the best reflecting criteria of insulin resistance. According to the NCEP criteria, no significant difference was found in fasting blood glucose levels in MS and non MS patients. The reason for this was thought to be the fact that NCEP kept fasting blood glucose threshold value low, in order to reduce the long-term risks. The entity that obesity was found in all the first-degree relatives of the diabetic patients aroused the suspicion that obesity disease may be transferred with the same genes with diabetes and insulin resistance.

Keywords: Diabetes, insulin resistance, metabolic syndrome, obesity

IDF and ATP criteria meeting rates for MS patients

	IDF n (%)	P	NCEP n (%)	P
Waist width	168 (100)	0,001	124 (83,8)	0,001
High Triglycerides	118 (70,2)	0,001	110 (74,3)	0,001
High HDL	96 (57,1)	0,005	95 (64,2)	0,001
High fasting blood glucose	165 (98,2)	0,096	138 (93,2)	0,001
Hypertension	108 (64,3)	0,001	97 (65,5)	0,001
Ratio	168 (80)		148 (70,5)	

P-0029

Management of female patients with Osteoporosis in Primary Health Care

Martha Andreou¹, Valentine Dislian¹, Marianna Petra²

¹Health Centre of Avdira, Xanthi, Greece

²Orthopedic Surgeon, Athens, Greece

BACKGROUND & AIM: The purpose was to study the female patients diagnosed with osteoporosis (dexa, x-rays) and treated by a General Practitioner (G. P.) with the support of an orthopedic surgeon

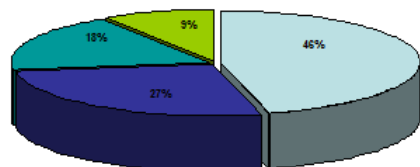
METHOD: We recorded in three years the number of female patients who received treatment against osteoporosis, their age, the pharmaceutical substance, the complications (hip and vertebral fractures), DEXA results (begin and after 2 years) and the compliance

RESULTS: a) totally 132 female patients were recorded, with an average age of 60,96± 6,50 years, b) 61 women (46,2%) received alendronate, 35 women (26,5%) ibandronic acid, 24 women (18,2%) risedronate and 12 women (9,1%) denosumab, c) All of them received calcium and 85 (64,4%) alfacalcidol, d) 104 women (78,8%) received treatment as recommended, e) as complications were recorded 3 hip fractures (2,3%) and 10 vertebral fractures (7,6%), f) about the t-score in DEXA at first was -3,091 ± 0,3765 (-4,2 until -2,5) and after two years -2,616 ± 0,3629 (-3,9 until -2,0)

CONCLUSIONS: a) the majority of the sampled women received bisphosphonates (90.1%) and Calcium pills. b) the majority of the sampled women showed good compliance that reached 100% for those who were treated with denosumab c) Complications were consistent with the literature, d) The majority of women showed a statistically significant improvement after two years of treatment with better results in patients who received denosumab (p<0,05) e) Our results demonstrate that the GP can offer an effective primary care to the female patients with osteoporosis when he has been trained and supported from the experts.

Keywords: women osteoporosis, family medicine, primary healthcare

The pharmaceutical substance



■ alendronate ■ ibandronic acid ■ risedronate ■ denosumab

Descriptive Statistics T-Score

	N	MINIMUM	MAXIMUM	MEAN	STD. DEVIATION
T-SCORE1	132	-4,2	-2,5	-3,091	,3765
T-SCORE2	132	-3,9	-2.0	-2,616	,3629
VALID N (LISTWISE)	132				

One-Sample Statistics T-Score

	N	MEAN	Std. Deviation	Std. Error Mean
T-SCORE1	132	-3,091	,3765	,0328
T-SCORE2	132	-2,616	,3629	,0316

P-0030

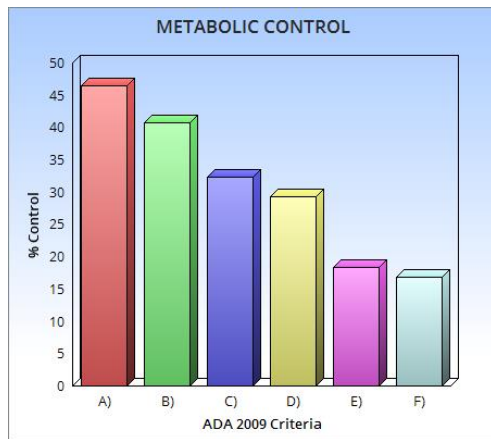
"A still-photograph of diabetes and its knowledge in a rural area"

Jose Antonio PASCUAL Lopez, Pedro María Martínez López, Concepción Martinez Delgado, Alfredo Pérez Carrillo, María Ros Marín, Javier Aracil Fernández, Juana Noelia López Pastor, María Huertas Vidal Gimenez, Francisco Javier Fernández Valero, Noelia Benítez Samuel, Miguel Angel Asmat Segura, Andres Egea Huertas
Centro de Salud de Calasparra. Gerencia del Noroeste. Servicio Murciano de salud. Murcia. Spain.

- Background & AIM: To determine the profile of our diabetic population, control and knowledge of the disease:
- METHOD: Quality assurance methodology. Rural Field. Simple random sampling. We collect biographical data and metabolic control as ADA criteria 2009 and we appreciate their understanding of the disease using a validated test, the adherence to treatment by Morinsky-Green test, the family support and the belonging to a diabetes group.
- RESULTS: 17% of diabetics are under 35 years old and 38% over 70. 64.8% have basic studies and only 4% university studies. 52.1% is male there is no significant difference. Almost 60% of diabetics have less than 10 years of evolution. Metabolic Control (ADA 2009). "A" (fasting glucose) 46.47%, "B" (A + glycohemoglobin) 40.86%, "C" (B + systolic blood pressure) 32.39%, "D" (C + diastolic blood pressure) 29.3%, "E" (D + LDL-cholesterol) 18.31% and "F" (E + Non smoking habit) 16.9%. 74.65% of patients had not presented symptomatic hypoglycemia with a confirmed blood glucose over the last year. Knowledge of the disease: 38% Inappropriate (0-13 / 26), 29.6 Intermediate (14-19 / 26), 32.4 Appropriate (20-26 / 26). 84.5% had family support, 77.5% had a good adherence (Morinsky-Green) and only 5.6% belongs to a group of diabetics.
- CONCLUSIONS: The biographical profile of diabetic patients and their metabolic control in our environment are similar to that found in other studies, with small differences have no statistical significance. There is a very low degree of membership diabetes group. The existence of family support is similar to studies of rural areas. There is a high therapeutic adherence. The percentage of patients without hypoglycemia is low, relative to the use of fewer hypoglycemic antidiabetic.

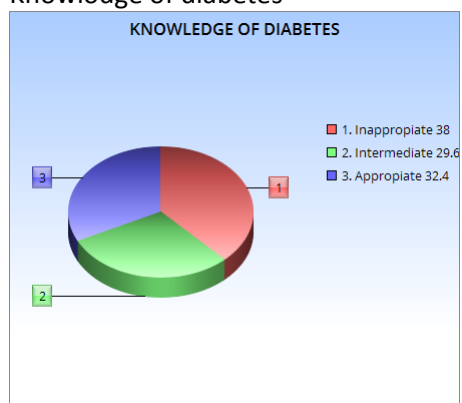
Keywords: Type 2 Diabetes Mellitus, Knowledge, Rural health center

METABOLIC CONTROL



Degree of metabolic control with ADA 2009 criteria "A" (fasting glucose) 46.47%, "B" (A + glycohemoglobin) 40.86%, "C" (B + systolic blood pressure) 32.39%, "D" (C + diastolic blood pressure) 29.3%, "E" (D + LDL-cholesterol) 18.31% and "F" (E + Non smoking habit) 16.9%

Knowledge of diabetes



Knowledge of diabetes with a validate test: Inappropriate (0-13/26), Intermedium (14-19/26) and Adequate (20-26/26)

P-0031

Factors associated with the number of capillary INR in a health centre

Jose Ramon Lopez Lanza¹, Rocio Lopez², Alvaro Perez³, Encarnacion Bustamante¹, Elena Serna¹, Rosa Gerez¹, Maria Jose Agüeros³

¹CS Alisal. Servicio Cantabro de Salud Cantabria. Spain

²CS Comillas. Servicio Cantabro de Salud Cantabria. Spain

³CS Centro. Servicio Cantabro de Salud Cantabria. Spain

Background&AIM: In our country, the control of most of the patients with AF and anti-coagulation using anti-vitamin K drugs, is carried out in primary care, with portable coagulometers on capillary blood. This results in a large number of visits to physicians and nurses. Our aim is to find out the factors associated with a high number a capillary check-ups.

METHOD: Retrospective study of the visits made by anticoagulated patients for AF treated with anti-vitamin K under the supervision of the physician in primary care. Data obtained from computerized medical records and from the hematology laboratory referenced over the period of one year.

Results. We obtained a sample of 201 patients; 141 over the age of 75(70.1%), and an similar number of men and women. 98.7% were taking acenocumarol as anticoagulant. The average number of check-ups per year was (12.21±3.27); more if the patient was immobile(14,02±4,35 Vs 11,62±2,57 p<0,05), which means that 52% of patients whose check-ups took place at home had more than 12 check-ups per year, compared to 32.5% for those who attended the medical centre. Those patients over the age of 75 also required a higher number of check-ups (12.74 ±3.31 Vs 10.97±2.84 p<0.05), and those whose INR was more unstable (13.27±4.17 Vs 11.81±2.66 p<0,05). There were no significant differences in the number of visits with regards to gender or to the degree of control.

CONCLUSIONS: Patients with capillary INR check-ups need to be seen by a doctor or nurse more than once a month on average. This number of check-ups is higher if the patient is unable to leave their house, if they are older or if their INR is more unstable. However, we have not found differences when the INR is controlled less, possibly due to a certain degree of inertia despite the poor control.

Keywords: Atrial fibrillation, anticoagulation, primary care

VARIABLES

VARIABLES	Nº CONTROLS	SIGNIFICATION
Age < 75 Vs >75 years	10,97 (SD 2,84) Vs 12,74(SD 3,31)	P<0,05
Sex Male Vs Female	12,23 (SD 2,91) Vs 12,2 (SD 2,97)	N.S
Inmobile Vs No Inmobile	14,02 (SD 4,35) Vs 11,62(SD 2,57)	P<0,05
INR Unestable Vs INR Estable	13,27 (SD 4,17) Vs 11,81 (SD 2,66)	P<0,05
Good control Vs Bad control	11,76 (SD 2,84) Vs 12,9 (SD 3,75)	N.S

P-0032

A case of generalized lichen nitidus successfully treated with low-dose acitretin

Salim Ozenç¹, Nehir Parlak², Adem Parlak³, Yusuf Emrah Eyi⁴

¹Department of Family Medicine, Diyarbakır Military Hospital, Diyarbakır, Turkey

²Department of Dermatology, Etimesgut Public Hospital, Ankara, Turkey

³Department of Family Medicine, President Guard Regiment, Ankara, Turkey

⁴Department of Emergency Medicine, President Guard Regiment, Ankara, Turkey

INTRODUCTION: Lichen nitidus (LN) is a relatively rare, chronic skin eruption that is characterized clinically by asymptomatic, flat-topped, skin-colored micropapules located on the chest, abdomen, penis glans and upper extremities. It usually presents with limited involvement; however, it can present as generalized involvement. LN mainly affects children and young adults. LN is usually an asymptomatic eruption; however, patients occasionally complain of pruritus. Familial cases have been described. The cause of LN is unknown. Controversy exists regarding the relationship between lichen planus and LN.

CASE: Herein we report the case of a 48-year-old woman who developed generalized LN. The patient came to our outpatient clinic complaining of a rash and pruritus on her body. Her dermatological examination showed bright, diffuse follicular papular lesions which were skin-colored or partially light pink in color. They were 1-2 mm in diameter and distributed on her body and back as well as her arms and legs. Nail and oral mucosal examinations were normal. A punch biopsy sample was taken from a papule on the leg. The patient was diagnosed with LN. The case of generalized lichen nitidus successfully treated with low dose acitretin (20mg). The lesions completely regressed with post-inflammatory hyperpigmentation on the one month of the therapy. We believe that acitretin is an effective treatment on generalized LN.

CONCLUSION: No therapeutic modality has been rigorously evaluated for the treatment of LN because of the rarity, lack of significant symptomatology, and disappearance of this disease within one or several years. Reported therapies, mostly from isolated case reports, include topical and systemic steroids, topical tacrolimus, systemic cetirizine, levamisole, etretinate, acitretin, itraconazole, cyclosporine, topical dinitrochlorobenzene, psoralen plus UV-A light, and narrow-band UV-B light. LN may remain active for several years; however, spontaneous resolution usually occurs.

Keywords: lichen nitidus, acitretin, dermatology

Figure 1. Generalized lichen nitidus



Bright, diffuse follicular papular lesions which were skin-colored or partially light pink in color

P-0033

"Degree of control and knowledge in Diabetes type 2. Comparison between rural and urban populations"

Jose Antonio Pascual Lopez¹, Pedro María Martínez López¹, Javier Aracil Fernández¹, Alfredo Pérez Carrillo¹, Concepción Martínez Delgado¹, María Ros Marín¹, María Dolores Vazquez García², María Huertas Vidal Gimenez¹, Francisco Javier Fernández Valero¹, Noelia Benítez Samuel¹, Mónica Arcos Rivera¹, José Alcibiades Durán Aaron¹

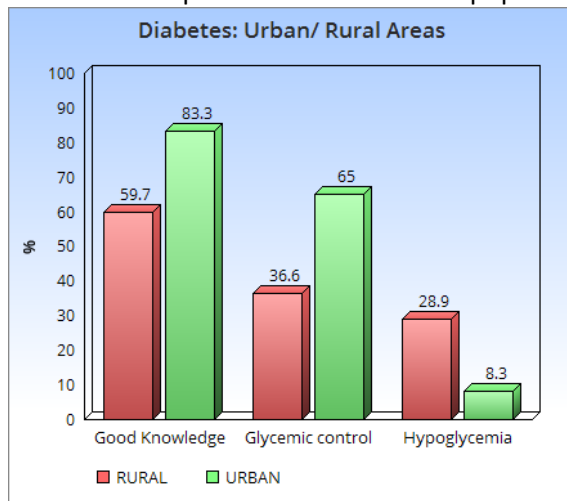
¹Centro de Salud de Calasparra. Gerencia del Noroeste. Servicio Murciano de salud. Murcia. Spain.

²Centro de Salud Barrio del Progreso. Gerencia Area VII. Servicio Murciano de Salud. Murcia. Spain.

- **Background & AIM:** To determine the importance of the control of diabetes and knowledge of the disease in the diabetic population.
- **METHOD:** Quality assurance methodology. Rural Field. Simple random sampling. We collected biographical data (sex, age, educational background and years of evolution), clinical and analytical data, knowledge of the disease using a validated test, adherence to treatment by Morinsky-Green test, family support and group membership diabetes. G-Stat statistical software. Chi-square and Fisher Test.
- **RESULTS:** Knowledge of the disease: Intermediate or appropriate 59.7% (rural) 83.3% (urban). Presence of hypoglycemia: 28.9% (rural) 8.3% (urban). Metabolic Control (ADA 2009 criteria) small non-significant difference. If we value only glycemic control (fasting glucose and HbA1c) is 36.6% (rural) and 65% (urban). Family support: 81% (rural) 100% (urban). Adherence to treatment: 83% (rural) 51% (urban). The rest of measurements studied: group members diabetes, systolic and diastolic blood pressure, LDL-cholesterol or smoking have a homogeneous distribution in both groups.
- **CONCLUSIONS:** There is a much higher percentage of diabetics with a suitable intermediate knowledge of the disease in urban areas, although a very little difference, it does not become significant, probably due to the sample size, nor is there a difference in family support. The differences in hypoglycemia, glycemic control, and adherence to treatment are statistically significant and the first two could be related to a better understanding of the disease in urban areas as we have already seen.

Keywords: Type 2 Diabetes Mellitus, Urban population, Rural health center

Diabetes: Comparison rural and urban population



Diference between rural and urban population in: % Intermediate + Adequate knowledge of diabetes, hypoglycemia and % of patients with good "Glycemic Control" (Fast glucose and HbA1c controlled)

P-0034

Chronic diseases and malnutrition

M Rosario Hernandez Ibañez¹, Natividad Martin Peña¹, Gemma Saez Rubio¹, Alicia Coiduras Charles¹, Carmen Acebron Sanchez Fortun¹, Núria Fabrellas²

¹CAP La Marina. ICS. Barcelona. Catalonia

²Universitat de Barcelona. IDIBELL. Barcelona. Catalonia

INTRODUCTION: The incidence of chronic diseases has increased in recent decades. The main causes are the increasing age of the population and unhealthy habits, such as smoking and alcohol consumption. Heart failure (HF) and Chronic Obstructive Pulmonary Disease (COPD) are major public health problems, because they cause a high morbidity and mortality in the general population. The cardiovascular disease prevention is based on a healthy diet. Healthy diet is part of the treatment of chronic diseases in order to avoid malnutrition. Malnutrition in these patients increases the risk of mortality.

AIM: To assess nutritional status in patients with HF and/or COPD attending an urban primary health care center.

Population:

Cross sectional study of patients with HF and/or COPD conducted during 2014.

Participation was voluntary and a diagnosis of HF and / or COPD during the study had to be registered in the medical record of the patients. Patients with severe mental disorders and other severe conditions in the terminal phase were excluded. A MiniNutritional Assessment test was performed in all patients.

FINDINGS: One hundred and ninety-two patients participated in the study, 77 with HF, 88 with COPD, and 27 with both. Fifty-nine percent of patients were male and 41% female. Average age was 77.6 years (range:46-96).

Overall, 32 of the 192 patients (17%) were malnourished or were at risk of malnutrition. Overall, men had a higher percentage of malnutrition compared to women (20.2% vs. 11.5%). Among the different conditions, the greatest prevalence of malnutrition was observed in patients with HF and COPD (30%), while patients with HF or COPD alone had lower risk (17% and 11%).

CONCLUSIONS: Men have greater risk of malnutrition compared to women. Malnutrition is frequent among patients with HF and/or COPD. Patients with the greatest risk of malnutrition were those suffering from HF associated with COPD.

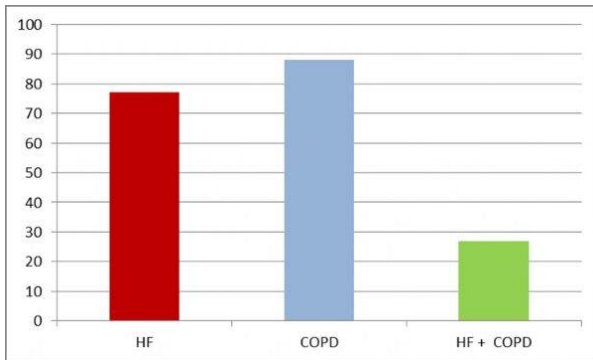
Keywords: Malnutrition, chronic disease, Chronic Obstructive Pulmonary Disease, heart failure



nutrition1



findings



malnutrition



P-0035

Adherence to anti-diabetic medications in Port Saied, Egypt

Taghreed Mohamed Farahat, Nagwa Nashat Hegazy

Department of family medicine; Faculty of medicine, Menofia university

BACKGROUND: Diabetes is the eleventh most important cause of premature mortality in Egypt, and is responsible for 2.4% of all years of life lost (YLL). Similarly, DM is the sixth most important cause of disability burden in Egypt Thus improvement of patient adherence will decline these figures

OBJECTIVES: assess the diabetic patient's adherence to medication and primary health care factors obscuring their adherence.

METHODS: Patients with type 2 DM were recruited at Port Said family health outpatient clinics, Egypt using a convenient sampling technique (150 participants). All the participants were interviewed using Morisky Medication Adherence Scale (MMAS) followed by a semi-structured questionnaire for service obstacles in the primary health care according to the quality standards.

RESULTS: 150 diabetic patients participated in the study most of them were low adherent resembling 55.3% of the studied group. Most of the low adherent patients were illiterate and those with insurance. The main services obstacles that were pointed at were long waiting time and short consultation period. There was a statistical significant correlation between adherence score and obstacles score.

CONCLUSION: This study showed that non adherence of the diabetic patients is a fundamental problem. Primary health care services are a corner stone in shaping their adherence.

Keywords: : Diabetes, diabetic adherence, general practice/family medicine

Figure (1): Distribution of patients regarding adherence

Adherence among diabetic patients

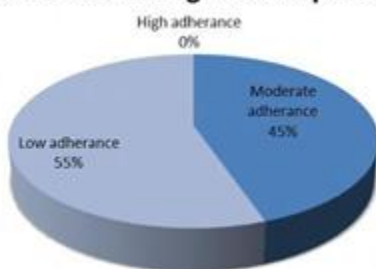


Figure (2): Frequency of primary health care services obstacles

PHC Services obstacles

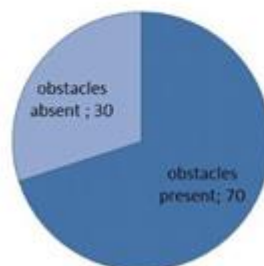


Table (2): Relationship between patient adherence to medication and socio demographic characteristics (N=150):

Socio -demographic characteristics	Moderate	Moderate	Low	Low	χ^2	P value
	(n=67)	(n=67)	(n=83)	(n=83)		
	No	%	No	%		
Gender:						
- Male	38	45.8	8	11.9	19.9	<0.001
- Female	45	54.2	59	88.1		
Marital state:						
- Single	1	1.2	1	1.5	1.87	>0.05
- Married	69	83.1	50	74.6		
- Widow	67	7.2	6	9		
- Divorce		8.4	10	14.9		
Educational level:						
- Illiterate	1	1.2	1	1.5	2.28	>0.05
- Basic	50	60.2	48	71.6		
- Secondary or diplom	257	30.1	144	20.96		
- University and above		8.4				
Occupation:						
- Not work	41	49.4	52	77.6	13.4	<0.001
- Worker	4	4.8	3	4.5		
- Technician	20	24.1	66	99		
- Government employee	18	21.7				
Socioeconomic level:						
- High	22	26.5	9	13.4	5.01	>0.05
- Moderate	21	25.3	21	31.3		
- Low	40	48.2	37	54.8		
Heath insurance:						
- Yes	18	21.7	5	7.5	5.77	<0.001
- No	65	78.3	62	92.5		
Disease duration $\bar{X} \pm SD$	44.2 \pm 3.9		45.2 \pm 4.2		t=1.01	>0.05

Table (3): Number and percent distribution of obstacles among studied group (N=150):

Obstacle	No	%
The time you spend with your doctor is not enough:		
• Disagree	32	21.3
• Not agree nor Disagree	1	0.7
• Agree	117	78
Difficult to conduct the necessary tests:	70	46.7
• Disagree.	0	0
• Not agree nor disagree.	80	53.3
• Agree.		
Difficulty of access to the center:	64	42.7
• Disagree.	0	0
• Not agree nor disagree.	86	57.3
• Agree.		

The center is far from the place of residence:	47	31.3
• Disagree.	3	2
• Not agree nor disagree.	100	66.7
• Agree		
High cost of the services:	64	42.7
• Disagree.	0	0
• Not agree nor disagree.	86	57.3
• Agree.		
Non-existence of a doctor	106	70.7
• Disagree	0	0
• Not agree nor Disagree	44	29.3
• Agree		
Appointments within the center is not appropriate	63	42
• Disagree	0	0
• Not agree nor Disagree	87	58
• Agree.		
Long wait time	59	39.3
• Disagree	0	0
• Not agree nor Disagree	91	60.7
• Agree		
Non-existence of the lab technician:	100	66
• Disagree	1	0.7
• Not agree nor Disagree	49	32.7
• Agree		

P-0036

KNOWLEDGE and EXPERIENCE ABOUT COMPLEMENTARY and ALTERNATIVE MEDICINE OF PATIENTS WITH LOW BACK PAIN IN A PRIVATE HOSPITAL

Nimet Emel Lülecı¹, Ayşe Gülsen Teker¹, Seyhan Hıdırođlu¹, Nurettin Lülecı², Aylin Özkahraman¹, Ayşe Ceren Kaypak¹, Şerife Gözde Şen¹, Ferhat Durup¹, Deniz Tengerek¹

¹Department of Public Health, Marmara University Medicine Faculty, Istanbul, Turkey

²Akkor Sağlık, Istanbul, Turkey

Background and Aim

CAM therapies are emerging in recent years and have been commonly used in many industrialized countries as well. There have been some studies in Turkey about CAM but these studies are limited to certain groups of patients and they are not enough. One of the fields where the CAM treatments are predominantly used is musculoskeletal disorders.

The objective of this study is to get views and experiences related to CAM from patients with low back pain, and to determine patients' level of knowledge about CAM treatments.

Method

In this cross-sectional study, the population consists of 450 patients that visited the pain clinics of a hospital between May and June 2014. And the sample consists of the 250 patients that were selected simple randomly from population. The sample was asked to answer our questionnaire that has 27 questions via telephone. In statistical analysis, the Student's t test, Chi-square test and the Mann-Whitney U test was applied.

Results

62.4 % of participants revealed that they have used CAM previously.

The reputation of the reliability of CAM was 4% very insufficient, 25.2% insufficient, 24% sufficient, 0.8% very sufficient.

45.6% of patient noted that they have no idea about the safety of CAM.

62.4% of the participants think that CAM is effective but sometimes, 27,4% said they found CAM effective, while 10,2% said it is ineffective.

In large of patients learn CAM by advice:

75.2% by advice of a friend and family

18,5% through television or internet

5.1% as a doctor's recommendation.

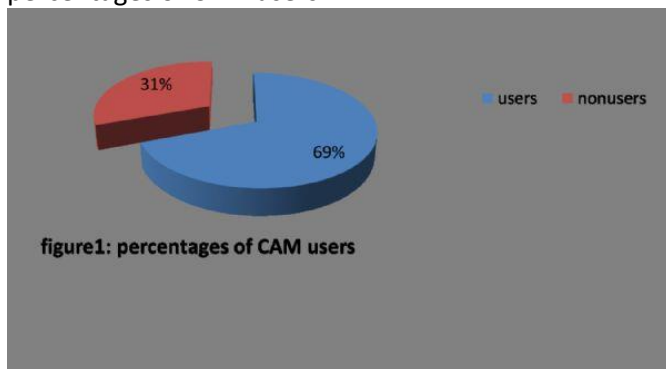
1.3% of patients said they heard CAM from other sources.

Conclusions

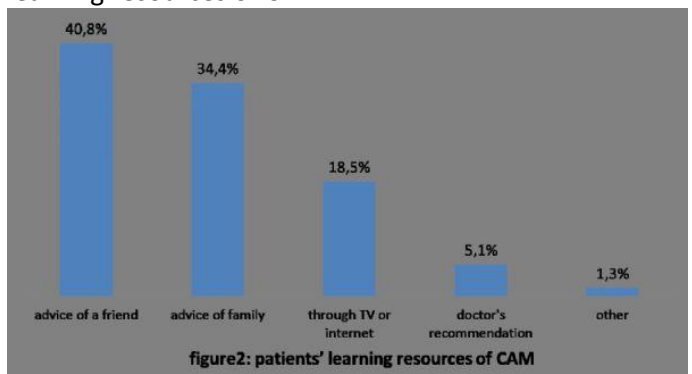
This study showed that patients mostly couldn't get information from right resources. The majority of patients have no idea about CAM safety and efficacy. Health workers should do more researches on this topic. And inform patients correctly.

Keywords: complementary medicine, alternative medicine, low back pain,

percentages of CAM users



learning resources of CAM



P-0037**Effectiveness of Diabetes Shared Care Program (DSCP) on diabetic outpatients of a local clinic in Taiwan**

Jiachi Tu, Ming Chen Chen, Wen Ruey Yu, Chin Yu Ho

Family Medicine Department, Taipei City Hospital, Yangming Branch, Taipei, Taiwan

Introduction: Diabetes is a rising worldwide problem and increases the risk of morbidity and mortality. "Diabetes Shared Care Program (DSCP)" is a comprehensive care model, consisting of multidisciplinary team members. Some studies have proved that DSCP improves the life quality of chronic care on diabetic outpatients in urban area in Taiwan. However, it was rarely studied in primary care in rural area of Taiwan.

Purpose / Methods

This retrospective study aimed to assess the effectiveness of DSCP in managing with type 2 diabetes in an outpatient clinic in rural area of Taiwan. We invited diabetic outpatients to join the DSCP from 2011 to 2014 in primary clinic and enrolled patients who persistently followed up. Parameters related to diabetes among these patients were inquired. Biochemical data were collected before and after the intervention of DSCP and analyzed with SPSS 12.0 software.

Results: 68 diabetic subjects were enrolled (average age 69.5 years with 36.7 % male and 63.3% female) from a local clinic in Taiwan from 2011 to 2014. We found statistically significant improvement in fasting sugar and HbA1C after 1 year intervention. Fasting sugar decreased from 138.7±33.6 to 137.6±33.6 (P<0.001) and HbA1C improved from 7.3±1.2 to 7.1±1.0 (P<0.001). Furthermore, consistent improvement, which was identified by paired T test (P<0.001), was found after 2 years intervention.

Conclusions/Comments: This research demonstrated the positive results of Diabetes Shared Care Program which practice on type 2 diabetic outpatients in primary care. We suggest Diabetes Shared Care Program, providing comprehensive care, should continually be offered to both urban and rural area of Taiwan.

Keywords: Type 2 diabetic:Chronic Disease; Diabetes Shared Care Program; rural area;Taiwan

Table 1.Characteristics of diabetic outpatients in a local clinic by gender (Independent T test)

Variable	Total	male	female	P VALUE
Total	68	25	43	
Age	69.5(8.1)	71.9(7.5)	68.0(8.2)	0.05
BMI	25.2(3.6)	24.9(3.3)	25.4(3.8)	0.60
WC	83.8(10.1)	89.1(8.6)	80.8(9.7)	0.001
SYSTOLIC	131.1(14.3)	131.0(16.9)	131.2(12.8)	0.96
DIASTOLIC	73.9(9.3)	75.1(11.0)	73.2(8.2)	0.42
AC	138.8(33.7)	142.3(41.8)	136.7(28.2)	0.51
HbA1C	7.4(1.2)	7.1(1.2)	7.5(1.2)	0.25
TCH	206(39.7)	197.0(38.0)	211.3(40.2)	0.15
TG	178.9(136.9)	154.2(59.3)	193.5(165.9)	0.25
HDL	51.1(19.9)	47.7(24.1)	53.0(17.0)	0.29
LDL	121.2(37.8)	117.5(32.7)	123.4(40.7)	0.53
CR	1.0(0.2)	1.2(0.2)	0.9(0.2)	0.00
GPT	27.3(16.5)	30.6(16.5)	25.3(16.4)	0.22
EGFR	68.8(15.3)	67.8(15.1)	69.3(15.6)	0.69

Table 2.The efficacy of diabetic control before and after 1 and 2 year follow up. (Biochemical data: Fasting sugar, HbA1C)

Variable	before	1 year	2 year	P value
AC	138.7±33.6	137.6±33.6	129.0±27.2	0.00
HbA1C	7.3±1.2	7.1±1.0	7.1±1.0	0.00

* P value referred to before & 1 year, 1 & 2 year and before& 2 year

P-0038

Does patient centeredness improve health care? A Case report

Abdurrahman Çınar, Oğuz Yılmaz, Azize Dilek Güldal

Department of Family Medicine, Dokuz Eylül University, Izmir, Turkey

Background

Studies show that 72% of the reasons of admission to primary care are chronic diseases. The aim of this case report is to show that better results can be achieved at the management of Type 2 DM by holistic approach.

Case Report

A 43 years old female patient had Type 2 DM for 10 years, receiving insulin therapy for 5 years. She had applied to a hospital with excessive thirst, frequent urination and feeling tired. The results of laboratory tests were fbg:310mg/dl, total cholesterol:412mg/dl, ldl:212mg/dl, hdl:37mg/dl, triglyceride:1450mg/dl, HbA1c.11.9%. She applied to our center because it was hard to get appointment from hospital.

When she applied she was calm and already started to apply her insulin and diet regimen properly. She had been hospitalized 3 times because of BG dysregulation. Recently she was using insulin and fenofibrate. She stopped metformin without consulting a physician. She indicated that she discontinued her medication frequently, although she has information about the DM. Her history was deepened in this direction. The patient expressed that she does not care her disease, feels worthless, nobody cares of her in the family. She lost her sister 2 years ago. The rest of her history and physical examination was normal.

The management of therapy is focused on her social and psychological problems. Patient was encouraged to think and talk about her life situation with her family. Also fluoxetine has been delivered besides regulating antidiabetic therapy. The patient was followed up with regular weekly and then monthly meetings. In follow-up, besides targeted diabetic results, she was feeling very well and stick on her therapy seriously.

Conclusion

The treatment addressing only the medical aspects of blood glucose regulation is inadequate, patient centered clinical method improves health care in primary care.

Keywords: Holistic approach, Type 2 DM, Patient centered clinical method, Family medicine

P-0039

Effect of Lixisenatide on glycosylated hemoglobin and weight in patient with Diabetes type 2 at initial. A case report

Rosa M^a Palacios Fort, Beatriz Soria Navalón

CSI Campello, Department of Health 17 San Juan, Alicante, Spain

Background and AIM:

New treatments for Diabetes type 2 as the glucagon-like peptide-1 receptor agonist (GLP-1) have demonstrated effectiveness in the reduction of postprandial glucose, glycosylated hemoglobin (HbA1c) and weight loss with a low risk of hypoglycemia.

Lixisenatide once daily subcutaneous dosing has shown the above effects and the objective of this study is to verify the data.

METHOD: 72 year-old woman with a history of hypertension, atrial fibrillation, morbid obesity and breast carcinoma, attends primary care consultation by polyuria and polydipsia that has evolved over several months.

Exploration: weight: 91 Kg., size: 150 cm, IMC: 40.4 kg / m²

Analytics: glucose 277 mg/dl, HbA1c 12.3%, ALT 37U/L, glycosuria, other parameters within normal levels.

Starts treatment with Lixisenatide (Lyxumia) 10 µg subcutaneous once daily for 14 days and then follow with Lixisenatide 20 µg once daily subcutaneous, plus metformin 850 mg. every 12 hours, proper diet and exercise for 6 months.

During the treatment the patient has not had any episode of hypoglycaemia or side effects.

RESULTS:

After 6 months the patient has lost 6.5 kg. and Analytics: HbA1c 6.7%, ALT 37, urine microalbumin 425.2 mg/L, albumin/creatinine ratio 369.7 mg/gr, and other parameters within normal levels.

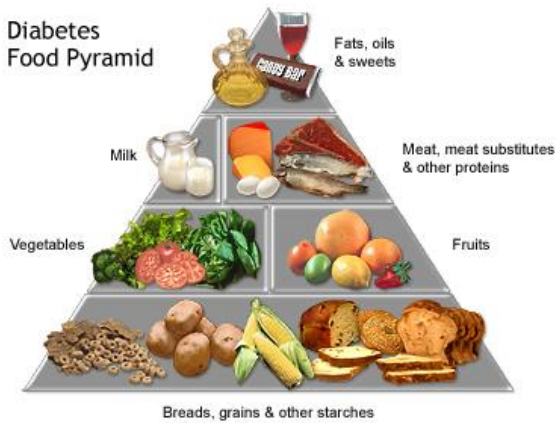
CONCLUSIONS:

Daily subcutaneous Lixisenatide in combination with metformin has proved its effectiveness both in the weight reduction and the decrease of HbA1c, being 5.6 points, with very good tolerability, no side effects nor hypoglycemia during the 6 months of the study. These results may have been so spectacular due to an initial stage of diabetes.

Lixisenatide in combination with oral anti-diabetic therapy significantly improves outcomes combining efficacy and safety in patients with diabetes type 2.

Keywords: Lixisenatide, Type 2 Diabetes, Hemoglobin A Glycosylated, Weight loss

Diabetic food pyramid



Recommendations for Antihyperglycemic Therapy in Type 2 Diabetes

ADA/EASD Position Statement: Managing Hyperglycemia in Type 2 Diabetes

Recommendations for Antihyperglycemic Therapy in Type 2 Diabetes

Lifestyle changes: healthy eating, weight control, increased physical activity, diabetes education

Monotherapy
 Metformin (MET)

If A1C target not achieved after 3 months of monotherapy, proceed to

Dual therapy*

MET + SU ¹	MET + TZD	MET + GLP-1 RA	MET + DPP-4 inhibitor	MET + SGLT2 inhibitor	MET + Insulin (basal)
-----------------------	-----------	----------------	-----------------------	-----------------------	-----------------------

If A1C target not achieved after 3 months of dual therapy, proceed to

Triple therapy

MET + SU ¹ + TZD or DPP-4 or GLP-1 or insulin ²	MET + TZD + SU ¹ or DPP-4 or GLP-1 or insulin ²	MET + GLP-1 RA + SU ¹ or TZD or insulin ²	MET + DPP-4 inhibitor + SU ¹ or TZD or insulin ²	MET + SGLT2 + SU or DPP-4 or TZD or Insulin ²	MET + Insulin (basal) + TZD or DPP-4 or GLP-1
---	---	---	--	--	---

If A1C target not achieved after 3 months of triple therapy and patient (1) on oral combination, move to injectable; (2) on GLP-1, add basal insulin, or (3) on optimally titrated basal insulin, add GLP-1 or mealtime insulin. Refractory patients: consider adding TZD or SGLT2.

Combination injectable therapy¹
 MET + Basal insulin + Mealtime insulin or GLP-1

*Consider initial therapy at this stage with A1C ≥9.0%. ¹Consider initial therapy at this stage with PG ≥300-350 mg/dL and/or A1C ≥10-12%. ²Usually a basal insulin. Inzucch SE et al. Diabetes Care. 2015;38(1):140-149.

P-0040

Comparison of glomerular filtration estimated with MDRD-4 and CKD-EPI between diabetic population "vs" non-diabetic of Madrid Health Service (SIMETAP study)

Antonio Ruiz García¹, María Eugenia García Fernández², Nuria Peña Antón³, María Cruz Díez Pérez⁴, Juan A. Cique Herráinz⁵, Antonio Sánchez Calso⁶, María Camino Baltuille Aller⁷, Pilar Arribas Álvaro⁸, Ana Isabel Macho Del Barrio⁹, Cristina Ciria De Pablo¹⁰, Carmelina Sanz Velasco¹¹, Concepción Vargas Machuca Cabañero¹², Pilar Cabello Igual¹³, Roberto Cabrera Vélez¹⁴, Ana Pilar Javierre Miranda¹⁵, María Pilar Hombrados Gonzalo¹⁶, Rosa Hueso Quesada⁵, Juan Ramón Iglesias Quintana¹⁷, Mercedes Rubio Villar¹⁸, María Soledad Lorenzo Borda¹⁹, Yolanda Hidalgo Calleja⁵, María Inmaculada Hernández Beltrán¹⁷, Raquel Pleite Raposo²⁰, María Carmen Sánchez Ramos²¹, Ana Olga Rodríguez Rodríguez²²

¹Universitary Health Center Pinto (Pinto-Madrid-Spain)

²Health Center Griñón (Torrejón de Velasco-Madrid-Spain)

³Health Center El Restón (Valdemoro-Madrid-Spain)

⁴Health Center Los Cármenes (Madrid-Spain)

⁵Health Center Torito (Moratalaz-Madrid-Spain)

⁶Health Center Galapagar (Galapagar-Madrid-Spain)

⁷Health Center Las Olivas (Aranjuez-Madrid-Spain)

⁸Health Center Campamento (Madrid-Spain)

⁹Health Center Vicente Soldevilla (Madrid-Spain)

¹⁰Health Center Hoyo de Manzanares (Torrelodones-Madrid-Spain)

¹¹Universitary Health Center Sector III (Getafe-Madrid-Spain)

¹²Health Center Guayaba (Madrid-Spain)

¹³Health Center Parque Europa (Pinto-Madrid-Spain)

¹⁴Health Center Espronceda (Madrid-Spain)

¹⁵Health Center Entrevías (Madrid-Spain)

¹⁶Health Center Reyes Magos (Madrid-Spain)

¹⁷Health Center Pavones (Moratalaz-Madrid-Spain)

¹⁸Health Center Abrantes (Madrid-Spain)

¹⁹Universitary Health Center Las Américas (Parla-Madrid-Spain)

²⁰Health Center Carmen Calzado (Alcalá de Henares-Madrid-Spain)

²¹Health Center Eloy Gonzalo (Madrid-Spain)

²²Universitary Health Center Isabel II (Parla-Madrid-Spain)

BACKGROUND: Guidelines recommend estimation of glomerular filtration rate (GFR) and albuminuria as routine tests in diabetic patients. Estimated GFR below 60 mL/min/1.73m² is considered as a major cardiovascular risk factor.

AIM: To compare GFR estimated with MDRD and CKD-EPI between diabetic population "vs" non-diabetic of Madrid Health Service.

METHOD: Study design: Case-control, cross-sectional multicenter study conducted in 55 Health Centers of Madrid Health Service (Spain).

Study population: Simple random sampling of the population (168,853 adults) attached to 111 researchers physicians: 8609 subjects. Exclusion criteria: Untraceable or dataless: 21.66%; refused consent: 7.87%; no medical interview: 3.94%; pregnant, immobilized: 3.44%. Study subjects: 5392.

Statistical analysis: Qualitative variables: Percentages with 95% confidence intervals (CI). Chi-square; z-Test.

Quantitative variables: Means with standard deviation (±SD). Differences of means: T-Test after evaluating Levene test.

RESULTS: Mean (±SD) age of the study population was 55.43 (±17.78) years. The percentage of male sex was 43.27% (41.94-44.60).

Prevalence of diabetes mellitus (DM) was 14.84% (13.90-15.81). Prevalence of chronic kidney disease (CKD) was 11.76% (10.91-12.65).

The differences of descriptive variables, prevalences of CKD stages and albuminuria between diabetic "vs" non-diabetic are described in tables 1 and 2.

In diabetic population, GFR mean estimated with MDRD-4 (85.92 mL/min/1.73m²) was slightly but significantly (p < 0.0001) higher than estimated with CKD-EPI (81.99 mL/min/1.73m²). There was no significant differences between prevalences of any CKD stage estimated with MDRD-4 "vs" CKD-EPI (Table 3).

CONCLUSIONS: GFR estimated with MDRD-4 and CKD-EPI are 8 and 13 mL/min/1.73m² respectively lower in diabetic than in non-diabetic.

GFR < 60 mL/min/1.73m² is three times more frequent in diabetic than in non-diabetic.

Prevalence differences in all stages of CKD between diabetic "vs" non-diabetic are significant, except in stage 4 In the diabetic population, there are not significant differences in the prevalence of any CKD stages estimated with CKD-EPI "vs" MDRD-4.

Keywords: Diabetes mellitus; Glomerular filtration rate; Chronic kidney disease.

Differences in descriptive variables between diabetic "vs" non-diabetic.

	* DM no.= 800	Non-DM no.= 4592	Means difference	T-Test p- value
Age (years)	Mean (javascript:adsym('%C2%B1');SD) 68.40 (javascript:adsym('%C2%B1');12.64)	Mean (javascript:adsym('%C2%B1');SD) 53.18 (javascript:adsym('%C2%B1');15,66)	15.22	<0.0001
Fasting plasma glucose (mg/dL)	132.15 (javascript:adsym('%C2%B1');39.28)	88.71 (javascript:adsym('%C2%B1');11.18)	43.44	<0.0001
HbA1c (%)	6.82 (javascript:adsym('%C2%B1');1.17)	5.33 (javascript:adsym('%C2%B1');0.45)	1.49	<0.0001
Creatinine (mg/dL)	0.93 (javascript:adsym('%C2%B1');0.49)	0.83 (javascript:adsym('%C2%B1');0.25)	0.10	<0.0001
Albuminuria (mg/L)	30.48 (javascript:adsym('%C2%B1');98.47)	10.52 (javascript:adsym('%C2%B1');33.83)	19.97	<0.0001
§ ACR (mg/g)	33.65 (javascript:adsym('%C2%B1');103.86)	10.17 (javascript:adsym('%C2%B1');44.17)	23.48	<0.0001
† GFR (MDRD-4) (mL/min/1.73m ² ; %C2%B2');	85.92 (javascript:adsym('%C2%B1');27.80)	94.13 (javascript:adsym('%C2%B1');25.33)	-8.21	<0.0001
GFR (CKD-EPI) (mL/min/1.73m ² ; %C2%B2');	81.99 (javascript:adsym('%C2%B1');24.22)	94.78 (javascript:adsym('%C2%B1');22.42)	-12.79	<0.0001

* DM: Diabetes mellitus § ACR: Urinary albumin:creatinine ratio † GFR: Glomerular filtration rate

Differences in prevalences between diabetic "vs" non-diabetic.

	* DM (%) (95% CI) no.= 800	Non-DM (%) (95% CI) no.= 4592	Percentages difference (%)	p-value
Male sex	54.25 (50.72-57.74)	41.35 (39.93-42.79)	12.90	<0.0001
¥ CKD	27.13 (24.07-30.35)	9.08 (8.27-9.95)	18.05	<0.0001

Albuminuria >30 mg/L	17.72 (15.16-20.58)	5.63 (4.99-6.35)	12.09	<0.0001
§ ACR >30 mg/g	18.37 (15.75-21.24)	4.79 (4.19-5.45)	13.58	<0.0001
CKD stage 1 (MDRD-4)	39.63 (36.22-43.11)	52.74 (51.28-54.19)	-13.11	<0.0001
CKD stage 2 (MDRD-4)	45.75 (42.26-49.28)	41.94 (40.50-43.37)	3.81	0.0443
CKD stage 3 (MDRD-4)	13.00 (10.75-15.53)	4.97 (4.36-5.63)	8.03	<0.0001
CKD stage 4 (MDRD-4)	0.88 (0.35-1.79)	0.30 (0.17-0.51)	0.58	0.0146
CKD stage 5 (MDRD-4)	0.75 (0.28-1.63)	0.04 (0.00-0.16)	0.71	<0.0001
CKD stage 1 (CKD-EPI)	36.00 (32.67-39.44)	59.09 (57.66-60.52)	-23.09	<0.0001
CKD stage 2 (CKD-EPI)	48.38 (44.86-51.90)	35.33 (33.95-36.73)	13.05	<0.0001
CKD stage 3 (CKD-EPI)	14.13 (11.78-16.73)	5.20 (4.58-5.89)	8.93	<0.0001
CKD stage 4 (CKD-EPI)	0.75 (0.28-1.63)	0.35 (0.20-0.57)	0.40	0.1020
CKD stage 5 (CKD-EPI)	0.75 (0.28-1.63)	0.02 (0.00-0.12)	0.73	<0.0001

* DM: Diabetes mellitus ¥ CKD: Chronic kidney disease § ACR: Urinary albumin:creatinine ratio

Differences between prevalences of CKD stages estimated with CKD-EPI "vs" MDRD-4 in diabetic population.

¥ CKD stages no.= 800	* DM (%) CKD-EPI	DM (%) MDRD-4	Percentages difference (%)	p-value
1	36.00 (32.67-39.44)	39.63 (36.22-43.11)	-3.63	0.1344
2	48.38 (44.86-51.90)	45.75 (42.26-49.28)	2.63	0.2920
3	14.13 (11.78-16.73)	13.00 (10.75-15.53)	1.13	0.5092
4	0.75 (0.28-1.63)	0.88 (0.35-1.79)	-0.13	0.7724
5	0.75 (0.28-1.63)	0.75 (0.28-1.63)	0.00	1

¥ CKD: Chronic kidney disease * DM: Diabetes mellitus

P-0041

COPD Screening in Family Medicine

Neda Ferizovic, Amra Lasic, Rasema Sehovic, Elma Merdzanovic, Farida Mehic, Atifa Kulovic
Public Institution Health Centre of Sarajevo Canton, Bosnia and Herzegovina

INTRODUCTION: COPD is "undervalued" because it is not recognized and not diagnosed until it is clinically recognizable and advanced. This disease affects 329 million people(5%) in the world, (WHO, 2013)

OBJECTIVE: To investigate the justification for the use of mini-spirometer (COPD-6) in family medicine for early detection of COPD in younger and middle-aged patients.

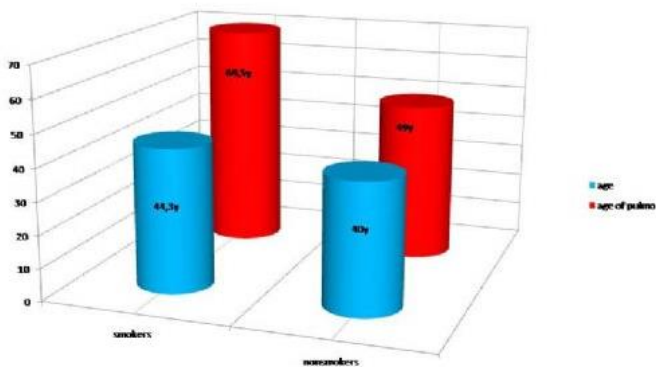
METHODS: Epidemiological study of six family medicine teams in the Sarajevo Canton (September - December 2014) on 240 patients (120 smokers and 120 non-smokers) 35 - 65 years of age with no prior diagnosis of COPD. Parameters for the study were: gender, age, smoking status, degree of dyspnea and pulmonary function. Data was obtained through an interview, COPD Assessment Test (CAT) and spirometry done with mini-spirometer (COPD-6) (FEV₁, FEV₆ and FEV₁ / FEV₆).

RESULTS: 240 patients with an average age of 48.04, SD 17.67. Of 142 women, 73 (51.4%) were smokers, and of 98 men 47 (47.9%) were smokers. According to the degree of dyspnea (CAT) 29% of smokers have moderate and severe dyspnea (23M and 12F), while 87% of non-smokers have no symptoms or they are very mild. Obstruction index 1 (50% <FEV₁ <80%) was found in 28.75% of patients (32M, 37F). Index obstruction 1 had 46.6% (25M,31F) of smokers, and 10.8% (7M6F) of non-smoker. According to the GOLD guidelines (50% <FEV₁ <80% and FEV₁ / FEV₆ <0.73) GOLD stage 2 COPD have 17 subjects (7.08%), 16 (10M and 6F) or 13.3% of smokers and 1 (M) non-smoker.

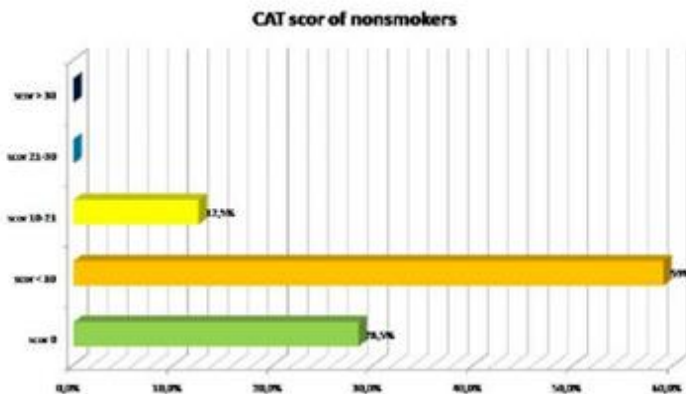
CONCLUSION: Newly discovered 7.08% of COPD patients, younger and middle aged with previously unrecognized diagnosis, justify the need for screening, especially in those with a positive smoking history (13.3% detected). Using mini-spirometer(COPD6) for evidence of airway obstruction family physician can begin early treatment of COPD and, if necessary, refer the patient to the "big" spirometry.

Keywords: COPD, Screening, Family practice

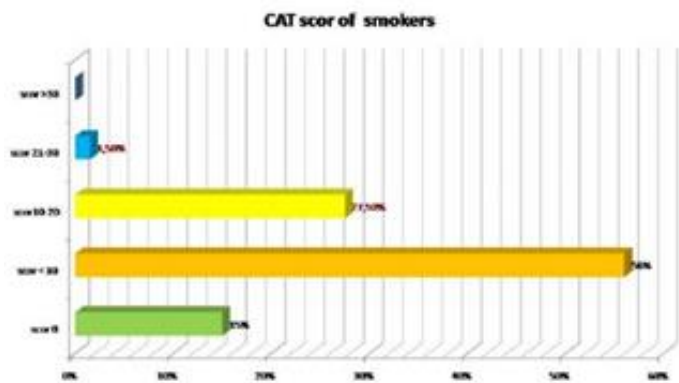
Age and age of lung in smokers and nonsmokers



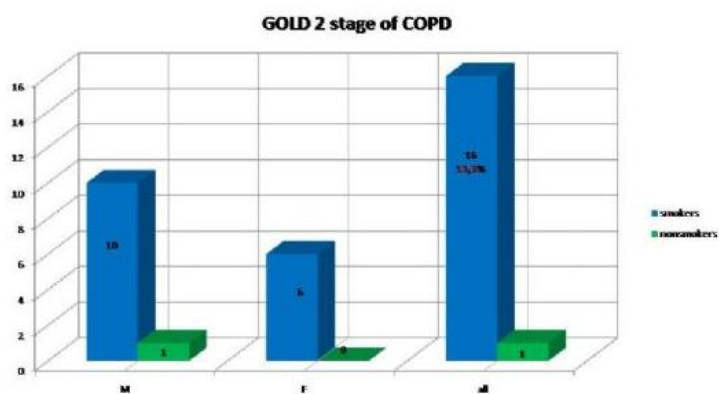
CAT score of nonsmokers



CAT score of smokers



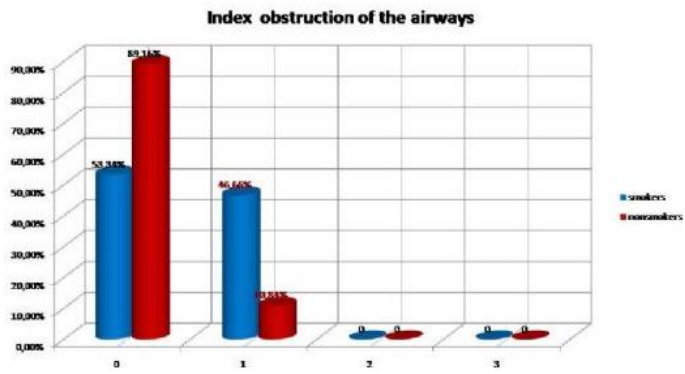
GOLD 2 stage of COPD



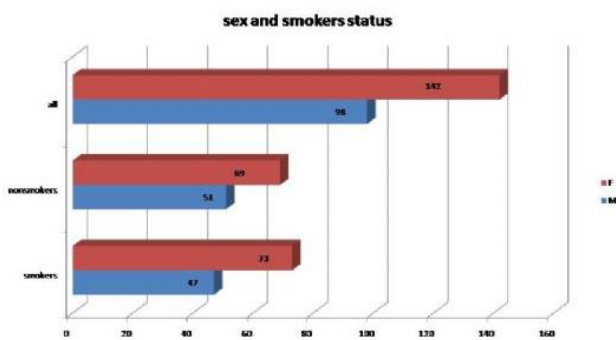
GOLD stage of COPD

GOLD	FEV ₁ %	FEV ₁ /FEV ₆
normal		≥ 0,73
stadij 1	≥ 80%	< 0,73
stadij 2	< 80%	< 0,73
stadij 3	< 50%	< 0,73
stadij 4	< 30%	< 0,73

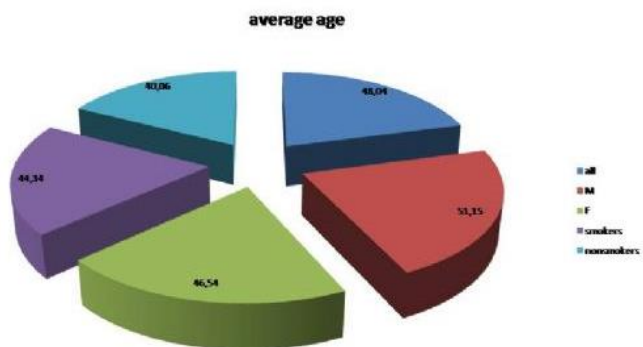
Obstruction of airways



smokers status in men and women



Structure of participants



The degree of dyspnea according CAT score

score	Degree of dyspnea
scor 0	No simptoms
scor < 10	mild dispnea
scor 10-20	moderate dispnea
scor 21-30	severe dispnea
scor > 30	Very severe dispnea

COPD6 mini spirometer



P-0042

Factors associated with Diabetic nephropathy in patients with Diabetes mellitus type 2 in Community Medical Unit 3 of Buriram hospital

Teeranart Oungsakul, Thanawan Bailee, Siwaporn Boonnontae, Tanapong Ing Ab, Anek Kaewsawat, Chayutra Intrakumhang, Thanaban Sereesongsaeng, Asst.prof. Dr.soraya Kaewpitoon, Dr. Pantipa Sangkarit, Dr. Seekaow Churproong, Thawee Sang Ngam
Department of Medicine, Suranaree university of technology, Nakhonratchasima, Thailand

Diabetic nephropathy is the most famous complication of Diabetic patients in Thailand and lead to renal replacement therapy, included by many factors. This study aimed to study the factors associated with Diabetic nephropathy in patients with Diabetes mellitus type 2.

The cross-sectional descriptive study and analytic study is chosen in the research for assess the factors with effected on diabetic nephropathy (DN). The study was done among 80 diabetes mellitus type 2-clients who came to Community Medical Unit 3 of Buriram hospital between 1st October 2013 and 30th November 2014. There are 65 diabetic nephropathy patients and 15 non-diabetic nephropathy patients.

The result of descriptive study revealed that the Mostly female, mean of age is 62 years, the most comorbidity is hypertension (78.8%), the most drug use is sulfonylurea group, and they have good knowledge, neutral attitude and moderate behavior.

The factors associated DN that we found the statistic significant in univariate analysis are the age less than or equal to 60 year-old, revealed lower chance to turn to DN compared with the age more than 60 years for 0.21 times (OR 0.05 95% CI=0.06-0.74), the male patient is lower chance to turn to DN compared with the female patient about 0.25 times (OR 0.05 95% CI=0.07-0.84), and patient have diabetic disease duration more than 10 years is higher chance to turn to DN than patient have lower 5 years is 8.46 times (OR 8.46 95% CI=1.01-71.10). Moreover, multivariate analysis at the significant level revealed that male patient is lower chance to turn to DN compared with the female patient about 0.13 times (OR 0.13 95% CI=0.02-0.67) and patients who have poor behavior are lower chance to turn to DN compare with patient who have great behavior about 0.03 times (OR 0.03 95% CI=0.01-0.88)

Keywords: Diabetes mellitus type 2, Diabetes nephropathy

Figure1: the sample size was calculated by Openepi

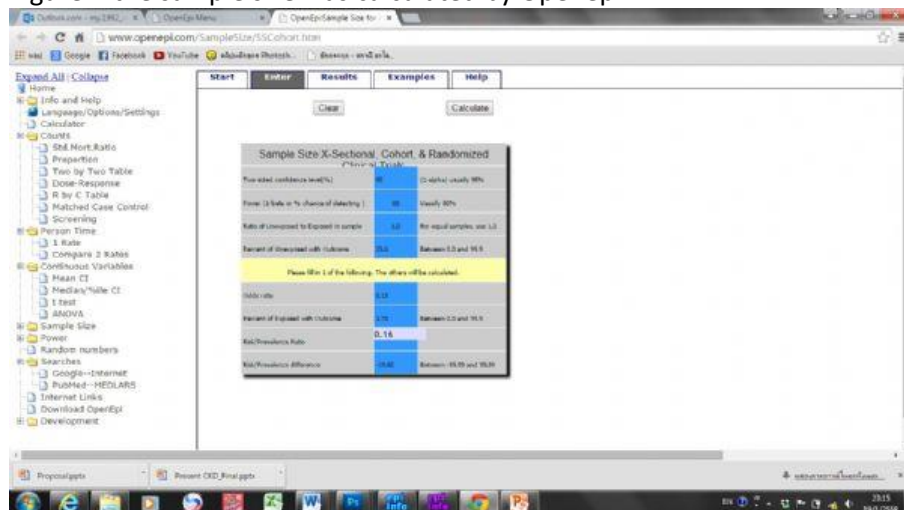


Table1: The individual data of the sample group

Individual factor	Most likely
Gender	Female (60%)
Mean of age	62 years
Education	Graduated from grade 4th(56.3%)
Income	Less than 5,000bath/month(31.1%)
Comorbidity	Hypertension (78.8%)
Duration of diabetes	Less than 5 years (46.25%)
Drug used	Sulfonylurea group(75.0%)

Figure2: the sample size was calculated by Openepi

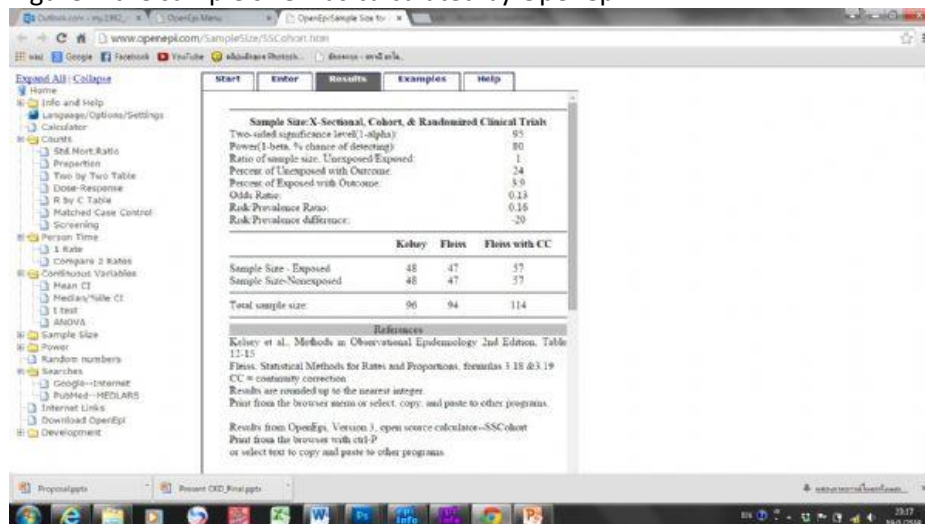


Table2: The data of biological factor of the sample group

Biological factor	Most likely
systolic blood pressure	≥ 130 mmHg (92.5%)
diastolic blood pressure	≥ 80 mmHg (61.25%)
BMI	≥ 25.0 (55.0%)

eGFR	60-89 ml/min (stage 2) (42.5%)
HbA1C	≥7 (71.25%)
cholesterol level	< 200 (57.5%)
LDL level	≥ 100 (56.25%)
Triglyceride level	< 150 (55.0%)
HDL level in men	≥ 40 mg/dl (78.1%)
HDL level in women	≥ 50 mg/dl (64.6%)

Figure3: the conclusion of the study population

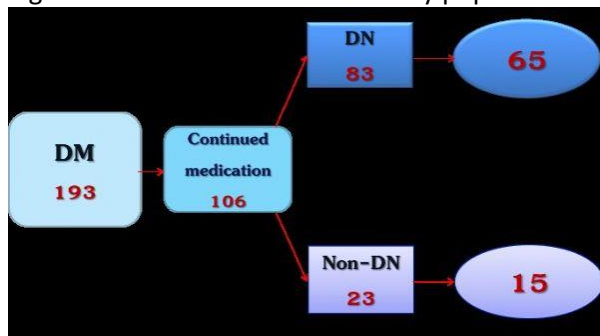


Table3: The data of knowledge, attitude and behavioral factor of the sample group

	Most likely
Knowledge	Good (46.3%)
Attitude	Neutral (45.0%)
Behavioral factor	Moderate (63.8%)

P-0043

A case group presentation with autoimmune polyglandular syndrome

Burcu Dogan¹, Hasan Ergenc², Nurdan Yörük³, Aytakin Oguz³

¹Family Medicine Clinic, Sakarya Training and Research Hospital, Sakarya, Turkey

²Department of Internal Medicine, Sakarya Training and Research Hospital, Sakarya, Turkey

³Department of Internal Medicine, Istanbul Medeniyet University Goztepe Training and Research Hospital, Istanbul, Turkey

Introduction

This study aim, the Autoimmune Polyglandular Syndrome (APS) determination of frequency in patients with Type 1 Diabetes Mellitus (T1DM).

Method

483 T1DM patients (264 men, mean age 36,73 and 218 women, mean age 35,82) who applied to Istanbul Medeniyet University Göztepe Training and Research Hospital, Diabetes Department between the dates 2009 and 2014 were included in the study. The patients with at least two autoimmune diseases accompanying the diabetes were scanned retrospectively.

Results

11 of the 483 patients had the Celiac Disease (CD) diagnosed with duodenum biopsy. 8 of the patients who were diagnosed with the CD were also diagnosed with Hashimoto Thyroiditis (HT) with one of or both of the Anti TPO and Anti Thyroglobulin positivity. These patients were in the APS Group Type 3B because they were diagnosed

with T1DM, CD and HT together. During the systemic examinations, Vitiligo was detected in 4 patients. 3 of the patients were diagnosed with the HT with one of or both of the Anti TPO and Anti Thyroglobulin positivity. The patients who had T1DM, Vitiligo and HT together were in the APS Type3C group. In a patient with T1DM and CD but no autoimmune thyroiditis, deep vein thrombosis developed, and factor V lieden mutation (homozygote) protein C and S deficiency MTHFR A 1298C mutation (heterozygote) were detected. The patient was evaluated in APS type4 group.

Conclusion

Upon 5 years of follow-up for the 483 patients with T1DM, the APS Type3B was determined in 12 of them. As a result, the APS frequency in T1DM patients has been determined as 2,48%; and the APS Type3B 1,65%, APS Type3C 0,62% and APS Type4 0,20%. Since it is known that various diseases may be included in the APS, it is considered that these rates may actually be higher.

Keywords: Autoimmune Polyglandular Syndrome, Type 1 Diabetes Mellitus, Hashimoto Thyroiditis, Celiac Disease, Vitiligo

Classification of Autoimmune Polyglandular Syndrome



P-0044

Comparison of glomerular filtration estimated with MDRD-4 and CKD-EPI between hypertensive population "vs" non-hypertensive of Madrid Health Service (SIMETAP study)

Antonio Ruiz García¹, María Eugenia García Fernández², María Carmen Martín Calle³, María Paloma García Villasur⁴, Nuria Nuria Marañón Henrich⁵, María Carmen Antón Sanz⁶, Teresa Fátima Casaseca Calvo⁷, Pilar Arribas Alvaro⁸, Ana Isabel Macho Del Barrio⁹, Cristina Ciria De Pablo¹⁰, Concepción Vargas Machuca Cabañero¹¹, Pilar Cabello Igual¹², Beatriz López Uriarte¹³, María Carmen Vieira Pascual¹⁴, Teresa Pascual Val¹⁵, Antonio Rosillo González¹⁶, Ana Pilar Javierre Miranda¹⁷, Rosa Ana Escrivá Ferrairó¹⁸, María Pilar Hombrados Gonzalo¹⁹, Ana María Ibarra Sánchez²⁰, Rosa Hueso Quesada²¹, Ana Isabel Martín Fernández¹, Mercedes Redondo Sánchez²¹, María Rosario Durán Tejada²¹, María Rosa García Redondo²¹

¹Universitary Health Center Pinto (Pinto-Madrid-Spain)

²Health Center Griñón (Torrejón de Velasco-Madrid-Spain)

³Health Center Ntraª Srª de Fátima (Madrid-Spain)

⁴Health Center María Montessori (Leganés-Madrid-Spain)

⁵Health Center Las Olivas (Aranjuez-Madrid-Spain)

⁶Health Center Alpedrete (Alpedrete-Madrid-Spain)

⁷Health Center Casa de Campo (Madrid-Spain)

⁸Health Center Campamento (Madrid-Spain)

⁹Health Center Vicente Soldevilla (Madrid-Spain)

¹⁰Health Center Hoyo de Manzanares (Torrelodones-Madrid-Spain)

¹¹Health Center Guayaba (Madrid-Spain)

¹²Health Center Parque Europa (Pinto-Madrid-Spain)

¹³Health Center Humanes (Humanes-Madrid-Spain)

¹⁴Health Center La Plata (Madrid-Spain)

¹⁵Health Center Los Ángeles (Madrid-Spain)

¹⁶Health Center Embarcaciones (Tres Cantos-Madrid-Spain)

- ¹⁷Health Center Entrevías (Madrid-Spain)
- ¹⁸Health Center Santa Isabel (Leganés-Madrid-Spain)
- ¹⁹Health Center Reyes Magos (Madrid-Spain)
- ²⁰Health Center Buenos Aires (Madrid-Spain)
- ²¹Health Center Torito (Moratalaz-Madrid-Spain)

BACKGROUND: Guidelines recommend estimation of glomerular filtration rate (GFR) and albuminuria as routine tests in hypertensive. Estimated GFR below 60 mL/min/1.73m² is considered as a major cardiovascular risk factor. **AIM:** To compare the GFR estimated with MDRD and CKD-EPI between hypertensive population "vs" non-hypertensive of Madrid Health Service.

METHOD:

Study design: Case-control, cross-sectional multicenter study conducted in 55 Health Centers of Madrid Health Service (Spain).

Study population: Simple random sampling of the population (168,853 adults) attached to 111 researchers physicians: 8609 subjects. Exclusion criteria: Untraceable or dataless: 21.66%; refused consent: 7.87%; no medical interview: 3.94%; pregnant, immobilized: 3.44%. Study subjects: 5392.

Statistical analysis: Qualitative variables: Percentages with 95% confidence intervals (CI). Chi-square; z-Test.

Quantitative variables: Means with standard deviation (±SD). Differences of means: T-Test after evaluating Levene test.

RESULTS:

Mean (±SD) age of the study population was 55.43 (±17.78) years. The percentage of male sex was 43.27% (41.94-44.60).

Prevalence of hypertension (HTN) was 36.78% (35.49-38.08). Prevalence of chronic kidney disease (CKD) was 11.76% (10.91-12.65).

Differences of descriptive variables and in prevalences of CKD stages and albuminuria between hypertensive "vs" non-hypertensive are described in tables 1 and 2.

In hypertensive population, the GFR mean estimated with MDRD-4 (83.97 mL/min/1.73m²) was slightly but significantly (p= 0.0014) higher than estimated with CKD-EPI (81.36 mL/min/1.73m²). There was no significant differences between prevalences of any CKD stage estimated with MDRD-4 "vs" CKD-EPI (Table 3).

CONCLUSIONS:

The GFR estimated with MDRD-4 and CKD-EPI are 14 and 18 mL/min/1.73m² respectively lower in hypertensive than in non-hypertensive.

The GFR < 60 mL/ min/1.73m² is five times more frequent in hypertensive than in non-hypertensive.

All prevalence differences in any stage of CKD between hypertensive "vs" non-hypertensive are significant.

In the hypertensive population, there are not significant differences in the prevalence of any CKD stages estimated with CKD-EPI "vs" MDRD-4.

Keywords: Hypertension; Glomerular filtration rate; Chronic kidney disease.

Differences in descriptive variables between hypertensive "vs" non-hypertensive.

	* HTN no.= 1550	Non-HTN no.= 2851	Means differe nce	T-Test p- value
	Mean (javascript:addsym('%C2%B 1');SD)	Mean (javascript:addsym('%C2%B 1');SD)		
Age (years)	68.08 (javascript:addsym('%C2%B 1');13.02)	48.08 (javascript:addsym('%C2%B 1');15,66)	20.00	<0.00 01
Systolic blood pressure (mmHg)	131.44 (javascript:addsym('%C2%B 1');15.32)	116.54 (javascript:addsym('%C2%B 1');12.94)	14.90	<0.00 01
Diastolic blood pressure (mmHg)	76.66 (javascript:addsym('%C2%B 1');9.83)	71.14 (javascript:addsym('%C2%B 1');9.33)	5.52	<0.00 01

Creatinine (mg/dL)	0.91 (javascript:addsymb('C2%B1');0.39)	0.80 (javascript:addsymb('C2%B1');0.22)	0.11	<0.0001
Albuminuria (mg/L)	22.20 (javascript:addsymb('C2%B1');78.94)	8.52 (javascript:addsymb('C2%B1');15.93)	13.68	<0.0001
§ ACR (mg/g)	26.68 (javascript:addsymb('C2%B1');91.80)	7.28 (javascript:addsymb('C2%B1');12.69)	19.40	<0.0001
† GFR (MDRD-4) (mL/min/1.73mjavascript:addsymb('C2%B2');)	83.97 (javascript:addsymb('C2%B1');24.17)	98.11 (javascript:addsymb('C2%B1');25,42)	-14.14	<0.0001
GFR (CKD-EPI) (mL/min/1.73mjavascript:addsymb('C2%B2');)	81.36 (javascript:addsymb('C2%B1');21.09)	99.59 (javascript:addsymb('C2%B1');21.60)	-18.23	<0.0001

* HTN: Hypertension § ACR: Urinary albumin:creatinine ratio † GFR: Glomerular filtration rate

Differences in prevalences between hypertensive "vs" non-hypertensive.

	*HTN (%) (95% CI) no.= 1550	Non-HTN (%) (95% CI) no.= 2851	Percentages difference (%)	p-value
Male sex	46.70 (44.20-49.23)	41.27 (39.47-43.12)	5.43	0.0005
¥ CKD	22.34 (20.27-24.48)	5.60 (4.80-6.52)	16.74	<0.0001
Albuminuria >30 mg/L	12.93 (11.27-14.67)	4.28 (3.57-5.09)	8.65	<0.0001
§ ACR >30 mg/g	13.51 (11.82-15.29)	2.90 (2.33-3.60)	10.61	<0.0001
CKD stage 1 (MDRD-4)	35.35 (32.97-37.79)	59.78 (57.94-61.58)	-24.43	<0.0001
CKD stage 2 (MDRD-4)	50.68 (48.46-52.90)	37.75 (36.12-39.40)	12.93	<0.0001
CKD stage 3 (MDRD-4)	12.71 (11.27-14.25)	2.35 (1.87-2.91)	10.36	<0.0001
CKD stage 4 (MDRD-4)	0.91 (0.54-1.43)	0.09 (0.02-0.26)	0.82	<0.0001
CKD stage 5 (MDRD-4)	0.35 (0.14-0.73)	0.03 (0.00-0.16)	0.32	0.0032
CKD stage 1 (CKD-EPI)	33.54 (31.46-35.66)	68.52 (66.94-70.08)	-34.98	<0.0001
CKD stage 2 (CKD-EPI)	51.64 (49.41-53.86)	28.89 (27.38-30.45)	22.75	<0.0001
CKD stage 3 (CKD-EPI)	13.67 (12.18-15.26)	2.38 (1.89-2.94)	11.29	<0.0001
CKD stage 4 (CKD-EPI)	0.86 (0.50-1.37)	0.15 (0.05-0.34)	0.71	<0.0001

CKD stage 5 (CKD-EPI) 0.30 (0.11-0.66) 0.03 (0.00-0.16) 0.27 0.0078

* HTN: Hypertension ¥ CKD: Chronic kidney disease § ACR: Urinary albumin:creatinine ratio

Differences between prevalences of CKD stages estimated with CKD-EPI "vs" MDRD-4 in hypertensive population.

¥ CKD stages no.= 1550	* HTN (%) CKD-EPI	HTN (%) MDRD-4	Percentages difference (%)	p-value
1	33.54 (31.46-35.66)	35.35 (32.97-37.79)	-1.81	0.2890
2	51.64 (49.41-53.86)	50.68 (48.46-52.90)	0.96	0.5929
3	13.67 (12.18-15.26)	12.71 (11.27-14.25)	0.96	0.4296
4	0.86 (0.50-1.37)	0.91 (0.54-1.43)	-0.05	0.8819
5	0.30 (0.11-0.66)	0.35 (0.14-0.73)	-0.05	0.8068

¥ CKD: Chronic kidney disease * HTN: Hypertension

P-0045

Importance of Diagnosing Diabetes Mellitus For Primary Care: Case Report

Elif Altunbaş Ateş, Zehra Aslan Aydoğdu, Burcu Aykanat, Turan Set

Department of Family Medicine, Karadeniz Technical University, Trabzon, Turkey

Background&AIM: In this study, a case diabetes mellitus (DM) did not diagnosed previously was discussed from a diagnostic direction

CASE: Thirty one-year-old male patient was admitted to Family Medicine outpatient clinic with complaints of drinking a lot of water, frequent urination, dry mouth in the last two months. He was anxious; because his uncle died two months ago due to late diagnosed DM complications. He also stated 12 kg weight lost in the last 20 days, loss of appetite and itchy sores on his back at the last two months. On physical examination, general condition of the patient was good. Body mass index was 31.14. Other physical examination findings were normal as blood pressure of 130/80 mmHg. Laboratory results were fasting blood glucose: 280 mg/dl, total cholesterol: 333 mg/dL, triglyceride level: 898 mg/dL, high density lipoprotein-cholesterol: 37 mg/dL, low density lipoprotein-cholesterol: 202 mg/dL. According to these findings, additional tests for diagnosis are carried out such as glycosylated hemoglobin A1c (HbA1C): %14.2, insulin level: 11.6 uIU/mL and C peptide: 1,74 ng/ml. In urine analysis, ketone was 80 mg/dL and glucose was 1000 mg/dL. As a result, we diagnosed this patient as DM. He was consulted with endocrinology department in terms of the hospitalization indicate, diabetic ketoacidosis and initiating insulin therapy. At the same day, patient was hospitalized to the endocrine service.

CONCLUSIONS: Although our patient has good general condition, laboratory findings were bad according to clinical situation. In case of delay of this patient's application could occur major complications. Obtaining early diagnosis and treatment goals are very important in terms of preventing complications. Giving education to patients, the recommended diet and exercise is as important as medical treatment.

Screening individuals with risk factors for DM and early diagnosis are extremely important. Family physician who gives continuous care and knows best the medical history of patients has an important role.

Keywords: Diabetes Mellitus, Primary Care, Early Diagnosis

P-0046

Assessment of Knowledge, Attitudes and Behaviors of Diabetic Patients About Diabetic Foot and Foot Care

Feyza Yücel, Didem Sunay

Department of Family medicine, Keçiören training and research hospital, Ankara, Turkey

Background and AIM: To assess the knowledge, attitudes and behaviors of diabetic patients about diabetic foot (DF) and foot care (FC).

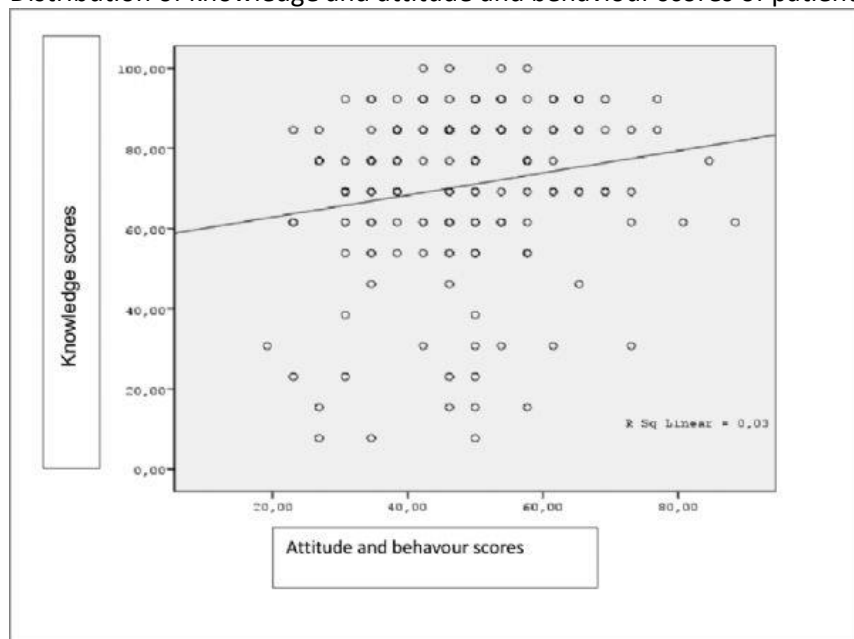
MATERIALS-METHODS: Patients attended to family medicine out-patient clinics with diabetes (DM) between May-August 2014 were included in this cross-sectional study. Data were collected by a questionnaire consisted of 56 items that questioned knowledge, attitudes, behaviors of patients about DF and FC. Correct answers were considered '1' point, wrong ones were '0' point. Collected scores were converted to hundred standard scores after the raw scores were calculated. The correlation and chi square analysis were used for the evaluation of associations between variables, Mann-Whitney U and Kruskal-Wallis H tests for the comparisons of groups.

RESULTS: 89 % of 176 patients were women, 21.0% were men. Mean age was 58.0 ± 10.6 years. The 45.5% of the patients noted that they do regular FC, 79% check soles regularly, %25.6 check inside of shoes while 54% were noted that they walk barefoot in and outside of home. According to physical examination findings 50% of them had high risk for DF. 65% of them had not received any education about DM, 90.9% about DF and FC. The average knowledge score was 70.6 ± 21.1 , attitude and behavior score was 48.1 ± 13.3 out of 100. There was a positive correlation between knowledge scores and attitude and behavior scores. Attitude and behavior scores were high in patients whom were followed up 10-20 years, controlled regularly and who had high risk for DF. All scores were high in patients who had another DM patient in the family.

CONCLUSION: It was seen that diabetic patients did not received education about DF and FC, also did not practice even if their knowledge was enough.

Keywords: diabetic foot, knowledge, attitude, behavior

Distribution of knowledge and attitude and behaviour scores of patients



Associations between DF risk groups and knowledge, attitude and behaviour scores

	Risk for DF							<i>P</i>
		n	Mean	Med	Min	Max	SD	
Knowledge scores	Low risk	74	70.8	76.9	15.4	100.0	19.7	0.371
	Increased risk	88	70.3	76.9	7.7	100.0	21.9	
	High risk	14	71.4	76.9	7.7	92.3	24.6	
	Total	176	70.6	76.9	7.7	100.0	21.1	
Attitude and behaviour scores	Low risk	74	49.9	50.0	19.2	80.8	12.6	0.024*
	Increased risk	88	45.8	46.2	23.1	88.5	13.7	
	High risk	14	52.2	51.9	26.9	69.2	12.3	
	Total	176	48.1	50.0	19.2	88.5	13.3	

P-0047**Physical Activity Levels of Patients Admitted to Family Medicine Clinic**

Salih Zekeriya Karslıoğlu, Elif Altunbaş Ateş, Turan Set

Department of Family Medicine, Karadeniz Technical University, Trabzon, Turkey

AIM: Physical activity is one of the most important elements for healthy lifestyle. This study aimed to evaluate the physical activity level of the patients.

METHOD: Research was performed sectionally in 424 patients between May 2014 and February 2015 at Karadeniz Technical University Family Medicine Clinic. Questionnaire which includes demographic characteristics and physical activity level was administered face to face to participants. Physical activity status was categorized.

Patients were stated if body mass index (BMI) is <25 as normal, 25 to 29.9 as overweight and ≥ 30 as obese.

RESULTS: Female and male patients rates were 66.7% and 33.3% respectively. While 0.9% of patients were immobile, 91.5% were less mobile. The mean age of immobile and less mobile group was 40.1, of the mobile and much mobile group was 39.7 years ($p > 0.05$). The mean BMI of immobile and less mobile groups was 27.64; mean BMI of mobile and much mobile group was calculated 25.66 ($p = 0.064$). Obesity rate in immobile and less mobile group was 29.3%, obesity rate in the mobile and much mobile group was 12.5% ($p = 0.119$). The mean age of normal, overweight and obese patients were 36, 40.2 and 45.7 respectively ($P < 0.001$). All three groups were significantly different from each other in mean age ($p < 0.05$).

DISCUSSION: We are faced with a population of overweight and nonmobile. Today, decreased time devoted to physical activity. Stating no association between age and physical activity level implies the risk for obesity for young people. Taking precaution for obesity would be beneficial at a young age because reaching normal weight is very difficult for old people.

CONCLUSION: Physical activity has an important role in preventing disease and development of health and it should become a lifestyle. Because of this, comprehensive health care family physicians should educate individuals followed. In addition providing of physical activity opportunity in schools, residential areas and the municipal parking area would be useful.

Keywords: Physical activity, Body mass index, Family Medicine

P-0048**Reading concordance in hypertensive retinopathy with nonmydriatic fundus camera between general practitioners versus an ophthalmologist**

Rosa Forés¹, M^a Teresa Alzamora¹, M^a Mar Domingo¹, Anna Girona², Judit Llussà¹, Joaquim Fernández¹, Antonio Heras¹, Ana M^a Altaba¹

¹Institut Català de la Salut. Barcelona. Spain

²Hospital de Barcelona. Spain

Background & AIM: The evaluation of retinal changes associated with hypertension is so far a subjective and subject to the expertise and experience of the observer. The aim of this study is to assess the reading concordance in hypertensive retinopathy with nonmydriatic fundus camera between general practitioners versus a professional expert (ophthalmologist).

METHOD: Cross-sectional study of reading concordance in retinal changes. An ophthalmologist and 6 general practitioners (GP1 to GP 6) assessed retinal photography images of 775 hypertensive patients aged 50 to 70 years old made by nonmydriatic fundus camera. A learning workshops were previously performed. Retinal changes with the classification of Keith-Wagener were evaluated. Classifications obtained for each of the six family physicians with the ophthalmologist were compared. Index Kappa was calculated.

RESULTS: The Kappa indexes obtained in the severity levels were to GP 1: 0.311 (0.24 to 0.38), GP 2: 0.475 (0.41 to 0.54), GP 3: 0.429 (0.36 to 0.50), GP 4: 0.303 (0.25 -0.36), GP 5: 0.473 (0.41 0.54) and GP 6: 0.215 (0.16 to 0.27). All values were between 0.2 and 0.5 so that the agreement is low / poor.

CONCLUSIONS: Assessment of retinal lesions due to arterial hypertension by retinography presents a major problem of subjectivity. It would be necessary to incorporate a more objective assessment technique to improve these determinations.

Keywords: Arterial hypertension, Retinopathy, Concordance

Interobserver concordance Kappa coefficients and confidence intervals of 95% obtained in the evaluation of the fundus with reference to the expert ophthalmologist.

GP 1	GP 2	GP 3	GP 4	GP 5	GP 6
0.311	0.475	0.429	0.303	0.473	0.215
(0.24–0.38)	(0.41-0.54)	(0.36-0.50)	(0.25 -0.36)	(0.41 0.54)	(0.16-0.27)

P-0049

Evaluation of clinical practice in primary care on gout treatment

Ines Abreu Mendes¹, Mileta Gomes², Ieda Paula³

¹USF D.Sancho I - Aces Lezíria - Portugal

²UCSP Almeirim - Aces Lezíria – Portugal

³USF Cynthia - Aces Sintra - Portugal

The gout prevalence has doubled in recent decades and we must optimize its management.

We studied a sample of patients with gout, in different disease's stages, quantifying the number with associated pathologies and identifying the takings medicine that could modify uricemia values.

METHODS: Retrospective study of gout diagnosed patients in files of three family doctors.

Variables: gender, age, uricemia year follow-up stages: initial uricemia (T0), after hipouricemic therapy within less than 6 months (T1) and last uricemia value (T2).

From 5713 patients, 80 (1.4%) were diagnosed gout. The average age with gout is 63.1 years and consists of 72 men. The average follow up of men was 8.44 years and 7.25 for women.

The uricemia at T0 was 72.5% above 8mg/dl and T1 uricemia were 27.5% below 6 mg / dl and 7.5% above 8 mg / dl. There was a significant drop in uricemia values from T0 to T1 ($p < 0.001$) and from T0 to T2 ($p < 0.001$). Between T1 and T2 was a significant increase in uricemia values ($p = 0.039$). This could be due to less continuity in gout cronic treatment.

Comorbidities: 25% of patients with type 2 diabetes mellitus, 70% hypertension, 15% renal calculi, 37.5% overweighted, 51% obesity, 37.5% mixed dyslipidemia, 35% hypertriglyceridemia and 7,5% hypercholesterolemia. Gout therapy used: NSAIDs in 95% of patients, allopurinol in 95% (2.5% had allergy to allopurinol), colchicine in 42.5%.

Of remaining chronic medication, 47.5% of patients were treated with diuretics and 50% with a statin, both drugs with hiperuricemic potential.

This sample characterization allowed the identification of potential improvements in monitoring and treatment of gout and its comorbidities. Vigilance and therapy adherence are fundamental to achieve the therapeutic goals.

When it's possible, hypertension and dyslipidemia should be treated with drugs, such as fenofibrate, losartan and amlodipine, by their hipouricemic effect.

Keywords: Gout treatment, comorbidities, management

P-0050

Evaluation of Serum Uric Acid Levels and Cardiovascular Risk Factors in Patients with Cardiovascular Disease

Hasan Ayberk Çakırlar¹, Didem Kafadar¹, Süleyman Sezai Yıldız², Mustafa Hakan Dinçkal²

¹Department of Family Medicine, Bağcılar Training and Research Hospital, Istanbul, Turkey

²Department of Cardiology, Bağcılar Training and Research Hospital, Istanbul, Turkey

Background & AIM: In this study, our aim was to evaluate the relationship between uric acid levels and cardiovascular risk factors and severity of coronary artery disease(CAD) in patients with cardiovascular diseases by analyzing laboratory values and comorbidities of patients such as hypertension, dyslipidemia and metabolic syndrome.

METHOD: 418 patients, 149 women and 269 men, who have admitted to cardiology and emergency outpatient clinics of our hospital between 01.01.2013 and 31.07.2014 were included to this retrospective study. In these patients, serum uric acid levels were present before coronary angiography was performed. In women, uric acid levels ≥ 6 mg/dL and in men ≥ 7 mg/dL were considered as hyperuricemia. Gensini Score(GS) was used to evaluate the angiographies. Patients were considered as having serious CAD if they had $GS \geq 20$. Laboratory values and CAD data of the patients were evaluated retrospectively.

RESULTS: In patients with higher uric acid levels, mean age was statistically more than patients with lower uric acid levels($p=0,003$). Women with high uric acid levels were statistically more than men with high uric acid levels($p<0,001$). Men with $GS \geq 20$ were more than women with $GS \geq 20$ ($p=0,016$). In patients with serious CAD according to gensini score, glucose ($p=0,003$), HbA1c ($p=0,012$), creatine ($p=0,003$) mean values were statistically higher than patients with $GS<20$. HDL levels were statistically lower in patients with serious CAD($p=0,038$). When patients were grouped according to uric acid levels, there was no significant difference between GS groups of patients ($p=0,59$).

CONCLUSIONS: Coexistence of hyperuricemia with other CAD risk factors such as hypertension, diabetes, obesity, dyslipidemia, smoking, and age remains the most important handicap in evaluating high uric acid values. We may conclude that uric acid is a marker of metabolic burden rather than being an independent risk factor for CAD. Prospective studies in large groups are still needed.

Keywords: Uric acid, coronary artery disease, cardiovascular risk factors, coronary angiography

P-0051

Prevalence of chronic non-communicable diseases in family medicine practice

Olivera Batic Mujanovic¹, Larisa Gavran², Lejla Kunosic³, Lejla Piric⁴, Munevera Becarevic⁵, Esad Alibasic⁴

¹Family Medicine Teaching Center of Health Center Tuzla; Department of Family Medicine, Medical Faculty of Tuzla University, Tuzla, Bosnia and Herzegovina

²Family Medicine Teaching Center Zenica, Zenica, Bosnia and Herzegovina

³Health Center Teocak

⁴Health Center Kalesija, Kalesija, Bosnia and Herzegovina

⁵Health Center Banovici, Banovici, Bosnia and Herzegovina

Background & AIM: Chronic non-communicable diseases account for almost 60% of global mortality, and 80% of deaths from chronic non-communicable diseases occur in low and middle income countries. The aim of this study was to investigate prevalence of four main types of chronic non-communicable diseases in family medicine practice.

METHODS: This study included 580/1492 medical records of patients with chronic non-communicable diseases registered in family medicine team at the Family Medicine Teaching Center Tuzla. We analyzed prevalence of modifiable risk factors for chronic non-communicable diseases (high blood pressure, obesity and smoking) and main types of chronic non-communicable diseases (cardiovascular diseases, cancers, chronic respiratory diseases and diabetes).

RESULTS: Prevalence of chronic non-communicable diseases was 38.87% (580/1492). Mean age of participants was 60.282 ± 14.95 years; 60.12 ± 16.01 years for women and 60.44 ± 13.89 years for men ($p=1$). There were significantly more women with diagnosis of chronic non-communicable diseases than men (66.55% vs. 33.45%;

p<0.0001). Majority of patients belonged to the age group 60-80 years (49.48%), 34.31% belonged to the age group 40-60 years, 11.55% belonged to the age group 10-40 years, and only 4.65% of patients were older than 80 year. Hypertension had 404 patients (69.66%), 392 patients (67.59%) were overweight or obese, and 202 patients (34.83%) smoked. Diagnosis of cardiovascular diseases had 162 patients (27.93%), cancers were diagnosed in 43 patients (7.23%), diabetes had 76 patients (13.1%), while 94 patients (16.21%) had chronic respiratory diseases. More than third of patients had some of the musculoskeletal diseases (38.44%), and 11.89% of patients had thyroid gland diseases.

CONCLUSION: Results of this study showed a high prevalence of chronic non-communicable diseases in primary health care, especially cardiovascular diseases. Healthy lifestyle including functional food, regular physical activity and a non-smoking policy is one of the most promising factors in primary and secondary prevention of chronic non-communicable diseases.

Keywords: chronic non-communicable diseases, family medicine

Figure 1. Prevalence of chronic non-communicable diseases in family medicine team

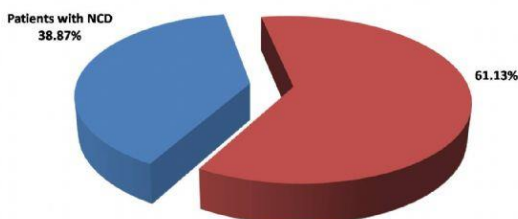


Figure 2. Distribution of patients related to gender

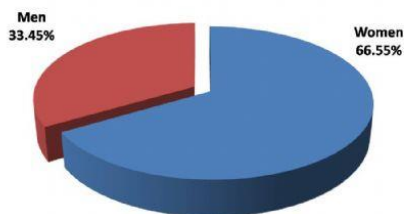


Figure 3. Distribution of patients related to age

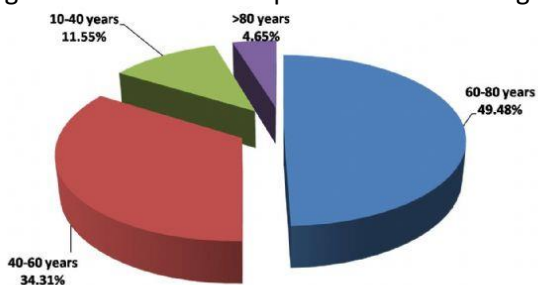
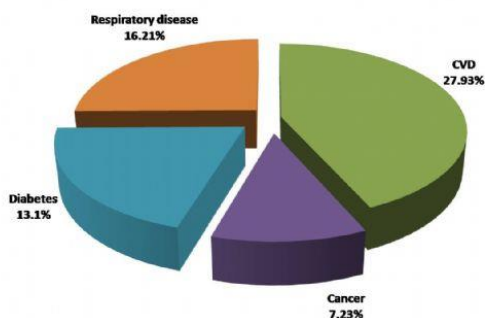


Figure 4. Distribution of patients related to main chronic non-communicable diseases



P-0052

Differential diagnostic of hand osteoarthritis

Sara Matos Moreira, Gabriela Silva Poças, Luis Monteiro Magalhães
 USF Leça, Unidade Local de Saúde de Matosinhos, Matosinhos, Porto, Portugal

BACKGROUND

Hands are frequent sites of loco-regional disease. They are very rich sources of information and may represent a rheumatic patient’s business card.

Hand Osteoarthritis is a heterogeneous condition of high prevalence with a negative impact in the quality of life.

AIM

Review the available knowledge about the differential diagnosis of hand osteoarthritis.

METHOD

Literature review in medical databases based on evidence, using MeSH terms: osteoarthritis, hand.

RESULTS

To date, there is no gold standard for the hand osteoarthritis diagnosis. The differential diagnosis of this entity with other arthropathies must take into account several factors, including clinical manifestations, risk factors (age and gender), onset and progression of symptoms, degree of rigidity, joints involved, presence of Heberden and Bouchard nodes, synovitis signs, joint damage, without neglecting the contribution of imaging and laboratory findings.

The differential diagnosis of hand OA is extensive. In general practice, predominates, Carpal Tunnel Syndrome followed by De Quervain's tendonitis.

The most common disorders are Psoriatic Arthritis (distal interphalangeal joints or just a distance), Rheumatoid Arthritis (metacarpalphalangeal, proximal interphalangeal and wrists), Gouty Arthritis (may override the pre-existing osteoarthritis) and Hemochromatosis (metacarpophalangeal and wrists). It is important to highlight that most systemic rheumatic diseases have in the hands, significant and often diagnostic translation.

CONCLUSIONS

Despite hand osteoarthritis having a high worldwide prevalence with high levels of disability, resulting in absenteeism and early retirement, with a significant impact on the patient and family quality of life, as well as the social and economic level, research in this area is still very limited.

Keywords: osteoarthritis, hand

Differential Diagnosis of Hand Arthropathies

DIAGNOSIS	CLINICAL MANIFESTATIONS
Carpal Tunnel Syndrome	Hand paresthesias in the median nerve area. Predominance in the morning and during the night. Positive Tinel’s sign and Phalen’s tests.
Cubital Tunnel Syndrome	Ulnar paresthesias in the edge of the forearm and hand. Positive Tinel’s sign over the cubital tunnel in the elbow or in Guyon's canal.

De Quervain's Tenosynovitis	Pain in the outer edge of the wrist and thumb. Mechanical rhythm. Painful palpation site. Positive finkelstein's test.
Flexor Tenosynovitis	Inflammatory or mechanical pain. Active finger flexion limitation. Trigger finger.
Dupuytren's Contracture	Palmar fascia retraction of the 3rd, 4th or 5th fingers.
Rhizarthrosis	Mechanical pain at the base of the thumb and radial edge of the handle.
Nodal Osteoarthritis	Mixed rhythm pain. Proximal and distal interphalangeal. Firm joint nodules.
Arthritis	Inflammatory pain. Hard-elastic joint swelling.

P-0053

Approach on vertigo in primary health care

Sara Matos Moreira, Gabriela Silva Poças, Luis Monteiro Magalhães
USF Leça, Unidade Local de Saúde de Matosinhos, Matosinhos, Porto, Portugal

BACKGROUND

Vertigo corresponds to 54% of the cases of dizziness in primary health care. In these, 85-90% is due to a vestibular system pathology, being the benign paroxysmal positional vertigo the most common, followed by Meniere's disease and vestibular neuritis.

AIM: Review the available knowledge on the management of vertigo in primary health care.

METHOD: Literature review in medical databases based on evidence, using the MeSH terms: peripheral vertigo, primary care.

RESULTS: In vertigo's differential diagnosis it is important to specify the duration of attacks, presentation, character and intensity, triggers, associated symptoms (ear and neurovegetative or neurological). It is also relevant to inquire history of cardiovascular, renal, diabetes, neurological diseases, syphilis, ototoxic drugs and head injury.

A detailed medical history with the comprehensive characterization of symptoms is critical to differentiate the peripheral etiology from the central (consult table), without neglecting the importance of a careful and directed physical examination, which should include the otoscopy, acumeny, neurological and cardiovascular examination; it also includes the vestibular exam, with a vestibular-spinal and vestibular-ocular function assessment, presence of nystagmus with and without ocular fixation.

The diagnosis of the entities responsible for peripheral vertigo syndrome is clinical. Ponder using complementary diagnostic procedures in the presence of an atypical clinical case which may suggest other etiology.

The symptomatic treatment of vertigo should have a short time, serving only as a way for the patient to tolerate the vestibular rehabilitation exercises, which will be the definitive treatment.

CONCLUSIONS: The diagnosis is essentially clinical, with approach and treatment within reach of primary health care, but it is crucial to adopt a systematic approach to exclude central pathology. The referral to other specialties should be reserved for the most serious cases which exceed the ability of resolution by the family physician.

Keywords: peripheral vertigo, primary care

Vertigo's Differential Diagnosis

	PERIPHERAL	CENTRAL
ANATOMY	Injury to the vestibular nerve or labyrinth	Injury from the vestibular nucleus
BEGIN	Sudden	Insidious
CHARACTER	Paroxistic (compensation)	Continuous
INTENSITY	Intense	Light

DURATION	Finite but recurrent Seconds, min., hours a days	Chronic Months without compensation
ASSOCIATED SYMPTOMS	Hearing loss, tinnitus, hearing pressure, intense neurovegetative symptoms (nausea, vomiting, diaphoresis)	Neurological and vascular symptoms Lack of hearing symptoms or marked neurovegetative symptoms
AGGRAVATING FACTORS	Head movements (intense aggravation)	Head movements (Slight increase)
CALORIC REACTIONS	Normal or reduced	Standard, rarely dissociated
DIRECTION OF THE FALL	Tendency to unilateral	To both sides
ROMBERG TEST	Unidirectional (coherent)	Multidirectional (incoherent)
NYSTAGMUS	Horizontal Unidirectional with fast phase opposite to the lesion Seconds after vertigo, (5-12 second time latency) Fatigable disappears in days, decreases with eye fixation	Vertical Unidirectional or bidirectional Instant start, non fatigable, from weeks to months, not influenced by eye fixation

P-0054

Knee Osteoarthritis in Primary care patients

Patricia Marquez¹, Jose M Segura², Delia Rodriguez², Maria Del Carmen Fernandez²

¹Clinica Cajal, Las Palmas de Gran Canaria, Spain

²Centro de salud Canalejas, Las Palmas de Gran Canaria, Spain

Introduction/ OBJECTIVE:

The knee is one of the joints most commonly affected by osteoarthritis and second most common cause of musculoskeletal consultation in primary care. As this joint takes an important role in walking, any pain or disability affects a person's daily life activities. The aim of our study is to determine in a period of time from the 1st June 2014 and 30th November 2014 in a Primary Care centre of the island of Gran Canaria, the number of adults, above 50 years old, being radiologically diagnosed of bilateral knee osteoarthritis, its level of knee pain, functional disability measured with VAS and WOMAC score.

METHODS: An observational, descriptive and retrospective study was designed. The data was collected from the electronic clinical registries in a Primary care centre.

RESULTS: 300 cases were studied, 78,2 % women and 22,8% men, with an average age of 69,5 years old, with BMI between 25-29,9: overweight 58% and above 30: obese (33%). In the VAS 55,8% moderate pain (45–74 mm), 27,5% mild pain (5-44mm) 16,7% severe pain (75–100 mm). With the WOMAC score the most affected activity 80,9% was walking up/down stairs followed by 77,5% rising from sitting and standing upright 67,5%.

CONCLUSION: The importance in of knee osteoarthritis in primary care due to its prevalence and the use of simple questionnaires to evaluate level of knee pain and disability in daily life of our patients, to avoid chronicity and evaluate effectiveness of treatment prescribed.

Keywords: Bilateral, Knee, osteoarthritis, VAS, WOMAC, Primary care

P-0055

Cases of Systemic Lupus Erythematosus: The Role and Importance of Physical Examination in Family Physician

Ömer Akca¹, Adem Bahadır¹, Turgay Albayrak⁴, Iskender Bülbül¹, Ihsan Ateş², Tarık Eren Yılmaz¹, İrfan Şencan¹, İsmail Kasım¹, Rabia Kahveci¹, Adem Özkara³

¹Department of Family Medicine, Ankara Numune Training and Research Hospital, Ankara, Turkey

²Department of Internal Medicine, Ankara Numune Training and Research Hospital, Ankara, Turkey

³Department of Family Medicine, Çorum Hittite University, Çorum, Turkey

⁴Department of Family Medicine, Dr. Abdurrahman Yurtaslan Training and Research Hospital, Ankara, Turkey

In United States one of every seven patients apply to the family physician with musculoskeletal complaints. Some of these patients have rheumatologic diseases which is chronic and causes loss of workforce. So it is very important to diagnosis and provide treatment.

Twenty-four years old female patient applied with complaints of asthenia and fatigue. Anemia and symptomatic treatment was given before where the patient applied with these complaints. It was learned from the anamnesis that there have been widespread pain in major joints, increasing rash on the face when get the sunshine and frequently recurring sores in mouth and genital area. On physical examination, hair loss, joint swelling, arthritis, Reynold's positivity, stomatitis and genital ulcers were detected. There was rubescence (photosensitivity) compatible with typical rash on her face. Tests aimed at diagnosis were asked on suspicion of there may be a rheumatic disease. In laboratory tests:

ANA:2++, dsDNA:25.2(+), pANCA+, MA/creatinine:106.03. Anti scl:70, Rose Bengal burecell scanning, grub Widal, Anti-sm anti-cm/RNP, anti-ssA, anti-ssB, anti-Jo-1, c-ANCA results were negative.

The patient was referred to rheumatology clinic with the pre-diagnosis of systemic lupus erythematosus according to examination and blood test results. Patient whose diagnosis confirmed in rheumatology, was hospitalized and her treatment was started. The patient is still following-up from rheumatology department, during her follow-up she became pregnant and gave a healthy birth. Missing or late diagnosis of rheumatic diseases, affects the patient's life and quality of life in a negatively way. As the family physicians serve a wide mass in terms of patient and disease, they should have minimal extent knowledge of rheumatic diseases as in other diseases. As in our case early diagnosis, follow-up and treatment of the disease contribute to lead more healthy and quality life in patients' social life. If the patient was not early diagnosed and did not passed a followed-up pregnant, patient could have; nephritis, kidney failure, stroke, vasculitis, anemia, pericarditis, pneumonia, born child could have; developing neonatal lupus, neonatal heart block, skin rash, liver abnormalities.

Keywords: Systemic Lupus Erythematosus, rheumatology, neonatal lupus

P-0056

Insulin resistance and increased cardiovascular risk in newly diagnosed hypertensive patients who were admitted to nephrology clinic

Tuba Dilek Ateş¹, Kenan Topal¹, Sibel Ada²

¹Adana Numune Research and Training Hospital, Department of Family Medicine

²Adana Numune Research and Training Hospital, Department of Nephrology

BACKGROUND: Cardiovascular disease (CVD) is the main leading cause of death in our country. The risk factors like hypertension, diabetes, metabolic syndrome, dyslipidemia should be controlled to reduce CVD. Insulin resistance (IR) has an important role in the pathophysiology of these risk factors. We investigated the presence of the other components of metabolic syndrome in patients with newly diagnosed essential hypertension. Specifically, we aimed to determine the relationship between hypertension and IR.

METHOD: This cross-sectional study included 128 newly diagnosed essential hypertension patients aged between 18-55 years who were admitted to Nephrology Clinic between 01.07.2014-31.01.2015. The patients were analysed for metabolic syndrome criteria, IR and CVD risk after sociodemographic data had been collected, anthropometric measurements and blood pressure staging had been done.

RESULTS: Of 125 patients, 65 were female; mean age was 42.3±7.8 years. Blood pressure was classified as first degree (n=46, 35.9%), second degree (n=55, 43%), and third degree (n=27, 21.1%). IR was detected in 66 patients

(51.6%). Eighty third patients (64.8%) had metabolic syndrome, %57.8 of metabolic syndrome patients and 40% of non-metabolic syndrome patients had IR. Also IR was detected in 2 patients (12.5%) with normal body mass index in 24 overweight patients (55.8%) and in 40 obese patients (58%). According to the 2013 ESH hypertension guidelines, CVD risk status was evaluated in six groups (low risk: 1, very high risk: 6). CVD risk score was significantly higher in patients with IR (4.02 ± 0.984 vs 3.58 ± 0.915). The difference between IR and CVD risk score elevation was statistically significant ($t: -2.582, p=0.011$).

CONCLUSIONS: We found a high rate of IR in newly diagnosed hypertensive patients. CVD risk score was higher than that of the hypertensive patients without IR.

Keywords: Insulin Resistance, Metabolic Syndrome, Hypertension, Cardiovascular Disease

P-0057

How do we manage chronic respiratory diseases in family medicine practice?

Olivera Batic Mujanovic¹, Larisa Gavran², Enisa Alic Pasalic³, Edita Cerni Obrdalj⁴, Amra Zalihic⁴

¹Family Medicine Teaching Center of Health Centre Tuzla; Department of Family Medicine, Medical Faculty of Tuzla University, Tuzla, Bosnia and Herzegovina

²Family Medicine Teaching Center of Health Center Zenica, Zenica, Bosnia and Herzegovina

³Health Center Gradacac, Gradacac, Bosnia and Herzegovina

⁴Family Medicine Teaching Center of Health Center Mostar, Mostar, Bosnia and Herzegovina

Background & AIM: Prevention and management of chronic non-communicable diseases are the main goals in family medicine practice. Aim of this study was to assess quality of chronic respiratory diseases care provided by family medicine team through a medical audit.

METHODS: This retrospective analysis included 44/1492 medical charts of patients with chronic respiratory diseases: chronic obstructive pulmonary disease (COPD) and asthma at the Family Medicine Teaching Centre Tuzla. Audit record form contained questions on gender, age, smoking status, advice to stop smoking, spirometry, and prescribed medications.

RESULTS: Prevalence of chronic respiratory diseases were 2.95%, without significantly difference between men and women (47.73% vs. 52.27%; $p=0.67$). Significantly more patients had COPD than asthma (81.82% vs. 18.18%; $p<0.0001$). COPD had 50% men and 50% women, while 62.5% women and 37.5% men had asthma, without significant differences related to gender ($p=1$; $p=0.3173$). Mean age of patients with COPD was 65.38 ± 7.26 years, and for asthma 23.34 ± 6.89 years. There were 38.89% smokers, 27.79% ex smokers and 30.55% never smokers in COPD group. All patients with asthma had never smoked. Smoking status was recorded for 93.18% patients. Stop smoking advice was given for 58.33% patients with COPD. Pulmonologist report was recorded significantly more in patients with asthma than COPD (100% vs. 69.44%; $p=0.0001$), but spirometry was recorded significantly more in patients with COPD than asthma (69.44% vs. 25%; $p=0.0195$). Majority of patients used beta2-agonists (75%), glucocorticoid used 22.73%, combined beta2-agonist and glucocorticoid used 31.82%, and anticholinergic therapy used 22.73% of patients. Leukotriene receptor antagonist used 50% of patients with asthma. Methylxanthine drug (teophylline) used 8.33 patients with COPD.

CONCLUSION: Results of this study showed a high prevalence of deficiencies in quality of care for chronic respiratory diseases in family medicine that suggests actions to prevent and control chronic respiratory diseases in primary health care.

Keywords: chronic respiratory diseases, family medicine

Figure 1. Distribution of patients with chronic respiratory disease

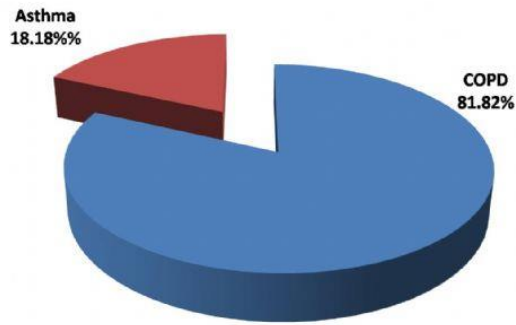
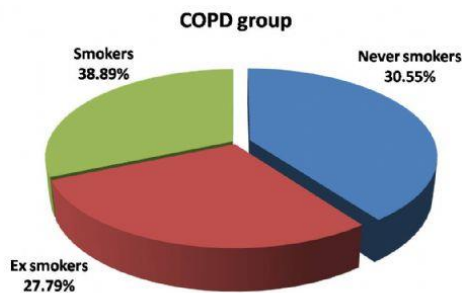


Figure 2. Smoking status of patients with COPD



P-0058

Control of old hypertensive patients with comorbidities

Pedro Alejandro Gonzales Flores, Silvia Sanchez Casco, Monica Pons Querol, Ione Veronica Mejia Ganoza, Giancarlo Jesús Ormeño Victorero
Catalan Health Institute, CAP Les Fontetes, Cerdanyola del Vallès, Barcelona, Spain

OBJECTIVES

- 1.To determine the degree of control of the patients with High Blood Pressure in the CAP Les Fontetes.
- 2.To determine the presence of diabetes in these patients and to assess its control.
- 3.To determine the main TOI (Target organ injury) of studied patients and the established cardiovascular disease (ECD)

METHODOLOGY

Patients with HBP of the CAP FONTETES (Cerdanyola del Vallès. Barcelona) was studied in a descriptive and cross. Were chosen 583 (80%). The two guides used were one of the Catalan Health Institute (ICS) and the another one of the European Hypertension Society (EHS). The TOI, the presence of diabetes and established Cardiovascular disease and its respective control were determined. Results were processed using the SPSS system.

RESULTS

Prevalence of hypertension was 46.3%. We selected 583 patients (80.2%). 341 were women (58.5%). The degree of control was 59.5% and 69.9% according the used guide. 162 had diabetes (27.8%) being the control right in 64.2% and 74.1% (ICS and ESH guide). The TIO were 22 left Ventricular hypertrophy and Microalbuminuria 28 (4.8% and 3.77%), and their control were 50% and 72,7% (ICS) and 60,7% and 81,8% (EHS). Established cardiovascular disease were: heart disease 82 (14.07%), kidney failure, 67 (11.49%), AVC 27 (4.63%), arterial disease 15 (2.57%). Patients with ECD control was: 64.3% heart disease, Chronic Renal Failure 56.7%, AVC 74.1% and arterial disease 66.7% (ICS Guide) and 75.6%, 66.6% and 85.2%, and 80% (EHS guide)

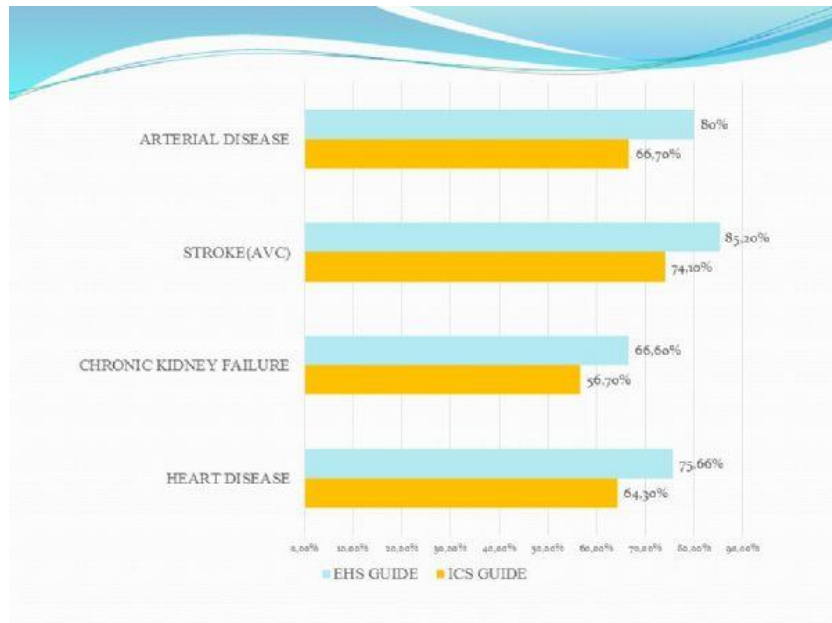
CONCLUSIONS

- 1.The degree of control was 59.5% (ICS) and 69.9% (ESH)
2. Presence of diabetes mellitus was 162 (27.8%) being controlled by 64.2% and 74.1% according the guide used.

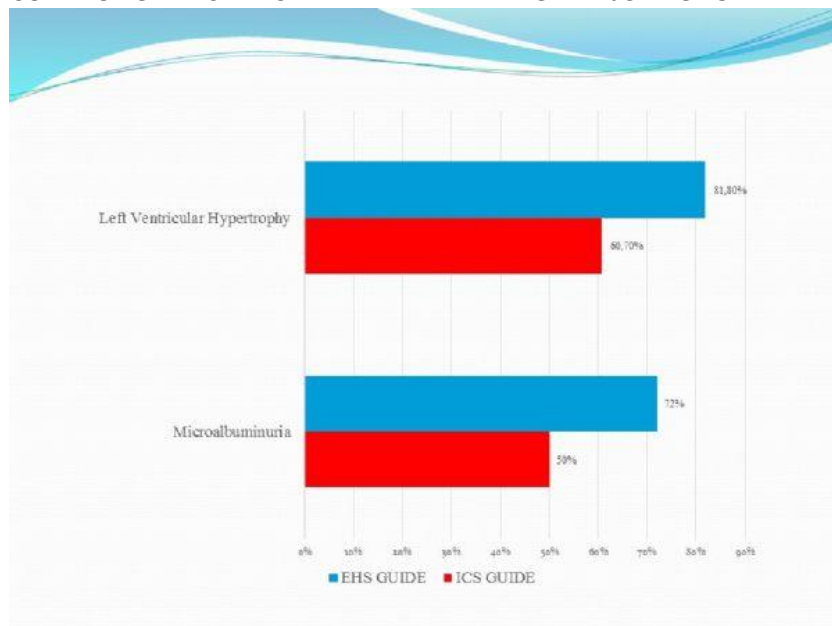
- 3. Control of the patient with TOI: Microalbuminuria and LVH is 50% and 72%
- 4. Control of heart disease 64.3%, 56.7% Chronic Renal Failure, AVC 74.1% and 66.7% arteriopathy. No differences with the literature

Keywords: High Blood Pressure, Target organ injury, Established Cardiovascular Disease

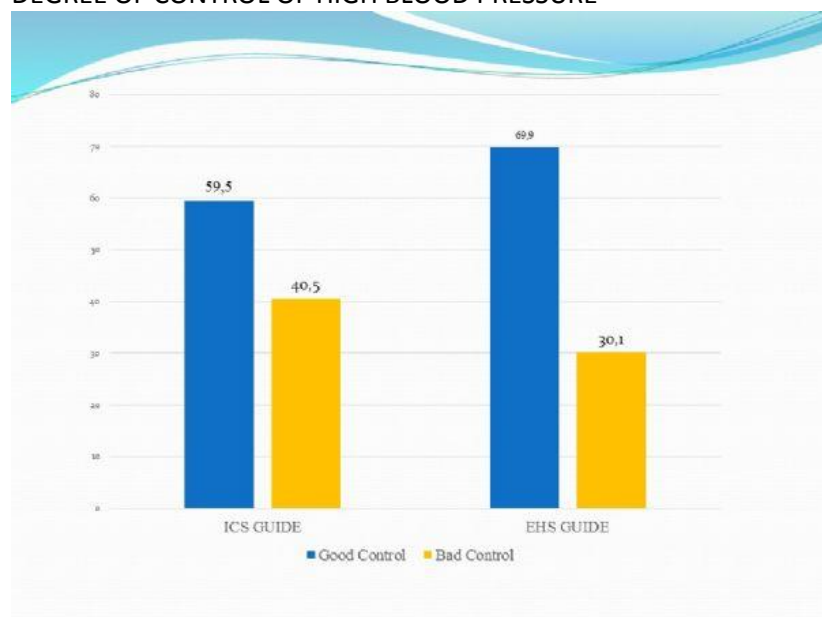
CONTROL OF HBP IN PATIENTS WITH ESTABLISHED CARDIOVASCULAR DISEASE



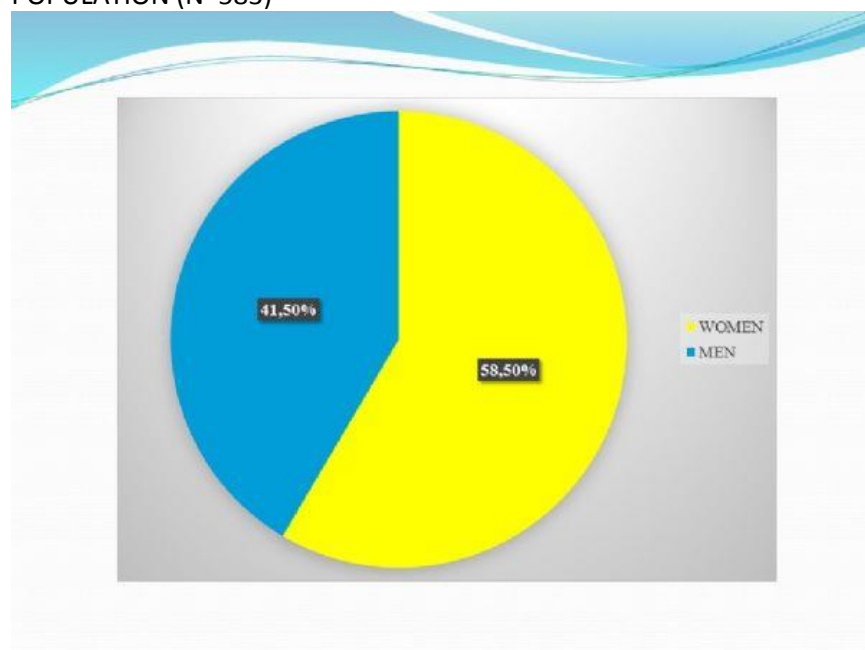
CONTROL OF PATIENTS WITH HBP AND TARGET INJURY ORGAN



DEGREE OF CONTROL OF HIGH BLOOD PRESSURE



POPULATION (N=583)



P-0059

Control of the old hypertensive patient

Pedro Alejandro Gonzales Flores, Silvia Sanchez Casco, Pablo Rubinstein Aguñin, Monica Pons Querol
Catalan Health Institute, CAP Les Fontetes, Cerdanyola del Vallès, Barcelona, Spain

OBJECTIVES

1. To determine the degree of control of the patients older than 65 with HBP in one centres of primary care.
- 2 To. Compare, if there are differences, with the application of the guide of the ICS and the ESH Guide.
- 3 To determine what kinds of treatment we use for the control of the patient with HBP.

METHODOLOGY

Patients with HBP CAP Fontetes (Cerdanyola del Vallès). Were chosen 583 of 727 patients with HBP. As good control was established the number of TA < 140/90 as indicated in the ICS and the limit of 150/90 according to the guide of the ESH in elderly people. The patients were divided into 3 age groups; 65, 65-79 and 80 years old. The results were processed using the SPSS system version 4.0

RESULTS

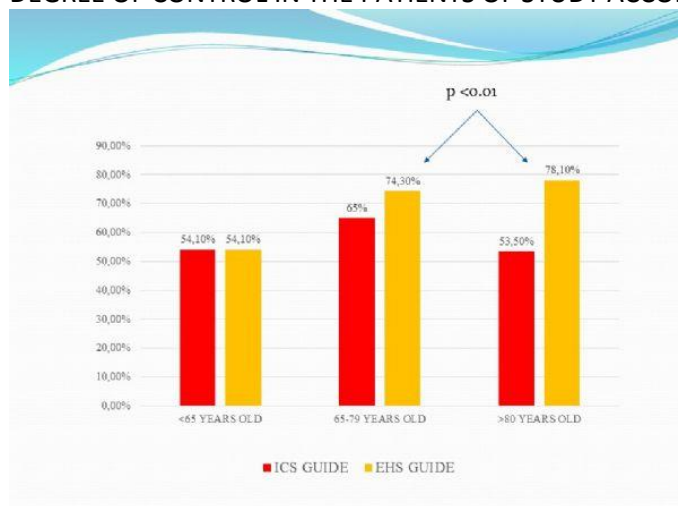
Prevalence of HBP was 46.3%. We selected 58 (80.2%). 341 were women (58.5%). 109 were under 65 years (18.7%), 300 between 65-79 (51.5%) and 174 older that 80 years old (29.8%). The main treatments were: ARA II 96 diuretics (16.47%), ACE diuretic 93 (15.95%), Aceis 81 (13.89%), ARA II 46 (7.89%), diuretics 34 (5.83%) and other 116 (19.90%). The degree of control by the ICS guide was 59.5% (347) and using the ESH guide 69.9% (408). In the patients control; 65 65 to 79 years old and 80 years old was 54.1%, 65% and 53.5% respectively using the ICS guidelines, while if we use the guide of the SEH control was 54.1%, 74.3% and 78,1% respectively ($p = 0.01$)

CONCLUSIONS

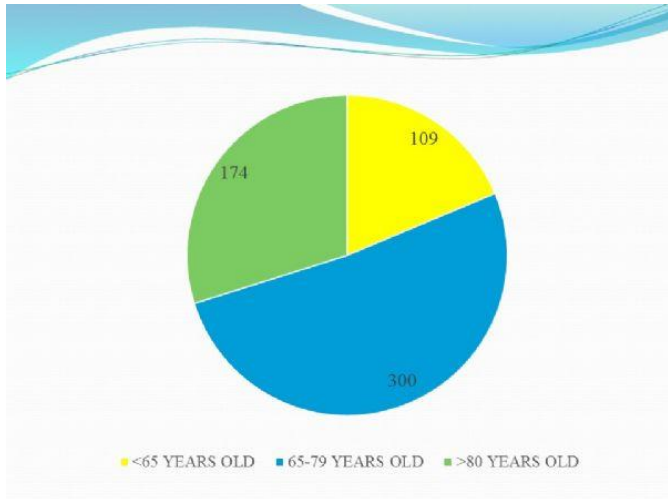
1. There is variability with respect to different treatments used for the treatment
2. The degree of control of hypertension was 59.5% and 69.9% (ICS vs EHS guide)
3. The population older than 65 years old is properly controlled, even reaching the 78.1% if we adjust the data to guide the SEH

Keywords: High Blood Pressure, Control of HBP, Older people

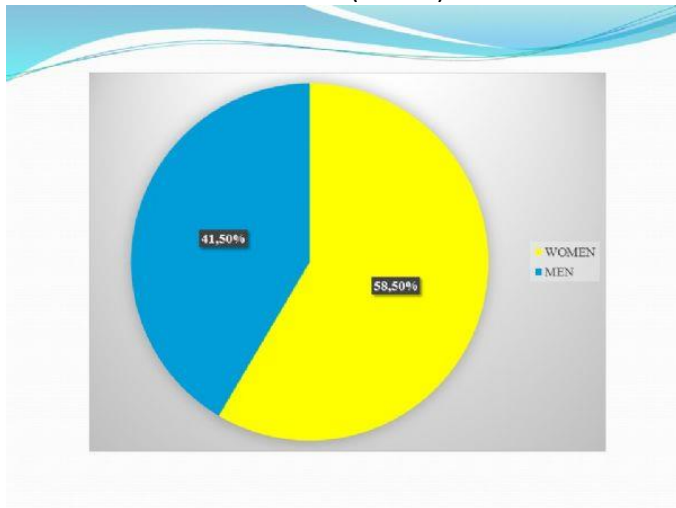
DEGREE OF CONTROL IN THE PATIENTS OF STUDY ACCORDING THE AGE



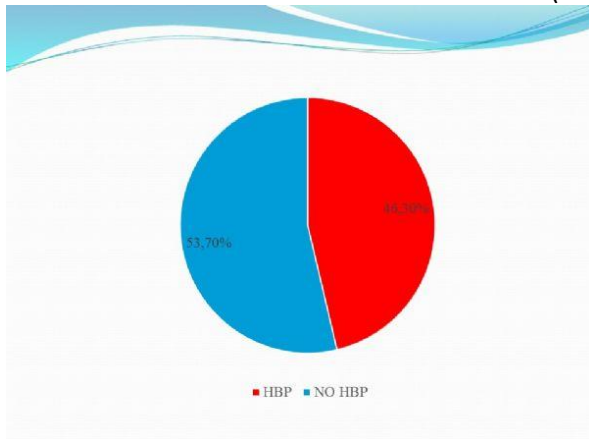
DISTRIBUTION OF PATIENTS ACCORDING THE AGE



POPULATION OF THE STUDY (N=583)



PREVALENCE OF THE HIGH BLOOD PRESSURE (HBP) IN THE POPULATION OF STUDY



P-0060

Assessment of Diabetic Nephropathy in Patients with Diabetes Mellitus at Vilnius Outpatient Clinics

Monika Niedvaraitė¹, Zdrune Visockienė¹, Laura Siaulienė³, Margarita Lasevic¹, Estera Muchlyte¹, Asta Sakaite¹, Daura Raudonyte¹, Dalia Palisaityte¹, Rima Povilioniene¹, Ruta Baneviciute Domarkiene¹, Roma Puronaite², Vytautas Kasiulevicius¹, Virginijus Sapoka¹

¹Vilnius University Faculty of Medicine, Vilnius, Lithuania

²Vilnius University Hospital Santariskiu Klinikos, Vilnius, Lithuania

³Karoliniskiu Outpatient Clinic, Vilnius, Lithuania

BACKGROUND AND AIM: Diabetic nephropathy (DN) is the leading cause of renal failure in patients with diabetes. Regular outpatient follow-up is key in managing DN successfully. The aim of our study was to assess the annual screening for DN and the incidence of DN in patients with type 1 diabetes mellitus (T1DM) and type 2 diabetes mellitus (T2DM) at Vilnius outpatient clinics.

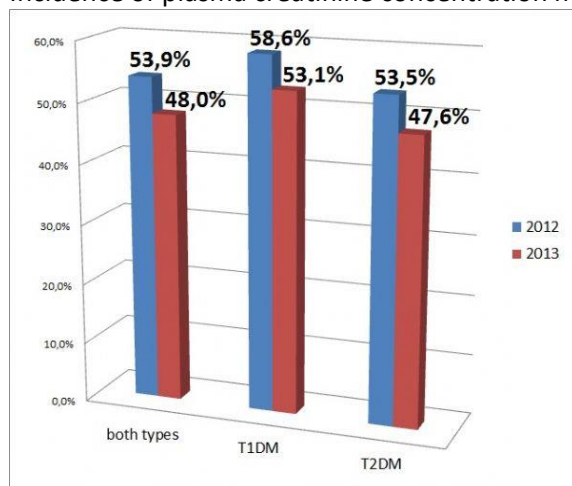
METHODS: A retrospective collection of data covering the period from 2012 to 2013 was performed in 5 largest Vilnius outpatient clinics. There were 1719 adult patients with T1DM and T2DM randomly selected. Information on basic patient's characteristics, diabetes type, duration of disease, annual assessment of plasma creatinine concentration, urinary albumin-to-creatinine ratio or microalbuminuria, presence of diagnosed DN was collected from clinical notes and electronic database system.

RESULTS: There were 7,4% of T1DM and 92,6% of T2DM in the group of 1719 patients, 58,9% were females. The mean age of subjects was 64±13,4 years, average duration of diabetes - 8,1±6,9 years. Plasma creatinine concentration was measured in 53,9% of patients (58,6% in T1DM; 53,5% in T2DM) in 2012 and in 48,0% (53,1% in T1DM; 47,6% in T2DM) in 2013. Urinary albumin-to-creatinine ratio or microalbuminuria was measured in 9,4% of patients (32,8% in T1DM; 7,5% in T2DM) in 2012 and 9,9% (29,7% in T1DM; 8,3% in T2DM) in 2013. Diabetic nephropathy was diagnosed in 8,4% of subjects in the whole group (21,1% in T1DM and 7,4% in T2DM).

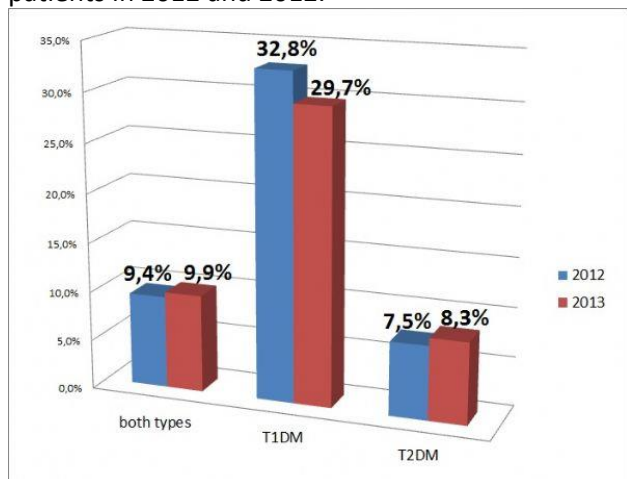
CONCLUSIONS: Our study revealed a quite high rate of diabetic nephropathy and poor annual monitoring for renal complications in patients with type 1 and type 2 diabetes at Vilnius outpatient clinics. Probably, certain amount of diabetic kidney disease remained undiagnosed, because of inadequate screening. Family doctors have to put more efforts in performing screening for diabetic nephropathy in every patient with diabetes.

Keywords: diabetes mellitus, primary care, diabetic nephropathy

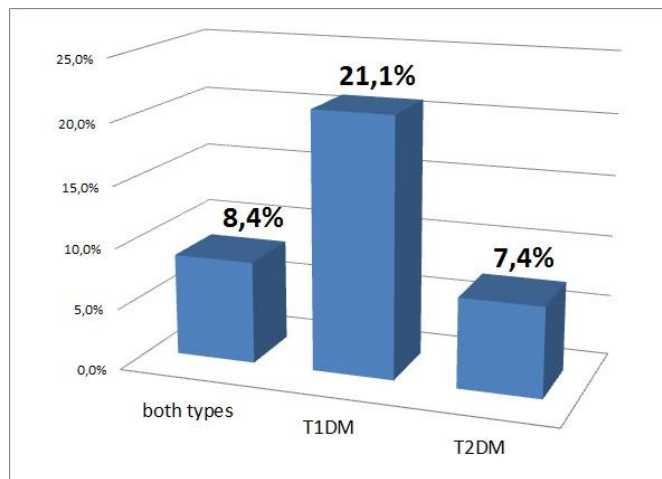
Incidence of plasma creatinine concentration measurement in T1DM and T2DM patients in 2012 and 2013.



Incidence of urinary albumin-to-creatinine ratio or microalbuminuria measurement in T1DM and T2DM patients in 2012 and 2013.



Incidence of diabetic nephropathy.



P-0061

Association of Glycated Hemoglobin, Complications and Disease Duration in Type 2 Diabetes Subjects at Vilnius Outpatient Clinics

Estera Muchlyte¹, Zydrune Visockiene¹, Laura Siaulienė³, Asta Sakaite¹, Daura Raudonyte¹, Dalia Palisaityte¹, Monika Niedvaraitė¹, Margarita Lasevic¹, Rima Povilioniene¹, Ruta Baneviciute Domarkiene¹, Roma Puronaite², Virginijus Sapoka¹, Vytautas Kasiulevicius¹

¹Vilnius University, Faculty of Medicine, Vilnius, Lithuania

²Vilnius University Hospital Santariskiu Klinikos, Vilnius, Lithuania

³Karoliniskiu Outpatient Clinic, Vilnius, Lithuania

BACKGROUND AND AIM: Data about diabetes control in Lithuania are poor while information about situation in the largest capital city Vilnius is missing. The aim of our study was to assess long-term diabetes control in relation to disease duration and complications in type 2 diabetes mellitus (T2DM) subjects in Vilnius.

METHODS: A retrospective collection of data on diabetes management, covering the period from 2012 to 2013 year inclusively was performed in 5 largest public primary Vilnius outpatient clinics and included a sample of 1591 randomly selected T2DM patients. Information on diabetes duration, glycated hemoglobin (HbA1c) and the presence of complications (retinopathy, nephropathy, polyneuropathy, angiopathy) was collected from clinical notes and electronic database system into the standardized data collection form. Diabetes duration was classified into 5 categories: 0-5, 6-10, 11-15, 16-20, >20 years. Target HbA1c was ≤7%.

RESULTS: The average HbA1c in T2DM subjects was 6,7±2,1%. The target HbA1c was achieved in 61,2% of patients. The lowest HbA1c of 6,3±2,1% was estimated in the group with T2DM duration of 0 -5 years, the highest - 7,5±1,9% - in the group with disease duration of 16-20 years. There was no further worsening of diabetes control with DM duration >20 years, where HbA1c was 7,1±2,2%. Patients with one DM complication had HbA1c 7,3±1,5%, with two - 7,6±1,5%, with three – 8,7±1,9%, with four - 8,8±1,1%.

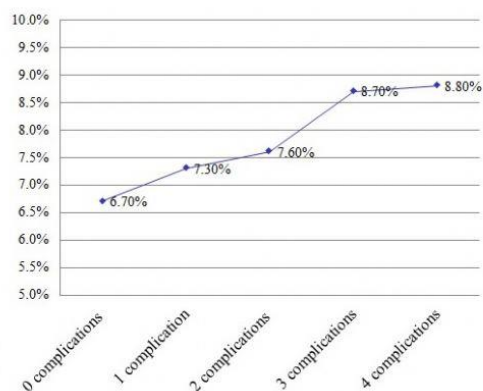
CONCLUSIONS: Our analysis revealed a very good level of long-term diabetes care in reaching glycemic goals at Vilnius outpatient clinics. However, there was a clear tendency of worsening glycemic control with diabetes duration and the increasing number of complications. Family doctors have to put more efforts to manage T2DM in a subset of patients with long disease duration and complications.

Keywords: type 2 diabetes, primary care, glycated hemoglobin

Table 1. Average glycated hemoglobin in different diabetes duration categories.

Diabetes duration (years)	HbA1c, % (in T2DM subjects)
0-5	6,3±2,1
6-10	7,0±1,4
11-15	7,3±2,3
16-20	7,5±1,9
>20	7,1±2,2

Figure 1. Association of HbA1c and number of complications in type 2 diabetes.



P-0062

Annual screening for Diabetic Retinopathy at Vilnius Outpatient Clinics

Monika Niedvaraitė¹, Zdrune Visockienė¹, Laura Siaulienė³, Margarita Lasevic¹, Estera Muchlyte¹, Asta Sakaite¹, Daura Raudonyte¹, Dalia Palisaityte¹, Rima Povilioniene¹, Ruta Baneviciute Domarkiene¹, Roma Puronaite², Vytautas Kasiulevicius¹, Virginijus Sapoka¹

¹Vilnius University Faculty of Medicine, Vilnius, Lithuania

²Vilnius University Hospital Santariskiu Klinikos, Vilnius, Lithuania

³Karoliniskiu Outpatient Clinic, Vilnius, Lithuania

Background and AIM: Diabetic retinopathy (DR) remains the most common complication of diabetes mellitus (DM) leading to the blindness in the working-age population. Early diagnosis of DR is critical in preventing visual loss. The aim of our research was to evaluate the annual assessment for DR and the incidence of DR in type 1 (T1DM) and type 2 diabetes mellitus (T2DM) subjects at primary care level.

METHODS: A retrospective analysis of medical records covering the period from 2012 to 2013 year was performed in five largest public primary Vilnius outpatient clinics collecting data on basic patient characteristics, diabetes type and duration, diagnosed DR, referrals to ophthalmologist for retinal screening.

RESULTS: The study group of 1719 adult patients consisted of 92.6% of T2DM subjects and 58.9% of women. Diabetic patients were 64.4±13.4 years of age with average duration of diabetes of 8.1±6.9 years. The incidence of DR was 10.7% (50.0% in T1DM and 7.5% in T2DM)–, There were 42.8% of patients referred to ophthalmologist for retinal screening in 2012 (51.6 % T1DM, 42.1 % T2DM) and 43.0% of patients – in 2013 (56.3 % and 42.0 % respectively).

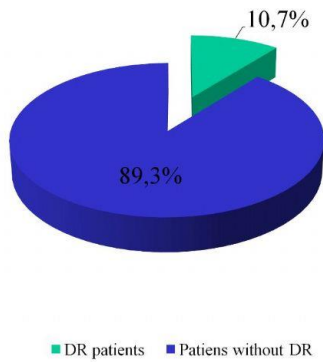
CONCLUSIONS: Our study revealed high prevalence of diabetic retinopathy and poor annual monitoring for diabetic retinopathy in patients with type 1 and type 2 diabetes at five largest Vilnius outpatient clinics. Family doctors should pay more attention for the management of diabetic retinopathy retinal screening and improve referrals to ophthalmologist for annual retinal screening.

Keywords: primary care, diabetes mellitus, diabetic retinopathy

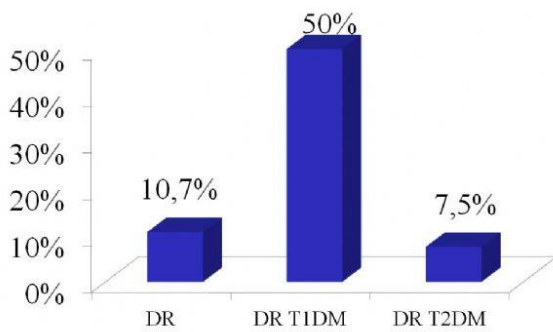
General data

Male	41,1%
Female	58,9%
T1DM patients	7,4%
T2DM patients	92,6%
Age average	64,4±13,4 years
Duration of diabetes average	8,1±6,9 years

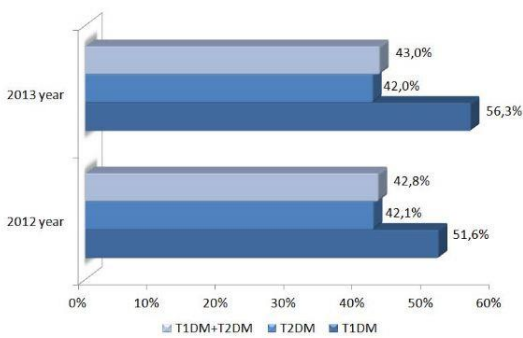
Incidence of diabetic retinopathy in DM patients.



Incidence of DR in T1DM and T2DM patients.



Incidence of ophthalmologist consultations for retinal screening.



P-0063

Efficacy of the treatments for High Blood Pressure in a primary care center

Pedro Alejandro Gonzales Flores, Ione Veronica Mejia Ganoza

Catalan Health Institute, CAP Les Fontetes, Cerdanyola del Vallès, Barcelona, Spain

OBJECTIVES

1. To determinate the differents kinds of treatments for ther treatment of High Blood Pressure (HBP)
2. To determinate the effectiveness of the diferents treatments for HBP

METODOLOGY

Descriptive and retrospective study. Were chosen 80% (583) of patients with HBP of the Primary Care Center Les Fontetes (Cerdanyola del Vallès. Barcelona). We describe the main kinds of treatments and measure the effectiveness off them. Good control was measured using the Catalan Health Institute (ICS) and European Hypertension Society (EHS)

RESULTS

Prevalence of HBP was 46,3%. For the chosen populations, good control by ICS guide was 59,5% and 69,9% using EHS guide. For men the good control was 63,2% and 71,1% (ICS and EHS respectively) and for women 56,9% and 69,2% (ICS and EHS). The mains treatments were: ARA II+Diuretics 16,47%; ACEi + Diuretics 15,95%; ACEi (Angiotensin coverse enzyme inhibitors) 13,89%; ARA II 7,89%; Diuretics 5,83%; ARAII+Calcium antagonist+Diuretics 4,12%; Beta-blockers 3,95%; ARAII+calcium antagonist 3,77% and others 19,90%.

The degree of control using the ICS guide: ARA II+Diuretics 57,3%; ACEi + Diuretics 69,9%; ACEi 58,1%; ARA II 56,5%; Diuretics 61,8%%; ARAII+Calcium antagonist+Diuretics 66,7%%; Beta-blockers 60,87%; ARAII+calcium antagonist 66,7% and others 50,72%.

The degree of control using EHS was: ARA II+Diuretics 70,9%; ACEi + Diuretics 77,4%; ACEi 63,9%; ARA II 73,9%; Diuretics 70,9%; ARAII+Calcium antagonist+Diuretics 75%; Beta-blockers 82,6%; ARAII+calcium antagonist 77,3% and others 61,1%.

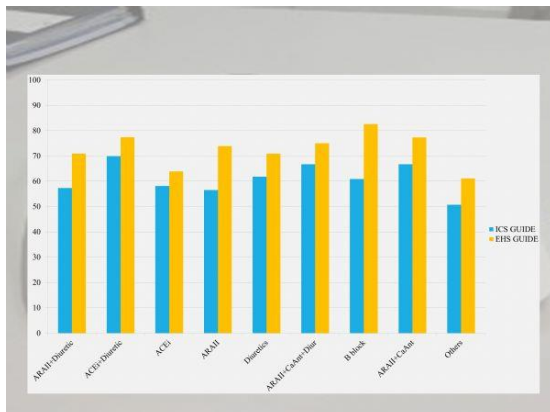
There were difference statistically significant in ARA II+Diuretic, ARA II, Beta-blockers, ACEi+Calcium antagonist and Calcium antagonist+Diuretic

CONCLUSIONS

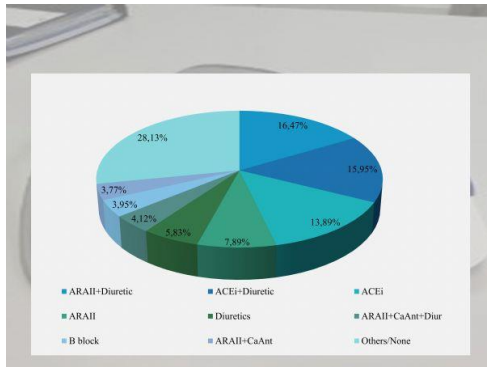
1. There were so many kinds of treatments for treatment of HBP in our study.
2. There was not difference statistically significant between man and women.
3. The mains treatments were ARA II+Diuretics; ACEi + Diuretics and ACEi.
4. The degree of control of HBP was non-uniform.
5. The most efective treatments were: ARAII+Diuretic, ARA II, Beta-Blockers ACEi+Calcium antagonist and Calcium antagonist+Diuretic.

Keywords: High Blood Pressure, Treatment, Good control

EFFECTIVENESS OF THE TREATMENTS FOR HIGH BLOOD PRESSURE



MAINS TREATMENTS USED FOR HIGH BLOOD PRESSURE



P-0064

Association of Glycated Hemoglobin and Diabetes Treatment at Vilnius Largest Outpatient Clinics

Estera Muchlyte¹, Zydrune Visockiene¹, Laura Siaulienė³, Asta Sakaite¹, Daura Raudonyte¹, Dalia Palisaityte¹, Monika Niedvaraitė¹, Margarita Lasevic¹, Rima Povilioniene¹, Ruta Baneviciute Domarkiene¹, Roma Puronaite², Virginijus Sapoka¹, Vytautas Kasiulevicius¹

¹Vilnius University, Faculty of Medicine, Vilnius, Lithuania

²Vilnius University Hospital Santariskiu Klinikos, Vilnius, Lithuania

³Karoliniskiu Outpatient Clinic, Vilnius, Lithuania

BACKGROUND AND AIM: Each country has its own policy on diabetes care but there is a lack of feedback how effective those strategies are in practise. The objective of our reaseach was to assess glycated hemoglobin (HbA1c) outcomes in relation to diabetes treatment.

METHODS: A retrospective analysis of medical records was performed at 5 largest outpatient clinics in Vilnius and included a randomly selected sample of 1719 type 1 diabetes (T1DM) and type 2 diabetes (T2DM) patients. Data from 2012 and 2013 year on patient basic characteristics, HbA1c, diabetes treatment strategy (diet, oral medications, insulin therapy, combined therapy) were collected.

RESULTS: Mean age of 1719 subjects was 64±13,4 years, female composed 58,9%. There were 7,4% of T1DM and 92,6% of T2DM subjects with average disease duration 8,13±6,9 years. Average HbA1c was 6,8±2,3 %: 8,6±2,6 % in T1DM and 6,6±2,1 % in T2DM. The target HbA1c of ≤7 % was reached in 57,6 % of subjects: in 13,3 % of T1DM and in 61,2 % of T2DM. The most of T2DM subjects - 72,2 % were treated with oral medications, 6,9 % - with diet, 11,6 % - with insulin, 9,1 % - with combination of insulin and oral agents. All T1DM patients were treated with insulin. T2DM patients treated with diet had HbA1c 6,1±0,1 %, with oral agents - 6,8 ±1,1 %, with insulin - 8,5 ±1,8 %, with combination of insulin and oral agents - 8,5 ± 1,5 %.

CONCLUSION: Good glycemic control at Vilnius outpatient clinics was achieved in the majority of T2DM patients treated with oral agents or diet, however situation worsened with insulin therapy. General practitioner faces a challenge in achieving glycemic goals in T1DM or T2DM subjects when insulin therapy is necessary with the progression of disease and have to put more efforts in achieving targets.

Keywords: diabetes treatment, glycated hemoglobin, primary care

Figure 1. The incidence of treatment options in T2DM patients.

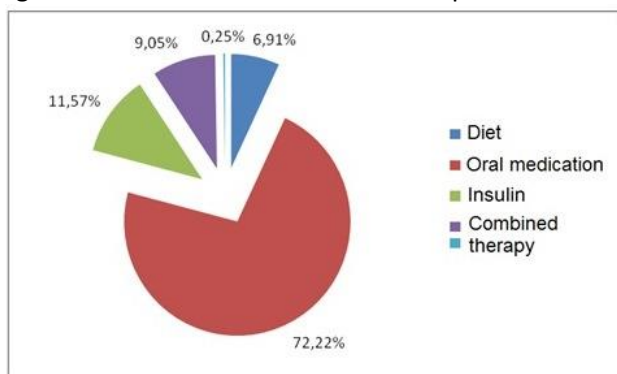
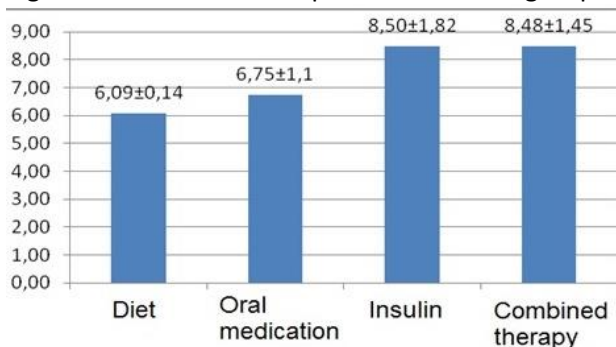


Figure 2. HbA1c rate in separate treatment groups of T2DM patients.



P-0065

Association between high risk alcohol consumption, hypertension in Korean people The Fifth Korea National Health and Nutrition Examination Survey (KNHANES V, 2010-2012)

Sun Hong Min, Ki Young Kwon, Hong Jun Cho, Jeong Ah Lee, Young Zu Kim

Department of Family Medicine, Asan Medical Center, University of Ulsan College of Medicine, Seoul, Korea

BACKGROUND: The purpose of this study was to investigate the association between high risk alcohol consumption and hypertension with representative sample in Korea.

METHODS: We used data from the Korean National Health and Nutrition Examination Survey, 2010-2012. The participants were aged 30 years and older, high risk drinking was divided into four groups: none, once a month, once a week and nearly daily. After adjusting for confounding factors, binomial logistic regression analysis was performed to assess the association between high risk drinking, hypertension

RESULTS: The prevalence of hypertension was 32.4% and the rate of high risk drinking was as follows: none = 36.1%; once a month = 30.3%; once a week = 26.0%; none = 7.6%. On binomial logistic regression analysis adjusting for confounding factors (age, body mass index, sex, hypercholesterolemia, household income, education status, physical activity, smoking status, DM and average daily alcohol consumption). A lineal association between the prevalence of hypertension and frequency of high risk drinking was found. Compared with non-risk drinking group, odds ratio (OR) (95% confidence interval, CI) for hypertension according to frequency of high risk drinking was as follows: once a month, OR = 1.280 (95% CI, 0.978-1.676); once a week, OR = 1.977 (95% CI, 1.559-2.228); nearly daily, OR = 2.341 (95% CI, 1.791-3.058).

CONCLUSION: This study shows that high risk drinking is associated with hypertension.

Keywords: High risk drinking; Hypertension; Average daily alcohol consumption

Baseline characteristics by Hypertension status among Korean people.

	Non-HTN %(SE)	HTN %(SE)	P value
Gender			
Male	64.6(0.8)	35.4(0.8)	<0.001
Female	70.5(0.7)	29.5(0.7)	
Age(years)			
≥ 70	34.2(1.1)	65.8(1.1)	<0.001
60-69	43.5(1.2)	56.5(1.2)	
50-59	62.6(1.1)	37.4(1.1)	
40-49	77.0(0.9)	23.0(0.7)	
30-39	89.9(0.7)	10.1(0.7)	
BMI(kg/m²)			
BMI ≥25	52.6(1.1)	47.4(1.1)	<0.001
18.5≤BMI≤25	73.4(0.9)	26.6(0.9)	
BMI<18.5	82.7(0.8)	17.3(0.8)	
Hypercholesterolemia			
Yes	49.8(1.3)	50.2(1.3)	<0.001
No	71.4(0.6)	28.6(0.6)	
Physical activity of Moderate intensity (day/week)			
6-7	72.4(2.0)	27.6(2.0)	<0.001
4-5	68.7(1.4)	31.3(1.4)	
2-3	72.2(1.2)	27.8(1.2)	
0-1	66.2(0.7)	38.8(0.7)	
Frequency of high Risk drinking			
Nearly daily	52.3(2.3)	47.7(2.3)	<0.001
Once a week	64.8(1.3)	35.2(1.3)	
Once a month	72.4(1.1)	27.6(1.1)	
None	71.2(1.0)	28.8(1.0)	
Amount of daily Alcohol consumption (gram/day)			
Alcohol gram <30	67.1(1.4)	32.9(1.4)	< 0.001
Alcohol gram ≥30	57.9(3.0)	42.1(3.0)	

Values are presented as number(%) *Chi-square test for categorical variables comparing subjects with normal, HTN

Baseline characteristics by frequency of high-risk drinking among Korean people.

	None %(SE)	Once a month %(SE)	Once a week %(SE)	Nearly daily %(SE)	P value*
Gender					
Male	18.5(0.6)	38.0(0.8)	33.0(0.5)	10.6(0.5)	<0.001
Female	65.7(0.9)	17.4(0.7)	14.4(0.7)	2.5(0.3)	
Age(years)					
≥ 70	64.4(1.8)	18.0(1.3)	10.5(1.2)	7.1(1.0)	<0.001
60-69	48.6(1.4)	25.8(1.3)	17.6(1.1)	8.0(0.8)	
50-59	35.4(1.2)	26.8(1.2)	27.6(1.2)	10.2(0.9)	
40-49	38.8(1.1)	30.9(1.1)	27.8(1.1)	7.4(0.7)	
30-39	27.0(1.0)	37.3(1.2)	30.1(1.2)	5.6(0.6)	
BMI(kg/m ²)					
BMI ≥25	31.1(0.9)	31.4(1.0)	29.0(1.0)	8.5(0.6)	<0.001
18.5≤BMI≤25	38.2(0.7)	29.9(0.7)	24.7(0.7)	7.2(0.4)	
BMI<18.5	52.1(3.6)	26.8(3.4)	17.1(2.8)	4.0(1.5)	
Hypercholesterolemia					
Yes	31.9(0.6)	37.2(0.6)	23.7(0.6)	7.2(0.4)	0.776
No	31.8(1.6)	38.5(1.6)	23.4(1.6)	6.3(1.0)	
DM					
Normal	38.2(0.7)	31.9(0.7)	24.2(0.7)	5.7(0.4)	<0.001
IFG	28.8(1.2)	28.7(1.3)	31.0(1.3)	11.5(0.9)	
DM	32.5(1.9)	28.2(1.8)	28.1(2.0)	11.2(1.3)	
Smoking status					
Current smoking	14.5(0.8)	34.0(1.1)	38.7(1.1)	12.9(0.8)	<0.001
Previous smoking	24.3(1.0)	38.2(1.2)	28.9(1.1)	8.6(0.7)	
Non-smoking	61.8(0.9)	22.3(0.7)	13.5(0.7)	2.5(0.3)	
Physical activity of moderate intensity (days/week)					
5-7	30.3(1.0)	39.2(1.1)	20.9(0.9)	9.6(1.0)	<0.001
2-4	27.6(1.1)	40.6(0.9)	24.9(0.9)	6.9(1.0)	
0-1	33.7(1.2)	37.0(0.9)	23.2(1.0)	6.1(1.0)	

Values are presented as number(%) *Chi-square test for categorical variables comparing subjects with normal, HTN

Odds ratio* and 95% confidence interval for HTN according to frequency of high risk drinking.

HTN	
	Odds ratio(95% CI) P value
None	1
1/month	1.280(0.978-1.676) 0.072

1/week 1.977(1.510-2.589) <0.001
Daily 2.319(1.751-3.072) <0.001
P for trend <0.001

*Odds ratios were derived from binomial logistic regression analysis Adjusted for age,sex,household income,education status, married status,physical activity and smoking status, BMI and diabetes mellitus,hypercholesterolemia and mean alcohol consumption amount

P-0066

Anemia after gastrectomy in long-term survivors for gastric cancer

Ji Hye Jun¹, Jeong Ah Lee¹, Sung Sunwoo¹, Young Sik Kim¹, Byung Sik Kim²

¹Department of Family Medicine, Asan Medical Center, University of Ulsan College of Medicine

²Department of Stomach Surgery, Asan Medical Center, University of Ulsan College of Medicine

Background

Anemia is one of the frequent complications after gastrectomy in patients with gastric cancer. In this study, we would like to evaluate the incidence of anemia in long-term survivors from gastric cancer and important risk factors impacting on anemia.

Method

This study included 385 patients who visited the Cancer Prevention Clinic in the department of family medicine in Asan medical center from January 1, 2009 to December 31, 2014. All patients underwent curative gastrectomy and have been surviving over 5 years. We measured hemoglobin, iron, TIBC, Ferritin and Vitamin B 12 level before the surgery as well as at 5 annual follow up. Variables such as patients' sex, age at the time of surgery, education level, alcohol consumption, smoking, marital status, occupation, and body mass index (before and after surgery) are considered. We used logistic regression model to describe the probability of anemia (as well as iron deficiency and B12 deficiency) with various covariates listed above. Statistical significance of each covariate is tested and 95% confidence intervals for odds ratio are obtained.

Result

The study subjects consist of 258 males and 127 females (mean age, 53.2 years). Compared to the level before the surgery, there is a significant increase of the incidence of anemia 5 years after the surgery in all patients; 38 among male out of 258(14.7%), 37 among female out of 127(29.1%). The incidence of anemia has tended to increase over time after gastrectomy. In univariate analysis, patients with total gastrectomy, women, lower body weight at 5 year showed significantly higher compared to patients with subtotal gastrectomy at 5 year after gastrectomy (P =0.00086, P=2e-07, P=0.00033).

Conclusions

Anemia after gastrectomy has been increasingly occurred on long-term follow up after gastrectomy. Therefore, the regular evaluation of anemia is necessary to long-term gastric cancer survivors.

Keywords: Anemia, Gastrectomy, Gastric cancer

P-0067

Prevalence of depression at general practitioners in Republic of Macedonia

Biljana Petkovska Ognjanova¹, Violeta Ognjanova², Stefan Arsov²

¹Doctor's Chamber of Macedonia

²PZU Urgenta

Background and OBJECTIVES: Due to the daily strain and stress at the work place the risk of depression is very high in the medical staff. Our aim was to measure the prevalence and the severity of underlying symptoms at the general practitioners in Republic of Macedonia.

METHODS: 298 General Practitioners were asked to perform PHQ9 depression self-assessment questionnaire. In which 9 symptoms were scored from 0-3 depending on their occurrence in the last 2 weeks.

RESULTS: The mean age of the subjects was 46 years of age, 88% were female and 30% worked in rural areas. The most commonly expressed depression symptom was tiredness and lack of energy. In 26% of subjects depression was present. In 20% of case it was subsyndromal depression, 3.5% had mild depression episode, 2.3% had moderately heavy depression episode whereas 0.8% had heavy depression episode. There was no correlation in the linear regression between the age, gender and location and severity of presence of depression. The independent predictors of the severity of depression were the 9 question from the questionnaire.

DISCUSSION: The prevalence of depression of general practitioners of 26% in Republic of Macedonia appears to be higher than the reported prevalence of around 10% of general population. The most common symptom was tiredness and lack of energy what indicated that the large work load can be one of the cause of the high prevalence of depression.

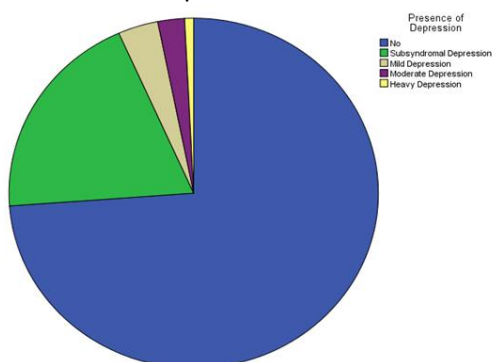
Keywords: depression, stress, general practitioner

PHQ9 questionnaire

Over the last 2 weeks, how often have you been bothered by any of the following problems?	Not at all	Several Days	More than half the days	Nearly every day
1. Little interest or pleasure in doing things	0	1	2	3
2. Feeling down, depressed, or hopeless	0	1	2	3
3. Trouble falling or staying asleep, or sleeping too much	0	1	2	3
4. Feeling tired or having little energy	0	1	2	3
5. Poor appetite or overeating	0	1	2	3
6. Feeling bad about yourself – or that you are a failure or have let yourself or your family down	0	1	2	3
7. Trouble concentrating on things, such as reading the newspaper or watching television	0	1	2	3
8. Moving or speaking so slowly that other people could have noticed. Or the opposite – being so fidgety or restless that you have been moving around a lot more than usual	0	1	2	3
9. Thoughts that you would be better off dead, or of hurting yourself in some way	0	1	2	3

Total Score: 1-4 Minimal depression; 5-9 Mild depression; 10-14 Moderate depression; 15-19 Moderately severe depression; 20-27 Severe depression

Presence of Depression at GPs



Average PHD9 Scores of the GPs

1 Little interest or pleasure in doing things	0.69±0.66
2. Feeling down, depressed, or hopeless	0.79±0.81
3 Trouble falling or staying asleep, or sleeping too much	0.55±0.78
4. Feeling tired or having little energy	1.00± 0.76
5. Poor appetite or overeating	0.52±0.78
6. Feeling bad about yourself-or that you are a failure or have let yourself or your family down	0.31±0.66
7. Trouble concentrating on things, such as reading the newspaper or watching TV	0.52±0.57
8. Moving or speaking so slowly that other people could have noticed. Or the opposite-being so fidgety or restless that you have been moving around a lot more than usual	0.21±0.41
9. Thought that you would be better off dead, or hurting yourself in some way	0.035±0.19
Total Score	4.55±3.16

Demographic Data of the GPs

Age (years)	46.1±12.4
Gender (Female/Male)	88% / 12%
Location of the GP office (rural/urban)	30% / 70%

P-0068

Should Human Chorionic Gonadotropine Treatment Increase Thyroid Volume?

Ayten Oguz¹, Dilek Tuzun¹, Murat Sahin¹, Numan Guvenc², Kamile Gul¹

¹Kahramanmaraş Sutcu Imam University School of Medicine, Department of Endocrinology and Metabolism, KAHRAMANMARAS, TURKEY

²Kahramanmaraş Sutcu Imam University School of Medicine, Department of Family Medicine, KAHRAMANMARAS, TURKEY

AIM: Our aim was to investigate the thyroid function tests and throid volume differences among isolated hypogonadotropic hypogonadism patients that take androgen replacement treatment.

MATERIAL-METHOD: 36 male patients with isolated hypogonadotropic hypogonadism with a mean age 33,2 (age,18-54) that diagnosed in Endocrinology and Metabolism Department between september 2013 and september 2014 and 40 healty control with a mean age 27,77 (age,18-55) were involved to study. Patient group was divided as testosterone treated patients (n=18) and human chorionic gonadotropin treated patients (n=18). Patient group was compared before and 6 months after treatment in terms of total testosterone, thyroid function tests (thyroid stimulating hormone, free thyroxine) and thyroid volume. Patient group was compared with control group as well.

RESULTS: When we compared the control group and patient group before treatment there was not any significant difference for age, BMI, TSH, ft4 and thyroid volume between 2 groups. When we compared the patient group before and after treatment there was not any difference for TSH and ft4 levels but testosterone levels and thyroid volume were significantly higher after treatment ($p<0.05$). When we compared the HCG-treated and testosterone-treated patients; thyroid volume was higher among HCG-treated patients ($p<0.05$) but there was not any difference for thyroid volume before and after testosterone treatment ($p>0.05$). Additionally, there was a statislically significant negative correlation between TSH and thyroid volume ($r=-0.195$, $p=0.039$).

CONCLUSION: Our study showed that androgen replacement treatment increases the thyroid volume and thyroid volume increased especially in HCG-treated patients. We suggest that thyroid volume changes should be considered in follow up among HCG-treated patients

Keywords: thyroid function, volume, hypogonadism, androgen replacement

Table 1. The baseline characteristics and thyroid function tests, total testosterone levels, thyroid volume of the male patients with IHH and controls

Parameters	Patient Group (n=36)	Control Group (n=40)	p
Age	33.2 ±9.30	27.77±9.68	0.078
BMI(kg/m ²)	27.33±6.61	26.5±7.06	0.605
FSH (mIU/ml)	1.82±1.68	5.1±2.21	<0.001
LH (mIU/ml)	1.44±1.24	3.71±1.50	<0.001
TT (ng/dl)	98.65±69.69	460.52±90.36	<0.001
TSH (mIU/ml)	1.41±0.79	1.70±0.94	0.133
fT ₄ (ng/dl)	1.16±0.19	1.10±0.14	0.128
Prolactin (ng/ml)	7.64±3.39	7.85±2.77	0.772
Cortizol (mcg/dl)	19.23±1.14	19.36±1.22	0.623
GH (ng/ml)	1.86±0.55	2.04±0.75	0.261
TV (mL)	8.62±1.46	8.78±0.81	0.558

Table 2. BMI, Total testosterone levels, thyroid function tests and thyroid volume changes before and after treatment in patient group

Parameters	Before Treatment n=36	After Treatment n=36	p
BMI (kg/m ²)	27.3±3.90	27.1±5.10	0.620
TT (ng/dl)	98.65±69.70	434.83±138.64	<0.001
TSH (mIU/ml)	1.45±0.75	1.39±0.56	0.627
FT ₄ (ng/dl)	1.16±0.19	1.34±0.49	0.024
TV (mL)	8.76±1.13	9.02±0.99	0.001

P-0069

Primary care providers' opinions about online self-management for well-controlled type 2 diabetes mellitus patients

Huberta Hart¹, Elke De Leeuw², Guy Rutten², Rimke Vos²

¹Leidsche Rijn Julius Health Centers, Utrecht, The Netherlands

²Julius Center for Health Sciences and Primary Care, University Medical Center Utrecht, The Netherlands

Background and AIM: To explore perceptions of primary care providers about an online self-management program for well controlled type 2 diabetes (T2DM) patients that replaces a greater part of regular care, and to assess the selection of eligibility of these patients in their own practice.

METHODS: An online self-management program was introduced in four primary healthcare centers. Well-controlled T2DM patients could get the opportunity to visit the practice once per year and to upload self-measured bloodglucose, blood pressure and bodyweight measures three-monthly. Patients will be contacted afterwards on indication. Well-controlled (both HbA1c, LDL-cholesterol and blood pressure) patients were selected from the Electronic Data Base. Primary care providers judged who of them were eligible for the self-

management program, and reported reasons for ineligibility. Patients' characteristics were compared and multivariable logistic regression was performed. Besides, the general practitioners and nurses received a questionnaire on online self-management in general.

RESULTS: Thirty six primary care providers participated. They considered 154 (54.6%) patients of 282 well-controlled T2DM patients eligible for self-management. Main reasons for ineligibility were 'language barrier' and 'cognitive impairment'. Odds for ineligibility were higher for older age (OR 1.05; 95%CI 1.03-1.08) and non-Western ethnicity (OR 4.18; 95%CI 1.77-9.90). In general, 32 primary care providers judged online self-management cost-effective (56.3%) and beneficial for patients (62.5%). The following categories of patients were considered to be capable of self-management: people with high compliance (90.3%) and health literacy (80.6%), being well-controlled for a longer period (61.3%) and with little comorbidity (6.5%). Most reported barriers for online self-management were poor health literacy (90%), cognitive impairment (83.3%), language barrier (83.3%) and low compliance (76.7%).

CONCLUSION: In general, primary care providers have positive perceptions about online self-management as alternative to regular care for well-controlled T2DM patients, but in practice they consider a high proportion of patients ineligible for online self-management.

Keywords: self management, type 2 diabetes mellitus, primary care providers

Reasons for ineligibility as judged by the GPs in 128 patients

	Number of patients
Language barrier	25 (19.5%)
No more well-controlled	23 (18.0%)
Cognitive impairment	23 (18.0%)
No computer/ internet	14 (5.0%)
Low compliance	12 (4.3%)
Comorbidity	11 (3.9%)
Complications	8 (2.8%)
Out of care	6 (2.1%)
SIMMS > 1	4 (1.4%)
Passed away	2(0.7%)

P-0070

Diagnosis and treatment of Chlamydia trachomatis infection- case report

Etela Janeková

InClinic s.r.o, Internal medicine and GP, Bratislava, Slovakia

Background & AIM: It is not just a disease that is occurring in developed countries. It is a disease occurring even in countries with highly developed economy and because of numerous antibiotic treatments, inflammatory diseases, not fully treated diseases and ongoing diseases.

The Chlamydia trachomatis infection often affects the urogenital tract in men and it manifests as dysuria, when short-lived and untreated progresses to epididymitis. With women there often occurs an asymptomatic, or with non-specific symptoms of an inflammatory disease. In both cases, usually, the true origin of the disease is not thought of and the disease leads to a chronic phase with the development of Reiter's syndrome and reactive arthritis, which is accompanied by urethritis (cervicitis in women), conjunctivitis, and a few aspects of painful musculoskeletal lesions. The disease develops in a few years spent with Chlamydia trachomatis. Often identified by medical history as Reiter's syndrome.

METHODS: The case study evaluated the disease in 11 patients who were not diagnosed in time and came to seek treatment for the pain of one or more joints (in most cases monoarthritis of the knee) and not for infections

of the urogenital tract. All patients were diagnosed with eye diseases such as conjunctivitis and/or keratoconjunctivitis.

RESULTS: The patients were treated, as well as their partners, given that it is an STD (sexually transmitted disease).

CONCLUSIONS: An important step in halting the spread of such an infection is an appropriate prevention, which consists of education, identification of asymptomatic ev. oligosymptomatic patients, effective diagnosis and treatment, and the treatment of sexual partners.

Keywords: chlamydia trachomatis, Reiter's syndrome, STD

Trachoma



Chronic bilateral follicular conjunctivitis and keratoconjunctivitis in untreated ev. relapsed transfer occurs in the deeper structures of the eye with the emergence of the entropy of a corneal ulcer.

P-0071

Individual Representations about Their Illness in End-Stage Renal Disease Patients Undergoing Hemodialysis

Aysen Kutan Fenercioglu¹, Ergun Simsek², Sibel Kosucu³, Huseyin Demirbilek²

¹Department of Family Medicine, Baskent University Medical Faculty, Istanbul Hospital, Istanbul, Turkey

²Hemodialysis Unit, Baskent University Istanbul Hospital, Istanbul, Turkey

³Nursing Services, Baskent University Istanbul Hospital, Istanbul, Turkey

AIM: To explore the impact of end-stage renal disease (ESRD) on individual illness representations including seven symptoms; time-line (acute/chronic), illness identity, cyclical symptoms, consequences, treatment control, coherence and emotional response.

MATERIALS-METHODS: This study employed a cross-sectional design. The participants in this study included 41 patients with ESRD who were undergoing hemodialysis treatment. Participants were assessed using 38 questions of Revised Illness Perception Questionnaire (IPQ-R) that address seven subscales. The patients rated the items on a five point scale, ranging from strongly disagree to strongly agree. Data were analyzed with NCSS (Number Cruncher Statistical System) 2007 Statistical Software program. Kruskal-Wallis one way variance analysis was used to analyze the differences between the groups. Pearson correlation test was used to analyze differences of emotional representations with age, disease onset age, employment and education. P value <0.05 was accepted as statistically significant.

RESULTS: In this study, the alfa coefficients for all subscales of patients' individual representations were between 0.782 and 0.835 compared to the alfa coefficients for subscales of individual illness representations of Turkish population which were between 0.69-0.77 as indicated in the validity and reliability study of the test. The correlations between the age, education level, employment status of the patients and the 7 subscales of illness representations didn't show any statistically significant result (p>0.05). Only, there was a statistically significant correlation in a negative direction between the disease onset age and the patient's coherence to their illness (r=0.343, p=0.03).

CONCLUSION: In ESRD, hemodialysis patients' individual representations to their illness didn't show significant changes at any age, education level and employment status. Besides, as the disease onset age increased, patients' coherence to their illness decreased. Young hemodialysis patients were able to understand and make sense of their disease quite well compared to baseline.

Keywords: End-stage renal disease, revised Illness Perception Questionnaire, individual illness representations

Table 1. Correlation between age, disease age and dialysis age of the patient with individual representations about their illness

	Age	Disease Age	Dialysis Age
Illness Identity	r -0,158 p 0,329	r 0,174 p 0,283	r 0,194 p 0,23
Time-line (Acute/Chronic)	r -0,066 p 0,688	r 0,074 p 0,648	r 0,047 p 0,772
Emotional Response	r 0,224 p 0,164	r -0,217 p 0,178	r -0,02 p 0,904
Coherence	r 0,138 p 0,394	r -0,343 p 0,03	r -0,196 p 0,225
Consequences	r 0,097 p 0,552	r 0,053 p 0,746	r -0,072 p 0,658
Treatment Control	r 0,05 p 0,759	r 0,155 p 0,339	r 0,027 p 0,867
Cyclical Symptoms	r 0,112 p 0,492	r 0,057 p 0,728	r 0,021 p 0,895
Illness Perception Scale	r 0,113 p 0,488	r -0,032 p 0,846	r 0,008 p 0,962

Table 2.. Correlation between education status of the patient with individual representations about their illness

	Primary school n:13	High school n:13	University n:15	p
Illness Identity	16,33±4,29	18,85±5,18	16,33±4,39	0,287
Time-line (Acute/Chronic)	19,25±2,73	16,92±4,17	19,27±4,76	0,246
Emotional Response	19,83±7,4	20,46±6,81	22,07±4,17	0,621
Coherence	7,17±3,3	6,85±2,88	8,67±4,34	0,370
Consequences	20,08±5,14	18,69±4,55	22,2±4,06	0,136
Treatment Control	14,17±2,44	15±3,63	14,73±2,46	0,765
Cyclical Symptoms	9,42±1,83	9,46±2,99	10,07±2,6	0,753
Illness Perception Scale	116,75±17,54	117,38±17,87	124,07±13,02	0,420

P-0072

A rare disease common in our region: Sickle Cell Disease Review and Recommendations for Primary Care

Aslı Korur, Çiğdem Gereklioğlu, Süheyl Asma

Department of Family Medicine, Başkent University, Adana, Türkiye

Background&AIM: Sickle cell disease (SCD) is a chronic hematological disorder characterized by sickled erythrocytes mediating microvascular occlusion, hemolytic anemia and jaundice. Although SCD is a hematological disorder, many patients are forced to rely on primary care providers (PCPs) for medical management of their SCD. **METHOD:** A selective search and review of the current literature on SCD and the authors' experience. **RESULTS:** Management of individuals with SCD is very complex requiring a multidisciplinary approach that should

involve the patient and the family. Newborn screening for SCD is now mandatory in our country, as well as in most states where SCD is prevalent. SCD is diagnosed in all age groups by hemoglobin electrophoresis or DNA analyses. In SCD, thrombosis and infarction caused by vasoocclusion of large and small blood vessels often results in acute and chronic organ damage. Frequent complications are anemia, vaso-occlusive pain episodes, febrile illness, cerebrovascular accident, acute splenic sequestration, acute chest syndrome, pulmonary hypertension, aplastic crisis, priapism, retinopathy, renal disease and leg ulcers. Red blood cell transfusion therapy and hydroxyurea are the major options available for patients in the treatment and prevention of complications. Hematopoietic stem cell transplantation is the only curable treatment option today which has begun to be performed in our centre.

CONCLUSIONS: PCPs are now in era of increased routine screening, assessment and management of chronic complications from this illness not previously seen in the care of adults with SCD. Holistic approach is critical for management of SCD patients who may usually be neglected at primary care setting. Therefore, PCPs should be aware of this rare disease which is common in our country.

Keywords: Sickle cell disease, primary care

P-0073

Causal Attributions of the Hemodialysis Patients for the Onset of End-Stage Renal Disease

Aysen Kutan Fenercioglu¹, Ergun Simsek², Sibel Kosucu³, Huseyin Demirbilek²

¹Department of Family Medicine, Baskent University Medical Faculty, Istanbul Hospital, Istanbul, Turkey

²Hemodialysis Unit, Baskent University Istanbul Hospital, Istanbul, Turkey

³Nursing Services, Baskent University Istanbul Hospital, Istanbul, Turkey

AIM: To explore the possible causal attributions (psychological factors, life style, chance, hereditary and environmental risk factors) of the hemodialysis patients for the onset of End-Stage Renal Disease (ESRD).

MATERIALS-METHODS: This study employed a cross-sectional design. The participants in this study included 41 patients with ESRD who were undergoing hemodialysis treatment. Participants were assessed using 18 questions of Cause Subscale of the revised Illness Perception Questionnaire (IPQ-R). The patients rated the items on a five point scale, ranging from strongly disagree to strongly agree. Data were analyzed with NCSS (Number Cruncher Statistical System) 2007 Statistical Software program (Utah, USA). Kruskal-Wallis one way variance analysis was used to analyze the differences between the groups. Pearson correlation test was used to analyze correlation of causal attributions with age, employment status and education. P value <0.05 was accepted as statistically significant.

RESULTS: In this study, the alfa coefficients for all subscales of patients' causal attributions about their illness were between 0.816 and 0.887 compared to the alfa coefficients for causal attributions of Turkish population which were between 0.25 and 0.72 as indicated in the validity and reliability study of the test. The correlations between the patients' age, disease onset age, hemodialysis age, education level of the patient, the employment status of the patient and the subscales of causal attributions about their illness didn't show any statistically significant result ($p>0.05$). The most common causal attribution was psychological factors and the least common causal attribution was chance.

CONCLUSION: In ESRD, hemodialysis patients' causal attributions about their illness didn't show significant changes at any age, education level and employment status. Most of the patients had believes that the disease occurred because of their psychological risk factors. The belief that the disease occurred by chance was the least possible causal attribution.

Keywords: End-stage renal disease, revised Illness Perception Questionnaire, Causal Attributions

P-0074

Profile of NSAIDs prescription in patients with ischaemic heart disease in a metropolitan city

Alejandro Leganes Ramos¹, Ana Gangoso Feroso², Laura Portillo Horcajada², Ana Villimar Rodriguez², Sonia Soto Diaz², Lourdes Martin Mendez²

¹Hospital Universitario Fundación Alcorcón, Alcorcón, España

²Dirección Asistencial Oeste, Servicio Madrileño de Salud, Mostoles, España

Background and AIM: NSAIDs must be used carefully in patients with ischaemic heart disease (IHD). We aimed to assessment the prescription of NSAIDs in patients with (IHD) in a metropolitan city with seven primary care health centers and compare with the agencies' recommendations in IHD that position as safer NSAID naproxen, followed by ibuprofen, and position selective COX-2 (coxib) as contraindicated.

METHOD: A descriptive cross-sectional study in patients 14 aged and over with active episode of IHD in the clinical history with CIAP code K74 (ischaemic heart disease with angina), K75 (acute myocardial infarction) and K76 (ischaemic heart disease without angina) with at least one dispensation of NSAIDs (period: September 2013-August 2014). Variables collected: sex, age, CIAP code, date of episode and dispensation, kind of NSAIDs, dosage, number of dispensed packages and use of NSAIDs in general population. The databases Consutaweb® and Farm@drid and statistic program Epidat 3.1 were used.

RESULTS: Of the 141,285 population studied, 3,563 patients (2.52% 95%CI: 2.11-2.94) have IHD. 896 of them (25.15% 95%CI: 22.36-27.93) had at least one dispensation of NSAIDs, the median age was 68.9 ± 11.8 years and 65.07% were male. The odds ratio of the NSAIDs prescription between patients with or without IHD was 0.91 (95%CI: 0.84-0.98 p=0,01). In patients with IHD, the total packages of NSAIDs dispensed was 2,083 (2.3 package/patient 95%CI: 1.95-2.70). The profile of NSAIDs use was: ibuprofen (51.03%), dexketoprofen (16.03%) coxib group (11.67%) and Naproxen (6.96%). Most of the patients (54,64%) had only one dispensation, and 12,74% had at least 4.

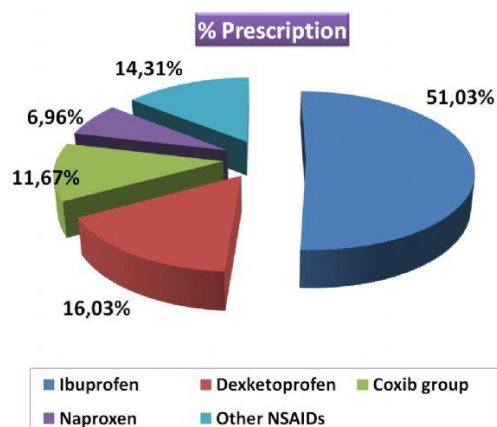
CONCLUSIONS: Despite the recommendations, the prescription of NSAIDs in patients with IHD is common and similar to general population, even though it seems to be used in short treatments. The profile should get better, because of the high use of coxib and low use of naproxen.

Keywords: ischaemic heart disease, NSAID, primary health care

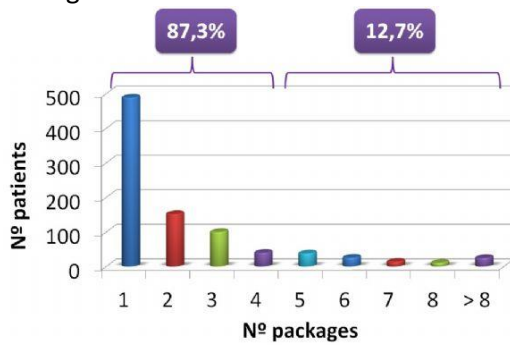
4x4

	NSAID	NO NSAID	TOTAL
IHD	896	2,667	3,563
NO IHD	37,281	100,441	137,722
TOTAL	38,177	103,108	141,285

Prescription



Packages



P-0075

The Comparison of Illness Perception Between Breast Cancer Patients and Other Cancer Patients

Sevsen Cebeci¹, Elif Akyol², Gül Eren², Dilek Önler², Müzeyyen Arslan², Metin Canbal¹

¹Department of Family Medicine, Turgut Ozal University, Ankara, Turkey

²Turgut Ozal University School of Nursing, Ankara, Turkey

AIM: Patients cluster their ideas about an illness around five coherent themes or components. These components together make up the patient's perception of their illness. The components provide a framework for patients to make sense of their symptoms, assess health risk, and direct action and coping. Each of these components holds a perception about one aspect of the illness and together they provide the individual's coherent view of an illness.

METHOD: The research sample was conducted in 106 outpatient treatment patients in Dr. Abdurrahman Yurtaslan Oncology Education and Research Hospital services which is located in the center of Ankara, who were treated between November 2013 May 2014. Questionnaire containing patient characteristics and Illness Perception Scale was used to collect the data.

RESULTS: In our study treatment control and duration (cyclic) subscale scores were found to be higher in patients with breast cancer compared to other cancer patients ($p=0,000$, $p=0,041$). Breast cancer patients have lower ascription points of lifestyle than other cancer patients ($p=0,013$). Chance factors, physical factors, treatment control subscale scores were higher in patients with a family history than those without a family history ($p<0,05$) Treatment control subscale scores in housewives were higher than other occupational groups, external ascription and lifestyle ascription subscale scores were lower ($p<0,05$).

CONCLUSION: A strong belief that the illness can be cured or controlled is typically associated with short perceived illness duration and relatively minor consequences. In contrast, beliefs that an illness will last a long time and has a number of symptoms tend to be associated with more severe consequences perceptions and lower beliefs about cure or control of the disease.

Keywords: illness perception, breast cancer, family medicine

P-0076

Annual Foot Screening in Type 1 and Type 2 Diabetes Subjects at Vilnius Primary Care Outpatient Clinics in 2012 – 2013

Dalia Palisaityte¹, Zdrune Visockiene¹, Laura Siaulienė³, Daura Raudonyte¹, Estera Muchlyte¹, Asta Sakaite¹, Monika Niedvaraitė¹, Margarita Lasevic¹, Rima Povilioniene¹, Ruta Baneviciute Domarkiene¹, Roma Puronaite², Vytautas Kasiulevicius¹, Virginijus Sapoka¹

¹Vilnius University, Faculty of Medicine, Vilnius, Lithuania

²Vilnius University hospital Santariskiu klinikos, Vilnius, Lithuania

³Karoliniskiu Outpatient Clinic, Vilnius, Lithuania

Background and AIM:

Annual foot examination doesn't require laboratory or instrumental resources, however, provided regularly, helps to early diagnose diabetic polyneuropathy and peripheral angiopathy. The aim of study was to assess the annual foot examination in type 1 diabetes mellitus (T1DM) and type 2 diabetes mellitus (T2DM) subjects during primary care visits.

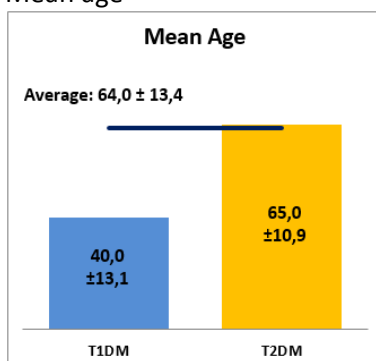
METHODS: A retrospective data from clinical notes on basic patient characteristics, disease duration, long-term glycemic control, diabetes complications - polyneuropathy, angiopathy, annual foot screening, tobacco use, covering the period from 2012 to 2013 inclusively, were collected at five largest Vilnius primary care outpatient clinics.

RESULTS: A randomly selected sample of 1719 subjects included 128 (7,4%) T1DM and 1591 (92,6%) T2DM subjects. The average age was $64,0 \pm 13,4$ years ($40,0 \pm 13,1$ T1DM; $65,0 \pm 10,9$ T2DM);, disease duration – $8,13 \pm 6,94$ years ($16,82 \pm 11,49$, T1DM; $7,49 \pm 5,92$, T2DM), and HbA1c – $6,82 \pm 2,34\%$ ($8,67 \pm 2,63$, T1DM; $6,67 \pm 2,14$ T2DM). Only 317 subjects (18,4%) were screened for tobacco use: there were 230 non-smokers (72,56%) and 87 (27,44%) smokers. Annual foot examination during primary care visit was performed only in 17,3% of subjects (21,9% T1DM; 16,9% T2DM). Diagnosis of angiopathy was recorded in 7,74% (13,28% T1DM, 7,29% T2DM), polyneuropathy - in 36,18% of cases (69,53% T1DM, 33,5% T2DM).

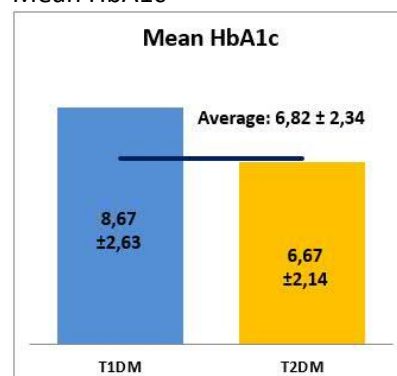
CONCLUSION: Study results show good long-term glycemic control especially in T2DM subjects, however annual screening for diabetes complications – polyneuropathy, angiopathy – providing simple exam of the feet is clearly insufficient, as during primary care visit is performed for less than one fifth of all subjects. It could be presumed that the estimated rate of angiopathy and polyneuropathy would be even higher if all subjects have annual foot examination. These results urge for implementation of long term strategy at the primary care level to improve comprehensive follow-up for diabetes complications.

Keywords: type 1 diabetes, type 2 diabetes, primary care, diabetic foot care

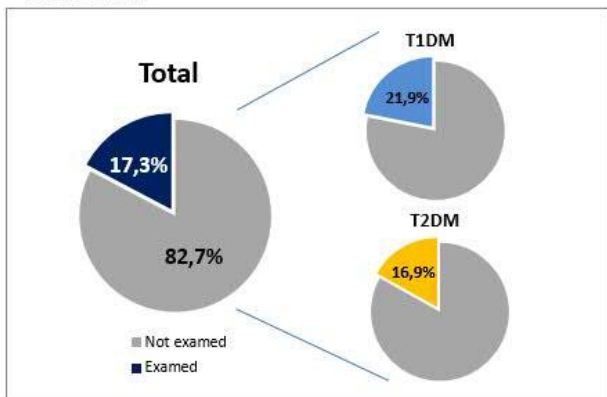
Mean age



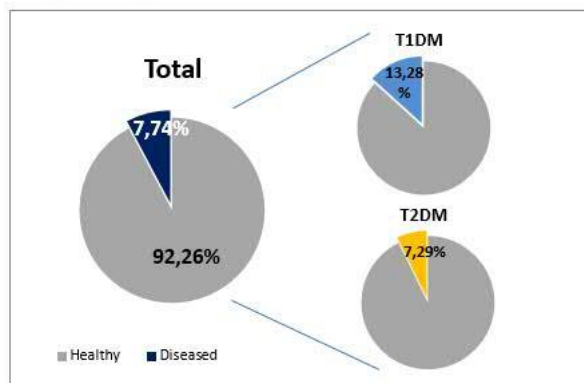
Mean HbA1c



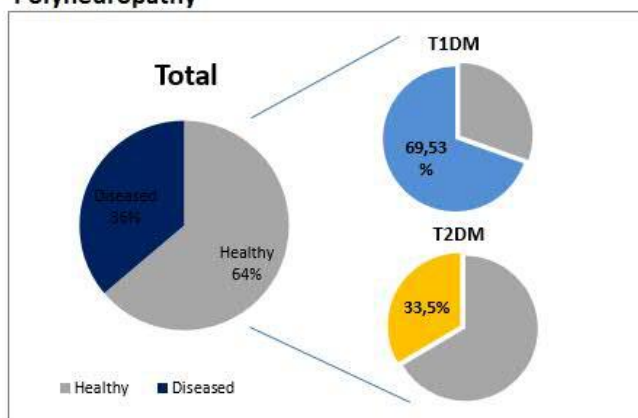
Foot exam
Foot exam



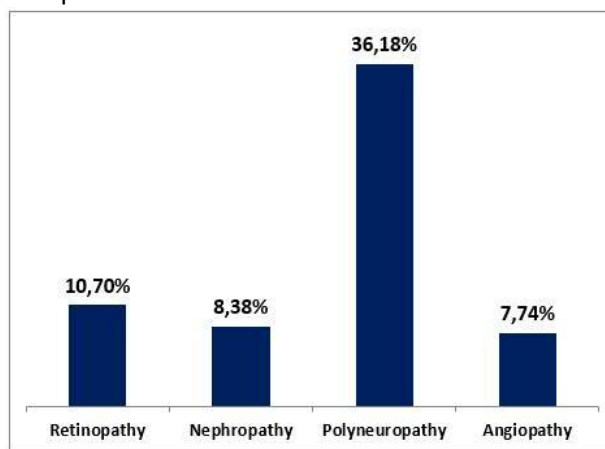
Angiopathy
Angiopathy



Polyneuropathy
Polyneuropathy



Complications of DM



P-0077

Patient and disease characteristics associated with activation for self-management in patients with a chronic disease: a cross-sectional survey study

Irene Bos Touwen¹, Marieke Schuurmans¹, Evelyn Monninkhof², Yvonne Korpershoek¹, Lotte Spruit Bentvelzen¹, Inge Ertugrul De Graaf¹, Niek De Wit², Jaap Trappenburg¹

¹Department rehabilitation, nursing science & sports, University Medical Centre Utrecht, Utrecht, The Netherlands.

²Julius Center for Health Sciences and Primary Care, University Medical Centre Utrecht, Utrecht, The Netherlands

Background & Aim A substantial proportion of chronic disease patients do not respond to self-management interventions, which suggests that one size interventions do not fit all, demanding more tailored interventions. To compose more individualized strategies, we aim to increase our understanding of characteristics associated with patient activation for self-management and to evaluate whether these are disease-transcending.

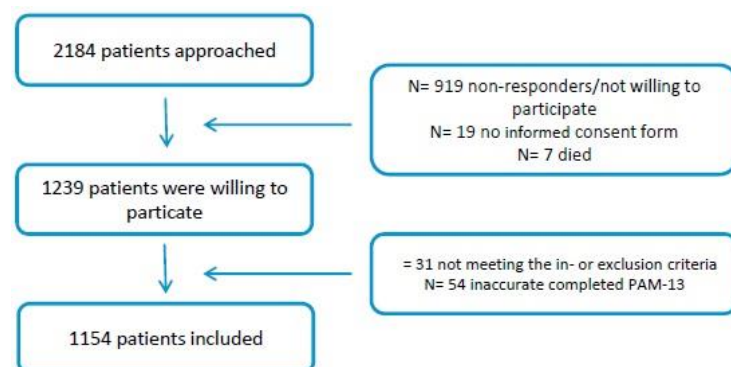
Methods A cross-sectional survey study was conducted in primary and secondary care in patients with type-2 Diabetes Mellitus (DM-II), Chronic Obstructive Pulmonary Disease (COPD), Chronic Heart Failure (CHF) and Chronic Renal Disease (CRD). Using multiple linear regression analysis, we analyzed associations between self-management activation (13-item Patient Activation Measure; PAM-13) and a wide range of socio-demographic, clinical, and psychosocial determinants. Furthermore, we assessed whether the associations between the determinants and the PAM were disease-transcending by testing whether disease was an effect modifier. In addition, we identified determinants associated with low activation for self-management using logistic regression analysis.

Results We included 1154 patients (53% response rate); 422 DM-II patients, 290 COPD patients, 223 HF patients and 219 CRD patients. Mean age was 69.6±10.9. Multiple linear regression analysis revealed 9 explanatory determinants of activation for self-management: age, BMI, educational level, financial distress, physical health status, depression, illness perception, social support and underlying disease, explaining a variance of 16.3%. All associations, except for social support, were disease transcending.

Conclusion This study explored factors associated with varying levels of activation for self-management. These results are a first step in supporting clinicians and researchers to identify subpopulations of chronic disease patients less likely to be engaged in self-management. Increased scientific efforts are needed to explain the greater part of the factors that contribute to the complex nature of patient activation for self-management.

Keywords: Chronic Disease, patient participation, cross-sectional studies

Flowchart



Response

Table 1. Results of multiple linear regression analysis

	Final multiple linear regression model after reduction β (95% CI)	
Age (years)	-0.04	(-0.10; 0.02)
BMI (kg/m ²)	-0.24	(-0.37;-0.11)
Level of education		
Moderate vs low	-0.57	(-1.81; 0.68)
High vs low	1.93	(0.10; 3.76)
Financial distress		
Low vs none	-1.72	(-2.98; -0.47)
High vs none	-1.18	(-3.50; 1.15)
Health status (SF-12)		
Physical component	0.03	(-0.00;0.07)
HADS (Hospital anxiety and depression scale)		
Depression	-0.15	(-0.35;0.04)
Illness perception	-0.16	(-0.21;-0.10)
Social support	0.09	(0.05;0.13)
Chronic disease		
COPD vs DM-II	1.35	(-0.23;2.94)
CHF vs DM-II	0.29	(-1.52; 2.10)
CRD vs DM-II	-2.45	(-4.09;-0.81)
Explained variance of the model	R ² = .163, adjusted R ² = .153	

P-0078

Association of Glycated Hemoglobin, Complications and Disease Duration in Type 1 Diabetes Patients at Vilnius Outpatient Clinics

Monika Niedvaraitė¹, Zdrune Visockienė¹, Laura Siaulienė³, Margarita Lasevic¹, Estera Muchlyte¹, Asta Sakaite¹, Daura Raudonyte¹, Dalia Palisaityte¹, Rima Povilioniene¹, Ruta Baneviciute Domarkiene¹, Roma Puronaite², Vytautas Kasiulevicius¹, Virginijus Sapoka¹

¹Vilnius University Faculty of Medicine, Vilnius, Lithuania

²Vilnius University Hospital Santariskiu Klinikos, Vilnius, Lithuania

³Karoliniskiu Outpatient Clinic, Vilnius, Lithuania

BACKGROUND AND AIM: information on long-term diabetes mellitus (DM) patients management is lacking. We aimed to assess the long-term control of type 1 diabetes mellitus (T1DM) in relation to disease duration and number of complications in Vilnius.

METHODS: a retrospective analysis of medical records was performed at five largest Vilnius primary outpatient clinics collecting data from 2012 to 2013 year inclusively. Target glycated hemoglobin (HbA1c) was $\leq 7\%$. Diabetes duration was classified into 5 categories: 0-5, 6-10, 11-15, 16-20, >20 years. Patients were divided into groups according to number of complications they had: 0, 1, 2, 3 and 4.

RESULTS: There were 128 T1DM subjects included in the study. The average HbA1c was $8,7 \pm 2,6\%$.

Target HbA1c $\leq 7\%$ was reached in 13,3% of patients. The lowest HbA1c of $8,1 \pm 2,6\%$ was reached in a group with T1DM duration of 6-10 years. HbA1c in disease duration of 0-5 years was $9,5 \pm 2,03\%$, 11-15 years - $8,4 \pm 4,0\%$, 16-20 years - $9,8 \pm 1,9\%$, >20 years - $8,6 \pm 2,3\%$. The lowest HbA1c of $6,9 \pm 1,4\%$ was reached in patients with 4 complications; the highest - $9,0 \pm 2,2\%$ - in a group with 2 complications. Patients without complications had HbA1c $7,7 \pm 3,7\%$, 1 complication - $8,9 \pm 1,7\%$, 3 complications - $8,9 \pm 3,0\%$.

CONCLUSIONS: The results showed insufficient long-term glucose control in most of T1DM subjects.

Poor control was estimated at the very beginning of disease and then with an increase of disease duration.

Complications also worsened glycemic control, with the tendency of HbA1c increase with the number of complications. Although there are some limitations of study due to small number of subjects, the overall tendency supports the need for care improvement in T1DM subjects.

Keywords: type 1 diabetes, primary care, glycated hemoglobin

General data

Gender	50% male 50% female
Age average	$40 \pm 13,1$ years
Average duration of DM	$16,82 \pm 11,49$
Average HbA1c	$8,7 \pm 2,6\%$

Average HbA1c value grouped by DM duration.

T1DM duration (years)	HbA1c, %
0-5	$9,5\% \pm 2,03$
6-10	$8,1\% \pm 2,65$
11-15	$8,4\% \pm 3,99$
16-20	$9,8\% \pm 1,85$
>20	$8,6\% \pm 2,30$

Average HbA1c value grouped by amount of DM complication

Number of complications	HbA1c, %
0	7,7%±3,73
1	8,9%±1,71
2	9,0%±2,22
3	8,9%±3,06
4	6,9%±1,35

P-0079

Control levels of blood pressure among a group of people with hypertension in a health clinic

José Carlos Perez Sánchez, Nayade Jorge Matin, Maria Ángeles Castaño Fuentes, José Ángel Sánchez Ortiz, Estela Diaz Sánchez, Rocio Gil Ruiz
Andalusian Health Service

OBJECTIVE: Study the level of control of a group of people with hypertension and its relation to variables such as gender, anthropometric index, diastolic and systolic arterial tension, tobacco consumption and use of anti hypertension medication by each patient.

MATERIAL-METHODS: Random data samples taken from 16 rural health clinics. Samples were taken from 166 patients who were measured according to age, sex, weight, size arterial tension, bodily mass index (BMI), tobacco, glycemia, cholesterol and quantity of anti hypertension medication consumed on average, standard derivation, **RESULTS:** The data was collected from 166 individuals, 74 men and 92 woman with an average age of 63, 28 weight 81,26, was it.size 163, bodily mass index 30,60, systolic arterial tension 134, diastolic arterial tension 79,72, glycemia 107,9, cholesterol 219,7, tobacco 3,13, patients controlled for arterial tension 124 and those who were not controlled 42. The number of medications taken per patient ranged from: 0 medications (11 patients), 1 medication (65 patients), 2 medications (56 patients), 3 medications (26 patients), 4 medications (8 patients). No significant difference was found between the non controlled groups and the groups controlled for weight, waist-size, BMI, age, glycemia, cholesterol and tobacco, but a significant difference was found by those controlled for diastolic and systolic arterial tension. Having studied the degree of control according to the number of medications, no dependency was found using contingency tables, analyzing if there existed a correlation between control and type of medication was only significant for control and treatment with calcium blockers.

ARGUMENT: There's a high percentage of non controlled patients, almost a third and a average of systolic arterial tension close to the limit just as the limit of weight, BMI, glycemia, and high cholesterol. It's also attention calling the absence of personal history records of the treatment of 11 patients and the independence between control and number of medications.

Keywords: arterial hypertension, control, medication

Figure 1

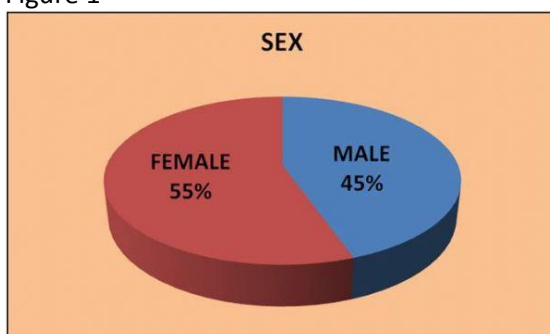


Figure 2

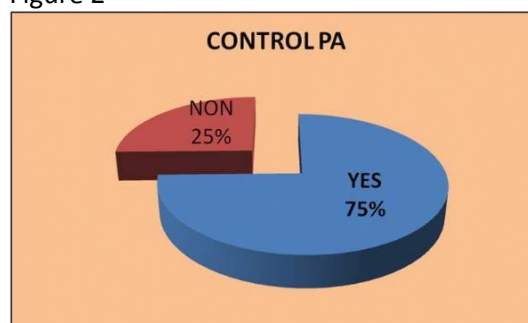


Figure 3

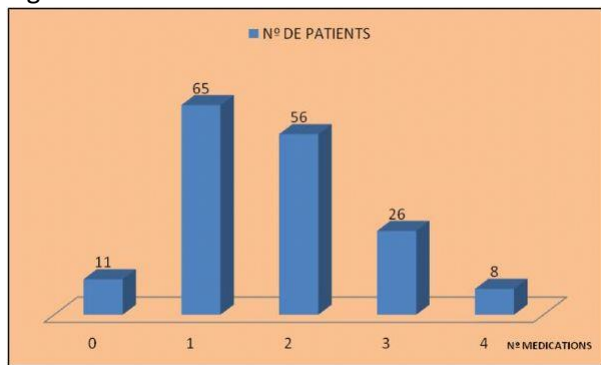


Table 1

	AGE	WEIGHT (KG)	HEIGHT (CM)	BM I	SBP (MMHG)	DBP (MMHG)	GLYCEMIA (MG/DL)	CHOLESTEROL (MG/DL)	TOBACCO
AVERAGE	63.28	81.26	163	30.7	134.7	79.72	107.9	219.7	3.13

P-0080

Variations in Lipid Screening Frequency in Family Medicine Patients with Cardiovascular Risk Factors

Yusuf Cetin Doganer¹, James Rohrer², Kurt Angstman², Stephen Merry², Jacob Erickson²

¹Department of Family Medicine, Turkish Military Academy, Primary Care Examination Center, Ankara, Turkey

²Department of Family Medicine, Mayo Clinic, Rochester, Minnesota, USA

Background & AIM: Over-testing for lipid levels in family medicine has been identified by the Choosing Wisely initiative of the American Board of Internal Medicine (ABIM) Foundation as a target for intelligent cost reduction in the U.S. This study was undertaken to assess the frequency of lipid screening in comparison to the United States Preventive Services Task Force (USPSTF) guideline in a sample of family medicine patients. In addition, we sought to determine the association between testing frequency and achievement of lipid targets.

METHODS: A random sample was extracted of 271 patients from among all patients cared for in our Department of Family Medicine for whom lipid screening was ordered from March to September, 2012 and who had ≥2 well-defined cardiovascular risk factors. Lipid testing frequency was classified in three ways: semi-annual or less often (0-12 tests over 6 years), annual or less often (0-6 tests), or biennial (0-3 tests).

RESULTS: Multiple logistic regression analysis revealed that the predictors of lipid screening more often than semiannually were age ≥60 years (OR=3.7) and diabetes mellitus (DM) (OR=30.6). Predictors of screening more often than annually were DM (OR=4.3), hypertension (OR=2.1), family history of premature coronary artery disease (CAD) (OR=5.6), and statin treatment (OR=3.5). Lipid goal attainment was not associated with testing frequency except in regard to low-density lipoprotein (LDL) levels (p=0.043, p<0.001, p=0.005 by semi-annual, annual, biennial, respectively) and total cholesterol levels (p=0.015, p=0.025 by semi-annual, annual, respectively).

CONCLUSIONS: Questionably high frequency of lipid testing was detected even when the more conservative approach of annual monitoring was assumed. Frequency of testing was not associated with goal attainment for most parameters. Physicians should request the lipid testing based on overall risk assessment, treatment goal achievement and person variability in accordance with published guidelines.

Keywords: Screening, risk factors, interval, lipid parameters, guidelines

Table 1. Baseline demographic characteristics (N=271)

	Frequency (n)	Percent (%)
Gender (Male)	132	48.7
Age Groups (≥ 60 years)	123	45.4
Race (Caucasian)	255	94.1
BMI (≥ 30)	177	65.3
Smoking status (Current smoker)	55	20.3
Coronary Artery Disease (CAD)	78	28.8
Diabetes Mellitus (DM)	89	32.8
Non- Coronary Artery Disease	39	14.4
Hypertension	191	70.5
Familial Premature CAD	19	7.0
Past Hyperlipidemia History	235	86.7
Statin Treatment	133	49.1

Table 2. Multiple logistic regression analysis of lipid screening frequencies among patients with two or more risk factors (N=271)*

	B	P	OR (95% CI Upper-Lower)
Semi-annual interval			
Age (≥ 60 years vs < 60 years)	1.30	0.025	3.67 (1.17 - 11.42)
DM (Y / N)	3.42	< 0.001	30.57 (6.54 - 142.74)
Annual interval			
DM (Y / N)	1.45	< 0.001	4.26 (2.21 - 8.18)
Hypertension (Y / N)	0.72	0.046	2.05 (1.01 - 4.17)
Family History of premature CAD (Y / N)	1.72	0.010	5.61 (1.50 - 20.93)
Statin treatment (Y / N)	1.25	< 0.001	3.51 (1.88 - 6.54)
Biennial interval			
Smoking (Current Smokers vs others)	-1.71	0.001	0.18 (0.06 - 0.47)
DM (Y / N)	1.73	0.001	5.64 (2.04 - 15.59)
History of previous Dyslipidemia (Y / N)	1.93	< 0.001	6.89 (2.36 - 20.11)
Statin treatment (Y / N)	1.55	< 0.001	4.72 (0.00 - 11.15)

*Controlling for the variables including gender, race, BMI groups, CAD, Non-coronary artery atherosclerosis.

DM: Both type of Diabetes Mellitus, CAD: Coronary artery disease

P-0081

"{"Research of the Frequency of Metabolic Syndrome in Patients with rheumatoid arthritis and spondyloarthropathies"}"

Ezgi Agadayı¹, Fatma Gul Yurdakul², Sitki Agadayı², Hatice Bodur², Rabia Kahveci¹, Adem Ozkara¹

¹Department of Family Medicine, Ankara Numune Education and Research Hospital, Ankara, Turkey

²Department of Physical Therapy and Rehabilitation, Ankara Numune Education and Research Hospital, Ankara, Turkey

""Background and AIM: Metabolic syndrome (MS) is a disease which involves components of low HDL levels, elevated plasma glucose and triglyceride levels, central obesity, hypertension. Rheumatoid arthritis (RA) is a chronic, inflammatory, systemic disease whose etiology is unknown. Spondyloarthropathies (SpA) is a group of diseases that associated with HLA-B27 with articular and extra-articular symptoms. Chronic inflammation is considered to play a role in metabolic disorders and vascular disorders. It is thought that proinflammatory cytokines could conduce to development of hypertension, atherosclerosis and peripheral insulin resistance. Results indicate that the MS may be associated with inflammatory rheumatic diseases. In this study we investigated the prevalence of MS in inflammatory diseases.

METHODS: Patients with a diagnosis of RA and SpA and without any inflammatory disease were included in the study. Patients' demographic characteristics, waist circumference, height and weight, blood pressure and biochemical laboratory analysis were recorded. MS was diagnosed according to the NCEP ATPIII 2005 criteria. **RESULTS:** Study were included 97 patients (RA: 49, SpA: 21, Control: 27) until March 10, 2015. According to other groups, SpA patients were younger and male patient ratio was higher. Blood pressure measurements were higher in RA patients. BMI, waist circumference and MS (RA: 44.9%; SpA: 47.6%; control group: 59.3%) was not statistically different between the groups. **CONCLUSIONS:** In the literature, waist circumference, blood pressure and plasma glucose levels were shown higher in patients with RA. Prevalence of MS in RA patients has been reported ranging 20% to 42% and prevalence of MS in RA patients is higher than healthy controls. In a study included patients of RA, AS, PsA, frequency of MS was reported as %20- %11- %38, respectively. In our data, there is no difference between the groups in prevalence of MS. Study is ongoing. ""

Keywords: Frequency of Metabolic Syndrome, Metabolic Syndrome in rheumatoid arthritis, Metabolic Syndrome in spondyloarthropathies

statistics

	RA (n=49)	SpA (n=21)	Control (n=27)	p
Age (mean, ±)	57,2 ±10,3	44,2 ±12,8	59,9 ±11,9	<0,001 ^{a,b}
Gender (F/M)	37/12	7/14	24/3	<0,05
BMI (mean, ±)	29,1 ±5	28 ±5,3	29 ±5	0,70
Waist Circumference (mean, ±)	103,9 ±13,8	100,6 ±12,6	101,5 ±15	0,61
BP (systolic) (mean, ±)	139,4 ±18,5	128,8 ±17,8	120,1 ±17,2	<0,001 ^c
BP (diastolic) (mean, ±)	88,7 ±10,9	83,3 ±10	74,6 ±10,6	<0,001 ^{b,c}
FPG (mean, ±)	105,3 ±30,3	102,1 ±15,9	105,1 ±34,1	0,90
LDL (mean, ±)	136,4 ±31,2	120,3 ±30,3	155,6 ±66,7	0,02 ^b
HDL (mean, ±)	56,9 ±15,5	45,6 ±7,7	50,6 ±14,7	0,007 ^a
Cholesterol (mean, ±)	227,8 ±57,6	193,4 ±36,7	233,8 ±52,5	< 0,05 ^{a,b}
Triglycerides (mean, ±)	141,9 ±64	137,9 ±74,4	194,8 ±87,9	< 0,05 ^{b,c}
ESR (mean, ±)	25,5 ±18,5	21,9 ±17,6	9,6 ±6,2	<0,001 ^{b,c}
CRP (mean, ±)	17,1 ±27,8	17,1 ±21,4	2,9 ±1,8	0,02 ^c
Presence of Metabolic Syndrome (n, %)	22 , %44,9	10, %47,6	16 , %59,3	0,47
Using Antihypertensive (n, %)	22 , %44,9	4 , %19	6 , %22,2	<0,05
Using Antidiabetic(n, %)	5 , %10,2	1 , %4,8	3 , %11,1	0,71
Using Antilipidemic (n,%)	1 , %2	0, %0	1 , %3,7	0,66
Smokers, (n,%Smokers)	4 , %8,2	8, %38,1	1 , % 3,7	<0,05

BMI: Body Mass Index, BP: Blood Pressure, FBG: fasting plasma glucose, LDL: Low Density Lipoprotein, HDL: High Density Lipoprotein, ESR: Erythrocyte Sedimentation Rate, CRP: C-Reaktif Protein a: p(RA- SpA) b: p(SpA-control) c: p(RA-control)

P-0082

Diabetic autonomic neuropathy

Diana Dominguez Jimenez¹, Maria Angeles Moreno Fontiveros², Carmen Maria Cortes Salazar³

¹Doctor trainee at theHealth Centre of Estepa, Sevilla

²Family doctor at theHealth Centre of Estepa, Sevilla

³Family doctor at theHealth Centre of Badolatosa, Sevilla

BACKGROUND: As doctors of primary care it is basic for our daily practice to know our patient and the chronic diseases most frequent to provide a good practice.

CASE: Female 68 years. She's been suffering of constipation for several years. The last 4 months, she refers episodes of diarrhea that last 1-2 days, especially at night. This episodes has been more frequent this last week. She does not refer fever or other symptoms.

Abdomen: depresible, not signs of peritoneal irritation. Not painful to palpation.

Blood test: All result normal, except for glucose: 256 mg/dl, and glycohemoglobin 10.2%.

After a few interviews with the patient to check the evolution, the absence of alarm signs and symptoms, and the personal history of the patient: Diabetic since 10 years, that in the last 2 years has been with bad glucose control, with sensitive and motor neuropathy since then. We diagnose her of diabetic autonomic neuropathy and focus on glucose level control.

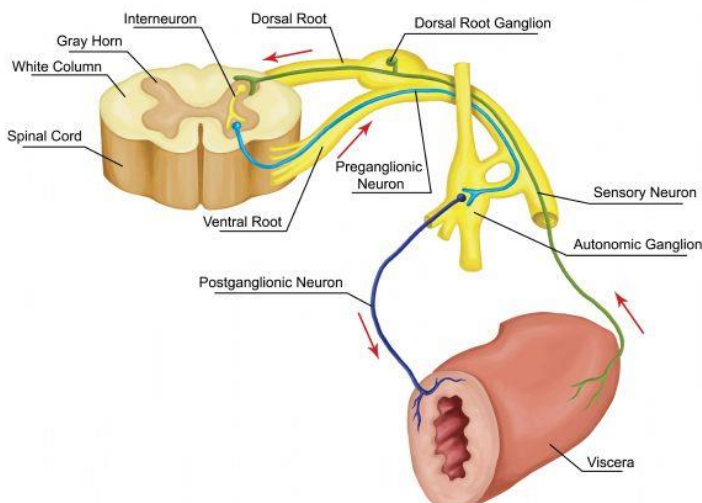
DISCUSSION: Diabetic autonomic neuropathy (DAN) is among the least recognized and understood complications of diabetes despite its significant negative impact on survival and quality of life in people with diabetes. DAN can involve the entire autonomic nervous system: cardiovascular, gastrointestinal, genitourinal and genitourinary, sudomotor, or ocular. Usually It is subclinical.

The gastrointestinal symptom most frequent is constipation. This can be interrupted for episodes of diarrhea, especially at night. The cause of this episodes of diarrhea are overgrowing bacterias and malabsorption of bile salts, so it can be treated with broad spectrum antibiotics. The constipation can be treated with supplements of fiber or metoclopramide.

Evolution: After speaking with the patient highlighting the importance of a good glucose level control, making some changes in her life style and the treatment, the patient normalized glucose level in 4 months. Since then she has been practically asymptomatic.

Keywords: Neuropathy, diabetes, constipation, diarrhea

Autonomic motor reflex



P-0083

Importance of AGE variable in a study of type 2 diabetes and knowledge of the disease in a rural area

Jose Antonio PASCUAL Lopez¹, Pedro María Martínez López¹, Maria Ros Marin¹, Alfredo Pérez Carrillo¹, Concepción Martínez Delgado¹, Javier Aracil Fernández¹, María Dolores Vazquez García², Jose Alcibiades Duran Aaron¹, Francisco Javier Fernández Valero¹, Noelia Benítez Samuel¹, Juana Noelia López Pastor¹, Andres Egea Huertas¹, Miguel Angel Asmat Segura¹, Hebab Saas Bob Bachir¹, Maria Huertas Vidal Gimenez¹, Monica Michelle Arcos Rivera¹

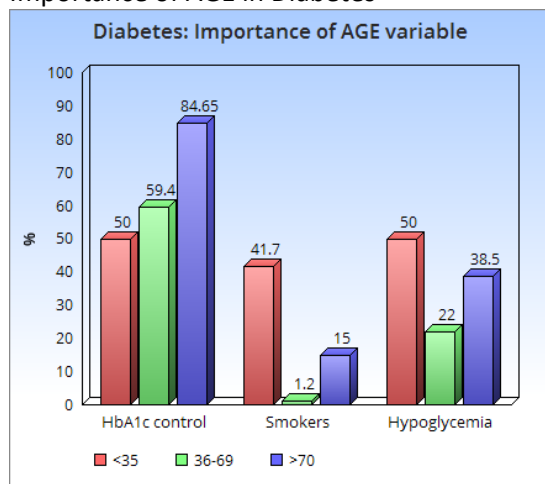
¹Centro de Salud de Calasparra. Gerencia del Noroeste. Servicio Murciano de salud. Murcia. Spain.

²Centro de Salud Barrio del Progreso. Gerencia Area VII. Servicio Murciano de Salud. Murcia. Spain.

- **Background & AIM:** To determine the relevance of the AGE of our diabetic population, control and knowledge of the disease:
- **METHOD:** Quality assurance methodology. Rural Field. Simple random sampling. We collect clinical-analytical biographical data (grouped by age > 35 years old, 36-69, > 70 and frail elderly people), - and we appreciate their understanding of the disease using a validated test, the adherence to treatment by Morinsky- Green test, the family support and the belonging to a diabetes group. G-Stat statistical software. Chi-square.
- **RESULTS:** Fasting Plasma Glucose Control: worse in the population of 36-69 years old, in the rest of the population, the distribution is homogeneous. HbA1c control: 50% (<35 years old), 59.4% (36-69), 84.65% (> 70) and 100% (frail elderly people). Control LDL-cholesterol is worse in <35 years old. Smokers: 15% (> 70), 41.7% (<35) and 1.2% (36 and 69). Hypoglycemia: 50% (<35), 25% (36-69) 11.5 (> 70). Adequate knowledge of the disease. 50% (<35), 22% (36-69) 38.5% (> 70). The rest of the strip of population (intermediate and inadequate) is more homogeneous. The belonging to a diabetes group: 25% (<35), in other ages is practically nil.
- **CONCLUSIONS:** The Age appears as a statistically significant factor in the control of HbA1c levels (probably for different purposes according to age), the percentage of smokers, the risk of hypoglycemia and the belonging to a diabetes group. The other measured variables, including the knowledge of the disease or ad the adherence are not statistically significantly conditioned by age. Knowing the importance of early monitoring we must intensify our efforts in the youngest population.

Keywords: Type 2 Diabetes Mellitus, Age factors, Rural health center

Importance of AGE in Diabetes



The Age appears as a statistically significant factor in the control of HbA1c levels (probably for different purposes according to age), the percentage of smokers, the risk of hypoglycemia

P-0084

COPD guidelines and inhaled corticosteroids. Do we prescribe them correctly in Primary Care?

Xavier Flor¹, Silvia Alvarez¹, Sara Davies¹, Albert Brau¹, Amparo Hervás², Núria Sánchez²

¹Institut Català de la Salut

²CAPSE

AIMS: 1. To determinate the number of patients that are being correctly treated with inhaled corticosteroids (IC) according to the stage and the different guides

2. To determinate the percentage of patients treated correctly according to the stage, severity and the guide used (GOLD or GesEPOC)

METHODS: Multicentric transversal study in Barcelona city. A total of 401 patients diagnosed of COPD and with FEV1/FVC post-bronchodilatation < 0,70 in spirometry test, from 6 primary care centres, were included. The treatment prescribed to the patients was analysed and compared to the recommendations given in both guides. Statistical bivariate analysis was performed.

RESULTS: If we analyse the IC treatment according to GOLD's classification, the highest percentage of prescribed IC is in stage B (81,5%). Although, if we analyse it according to GesEPOC's classification, the highest percentage is in phenotype D (80%). The adequacy of prescribed treatment according to GOLD's guide is correct in 89,5% of the patients in stage B. On the other hand, according to GesEPOC's guide, 70,6% of phenotype C patients have IC correctly prescribed.

CONCLUSIONS: 1. According to GOLD's guide, there's a high percentage of patients in mild and moderate stages who should not have IC prescribed. Regarding GesEPOC's guide, the same happens with phenotype A patients. There is a correct adequacy of prescribed IC in the other stages and phenotypes.

2. Globally, we can observe a better treatment adequacy in mild and very severe stages according to GOLD's guide, and phenotypes A and C in accordance to GesEPOC's guide

Keywords: COPD Corticosteroids Adequacy Guidelines

Sociodemographic data

Variable	Data
Age	70,70 years (SD 9,9)
Men	84,3%
Smokers	35,3%
Package-year	37,91 (SD 21,04)
FEV1/FVC	59,64% (SD 10,03)
FEV1 post	61,52% (SD 17,74)

IC distribution

GesEPOC	Non exacerbator phenotype	Mixed COPD-Asthma phenotype	Exacerbator with emphisema phenotype	Exacerbator with chronic bronchitic phenotype
IC prescribed	30,3% (89/294)	69,8% (30/43)	58,8% (10/17)	80% (36/45)
IC not prescribed	69,7% (205/294)	30,2% (13/43)	41,2% (7/17)	20% (9/45)
GOLD	A	B	C	D
IC prescribed	20,7% (37/179)	41,4% (41/99)	81,5% (22/27)	69,5% (66/95)

IC not prescribed	79,3% (142/179)	58,6% (58/99)	18,5% (5/27)	30,5%(29/95)
-------------------	-----------------	---------------	--------------	--------------

GOLD A and B should not take IC - 100% of mixed COPD-asthma phenotype should take IC - 47,1% of the exacerbators with emphysema phenotype and 55,6% of the exacerbators with chronic bronchitis should take IC

Percentage of patients well treated according to guidelines ans stage

GesEPOC	% well treated	GOLD	% well treated
Non exacerbatos phenotype	50,5% (149/295)		
- Mild	56,3% (133/236)		
- Moderate	26,1% (12/46)	A	58,3% (105/180)
- Severe	33,3% (4/12)		
- Very severe	0% (0/1)		
Mixed asthma-COPD phenotype	47,7% (21/44)		
Mild	46,2% (12/26)		
Moderate	52,9% (9/17)	B	33,3% (33/99)
Severe	0% (0/1)		
Very severe	0% (0/0)		
Exacerbator with emphisema phenotype	70,6% (12/17)		
Mild	60% (3/5)		
Moderate	85,7% (6/7)	C	44,4% (12/27)
Severe	50% (1/2)		
Very severe	66,7% (2/3)		
Exacerbator with chronic bronchitics phenotype	44,4% (20/45)		
Mild	6,7% (1/15)		
Moderate	42,9% (6/14)	D	89,5% (85/95)
Severe	81,8% (9/11)		
Very severe	80% (4/5)		

Baseline treatment vs recomended by guidelines



- The concordance between the baseline treatment and the recomended by GOLD guidelines is moderate (K=0,47); while in GesEPOC is low (k=0,366). - The concordance between both guidelines is about 73,41%, which means a kappa index of 0,58 (moderate concordance).

P-0085

Healthcare improvement through the new technologies: Diabetic Retinopathy Screening in Primary Care and Ophthalmologist teleconsultation

Esther Díaz Salcedo, Mònica Torremorell Núñez, Gemma Puig Ponsico, Maria Jesus García Jordán, Cristina Gallardo Sánchez, Encarna Rodríguez Sánchez, Oriol Huguet Briva, Cristina Viladot Viñas, Xavier Castro Bresco, Rosa Codina Pascual, Marta Albiol Serra
Institut Català de la Salut, Barcelona, Spain

Background and aim

The new technologies development can allow us to streamline the process of ophthalmologist teleconsultation if we detect pathology in diabetic retinopathy screening (DRS) in Primary Care (PC). Therefore, it's reasonable to develop new organizational proposals between healthcare levels to improve system efficiency.

The main objective is to speed up the healthcare process when pathology is detected in DRS, using the teleconsultation. As secondary objective we study the diagnostic concordance between physician and ophthalmologist retinography interpretation, and with the diagnosis doing a direct fundus oculi by the ophthalmologist.

Method

Retrospective descriptive study of 2014

Population: diabetic patients included in the DRS (non-mydratic camera) attended in our PC area and presented pathology suspicion, reason why a teleconsultation is performed.

Variables: Total number performed teleconsultation, retinography realization and ophthalmologist teleconsultation response delay, retinography interpretation diagnostic concordance between physician and ophthalmologist, and with the direct ophtalmoscopy diagnosis, main diagnosis in teleconsultations.

Results: Assigned population: 110153, 4245 diabetic patients, 3650 visits in DRS, 98 teleconsultations (2,7% of the DRS visits). From the 98 teleconsultations, we received 96 ophthalmologist response, and 56 patients needed a classroom visit. Average days delay: between DRS visit and ophthalmologist teleconsultation response, 52 +/- 67'9. Diagnostic concordance: between physician and ophthalmologist retinography interpretation: N: 83, good concordance kappa 0'727 (P<0.001). Between physician retinography interpretation and ophthalmologist classroom visit diagnosis: N: 50, acceptable concordance Kappa 0.444 (P>0.001).

Diagnosis in physician teleconsultation: 46.9% moderate diabetic retinopathy (DR), 14.3% mild DR, 8.2% druses. Diagnosis in ophthalmologist teleconsultation: 38.5% moderate DR, 13.5% other pathologies and doubts, 8.3% druses.

Conclusions: The teleconsultation system between specialized levels allowed to speed up the assitance in suspected pathology diabetic patients of DRS. The ophthalmology service waiting lists have decreased. Phsicians do a good retinography interpretation. Retinography is a good screening tool for the pathology detection.

Keywords: Primary Care, Diabetic Retinopathy, Fundus Oculi

Diagnostic concordance interpretation

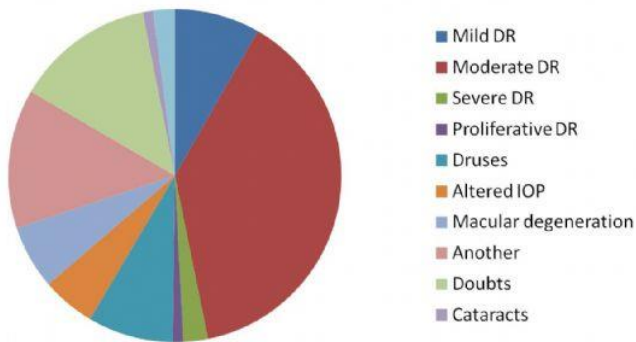
DIAGNOSTIC CONCORDANCE INTERPRETATION	
Retinography (by physician and ophtalmologist)	good concordance (kappa 0.727)
Pshysician retinography int. and Ophtalmologist visit	acceptable (kappa 0.444)

Non-mydratiatic camera



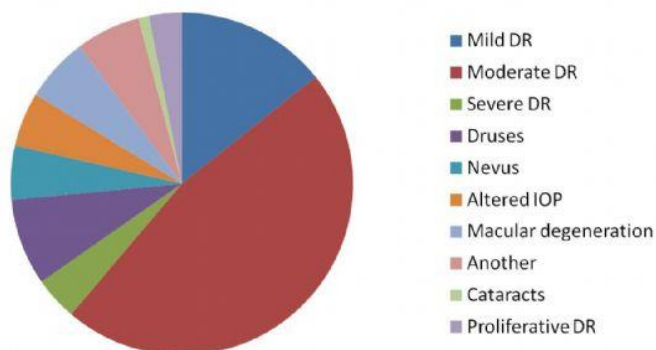
Teleconsultation Ophtalmologist diagnosis

Teleconsultation Ophtalmologist diagnosis



Teleconsultation Physician diagnosis

Teleconsultation Physician diagnosis



P-0086

Prevalence and Treatment Strategy of Essential Hypertension in Type 2 Diabetes Subjects

Estera Muchlyte¹, Zydrune Visockiene¹, Laura Siaulienė³, Ruta Baneviciute Domarkiene¹, Rima Povilioniene¹, Margarita Lasevic¹, Monika Niedvaraitė¹, Dalia Palisaityte¹, Daura Raudonyte¹, Asta Sakaite¹, Roma Puronaite², Vytautas Kasiulevicius¹, Virgilijus Sapoka¹

¹Vilnius University, Faculty of Medicine, Vilnius, Lithuania

²Vilnius University Hospital Santariskiu Klinikos, Vilnius, Lithuania

³Karoliniskiu Outpatient Clinic, Vilnius, Lithuania

BACKGROUND AND AIM: Type 2 diabetes mellitus (T2DM) and essential hypertension (EH) are commonly associated conditions increasing cardiovascular risk. Hypertension prevalence in Lithuanian population is 55%, however the data in diabetic subjects are lacking. The aim of study was to evaluate the prevalence and treatment of EH in T2DM subjects in five outpatient clinics in Vilnius.

METHODS: A retrospective analysis of medical records, collecting data from 2012 and 2013 year was performed in 5 largest Vilnius primary outpatient clinics and included a sample of 1591 randomly selected T2DM patients. Data on basic characteristics, disease duration, diagnosis of EH and treatment were collected. Target blood pressure (BP) was $\leq 130/80$ mmHg.

RESULTS: T2DM patients were $65 \pm 10,9$ years of age, average duration of diabetes was $7,4 \pm 5,9$ years. Hypertension was diagnosed in 91,1% of patients (59,5% women, 40,4 % men). Angiotensin- converting enzyme inhibitors were used in 58,0%, beta- adrenergic blockers - in 50,7%, diuretics – in 41,3%, calcium channel blockers - in 34,1%, angiotensin receptor blockers - in 24,9 %, centrally acting medications - in 22,2%, alpha adrenergic blockers - in 4,0 % of patients. Monotherapy was used in 20,5%, combination with two medications - in 33,4%, three - in 29,7%, four - in 13,2 %, five and more - in 3,2% of subjects. The average systolic BP was $141,5 \pm 17,1$ mmHg, diastolic - $83,5 \pm 9,3$ mmHg. Target BP $\leq 130/80$ mmHg was reached in 8,5% of patients who received one medication and in 5,1% who received combined treatment.

CONCLUSION: Hypertension affects majority of T2DM patients and in most cases requires combination therapy with at least two medications. Angiotensin- converting enzyme inhibitors and angiotensin receptor blockers are used in almost all patient which is in line with treatment guidelines. However, target BP is reached in less than 10% of patients, which shows extremely poor control urging for action.

Keywords: diabetes mellitus, hypertension, ambulatory care

Figure No. 1. Incidence of EH in DM patients.

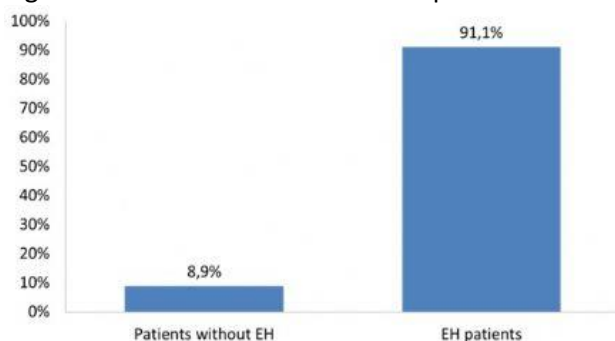


Figure No. 2. The number of medications for EH treatment.

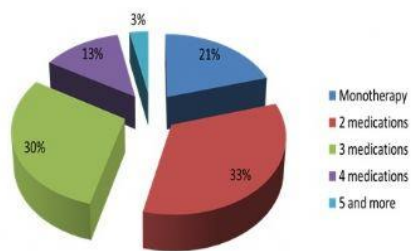


Table No. 1. Used medications.

TOTAL	Number of patients	Percentage
MEDICATIONS		
Angiotensin- converting enzyme inhibitors	841	58,0
Beta- adrenergic blockers	735	50,7
Diuretics	599	41,3
Calcium channel blockers	494	34,1
Angiotensin receptor blockers	361	24,9
Centrally acting medications	372	22,2
Alpha adrenergic blockers	58	4,0

P-0087

The association between hypertension and affective disorders

Bojan Zoran Pavkovic, Marija Marjan Zaric, Marina Slobodan Brankovic
 Department of General Practice, Health Center "Dr Simo Milosevic"

Background & Aim

Medical evidence based on previous studies suggests existence of comorbidity between mental illness and cardiovascular diseases.

The aim of study was to evaluate association between hypertension and affective disorders, such as depression, bipolar disorder and anxiety.

Method

Data were retrospectively collected from medical records of patients with affective disorders during 12 months follow-up in 2014, and statistical analysis was done to evaluate the correlation with hypertension.

Results

A total of 225 adults, aged 20-50 years, were included in study.

Observed population consisted of 106 patients, of which 57 with anxiety, 49 with depression and 17 with bipolar disorder. Control group consisted of 102 subjects, from general population, all without confirmed mental illness. It was found the following prevalence of hypertension - in observed population it was 77%, of which in anxiety subgroup 84%, in bipolar disorder 64%, and in depression 47%. Prevalence of hypertension in control group was 21%. Analysis showed that there was a statistically significant difference in prevalence of hypertension between observed population and control group (p<0.005). Also, there was a statistically significant difference between

each individual subgroup of observed population and control group ($p < 0.005$).

Interesting is the existence of significantly higher prevalence of hypertension among patients with anxiety than in group with depression.

Prevalence of hypertension was significantly higher in group of bipolar disorder than in the anxiety group, but only at level of safety of 0.90, and not at level of safety of 0.95. There was no statistically significant difference between groups of bipolar disorder and depression ($p > 0.05$).

Conclusions

This study demonstrated an association between hypertension and affective disorders.

Prevalence of hypertension is higher among patients with anxiety disorder compared to those suffering from depression.

It is very important in daily practice to review the blood pressure of patients suffering from affective disorders.

Keywords: Hypertension, Depression, Bipolar disorder, Anxiety

P-0088

Depression: Therapeutic Approach in Primary Health Care

Maria Joao Nobre¹, Angelo Costa², Joana Guerra³

¹USF Guadiana, Castro Marim, Portugal

²USF Al-Gharb, Faro, Portugal

³USF Mirante, Olhão, Portugal

Background and AIM:

During our Mental Health internship we had the chance to observe how an assertive therapeutic approach allows a faster recover and avoids worsening of clinical status. Therefore we consider pertinent to do a review about this theme. Our aim was to collect and organize the several recommendations and guidelines about treatment of depression with focus on Primary Health Care.

METHOD: This review work was based on research in Medline with the search engine Pubmed on February/2015 with the following words: “(psychotherapy [MeSH Terms] OR drug treatment) AND (depression [MeSH Terms] AND guideline [MeSH Terms])”. From the articles found, and after reading the abstracts, we select the ones written in English or Portuguese, published between January/2005 and February/2015.

We also research on Portuguese Health General Directorate, European Psychiatric Association and American Psychiatric Association webpages for documents or guidelines related with depression.

These publications were analysed and selected based on its relevance and applicability on clinical practice within the speciality of family medicine.

RESULTS: Psychotherapy can be as effective as pharmacological treatment in minor or moderate depressions.

All antidepressant drugs are effective in depression treatment. The drug selection must take in consideration the safety and tolerability of the drug, the type of depression, the clinical characteristics of the patient (comorbidities), drug interactions, the potential side effects and its cost.

CONCLUSION: There is a wide variety of possible treatments for depression, so the therapeutic choice should be individualized according to the patient and their symptoms.

For optimal clinical response is essential the regular monitoring and therapeutic setting.

Keywords: Depression; Primary care; Therapeutic

Clinical Observations

Clinical Observations	
Fluoxetine	- effective in hypersomnia and hyperphagia - activator - long half-life (2 weeks)
Paroxetine	- in cases of depression and anxiety - usually has discontinuation syndrome
Sertraline	- usefull in elderly patients - escalating dose - can cause panic attacks
Mirtazapine	- fast response - slightly sedative
Venlafaxine	- fast response - safe in high doses
Trazadone	- in case of insomnia
Bupropion	- to avoid sexual disffunction - to smoking cessation at the same time
(Es)Citalopram	- less drug-drug interaction

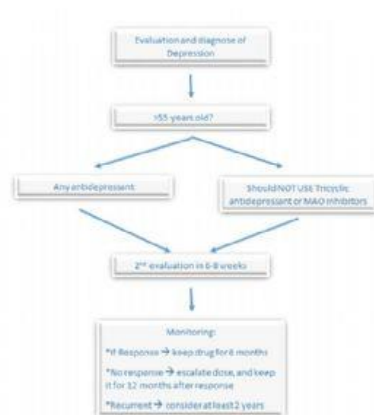
When to referral (Psychiatrist / hospitalization) ?

When to referral (Psychiatrist / hospitalization) ?
- refractory depression (to 2 drugs from diferente classes in high doses)
- Suicidal or homicidal ideas
- Psycotic features
-Catatonia
- Poor judgement
- Grossly impaired functioning

Adverse effects

Common adverse effects	
Diarrhea	Sertraline
Nausea and vomiting	Venlafaxine
Sexual disffunction	Escitalopram fluoxetine, paroxetine, sertraline
Somnolence	Trazadone
Weight gain	Mirtazapina

Decision fluxogram



P-0089

EARLY DETECTION of DIABETIC RETINOPATHY in OUR HEALTH CENTER

Juan Jesus Rodriguez Vallejo¹, Hector Leonardo Lugo Ramos², Jose Maria Fernandez Gonzalez², Pedro Guijo Gonzalez²

¹Delicias Health Center of Primary Care, Jerez de La Frontera, Cádiz, Spain

²Hospital of Jerez, Jerez de la Frontera, Cádiz, Spain

OBJECTIVES

Assess implementation of the Programme for early detection of diabetic retinopathy (PDPRD) in our health center. Knowing the number of retinographies requested by screening family doctors.

Meet the utility and diagnostic concordance between primary care and specialized ophthalmologists.

MATERIAL AND METHODS

Cross-sectional study of 322 retinographies belonging to patients of 15 quotas and registered in the PDPRD of an urban health center with two districts made during two years. Using the platform of the Integral Plan for Diabetes variables were collected: Age, sex, weight, height, BMI, smoking, nephropathy, years of evolution of diabetes, treatment performed, family doctor requesting the test, diagnosis of the physician performing the first reading, diagnosis of ophthalmologist and final state. Data were processed with SPSSv20.

RESULTS

Of the 322 retinographies studied, there were 50% of each sex. The middle age was 65(+/- 10) years. With an average BMI of 29,66kg/m² and an average duration of the Diabetes of 8 years. Through the doctors who performing the screening were diagnosed a total of 107 possible DR(33.2%) that were sent to the ophthalmologist, 8 patients were diagnosed as known and treated DR(2.5%), 1 was not assessable(0.3%) and 206 retinographies were labeled as normal(64%). After the study by the Ophthalmologist of the 107 possible DR, were finally cataloged as such 27 retinographies(25.2%). With a positive predictive value of 25%. While in 21 test were found other retinal findings(19.6%), 1 was not assessable(0.9%) and the rest were classified as normal(54.2%).

CONCLUSIONS

The use of screening by retinographies was irregular among professionals.

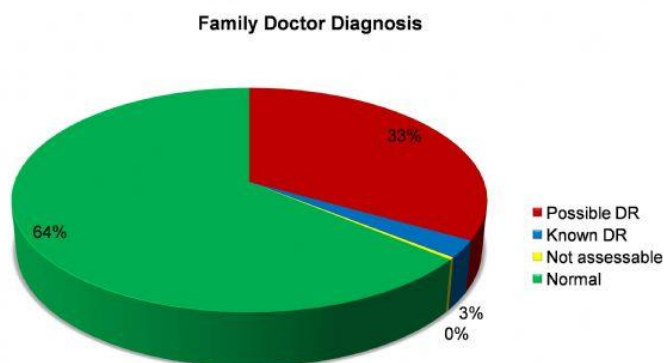
One third of the tests were referred to the ophthalmologist for suspected DR, confirming pathological fourth part of them.

Patients on treatment with insulin have more diabetic retinopathy than the rest.

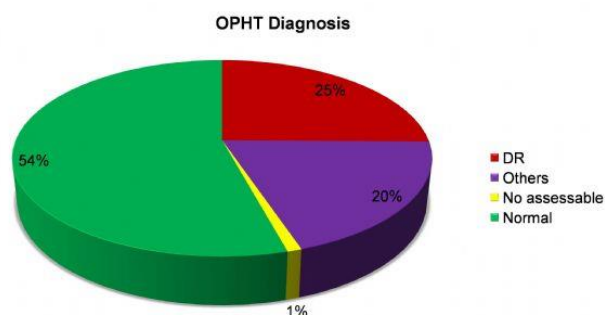
The agreement rate between the family doctor and the ophthalmologist was low, so a more thorough patient monitoring and periodic training of professionals would be required.

Keywords: Diabetic Retinopathy Fundus Oculi Family Practice

FAMILY DOCTOR DIAGNOSIS



OPHT DIAGNOSIS



Headache Performance Protocol in Primary Health Care

Maria João Abreu¹, Célia Machado², Helena Ribeiro³, Nuno Namora¹, Teresa Martins³

¹USF Duovida - ACES do Alto Ave, Guimarães, Portugal

²Department of Neurology, Braga, Portugal

³USF Novos Rumos - ACES do Alto Ave, Vizela, Portugal

BACKGROUND: Headache is a very common and one of the symptoms that most often leads patients to complain to a General Practitioner (GP). It can be disabling, affecting men and women of all age groups. According to the World Health Organization, migraine appears among 20 leading causes of loss of healthy years of life per year.

AIM: To review the literature regarding the approach to headache in Primary Health Care.

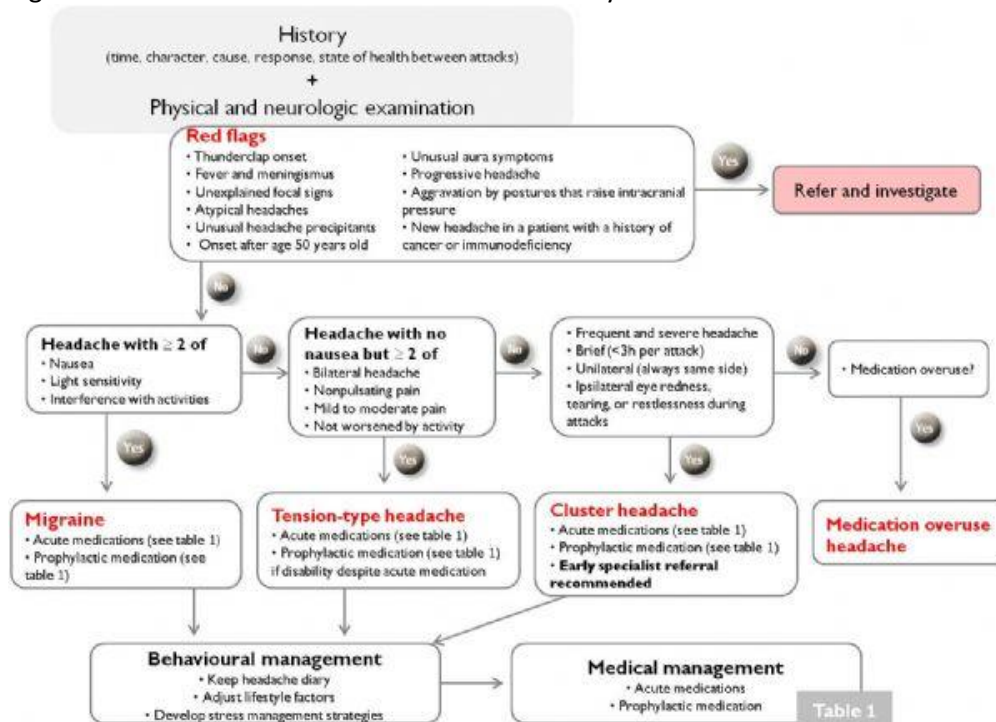
METHODOLOGY: Articles research in Medline/Pubmed, guidelines and specific books in Portuguese or English, using the Mesh terms: "Headache" and "Primary Health Care".

RESULTS: In the evaluation of headache, the clinical history and the physical examination are most important. In Primary Health Care, tension headache, migraine, headache provoked by drug abuse and cluster headache are the most common types, and it is important to recognize that the same individual may experience more than one type of headache. Secondary headaches account for less than 1% of cases, which must be recognized and studied. The additional diagnostic tests, including neuroimaging, are always indicated when the history or physical examination suggest the possibility that it is a secondary headache. Despite headache doesn't have cure, most can be treated effectively. Adequate follow-up of these patients implies the recognition of the treatments (non-pharmacological and pharmacological) available, which represents an important pillar in the control of this problem. Alongside this approach, it is essential that the GP recognizes the criteria for referral to hospital treatment.

CONCLUSION: Headache, beyond its frequency, has a great impact on the quality of life of patients, thus the GP, as the first provider of health care, should be familiar with this approach to be able to monitor symptoms and properly refer the patient to Secondary Health Care, when necessary.

Keywords: Headache, Primary Health Care

Figure 1: Headache Orientation Protocol in Primary Health Care



Adapted from "Guideline for primary care management of headache in adults. Canadian Family Physician. 2015"

Table 1: Medications for migraine, tension-type headache and cluster headache

Type of Headache	Prophylactic medication	Acute medication	
		Step 1: symptomatic therapy	Step 2: specific therapy
Migraine	First line: • Propranolol 40-120mg twice daily • Metoprolol 50-100mg twice daily • Amitriptyline 10-100mg at bedtime • Nortriptyline 10-100mg at bedtime Second line: • Topiramate 50mg twice daily • Candesartan 16mg/day • Gabapentin 1200-1800mg/day divided into 3 doses Other: • Flunarizine 10mg at bedtime	• Acetylsalicylic acid 1000mg (adults) • Ibuprofen 400-800mg • Diclofenac 50-100mg • Ketoprofen 100mg • Naproxen 500-1000mg • Acetaminophen 1000mg	• Almotriptan 12.5mg • Eletriptan 40mg • Frovatriptan 2.5mg • Naratriptan 2.5mg • Rizatriptan 10mg • Sumatriptan 100mg • Zolmitriptan 2.5mg
		± antiemetics: domperidone 20mg or metoclopramide 10mg	
		Tension-type headache	
Tension-type headache	First line: • Amitriptyline 10-100mg at bedtime • Nortriptyline 10-100mg at bedtime Second line: • Mirtazapine 30mg/day • Venlafaxine 150mg/day	• Ibuprofen 400mg • Acetylsalicylic acid 1000mg • Naproxen 500mg • Acetaminophen 1000mg	
Cluster headache	First line: verapamil 240-480 mg/day Second line: lithium 900-1200mg/day Other: topiramate 100-200mg/day	Consider early specialist referral • Subcutaneous sumatriptan 6mg • Intranasal zolmitriptan 5mg • 100% oxygen	

Adapted from "Guideline for primary care management of headache in adults. Canadian Family Physician. 2015" and "European Headache Federation (EHF). European principles of management of common headache disorders in primary care. 2010"

P-0091

Economic impact of costs incurred in monitoring atrial fibrillation. Can we improve efficiency in Primare Care?

Clara Casas, Yuri Ochiai, Isabel Boba, Anna Sanromà, Mercedes Liroz, [Mariam De La Poza](#)
 Centre de Salut Dr. Carles Ribas, Institut Català de la Salut

Background & Aim

Atrial fibrillation (AF) is one of the most prevalent cardiac abnormalities in over 65 years in Spain. Anticoagulant therapy helps prevent the risk of thromboembolic events.

Today we have a new family of oral anticoagulant drugs to which characterizes them less need for monitoring of INR and adjust dose with a favorable safety profile that leads to a reduction of non-pharmacological costs of AF and its complications.

The aims were:

To evaluate the economic cost of INR monitoring of patients with AF treated with acenocoumarol primary care level. Analyze its value compared to other oral anticoagulants in which no monitoring is required.

Methods

We evaluated patients with AF included home care program of an urban health center, during six months (1-9-14/1-3-15)

Cost analysis:

Nonpharmacological direct costs related to monitoring of acenocoumarol (acenocoumarol reflectometer, dipstick), cost of personnel involved and costs of emergency ambulance

Results

N = 29 patients with AF treated with acenocoumarol in home care program.

Costs:

Reflectometer: $2 * 753 = € 1506$

Test Strips: $264 \text{ INR}(1.21) * 264 = € 319.44$

Professionals: Nursing € 1,184, Emergency Medical 1561.2 €, Administrative 712.8 €.

Medical transport for INR > 6 = 4,164.93 (urgent ambulance: € 532.33 and ambulance back: € 62.66)

Acenocoumarol treatment 29 patients: $2.67 € 6m = € 464.58$ / NACO Treatment 6m $90.86 = € 15,809.64$

Nonpharmacological direct cost of entry into hospital: 7 revenues = € 5,901 (Observation + CBC)

Conclusions

The direct cost of monitoring treatment of AF in patients with acenocoumarol household was 17319.95 euros.

This means 1510.31 euros in six months when compared with NACO.

During 6 months, not only save 1510 euros is observed, a liberation center staff could be exchanged for use in enhancing the care of chronic patients.

Keywords: atrial fibrillation, acenocumarol, efficiency

Costs

	Costs	Saving
ACO	17319.95	
NACO	15809.64	-1510.31

.Cost in euros

P-0092

Chronic heart failure. What not to miss in the treatment of our patients

Juan Manuel García López, Verónica Parent Mathias

Department of Emergencies, Regional Hospital, Málaga, Spain

OBJECTIVE: to influence the use of drugs that have shown an increase in survival of patients with chronic heart failure.

METHOD: Review of clinical practice guidelines of the European Society of Cardiology.

All family doctors have to treat patients with chronic heart failure and we must consider that there are three groups of drugs that should not be missed in the treatment of our patients:

- Angiotensin-converting enzyme inhibitors (ACEIs): If the patient is allergic to these medicines or present adverse effects (cough), is indicated using antagonists of angiotensin II (ARA II).
- Beta-blockers (BB): There is consensus that treatment should be initiated BB in combination with ACE inhibitors / ARBs as soon as heart failure diagnosed with depressed ejection fraction (<40%). They get improved ejection fraction and have anti-ischemic properties. The combination of both treatments achieved dramatically reduce mortality. They are contraindicated in asthma but not in COPD, where we employ selective beta receptor antagonists (bisoprolol, metoprolol, nebivolol). Nor are contraindicated in diabetics.
- Mineralocorticoid receptor antagonists: they have also demonstrated reduced mortality, but should only be used in patients with normal renal function and normal potassium levels. When employed, should monitor renal function and potassium.

It should be noted that diuretics have only shown improvement in terms of congestive symptoms, but not in terms of mortality improvement.

In the table, you can see the dose of the most common drugs of these groups.

Keywords: treatment, chronic, heart failure

dose

Table 14 Evidence-based doses of disease-modifying drugs used in key randomized trials in heart failure (or after myocardial infarction)

	Starting dose (mg)	Target dose (mg)
ACE inhibitor		
Captopril ^b	6.25 t.i.d.	50 t.i.d.
Enalapril	2.5 b.i.d.	10–20 b.i.d.
Lisinopril ^b	2.5–5.0 o.d.	20–35 o.d.
Ramipril	2.5 o.d.	5 b.i.d.
Trandolapril ^b	0.5 o.d.	4 o.d.
Beta-blocker		
Bisoprolol	1.25 o.d.	10 o.d.
Carvedilol	3.125 b.i.d.	25–50 b.i.d.
Metoprolol succinate (CR/XL)	12.5/25 o.d.	200 o.d.
Nebivolol ^b	1.25 o.d.	10 o.d.
ARB		
Candesartan	4 or 8 o.d.	32 o.d.
Valsartan	40 b.i.d.	160 b.i.d.
Losartan ^{b,c}	50 o.d.	150 o.d.
MRA		
Eplerenone	25 o.d.	50 o.d.
Spironolactone	25 o.d.	25–50 o.d.

ACE = angiotensin-converting enzyme; ARB = angiotensin receptor blocker; b.i.d. = bis in die (twice daily); MRA = mineralocorticoid receptor antagonist; o.d. = omni die (once every day); t.i.d. = ter in die (three times daily).

^bIndicates an ACE inhibitor where the dosing target is derived from post-myocardial infarction trials.

^cIndicates drugs where a higher dose has been shown to reduce morbidity–mortality compared with a lower dose of the same drug, but there is no substantive placebo-controlled randomized controlled trial and the optimum dose is uncertain.

^dIndicates a treatment not shown to reduce cardiovascular or all-cause mortality in patients with heart failure or after acute myocardial infarction (or shown to be non-inferior to a treatment that does).

recomendations

Pharmacological treatments indicated in potentially all patients with symptomatic (NYHA functional class II–IV) systolic heart failure

Recommendations	Class ^a	Level ^b	Ref ^c
An ACE inhibitor is recommended, in addition to a beta-blocker, for all patients with an EF ≤40% to reduce the risk of HF hospitalization and the risk of premature death.	I	A	87–91
A beta-blocker is recommended, in addition to an ACE inhibitor (or ARB if ACE inhibitor not tolerated), for all patients with an EF ≤40% to reduce the risk of HF hospitalization and the risk of premature death.	I	A	92–98
An MRA is recommended for all patients with persisting symptoms (NYHA class II–IV) and an EF ≤35%, despite treatment with an ACE inhibitor (or an ARB if an ACE inhibitor is not tolerated) and a beta-blocker, to reduce the risk of HF hospitalization and the risk of premature death.	I	A	99, 100

ACE = angiotensin-converting enzyme; ARB = angiotensin receptor blocker; EF = ejection fraction; HF = heart failure; MRA = mineralocorticoid receptor antagonist; NYHA = New York Heart Association.

^aClass of recommendation.

P-0093

Hirschsprung's disease – Warning signs

Raquel Cardoso Abreu¹, Andreia Filipa Lopes Fernandes², Catarina Ferreira Leite³, Joana Silva Parente⁴

¹Family Health Care Unit Pro Saúde, Vila Verde

²Family Health Care Unit Alcaides Faria, Barcelos, Portugal

³Family Health Care Unit AmareSaude, Amares, Portugal

⁴Family Health Care Unit São Lourenço, Braga, Portugal

Background&AIM: Alert to the signs and symptoms of the Hirschsprung disease. Describe the clinical characteristics of a newborn with congenital aganglionosis total diagnosed.

Hirschsprung's (DH) disease or aganglionosis is characterized by an absence of ganglion cells and intestinal segment ganglia, being named Meissner submucosal plexus and myenteric Auerbach, respectively.

Newborn (NB), female, with a gestational age of 33 weeks and 5 days. With 18 days, resorts to his family doctor (FD), by presenting a erythema in the region peri anal in extension, being diagnosed by diaper rash.

After six days he comes back due to intense crying. His Mother Refers that the NB has had less faeces after feedings, despite having good breastfeeding.

The objective examination shows abdomen very distended and bloat to percussion.

The mother says that the NB has eliminated meconio only on the 3rd day of his life.

Faced to a patient suspected to have Hirschsprung's disease, evidenced from anamnesis and physical examination, begins the diagnostic investigation. The plain abdominal radiography may reveal gaseous distension of colon handles and the level of obstruction can be inferred by the presence of air in the colon or rectum non-dilated. The definitive diagnosis of Hirschsprung's disease should be established by histopathological examination, allows the view the ganglion cells of the enteric nervous system in tissue samples obtained by rectal biopsies.

METHOD: Case Report–Study of signs and symptoms of DH

RESULTS: Symptoms can start immediately after birth, with a delayed elimination of meconium. Other times, the history of the disease is a chronic constipation. The difficulty in eliminating feces will involve a intestinal dilatation and abdominal distension. This situation can be complicated by the proliferation of bacteria and consequent infection of variable severity.

CONCLUSIONS: The diagnosis should be suspected in any newborn with delayed intestinal transit or in children with history of chronic constipation since the neonatal period.

Keywords: Hirschsprung's disease, aganglionose

Hirschsprung's disease



P-0094

Breaking the Barriers: Addressing the Patient's Understanding about Insulin in Type 2 Diabetes in Primary Care Clinic

Abdul Hafiz Mohamad Gani

Department of Health, Federal Territory of Labuan, Labuan, Malaysia

BACKGROUND: Resistant in accepting insulin as a part of diabetes treatment is a common scenario facing by most of primary care physician. Patients have their own perception in addition to the information that they received which may contribute to their compliance of treatment plan.

AIM: To identify patient myths and clinical facts that may affect their decision on insulin as one of the treatment option in Type 2 Diabetes

METHOD: 384 registered Type 2 Diabetes patients in Primary Care Clinic in Labuan, Malaysia were randomly selected. Patients who are on insulin were excluded from the study. The questionnaires consisted of socio-demographic and lists of ten questions on the most important barriers were given to them. They were also given option whether to accept insulin treatment if advice by doctor in the future.

RESULTS: Based on the interviewed data, 71.3% (n: 274) of them knew or have heard of insulin. Only 11.1% of them disagreed that insulin is given only to diabetic patient with uncontrolled blood glucose level only. However, majority of the patients agreed that insulin should be kept in a special place. Those with high score (correctly answered the questionnaires) have better acceptance toward insulin for diabetic management.

CONCLUSIONS: It is important to address the patient's understanding about insulin in Type 2 Diabetes before the decision to initiate insulin in order to rectify any misconception. Those with proper understanding regarding insulin have better acceptance towards insulin use in diabetic treatment.

Keywords: Insulin, Barriers, Type 2 Diabetes Mellitus, Primary Care

Statement Regarding Insulin

STATEMENT REGARDING INSULIN	AGREED n (%)	DISAGREED n (%)	UNSURE n (%)
Insulin is one of the best option in blood glucose control	154 (74.4)	37 (17.9)	16 (7.7)
Insulin is the end resort of treatment	154 (74.4)	43 (20.8)	10 (4.8)
Insulin is given only to those with poor diabetic control	170 (82.1)	27 (13.0)	10 (4.8)
Insulin usage in a long term may cause end organ damage	95 (45.9)	89 (43.0)	23 (11.1)
Insulin may cause hypoglycaemia	103 (49.8)	78 (37.7)	22 (10.6)
I have phobia of using insulin	155 (74.9)	47 (22.7)	5 (2.4)
Insulin injection is painful	107 (51.7)	78 (37.7)	22 (10.6)
Insulin may cause weight gain	43 (20.7)	126 (60.9)	38 (18.4)
Insulin is inconvenient compared to oral diabetic medication	146 (70.5)	46 (22.2)	15 (7.2)
Insulin should be kept in a special place	169 (81.6)	22 (10.6)	16 (7.7)
Insulin limit s or disturbs daily activity	97 (46.9)	94 (45.4)	16 (7.7)
Insulin may cause drug addiction	29 (14.0)	143 (69.1)	35 (16.9)
Insulin is unlawful for Muslim patients	65 (31.4)	114 (55.1)	28 (13.5)

P-0095

Recurrent epistaxis, more than a nasal mucose alterations

Miriam Rey Seoane¹, Rabee Kazan³, Cristina Herranz Martinez¹, Ana Rascón García⁴, Julio Verastegui Cordova⁴, Franco Paniccia Cuocco²

¹Hospital de Viladecans, Barcelona, Spain

²Hospital Los Camilos, Barcelona, Spain

³Hospital La Mutua de Terrasa, Spain

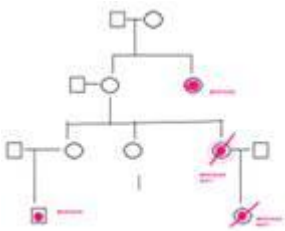
⁴CAP El Castell Castelldefels, Spain

Spontaneous recurrent epistaxis is usually the earliest sign of Hereditary Hemorrhagic Telangiectasia (HHT) but in this case a casual finding in a x-ray did the diagnosis.

We present a 46 years-old female who consulted her doctor about continuous and recurrent epistaxis since the age of 24. She had clinical history of hypothyroidism, herpes zoster, discal hernia, 3 miscarriages, chronic depression. Medication. Eutirox. She referred chronic recurrent epistaxis and some tongue telangiectasia in years prior to consultation. Physical examination is normal, otorrinolagingology examination only reflects a alteration in the nasal mucosa. As a complimentary test a chest x-ray was demanded, and was commented as a alteration in the upper-right pulmonary lobe and a radiologist recommended a CT-scan. In the CT-SCAN a nidus, an arteriovenose malformation around 3,1 cm in the upper-right. pulmonary lobe was been detected and in concur with all the others clinical simtons a diagnosis was made. Differential diagnosis in recurrent epistaxis is basic in primary care but illness such as HHT are usually not in the equation, things like hypertension, nasal mucosa alteration (allergic rhinitis, arterial malformation) or blood coagulation alterations. Casual findings in other complementary test could be our best resource to solve an years problem.

Keywords: Epistaxis, telangiectasia, nose diseases, hereditary hemorrharric telangiectasia

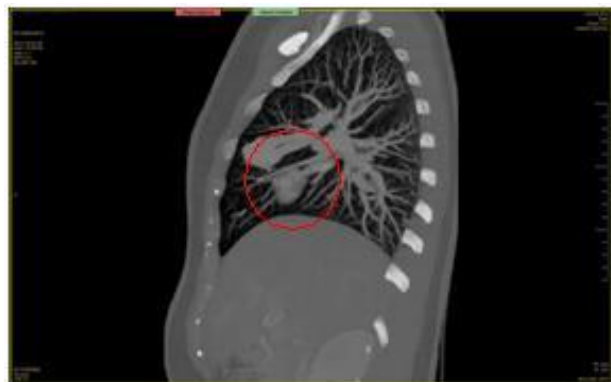
tree



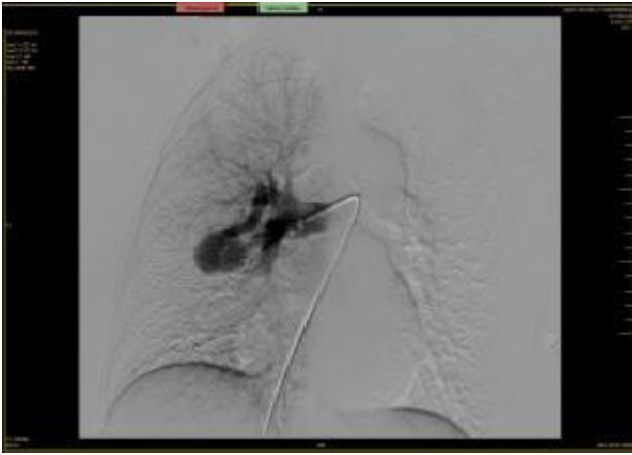
tx1



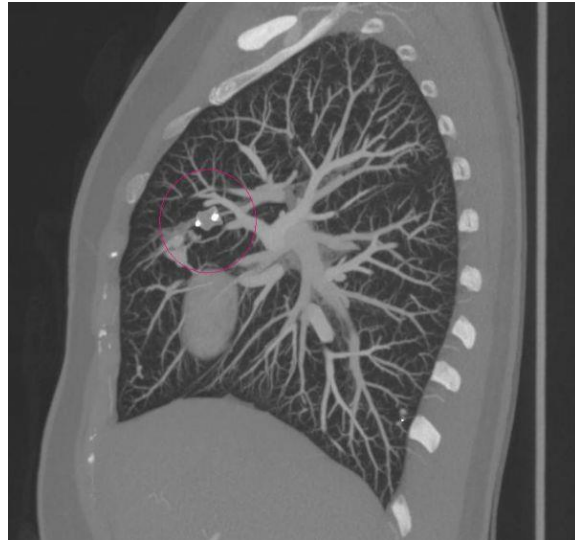
tac1



angitc



result



P-0096

Proposal of a Primary Care follow-up protocol for management of patients with chronic Heart Failure

Joana Ribeiro¹, Luís Santos², Tiago Adrega², Patrícia Morgado¹, Sofia Madanelo³, José Santos²

¹Unidade de Cuidados de Saúde Primários Aveiro I, ACES Baixo Vouga

²Department of Cardiology, Centro Hospitalar do Baixo Vouga, Aveiro

³Unidade de Saúde Familiar Santa Joana, ACES Baixo Vouga

BACKGROUND: Due to ageing population and burden of ischemic heart disease, Family Physicians (FP) are increasingly entailed to face the challenging patients with chronic Heart Failure (HF).

Although the bulk of these patients have hospital follow-up, they frequently resort to the FP, mainly due to aggravated symptoms, other comorbidities and prescription renewal.

It is therefore essential that the FP is informed about the condition and accordingly prepared for appropriate clinical management. For these reasons, we propose a clinical protocol to improve clinical practice excellence in this setting, and adapted to the Primary Care reality.

AIM: I. Individualization of care in patients with HF (NYHA class \leq II) with up-to-date evidence; II. Improve patient's quality of life; III. Prevent hospital admissions; IV. Hamper HF progression; V. Decrease the disease's economic burden; VI. Foster collaboration between Primary and Secondary Care.

METHODS: We evaluated the international guidelines with more scientific impact and performed additional literature search on HF. The information was organized and adapted in consonance with Primary Care challenges. The project was carried out with the help of Cardiology and FP experts. Finally, it has been proposed for presentation to FP of the hospital referral area.

RESULTS: an integrator document was conceived, directed to FP, proposing decision-making flow charts designed to guide the clinical judgment, and consists of eight main points: I. Patient and caregiver information and education; II. Provide social support; III. Lifestyle modification and control of risk factors; IV. Clinical monitoring (symptoms, physical examination, drug's iatrogenesis, concomitant diseases); V. Analytical, electro and echocardiographic management; VI. Pharmacological management; VII. Control of comorbidities (namely vaccination); VIII. Red flags for hospital referral.

CONCLUSION: The existence of protocols adapted to the reality of Primary Care underpin a valuable resource to optimize medical performance and ensure excellence of care for patients with chronic HF.

Keywords: Chronic Heart Failure; Primary Care; protocol; clinical management; follow-up; guidelines.

Summary of the guidelines described in the protocol for follow-up of patients with heart failure by the family doctor

I. Patient and caregiver information and education	<p>Provide information about the disease, the causes and treatment Reinforce the importance of adherence to therapy; Understand the indications, doses and effects of drugs; Teaching self-management of symptoms and warning signs</p>
II. Provide social support	<p>Family support assessment Assess the need for psychosocial support</p>
III. Lifestyle modification and control of risk factors	<p>Provide information about risk factors: - alcohol [Discouraging alcohol; consumption <2U / alcohol / day in men and <1 U / day in women] - tobacco [Stop; provide medical assistance required] - physical exercise [Regular physical activity of low intensity; 30 minutes per day during 5 weekdays] - dietary changes [Consumption <2-3g / sodium daily; water restriction <2L / day; warn of risk of malnutrition in advanced stages; consider evaluation by nutritionist] - Therapeutic alternatives [Warn of the risk of these therapies may interfere with heart function]</p>
IV. Clinical monitoring	<p>Physical examination Symptoms / signs - Related to heart failure - Related to causes of decompensation or therapy (drug's iatrogenesis) - Related to concomitant diseases</p>
V. Analytical, electro and echocardiographic management	<p>Analysis: Renal function and ionogram [regularly because side effects of HF therapeutic] Hepatic Function Hemogram [if signs or symptoms of anemia] Inflammatory markers [if signs or symptoms of infection] Thyroid function [if pathology suspected_ pro-arrhythmic risk]</p>
	<p>Ecocardiograma If signs or symptoms new or worsened [no routine indication]</p>
	<p>Electrocardiogram If arrhythmia suspected If signs or symptoms new or worsened [no routine indication]</p>
VI. Pharmacological management	<p>Dose adjustment of therapeutic drug Depending of clinical evolution, side effects and comorbidities</p> <ul style="list-style-type: none"> - ACE inhibitor: all patients with EF ≤ 40% - B-blockers: in addition to an ACE inhibitor in all patients LVEF ≤40% with a - MRA: persistent symptoms (NYHA classII-IV) and LVEF ≤ 35% despite treatment with an ACE inhibitor and a beta blocker. - Ivabradine: persistent symptoms (NYHA classII-IV) and EF ≤ 35% despite treatment with an ACE inhibitor, beta blocker and MRA. - Diuretics: control congestive symptoms.
VII. Control of comorbidities	<p>Vaccination (influenza virus; anti-pneumococcal vaccine) Early and timely response to patients with inflammatory / infectious symptoms</p> <p>Early diagnosis of factors that can be prevented and that can cause</p>

decompensation:

- Diabetes mellitus [avoid hypoglycemia; avoid glitazones; keep controlled HbA1C]
- Dyslipidemia
- Blood pressure
- Anemia
- Depression [leads to worse prognosis tricyclic antidepressants should be avoided]
- Obesity
- Sexual dysfunction
- Drop [avoid nonsteroidal anti-inflammatory drug; use colchicine]
- Sleep apnea syndrome [independent factor of poor prognosis; identify and treat]
- Travels [Traveling always accompanied by a report with medical history, the updated therapeutic and supplementary medication]

Acute clinical decompensation (referral to ER);

Worsening of symptoms despite optimal therapy

Worsening of ventricular function by echocardiography

Other concomitant pathology that requires evaluation by a cardiologist

Family doctor's difficulty in managing therapy/ symptoms

VIII. Red flags
for hospital referral

The table summarizes the main guidelines to be considered in the follow-up of patients with heart failure, which are described in the protocol proposal [Note: Most patients with heart failure are followed in the cardiologist, the Indications for referral is intended for patients who require early consultation by cardiologist or observation in the ER] [HbA1c: hemoglobin A1c; HF: Heart Failure; ACE inhibitor: angiotensin-converting-enzyme inhibitor; LVEF: Left Ventricular Ejection Fraction; MRA: Mineralocorticoid Receptor Antagonist; NYHA: New York Heart Association (NYHA) Functional Classification; ER: Emergency Room]

P-0097

Proposal of a Primary Care follow-up protocol for management of patients with Valvular Heart Disease

Joana Ribeiro¹, Luis Santos², Tiago Adrega², Bruno Oliveira¹, Patrícia Morgado¹, José Santos²

¹Unidade de Cuidados de Saude Primarios Aveiro I, ACES Baixo Vouga

²Department of Cardiology, Centro Hospitalar do Baixo Vouga, Aveiro

BACKGROUND: Valvular Heart Disease (VHD) is a burgeoning condition in patients accompanied by Family Physicians (FP) that demands close monitoring since it often requires intervention.

The observation of patients diagnosed with VHD is often performed in parallel between Primary and Secondary Health Care, especially in patients with compensated, non-critical VHD.

It is therefore essential that the FP is informed about the condition and accordingly prepared for appropriate clinical management of these patients. For these reasons, we propose a clinical protocol to improve clinical practice excellence in this setting, and adapted to the Primary Care reality.

AIM: I. Standardization of care in mild to moderate cases and those stabilized after intervention, with up-to-date evidence; II. Increase disease morbidity and mortality; III. Foster collaboration between Primary and Secondary Care.

METHODS: We evaluated the international guidelines with more scientific impact and performed additional literature search on VHD. The information was organized and adapted in consonance with Primary Care challenges. The project was carried out with the help of Cardiology and FP experts. Finally, it has been proposed for presentation to FP of the hospital referral area.

RESULTS: an integrator document was conceived, directed to FP, proposing decision-making flow charts designed to guide the clinical judgment, and consists of seven main points: I. Patient information and education; II. Clinical monitoring (symptoms, physical examination, drug's iatrogenesis, concomitant diseases); III. Control of risk factors related to disease progression and endocarditis; IV. Control of comorbidities; V. Pharmacological management (namely anticoagulation in mechanical valves); VI. echocardiographic follow-up; VII. Red flags for

hospital referral.

CONCLUSION: The existence of protocols adapted to the reality of Primary Care underpin a valuable resource to optimize medical performance and ensure excellence of care for patients with VHD.

Keywords: Valvular Heart Disease; Primary Care; protocol; clinical management; follow-up; guidelines.

Follow-up of asymptomatic patients with mild-moderate valvular disease after evaluation by cardiology

	Symptoms / Physical Examination	Complementary means of diagnosis	Referencing
Aortic stenosis (AS) (A regular follow-up should be determined by the initial clinical evaluation and at each visit)	- Fatigue - Dyspnea - Dizziness - Syncope - Angina Auscultation: systolic ejection murmur (compare with previous evaluation)	Echocardiogram: Mild AS: 1-2 Years Moderate AS: 6 Months -1 Year	Presence of symptoms If asymptomatic but severe AS [Mean gradient > 40 mmHg Area <1cm ²]
Mitral Regurgitation (MR) (Primary) [Degenerative factors; rheumatic fever]	- Dyspnea - Fatigue Systolic murmur (not related to the severity) 3rd heart sound (compare with previous evaluation)	Echocardiogram: Mild MR (asymptomatic): 2-3 Years Moderate MR: Annual	Presence of symptoms AF; doubts regarding to anticoagulation
Aortic Regurgitation (AR)	- Decreased diastolic pressure - Increased arterial pulses - Dizziness Protodiastolic blow (compare with previous evaluation)	Electrocardiogram / Holter: annual Echocardiogram: Mild AR: 2-3 Years Moderate AR: Annual	Severe MR Presence of symptoms Severe AR
Mitral Stenosis (MS)	- Palpitations - Dyspnea - Fatigue Systolic murmur; Opening snap (hard to listen) (compare with previous evaluation)	Mild MS: 2-3 years; Moderate MS: 1-2 years; Holter: Annual	Presence of symptoms Severe MS

This table summarizes the main indications proposals for follow-up by family physicians of patients with valvular disease non-surgically intervened

Proposal for follow-up, by family doctor, of asymptomatic patients with history of surgical intervention to valvular disease

Biological prostheses / valvuloplasty

Prosthetic Valves

Clinical evaluation	Auscultation of the prosthetic sound [compare with previous evaluation]	Auscultation of the prosthetic sound [compare with previous evaluation] Continuous anticoagulation With Vitamin K Antagonists (VKA) (Are contraindicated new oral anticoagulants) [INR -> 2-3 If mitral or tricuspid prosthesis -> 2.5-3.5]
Anticoagulation	No need continuous anticoagulation	[Allow for patients with high thromboembolic risk: Atrial Fibrillation; mitral or tricuspid valve prosthesis; Thromboembolism history; LVEF <35%; mitral stenosis] Interruption: minor surgical procedures: consider not stop Major surgical procedures: Keep INR <1.5; stop VKA; do LMWH in therapeutic dose bid;
Endocarditis risk	Dental assessment and regular dental hygiene; Prophylaxis for dental risk procedures: (30-60 minutes prior to the procedure) - Amoxicillin 2 g po ev - Clindamycin 600mg po ev (if allergy to beta-lactam) In case of infection (respiratory, gastro-intestinal, genitourinary or dermatological, include the antibiotic treatment agent against Staphylococcus).	Dental assessment and regular dental hygiene; Prophylaxis for dental risk procedures: (30-60 minutes prior to the procedure) - Amoxicillin 2 g po ev - Clindamycin 600mg po ev (if allergy to beta-lactam) In case of infection (respiratory, gastro-intestinal, genitourinary or dermatological, include the antibiotic treatment agent against Staphylococcus).
Hemolysis risk	Without increased risk	- Complete blood count; - Haptoglobin; - LDH; Treatment: iron supplements; beta-blockadores; erythropoietin.
Echocardiogram	Yearly If further changes to auscultation (worsening of murmur, absence of the prosthetic sound	Yearly If further changes to auscultation (worsening of murmur, absence of the prosthetic sound
Referencing	- New symptoms; - Changes in cardiac auscultation (worsening of murmur); - Suspected endocarditis; - Difficulty in the management of antibiotic prophylaxis at risk procedures; - Echocardiographic signs of prosthetic dysfunction.	- New symptoms; - Changes in cardiac auscultation: worsening of murmur, absence of hearing the prosthetic sound - Difficulty in managing anticoagulation; - Suspected endocarditis; - Suspected hemolysis; - Difficulty in the management of antibiotic prophylaxis at risk procedures; - Echocardiographic signs of prosthetic dysfunction.

The proposal takes into account the main care that should be part of the evaluation of these patients: clinical, the main risk factors (thromboembolic, endocarditis, hemolysis), imaging tests and the criteria for referral depending on the type of intervention (biological or mechanical prosthesis) [LVEF: Left Ventricular Ejection Fraction; INR:

P-0098

Comorbidity in patients included in the program of Planned Home Care in the province of Lecce

Ernesto Mola¹, Silvia Aprile², Maria Alessandra Carrozzo²

¹Interdisciplinary Scientific Association of both Family and Community Medicine - ASSIMEFAC

²Vocational training in General Practice - Medical College of Lecce Province

Background

Comorbidity has been defined as the presence of two or more diseases in the same individual. It is a common condition in elderly people and a challenge mainly for general practitioners (GPs), because it implies a contemporary management of diseases of different organs and apparatus. In Italy about 5% of elderly patients are included in the program of Planned Home Care (PHC) by GPs, with a different care burden in relation with comorbidity.

Aims

- to know the predominant diseases among patients included in the program of PHC in the health district of Lecce and calculate Charlson and Barthel indexes.
- To measure the care burden in relation with comorbidity.
- To know which diseases are treated with drugs and the number of drugs daily taken.
- To know the perception of the comorbidity by patients and FDs.

Design

The trainees of the vocational training in General Practice of the Medical College of Lecce recruited the patients included in the PHC of the trainer GP. Then, for each patient they completed a form of five sections. The first three sections concerned the data of patient, the section D was a questionnaire to the FD, and the section E a questionnaire to the patient.

Results

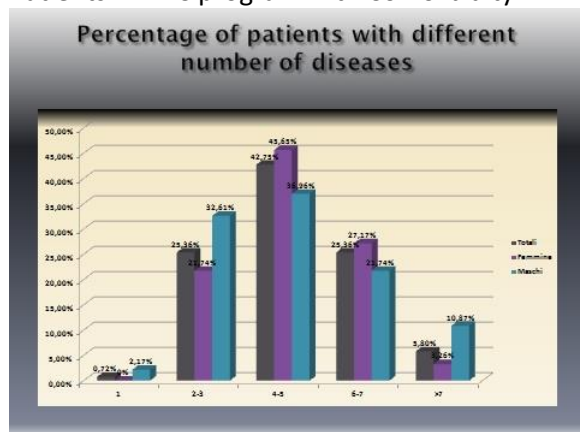
138 patients have been recruited, 92 women and 46 men. 67,9% need a help for gait and 41,30% are cared by a salaried caregiver. The predominant diseases are heart failure (42,03%) and cerebro-vascular disease (49,28%). While patients perceive rheumatic diseases (37.30%) as the most important illnesses, only 40% receive a treatment for them and only 3 out of 138 rehabilitative care.

Conclusions

Comorbidity in elderly patients is a big challenge for primary care. Health services should pay specific attention to needs and expectation of patients, and should tailor care on individual conditions.

Keywords: Comorbidity, General Practitioners, Rheumatic diseases

Patients in PHC program with Comorbidity



P-0099

Chronic wounds and seasons. Is there a relationship?

Anna Lanau Roig, Ángel Casado Bech, Teresa Graell Riera, Julian Martín Martín, Laia Martí Clavé, Andrea Moncau Mayola

Health centre La Marina, Institut Català de la Salut, Barcelona, Spain

BACKGROUND:

Chronic wounds have different etiologies: pressure ulcers, varicose ulcers, arterial ulcers, neuropathic ulcers and other wounds healing by second intention. All they have one thing in common, the difficult healing.

Chronic wounds represent a significant consumption of resources, material and human.

AIM:

Knowing the correlation between the incidence of chronic wounds and:

- The season
- The temperature.

METHOD:

Cross-sectional retrospective study of January 1 to December 31, 2013, with a population of 15,389 persons, aged more than 15 years, attended in a primary health care of Barcelona.

Variables were collect, through medical story, which included gender, age, wound type and date of appearance.

The monthly mean temperature values were provided by the official meteorological service.

For statistical analysis wounds were grouped according to their etiology, the season and the mean temperature.

We worked with confidence intervals of 95%.

RESULTS:

Were located 48 chronic wounds. The mean age was 72.04 years with a standard deviation (SD) of 5.78, 52.1% were women and 47.9% men.

62.5% were leg ulcers (LU), 22.9% other chronic wounds healing by second intention and 14.6% pressure ulcers (PP).

The data showed a higher incidence of LU and PP (76.7% and 71.4% respectively) in the warm seasons (spring-summer), although no statistically significant difference ($p = 0.159$) for the cold seasons (autumn-winter).

No statistically significant differences were observed ($p = 0.544$) when comparing the average temperature at the moment of appearance the wounds.

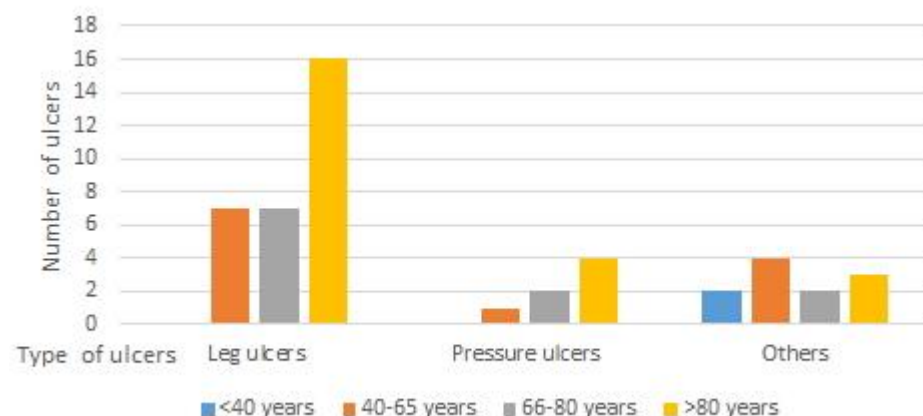
CONCLUSIONS:

A trend is observed at a higher incidence of LU and UPP in the warm seasons. A larger sample could be statistically significant. There is no relationship between the season and the appearance of other chronic wounds healing by second intention.

There is no relationship between temperature and the appearance of chronic wounds.

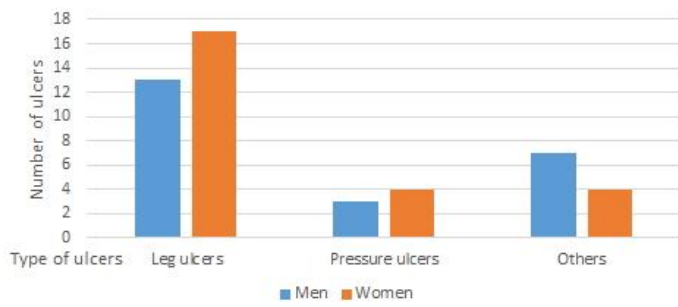
Keywords: skin ulcer, season, temperature, nursing care, primary health care,

Figure 1. Skin ulcers depending on age



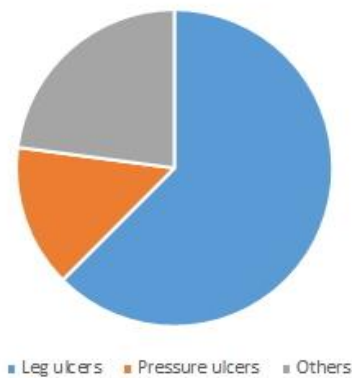
LU and PU are more common in people over 80 years

Figure 2. Skin ulcers depending on the sex



No statistically significant differences between men and women

Figure 3. Type of chronic wounds



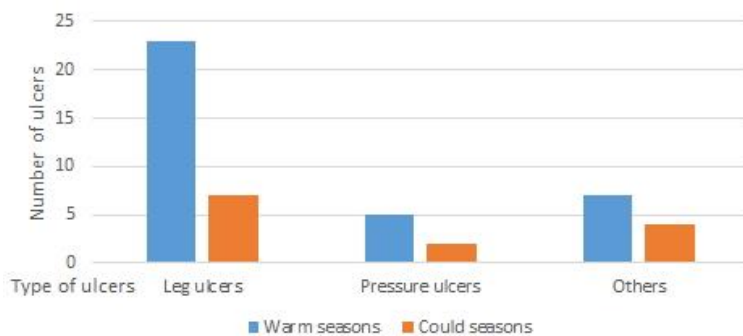
The most common chronic wounds are chronic leg ulcers

Figure 4. Average monthly temperature 2013



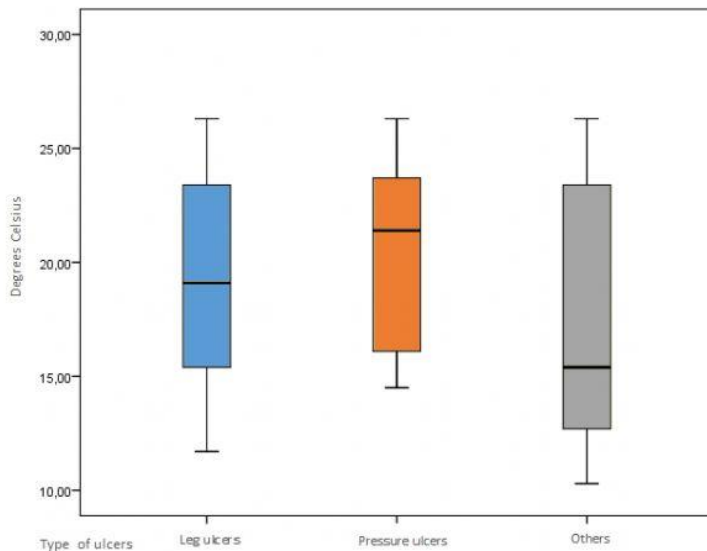
From April to September have been considered warm seasons From Octure to May have been considered cold seasons

Figure 5. Incidence of skin ulcers depending on season of year



In the warmer seasons there is more incidence

Figure 6. Incidence of skin ulcers depending on the ambient temperature



P-0100

Case-mix adjusted differences in the treatment of cardiovascular risk factors in patients with type 2 diabetes in Sweden

Mikael Lilja¹, Bettina Julin², Gudrun Andersson³, Inga Lena Andersson⁴, Mette Axelsson⁴, Robert Kristiansson⁵, Janeth Leksell³, Agneta Lindberg⁶, Peter Lindgren², Fredrik Löndahl⁷, Karin Loström Muth⁸, Ann Marie Svensson⁹, Tobias Dahlström¹⁰

¹Department of public health and clinical medicine, Family medicine, Östersund unit, Umeå university, Sweden

²Ivbar, Stockholm, Sweden

³The Swedish Society of Diabetes nursing

⁴The Swedish association of clinical dietitians

⁵The county council of Uppsala, Uppsala, Sweden

⁶The county council of Skåne, Malmö Sweden

⁷The association of Swedish diabetes patients

⁸The region of Västra Götaland, Vänersborg, Sweden

⁹Swedish National Diabetes Register, Göteborg, Sweden

¹⁰The county council of Dalarna, Falun, Sweden

BACKGROUND AND AIM

Proper management of cardiovascular risk factors constitutes a cornerstone in the management of type 2 diabetes. Prescription patterns vary across Sweden. However, to what extent this variation remains if account is taken to differences in patient populations has not been studied. As part of the ongoing National Collaboration for Value Based Reimbursement and Monitoring Systems, we set out to investigate this by conducting a case-mix adjusted comparison of the participating county councils.

METHODS

Persons with a health care contact and a diagnosis of diabetes during 2010-11 in the administrative systems of seven Swedish county councils (Dalarna, Jämtland Härjedalen, Skåne, Stockholm, Uppsala, Västra Götaland and Östergötland), covering ~70% of the Swedish population was linked to data from the National Diabetes Register, socioeconomic data from Statistics Sweden and data on filled prescriptions from the Prescribed Drug Register. We estimated random effects models on the number of antihypertensive classes the patients received during one year following inclusion and whether or not the patient received a statin, adjusted for age, gender, level of education, civil status, duration of diabetes, the presence of diabetic complications, systolic blood pressure, LDL-cholesterol, BMI, and smoking status.

RESULTS

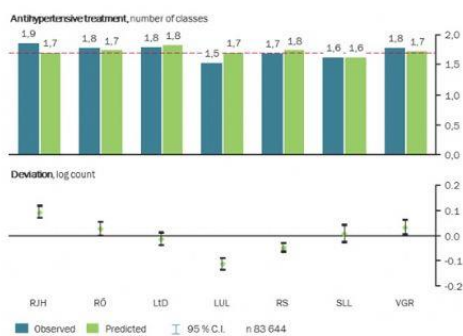
Based on a complete case approach, 83 644 patients were analyzed. Antihypertensive treatment was more intensive in Jämtland Härjedalen, Östergötland and Västra Götaland while Uppsala and Skåne prescribed significantly fewer classes per patient. Statins were more frequently prescribed in Jämtland Härjedalen, Östergötland, and Skåne, less frequently so in Uppsala and Stockholm. County councils with less intensive therapy had fewer patients at treatment goal.

CONCLUSIONS

There were significant differences in the prescription patterns of antihypertensive drugs and statins between the county councils. These differences remained when taking a wide range of clinical and socioeconomic factors into account. These data indicate that unequal treatment is not uncommon in Sweden.

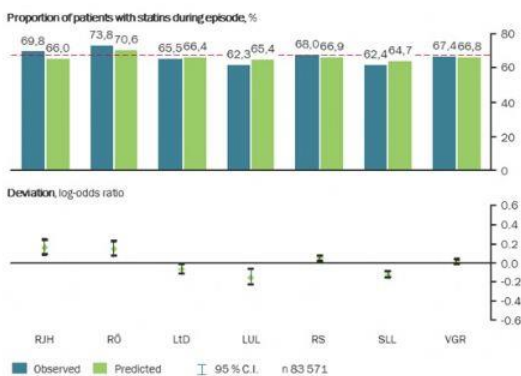
Keywords: Value based monitoring, diabetes type 2, risk factor treatment

Antihypertensive treatment, number of classes



Adjusted for: age, gender, level of education, civil status, born outside of EU, duration of diabetes, the presence of diabetic complications, systolic blood pressure, LDL-cholesterol, BMI, comorbidities, eGFR and HbA1C at start of episode, and smoking status

Statin use, proportion of patients (%)



Adjusted for: age, gender, level of education, civil status, born outside of EU, duration of diabetes, the presence of diabetic complications, systolic blood pressure, LDL-cholesterol, BMI, comorbidities, eGFR and HbA1C at start of episode, and smoking status

P-0101

Asthenia and swollen legs

Paola Lievano, Patricia Lloro, David Idoipe, Yamileth Guerrero, Mercedes Cervero, Sara Sastre, Carlota Canet, Sara Lainez, Jose Antonio Ibañez, Oscar Zepeda, Miguel Lopez Del Pueyo, Jesus Tenias, Laura Urieta, Amparo Cantin, Laura Bosqued, Miguel Rivas

Department of Community & Family Medicine. Sector III. Hospital Clínico Universitario Lozano Blesa, Zaragoza, Spain.

Background & Aim

Glomerular disease is a common problem in patients consulting primary care. Urinalysis, estimated glomerular filtration rate (GFR) and patient age help to detect the most likely causes. Family history and comorbidities also may suggest particular etiologies. However, confirmation by renal biopsy is generally required.

Method

64 year-old woman with a history of psoriasis, hypertension and asthma.

Asthenia, generalized aches and edema in both legs since months. On examination shows slight ankle edema without other findings.

Results

Initial blood test shows hypercholesterolemia, hypertriglyceridemia and LDH increase, hypoproteinemia.

Proteinuria and urine albumin/creatinine ratio increased. It was recommended reducing sodium intake, diuretic therapy is added and it is sent for assessment and treatment of nephrology. Serology is prompted; EAB, iron metabolism, HbA1c, and autoimmune Ig and complement AC within normal parameters except for a decreased IgG and increased C3. Bence Jones protein urine culture and negative ion with impaired clearance. Negative fecal occult blood. Abdominal ECO with bilateral pleural effusion, normal kidneys.

Corticosteroid treatment is initiated, with poor response (deterioration of renal function, so far with urea and creatinine in normal serum, and reduced general condition), so finally renal biopsy was performed.

CONCLUSION: Among the leading causes of nephrotic syndrome are the primary glomerulopathies but we must not forget the existence of general diseases affecting the glomerulus and which have considerable prevalence in adults (up to 40% versus 60%) as the case we reviewed, that revealed presence of amyloidosis.

Keywords: Nephrotic syndrome. Glomerular disease. Amyloidosis.

P-0102

Evaluation of Thalassemia Trait from Ondokuz Mayıs University, Department of Family Medicine

Aysenur Alper Gurz, Bahadır Yazicioglu, Fusun Artiran Igde

Department of Family Medicine, Ondokuz Mayıs University, Samsun, Turkey

Background & AIM: Thalassemia is a form of blood disorder characterized by hypochromic microcytic anemia, caused abnormal formation of haemoglobin. A higher frequency of thalassemia trait (TT) cases is reported mostly from the Mediterranean region, including Turkey. In this study we aimed to evaluating patients laboratory results that consulted to department of family medicine for TT. And we aimed to attend the important points for traiting.

Material&METHODS: In this study, we analyzed patients' laboratory results that consulted to department of family medicine for distinguishing trait the family whom daughter/son is thalassemia. This study investigated between April 2011-June 2014, in Ondokuz Mayıs University, Department of Family Medicine. Evaluation of the samples; MCV<80 fL=low, Mentzer index (MCV/RBC)<13= high risk for TT. HbA2>3.5% and/or HbF>2.0%= TT.

RESULTS: Between April 2011 and July 2014, 99 patients (49.5 % female (n=49) and 50.5% male (n=50)) have been examined for thalassemia. The mean of age is 34.5±7.3. 53.53% of the patients (n=53) have been diagnosed with TT. It is observed that 3.03% of mothers (n=3) have α , 17.17% (n=17) has β -TT and 7.07% of fathers (n=7) have α , 19.19% (n=19) has β -TT. The brother of a patient whose father is β -TT is observed to have β -thalassemia as well. In the examinations applied on parents, it is seen that one couple has α and two couples have β -thalassemia. The relation between the diagnoses and MCV are examined (Table 1).

CONCLUSION: To prevent the increase in the costs, complete blood counts should be performed primarily to parents for the evaluation of thalassemia trait and it should be appropriate distinguish of iron deficiency anemia

and TT and than make further examinations. Hb electrophoresis is an expensive examination and it will be much more cost-effective policy if is requested from those who believed thalassemia according to CBC results.

Keywords: Family Practice, Thalassemia, Trait

The relation between the diagnoses and MCV

	Thalassemia+	Thalassemia-	
MCV<80fL	52	6	58
MCV>80fL	0	38	38
	52	44	96

P-0103

Surveillance of Chronic Obstructive Pulmonary Disease in a Primary Health Care Unit

Helena Ribeiro, Teresa Martins, Vânia Leite, Bruno Vaz
USF Novos Rumos, ACES Alto Ave, Vizela, Portugal

BACKGROUND: Chronic Obstructive Pulmonary Disease (COPD) is considered an important public health problem, being the fourth leading cause of death in the World. The estimated prevalence of COPD in Portugal varies between 4% and 14%.

AIM: To determine the prevalence of COPD and characterize its surveillance in the population of a primary care unit.

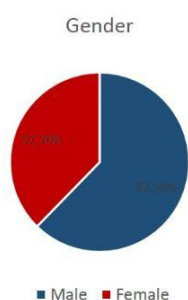
METHOD: Observational, descriptive, analytical and transversal study in adult patients of a primary care unit with COPD code (R95) of the International Classification of Primary Care - 2nd edition. The variables were collect in February 2015 through the electronic clinical records. Statistical analysis was performed with SPSS.

RESULTS: The prevalence of COPD was 0.92%, with a mean age of $69,7 \pm 11,9$ years and an average BMI of 27.1 kg / m². 62.3% patients were male, 13.7% smokers, 2.7% ex-smokers and 14.4% had no records. The influenza vaccine was administrated in 51.4% patients, and the pneumococcal vaccine in 16,5%. Only 34,9% performed a diagnostic spirometry with bronchodilator test. Considering the latest spirometry, 26.3% was performed in the last four years, 14.4% in more than four years and 59.6% had no record of a spirometry. In 78% patients the forced expiratory volume in one second (VEF1) was not registered. Regarding treatment, 18.5% perform short-acting bronchodilators, 26% long-acting anticholinergic (LAMA) or long-acting beta2-agonists (LABA), 3,4% LAMA and LABA, 34,2% inhaled corticosteroids (ICS) and LAMA or LABA, 4,1% ICS, LAMA and LABA and 13,7% methylxanthines.

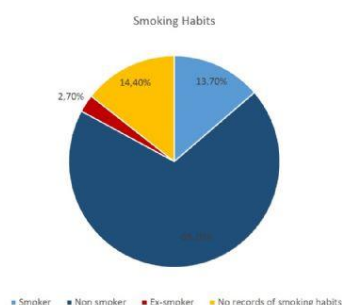
CONCLUSION: The prevalence of COPD found is lower than reported in the literature, which may be explained by the absence of diagnose recording. Adequate surveillance of COPD may reduce patient's symptoms, which improves quality of life, prevents the disease's complications and reduces the associated morbidity and mortality. The General Practitioner is in a privileged position to diagnose COPD and ensure its proper surveillance.

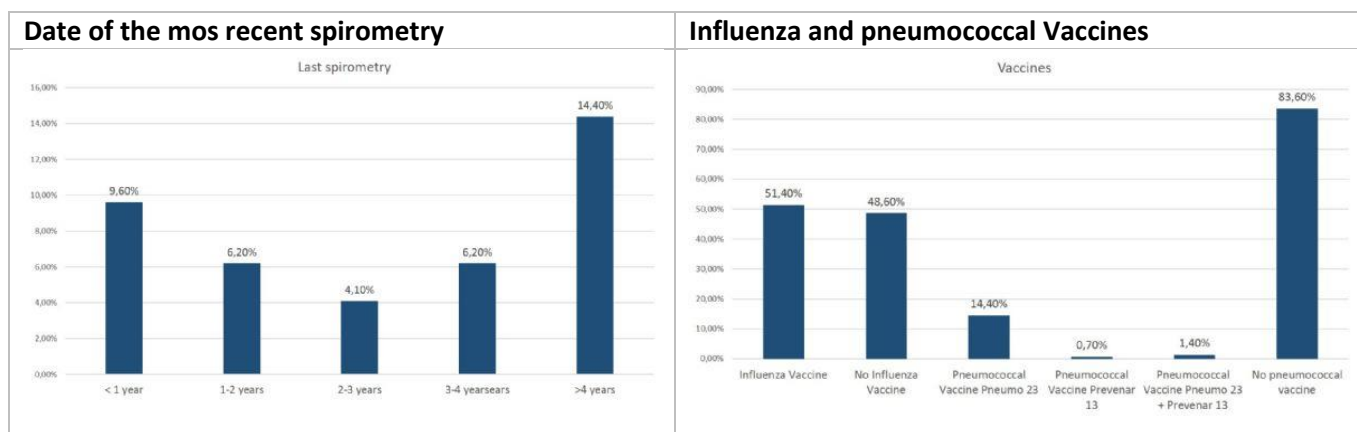
Keywords: Chronic Obstructive Pulmonary Disease, spirometry, treatment

Distribution of patients by gender

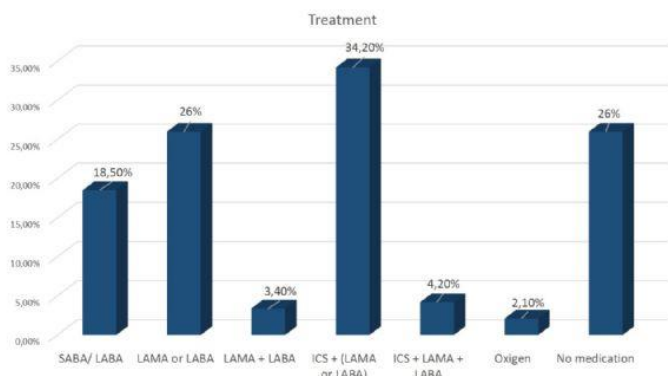


Smoking Habits





Treatment



P-0104

Evaluation of dyslipidemia in type 2 diabetes: degree of control and associated lipid-lowering treatment

Carmen Maria Cortes Salazar¹, Jose Carlos Fernández Garcia², Diana Domínguez Jiménez³

¹Primary Care Centre of Badolatosa, Seville, Spain.

²Endocrinology Department, Virgen de la Victoria University Hospital, Málaga, Spain.

³Primary Care Centre of Estepa, Seville, Spain.

Background & AIM: Dyslipidemia is one of the major risk factors for cardiovascular disease in type 2 diabetes mellitus (T2DM). The characteristic features of diabetic dyslipidemia are a high plasma triglyceride concentration, low HDL cholesterol concentration and increased concentration of small dense LDL-cholesterol particles. In this study we aimed to evaluate the degree of control of dyslipidemia in patients with T2DM in primary care.

METHOD: Retrospective cohort study which included patients with T2DM followed in a primary care setting. Patients were classified according to the following criteria: strict control of dyslipidemia (LDL<100 mg/dl and triglycerides < 150 mg/dl), partial control of dyslipidemia (LDL≥100 mg/dl or triglycerides ≥150 mg/dl), or absence of control of dyslipidemia (LDL≥100 mg/dl and triglycerides ≥150 mg/dl). Treatment with lipid-lowering drugs (statins, fibrates, nicotinic acid, ezetimibe) was also collected.

RESULTS: 183 patients were included, with a mean age of 62.1±8.3 years (58.4% women). After stratification of patients according to previous criteria, only 32% of patients had strict control of dyslipidemia, 43% had partial control of dyslipidemia and 25% had absence of control of dyslipidemia. Associated lipid-lowering treatment was present in 72% of patients with strict control, in 81% of patients with partial control and in 90% of patients with absence of control.

CONCLUSIONS: Despite the high rate of prescription of lipid-lowering therapy in patients with T2DM, a significant percentage of patients do not achieve recommended lipid goals.

Keywords: type 2 diabetes, dyslipidemia, associated-treatment

P-0105

Determinants of the risk for dying or hospitalization in heart failure patients included in homecare programs

Miguel Angel Muñoz, Jose Maria Verdú Rotellar, Jose Luis Del Val, Xavier Mundet, Ernest Vinyoles, Mar Domingo, Eva Frigola, Cilia Mejia Lancheros
Institut Català de la Salut. Primary healthcare University Research Institut IDIAP-Jordi Gol.

Background & AIM: Primary care programs oriented to provide homecare to the most fragile patients has been carried out for several years. Nevertheless, not specific analysis has been made to know the characteristics and prognosis of heart failure patients included in these programs. Our study is aimed at knowing the differences in the characteristics, mortality and hospitalization rates between heart failure patients needing medical homecare and community dwelling ones.

RESULTS: 8.376 patients with heart failure were followed since 2009 to 2012 (median of follow up: 11,6 months, P25-75, 5.9-23.6), in Catalunya (Spain). Mean age was 78.0 years (SD 10.2) and 55.9% were women. Patients included in homecare programs represented 26.8% of the total, and had more frequently cardiovascular comorbidity (hypertension, diabetes, atrial fibrillation, history of stroke, peripheral artery disease) and previous hospitalization as a consequence of HF than those community dwelling. These patients were significantly older and had a worse cognitive profile.

Probability of dying during the follow-up was higher in patients included in homecare programs: OR 1.32 (95% Confidence Interval, 1.05-1.67) but the significance disappeared when adjusting for cognitive impairment (OR 1.15, 95% Confidence Interval 0.84-1.58). Probability of being admitted at hospital for a cardiovascular episode was also higher for homecare patients, but the OR was reduced from 2.32 (95% Confidence Interval 2.07-2.60) to 1.34 (95% Confidence Interval, 1.00-1.79) when cognitive impairment was introduced in the multivariate models.

CONCLUSIONS: HF patients included in homecare programs had higher cardiovascular comorbidity. Cognitive impairment determines the higher risk of dying or being admitted at hospital as a consequence of a cardiovascular event in this population.

Keywords: Primary care, homecare, Heart Failure, prognosis

Figure 1

Probability of dying for Heart Failure patients not including cognitive impairment in the multivariate models

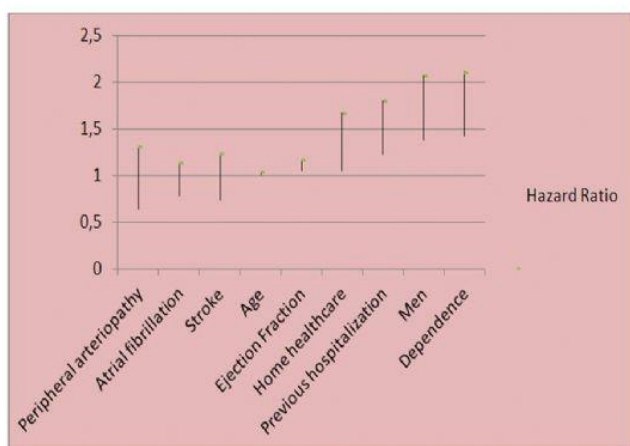


Figure 2

Probability of dying for Heart Failure patients including cognitive impairment in the multivariate models

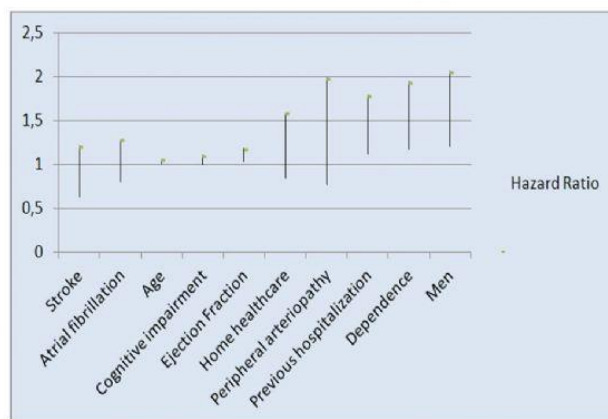
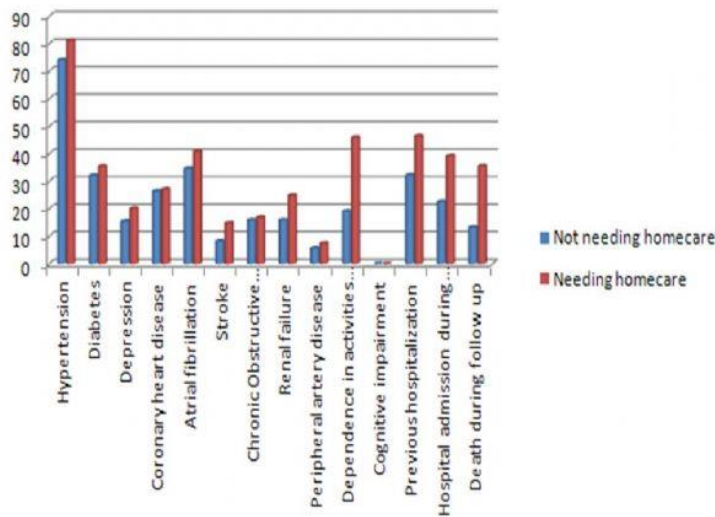


Figure 3



Characteristics of patients according to the necessity or not of receiving home healthcare attention

P-0106

Efficacy of liraglutide in type 2 diabetes: analysis of 23 patients attended in primary care

Carmen Maria Cortes Salazar¹, Jose Carlos Fernández Garcia², Diana Domínguez Jiménez³

¹Primary Care Centre of Badolatosa, Seville, Spain.

²Endocrinology Department, Virgen de la Victoria University Hospital, Málaga, Spain.

³Primary Care Centre of Estepa, Seville, Spain.

BACKGROUND & AIM: To evaluate the efficacy of liraglutide (a novel glucagon-like peptide 1 receptor agonist) in patients with type 2 diabetes mellitus (T2DM) followed in primary care.

METHOD: Observational, retrospective study conducted in adult subjects with T2DM and obesity (IMC ≥ 30 kg/m²) who were started on liraglutide. Anthropometric data, blood tests, and blood pressure at the time of initiation of treatment and after 4 months were collected.

RESULTS: 23 patients were included in this study (mean age 56.4 ± 12.3 years, 56.5% females. After a mean of 4 months of follow-up, a significant decrease in body weight was found (-4.3 kg, baseline 102.1 kg, $p < 0.05$), in HbA1c levels (-1.3%, baseline 8.8%, $p < 0.01$), in systolic blood pressure (-7.4 mmHg, baseline 147.2 mmHg, $p < 0.01$) and in LDL concentrations (-25.8 mg/dl, baseline 138.2 mg/dl, $p < 0.05$). No significant changes, however, were observed in triglycerides, HDL cholesterol or diastolic blood pressure.

CONCLUSIONS: Liraglutide is an effective treatment in obese patients with type 2 diabetes, improving metabolic control, reducing LDL cholesterol and lowering body weight and systolic blood pressure.

Keywords: type 2 diabetes, obesity, liraglutide

P-0107

Outcomes of a high-resolution thyroid clinic in patients referred from primary care

Carmen Maria Cortes Salazar¹, Jose Carlos Fernández Garcia², Diana Domínguez Jiménez³, Isabel Mancha Doblaz²

¹Primary Care Centre of Badolatosa, Seville, Spain.

²Endocrinology Department, Virgen de la Victoria University Hospital, Málaga, Spain.

³Primary Care Centre of Estepa, Seville, Spain.

BACKGROUND & AIM: The finding of a thyroid nodule is a very common occurrence in clinical practice. Management of thyroid nodules requires a multidisciplinary approach that may be eased by a high-resolution thyroid nodule clinic. We report our clinical experience and outcomes of patients from primary care referred to a high-resolution thyroid nodule clinic.

METHOD: Retrospective cohort study which included patients from primary care and suspected thyroid nodule referred to a high-resolution thyroid nodule clinic. Demographic data and clinical characteristics were collected and all patients underwent a thyroid ultrasound.

RESULTS: 987 patients were included in this study (mean age 47.3±14.7 years, women 90.6%). 38.3% out of patients had family history of thyroid disease. Nodule was detected mostly by the patient (35.6%) or by the primary care physician (29.6%). Most of the patients (98.5%) reported no symptoms of thyroid dysfunction. 57.2% of patients had palpable goiter. After performing thyroid ultrasound, a thyroid nodule was detected in 79.5% of patients (785 nodules) with a mean nodular diameter of 2±1.15 cm.

CONCLUSIONS: Most patients referred from primary care to a high-resolution thyroid nodule clinic are middle-aged women. Usually, the finding of the nodule is done by the patient himself or by the primary care physician. Goiter is frequently present and mean nodule diameter is approximately 2 cm.

Keywords: thyroid nodule, high-resolution thyroid clinic, thyroid ultrasound

P-0108

Is the polypharmacy a challenge in general practice?

Gergana Hristeva Foreva, Daniela Mileva, Zornitsa Ambareva, Levena Kireva, Maria Semerdjieva, Radost Asenova
Dept of General Practice, Medical University Plovdiv

BACKGROUND: Polypharmacy and potentially inappropriate prescriptions should be considered in general practice in order to decrease the risk for adverse drug events. In addition, general practitioners don't use computerized drug interaction alerts. Nevertheless the studies related to the topic are scarce in Bulgaria. Research question: To investigate the GPs' attitude about the polypharmacy in general practice with validated tool.

METHODOLOGY: A cross-sectional study among 217 GPs in Bulgaria, using a questionnaire focused on polypharmacy, was done. The sample consisted of 77 males (35.5%) and 140 females (64.5%), average age 50.9±9.5 years.

The results were processed by SPSS 17.0 version, using descriptive statistics and nonparametric test (Chi-square).

RESULTS: Polypharmacy is known as a widespread issue but there is no generally accepted definition. Our data reveal that the most common definition used by the GPs is multiple, often unjustified, prescriptions. 53.0% of the respondents always give information for adverse drug events, 37.3% in their judgment and 7.8% in patients' demands.

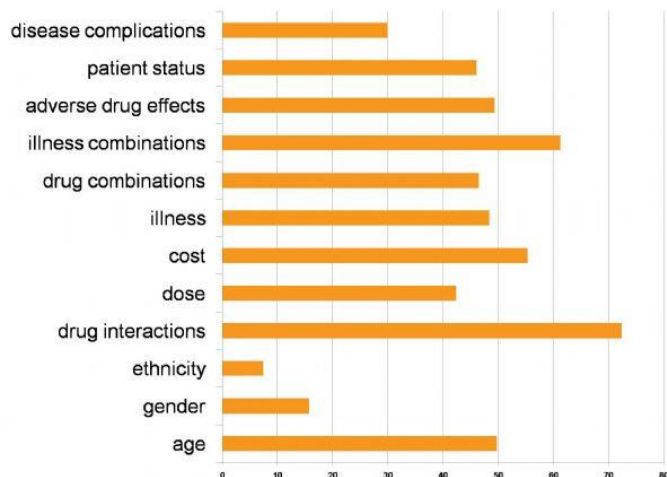
54.4% of the GPs have documented adverse drug events in the patient's records. The polypharmacy affects the quality of life of patients. According to 70% of the participants it is related to financial burden and 35.9% have emphasized on the psychological effect of the polypharmacy.

CONCLUSIONS: Polypharmacy negatively influences the health related quality of life, including with frequent adverse drug events. Specific attitude and attention is needed to facilitate the management of polypharmacy in general practice.

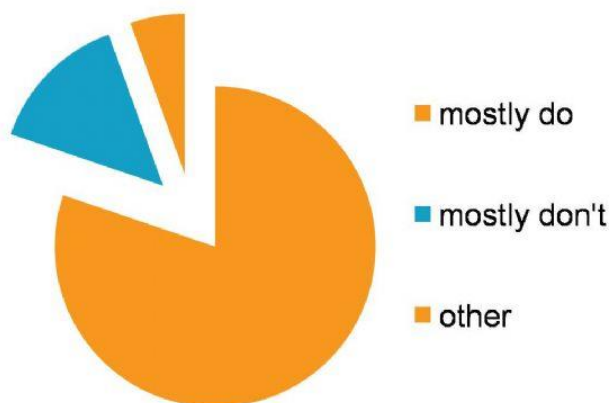
The research is supported by the university grant № HO - 15/2014 Polypharmacy and multimorbidity among geriatric patients in general practice – implementation of patient-centred approach.

Keywords: polypharmacy, general practice, adverse drug events

Distributions of the factors taking into consideration by GPs related to multi-drug prescription:



Do patients follow GPs' advice in multi-drug prescriptions:



P-0109
Family based treatment of childhood obesity in primary care

Milena Blaž Kovač, Antonija Poplas Susič, Barbara Ferjan
Community Health Centre Ljubljana

Background

Based on the latest estimates in European union countries the number of overweight and obese children rose steadily. Family obesity is often factor for developing child obesity, which leads in adulthood with various health problems. Obesity treatment programmes for children and all family members are rare.

Aim

The programme based on family treatment was developed by a team of family doctors, graduated nurses and professors of physical education. The aim is to manage the obese children and their family members with moderate healthy goals and with sticking on the changes achieve weight reduction.

Methods

The 5- months initial programme following with 18-months maintaining programme includes children older than 7 years with BMI>95th percentile and their family members who are obese; after assesment readines for change. It is based on behaviour approaches, dietary modification, increased physical activity and monitoring body weight. The children follow the 5-4-3-2-1-0 plan: 5 fruits or vegetables per day, 4 to 5 daily meals, at least 3 hours of family physical activity per week, less than 2 hours of screen time, 1 hour daily physical activity and 0 sweeted

drinks.

The programme consists of group and individual therapy. The group therapy is repeated every two weeks for children and their family members and on alternate weeks with meeting a physician. Physical activity is organized twice a week, inside or outdoors. All family members are invited to support the changes. Targets and achieved goals are monitored.

Results

Preliminary results show the effectiveness of programme.

Conclusions

Child obesity treatment including the whole family are challenge for primary care.

Programme is supported by Norway Grants

Keywords: Childhood obesity treatment, family based obesity treatment, primary care



P-0110

Multimorbidity management in general practice

Daniela Mileva, Zornitsa Ambareva, Levena Kireva, Maria Semerdjieva, Gergana Foreva, Radost Asenova
Dept of General Practice, Medical University Plovdiv

BACKGROUND: Demographic changes are leading to an increasing number of people with chronic conditions and multimorbidity. The management of the long-term conditions is a major challenge for GPs who are responsible for comprehensive care. However, the health care systems are largely configured for individual diseases rather than multimorbidity.

Research question: The aim of the study was to explore the opinion of the GPs about the management of multimorbidity in general practice consultations.

METHODOLOGY: A cross-sectional study among 217 GPs in Bulgaria, using a questionnaire focused on management of multimorbid patients, was done.

Measured outcomes - socio-demographic data, difficulties in patient management, communication barriers.

The results were processed by SPSS 17.0 version, using descriptive statistics and nonparametric test (Chi-square).

The study was conducted as part of a PhD thesis.

RESULTS: Appropriate management of multimorbid patients was one of the main challenge in general practice consultations. 53% of the GPs defined multimorbidity as the presence of two or more chronic conditions. The participants pointed out that multimorbidity affects the emotional status of patients and according to 68.7% of them patients were depressed. Only 46% claimed that patients accepted their condition.

44.7% of studied revealed that the main difficulties in counseling were related to the lack of financial resources.

32.7% reported about administrative barriers, 35.9% about difficulties associated with legislative limitations.

65.0% of the GPs considered that care for multimorbidity patients required more time, 54.8% more explanations for patients and 37.8% special attitude. 37.8% noted that multimorbidity requires an assessment of the psychological status of the patient. 39.2% of responders underlined the need of communication skills.

CONCLUSIONS: This study indicates the need for adjustment in the function of the health care system as well as the need of applying the guidelines for multimorbidity management in general practice.

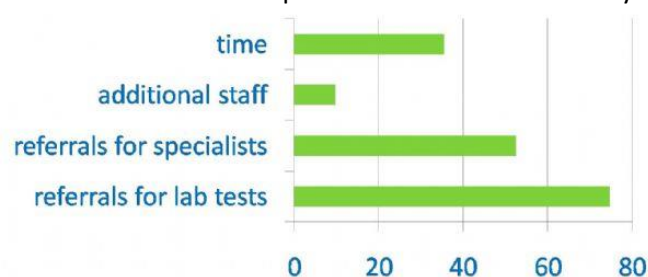
Keywords: multimorbidity, general practice, long term care

Difficulties in multimorbidity management:

Difficulties in multimorbidity management :



Resources needed for optimization of multimorbidity management:



P-0111

Predictive factors of metabolic control in patients with type 2 diabetes mellitus

Carmen Maria Cortes Salazar¹, Jose Carlos Fernández Garcia², Diana Domínguez Jiménez³

¹Primary Care Centre of Badolatosa, Seville, Spain.

²Endocrinology Department, Virgen de la Victoria University Hospital, Málaga, Spain.

³Primary Care Centre of Estepa, Seville, Spain.

BACKGROUND & AIM: Despite elevated use of antidiabetic drugs, a significant proportion of patients with type 2 diabetes mellitus (T2DM) do not achieve adequate metabolic control. In this study we evaluate the clinical characteristics and predictive factors of metabolic control in patients with T2DM.

METHOD: Cross-sectional study including patients with T2DM from a rural population (3600 inhabitants). Data about age, sex, body mass index (BMI), years of evolution of diabetes, associated-diabetes treatment and glycosylated hemoglobin (HbA1c) was collected. A binary logistic regression analysis (HbA1c <7% or HbA1c ≥7%) was used to evaluate potential predictors of inadequate metabolic control.

RESULTS: 62 patients were evaluated: mean duration of T2DM 6.3 years (standard deviation [SD] 5), mean age 71.16 years (SD 10.2), 64.5% men. Mean weight was 77.8 kg (SD 12.9) and BMI was 30.5 kg/m² (SD 5.3). All patients were receiving antidiabetic drugs: oral antidiabetic drugs (OAD) 74.2%, OAD plus insulin 22.6%, insulin alone 3.2%. An average of 1.45 OAD was used; monotherapy 58.1% of patients, 30.6% dual therapy and 8.1% triple therapy. Most commonly used drugs were metformin (85.2%), DPP4 inhibitors (34.4%) and sulfonylureas (19.7%). Regarding insulin therapy, most patients were on basal/bolus routine (56.2%), 37.5% were on basal insulin alone and 6.3% on mixed insulin. Mean insulin dose was 62 units (SD 38.1) and mean HbA1c levels was 6.9% (SD 0.9). 60.7% of patients achieved good metabolic control (HbA1c <7%). Among predictive studied factors (gender, age, BMI, OAD therapy, insulin therapy and years of diabetes evolution), insulin treatment was the only predictor factor for having HbA1c ≥7% (OR 10.6, 95% confidence interval 1.8 to 61.7, p=0.008).

CONCLUSIONS: Most patients with T2DM from a rural setting are elderly obese men. Most of these patients are

treated with OAD (metformin mainly). Insulin use is an important predictive factor for inadequate metabolic control.

Keywords: type 2 diabetes, predictive factors, HbA1c

P-0112

{Parsonage -Turner} Syndrome - a case report

Maria Inês Araújo Antunes¹, Sara Almeida Magalhães¹, Ana Leite Abreu²

¹USF Ponte

²USF physis

Background & AIM

Parsonage -Turner syndrome, also called brachial neuritis or neuralgic amyotrophy, is an uncommon syndrome with an annual incidence of 1.64 per 100,000 persons. An acute or sub acute neuritis of the brachial plexus is the syndrome main expression, manifesting itself by an intense arm pain, with possible cervical irradiation. It is usually followed by paralysis and muscle atrophy, days, weeks or months after onset. Although an unknown etiology, around 25-50% of the cases have a precipitating factor, more often an infection, intense exercise or traumatism. RMN and electromyography are the best exams for diagnosis and exclusion of other lesions. Treatment is symptomatic and it can be used corticosteroids in some patients. After acute phase, rehabilitation is the gold treatment to reach a full recovery, which can take between 1 and 3 years.

METHOD: Clinical interview and clinical process consultation.

RESULTS: Case report

ACSR, 28 years old, nuclear family, Stage I in Duvall cycle.

In June 2013, patient expressed pain in left arm with posterior bilateral affection and muscle weakness with paresthesia, three weeks after onset. Patient was referenced to physical medicine and rehabilitation consultation and then to Neurology, where diagnosis was confirmed by RMN and electromyography. Therefore, patient initiated corticosteroids during 2 months and also physiotherapy to relieve the pain, with significant improvement of the condition.

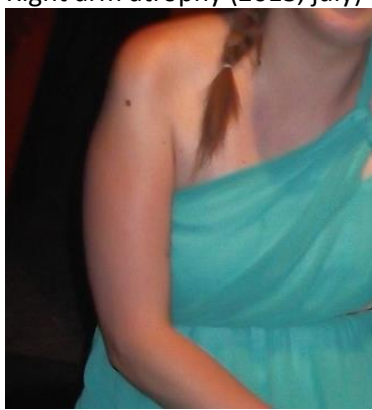
CONCLUSIONS: Parsonage -Turner syndrome is confused with other causes of pain and paresis of the upper limb. The family physician, first interlocutor in the primary health care, should be aware to this diagnosis due the high prevalence of similar symptoms. The early diagnosis allows the correct orientation, minimizing psychosocial damage associated to symptoms and functional and work disability.

Keywords: Parsonage -Turner syndrome, brachial neuritis, neuralgic amyotrophy.

Left arm atrophy (2013, july)



Right arm atrophy (2013, july)



Auxiliary diagnostic exams (2013, july)

Electromyography	Acute bilaterally deltoid muscle denervation and of left, and left infraspinatus and supraspinatus
	Suggest Parsonnage-Turner syndrome
RMN cervical, dorsal and low back	Normal
	Exclude central spinal cord lesion

P-0113

A case of Irritable bowel syndrome

Cláudia Teixeira¹, Isabela Carvalho²

¹USF 3 Rios, ACES Tâmega II - Vale Sousa Sul, ARS Norte, Portugal

²USF Salvador Lordelo, ACES Tâmega II - Vale Sousa Sul, ARS Norte, Portugal

Background & AIM: Irritable bowel syndrome (IBS) is a gastrointestinal syndrome characterized by chronic abdominal pain and altered bowel habits in the absence of any organic cause over a period of at least three months. It is one of the most commonly diagnosed gastrointestinal conditions responsible for a significant number of visits to primary care physicians.

METHOD: Clinical process and interview with the patient. Research articles in Medline and EBM sites (evidence-based medicine), in English published in the last 5 years.

RESULTS: 49 years old Caucasian woman, nuclear family in the stage V Duvall's cycle, Graffar III, presents with symptoms of recurrent abdominal pain and distention. During the last year, she became unemployed and was submitted to hysterectomy. Her symptoms have been occurring more frequently and with greater severity resulting in several medical observations. The bloating seems to worsen with food intake, as a consequence she started to avoid eating leading to weight loss. Abdominal pain significantly improves after defecation but sense of incomplete evacuation persists. Colonoscopy and routine laboratory tests are normal. After a lifestyle and dietary modification the patient initiated antispasmodics on a needed basis.

CONCLUSIONS: Patients with irritable bowel syndrome (IBS) can present with a wide array of gastrointestinal symptoms. However, the symptom complex of chronic abdominal pain and altered bowel habits remains the nonspecific yet primary characteristic of IBS.

Perhaps because IBS is such a heterogeneous disorder, there is no single therapeutic approach and the aim of treatment is to minimize the costs and possible adverse effects of therapies. Establishment of the clinician-patient relationship and continuity of care are critical to the management of all patients with IBS.

Keywords: Irritable bowel syndrome

P-0114

Salivary gland growth – Clinical diagnosis

Diana Sofia Duarte¹, Miguel Marques Ferreira¹, Avelina Pereira Moniz², João Silva Bastos¹

¹Family Physician resident, USF Tejo, Lisbon, Portugal

²Family Physician, USF Tejo, Lisbon, Portugal

BACKGROUND:

Salivary glands tumors are frequent and parotid gland represents 80-85% of them. 25% are malignant. Radiation exposure, smoking viral infections and environmental factors are important risk factors. The clinical presentation is usually a painless mass, swelling, related with facial nerve involvement. The history, physical examination and imaging studies are important for diagnosis.

Description

Female, 28 years old, Asian race, married, unemployed. Extended family, no family risk factors and no relevant

personal past history. She attended our family practice with a recent (up to 5 weeks) painless swelling in the right parotid region. Observation: we felt a 4x4 cm well demarcated growth petrous mass reaching the mandibular angle, firm consistency fixed to neighboring tissues not painful on palpation. The patient shows a good opening mouth with good oral hygiene. The ultrasound scan reveals mixed tumor of the parotid gland. We refer the patient to head and neck surgery. She waits the histology exam that will give perspectives about this case.

Discussion

Most of parotid gland tumors are benign, the common presentation is an incidental mass found in physical exam. The clinical features about this issue are the most important modality of identifying malignancy. The histology of tumor is required to establish a plan therapy. Family physician is usually the first one to see the patient and is important for a preliminary diagnosis and soon refers. Family doctor integrates the knowledge about family and environmental factors to contribute for a differential diagnosis.

This case shows the importance of good clinical history and attentive physical exam to an attempted reference to the secondary care and surgical approach.

Keywords: salivary gland, parotid gland, tumor

P-0115

Scrotal mass in a young adult – benign semiology vs cancer histology

Diana Sofia Duarte¹, [Miguel Marques Ferreira](#)¹, Avelina Pereira Moniz²

¹Family Physician resident, USF Tejo, Lisbon, Portugal

²Family Physician, USF Tejo, Lisbon, Portugal

BACKGROUND:

Scrotal masses can represent a wide range of medical issues, from benign congenital conditions to life-threatening malignancies and acute surgical emergencies. Testicular swelling may be caused by local infections, cancer, or testicular torsion. Testicular tumors are the most common malignant tumors encountered in men 25 to 35 years of age. The history, physical examination and imaging studies are important for the differential diagnosis.

Description

Man, Caucasian, 32 years, married, nuclear family, recent parenting, working as upholsterer (14 years exposure). No relevant personal or family history. One week after a sport trauma, he went to his family physician with a Painful mass on the right scrotum. Observation: swelling of right scrotum without skin changes, painful mass in the right testis, with soft consistency and no transillumination.

An ultrasonography revealed well differentiated mass with hemorrhagic areas. Beta-hCG – 760.3 mU/ML. Staging imagiology was favorable and an orchiectomy was done, leading to Beta-hCG -5.3 mU/ML.

The histology was compatible with diagnosis of seminoma.

On behalf elevated beta-hCG - 310 mU/ML, 3 weeks after surgery, body PET revealed solitary pulmonary metastasis (17 x 14 mm), obliged intensive chemotherapy regimen, (5 cycles).

Semen preservation was performed.

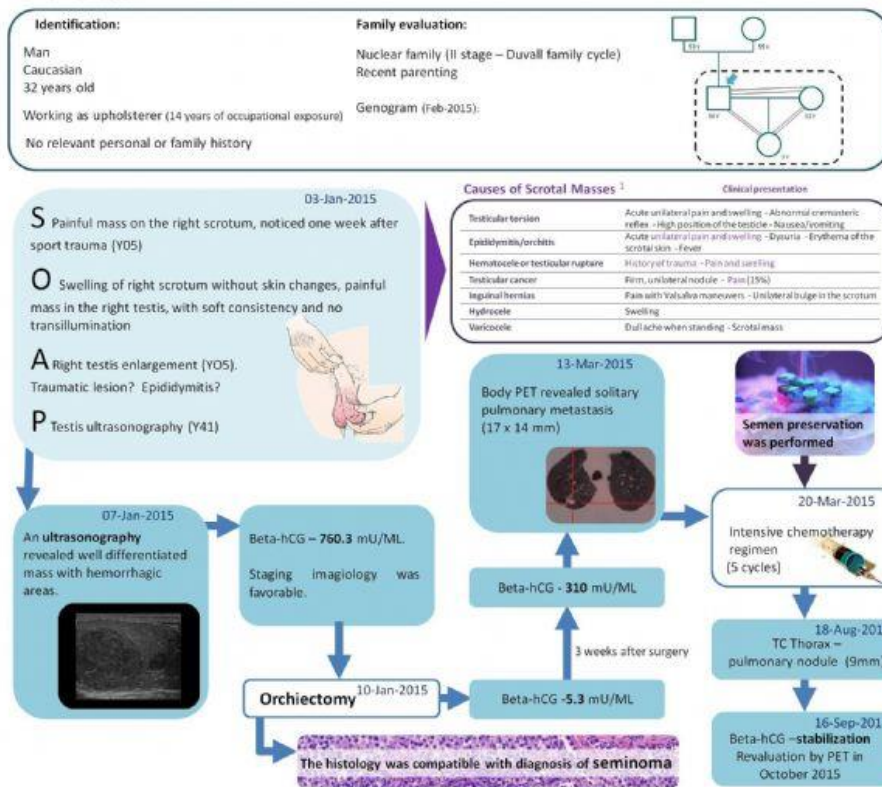
Discussion

The clinical presentation of scrotal mass with pain and association with trauma, confirmed by innocent ultrasound, is suggestive of benign etiology, possibly traumatic. However, the presence of a mass at this location associated with an increased beta-hCG, are indicators of possible malignancy - confirmed by histology. This case shows the importance of the clinical approach of testes masses; although the high prevalence of malignancy in younger males justifies exclusion of other diagnosis hypothesis.

In young couples we should respect the patient will of paternity and a semen preserve must be offered.

Keywords: scrotal swelling, testicular mass, seminoma, tumor

Clinical Case



P-0116

Lifestyle changes to improve symptoms of gastroesophageal reflux disease – is there evidence?

F. Charrão¹, C. Pina², C. Mata³

¹Esposende Norte Family Health Unit, Esposende, Portugal

²Cuidar Family Health Unit, Santa Maria da Feira, Portugal

³Santiago Family Health Unit, Leiria, Portugal

Background & Aim

Lifestyle changes are often suggested in the presence of gastroesophageal reflux symptoms.

The aim of this review is to assess the effect of lifestyle changes on the reduction of gastroesophageal reflux disease's (GERD) symptoms.

Methods

Data Sources

A search for meta-analyses, systematic reviews, clinical guidance and controlled and randomized clinical trials was conducted in Medicine Based on Evidence databases (National Guideline Clearinghouse, Guidelines Finder, Canadian Medical Association Practice Guidelines Infobase, The Cochrane Library, Clinical Evidence, DARE, Bandolier and Pubmed).

Review methods

Articles included were published between January 2006 and February 2015 in English, Portuguese and Spanish. To assess the quality of the studies and establish the strength of recommendation the "Strength of Recommendation Taxonomy" (SORT) scale of the American Family Physician was used.

Results

95 articles were obtained from the research, of which five met the inclusion criteria: one systematic review, one meta-analysis and three standards of clinical guidance. Weight loss in obese or overweight patients appears to be effective in reducing GERD symptoms.

Conclusions

The majority of studies and clinical guidelines analyzed showed a decrease of GERD symptoms when associated with weight loss, in obese or overweight patients (SOR B). However, one cannot assign strength of recommendation to the other changes in lifestyles, given the low level of evidence.

Keywords: lifestyles, gastroesophageal reflux disease, adults

Table 1. Clinical Guidance

Reference	Conclusions	Strength of the Recommendations	Evidence Level
AGA Medical Position Statement on the Management of Gastroesophageal Reflux Disease 2008	Weight loss should be advised for overweight or obese patients with oesophageal GERD syndromes. Other measures – adjust to each patient	B B	1 1
Gastroesophageal reflux disease (GERD) – UMHS, 2012 U.S. Department of Health e Human Services	All measures associated should be recommended throughout the treatment of GERD Only Weight loss and avoidance recumbency several hours after meals should be recommended	B B	2 2
Guidelines for the diagnosis and management of gastroesophageal reflux disease. ACG 2013 American College of Gastroenterology	Weight loss is recommended for overweight patients or have recent gain weight Head bed elevation is recommended for patient with nocturnal GERD Other measures – not recommended	Conditional Conditional Conditional	2 3 3

Table 2. Systemic Review and Meta-analysis

Reference	Studies	Sample	Population	Intervention	Results	NE
Davide Festi et al 2009 "Body weight, lifestyle, dietary habits and gastroesophageal reflux disease." World J Gastro 2009 April 14;15(14): 1690-1701	RS 2 MT 2 RCT 40 Observational	n>18796 n=71 n>380.00 0	Adults	Weight loss and other lifestyle changes	Weight loss has an effective role in improving GERD symptoms. No definitive data exist regarding the role of other lifestyle changes in GERD clinical manifestations.	2 3
Henry Cohen et al 2010 "Latin American Consensus on Gastroesophageal Reflux Disease: An Update on Therapy" Gastroenterol Hepatol.2010;33(2):135-147	MT 79 RS and RCT	---	Adults	Weight loss and other lifestyle changes	Encouraging weight loss for obese and overweight is reasonable. Others recommendations should be decided on a case-by-case basis	2 3

Subtittle: RS – Systemic Review; MT – Meta-analysis; RCT – randomized controlled trial

P-0117

Constipation - How to use laxatives?

Lisete Aires Silva, Sónia Marcelo

USF Terras de Souza, ACES Tâmega II - Vale do Sousa Sul, Portugal

INTRODUCTION and OBJECTIVES: Constipation is a public health problem. Studies have reported that the prevalence of constipation ranges from 2 to 27 percent. The use of laxatives is also very prevalent, and the aim of this study was to review the therapeutic indications of the use of laxatives, adverse effects and contraindications.

METHODS: We conducted a search in Pubmed using the MeSH terms constipation, adult and laxatives.

RESULTS: Non-pharmacological treatment of constipation, with high fiber diet and regular exercise, should be recommended.

We should start the pharmacological therapy with laxatives after the bankruptcy of non-pharmacological treatment (after 4 weeks of beginning the treatment); secondary constipation follows from a therapy impossible to stop or replace; elderly patient and hypocaloric diet; association with comorbidity, surgery or preoperative period; as well as pregnancy or breastfeeding, when the bankruptcy of non-pharmacological treatment and the presence of fecaliths.

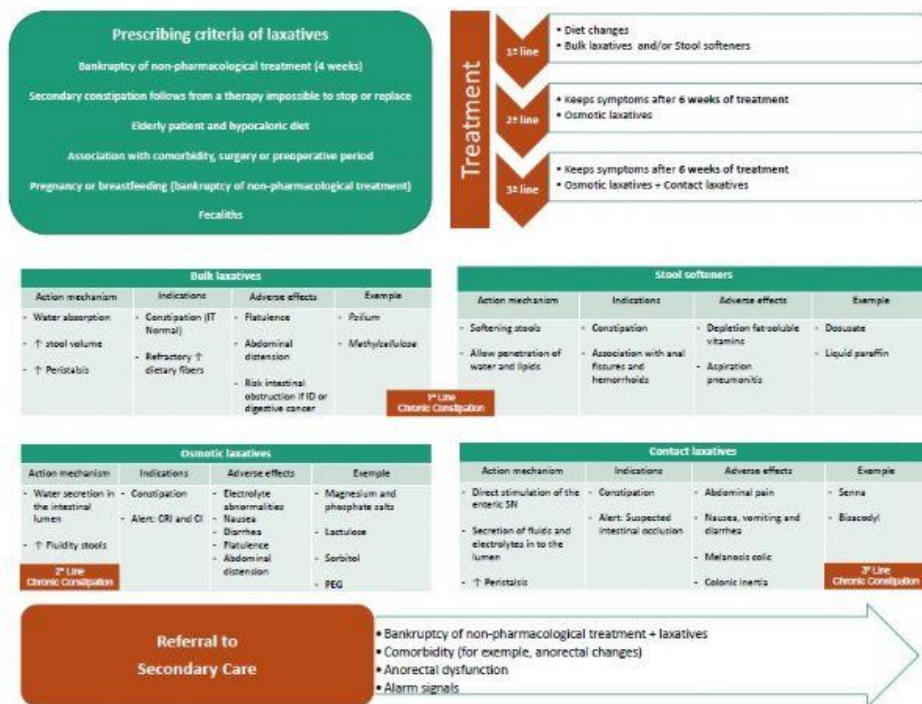
We suggest bulk laxatives or stool softeners as first line of therapy. Osmotic laxatives could be used as second line of therapy, and if necessary we should use the contact laxatives associated as a third line of therapy.

Special attention should be given to situations like constipation in the elderly, palliative, care comorbidity with diabetes mellitus, kidney or heart failure, in travel situations and pregnancy.

CONCLUSION: The correct use of laxatives is a major asset in the constipation therapy. We highlight the role of the Family Doctor in the surveillance of this disease by promoting the maintenance of healthy lifestyles and their treatment. Treatment failure is a criterion for referral to secondary care.

Keywords: Constipation, adult and laxatives.

Results



P-0118

Total Cardiovascular Risk: How to calculate and how to use it?

José Carlos Da Silva Russo, Márcia Sofia Dos Reis Gonçalves Lopes Braga
 Unidade de Saúde Familiar Descobertas, Belém, Lisboa, Portugal

Background and AIM:

The atherosclerotic disease is very common after the age of 60 and occurs due to the presence of several risk factors. The interaction between these risk factors determines the Total/Global Cardiovascular Risk. In this way, the prevention and treatment of the atherosclerotic disease focuses on Total Cardiovascular Risk and not just in each risk factor by itself. The estimated Total Cardiovascular Risk (low, moderate, high or very high), allows us to arrange the appropriate therapeutic strategies and to avoid sub therapeutic or excessive therapeutic measures. The aim of this poster is to illustrate how to calculate and how to use the Total Cardiovascular Risk in the day-to-day clinical practice of primary health care.

METHODS: Literature review of the Total Cardiovascular Risk, its calculation formula and its usefulness. This review was performed in multiple recognized databases.

CONCLUSIONS: The Total Cardiovascular Risk is determined by various diseases and cardiovascular risk factors. The SCORE model is applied to patients between 20 and 65 years of age. It evaluates: age, gender, systolic blood pressure, total cholesterol, HDL cholesterol and cigarette smoking habits.

Informing the patient about his Total Cardiovascular Risk is a crucial measure to motivate him to cooperate with changing some aspects of his lifestyle and to not forget to take the prescribed pills.

In the future, the estimated Total Cardiovascular Risk is likely to be improved by the inclusion of other factors and biological markers of cardiovascular risk. In this way, there are expected new models with higher power prediction of the Total/Global Cardiovascular Risk.

Keywords: Adult; Cardiovascular diseases/mortality; Coronary disease/mortality

Cholesterol targets by the Total cardiovascular Risk

	Total-Cholesterol (mg/dL)	LDL-Cholesterol (mg/dL)
SCORE 1 - 5%	190	115
SCORE 5 - 10 %	190	100
SCORE > 10%	190	70

The Total Cardiovascular Risk evaluation is indicated in the following situations

- Patient's will;
- ≥ 1 risk factor
- Family history of cardiovascular disease or premature familial dyslipidaemia;
- Cardiovascular symptoms;
- >45 years.

P-0119

«I'm finally growing up» - a case report of hypogonadism

Mariana Sousa Silva, Rui Queiroz Valério

UCSP Povoá de Santa Iria, ACES Estuário do Tejo, Portugal

BACKGROUND: Male hypogonadism represents an altered testicular function with infertility and decreased testosterone production. It can be caused by an intrinsic testicular damage, hypothalamic-pituitary dysfunction or decreased end organ response to testosterone. Signs include hair loss, decreased sexual function, voice changes, eunuchoidal habitus and gynecomastia. The diagnosis is clinically suspected usually after late onset of puberty and is confirmed with decreased circulating testosterone concentrations.

CASE: A 44 year-old divorced male patient, without assigned family doctor, came to consultation with complaints of hypospermia. Physical examination pointed absence of facial hair, normal penis and testicles, gynoid pubic hair distribution and absence of body hair at the remaining areas. There was also history of infertility on his previous marriage. Given this findings, we put the hypothesis of hypogonadism and requested blood tests (serum concentrations of sex hormones and pituitary hormones) and prostatic and testicular ecography. We also requested a referral to endocrinology.

The patient returned after a month with results that revealed low serum testosterone concentration and also low serum luteinizing hormone and follicle stimulating hormone concentration. The ecography showed a small volume prostate and normal testicles. We admitted the diagnosis of secondary hypothyroidism. After this, we requested a CT scan for the pituitary gland, and at this moment the patient awaits the endocrinology consultation to get the proper treatment and finally go through complete puberty.

CONCLUSION: The fact this patient didn't have an assigned family doctor delayed the diagnosis of a clinically relevant situation. Hypogonadism can significantly reduce the quality of life and has resulted in the loss of livelihood, infertility and separation of couples, leading to divorce. There is a clear need to increase the awareness of hypogonadism throughout the medical profession, especially in primary care physicians who are usually the first port of call for the patient.

Keywords: hypogonadism, hypospermia, longitudinal continuity

P-0120

How to Study Constipation in Primary Health Care?

Lisete Aires Silva¹, Joana Andrade Barros¹, Marta Santos⁴, Simão Martins³, Umbelina Mesquita²

¹USF Terras de Souza, ACES Tâmega II - Vale do Sousa Sul, Portugal

²USF Torrão, ACES Tâmega III - Vale do Sousa Norte, Portugal

³USF Hygeia, ACES Tâmega III - Vale do Sousa Norte, Portugal

⁴UCSP Boticas, ACES Alto Tâmega e Barroso, Portugal

INTRODUCTION and OBJECTIVES: Constipation is a very common problem. It is associated with some risk factors, such as women, elderly, lower educational level and dietary errors. It is a disease with high impact on life quality. The aim of this study was to review step by step management of constipation.

METHODS: We conducted a search in Pubmed using the MeSH terms constipation, adult and causality.

RESULTS: The first step in the investigation of constipation, to determine if it is a acute or chronic condition, was the duration of symptoms. Appropriate management requires an evaluation for secondary etiologies, such as systemic disorders and drugs.

Primary constipation, may be associated with normal or slow colonic transit or defecatory dysfunction.

Secondary constipation may be due to comorbidities as endocrine or metabolic diseases (diabetes mellitus, hypercalcemia or hypothyroidism), neurological diseases (autonomic neuropathy, Hirschsprung disease, multiple sclerosis or Parkinson's disease), psychiatric disorders (anxiety, depression or somatization) structural changes (anal fissures and pelvic inflammatory disease) or drugs (antidepressants, antihistamines, antipsychotics, diuretics, opiates, calcium channel blockers, antacids, aine's, calcium and iron supplements).

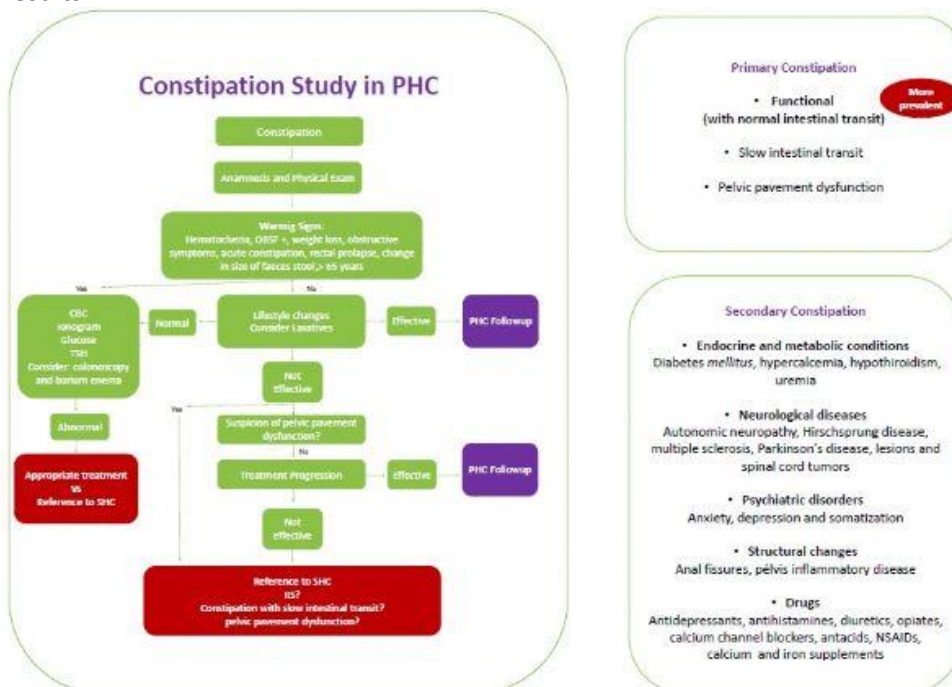
The presence of warning signs, as well as chronic and severe constipation, guides to the request for additional investigation, with blood tests, X-ray and endoscopic tecnics.

CONCLUSIONS: Functional constipation is the most frequent cause of chronic constipation. However other causes should be properly excluded, towards the best therapeutic orientation.

Special focus on alarm signals history and fysical examination must guided the study of constipation within primary health care, with special attention to referral criteria to secondary care.

Keywords: Constipation, adult and causality.

Results



P-0121

Initial approach and monitoring of Obstructive Sleep Apnea Syndrome in Primary Health Care

Sara Quelha, Felicidade Malheiro

USF Arca d'Àgua; ACeS Porto Oriental; Porto; Portugal

Background and AIM: The Obstructive Sleep Apnea Syndrome (OSAS) is a sleep disorder, and its prevalence estimated in Portugal is 20%, predominantly in obese men between 40-60 years. OSAS is associated with various diseases, such as hypertension, being fundamental a correct follow-up of these patients to better control these diseases. The objective is to optimize the evaluation of patients with suspected OSA and monitoring in Health Primary Care (PHC) after introduction of non-invasive mechanical ventilation (NIV).

METHOD: Bibliographic Search System Dynamed and search engines Cochrane Library and PubMed.

RESULTS: The suspicion of OSAS should fall before complaints of snoring and daytime sleepiness and results ≥ 11 the Epworth Sleepiness Scale. The diagnosis is established by polysomnography with an Apnea/hypopnea Index (AHI) $\geq 5/h$ and the NIV is the treatment of choice. When stabilized and after hospital discharge, the patient's adherence to NIV and its control should be reviewed annually by the Family Physician (FP), always emphasizing the importance of hygiene and dietary measures for therapeutic success. Ideally the patient should use the NIV $\geq 90\%$ of nights and $\geq 6h$ / night, with tolerable use $\geq 70\%$ of nights and $\geq 4h$ / night. It is considered controlled when presenting a normal AHI, or $< 5 / h$. The referral should be considered when clinical worsening, variation $> 10\%$ by weight, $AHI \geq 5 / h$, use of NIV $< 70\%$ of the nights, use of NIV $< 4h$ / night or when the patient does not tolerate NIV.

CONCLUSIONS: OSAS is associated with various diseases causing high cardiovascular morbidity. The FP should assess compliance and effectiveness of NIV, referencing the patient when necessary therapy optimization.

Keywords: obstructive sleep apnea syndrome; apnea/hypopnea index; non-invasive mechanical ventilation

Patients with optimal control and tolerable control

Ideally	Tolerable
Asymptomatic Epworth Sleepiness Scale < 11 Weight variation $< 10\%$	
NIV in $\geq 90\%$ of nights NIV ≥ 6 h per night IAH $< 5/h$	NIV in $\geq 70\%$ of nights NIV ≥ 4 h per night IAH $< 10/h$

Patients referencing sleep experts

Referencing
Symptomatic Epworth Sleepiness Scale ≥ 11 Weight variation $\geq 10\%$ NIV in $< 70\%$ of nights NIV $< 4h$ per night or $< 2h$ per night in the last six months IAH ≥ 10 Patients who can not tolerate NIV

P-0122

Pharmacotherapy in generalized anxiety disorder

Asli Ebiloglu¹, Umit Aydogan², Oktay Sari², Halil Akbulut³, Mehmet Ak⁴, Murat Erdem⁴, Aytekin Ozsahin⁴, Kenan Saglam⁵

¹Oran Outpatient Clinic, Primary Care & Family Health Center, Beytepe Military Hospital, Ankara, Turkey

²Department of Family Medicine, Gulhane Military Medical Faculty, Ankara, Turkey

³Akinci Outpatient Clinic, Primary Care & Family Health Center, Etimesgut Military Hospital, Ankara, Turkey

⁴Department of Psychiatry, Gulhane Military Medical Faculty, Ankara, Turkey

⁵Department of Internal Medicine, Gulhane Military Medical Faculty, Ankara, Turkey

AIM: Generalized anxiety disorder (GAD) is one of the most prevalent psychiatric disorder in the world. In order to treat GAD and related illnesses, many drugs are used. In this research we aimed to identify which drugs are used for GAD and related illnesses.

METHOD: Between 2009 to 2012, 73 patients enrolled in this study. Diagnoses were done by using Beck Anxiety Scale and DSM-IV criteria. Data was analysed by using SPSS 20 for MAC.

RESULTS: There were 61 (83.6%) female and 12 (16.4%) male. Fifty nine (81%) of patients were using SSRI, 8 (11%) were using SNRI, 4 (5.5%) were using TAD, 5 (6.8%) were using Tetracyclic Antidepressant, 3 (4.1%) were using Trazodon, 8 were using alprazolam, 1 (1.4%) was using Clonazepam, 1 (1.4%) was using Risperidon, 1 (1.4%) was using Stilizan, 1 (1.4%) was using Haloperidol, 1 (1.4%) was using Antihistaminic, 3 (4.1%) were using B-Blocker, 4 (5.5%) were using OAD, 12 (16.4%) were using antihypertensive therapy, 2 (2.7%) were using antihyperlipidemics, 2 (2.7%) were using vasodilators, 7 (9.6%) were using anti-thyroid drugs, 7 (9.6%) were using B12 vitamins.

CONCLUSIONS: SSRIs and antihypertensive drugs are the most used drugs in GAD.

Keywords: Generalized anxiety disorder, drug, pharmacotherapy

P-0123

Is there a role for tamsulosin in the treatment of distal ureteral stones?

Ana Margarida Pinho, Célia Gomes Silva

ACES Entre Douro e Vouga I Feira/Arouca, USF Famílias, Lourosa, Santa Maria da Feira, Portugal

Background & Aim

The incidence of urinary tract stones in the general population appears to be increasing. Therefore, urolithiasis is a chronic disease with substantial economic consequences and great public health importance.

In the last few years, medical expulsive therapy for ureteral stones has been developed, which includes α 1-adrenergic antagonists.

Alpha blockers mainly produce relaxation of the distal human ureter by reducing ureteric smooth muscle tone.

Tamsulosin (0.4 mg/day), an α 1-adrenergic antagonist, has been used because of its tolerability.

The aim is to review the available evidence on the efficacy of Tamsulosin in the expulsion of distal ureteral calculi.

Method

A search for clinical practice guidelines, meta-analyses, systematic reviews, evidence-based reviews and clinical trials published between January 2010 and March 2015, in English, Spanish and Portuguese was performed using the MeSH terms: Tamsulosin and Urolithiasis. The Strength of Recommendation Taxonomy of the American Family Physician was used for the assessment of levels of evidence and the strength of recommendations.

Results

Of the sixty-two articles found, only ten fulfilled the inclusion criteria and were selected. These included one practice guideline, one meta-analysis (MA) and eight randomized clinical trials (RCT).

The practice guideline recommended Tamsulosin for the medical expulsive therapy for ureteral stones. The MA found evidence for the efficacy of Tamsulosin in facilitating the expulsion of ureteral calculi. Seven RCT found that Tamsulosin increase spontaneous passage of distal ureteral stones. Only one RCT showed that Tamsulosin did not accelerate the expulsion of distal ureteral stones.

Conclusions

Evidence from available studies suggests that Tamsulosin can facilitate the expulsion of distal ureteral calculi

(Strength of Recommendation B).

However, more studies are needed to establish the efficacy in others populations and to compare Tamsulosin with other medical expulsive therapy.

Keywords: Tamsulosin, Urolithiasis, Urinary Calculi

Inclusion Criteria

P Population/patient Adult patients with distal ureteral stones
 I Intervention/indicator Tamsulosin
 C Comparator/control Placebo or other Medical expulsive therapy
 O Outcome Expulsion of distal ureteral stones

Meta-Analysis and Randomized Clinical Trials

Studies	References	Population/ Intervention	Results	Conclusions	Levels of Evidence
MA	Fan B et al. 2013	20 trials n=799 Tamsulosin vs Conventional Treatment	Tamsulosin vs Conventional Treatment RR=1.51; 95% CI 1.40–1.63 p < 0.0001	Tamsulosin facilitates the expulsion of ureteral calculi.	2
RCT	Kumar S et al. 2015	n= 285 patients Tamsulosin (Group A) vs Silodosin (Group B) vs Tadalafil (Group C) Follow-up: 4 weeks	There was a statistically significant expulsion rate of 83.3% in group B compared with 64.4% and 66.7% in groups A and C, respectively, with lower time of stone expulsion (P value =.006 and P value =.016, respectively)	Medical expulsive therapy for the distal ureteric stones using tamsulosin, silodosin, and tadalafil is safe, efficacious, and well tolerated.	2
RCT	Alizadeh M et al. 2014	n=96 patients Tamsulosin and indomethacin vs fluids (hydration) and indomethacin Follow-up: 4 weeks	Spontaneous expulsion of stone was occurred in 62.5% (30 patients out of 46) of control group patients and 82% (41 patients out of 50) that there was no significant difference (P>0.05).	Addition of tamsulosin to conservative treatment of distal ureteral stones in the distal ureteral stone expulsion showed no significant difference between the two groups.	2
RCT	Imperatore V et al. 2014	n=100 patients Silodosin vs Tamsulosin Follow-up: 4 weeks	Stone-expulsion rate in the silodosin and in the tamsulosin groups were 88% and 82%, respectively (p not significant).	Tamsulosin and silodosin are equally effective as MET for distal ureteric stones sized 10 mm or smaller.	2
RCT	Gupta S et al. 2013	n= 100 patients Tamsulosin (Group 1) vs Silodosin (Group 2) Follow-up: 4 weeks	A spontaneous stone expulsion was observed in 58% of the patients in group 1 and in 82% of the patients in Group 2, which was statistically significant.	Silodosin was found to be clinically superior to tamsulosin, both in terms of the stone expulsion rate and the stone expulsion time.	2
RCT	Zhou SG et al. 2011	n= 131 patients Naftopidil (group 1) vs Tamsulosin (Group 2) vs Control group	A statistically significant difference was noted in the stone expulsion between groups 1 and 3, and groups 2	Tamsulosin could significantly increase spontaneous passage of distal ureteral stones.	2

		(Group 3) Follow-up: 2 weeks	and 3 (P = 0.000 and P = 0.000, respectively).		
RCT	Ye Z et al. 2011	n= 3189 patients Tamsulosin (Group 1) vs Nifedipine (Group2) Follow-up: 4 weeks	There was a significant variation in stone-expulsion rates between groups 1 and 2 (P < 0.01).	Tamsulosin and nifedipine in MET was determined to be safe and effective for distal ureteric stones with renal colic.	2
RCT	Kaneko T et al. 2010	n= 71 patients Tamsulosin (Group 1) vs Control Group (Group 2) Follow-up: 4 weeks	The stone expulsion rate was significantly higher in group 1 than in group 2 (77% vs 50%, P = 0.002).	Low dose tamsulosin can significantly facilitate spontaneous passage of ureteral stones without significant side-effects.	2
RCT	Vincendeau S et al. 2010	n= 129 patients Tamsulosin (Group 1) Vs Placebo (Group 2) Follow-up: 42 days	Expulsion delay distributions during 42 days did not show any difference (P =.30).	A daily administration of 0.4 mg of tamsulosin did not accelerate the expulsion of distal ureteral stones in patients with ureteral colic.	1

Practice Guideline

Practice Guideline	Year	Conclusion	Strength of recommendation
European Association of Urology	2013	Tamsulosin is recommended for the medical expulsive therapy for ureteral stones.	B

P-0124

Restless Legs Syndrome: Primary Healthcare Approach

Susana Cordeiro Rita¹, Ana Matos Coronha², Ana Paula Cardoso¹, Mariana Anete Mira¹, Ana Sofia Pena¹

¹USF Samora Correia, ACES Estuário Tejo, ARSLVT, Santarém, Portugal

²Extensão Porto Alto, UCSP Benavente, ACES Estuário Tejo, ARSLVT, Santarém, Portugal

Introduction and PURPOSE: Restless Legs Syndrome (RLS) is characterized by an urge to move the legs, frequently secondary to an unpleasant sensation. Although relatively common (5-10% of the European population), its diagnosis is difficult, frequently mistaken for other conditions. In this paper, the authors review the management of RLS from the family physician (FP) perspective.

MATERIALS-METHODS: the authors performed a narrative review, searching Pneumology and Neurology monographies and English articles between 2000 and 2014 from Pubmed, Medline, Medscape and UptoDate databases.

RESULTS: by providing both transversal and longitudinal healthcare, the FP is in a privileged position to identify RLS. When this condition is suspected, the FP should:

a) enquire about RLS associated symptoms, according to the International Restless Legs Syndrome Study Group – 2012: 1) an urge to move the legs usually but not always accompanied by uncomfortable and unpleasant sensations in the legs; 2) symptoms begin or worsen during rest or inactivity; 3) symptoms are relieved or resolved with movement; 4) symptoms only occur or worsen during the evening or nighttime; 5) the before

mentioned criteria are not caused by any other condition, and results in functional and quality of life repercussions;

b) perform a complete physical examination, with a special focus on the cardiovascular, respiratory and neurological systems;

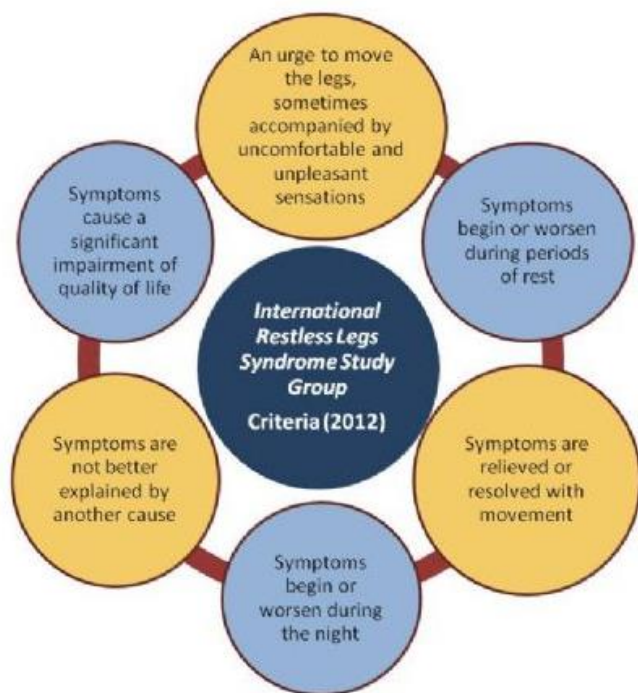
c) request diagnostic tests to exclude confounding factors (Eg: iron metabolism tests, thyroid function tests or polysomnography);

d) classify RLS as either primary (etiology unknown or likely familial) or secondary (associated with pregnancy, iron-deficiency, diabetes mellitus, multiple sclerosis, Parkinson's, pharmacological, among others);

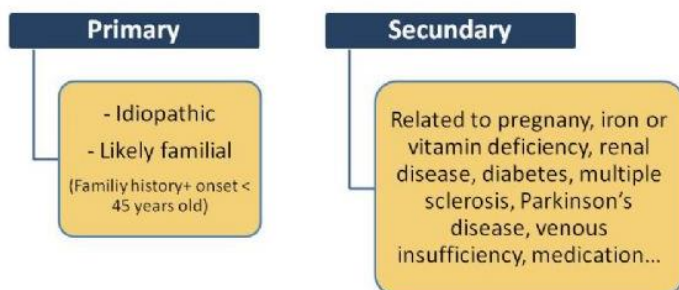
CONCLUSIONS: resulting from the management of the patient as a whole and the proximity and accessibility of primary healthcare, the FP has an essential role in the early diagnosis and follow-up of RLS, minimizing its detrimental impact in the quality of life of the patient.

Keywords: restless legs syndrome, Willis-Ekbom disease, family physician

Question symptoms (Diagram 1)



RLS classification (Diagram 2)



P-0125

Chronic-disease management in the patient's home environment

Simona Repar Bornšek, Tonka Poplas Susic

DEPARTMENT OF GENERAL PRACTICE, COMMUNITY HEALTH CENTRE LJUBLJANA, LJUBLJANA, SLOVENIA

Background & AIM: People with a chronic disease are the most frequent users of national health services.

Furthermore, chronic, non-communicable diseases are the leading cause of mortality in the developed world. Most complications can be prevented by a timely intervention, so early treatment is of vital importance.

METHODS: Effective chronic-disease management requires a sustained follow-up and continuous stimulation of the patient's compliance. Therefore a graduated nurse and community nurse were introduced in the physician's team to provide follow-up in the office and at patient's home.

RESULTS: Indicators that are systematically followed are: survey on patients and staff satisfaction – annually, establishing registers of patients with diabetes, asthma, COPD, hypertension, benign hypertrophy of prostate, osteoporosis, depression, and coronary heart diseases, annually measured blood pressure in all registered chronic patients, annually checked smoking status in all registered chronic patients, annually verified side effects of medications used in asthma patients, annually performed spirometry in patients with COPD, annually verified side effects of medications used in COPD patients, All data are entered in the computer program and automatically reported to the national central office. First analysis is expected in 2016.

CONCLUSION: The community nurse also monitors the patient's risk factors in their home environment. Due to his/her direct contact and the possibility to enter the patient's home environment, the nurse can identify the causes of a patient's failure to meet treatment goals, give advice about a safe environment (prevention of falls in patient with osteoporosis) or recommend a lifestyle change. A close collaboration between the family practitioner's team and a community nurse presumably increases patient satisfaction and compliance, allows treatment surveillance and monitoring of medication side effects.

Disclosure: Chronic-disease management in the patient's home environment is a part of a project funded by the Norwegian financial mechanism programme.

Keywords: : chronic disease, community nurse, treatment at home



CHRONIC-DISEASE MANAGEMENT IN THE PATIENT'S HOME ENVIRONMENT

Simona Repar Bornšek, Tonka Poplas Susic

Community Health Centre Ljubljana, Ljubljana, Slovenia

Background & Aim : People with a chronic disease are the most frequent users of national health services. Furthermore, chronic, non-communicable diseases are the leading cause of mortality in the developed world. Most complications can be prevented by a timely intervention, so early treatment is of vital importance.

Methods: Effective chronic-disease management requires a sustained follow-up and continuous stimulation of the patient's compliance. Therefore a graduated nurse and community nurse were introduced in the physician's team to provide follow-up in the office and at patient's home.

Results:



All data are entered in the computer program and automatically reported to the national central office. First analysis is expected in 2016.



Conclusion: The community nurse also monitors the patient's risk factors in their home environment. Due to his/her direct contact the nurse can identify the causes of a patient's failure to meet treatment goals, give advice about a safe environment (prevention of falls in patient with osteoporosis) or recommend a lifestyle change. A close collaboration between the family practitioner's team and a community nurse presumably increases patient satisfaction and compliance, allows treatment surveillance and monitoring of medication side effects.

Disclosure: Chronic-disease management in the patient's home environment is a part of a project funded by the Norwegian financial mechanism programme.

Patient’s satisfaction with work of graduated nurse in family physician’s team

Andrej Škrinjar¹, Liljana Klančnik¹, Antonija Poplas Susič¹

¹Andrej Škrinjar, MD, Community Health Center Ljubljana, Ljubljana, Slovenia

²Liljana Klančnik, graduated nurse, Community Health Center Ljubljana, Slovenia

³doc.dr. Antonija Poplas Susič, MD, Community Health center Ljubljana, Slovenia

Background & AIM: Graduated nurses can undertake substantial part of the management of chronic diseases and decrease the workload of family physicians. In 2011, a graduated nurse was introduced in the family physician’s team as a part of national project supported by Ministry of Health. In 2015, with a financial support of Norway Grants also a graduated nurse has been implemented with a purpose to manage patients at home (chronic diseases and preventive screening) as a pilot project in The Health Centre Ljubljana.

METHODS: The study evaluates a patient’s satisfaction in the Health Centre Ljubljana with the work of graduated nurse. Patients fulfilled questionnaires and assessed on the scale from 1(not good) to 5 (excellent) 3 groups of questions: the content of work, the time providing to patients and usefulness of information given by nurse.

RESULTS: In one month period, 235 patients assessed the work of 20 graduated nurses in Health Centre Ljubljana. The average score of patients satisfaction with graduated nurse is assessed by 77% of patients as excellent (grade 5) and by 23% as very well (grade 4). The average assessment of earlier mentioned areas are as follows: a content of work -77% excellent, 20 % very well, 2% good (grade 3) and 1% of patients did not answered; time providing to patients- 78% excellent, 19% very well, 2% good and 1% of patients did not answered; usefulness of information- 75% excellent, 21% very well, 2% good and 2% of patients did not answered the questions.

CONCLUSIONS: The majority of patients are very satisfied with the contribution of graduated nurses and we do believe that this is the appropriate way to upgrade primary care.

Keywords: patients satisfaction, primary care, graduated nurses

Disclosure: Treatment of patients provided by home visit nurse is supported by Norwegian finance mechanism program.

Keywords: patients satisfaction, primary care, graduated nurses

ZDL Zdravstveni dom Ljubljana Community Health Centre Ljubljana

norway grants

PC+3

ZDL Zdravstveni dom Ljubljana Community Health Centre Ljubljana

norway grants

PC+3

PATIENTS SATISFACTION WITH WORK OF GRADUATED NURSE IN FAMILY PHYSICIANS TEAM

Andrej Škrinjar, Liljana Klančnik, Antonija Poplas Susič

- Andrej Škrinjar, MD, Community Health Center Ljubljana, Ljubljana, Slovenia
- Liljana Klančnik, graduated nurse, Community Health Center Ljubljana, Ljubljana, Slovenia
- doc.dr. Antonija Poplas Susič, MD, Community Health Center Ljubljana, Ljubljana, Slovenia

BACKGROUND & AIM

Graduated nurses can undertake substantial part of the management of chronic diseases and decrease the workload of family physicians. In 2011, a graduated nurse was introduced in the family physician’s team as a part of national project supported by Ministry of Health. In 2015, with a financial support of Norway Grants also a graduated nurse has been implemented with a purpose to manage patients at home (chronic diseases and preventive screening) as a pilot project in The Health Centre Ljubljana.

METHODS

The study evaluates a patient’s satisfaction in the Health Centre Ljubljana with the work of graduated nurse. Patients fulfilled questionnaires and assessed on the scale from 1(not good) to 5 (excellent) 3 groups of questions: the content of work, the time providing to patients and usefulness of information given by nurse.

RESULTS

In one month period, 235 patients assessed the work of 20 graduated nurses in Health Centre Ljubljana. The average score of patients satisfaction with graduated nurse is assessed by 77% of patients as excellent (grade 5) and by 23% as very well (grade 4). The average assessment of earlier mentioned areas are as follows: a content of work -77% excellent, 20 % very well, 2% good (grade 3) and 1% of patients did not answered; time providing to patients- 78% excellent, 19% very well, 2% good and 1% of patients did not answered; usefulness of information- 75% excellent, 21% very well, 2% good and 2% of patients did not answered the questions.

CONCLUSIONS

The majority of patients are very satisfied with the contribution of graduated nurses and we do believe that this is the appropriate way to upgrade primary care.

Keywords: patients satisfaction, primary care, graduated nurses

Disclosure: Treatment of patients provided by home visit nurse is supported by Norwegian finance mechanism program.

Category	Excellent	Very well	Good	Not answered
Patient satisfaction	77%	23%	0%	0%
Content of work	77%	20%	2%	1%
Time providing to patients	78%	19%	2%	1%
Usefulness of information	75%	21%	2%	2%

P-0127

The Role of the Family Physician in the Diagnosis and Management of Orofacial Dyskinesia: a Case Report

Susana Cordeiro Rita, Ana Paula Cardoso, Virgínia Carreiras

USF Samora Correia, ACES Estuário Tejo, ARSLVT, Santarém, Portugal

Introduction and PURPOSE: dyskinesia is a greek term applied to abnormal involuntary hyperkinetic movement disorders, which may involve any part of the body. Diverse etiologies include Parkinson's disease, organic acidemia, conversive syndrome or anti-dopaminergic medications, which should guide the clinical investigation. The purpose of our case report is to demonstrate the role of the family physician in the multidisciplinary care of a patient with orofacial dyskinesia.

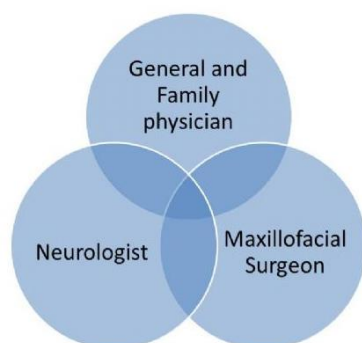
MATERIALS-METHODS: case report.

CASE: the authors present the case of a 74 year-old female, with a personal history of arterial hypertension, cardiac arrhythmia, vertiginous syndrome and reactive depression to the death of a son 18 months ago, medicated with valsartan, hydrochlorothiazide, lercanidipine, amiodarone, dabigatran etexilate, beta-histine and escitalopram. 12 months after the passing of her son, the patient reports the onset of bruxism and a mild degree of orofacial dyskinesia, characterized by involuntary lateralization movements of the jaw and tongue, and involuntary biting. This presentation was accompanied by trismus and temporo-mandibular joint limitation of movement and crepitation. A CT scan and Maxillofacial specialist consultation were requested, both discarding osteoarticular disease. The patient was then referred to a Neurology consultation and by this time her clinical picture had worsened to the point of a marked difficulty with speech and consequent social reclusion. After the appropriate laboratorial and imaging tests, the diagnosis is considered to be a conversive syndrome. The patient was prescribed clonazepam 1mg, 2 times a day, reporting a discrete improvement in the symptoms.

CONCLUSIONS: this clinical picture illustrates the role of the family physician as a pivot in complex cases, contributing to the early diagnosis and inter-disciplinary management of these patients. The importance of the familial and social context in this case, both contributed to the etiological investigation and the mitigation of detrimental effects in the patient's daily life.

Keywords: orofacial dyskinesia, Parkinson disease, tardive dyskinesia, conversive syndrome, family physician

Figure 1



P-0128

"Scleroderma": A hard approach in a hardened skin

Helena Marques, Cristina Ferreira Tavares

USF S.Félix da Marinha, ACeS Espinho/ Gaia, São Félix da Marinha, Portugal

Background & Aim: Systemic Sclerosis (SSc) is a rare connective tissue disease, characterized by hardened skin, vascular dysfunction and involvement of multiple organ systems with fibrotic complications. SSc's prevalence ranges from 30 to 240 per million inhabitants, being females mostly affected.

Considering that SSc has the highest disease-related mortality of connective tissue conditions and its significant impact, it is crucial the early recognition.

Method: Interview/ Family evaluation and consultation of clinical data.

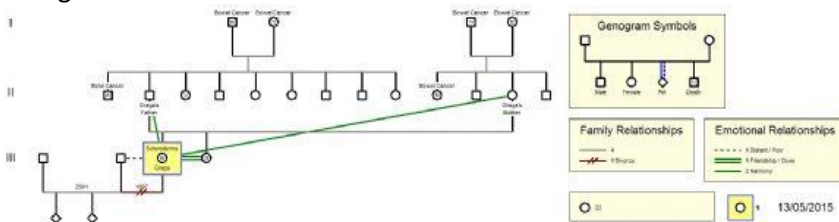
Results: A 43-year-old woman, married, from a nuclear family in stage I of Cycle of Duvall and a public transport driver. Previous history of esophagitis, hiatal hernia and dyslipidemia. Family's history of psoriasis (father's patient). The patient consulted her family doctor in May-2013, complaining of fatigue, myalgia, hand's arthralgia and thumb's paresthesia. On physical examination, it were found hand's swelling (without other skin alterations) and a dubious Raynaud.

She was referenced to Rheumatology and was observed in August-2013. It were requested immunologic studies, serology and protein's electrophoresis. In differential diagnosis, it were mainly considered Rheumatoid Arthritis, Psoriatic Arthritis and SSc. In September-2014, the patient presented with thickened/hardened skin (fingers-3+; forearm/face-0/1 – Modified Rodnan skin score) and Raynaud phenomenon. Capillaroscopy's results were compatible with SSc. Therefore, patient was diagnosed with Limited Cutaneous SSc (lcSSc), probably associated with CREST Syndrome and was treated with Methotrexate. This burden of uncertainty to diagnosis, enhancer of anxiety and familiar instability, accompanied with symptomatology's fluctuation/deteriorating, led to patient's temporary professional incapacity.

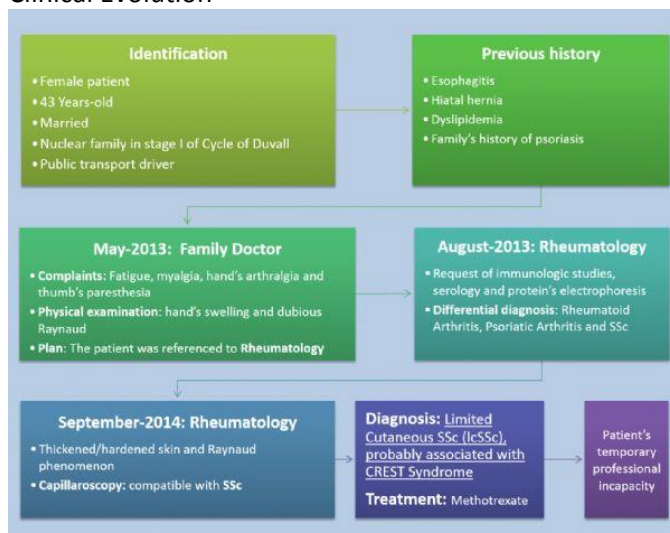
Conclusions: Musculoskeletal complaints, a considerable bulk as far as General Practice consultations are concerned, are often integrated in incipient presentations, which could be either valuable or confounding. Diffuse symptomatology's approach highlights the applicability of the core capacities of the family doctor such as problem solving skills in undifferentiated disease's stages, person-centered care and holistic approach.

Keywords: Systemic sclerosis, Scleroderma, raynaud phenomenon, Family Medicine

Genogram



Clinical Evolution



Supplementation of vitamin D in fibromyalgia, is it important? A systematic review

Mariana Gayo, Ana Beatriz Figueiredo, Maria Manuela Bernardo
 USF das Conchas, Lisbon, Portugal

AIM: To review the literature that supports an association between the deficit of vitamin D and fibromyalgia and if its diagnosis and treatment should be routinely considered on these patients.

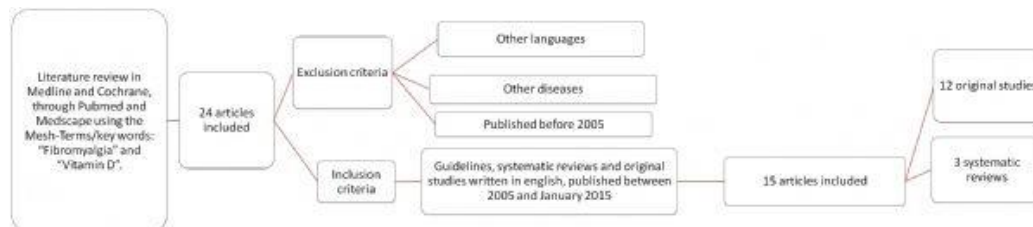
METHODS: Literature review in Medline and Cochrane, through Pubmed and Medscape using the Mesh-Terms: “Fibromyalgia” and “Vitamin D”. Inclusion criteria: guidelines, systematic reviews and original studies written in english, published between 2005 and January 2015.

RESULTS: Based on inclusion criteria, 12 original studies, 5 systematic reviews and 1 guideline review were included. The results obtained were conflicting. In 5 studies there is no association between fibromyalgia and vitamin D deficiency, but in the other 7 studies with different features they found a high prevalence of hypovitaminosis D among fibromyalgia patients. Most of the authors defend that an early nutrition program rich in calcium and vitamin D associated with medical treatment should be considered in fibromyalgia patients. A recent randomized placebo-controlled trial further states that vitamin D supplementation may be regarded as relatively safe and economical treatment in fibromyalgia. The current guidelines and Cochrane database defends that, the evidence base for the use of vitamin D supplementation for fibromyalgia is rather poor and there’s no evidence sufficient quality to guide clinical practice.

Discussion and CONCLUSION: All the studies so far are limited to a small number of participants and a highly selected patient population, so further investigation is needed to show the effect of vitamin D supplementation in fibromyalgia patients. We conclude that the association between low levels of vitamin D and fibromyalgia remains unclear; nevertheless treating hypovitaminosis D is relatively safe and inexpensive and may improve patients’ long-term bone health, muscle strength and therefore their symptoms.

Keywords: Fibromyalgia, chronic pain syndrome, Vitamin D, Treatment

Methods



References

1-Gilman M, et al. Fibromyalgia Syndrome: Is It Related to Vitamin D Deficiency in Premenopausal Female Patients? Pain Manag Nurs. 2013 Dec;14(6):24-8. 2-Hubbard H, et al. Serum vitamin D status and bone mineral density in fibromyalgia. J Rehabil Lit. 2013;10:494-8. 3-Andersson H, et al. Serum 25-OH-vitamin D Levels in Patients with Fibromyalgia. BMC. 2008 Jun;11(1):1381-2. 4-Weyner J, et al. Effect of vitamin D on patients with fibromyalgia syndrome: a randomized placebo-controlled trial. Pain. 2014 Feb;125(2):243-8. 5-Molina R, et al. The relation between Vitamin D deficiency and fibromyalgia symptoms in women. Saudi J Biol Sci. 2013;16(1):11-16. 6-Okada T, et al. Original Research Article: Vitamin D Deficiency in Women with Fibromyalgia in Saudi Arabia. Pain Med. 2012;13(10):1492-5. 7-Quinn S, et al. Serum vitamin D level and bone mineral density in generalized fatigue disorder with fibromyalgia. Rheumatol Int. 2012;32(12):1225-9. 8-Andersson H, et al. Association between nonspecific skeletal pain and vitamin D deficiency. Int J Rheumatol. 2013 Dec;11(4):349-6. 9-de Souza Costa C, et al. Evaluation of 25-hydroxyvitamin D serum levels in patients with fibromyalgia. J Clin Rheumatol. 2013 Dec;19(1):345-9. 10-Sudhan R, et al. Multiple low-specific muscle pain in Arab or Arab-Bahrain patients may indicate vitamin D deficiency. Clin Rheumatol. 2009 Aug;29(8):871-3. 11-Morales M, et al. Hypovitaminosis D among rheumatologic subgroups in clinical practice. Rheumatology (Oxford). 2008 Sep;17(9):1242-5. 12-Wikman A, et al. Diffuse musculoskeletal pain is not associated with low vitamin D levels or improved by treatment with vitamin D. J Clin Rheumatol. 2008 Feb;14(1):4. 13-Carpel G, et al. Fibromyalgia should not be treated with vitamin D deficiency? Curr Pain Res. 2014;20(1):1. 14-Jarvik A, et al. Treatment of fibromyalgia syndrome. Recommendations of Research Evidence-Based Interdisciplinary Guidelines with Special Emphasis on Complementary and Alternative Therapies. Medical Publishing Corporation Evidence-Based Complementary and Alternative Medicine. 2013. Article ID 481970. 7 pages. 15-Sebastian S, et al. Vitamin D for the treatment of chronic painful conditions in adults. Database Abstract Syst Rev (2) 20087775.

Results

Author	Type of study	Conclusion	Level of evidence
Wepner F, et al ¹	Randomized Controlled Trial		1
Mona H, et al ²	Cohort Study	• Positive association between FM and low levels of vitamin D	2
Noha T, et al ³	Cohort study	• Pain improvement with supplementation of vitamin D	2
Olama S, et al ⁴	Case control study		2
Okamus M, et al ⁵		• Positive association between FM and low levels of vitamin D	2
Moseys M, et al ⁶	Cross-sectional study	• No conclusion about pain improvement with supplementation of vitamin D	2
Ulusey H, et al ⁷	Cohort study		2
Tandeter H, et al ⁸		• No association between FM and low levels of vitamin D	2
Hoidari B, et al ⁹	Cross-sectional study		2
de Rezende Pereira C, et al ¹⁰			2
Wanner A, et al ¹¹			2

Results

Author	Systematic Reviews	
	Conclusion	SOFT
Daniel D, et al ¹²	<ul style="list-style-type: none"> The evidence for an association between FM and vitamin D deficiency is inconclusive No improvement in pain on supplementation 	B
Jacob A, et al ¹³	<ul style="list-style-type: none"> No evidence in supplementation of vitamin D in patients with FM 	B
Sebastian S, et al ¹⁴	<ul style="list-style-type: none"> The use of vitamin D supplementation for FM in adults is rather poor and there's no evidence sufficient quality to guide clinical practice. 	A

P-0130

Thyroid hemiagenesis: a rare finding in primary health care

Joana Parente¹, Paula Ferreira¹, Joana Araújo¹, Catarina Ferreira Leite², Raquel Abreu³, Andreia Fernandes⁴, Marta Ferreira¹

¹São Lourenço Family Health Care Unit, Braga, Portugal

²AmareSaúde Family Health Care Unit, Amares - Braga, Portugal

³Pro Saúde Family Health Care Unit, Vila Verde - Braga, Portugal

⁴Alcaides Faria Family Health Care Unit, Barcelos, Portugal

BACKGROUND & AIM: Thyroid development abnormalities are rare and include thyroid hemiagenesis, a congenital anomaly characterized by the absence of a thyroid lobe associated in 50% of cases with absence of the isthmus. Its prevalence is 0,5 to 0,2% with very few cases described to date. Most frequently, it is observed in the left lobe (4:1) and in female (3:1). It may be associated with thyroid dysfunction, but many cases are euthyroid and the diagnosis is incidental. Thyroid ultrasound has a role in the diagnosis and follow-up of these patients. Our aim is to report an incidental finding of thyroid hemiagnesis in a 33-years-old caucasian woman and present a review of literature. The patient, with a medical history of asthma, had her first appointment with her new family physician at january 2014. Biochemical analyzes were requested, which reported a TSH level slightly elevated. For enlightenment, the patient repeated thyroid function and it was requested a thyroid ultrasound. The results revealed thyroid hemiagenesis and subclinical primary hypothyroidism. It was decided to manage it with thyroid function and thyroid ultrasound every six months. In follow-up, patient remains asymptomatic.

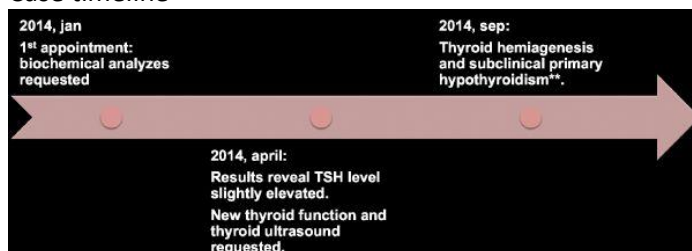
METHODS: Case report and review of literature.

RESULTS: Thyroid ultrasound revealed "left lobe of the thyroid not displayed and since there is no surgical history, there is probably an agenesis of the left lobe. Right lobe and isthmus are normal." The results of thyroid function were TSH of 5,3 mU/L (0,4-4mU/ml) and T4 of 1,23 ug/dl (0,7-1,8ug/dl).

CONCLUSIONS: Thyroid hemiagenesis is a rare congenital anomaly in most cases associated with an euthyroid state, but it can also be related to hypothyroidism, hyperthyroidism, adenomas, carcinomas, thyroiditis, among others. The awareness of this association should lead to a regular and proper follow-up with thyroid function and ultrasound.

Keywords: Thyroid hemiagenesis, agenesis hemithyroid, thyroid congenital anomaly

Case timeline



Timeline of the case report since the first appointment to the diagnosis.

Thyroid ultrasound



Patient's thyroid ultrasound. "Left lobe of the thyroid not displayed and since there is no surgical history, there is probably an agenesis of the left lobe. Right lobe and isthmus are normal." 2014, September.

P-0131

Platelet dysfunction in type 2 diabetes

Mehmet Aytug Dikililer¹, Adem Parlak², Muammer Korkmaz³, Umit Aydogan², Oktay Sari², Kenan Saglam⁴

¹Ankara Mevki Asker Hastanesi Anittepe Polikliniği Birinci Basamak Muayene ve Aile Sağlığı Merkezi / ANKARA

²Department of Family Medicine, Gulhane Military Medical Academy, Ankara, Turkey

³Department of Neurology, Gulhane Military Medical Academy, Ankara, Turkey

⁴Department of Internal Medicine, Gulhane Military Medical Academy, Ankara, Turkey

Background and AIM: Platelet activity and aggregation potential are essential components of thrombogenesis and atherosclerosis and can be conveniently estimated by measuring mean platelet volume (MPV). It has been shown that MPV was significantly higher in Diabetes Mellitus (DM). The aim of this study was to investigate MPV in type 2 DM.

METHODS: 110 patients (60 Diabetics, 50 controls) admitted to Gulhane School of Medicine Internal Medicine outpatient clinic from June 2009 to April 2010 have been included in this study. Heart failure, renal failure, hypertension, CVO and other chronic diseases which were excluded by history and physical exam and patients with anormal Hb and trombosit were not included our study.

RESULTS: There were 19 male (% 31,7), 41 female (% 68,3) in diabetic group; 18 male (% 36), 41 female (% 64) in control group. Mean MPV in diabetic group ($8,54\pm 1,07$ fL), were higher than control group ($7,99\pm 0,87$ fL) ($p=0.004$). There was a close relationship between HbA1c and MPV ($r=0,562$ $p<0,001$).

CONCLUSION: Our results have showed a close relationship between poor glycemic control and increased platelet activity in patients with type 2 DM. Furthermore, Platelet activity recovered through improved glycemic control, which may prevent the possible role of platelets in vascular events in these patients.

Keywords: Mean Platelet Volume, Glycemic Control, diabetes mellitus, platelet

P-0132

Musculoskeletal Disorders In Diabetes Mellitus

Marisa Batarda¹, Diana Costa Marques¹, Diogo Silva², Jenny Duarte¹, Ricardo Vicente¹

¹USF Tornada, Caldas da Rainha, Portugal

²USF Pedro e Inês, Alcobaça, Portugal

BACKGROUND AND AIM:

Diabetes Mellitus (DM) is a metabolic disorder of increasing prevalence accompanied by important multiorgan compromise. Various musculoskeletal manifestations have been associated with this disease, causing significant functional limitations in Diabetic patients. This review discusses the principal musculoskeletal changes in DM.

METHOD: The search engine used for this review was PubMed, with the following MeSH terms: diabetes mellitus, Dupuytren's contracture, trigger finger, bursitis and carpal tunnel syndrome. Five reviews pertaining to the last ten years were selected.

RESULTS: Many authors have tried to classify the musculoskeletal manifestations in DM, which proves difficult, due to the fact that the majority of the physiopathological mechanisms still remain unclear.

In patients with DM, the following musculoskeletal changes have been described: limited joint mobility syndrome, Dupuytren's contracture, trigger finger or stenosing flexor tenosynovitis, carpal tunnel syndrome, calcific tendinitis and adhesive capsulitis of the shoulder, muscular infarction, diffuse idiopathic skeletal hyperostosis, Charcot's arthropathy or diabetic neuropathic arthropathy.

CONCLUSIONS: This review points out the importance of an early diagnosis and timely therapeutic orientations for these different DM-related musculoskeletal manifestations.

Keywords: diabetes mellitus, Dupuytren's contracture, trigger finger

P-0133

Multiple Benefits of Oswestry Questionnaire Implementation in GP

Tatjana Cikac¹, Blazenka Fijacko¹, Tamara Bosak¹, Silva Potrebica², Renata Cop³

¹G.P. Out Patients Klinik, Varazdin

²Special Hospital for Rehabilitation, V.Toplice

³Home for Health Care Zagreb Center, Zagreb

INTRODUCTION: It is well-known that Oswestry questionnaire (OQ) is an extraordinary useful and widely used tool for initial check and identification of subjective patients' potentials and difficulties/disabilities, which is as a standard applied mainly in low back surgery and physical medicine.

MATERIALS-METHODS: In this paper in details are reviewed the results of OQ application at a group of 46 patients (before and after selected medical treatments) in 3-months period of GP group praxis in 2014-2015. According to subjective patients' perception of their problem levels intensities, the most of them were treated by NSAIDs. Only few of them were treated with physical therapy to which they were referred from their GPs.

Results. Through OQ GPs patients were able to express in a simple way their subjective perception of back pain level and its negative consequences on their daily activities. On the other hand, GPs can recognise patient's problems and immediately react in three directions:

- by recommending preventive behaviour and moderate activities to minimize risks of further minor pains development to patients with low level of symptoms intensity,
 - by proscribing and providing adequate medical treatments for the majority of low back pains patients etc
- With post-treatment OQ as a feedback GP can easily control the efficiency of all described activities with the aim of eventually further activities for improvements of patients' condition.

Conclusion: Besides physical rehabilitation related issues, OQ (when applied cyclically, e.g. once in every 3-5 years) may also contribute to insight of overall patient's lifestyle – quality, behaviours, capabilities and changes: this makes OQ an important source of knowledge about their patients to GPs (taking them in combination with patients' ages, personal, social, employment, tradition and other specific circumstances) and thus the input for possibly needed preventive activities and/or advices for improvements in different areas.

Keywords: post-treatment, back pain level, minor pains development

tcikac clonclusion

Conclusion

OQ (when applied cyclically, e.g. once in every 3-5 years) may also contribute to insight of overall patient's lifestyle – quality, behaviours, capabilities and changes: this makes OQ an important source of knowledge about their patients to GPs (taking them in combination with patients' ages, personal, social, employment, tradition and other specific circumstances) and thus the input for possibly needed preventive activities and/or advices for improvements in different areas.

tcikac methods

Materials and methods: The results of OQ application at a group of 46 patients (before and after selected medical treatments) in 3-months period of GP group praxis in 2014-2015. According to subjective patients' perception of their problem levels intensities, the most of them were treated by NSAIDs. Only few of them were treated with physical therapy to which they were referred from their GPs.

tcikac results

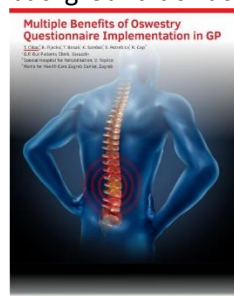
Results

Through OQ GPs patients were able to express in a simple way their subjective perception of back pain level and its negative consequences on their daily activities. On the other hand, GPs can recognise patient's problems and immediately react in three directions:

- by recommending preventive behaviour and moderate activities to minimize risks of further minor pains development to patients with low level of symptoms intensity,
 - by proscribing and providing adequate medical treatments for the majority of low back pains patients,
 - by indicating physical therapy treatments only for minor group patients with the highest level of pains (present in different daily situations).
- With post-treatment OQ as a feedback GP can easily control the efficiency of all described activities with the aim of eventually further activities for improvements of patients' condition.

Within the observed and treated group of 46 patients, initial average general pain level was reported as 3.3 (according to standard OQ), with the greatest problems at lifting (average score: 3.2) and standing (average score: 3.0). After treatments provided during 3 months the reported average general pain level is less than 1 point lower.

background t cikac



P-0134

Diagnosis and Management of Generalized Anxiety Disorders in Primary Care - Practical Guide

Sílvia Martins¹, Carla Silva¹, Dalila Teixeira²

¹Unidade de Saúde Familiar Lagoa - Unidade Local de Saúde de Matosinhos

²Unidade de Cuidados de Saúde Personalizados de Matosinhos - Unidade Local de Saúde de Matosinhos

INTRODUCTION: Generalized anxiety disorder (GAD) is amongst the most common of mental disorders in primary care (PC); however it is often not recognized because of the range of different anxiety disorders, co-morbidity, widespread lack of awareness of anxiety affected individuals and health practitioners, and the low confidence of many practitioners in their management. This emphasizes the need to provide strategies to improve clinical practice.

OBJECTIVE: Provide a practical, evidence-based guide on key steps in diagnosis and management of GAD, to PC physicians.

METHODS: A search was performed through databases, of English and Portuguese publications (2004-2015), using as search terms: “Generalized Anxiety Disorder”, “Treatment”, “Management”, “Primary Care”.

RESULTS: The general practitioners faces a significant challenge to establish GAD diagnosis, because anxiety symptoms are usually not the presenting complaints; therefore a structured clinical interview should be the first step to establish an accurate diagnosis, aided by the Diagnostic and Statistical Manual of Mental Disorders. The need for treatment is influenced by disease severity, impact of symptoms and the presence of comorbid disorders. The choice of a particular treatment should be influenced by patients characteristics, preferences and local availability options. Psychological therapy, based on cognitive behavior therapy and the first-line pharmacologic agents, selective serotonin reuptake inhibitors, are effective treatments. However, evidence suggests that the effects of psychological therapies may be more durable. It should be emphasized that treatment response is not immediate and that prolonged courses are needed to maintain results. Psychiatric referral should be considered in patients who fail to demonstrate improvement or if serious comorbid problems, such suicidal ideation or substance abuse.

CONCLUSION: The personal and societal burden associated with GAD is considerable, but many people who might benefit from treatment are not recognized or treated. The therapeutic approach should be based on educational, psychological or pharmacological interventions, according individual factors.

Keywords: “Generalized Anxiety Disorder”, “Treatment”, “Management”, “Primary Care”

Algorithm 1: Therapeutic Decision Algorithm in a patient with GAD. Legend: CBT - cognitive behavioral therapy.

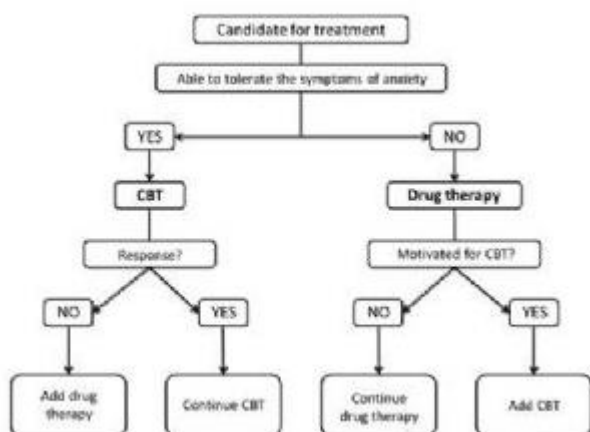


Table 1: Diagnostic Approach of GAD

Diagnostic approach: Key Points

Diagnostic approach: Key Points

Symptoms identification of anxiety

Excessive anxiety, worry, restlessness and stress and difficult to control, associated with functional impairment

Symptoms characterization	Intensity, frequency, duration, timing, development, relief or worsening factors
Somatic symptoms	Autonomic hyperactivity (palpitations, tachypnea, sweating), headache, dizziness, "light-headedness", muscle tension, tiredness, difficulty concentrating, sleep disturbances
Identification of psychosocial factors triggering anxiety	Life changes, separation, bereavement, recent or past trauma
Psychosocial exploration	Beliefs, expectations, content of thought, affection
Medical and psychiatric pathology, alcohol and drugs consumption	Personal history, physical examination and laboratory study, if appropriate

Table 2: Risk factors for GAD

Risk factors for GAD

Personal and familiar history of mood or anxiety disorders

Woman

Low socio-educational level

Presence of chronic medical illnesses

Susceptible pre morbid personality

Adverse life events (divorce, unemployment, serious illness, bereavement, adverse parenting in childhood)

Table 3: Differential Diagnosis of GAD

Differential Diagnosis	Differential Diagnosis
Non pathological anxiety	Less pervasive concerns, without psychosocial functioning impairment
Substances consumption or withdrawal	Sympathomimetics, xanthine derivatives, steroids, alcohol, illicit drugs, antidepressants, antipsychotics, hypnotics / sedatives, anticholinergics
Medical diseases	Neurological, cardiopulmonar or endocrine diseases
Psychiatric illness	Specific and social phobia, adjustment disorder, obsessive-compulsive disorder, depressive syndrome, psychotic disorder, posttraumatic stress and bipolarity

P-0135

Relationship between age and anxiety level in patients with Generalized Anxiety Disorder

Asli Ebiloglu¹, Umit Aydogan², Oktay Sari², Halil Akbulut³, Mehmet Ak⁴, Murat Erdem⁴, Aytekin Ozsahin⁴, Kenan Saglam⁵

¹Oran Outpatient Clinic, Primary Care & Family Health Center, Beytepe Military Hospital, Ankara, Turkey

²Department of Family Medicine, Gulhane Military Medical Faculty, Ankara, Turkey

³Akinci Outpatient Clinic, Primary Care & Family Health Center, Etimesgut Military Hospital, Ankara, Turkey

⁴Department of Psychiatry, Gulhane Military Medical Faculty, Ankara, Turkey

⁵Department of Internal Medicine, Gulhane Military Medical Faculty, Ankara, Turkey

AIM: Age seems to be one of the important factors in psychiatric disorders. This research was done to determine the relationship between age and anxiety levels of patients with generalized anxiety disorder (GAD).

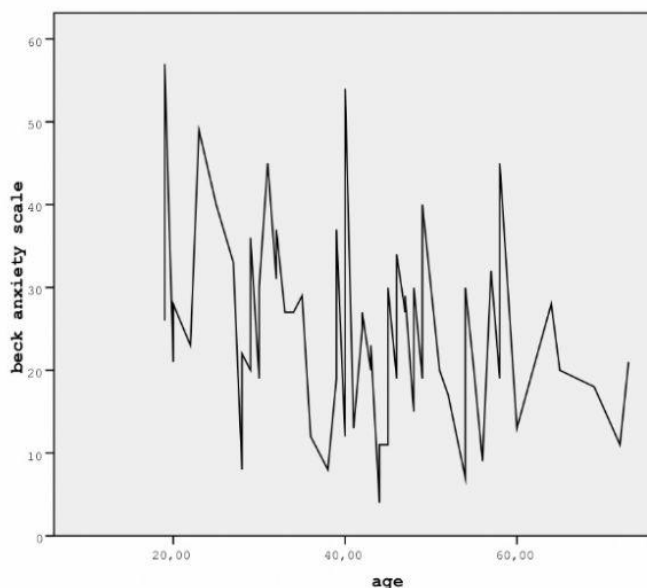
METHOD: Between 2009 to 2012, 73 patients enrolled in this study. Age and Beck Anxiety Scale score were (BASS) compared. SPSS 20 for Mac used to analyze the data.

RESULTS: There were 61 (83.6%) female and 12 (16.4%) male. Older patients had lower BASS than younger (p=0.009).

CONCLUSIONS: BASS seems to be lower in elderly patients.

Keywords: age, anxiety level, relationship

Figure



Pearson Correlation Between Age and Anxiety Level

P-0136

Madelung's disease VS Thyroid disease: report of a clinical case

Marta Lopes¹, David Rodrigues¹, Nídia Nunes¹, Susana Grilo Lourenço¹, Teresa Pereira Leite²

¹USF Planície, ARS Alentejo, Évora, Portugal

²USF Alcaides, ARS Alentejo, Montemor-O-Novo, Portugal

BACKGROUND & AIM: Madelung's disease, or multiple symmetric lipomatosis, is a rare disease, characterized by accumulation of unencapsulated fat, generally located symmetrically around the neck and shoulders. It is commonest in countries bordering the Mediterranean. Approximately 300 cases have been published. Benign symmetrical lipomatosis of the neck has to be differentiated from goiter, obesity or lymphatic tumor. This study describes the case of a patient with Madelung's disease whose diagnosis is often confused with thyroid pathology.

CASE DESCRIPTION: Patient male, 72 years old, Caucasian, inserted into nuclear family in the phase VIII of Duvall Cycle. Previous history of hypertension, dyslipidaemia, hyperuricemia, cerebral vascular disease and chronic alcoholism. In 2002 the patient was hospitalized for ischemic stroke, and it was detected a bilateral neck swelling compatible with enlarged thyroid. The patient had laboratory analysis, ultrasound and thyroid gammagraphy which were normal.

After hospital discharge, the patient appealed for the first time to your family doctor's consultation. The family doctor's realized bilateral neck swelling and returned to run tests and thyroid ultrasound that revealed no changes in the gland. However, the ultrasound showed a heterogeneous thickening of soft tissues prior to the thyroid. The patient had cervical computed tomography identified diffuse hypertrophy of adipose tissue in the neck, consistent with Madelung's disease.

In 2010 the patient it was hospitalized again. At the increase in cervical patient volume, the doctors returned consider the diagnosis of substernal goiter. The patient repeated analyzes and thyroid ultrasound, which again revealed no changes. The patient underwent a second cervical computed tomography that confirmed the

diagnosis of Madelung's disease.

CONCLUSIONS: Although the Madelung's disease can be diagnosed right after detailed clinical examination, this study pointed out possible diagnostic mistakes when a physician in a differentiation of symmetrical neck swellings doesn't consider the possibility of diagnosing a Madelung's disease.

Keywords: Madelung's disease; Lipomatosis; Thyroid disease

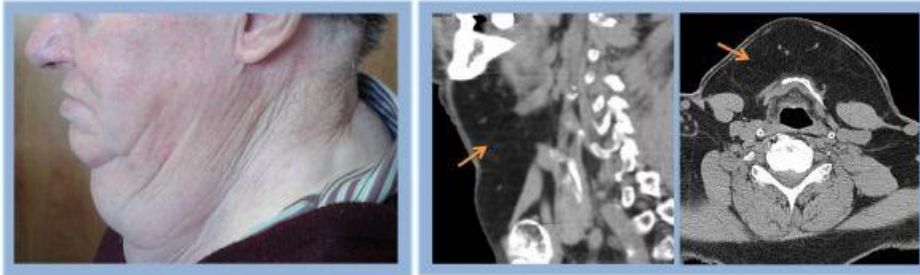


Figure 1 - Patient photography with fatty accumulation in the cervical areas

Figure 2 and 3 - Cervical CT scan showing areas of fat deposition

P-0137

Evaluation of Health Related Quality of Life in Obese Individuals

Fatma Kocaman¹, Berrin Telatar², Albena Gayef³, Can Öner²

¹Istanbul Bölge Hospital, Nutrition and Dietetics Specialist, Istanbul, Turkey

²Istanbul Bilim University, School of Medicine, Department of Family Medicine, Istanbul, Turkey

³Istanbul Bilim University, School of Medicine, Department of Medical Education and Informatics, Istanbul, Turkey

Background & AIM: Obesity increases morbidity, mortality and reduces the quality of life. The aim of this study is to investigate the effect of obesity on health-related quality levels of life.

METHOD: The study was conducted with 150 patients and their relatives admitted to the clinic within 2013. The ethics committee approval was taken. Individuals over 18 years of age were enrolled. Sociodemographic questionnaire form, health-related quality of life scale (SF-36) were used for data collection. Body Mass Index (BMI) was calculated. Questionnaires were administered through face to face interviews. The obese, overweight and normal individuals were compared by SF-36 subgroup mean scores. NCS 2007 was used for statistical analysis.

RESULTS: In the study (23.3%) individuals were obese, (35%) were overweight, (46.7%) were normal weight. Obesity was higher in women, in married and non-working individuals. ($p < 0,05$). 82.8% of obese individuals were dissatisfied with their weight ($p = 0,0001$). Familial, environmental and social pressure were significantly higher in obese ($p = 0,002$, $p = 0,042$). Individuals in each of the three groups want to lose weight primarily for health reasons and appearance at a lesser degree. Weakening demand for health reasons was highly significant in the obese group. Compared to sub-groups of the SF-36 scale, significant difference was found in physical function, general health and physical function components. Obese group's physical function means were significantly lower compared to the other two groups. Increasing weight had no effect on the mental dimension ($p > 0.05$).

CONCLUSIONS: Obese individuals are aware of the negative impacts of this situation. Psychological problems may arise as a result of prolonged obesity. Primary health care should be able to play more active role in obesity; presence of nutritionist, social worker and psychologist at primary healthcare institutions will provide a more holistic approach.

Keywords: Obesity, Health, Quality of Life

Table 1: Distributions of total and subscale mean scores of Health-related quality of life scale

	BKI (18,5-24,9) (n=70)	BKI (25-29,9) (n=45)	BKI (30 and above) (n=35)	p	Total (n=150)
Physical Function	91±12,76	79,78±24,43	69,29±25,42	0,0001	81,87±21,96
Social Function	77,32±20,44	75±25,42	70±25,58	0,317	74,92±23,98
Physical role function	82,86±31,14	76,67±39,31	70,71±39,52	0,250	78,17±35,86
Social role function	80±32,8	78,15±42,02	90,48±26,29	0,217	78,89±35,27
Mental Health	63,83±17,34	64±17,37	61,83±24,34	0,855	63,41±19,09
Vitality	63,71±16,57	62,22±18,97	59±25,02	0,508	62,17±19,49
Pain	79,05±21,03	74,81±27,05	72,06±29,57	0,372	76,15±25,07
General Health	54,43±10,82	49±10,74	50,86±13,58	0,041	51,97±11,67
Physical Health	76,83±12,78	70,06±19,34	64,8±23,48	0,005	72,04±18,32
Mental Health	71,22±16,55	67,34±20,97	70,33±21,93	0,568	69,85±19,22

Table 2: Comparison of physical function, general health, physical health according to the BMI groups.

Tukey Test	Physical Function	General Health	Physical Health
18,5-24,9 kg/m ² vs 25,0-29,9 kg/m ²	0,01	0,039	0,118
18,5-24,9 kg/m ² vs 30 kg/m ² and above	0,0001	0,294	0,004
25,0-29,9 kg/m ² vs 30 kg/m ² and above	0,008	0,754	0,415

P-0138

Prevalence of Peripheral Arterial Disease in Patients Who Require Home Care

Halis Yılmaz, Çiğdem Apaydın Kaya, Seda Arslan Özkul, Pemra Ünalın
Marmara University

Background & AIM: Most of the patients who need home care services are in high risk groups in terms of peripheral arterial disease (PAD). But, PAD may be asymptomatic in these patients due to inactivity. Determination of PAD in home care patients, may decrease ischemic events and risk of death. The aim of this study is to identify the prevalence of PAD and related factors in patients who are cared at home.

METHOD: This study is a cross-sectional study. The study was carried out among home care patients followed by Home Care Unit of Marmara University Hospital between June-December 2014. Two hundred eighty five patients (99 M, 186 F) who were older than 40 years old were included in the study. Ankle-brachial index (ABI) was assessed with a hand-held Doppler device and PAD was defined as ABI>0.9. Socio-demographic features, medical history and physical examination findings were recorded. Data were analyzed in terms of prevalence of PAD age and gender relation and other risk factors.

RESULTS: The mean age of the patients was 76±1.17 (42-100). The PAD prevalence of home care patients were 16.8% (12.4% for female, 25.3% for male). In the univariate analysis, male gender, skin fold thickness, diabetes mellitus, hypertension, CAD and ever smoking were associated with PAD (p<0.005). In multivariate analysis, ever smoking (OR:5.63), hypertension (OR:2.44) and high skinfold thickness (OR:1.11). were the risk factors for PAD.

CONCLUSIONS: This study is the first study that determined the prevalence of PAD and related risk factors in patients who require home care. Our study showed that the prevalence of PAD is high in home care patients. The patients who require home care, may be asymptomatic for PAD depending on inactivity. So, ABI measurement is very important for these patients.

Keywords: Ankle brachial index, peripheral arterial disease, home care, home health care services

Measurement of ABI

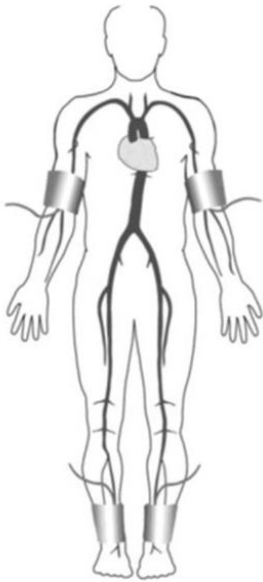


Table 1: Associated Factors with Peripheral Arterial Disease

	ABI<0.9	ABI≥0.9	p value	x2
Sex				
Female	23 (%12.4)	163 (%87.6)	0.006	7,66
Male	25 (%25.3)	74 (%74.7)		
Smoking status				
Ever	24 (35.3%)	44 (64.7%)	<0.001	21.77
Never	24 (11.1%)	193 (88.9%)		
DM				
Yes	20 (24.1)	63 (75.9%)	0.036	4.40
No	28 (13.9)	174 (86.1%)		
HT				
Yes	35 (21.0%)	132 (79.0%)	0.027	4.87
No	13 (11.0%)	105 (89.0%)		
CAD				
Yes	10 (32.3%)	21 (67.7%)	0.015	5.90
No	38 (15.0%)	216 (85.0%)		
Skinfold thickness	18.44 ± 7.78	14.93 ± 5.03	0.004	t value -3.92

Table 2: Risk Factors of PAD (Results of Multivariate Analysis)

	OR	95% CI	p value
Ever smoking	5.64	2.73-11.60	<0.001
HT	2.45	1.13-5.26	0.022
Skinfold thickness	1.12	1.05-1.18	<0.001

Logistic regression model include: sex, having diabetes mellitus, hypertension, coronary artery disease and skinfold thickness.

P-0139

ETHICCAR: Evaluation of therapeutic education for patient with high cardiovascular risk in primary care in France

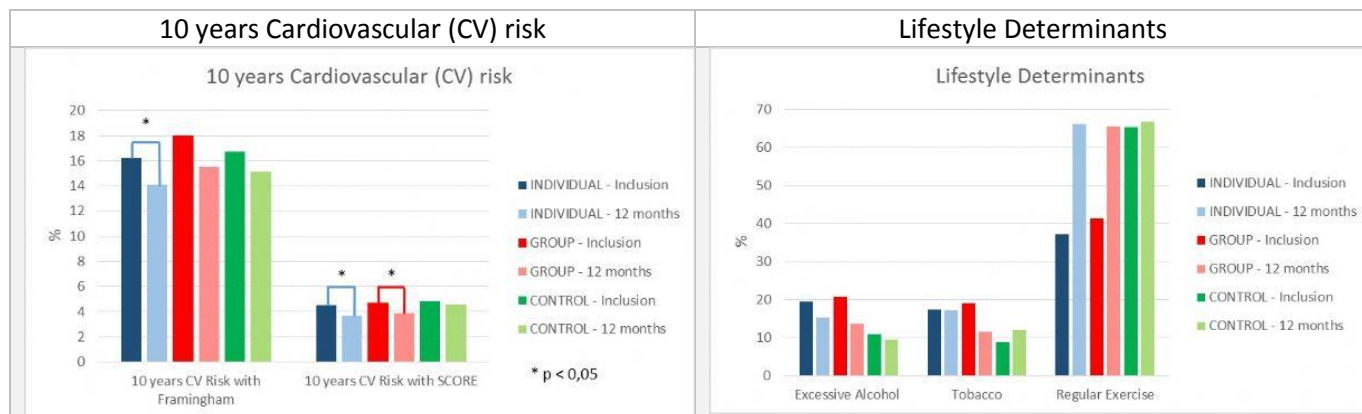
Mélanie Afonso, Jean Philippe Joseph, Jean Louis Demeaux, Marie Laure Marty, Bernard Gay
 General Practice Department, Bordeaux University, Bordeaux, France

Background and AIM: Therapeutic Patient Education (TPE) takes a larger place in the management of chronic diseases, particularly in primary health care. Educative interventions can have a positive impact on the patient outcomes in cardiovascular diseases, who are one of the leading causes of death in France, especially for untimely mortality. The research question is: what is the effect of TPE on risk score in patient with high cardiovascular risk? The aim is to analyse the efficacy of TPE on risk score and to compare individual or collective interventions. METHOD: Cluster-randomized controlled trial, comparing the effectiveness of individual or collective methods of TPE, vs usual follow-up (control group). Inclusion criteria: patients with at least 3 cardiovascular risk factors. Primary endpoint: cardiovascular risk score calculated using the Framingham and SCORE equations. Intention-to-treat analysis of risk evolution.

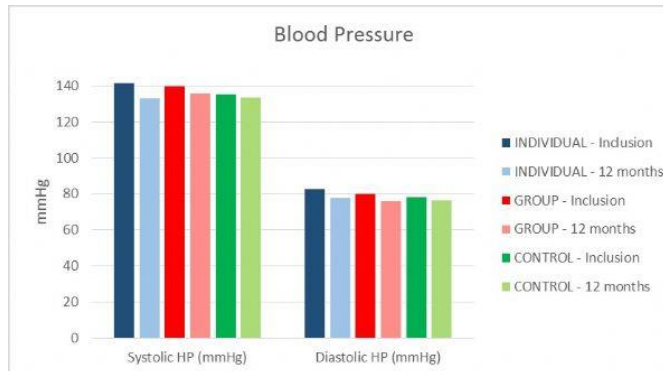
RESULTS: Of the 219 patients included (81 in the collective group, 78 in the individual group, 60 in the control group) from 72 GPs, 153 were followed in one year. Patient's characteristics were not significantly different in the 3 groups. The comparison of the risk score from the inclusion to one year in each of the 3 groups highlighted a significant difference in the individual group according to Framingham ($p=0.009$) and SCORE ($p<0.001$), and a significant difference in the collective group according to SCORE ($p=0.03$). The risk score between inclusion and 12-month declined overall by 1.7% according to Framingham and 0.6% according to SCORE, but this decrease appeared not significant in the 3 groups. There was no significant difference between the 3 groups in the percentage of patients with a risk score improved in 12 months.

CONCLUSIONS: At 12 months, despite a significant difference in intervention groups, the ETHICCAR study cannot highlight a possible effect of TPE in individual and collective groups vs control group.

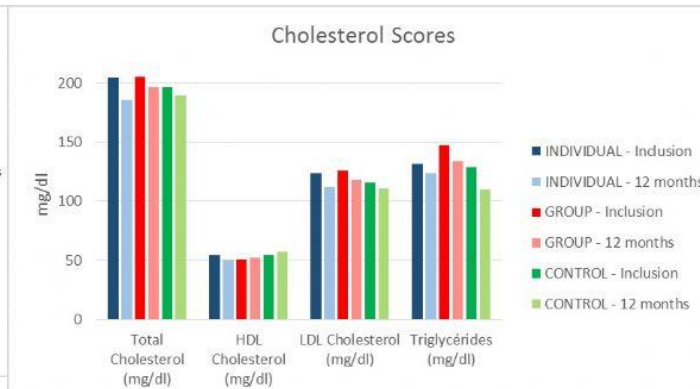
Keywords: therapeutic patient education, cardiovascular risk, general practice, primary prevention

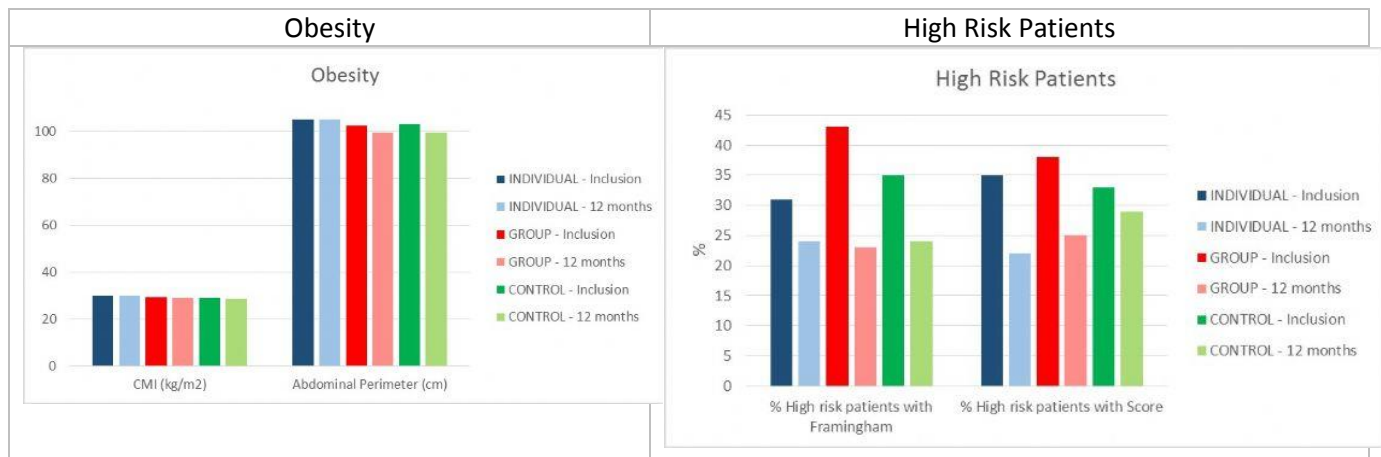


Blood Pressure



Cholesterol Scores





P-0140

Behçet disease – a case

Ana Patrícia Rodrigues Carvalho Rosa, Eliseo Manuel Álvarez Martínez, Carlos Filipe Martins Dos Santos, Andreia Filipa Lopes Fernandes

Family Health Care Unit Alcaides Faria, Barcelos, Portugal

Behçet's disease is a multisystemic disorder characterized by a generalized vasculitis with potential involvement of the blood vessels of all sizes, arterial and venous. There are no pathognomonic laboratory tests for this disease based on clinical diagnosis.

The authors describe a clinic case of a 43 years old woman, caucasian race, without a relevant clinical history. On September 2011 began recurrent episodes of maculo-papular skin lesions with some pustules and vesicles, variable location with achievement of upper and lower members. On suspicion of impetiginized allergic dermatitis was treated with corticosteroids and topical antibiotics with partial response and limited in time. Extended analytical study was made with nonspecific results. Skin biopsy was performed and result was consistent with Sweet's syndrome, so was made treatment with oral prednisone and dapsone. From September 2012 there is emergence of multiple episodes of recurrent oral and tongue aphthous ulcers, red eye and altered bowel habits. Endoscopic study performed with no significant results. There wasn't complete clinical remission despite established therapy. On May 2013, after the appearance of a massive vulvar ulceration, was established the diagnosis of Behçet's disease and started multidisciplinary hospital monitoring.

Initially treated with prednisolone and cyclophosphamide, without good response, had multiple hospital admissions for neurologic involvement of Behçet's disease. Currently in remission with combination therapy with prednisolone, azathioprine and infliximab. Behçet's disease is characterized clinically by recurrent presence of oral aphthae and other systemic manifestations including genital ulcers, eye disease, skin lesions, gastrointestinal disorders, neurological disease, vascular disease and arthritis; being the most frequent symptoms and earlier oral aphthae, skin lesions and urogenital ulcers. With this clinical case the authors want to emphasize the importance of the family doctor in the timely detection of systemic disorders with manifestations initially mucocutaneous.

Keywords: Behçet, aphthae, vasculitis

P-0141

COPD Screening in smokers and former smokers in primary care

Nuria Sanchez Ruano¹, Amparo Hervas¹, Cristina Colungo¹, Nora Selvi¹, Silvia Alvarez², Xavier Flor²

¹CAP Comte Borrell, CAPSBE, Barcelona, Spain.

²CAP Chafarinas, Barcelona, Spain.

Justification

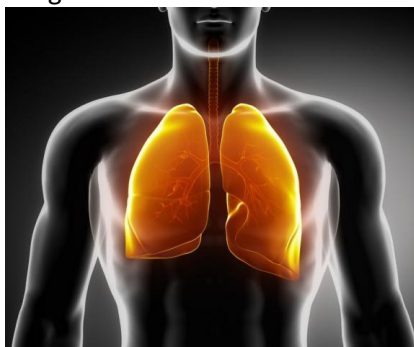
Chronic obstructive pulmonary disease (COPD) is the fourth leading cause of death in the world. Underdiagnosis of COPD seems to be common. Early diagnosis through case finding will allow for early actions, to influence smoking cessation and can achieve a reduction in the burden of COPD symptoms and reduced disease impact. Spirometry is required to make the diagnosis in the clinical context. The role of primary care is very important in the detection of patients with COPD. Recently designed several portable electronic devices that allow obtaining quickly FEV1, FEV6 and FEV1/FEV6 ratio, and replaces FVC (patient's ability to exhale all the air), for only the patient is able to exhale in 6 seconds. These devices are useful for screening for COPD in primary care and the ratio FEV1/FEV6 has a good correlation with the ratio FEV1/FVC. This "office spirometry" is validated for the detection of airway obstruction. They are an excellent screening tool for obstructive diseases. If results are normal COPD is discarded. If the results are altered we perform spirometry to confirm the diagnosis.

Content

We will screen all patients at risk, smokers or former smokers over 40 years with cumulative dose >10 pack-year in consultations at the center of the urban primary care. A screening test will be done with the portable device(COPD-6). If the result is the FEV1/FV6(COPD-6)<0.70 or FEV1%(COPD-6)<80% rate will perform a chest x-ray and standard spirometry to confirm or rule COPD. The following variables will be evaluated: gender, age, smoker or former smoker, cumulative dose pack-year, asymptomatic or symptoms: cough, dyspnea (mMRC), mucus; Portable spirometry RESULTS: FEV1(COPD-6), FEV6(COPD-6) and FEV1/FEV6(COPD-6) and pulmonary age; Results of conventional spirometry FEV1, FVC, FEV1/FVC post-bronchodilator, and finally new COPD diagnosis, GOLD classification and patients who quit smoking after our intervention.

Keywords: COPD Diagnosis Smoke

Lung



Screening



Tobacco



Vitalograph COPD-6



We are waiting for results

P-0142

Amyotrofik Lateral Skleroz (ALS) ALS patients in Marmara University Training and Research Hospital

Seyhan Hidirođlu, Tunç Laçın, Int.dr. Safa Tuncar, Int.dr. Beray Karademir, Int.dr. Ufuk Birim Öncü Öncü, Int.dr. Aykan Baş Baş, Int.dr. Mehmet Solmaz Solmaz, Int.dr. Levent Ođuzhan Demire Demirel, Melda Karavuş
Marmara Üniversitesi Tıp Fakóltesi Halk sađlığı

PURPOSE: To investigate environmental, occupational and heavy metal exposure in ALS patients in Marmara University Training and Research Hospital.

METHOD: Questionnaires, that includes 21 personal information and multiple choice questions, are administered by telephone to ALS patients in Marmara University Training and Research Hospital. The data was evaluated using the SPSS 16.0 program.

FINDINGS: To our study 30 diagnosed ALS patients and 70 people without ALS has participated.

%61 percent of 100 people in our research were female, %39 percent were male. %57 percent of the ALS patient group were female, %43 percent were male. %20 percent of the participants were college graduates, %16 percent of them were high school graduates, %52 percent of them were primary school graduates, %6 percent of them were just literate, %6 percent of them were illiterate. In our study to the question about the previous history of accident-trauma %86 percent answered "no", %14 percent answered "yes". In the ALS patient group this question was answered % 70 "no" and %30 as "yes". We found meaningful relation to this question however regarding the other questions we couldn't find a meaningful relation between the patient and the control group. There has been no meaningful relation in between the patient and the control group about the usage of sea products, tuna fish, oyster, salmon. There was no meaningful difference between the participants previous living areas and their occupations as well.

RESULTS: According to the data we acquired, there has been no meaningful result between the control and the patient groups. Relatively most important meaningful result we had was the accident trauma history in the ALS patients. In order to learn more about the disease more studies are required.

Keywords: ALS, a fatal motor neuron disease, heavy metal exposure

P-0143

Hypertension (HT) and Thiol/Disulphide Homeostasis

Basri Furkan Dađciođlu¹, İrep Karataş Eray², Tuncer Kılıç¹, Ahmet Keskin¹, Aylin Baydar Artantaş², Yusuf Üstü¹, Mehmet Uđurlu¹

¹Department of Family Medicine, Yıldırım Beyazıt University, Faculty of Medicine, Ankara, Turkey

²Family Medicine Clinic, Atatürk Training And Research Hospital, Ankara, Turkey

Background/AIMS: Thiol / disulphide homeostasis has a critical role in cellular events such as antioxidant protection and apoptosis. There is increasing evidence that deterioration in this balance plays role in the pathogenesis of various diseases including Hypertension. In this study, we aimed to investigate the relationship between HT and thiol/disulphide homeostasis which is a new indicator for the oxidative stress.

METHODS: Thiol / disulphide homeostasis parameters were studied in the blood samples of 51 patients with HT and 60 patients in the control group, who were 18 years or over and admitted to outpatient clinic of our hospital between December 2014 and March 2015. Subjects were selected from 574 patients according to exclusion criteria including history of chronic disease, smoking, alcohol consumption and malignancy. Venous blood samples were obtained from patients and centrifuged for 15 minutes at 3600 rpm to obtain plasma. After that, native thiol, disulphide, total thiol, index 1 (disulphide/native thiol), index 2 (disulphide/total thiol) and index 3 (native thiol/total thiol) levels were measured by an automated colorimetric analyzer. Statistical analyzes were performed on 111 patient who were included to the study. All statistical analyzes were performed with IBMSPSS Statistics (V.16) computer program. $P < 0,05$ was accepted as statistically significant.

RESULTS: Native thiol and total thiol levels of patients with HT were significantly lower than the control group [($p < 0,01$; $Z: -3,60$) and ($p < 0,01$; $Z: -3,96$) respectively]. Disulphide, index 1 and index 3 levels tended to be lower on patient group too, whereas the difference was not significant. (Table 1)

CONCLUSION: These findings are the first results of our continuing study and we aim to finish the process with higher amounts of patient data in order to publish the final results. Further studies may reveal the clinical importance of dynamic thiol/disulphide homeostasis on many conditions like HT.

Keywords: Thiol Disulphide Homeostasis, Hypertension, Oxidative stress

Table 1

Parameters	Groups	N	Mean Rank	p	Z
Native Thiol	Control	60	66.14	<0.001	-3.60
	HT	51	44.07		
	Total	111			
Disulphide	Control	60	57.11	0.694	-0.39
	HT	51	54.70		
	Total	111			
Total Thiol	Control	60	67.17	<0.001	-3.96
	HT	51	42.86		
	Total	111			
Index 1	Control	60	56.18	0.947	-0.06
	HT	51	55.78		
	Total	111			
Index 2	Control	60	54.20	0.509	-0.66
	HT	51	58.12		
	Total	111			
Index 3	Control	60	59.41	0.223	-1.21
	HT	51	51.99		
	Total	111			

P-0144

Prognostic value of ambulatory blood pressure monitoring in patients at high cardiovascular risk: diabetes mellitus type 2

Daniel Rey Aldana¹, Sergio Cinza Sanjurjo², Enrique López Paz³, Álvaro Hermida Ameijeiras³, Gaila Calvo González³, Carlos Calvo gomez³

¹centro de salud de a estrada, pontevedra, sergas, spain

²centro de salud de porto do son, a coruña, sergas, spain

³unidad de hipertensión y riesgo cardiovascular, servicio de medicina interna, complejo hospitalario universitario de santiago de compostela, a coruña, sergas, spain

Introduction and Objectives. Ambulatory Blood Pressure Monitoring (ABPM) defines the circadian variation and is the method of BP measurement that best defines the cardiovascular (CV) risk. Patients with Diabetes Mellitus (DM), are characterized by alterations in the circadian rhythm of ambulatory BP. The objective was to analyze the prognostic value of ABPM in a cohort of diabetic patients after 10 years of follow up.

Material and Methods. Cohort study in a sample of 766 unselected patients diagnosed with DM and HT. In all cases, a clinical-biological and MAP-24h evaluation was performed using monitors SpaceLabs and individualizing all reports. The follow-up of patients was performed by reviewing medical records, recording the event type (peripheral-EAP artery disease, coronary heart disease-CC, congestive heart-IC-stroke or cerebral vascular accident) and the date thereof.

Results. Follow up of 715 patients (274 women) was completed. During follow-up study, 319 events were recorded. Clinical variables, the presence of previous cardiovascular disease and established diabetic nephropathy negatively influence the CV prognosis and increase the incidence of events. From the values of MAP, those with greater prognostic correlation were nocturnal BP and circadian profiles in which a decrease or loss of depth of ambulatory blood pressure, $p < 0.0001$ is objective. The Kaplan-Meier curve shows that the circadian rhythms riser and non dipper are those with less free time of events.

Conclusions. Nocturnal blood pressure and decrease or loss of depth PA objectified by MAP, along with the presence of previous cardiovascular disease (including impairment of renal function and / or microalbuminuria) are the parameters that are associated with a worse cardiovascular prognosis of diabetic hypertensive patients, confirming the importance of the prognostic value of ABPM, and early diagnosis and treatment of these patients.

Keywords: Cardiovascular risk, Ambulatory blood pressure monitoring, Diabetes mellitus type 2

P-0145

Analysis of the temporal trend in poor control of anticoagulated patients in a cohort of primary care patients

Daniel Rey Aldana¹, Sergio Cinza Sanjurjo², Enrique Gestal Pereira², German Allut Vidal², Carmen Lires Rodríguez², Antonio Garcia Rechou², Beatriz Martínez Pérez²

¹centro de salud de a estrada, pontevedra, sergas, spain

²centro de salud de porto do son, a coruña, sergas, spain

Objective. Knowing the variables that influence the TRT, and especially the temporal trend in patients with insufficient TRT.

Material and methods. A longitudinal study from an unselected sample of all patients treated at a rural health care center over three years. Patients who received anticoagulation with antivitamin K for at least six months, for a non-valvular AF obtaining a final sample of 130 patients were selected.

Results. 53.1% were male, with a mean age of 77.0 ± 1.5 years. The prevalence of hypertension and DM was 90% and 33.8% respectively, and 11.5% and 14.9% had had heart failure or stroke. The average number of drugs consumed by patients was 7.6 ± 0.6 . The prevalence of inadequate control of TRT, calculated by Rosendaal, was 60.2% in 2011, 54.2% in 2010 and 43.4% in 2012. Analyzing the behavior of TRT in patients with insufficient control in the first quarter of follow-up, we observed that would remain low in the following years (69.7% vs 55%, $p = 0.0005$, in 2011), (71.9% vs 59.3%, $p = 0.0015$, in 2012) and (74.7% vs 60.0%, $p < 0.0005$, in 2013).

Conclusions. Our study shows that patients with poor INR control in the temporary exhibit no tendency to achieve the therapeutic goal, so we raised the need for early clinical decision making in patients anticoagulated given the prognostic implications of atrial fibrillation.

Keywords: Anticoagulated patients, Atrial fibrillation, Primary care

P-0146

Evaluation of Obesity and Blood Pressure Status of Health Care Workers: A Cross Sectional Study

Elif Altunbaş Ates, Turan Set

Department of Family Medicine, Karadeniz Technical University, Trabzon, Turkey

Background&AIM: According to one of the core-competencies of family medicine discipline community oriented care, it is important to identify the population and health needs. In this study we try to identify blood pressure levels, obesity status of health care workers at our hospital.

METHOD: This cross-sectional study was carried out among 341 health care workers between January 2015 and February 2015 in Karadeniz Technical University Research Hospital. Under the umbrella of periodic health examination these workers attended to Family Medicine Clinic. We designed a questionnaire which includes demographic characteristics and measurement of blood pressure, weight, height, waist and hip circumference. The data obtained were analyzed.

RESULTS: Female and male participants rates were 55.4% and 44.6% respectively. The mean age of male was 31.6 ± 8.5 ; mean age of women was 25.9 ± 7.5 years ($p < 0.001$). The percentage of hypertensive people was 4.3% ($n=15$). The mean BMI was 24.4 ± 4.1 kg/m²; average BMI of men was 25.6 ± 3.7 , women's average BMI was 23.5 ± 4.2 kg / m² ($p < 0.001$). Ratio of underweight, normal, overweight, obese participants were 4.4% ($n=15$), 56.8 % ($n=192$), 29.3% ($n=99$) and 9.5 % ($n=32$) respectively. While 50.3% of men are overweight or obese, this rate for women was 29.5% ($p < 0.001$). While the percentage of waist/hip ratio greater than 0.85 in women was 32.60% ($n=60$), this percentage was 4% ($n=6$) in men for waist/hip ratio greater than 1.

DISCUSSION: Participant's prevalence of hypertension was low according to the output of the population in Turkey. This might be attributed to doing research in the young population. According to our results obese participant's rate was low if we compare with Turkish population. But overweight population was greater than Turkish data which are at risk for obesity. We need to prepare a structured program for our health care workers not being an obese.

Keywords: Obesity, Blood Pressure, Health Care Workers, Periodic Health Examination

P-0147

Acute Stress Disorder - The beginning of an essential hypertension

Nuno Guerra, Joana Almeida, Marta Magalhães

Health Unity Camélias, Health Center Porto VII, Vila Nova de Gaia, Portugal

BACKGROUND: Stress, in its many different ways, can lead to a temporary blood pressure (BP) rise. Nevertheless, it is under discussion whether an acute stress situation can or not lead to a permanent blood pressure rise.

OBJECTIVE: The aim of this study is to report a case of essential hypertension in a young woman with no cardiovascular risk factors, detected after an acute stress situation.

Description: Female, 37 years old, belonging to a nuclear family in the I phase of Duvall Cycle, with a personal history of migraine without aura. During a period in which her father was under an induced coma due to hemorrhagic stroke, she visited her general practitioner (GP) presenting with insomnia, irritability, lack of concentration and fatigue. The physical examination showed a BP of 170/110mmg, so she initiated treatment with 5 mg alprazolam and self-measurement of blood pressure. On account of maintaining high blood pressure, she was medicated with Lisinopril 20 mg and secondary hypertension screening was carried out with no significant findings and a diagnosis of essential hypertension was assumed.

DISCUSSION: Although there is no scientific evidence that supports a relation between an acute stress situation and hypertension, some studies defend the hypothesis that an acute stress could lead to an excessive cardiovascular reactivity, due to autonomic neuro system stimulation, injuring the blood vessels and changing the blood pressure receptors.

One of the six core competences of family physicians is the Holistic Approach which uses a bio-psycho-social model, taking into account emotional and biological dimensions. This case report intends to raise awareness about biological alterations that can appear after an acute stress event.

Keywords: Hypertension, acute stress disorder

December 2013

Soap - Insomnia, irritability, lack of concentration and fatigue

sOap - BP: 170/110 mmHg with no other findings

soAp - High blood pressure, Anxiety

soaP - Alprazolam 0,5 mg/day + self-measurement of blood pressure

January 2014

Soap - Better from the anxiety symptoms. Maintain the high blood pressure

sOap - BP: 160/100 mmHg

soAp - Arterial Hypertension

soaP - Secondary hypertension screening (hemogram, cortisol, calcium, TSH, T4, urin exam, aldosterone, kidney ultrasonography, cerebral tomography, tyroid ultrasonography). Initiated lisinopril 20 mg

January 2014

The secondary hypertension screening showed no significant findings and a diagnosis of essential hypertension was assumed. The BP was controlled with lisinopril 20 mg.

P-0148**Factors affecting treatment compliance in iron deficiency anemia**

Süheyl Asma, Çiğdem Gereklioğlu, Aslı Korur

Başkent University, Department of Family Medicine, Adana, Türkiye

BACKGROUND: Treatment compliance is an important issue in long lasting treatments. We aimed to evaluate treatment compliance in patients who use peroral iron due to iron deficiency anemia.

MATERIAL-METHODS: A total of 120 patients aged between 18-53 years (30 ± 10.1) who were admitted to Family Medicine Clinic in March 2015 and who had the history of iron treatment due to iron deficiency anemia were included in the study.

RESULTS: Of the patients, 48% were detected not to use iron pills regularly or sufficiently. When the reasons were evaluated, 17% were found not to be informed adequately by their doctors, 10% discontinued the treatment as their symptoms relieved, 51% were found to develop gastrointestinal side effects and 25% of them were detected to discontinue the treatment due to this side effect, 13% were detected to forget to take the medication, 52% found to gain weight during the treatment and 23% of them reported that they discontinued the treatment due to this reason.

CONCLUSION: We may conclude that treatment compliance is poor in iron deficiency anemia. The most important factors seem as gastrointestinal side effects followed by weight gain. We believe that sufficient information may improve treatment compliance and further studies are required to investigate these factors in detail.

Keywords: iron treatment, compliance, primary care

P-0149**Self-esteem, Social Appearance Anxiety, Body Cathexis In Obese Individuals**

Niyazi Yilmaz, Mehtap Kartal

Department of Family Medicine, Dokuz Eylul University, Izmir, Turkey

Obesity is a medical situation that is easiest to recognize and hardest to treat. Its effect on mortality and morbidity is well-known, however studies on the psychosocial aspect of it increases. This study aims to put forth the relation between obesity and self-esteem, social appearance anxiety and body cathexis.

The study planned as a case-control included 18-65 years of age who have applied to 24th Family Health Center (FHC) in Konak, Izmir between April 2014 and December 2014 and completed with 361 people where 180 obese and 181 normal weight had similar gender ($p=0.564$), age ($p=0.508$). Permissions were taken from Ethical Committee of Dokuz Eylul University and Public Health Directorate of Izmir. A questionnaire prepared by the researcher in addition to the Rosenberg Self Esteem, Social Appearance Anxiety and Body Cathexis Scales applied to the participants face to face, and their weights and heights were recorded.

Compared to the control group obese had lower education level ($p=0.001$), lower income ($p=0.033$), having an obese mother ($p<0.001$) and father ($p<0.001$) more. Obese had more hypertension ($p<0.001$), diabetes ($p<0.001$), depression ($p<0.009$), higher quitting smoking rate ($p<0.001$) and exercising rate ($p<0.001$). The self esteem ($p<0.001$), social appearance anxiety ($p<0.001$), and body cathexis of the obese is ($p<0.001$) much lower than the control group.

Besides its well-known medical problems, obesity causes loss in psychosocial aspects. The feeling of guilt and stigmatization result in focusing on body and self perception in the obese. Thereby, in addition to their negative body and self perception they develop anxiety regarding their appearance. When evaluating their obese patients, family physicians should be aware of their psychosocial problems and should inform them to get support when needed.

Keywords: Obesity, self-esteem, social appearance anxiety, body cathexis

Fig.1 Comparison of Rosenberg self esteem scale scores between obese and nonobese

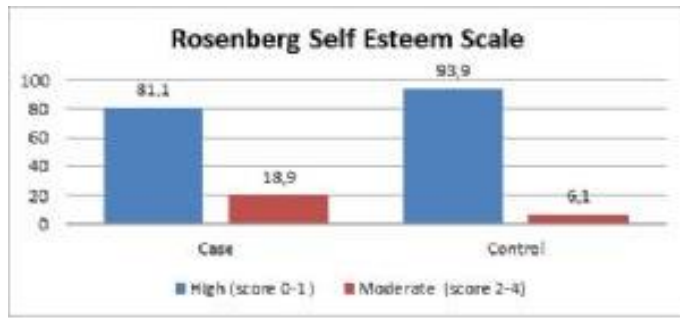


Fig. 2 Comparison of Social appearance anxiety scale scores between obese and nonobese

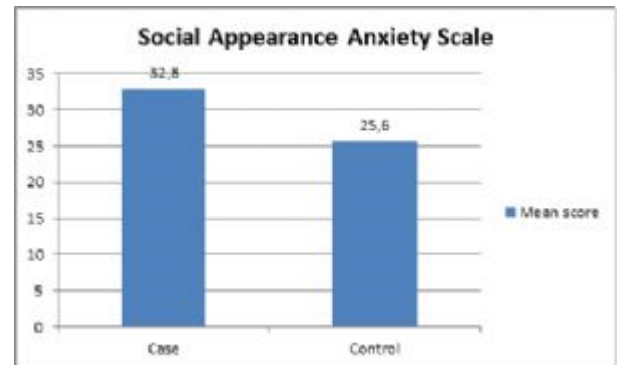
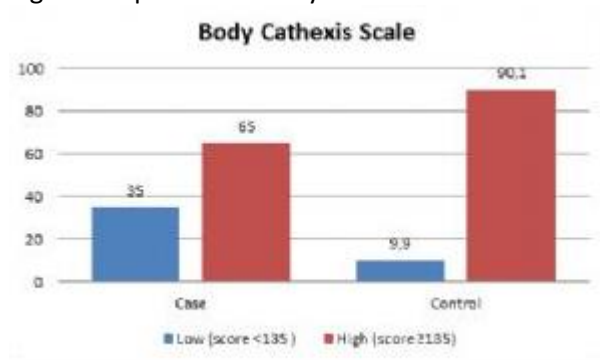


Fig. 3 Comparison of Body cathexis scale scores between obese and nonobese



P-0150

Usefulness of retinography by non-mydriatic camera in diabetic patients in a primary care center

Victor Lopez Marina¹, David Rodriguez Vargas¹, Rosa Alcolea Garcia², Teresa Rama Martinez³, Gregorio Pizarro Romero⁴, Dolors Costa Picañol², Maria Petra Perez Hervada²

¹Primary Care Center of Piera. Catalanian Health Institute. Barcelona. Spain.

²Primary Care Center of Besos. Catalanian Health Institute. Barcelona. Spain.

³Primary Care Center of Masnou-Alella. Catalanian Health Institute. Barcelona. Spain.

⁴Primary Care Center of Badalona 6-Llefià. Catalanian Health Institute. Barcelona. Spain.

- **Background and AIMS:** Diabetic retinopathy is a leading cause of blindness, appearing in 2% of patients with diabetes mellitus (DM) of less than 5 years of evolution and in 25% of those over 25 years. This study evaluates the usefulness of retinography by non-mydriatic camera (NMC) for the diagnosis of diabetic retinopathy and other visual disturbances suspected.
- **METHODS:** Design: a descriptive transversal study. Emplacement: an urban primary care center. Subjects: 614 patients referred in 2014 to review the ocular fundus by NMC. Variables: age, gender, diabetes type, treatment and outcomes of the NMC. Statistics: mean, standard deviation, percentages, Chi-square test for inferential statistics.
- **RESULTS:** Age: 66,3±14,1 years, 47% having an age of 61-80 years. Gender: 55% male and 45% female. Diabetes type: 3% DM-1, 91% DM-2 and 6% have not DM (hyperglycemia, secondary diabetes, etc). Treatment: 17% diet, 61% oral antidiabetics, 15% oral antidiabetic+insulin, 7% insulin. Outcomes of the NMC: 88% submitted to the prove and 12% not submitted. 68% with NMC normal, 32% pathological (7% non-proliferative retinopathy, 22% diminished visual acuity, 3% ocular high tension, 26,05% cataracts, 12,61% drusen, 5,6% proliferative retinopathy) (figure 1). Inferential statistics: 39,2% are men with normal NMC ($p < 0,0066$); 27,29% are men with oral antidiabetic agents ($p < 0,0001$); 33,05% are men and have normal visual acuity ($p < 0,0001$); 60% of patients diagnosed with DM in 2014 made NMC that year ($p < 0,0001$); 47,35% of diabetics which made retinography perform monitoring control in 24 months ($p < 0,0001$).
- **CONCLUSIONS:** Most are patients >60 years treated with oral antidiabetics. In 1/3 of cases were observed

various visual disturbances, which may coexist: 26,05% cataracts, 22% diminished visual acuity, 7% non-proliferative retinopathy and proliferative 5,6%, etc. The NMC performed in primary care is a good diagnostic tool of diabetic retinopathy and other visual disturbances suspected.

Keywords: Retinography, diabetic retinopathy, primary care.

Figure 1

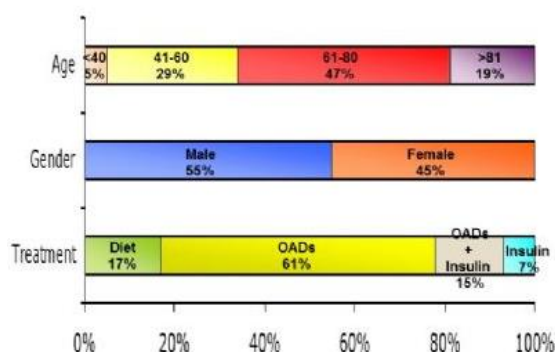
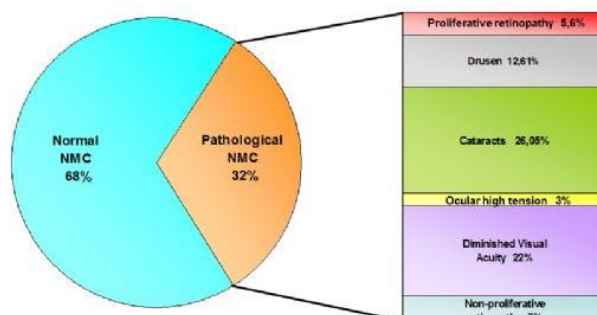


Figure 2



P-0151

The Evaluation On The Quality Of Life In The Patients Receiving Home Care Service

Yeşim Cengiz Balyen, Tahsin Çelepkolu, P. Gamze Erten Bucaktepe, Vasfiye Demir, Yeşim Doğrusöz, Serap Y. Aslan, Ahmet Yılmaz, Murat Orak, Mehmet Üstündağ
Dicle University Faculty of Medicine, Family Medicine, Istanbul, Turkey

INTRODUCTION:

Home care service is a healthcare model in which in-home health support including psychosocial, physiological, and medical support as well as social service is supplied for the individuals who are disabled or old, or the ones who are present with chronic diseases or spend their post-treatment recovery, which is aimed to help the patient readapt to social life and reduce family caregiver burden.

AIM: The aim of this study was to assess the quality of life of the patients receiving home care service and to discuss what regulations could be devised for this system.

METHOD: The universe of our study included the patients registered at the Home Care Services in Diyarbakır. The study included a total of 151 patients using a short form-36 (Sf-36) quality of life questionnaire including socio-demographic form.

RESULTS: All the mean quality of life scores were significantly lower than the standardized mean scores for Turkish community. The raw vitality, scaled vitality and mental health scores were significantly higher in unmarried patients. The raw general health perception (RGHP) scores were significantly lower in the uneducated group. RGHP, raw mental health, scaled general health perception and scaled mental health scores were significantly lower in the group with low level of income. RGHP and raw vitality scores were significantly higher in the patients cared for by a first-degree relative.

Conclusion and Suggestions:

Home care service should not be perceived as a mere service which only provides medical support for the patients; rather, it should be viewed as a service aiming to improve the quality of life of the patients by taking into account the sociodemographic characteristics of the patients and their families with a special focus on their material and pecuniary assets and by achieving active participation of state-run institutions, civil societies, and foundations.

Keywords: Home Health Care Services, Quality of Life

THE EVALUATION ON THE QUALITY OF LIFE IN THE PATIENTS RECEIVING HOME CARE SERVICE

Yeşim Cengiz Balyen¹, Tahsin Çelepkolu², P. Gamze Erten Bucaktepe³, Murat Orak⁴, Mehmet Üstündağ⁵, Vasfiye Demir⁶, Yeşim Doğrusöz⁷, Serap Yurdagül Arslan⁸, Ahmet Yılmaz⁹

¹Family Medicine Specialist
²Dicle University Medical Faculty Department of Family Medicine, Asst. Prof. Dr.
³Dicle University Medical Faculty Department of Emergency Medicine, Assoc. Prof. Dr.
⁴Dicle University Medical Faculty Department of Family Medicine, Res. Asst. Dr.

Introduction:

Home care service is a healthcare model in which in-home health support including psychosocial, physiological, and medical support as well as social service is supplied for the individuals who are disabled or old, or the ones who are present with chronic diseases or spend their post-treatment recovery, and to their family which is aimed to help the patient readapt to social life, prepare him/her for reintegration into society for a comfortable and powerful life, and reduce family caregiver burden.

Aim:

The aim of this study was to assess the quality of life of the patients receiving home care service and to discuss what regulations could be devised for this system.

Method:

The universe of our study included the patients registered at the Home Care Services subordinate to the Diyarbakir Provincial Health Directorate. The study included a total of 131 patients who were interviewed face-to-face in their homes using a short form-36 (SF-36) quality of life questionnaire including socio-demographic and cultural information between July 2013-2014. Data were analyzed using SPSS 20.0 (SPSS Inc., Chicago, IL, USA).

Results:

All the mean quality of life scores obtained in our study were significantly lower than the standardized mean scores for Turkish community (see Table). The evaluations of the quality of life scores based on the demographic characteristics of the patients were as follows:

Gender-based comparison revealed that the difference between the raw emotional role functioning scores for women and men were slightly significant ($p=0.045$). The comparison based on marital status indicated that the raw vitality, scaled vitality and mental health scores were significantly higher in unmarried patients compared to married patients ($p<0.001$, $p<0.001$, $p<0.002$, respectively). The raw physical functionality and raw physical role functioning scores were significantly higher in the group with high level of education compared to other two groups ($p<0.001$, $p<0.001$, respectively). The raw general health perception scores were significantly lower in the uneducated group ($p=0.010$). The raw general health perception and raw mental health scores were significantly lower in the group with low level of income ($p<0.006$, $p<0.010$, respectively). The raw general health perception and raw vitality scores were significantly higher in the patients cared for by a first-degree relative ($p<0.006$, $p<0.010$, respectively). The raw general health perception and scaled general health perception scores were significantly lower in the group with a monthly income of <1.000 compared to the group with a monthly income of 1.000-1.500 ($p<0.006$ for both) and the raw mental health and scaled mental health scores were significantly lower in the group with a monthly income of <1.000 compared to the group with a monthly income of 1-1.500 ($p<0.010$ for both).

Subscales	Mean±Standard Deviation		p
	Turkish community	Patients (95% Confidence interval)	
Physical functionality	86.6±25.2	10.46±0.20 (10.7-10.86)	<0.0001
Physical role functioning	89.5±29.6	4.03±0.03 (3.97-4.08)	<0.0001
Pain	86.1±20.6	4.50±0.09 (4.31-4.68)	<0.0001
General health perception	73.9±17.5	9.72±0.25 (9.22-10.22)	<0.0001
Vitality	67.0±13.8	8.46±0.32 (7.82-9.09)	<0.0001
Social functionality	94.8±14.2	2.83±0.08 (2.68-2.99)	<0.0001
Emotional role functioning	94.7±20.9	2.97±0.01 (2.95-3.00)	<0.0001
Mental health	73.5±11.6	13.86±0.45 (12.97-14.75)	<0.0001

CONCLUSION:

Home care service should not be perceived as a mere service which only provides medical support for the patient and improve their quality of life, rather, it should be viewed as a service aiming to improve the quality of life of the patients by taking into account the socio-demographic characteristics of the patients and their families with a special focus on their material and primary assets and by addressing their perception of various situations, civil society, and information. Accordingly, establishing a systematic and applicable approach with minimum cash support will not undermine the value of home care service but also will provide a thoughtful workflow for this system.

REFERENCES:

1. Zeki K. Evde bakım hizmeti alanın aile üyesi bakım alanları mental ve fiziksel durumlarının değerlendirilmesi. Rize Üniversitesi Sosyal Bilimler Enstitüsü Dergisi, 2008; 10(1): 1-10.
2. Dany M.Z. Geriatri ve nöropsikiyatriye yaklaşım temelinde bakım alanları. Hastalıklar Dergisi, 2009; <http://www.gimadigit.com.tr/soz/geriatri/geriatri.htm>
3. Koçgenç H, Aydemir Ö, Hancı G ve ark. Kim Form-36'nun sarkotik sarboşuvarın değerlendirilme ve geçerliliği. Sağlık ve Tıbbi Dergisi, 1999; 12: 102-106.

THE QUALITY OF LIFE

Mean±Standard Deviation

Subscales	Turkish community	Patients (95% Confidence interval) p	
Physical functionality	86.6±25.2	10.46±0.20 (10.7-10.86)	<0.0001
Physical role functioning	89.5±29.6	4.03±0.03 (3.97-4.08)	<0.0001
Pain	86.1±20.6	4.50±0.09 (4.31-4.68)	<0.0001
General health perception	73.9±17.5	9.72±0.25 (9.22-10.22)	<0.0001
Vitality	67.0±13.8	8.46±0.32 (7.82-9.09)	<0.0001
Social functionality	94.8±14.2	2.83±0.08 (2.68-2.99)	<0.0001
Emotional role functioning	94.7±20.9	2.97±0.01 (2.95-3.00)	<0.0001
Mental health	73.5±11.6	13.86±0.45 (12.97-14.75)	<0.0001

P-0152

The Evaluation On The Quality Of Life In The Relative Caregivers Providing Home Care Service

Yeşim Cengiz Balyen, Tahsin Çelepkolu, P. Gamze Erten Bucaktepe, Vasfiye Demir, Yeşim Doğrusöz, Serap Y. Arslan, Ahmet Yılmaz, Murat Orak, Mehmet Üstündağ
 Dicle University Faculty of Medicine, Family Medicine, Istanbul, Turkey

INTRODUCTION: Home care service is a healthcare model in which in-home health support including psychosocial, physiological, and medical support as well as social service is supplied for the individuals who are disabled or old, or the ones who are present with chronic diseases or spend their post-treatment recovery, which is aimed to help the patient readapt to social life and reduce family caregiver burden.

AIM: The aim of this study was to assess the quality of life of the relative caregivers providing home care service and to discuss what regulations could be devised for this system.

METHOD: The universe of our study included the patients', who are registered at the Home Care Services subordinate to the Diyarbakır Provincial Health Directorate, relative caregivers. The study included a total of 153 caregivers using a short form-36 (Sf-36) quality of life questionnaire including socio-demographic and cultural information between July 1 and August 31, 2014.

RESULTS: All the mean quality of life scores obtained in our study were significantly lower than the standardized mean scores for Turkish community (see Table). Gender-based comparison revealed that the scaled pain scores were significantly lower in women compared to men ($p=0.039$). Both the raw and scaled physical functionality scores were significantly higher in the group with low level of income ($p=0.010$, $p=0.004$, respectively).

Conclusion and Suggestions: Home care service is not a service that can be overcome by the caregivers alone. Caregivers should be trained about the disease of their patient and also full-time nursing services should be provided for caregivers in order to prevent their work losses and help them with physical difficulties. Establishing a systematic and applicable approach with minimum fault tolerance will not only enhance the value of this service but also will provide a thoroughgoing workflow for this system

Keywords: Home Health Care Services, Quality of Life, Caring relatives

WONCA RELATIVE CAREGIVERS

THE EVALUATION OF THE QUALITY OF LIFE IN THE RELATIVE CAREGIVERS PROVIDING HOME CARE SERVICE

Yeşim Çengiz Balçın¹, Tahsin Çelepköfçü², P.Gamze Eren Bıcaktepe³, Miran Onuk⁴, Mehmet Cstüneli², Vasilije Demir¹, Yeşim Doğruoğlu⁵, Serap Yurkugül Anıkar¹, Ahmet Yılmaz²
¹Family Medicine Specialist
²Dicle University Medical Faculty Department of Family Medicine, Asst. Prof. Dr.
³Dicle University Medical Faculty Department of Emergency Medicine, Assoc. Prof. Dr.
⁴Dicle University Medical Faculty Department of Family Medicine, Res. Asst. Dr.

Introduction:
Home care service is a healthcare model in which in-home health support including psychosocial, physiological, and medical support as well as social service is supplied for the individuals who are disabled or old, or the ones who are present with chronic diseases or spend their post-treatment recovery, and to their family, which is aimed to help the patient readapt to social life, prepare him/her for reintegration into society for a comfortable and peaceful life, and reduce family caregiver burden.

Aim:
The aim of this study was to assess the quality of life of the relative caregivers providing home care service and to discuss what regulations could be devised for this system.

Method:
The universe of our study included the patients', who are registered at the Home Care Services subordinate to the Diyarbakır Provincial Health Directorate, relative caregivers. The study included a total of 153 caregivers who were interviewed face-to-face in their homes using a short form-36 (Sf-36) quality of life questionnaire including socio-demographic and cultural information between July 1 and August 31, 2014. Data were analyzed using SPSS 20.0 (SPSS Inc., Chicago, IL, USA).

Results:
All the mean quality of life scores obtained in our study were significantly lower than the standardized mean scores for Turkish community (see Table). Gender-based comparison revealed that the scaled pain scores were significantly lower in women compared to men ($p=0.039$). Both the raw and scaled physical functionality scores were significantly higher in the group with low level of income ($p=0.010$, $p=0.004$, respectively).

Subscales	Mean±Standard Deviation		p
	Turkish community	Patients (95% Confidence interval)	
Physical functionality	86.6±25.2	28.08±3.88 (19.54-36.82)	<0.0001
Physical role functioning	89.5±29.6	13.82±8.64 (-5.42-33.06)	
Pain	86.1±20.6	11.55±4.04 (2.56-20.54)	
General health perception	73.9±17.5	17.91±5.29 (6.12-29.70)	
Vitality	67.0±13.8	15.64±4.78 (4.98-26.29)	
Social functionality	94.8±14.2	14.82±7.55 (-2.05-31.64)	
Emotional role functioning	94.7±20.9	4.27±0.56 (3.08-5.51)	
Mean health	73.5±11.6	18.82±1.71 (15.02-22.62)	

Conclusion and Suggestions:
Home care service is not a service that can be overcome by the caregivers alone. Caregivers should be trained about the disease of their patient and also full-time nursing services should be provided for caregivers in order to prevent their work losses and help them with physical difficulties. Establishing a systematic and applicable approach with minimum fault tolerance will not only enhance the value of this service but also will provide a thoroughgoing workflow for this system.

References:
1. Zeki K., Evde bakım hizmetleri aile bireyleri bakacaklarının moral ve manevi değerlerinin başka cümledeki etkisi. Rize Üniversitesi Sosyal Bilimler Enstitüsü Dini Psikolojisi Bilim Dalı, Yüksek Lisans Tezi, Rize 2011.
2. Dramalı A, Demir F, Yavuz M. Evde kronik hastaya bakım veren hasta yakınlarının karşılaştıkları sorunlar. I. Ulusal Evde Bakım Kongresi Kitabı, İstanbul 1998; 13.
3. Altun İ. Hasta yakınlarının bakım verme rollerinde zorlanma durumları, I. Ulusal Evde Bakım Kongresi Özet Kitabı, İstanbul 1998; s. 71-78.

QUALITY OF LIFE

Subscales	Mean±Standard Deviation		
	Turkish community	Patients (95% Confidence interval)	p
Physical functionality	86.6±25.2	28.08±3.88 (19.54-36.82)	<0.0001
Physical role functioning	89.5±29.6	13.82±8.64 (-5.42-33.06)	<0.0001
Pain	86.1±20.6	11.55±4.04 (2.56-20.54)	<0.0001
General health perception	73.9±17.5	17.91±5.29 (6.12-29.70)	<0.0001
Vitality	67.0±13.8	15.64±4.78 (4.98-26.29)	<0.0001
Social functionality	94.8±14.2	14.82±7.55 (-2.05-31.64)	<0.0001
Emotional role functioning	94.7±20.9	4.27±0.56 (3.08-5.51)	<0.0001
Mean health	73.5±11.6	18.82±1.71 (15.02-22.62)	<0.0001

P-0153

Quality of life and sleep disturbances in elderly symptomatic patients with stable Chronic Obstructive Pulmonary Disease

Apostolos Manolis¹, Eleni Leontidou¹, Evangelia Nena⁴, Grigorios Trypsianis², Theodoros Konstantinidis⁴, Pashalis Steiropoulos³

¹Health Center of Iasmos, Komotini, Greece

²Department of Laboratory of Medical Statistics, Democritus University, Alexandroupolis, Greece

³Department of Pneumology, Democritus University, Alexandroupolis, Greece

⁴Department of Laboratory of Hygiene and Environmental Protection, Democritus University, Alexandroupolis, Greece

BACKGROUND: Impairment of health-related quality of life (HRQoL) and sleep quality are common but underestimated in patients with Chronic Obstructive Pulmonary Disease (COPD). Purpose of the study was to assess HRQoL and sleep characteristics of COPD patients with severe dyspnea and poor disease control.

METHODS: Consecutive patients with stable COPD (n= 60) were included. Their score in the Medical Research Council Dyspnea Scale (MRC) was indicative of severe dyspnea (MRC \geq 2). Additionally, their scores in COPD Assessment Test (CAT) indicated poor COPD control (CAT score \geq 10). All included patients answered the following questionnaires: Athens Insomnia Scale (AIS; for insomnia), Epworth Sleepiness Scale (ESS; for daytime sleepiness), Pittsburg Sleep Quality Index (PSQI; for sleep quality) and WHO-5 Well-Being Index (for QoL).

RESULTS: Patients were all males, mean aged 74.4, overweight (mean BMI of 28.2 ± 2.7 kg/m²) with impaired respiratory function (FEV1 $40.8 \pm 13.5\%$ pred, FVC $57.4 \pm 14.3\%$ pred, FEV1/FVC $54.7 \pm 9\%$ pred). In 86.7% of patients (n=52) the WHO-5 questionnaire was indicative of poor quality of life. Overall, 83.3% of patients (n = 50) reported poor sleep quality (PSQI score $>$ 5). Insomnia (AIS score \geq 6) was reported by the vast majority (n = 56; 93.3%). On the contrary, daytime sleepiness (ESS score $>$ 10) was reported only by four patients (6.7%).

CONCLUSIONS: COPD patients with poor disease control, apart from the disease-related symptoms, also experience insomnia, poor sleep quality and impaired QoL. This should be always kept in mind of family physicians, in order to deliver best quality care to their patients

Keywords: COPD, Elderly, Insomnia, Poor sleep quality, WHO-5 WELL-Being Index

P-0154

A case of Takayasu arteritis presenting with weight loss and elevated erythrocyte sedimentation rate

Süheyl Asma, Çiğdem Gereklioğlu, Aslı Korur

Başkent University, Department of Family Medicine, Adana, Türkiye

BACKGROUND: Takayasu arteritis known as pulseless disease is a granulomatous vasculitis characterized by massive intimal fibrosis and affecting large vessels. It is common among middle-aged women.

MATERIAL-METHOD: In this case report, a 24-year-old female patient who was admitted to Family Medicine Clinic due to fatigue, weight loss and elevated erythrocyte sedimentation rate (ESR) with unknown origin lasting for six month and diagnosed with Takayasu arteritis as pulse could not be detected in the left arm is presented. Her medical history was uneventful. The left radial and ulnar pulses could not be palpated on her physical examination.

RESULTS: She was referred to Interventional Radiology and MR angiography revealed normal arcus aorta and normal main vascular structures originating from arcus aorta, severe stenosis approximately 3 cm in the left axillary artery and also a mild stenosis in the proximal part of the right renal artery. Her blood tests were normal except ESR of 68 mm/h, C-reactive protein (CRP) of 101 mg/L. She had no additional radiologic abnormality. She was referred to Rheumatology Clinic and diagnosed with Takayasu arteritis, steroid+methotrexate treatment was started. Acute phase reactant levels were detected to regress and her clinical condition was seen to improve after immuno-suppressive treatment.

CONCLUSION: We may conclude that diagnosis should not be based on only laboratory findings but a careful and detailed physical examination is essential in primary care. Further tests should be planned according to the preliminary data.

Keywords: Takayasu, arteritis, physical examination

P-0155

The prevalence of metabolic syndrome in Hashimoto's thyroiditis patients and correlation with various parameters

Murat Atmaca, Zeynep Tuzcular Vural, Işık Gönenç, Refik Demirtunç
Haydarpaşa Numune Training And Research Hospital Family Medicine Department

Background & AIM: Hashimoto's thyroiditis is an autoimmune disease in which the immune system attacks the thyroid gland, causing primary hypothyroidism. In this study, we aimed to investigate the prevalence of metabolic syndrome in Hashimoto's thyroiditis patients and correlation with various parameters.

METHOD: In this cross-sectional study, 116 women with Hashimoto's thyroiditis, followed up in our outpatient clinic, constituted the material of our research. Examinations and laboratory tests included thyroid function tests, anti-TPO and anti-TG levels and thyroid nodule presence. ATP III criteria were used for diagnosing metabolic syndrome.

RESULTS: We found the prevalence of metabolic syndrome to be 37.9% in our study. Correlation with age, showed that metabolic syndrome increased with age. The BMI levels of 18-29 year olds were lower and the insulin levels of 30-39 year olds were higher compared to other age groups. In regard to insulin resistance, there were no statistically significant differences amongst different age groups. There was negative correlation with higher education levels and work status and the prevalence of metabolic syndrome. Thyroid nodule diameters were statistically significantly higher in women with metabolic syndrome. Although our results correlate with other studies showing higher risks of metabolic syndrome with presence of thyroid nodules, large scale studies and widespread research should be conducted for more definite results. Receiving thyroid replacement therapy, anti-TPO and anti-TG positivity was not related to metabolic syndrome, insulin resistance, or BMI measurements.

CONCLUSIONS: As a result we believe that the prevalence of metabolic syndrome was very high in our study group. Family medicine specialists and physicians working in primary care health services should be aware of the age-related increasing risk for metabolic syndrome and should advise their patients to make lifestyle changes whenever necessary.

Keywords: Chronic autoimmune thyroiditis, Hashimoto's thyroiditis, metabolic syndrome

Table 1: Prevalence of metabolic syndrome in our study group with Hashimoto's thyroiditis

Age	%
18-29	5,6
30-39	27,8
40-49	45,9
50-59	46,9
≥ 60	54,5
Prevalence	37,9

Table 2: Prevalence of metabolic syndrome in Turkish urban women (METSAR 2004)

Age	%
20 - 29	9,6
30 - 39	29,7
40 - 49	51,6
50 - 59	67,9
60 - 69	74,6
≥ 70	68,6
Prevalence	39,6

P-0156

Relation between severity of hyponatremia and comorbidity in elderly patients who develop hyponatremia

Nuket Bayram Kayar¹, Yusuf Kayar², Dede Sit³

¹Department of Family Medicine, Bagcilar Education and Traditional Hospital, Istanbul, Turkey

²Department of Internal Medicine, Bezmialem Vakif University, Istanbul, Turkey

³Department of Internal Medicine, Bagcilar Education and Traditional Hospital, Istanbul, Turkey

INTRODUCTION: Hyponatremia has a higher incidence among elderly individuals. There are few studies include uptodate information on the relationship between severity of hyponatremia and comorbidity. The aims of our study are that; comorbid conditions in elderly inpatients diagnosed with hyponatremia and the relationship between hyponatremia severity and comorbid conditions.

MATERIALS-METHOD: A total 978 patients aged 65 years and older admitted for inpatient care at our clinic over the past one year were considered for our study. 176 patients with serum sodium <135 mEq/L were included in the study. Sodium levels between 126 and 135 mEq/L were defined as mild, between 116 and 125 mEq/L as moderate and 115 mEq/L and below as severe hyponatremia. The concomitant hyponatremia and comorbid conditions, the relationships between severity of hyponatremia and comorbid conditions were studied.

RESULTS: 7.2 years (65–95 years). Hyponatremia was significantly higher among women (female/male: 109/67; 61.6% vs. 38.4%). 121 patients (68.7%) had mild, 41 (23.2%) had moderate and 14(7.9%) had severe hyponatremia. Ninety-two patients (52.2%) had diabetes mellitus, 130 (73.8%) had hypertension and 87(49.4%) had chronic renal failure. A significant relationship was found between hyponatremia severity and ischemic and congestive heart diseases, neurological disorders, psychiatric disorders and thyroid dysfunction. In addition moderate and severe hyponatremia increased with higher number of comorbidities.±Patients' mean age was 76.1

CONCLUSION: Comorbid conditions may cause hyponatremia through several mechanisms but hyponatremia severity may differ. Hospitalizations, morbidity, mortality rates and healthcare expenses due to hyponatremia can be reduced with regular care of geriatric patients.

Keywords: Hyponatremia; Geriatric patients; Comorbidity

P-0157

The Factors That Influence Physical therapy Patients' Lower Back Pain

Edibe Pirincci¹, Ferit Kaya², Eyyup Demirpolat³

¹Firat University School of Medicine. Department of Public Health

²Public Health Institution

³Training and Research Hospital

BACKGROUND & AIM: This study analyzes the factors that influence the lower back pain of patients in the Physiotherapy Unit of an Education and Research Hospital.

METHOD: The study sample included 102 patients who came to the physiotherapy unit and voluntarily participated in the study. The data were collected using a 23-question survey form created by the authors based on a review of the relevant literature. The data were entered into the SPSS Program For comparisons, p values below 0.05 were deemed to be statistically significant.

RESULTS: The average age of the participants is 46.78±14.40. Of the participants 65.6% are female. By occupation, lower back pain is most common among housewives. Of the patients who suffer from lower back pain, 57.8% are overweight or obese. Of the patients who suffer from lower back pain 11 times or more a year, the percentage of smokers is 66.7%, while this rate is 35.7% among nonsmokers (p<0.05). The increase in lower back pain with body mass index is not statistically significant (p>0.05). Of those experiencing lower back pain, 73.5% stand on their feet for long periods of time, and 67.6% lift heavy loads. The frequency of lower back pain among patients who do not receive drug therapy is greater than that of patients who do (p<0.05). Of the patients, 69.6% have lower back pain in their family, and 29.4% of the family members with lower back pain are their mothers.

CONCLUSION: More than half of the patients who have this pain are overweight or obese. Patients with lower back pain also tend to have family members with lower back pain. Smoking increases the frequency of lower back

pain. If measures are taken to reduce risk factors, the frequency of lower back pain which hinders daily life activities can be reduced.

Keywords: lower back pain, hospital, patient

P-0158

Amaurosi fugax: a wake-up call for General Practitioner

Camilla Bersani, Nelson Gentile

Department of Primary Care, Ausl Bologna, Italy

BACKGROUND and AIM: Symptomatic carotid disease is defined as focal neurologic symptoms, sudden in onset and referable to the appropriate carotid artery distribution, including transient ischemic attacks (like amaurosi fugax; differential diagnosis in Tab.1), or minor strokes. The aim of this case report is to underline the role of General Practitioner (GP) to educate and first evaluate his patients.

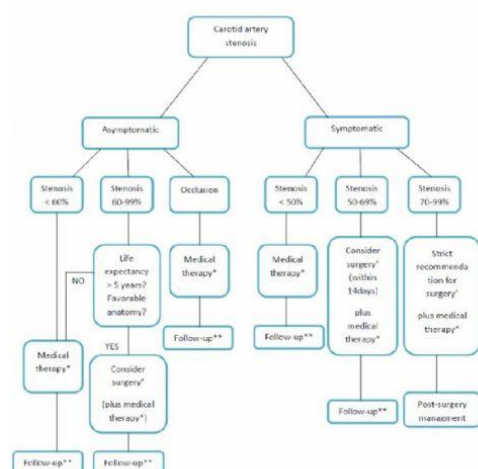
METHODS: M.S., male, 58 years old, overweight (BMI 28,6), smoker, pre-hypertension (140/86 mmHg), psoriasis with spotty dermatological manifestation, monocular since childhood for a trauma injury, hypercholesterolemia with hypertriglyceridemia in therapy only with omega-3-fatty-acid, not eligible to statins for high serum CPK baseline level. The patient was visiting his doctor for some right eye episodes of amaurosi fugax in march 2015. Physical examination: regular heart beats, blood pressure 156/86 mmHg, bilateral carotid bruit. GP added olmesartan and cardioaspirin, then sent MS to do carotid duplex ultrasound that evidenced bilateral stenosis (internal right 65-70 %). Afterwards the patient underwent right carotid endoarterectomy in last april 2015. Finally was started a therapy with amlodipina, doxazosina (plus enoxaparina for a week).

DISCUSSION: Stroke is the third cause of death in Italy and the first for disability. A common process leading to ischemic stroke is the complication of a carotid artery atherosclerotic plaque. Atherosclerosis is strictly connected with everyday life behavior. Primary prevention consist in stopping smoking, keeping fit, management of hypertension, diabete and/or dislipidemia. Carotid stenosis is suspected by carotid bruit at auscultation and detected with duplex ultrasound. Second level examinations are Computed Tomography Angiography and Magnetic Resonance Angiography. The treatment is medical therapy or surgery (endoarterectomy or stenting) according to stenosis percentage (Image 1).

CONCLUSIONS: Amaurosi fugax is a red flag for serious conditions. GP is the first to evaluate and manage correctly such pathologies to prevent morbidity and mortality.

Keywords: amaurosi fugax, carotid artery stenosis, stroke, prevention, general practitioner

Image 1. Flow-chart of carotid artery stenosis management



*Antiplatelet agents, anti hypertensive drugs, diabet and/or dyslipidemia treatment
 **Follow-up every 6-12 months
 *Endoarterectomy or stenting after careful evaluation of age of patient, co-morbidities, anesthesiologic and surgical risks

Table 1. Differential diagnosis of transient visual loss.

ETIOLOGY	TYPICAL DURATION	PATTERN OF VISUAL LOSS	ASSOCIATED SIGNS AND SYMPTOMS	MECHANISM
Monocular ischemia, carotid disease, other embolic source	1-10 minutes	Monocular, rapid onset, altitudinal onset	Hollenhorst plaque, hemispheric symptoms	Retinal embolism (usually)
Giant Cell arteritis	Variable	Usually monocular	Headache, neck pain, jaw claudication	Optic nerve ischemia
Papilledema	Seconds	Monocular blurring	Headache, diplopia	Elevated intracranial pressure
Idiopathic retinal vasospasm	5-60 minutes	Monocular positive or negative symptoms	Transient retinal arterial narrowing, headache	Vasospasm
Migraine	10-30 minutes	Usually binocular, positive symptoms with spread	Usually followed by migraine headache	Spreading cortical depression, possibly retinal vasospasm
Vertebrobasilar ischemia	1-10 minutes	Homonymous hemianopsia	Isolated or accompanied by other brainstem deficits	Embolic
Seizure: Ictal	3-5 minutes	Binocular, lateralized, positive phenomenon common	Altered consciousness, motor symptoms	Epileptic discharge
Post-ictal	20 minutes or more	Binocular visual field loss	Preceding ictus	Cortical inhibition

P-0159

Use and adverse effects in oral anticoagulation:: Dicoumarol / NOACS

Pilar Aznar¹, José Ignacio Torrente¹, Roberto Gonzalez¹, Belen Gay¹, Silvia Castan², Silvia Torrente¹

¹Primary Health Center

²Public Health Technic

Atrial fibrillation (AF) is the most frequent arrhythmia in primary care, and it is associated with an increase in morbimortality due to the risk of embolism.

Our objectives were:

1. To learn about the type of anticoagulant used by our patients: Dicoumarol / NOACS (New oral anticoagulants), the causes for use, and the possible adverse effects.

2. To assess the level of INR (International normalized ratio) control of patients treated with dicoumarols.

We made a transversal, multicentre study on the use of anticoagulants in primary care.

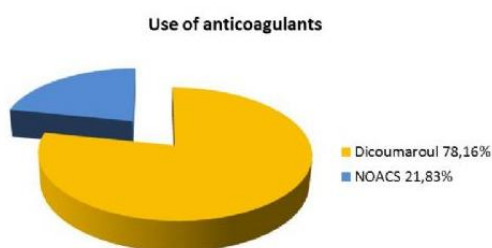
In our study, we found an increase in the use of NOACS compared to our study made last year.

The level of INR control was deficient.

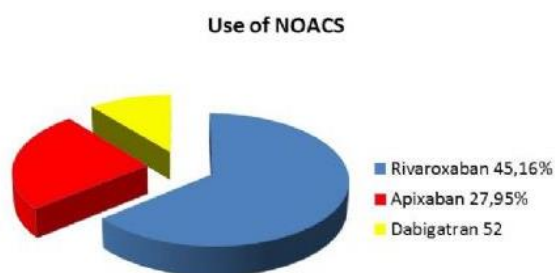
The increase in the number and duration of NOACS administrated was accompanied by the presence of some complications

Keywords: Atrial fibrillation, Dicoumarol, NOACS, Adverse effects

Use of anticoagulants



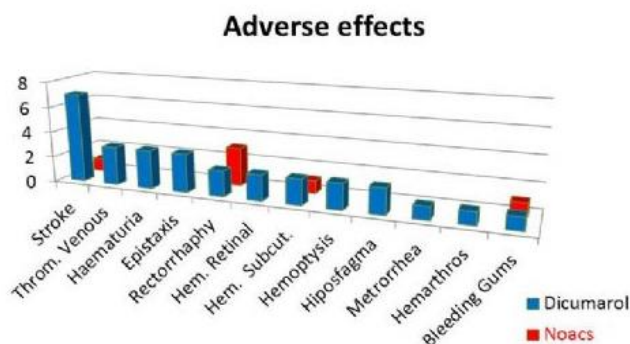
NOACS



INR CONTROL



Adverse effects



1-Dicoumarol: Complications appeared in 29 patients (27.88%): 7 strokes, 3 haematurias, 3 serious epistaxis, 2 rectal hemorrhages, 2 retinal hemorrhages, 2 subcutaneous haematomas, 2 hemoptysis, 2 venous thrombosis, 2 subconjunctival hemorrhages, 1 metrorrhea, 1 hemarthrosis and 1 bleeding gums. 2-NOACS: Complications appeared in 6 patients (6.45%): 3 rectal hemorrhages, 1 stroke, 1 subcutaneous haematoma and 1 bleeding gums.

P-0160

A COPD Case Due to Passive Smoking

Ayşe Gökçen Sayılır¹, Tuncer Kılıç², Yusuf Üstü², Ahmet Keskin², Furkan Dağcıoğlu², Mehmet Uğurlu²

¹Department of Family Medicine, Ankara Atatürk Training and Research Hospital, Ankara, Turkey

²Department of Family Medicine, Yıldırım Beyazıt University, Ankara, Turkey

A 71-year-old Turkish female patient, a passive smoker from Turkey, admitted to our outpatient clinic for progressive shortness of breath and cough. She reported that her breathlessness and coughing episodes had become particularly severe in the preceding week. She has excessive daytime sleepiness and apnea. She stated that her husband died due to chronic obstructive pulmonary disease and she has 40 pack-years passive smoking history.

Her medical history revealed type 2 diabetes mellitus, systemic hypertension, arrhythmia, coronary artery disease, cerebrovascular disease. She had a history of farming. She hasn't stated any recent travel history. She has no family history of asthma or allergy.

On examination, she was in moderate respiratory distress and had decreased breath sounds and apparent cyanotic skin, +2 lower extremity edema.

Respiratory rate: 30

Heart rate: 88

Sao₂: 85

Hct: 53%

Hb: 17.3

P-0161

Is Anorexia Nervosa or Celiac? A Case Report

Orkide Kutlu¹, Selma Pekgor², Samil Ecirli¹, Özlem Çakır¹, Yasemin Alagöz², Humeyra Yaka², Sule Erayman Demirbas¹, Abdulkadir Basturk¹

¹Department of Internal Medicine, Konya Training and Research Hospital

²Department of Family Medicine, Konya Training and Research Hospital

INTRODUCTION: Celiac disease is an autoimmune disease of the small intestine triggered by gluten containing food in patients with genetic predisposition. The immune response in the small bowel mucosa is characterized by inflammation, villous atrophy and crypt hyperplasia. The prevalence in the community is very high (1/100-300). It is usually diagnosed at 6 months to 2 years of age in children and 40-50 years of age in adults. The classic symptoms are chronic recurrent diarrhea, abdominal distension and weight loss. In adults, the most common finding is iron deficiency anemia. It may mimic irritable bowel syndrome. Herein, we report a patient diagnosed celiac disease while investigating with suspicion of anorexia nervosa.

CASE: A 26 year old female patient was admitted to the internal medicine department with complaints of decreased weight gain, nausea and vomiting after meals in the last 6 months. The patient was around 28 kg for many years. 3 months ago, psychiatric experts has began citalopram treatment and offer her admission to the hospital because of suspicion of anorexia nervosa. On physical examination, there was cachexia and cardiac 2/6 systolic murmur. Height 155cm and weight 23.5 kg. BMI was 9.9 kg/ m². In laboratory findings, glucose 66 mg/dL, total protein 4.3 g/dl (6.6-8.3), albumin 2.3 g/dl (3.5-5.2), proteinuria in 24-hour urine sample 2760 mg/dl. gastroesophageoduedonoskopi revealed grade B esophagitis, slow gastric motility movements and severely swollen/deformed duodenum (compatible with gluten enteropathy). The biopsies showed duodenitis. Antigliadin IgA (+), anti-endomysium IgA (++). ANA, ANCA were negative. C3,C4 were normal. The patient was treated with gluten-free diet.

CONCLUSION: It is not difficult to diagnose celiac disease, but diagnosis can be skipped when not suspected. In patients with anorexia nervosa, exclusion of organic pathology is extremely important. So mistakenly considered treatment resistant patients may be avoided.

Keywords: Celiac disease, anorexia nervosa, cachexia

P-0162

Bisphosphonates-related adverse events: a survey of Lebanese physicians' knowledge, attitude and experience

Lana El Osta¹, Badi El Osta², Nazek Saadallah¹, Reine Tannous¹, Sara Lakiss¹, Maria El Gemayel¹, Nada El Osta³

¹Department of Public Health, School of Medicine, Saint-Joseph University, Beirut, Lebanon

²Georgia Regents University Cancer Center, Augusta, GA, USA

³Department of Prosthetic Dentistry, School of Dentistry, Saint-Joseph University, Beirut, Lebanon

BACKGROUND AND AIM: Bisphosphonates are widely used in the prevention and treatment of osteoporosis. They are also recommended to prevent skeletal complications and relieve bone pain induced by malignancies. However, these benefits are associated with multiple undesirable events, some of which may be serious and not previously recognized.

This study aims to assess the knowledge and attitude of Lebanese physicians regarding bisphosphonates-related complications.

METHODS: An observational cross-sectional survey was conducted at a major tertiary teaching hospital in Beirut city. Data were collected through an anonymous structured self-administered questionnaire distributed to physicians expected to regularly prescribe bisphosphonates (n=215). The questionnaire assessed participants' knowledge, fear and experience regarding bisphosphonates-reported side effects.

RESULTS: A total of 157 physicians completed the questionnaire (response rate: 73%): 77.7% and 75.2% considered that gastrointestinal intolerance and osteonecrosis of the jaw (ONJ) are linked to bisphosphonates, respectively. Conversely, the least recognised complications are ocular inflammation (7.6%) and severe musculoskeletal pain (37.6%). The association of bisphosphonates with oesophageal cancer, atrial fibrillation and hepatotoxicity was wrongly reported by 11.5%, 13.4% and 24.8% of respondents, respectively. The multivariate

analysis showed a significant association between the level of knowledge and physicians' specialty (-p-value=0.043), their gender (-p-value=0.044), whether or not they prescribe a bisphosphonate (-p-value=0.012), and the number of bisphosphonate prescriptions delivered per month (-p-value=0.012).

Physicians are mainly concerned about ONJ, atypical fractures and nephrotoxicity when prescribing a bisphosphonate. However, the complications frequently encountered in their practice are gastrointestinal intolerance (44.6%) and flu-like symptoms (26.7%).

CONCLUSIONS: Practitioners' awareness of bisphosphonates-related side effects can potentially lead to prevent the occurrence of more serious complications due to an earlier detection and management. Our study revealed that the adverse effect profile of these drugs is not well known by our physicians. Appropriate training strategies to increase their knowledge are needed.

Keywords: Bisphosphonates, Drug complications, Knowledge, Osteoporosis, Malignant bone diseases

Table 1: Physicians' knowledge, fear and experience regarding bisphosphonates-reported side effects

Side effects	Reported by physicians N (%)	Feared by physicians N (%)	Encountered by physicians N (%)
Acute phase reaction	86 (54.8)	12 (7.6)	42 (26.8)
Atrial fibrillation	21 (13.4)	12 (7.6)	0 (0.0)
Atypical femoral fractures	67 (42.7)	48 (30.6)	13 (8.3)
Esophageal cancer	18 (11.5)	11 (7.0)	0 (0.0)
Hepatotoxicity	39 (24.8)	18 (11.5)	2 (1.3)
Hypocalcaemia	72 (45.9)	33 (21.0)	27 (17.2)
Ocular inflammation	12 (7.6)	3 (1.9)	2 (1.3)
Osteonecrosis of the jaw	118 (75.2)	93 (59.2)	38 (24.2)
Renal toxicity	84 (53.5)	67 (42.7)	33 (21.0)
Severe musculoskeletal pain	59 (37.6)	10 (6.4)	24 (15.3)
Upper GI* intolerance	122 (77.7)	45 (28.7)	70 (44.6)
No side effect	2 (1.3)	7 (4.5)	32 (20.4)

GI: Gastrointestinal

Table 2: Univariate analyses of factors associated with the level of knowledge

Independent variables	Knowledge score Mean ± standard deviation	N	-p-value
1. Professional position	8.82 ± 2.83	17	0.232
• Professor	8.65 ± 2.57	54	
• Attending physician	7.93 ± 2.90	86	
2. Department affiliation	8.92 ± 2.553	114	< 0.0001*
• Medical	6.56 ± 2.693	43	
• Surgical			
3. Department affiliation	10.62 ± 2.83	8	< 0.0001*
• Rheumatology	10.10 ± 1.77	20	
• Oncology	9.70 ± 2.63	10	
• Nephrology	9.45 ± 2.51	11	
• Endocrinology	8.21 ± 2.48	29	
• Internal Medicine	8.08 ± 2.52	36	
• Family Medicine	7.38 ± 3.09	21	
	5.77 ± 2.02	22	

• Orthopedics				
• Gynecology				
4. Age				
• < 30 years	7.91 ± 2.87	80		
• 30-50 years	8.53 ± 2.77	55	0.213	
• > 50 years	8.95 ± 2.46	22		
5. Gender				
• Male	7.84 ± 2.63	95		
• Female	8.94 ± 2.91	62	0.016*	
6. Number of patients attended per day				
• < 10 patients	8.29 ± 2.84	52		
• 10-20 patients	8.32 ± 2.89	65	0.874	
• > 20 patients	8.03 ± 2.42	34		
7. Number of medical sales representatives received per week				
• 0	7.55 ± 2.60	20		
• < 10	7.98 ± 2.76	86		
• 10-20	8.91 ± 2.62	34	0.149	
• > 20	9.07 ± 2.99	14		
8. Time consumed for patients care				
• < 25%	8.25 ± 2.06	4		
• 25-50%	8.00 ± 2.77	37		
• 51-75%	8.43 ± 2.88	68	0.906	
• > 75%	8.25 ± 2.75	44		
9. Time consumed for academic work				
• < 25%	8.23 ± 2.78	57		
• 25-50%	8.42 ± 2.80	76		
• 51-75%	7.25 ± 2.54	16	0.171	
• > 75%	10.50 ± 1.91	4		
10. BP [†] prescription				
• Yes	8.78 ± 2.69	108		
• No	7.16 ± 2.70	49	0.001*	
11. Number of BP prescriptions delivered per month				
• ≤ 5 prescriptions	8.27 ± 2.64	73		
• 6 - 10 prescriptions	9.70 ± 2.46	27	0.006*	
• > 10 prescriptions	10.86 ± 2.48	7		
12. Most frequent form of BP prescribed				
• Oral form	8.48 ± 2.73	87		
• Intravenous form	9.90 ± 2.22	20	0.033*	
13. Number of patients on BP attended per month				
• 0 patient	6.64 ± 2.06	11		
• 1 - 5 patients	7.85 ± 2.52	81		
• 6 - 10 patients	8.26 ± 2.81	34	< 0.0001*	
• > 10 patients	9.97 ± 2.99	31		

*-p-value < 0.05 (level of significance) † BP: Bisphosphonate

Table 3: Multiple regression analysis of factors associated with the level of knowledge

Unstandardized coefficients	Standard error	Standardized coefficients	Student	-p-value	Partial correlations
β		β			

- Department affiliation	1.253	0.610	0.201	2.054	0.043*	0.204
- Gender	1.103	0.539	0.194	2.045	0.044*	0.203
- Number of medical sales representatives received per week	0.167	0.330	0.048	0.506	0.614	0.051
- Time consumed for academic work	0.144	0.331	0.038	0.434	0.665	0.044
- BP [†] prescription	-1.455	0.566	-0.242	-2.569	0.012*	-0.252
- Number of BP prescriptions delivered per month	1.106	0.431	0.241	2.567	0.012*	0.252
- Most frequent form of BP prescribed	0.870	0.671	0.122	1.296	0.198	0.130

*-p-value < 0.05 (level of significance) † BP: Bisphosphonate

P-0163

Tophaceous chronic gout: A Case Report

Orkide Kutlu¹, Samil Ecirli¹, Vedat Gencer², Abdullah Sakin³, Şule Erayman Demirbas⁴, Humeyra Yaka⁴, Abdulkadir Basturk¹, Ahmet Yıldırım¹

¹Department of Internal Medicine, Konya Training and Research Hospital

²Department of Nephrology, Konya Training and Research Hospital

³Department of Oncology, Okmeydanı Training and Research Hospital

⁴Department of Family Medicine, Konya Training and Research Hospital

INTRODUCTION: Gout is more common in men at middle ages, and its incidence has reached 3%. After recurrent arthritis, chronic arthritis and tophaceous gout may develop. Allopurinol and uric acid lowering therapy has provided significant reduction in tophaceous gout. Herein, we report a patient with dense tophus deposits on the hands, olecranon bursa and first metatarsophalangeal joints as it is rarely encountered today.

CASE: A 71-year-old male was admitted to our outpatient clinic with complaints of masses on his extremities. He had been diagnosed gout 30 years ago. He has been taking colchicine 1.5 mg/day and allopurinol 150mg/day for last 1 year. There were significant tophus deposits on his hands, olecranon and first metatarsophalangeal joints (Figure). In laboratory findings

; Uric acid 3.8 mg/dL (2.6-6), sedimentation 26 mm/h (0-25), CRP 28.6 mg/l (0-5). CBC, urea, creatinine, albumin, ALT, CK levels were normal.

DISCUSSION: In patients with asymptomatic hyperuricemia without arthritis, renal stone or tophus formation, there is no need to start the long-term, expensive, and potentially toxic treatments. Colchicine, NSAIDs or corticosteroids provide dramatic improvements in the acute attacks. In periods between the acute attacks, the poor purine diet (meat products, alcohol, fructose corn syrup) getting plenty of fluids, to avoid treatments reducing uric acid excretion (thiazide/loop diuretics, low-dose aspirin, niacin, cyclosporine) and using colchicine is important to prevent new attacks. Uric acid lowering treatments (allopurinol, febuxostat) can be used in patients with 2/more acute arthritis attacks in a year, grade 2/above CRF or tophus deposits to decrease serum uric acid levels <6 mg/dL. Uricosuric agents (probenecid, urine, alkylating agents) or uricase (pegloticas A) also can be used. Allopurinol may cause life-threatening form of hypersensitivity (hepatitis, toxic epidermal necrolysis, vasculitis) in 2% of patients. Excision of the tophus may be performed in selected patients.

Keywords: Gout, Colchicine, Tophus

Tophaceous chronic gout



P-0164

The association between hematologic parameters and disease activity in patients with ankylosing spondylitis

Ayşe Nur Topuz¹, Ipek Türk², Nafiz Bozdemir¹, Mustafa Topuz³

¹Department of Family Medicine, Çukurova University, Adana, Turkey

²Department of Rheumatology, Çukurova University, Adana, Turkey

³Department of Cardiology, Adana Numune Hastanesi, Adana, Turkey

AIM: Ankylosing spondylitis (AS) is a type of chronic inflammatory arthritis resulting in ankylosis of the spine and inflammation in the tendons. In this study, we aimed to investigate the usability of hematologic parameters to determine disease activity in patients with AS.

MATERIALS-METHODS: The study enrolled 65 patients diagnosed with AS. Patients were divided into two groups according to their Bath Ankylosing Spondylitis Disease Activity Index (BASDAI) scores. Thirty one (% 47) patients had BASDAI score ≥ 5 served as Group 1 and 34 (%53) patients had BASDAI score <5 served as Group 2. Patients' medications, demographic and laboratory findings were also recorded.

RESULTS: The demographic and clinical features of both groups were comparable. There was no significant differences between groups in terms of use of medications, duration of AS and presence of uveitis, enthesopathy and peripheral arthritis. The Erythrocyte Sedimentation Rate (ESR), C-reactive Protein (CRP) and Neutrophil/Lymphocyte Ratio (NLR) were significantly higher in patients of Group 1 compared to those in Group 2 (43.04 ± 31.4 vs 23.20 ± 17.20 $p=0.002$, 7.20 ± 1.74 vs 5.39 ± 1.43 $p=0.003$ and 3.14 ± 1.21 vs 2.33 ± 0.94 $p=0.004$, respectively) whereas the, Mean Platelet Volume (MPV) was significantly lower in Group 1 patients than in Group 2 patient (7.67 ± 1.62 vs 8.72 ± 2.30 $p=0.016$). BASDAI score was significantly negatively correlated with MPV ($r= -0.309$, $p=0.012$) and significantly positively correlated with ESR, CRP and NLR values ($r=0.427$, $p<0.001$, $r=0.328$, $p=0.008$ and $r=0.316$, $p=0.010$, respectively). These variables were entered into uni-and multivariate regression analysis and MPV was found a significant risk factor for predict the disease activity (OR 2.03 $p=0.012$).

CONCLUSION: As inflammation marker, MPV can predict disease activity in AS and could be used in primary care as an easy and inexpensive method.

Keywords: Ankylosing spondylitis, BASDAI score, Mean Platelet Volume.

P-0165

GP Eye Health Network

Waqaar Shah¹, Annette Dinnall²

¹Royal College of General Practitioners

²UK Vision Strategy

Introduction

The Royal College of General Practitioners (RCGP) have selected eye health, with a focus on ageing and sight loss, as a clinical priority.

Dr Waqaar Shah, RCGP Clinical Champion for Eye Health, is working with the RCGP Clinical Innovation and Research Centre and UK Vision Strategy to provide clinical leadership for this programme of work.

Method: The aim of a GP Network is to bring together GPs and practice staff from across the UK to raise the profile of eye health within general practice and improve the quality of care for patients with sight loss by enabling them to:

- Access and share relevant research and examples of good practice
- Share innovative ways of managing patients with sight loss
- Develop care pathways with local eyecare providers including ophthalmologists and optometrists
- Collaborate with other practitioners in the health, social care and voluntary sectors at UK, national and regional levels.

Results

- The programme has established a UK wide GP Eye Health Network. It is the first network of its kind and currently has over 480 members from across the UK.
- A dedicated web page and resources have been set up for members on the UK Vision Strategy website
- A series of clinical factsheets have been developed for members by Dr Gilli Vafidis (an Ophthalmologist) and peer reviewed by a member of the Royal College of Ophthalmologists Professional Standards council, experts at the College of Optometrists, the Optical Confederation and British and Irish Orthoptic Society.

Conclusion: Early feedback on the usefulness of this network is very encouraging. Our aim is to increase membership and promote local champions in eye health, which would ultimately improve patient care.

- To join the free GP Network or for more information, <http://www.ukvisionstrategy.org.uk/GPnetwork>
- UK Vision Strategy website, <http://www.ukvisionstrategy.org.uk/clinicalpriority>
- Clinical Priority Programme: <http://www.ukvisionstrategy.org.uk/clinicalpriority>
- To contact Dr Waqaar Shah: email ukvisionstrategy@rnib.org.uk

Keywords: GP Eye Health Network, sight loss, eye health, clinical priority, general practice, patient care

P-0166

Asthma would require a more individualized follow-up?

M Teresa Magdalena Carreres, Juan Carlos Montalvá Barra, Pilar Herrera Rodriguez, Rosa Albelda Vendrell
CENTRO SALUD CARCAIXENT - H DE LA RIBERA

Asthma is a chronic disease that causes inflammation and narrowing of recurrent pathology whose cause is variable and risk factors are a combination of genetic predisposition with environmental exposure to inhaled substances and particles (dust mites, pollens, molds, smoke snuff...)

According to the OMS estimates that there are currently 235 million asthma patients and is present in all countries.. Often asthma is not correctly diagnosed and properly treated, creating a substantial burden for patients and their families, and may limit the patient's activity throughout their lives.

A prospective study is proposed in health center with monitoring and smoking cessation in 25 asthmatic smokers (Richmond with medium-high motivation and test unit-high moderate Fragerström) of our consultations and assess whether individually controlled abandonment of snuff is achieved and a decrease in asthma attacks.

RESULTS

Of the 25 patients, 68% (17) they were male, with a mean age of 47.52 years and a follow-up at nurse and regular

physician while smoking cessation is achieved.

Three months, 50% of men achieved an improvement in dependency while women 30% reduction was achieved in 100% dependent (8 women).

The emergency number was 8 patients (3.2%) and symptom control 90% reduction was achieved with 2 drugs in 90% (salbutamol and ipratropium bromide)

CONCLUSIONS

The individual adjustment and better monitoring of our patients can achieve improvement of symptoms and a cost-effectiveness much higher compared to patients not controlled in our consultations primary.

Keywords: asthma, snuff, individualized

treatment

Men	Women
68%	32%
30% reduction	100% reduction

P-0167

Use of liraglutide to improve metabolic control in patients with diabetes type 2 treated with insulin

Estefania Perez Nicolas¹, Laura Montesinos Ramón², David Khazzoum Collado³, Patricia De Lobaig Ramos⁴, Alejandro Salanova Penalba⁵

¹Centro de Salud de Fuente de San Luis, Hospital Doctor Peset, Valencia, Spain; nowadays in Centro de Salud de Cullera, Hospital Alzira

²Centro de Salud de Burjasot, Hospital Arnau de Vilanova, Valencia, Spain

³Centro de Salud de Fuente de San Luis, Hospital Doctor Peset, Valencia, Spain; nowadays in Centro de Salud de Algemesi, Hospital de Alzira

⁴Centro de Salud de Fuente de San Luis, Hospital Doctor Peset, Valencia, Spain; nowadays in Urgencias Hospital Doctor Peset

⁵Centro de Salud de Fuente de San Luis, Hospital Doctor Peset, Valencia, Spain

Diabetes Mellitus type 2 is a chronic and underdiagnosed disease in our country, with a high impact in the health system which treatment should be directed to the control of the comorbidities. GLP-1 receptor agonists is a group of drugs that induces loss of weight, improve blood pressure and dyslipemia in these patients by the incretin effect.

We present a case and a review of the literature on the role of liraglutide in the control of cardiovascular risk. It is a man, 69 years old, diagnosed of Diabetes Mellitus type 2 in 2003 treated with metformin. In 2008, due to a poor metabolic control, he was admitted, adding to the treatment insulin glargina and rapid insulin. During the remaining years, he continued with poor metabolic control so, in 2012, we decided to remove the rapid insulin and add liraglutide. Patient was followed throughout their cardiovascular risk. Currently, we can see a better blood pressure, cholesterol-LDL lowering and a loss of 6.3% of his initial BMI. The most important thing is that, before of the treatment, he has got HbA1c of 8.2 %, decreasing at 12 weeks of HbA1c to 7.7 % and 7.1 % in a year. Liraglutide Effect and Action in Diabetes (LEAD) program has demonstrated that liraglutide is effective and well tolerated in various stages of Diabetes type 2, as monotherapy or in combination with one or two oral agents. A recent meta-analyzes has evaluated the various randomized clinical trials comparing treatment with GLP-1 analogues associated with insulin, concluding that improved glycemic control, particularly postprandial with the combination is achieved, allowing a lower dose of insulin.

Finally, treatment with liraglutide has a lower rate of hypoglycemia than other treatments, being somewhat higher if it is associated with sulfonylureas, a fact not observed by associating with metformin or insulin.

Keywords: liraglutide, Diabetes, Cardiovascular Risk.

Table 9 Weight and SBP outcomes from phase 3 liraglutide clinical trials (17-21)

Change from baseline data	Liraglutide, 3.0 mg	Liraglutide, 1.8 mg	Comparator	Results
GLAD-1: Liraglutide vs. placebo in monotherapy				
Weight (kg)	-2.1*	-1.4*	1.7	NA
SBP (mmHg)	-3.1	-3.3*	-0.7	NA
GLAD-2: Liraglutide vs. placebo in metformin-treated patients				
Weight (kg)	-2.8*	-1.9*	1.8	-1.3
SBP (mmHg)	-2.7*	-1.7*	NA	-1.8
GLAD-3: Liraglutide vs. rosiglitazone in sulfonylurea-treated patients				
Weight change (kg)	0.2*	-0.2*	2.1	-0.1
SBP (mmHg)	-2.8	-2.9	-0.9	-2.3
GLAD-4: Liraglutide + rosiglitazone and metformin vs. rosiglitazone + metformin				
Weight (kg)	-1.9†	-1.0	NA	-0.0
SBP (mmHg)	-4.7†	-5.8†	NA	-1.1
GLAD-5: Liraglutide vs. insulin glargine in metformin- and glimepiride-treated patients				
Weight (kg)	NA	-1.2*	1.6	-0.4
SBP (mmHg)	NA	-4.2*	5.5	-1.8
GLAD-6: Liraglutide vs. insulin in metformin- and/or sulphonylurea-treated patients				
Weight (kg)	NA	-1.1	-1.9	NA
SBP (mmHg)	NA	-1.5	-1.0	NA
Resglutide vs. sitagliptin in metformin-treated patients				
Weight (kg)	-2.8*	-1.4*	-1.0	NA
SBP (mmHg)	-4.4	-6.1	-2.8	NA

Liraglutide and active comparator placebo included in GLAD-1, -4 and -5. Liraglutide placebo included in GLAD-6 (vs active comparator group). Liraglutide placebo included in GLAD-5. GLAD-6 was open label. NA, not applicable. *Liraglutide significantly different to comparator. †Liraglutide significantly different to placebo.

results of LEAD program

P-0168

The Effect of Group Visits on Body Weight, Well-being, and Health Locus of Control in Overweight and Obese Women

Merthan Tunay¹, Hatice Kurdak¹, Sevgi Özcan¹, Çiğdem Özdemir², Funda Coşkun³, Özgür Günaşır²

¹Department of Family Medicine, University of Cukurova, Adana, Turkey.

²Department of Physiology, Division of Sports Physiology, University of Cukurova, Adana, Turkey

³School of Physical Education And Sports, University of Cukurova, Adana, Turkey

AIM: The aim of this study is to investigate the effect of group visits on weight loss, well-being, and health locus of control in overweight and obese women.

METHODS: Sixty volunteers meeting the inclusion criteria were enrolled in the study. Multidimensional Health Locus of Control and Short Form-36 scales were completed for each participant. Blood variables, resting metabolic rate, exercise stress test and arteriography measurements were performed. Diet and exercise programs were organized. The scales, blood analysis, exercise stress test and resting metabolism measurements were repeated for 30 participants who have completed the eight group visits in six months.

RESULTS: Participants mean body weights measured in the beginning of the study were significantly decreased 8,2% in the end (84.7±13.8 kg, 77.8±14.1 kg, p <0.001, respectively). Significant decreases were found in mean body mass index, waist-hip circumference and waist-height ratio (p<0.001 for each). While significant increase was found in HDL cholesterol values, WBC, TSH, ft4, Hgb, Plt, AST, ALT, heart rate and systolic-diastolic blood pressures were significantly decreased. In the end of the study, significant improvement was observed in physical functioning, bodily pain, general health, vitality, emotional role and mental health subscales (p=0.011, p=0.003, p=0.004, p=0.04, p=0.014, p=0.024, respectively). Significant improvements were found both in physical (p=0.002) and mental component (p=0.038) summary scales. Participants' Health Locus of Control scores did not changed significantly. The time spent on a patient during the group visits was found to be 2,5 to 2,8 times shorter than that of individual interviews.

CONCLUSION: Our results showed that significant weight loss and quality of life improvement may be achieved with group visits in overweight and obese women. Our results may motivate physicians to use group visits for their overweight and obese patients.

Keywords: Obesity, group visits, SF-36, well-being, quality of life, locus of control

Table 1. Change in BMI, waist, hip, WHR and WHtR at the beginning and end of group visits

	Beginning of study	End of study	p
	Mean±SD	Mean±SD	
Weight(kg)	84,7 ± 13,8	77,8 ± 14,1	0,001
BMI (kg/m ²)*	31,6 ± 4,2	29,0 ± 4,4	0,001
Waist(cm)	99,8 ± 9,1	93,7 ± 10,0	0,001
Hip (cm)	114,5 ± 9,6	108,15 ± 10,19	0,001
WHR	0,87 ± 0,07	0,86 ± 0,06	0,221
WHtR	0,61 ± 0,1	0,57 ± 0,1	0,001

*Wilcoxon sign test

Table 2. Comparison of Sf-36 life quality scales at the beginning and end of study

sf-36	Patients completed group visits (n=30)		Patients discontinued group visits (n=29)		
	First measurement	Last measurement		p [#]	p [*]
	Mean±SD	Mean±SD	Mean±SD		
Physical functioning	79,0 ± 17,6	87,5 ± 9,1	74,5 ± 18,5	0,011	0,188
Physical role functioning	69,2 ± 33,9	79,2 ± 31,5	57,8 ± 39,6	0,194	0,358
Bodily pain	61,3 ± 27,8	77,3 ± 18,6	53,4 ± 28,0	0,005	0,337
General health perceptions	55,8 ± 23,3	68,2 ± 17,0	58,9 ± 21,3	0,006	0,750
Vitality	53,2 ± 25,6	62,0 ± 21,4	51,7 ± 19,1	0,048	0,796
Social role functioning	70,4 ± 21,4	78,3 ± 21,8	70,7 ± 26,8	0,051	0,660
Emotional role functioning	51,1 ± 25,9	63,3 ± 22,1	54,0 ± 31,4	0,023	0,554
Mental health	63,7 ± 21,8	71,9 ± 18,4	60,3 ± 17,7	0,041	0,326
Physical component	46,8 ± 8,5	51,5 ± 4,7	44,4 ± 8,6	0,002	0,197
Mental component	42,3 ± 10,1	46,0 ± 9,7	42,8 ± 9,3	0,044	0,885

Patients completed and discontinued group visits. Mann- Whitney U test @ First and last measurements of patients completed the group visits. Wilcoxon sign test

Table 3. MHLC values of participants at the beginning and end of study

MHLC	Patients completed group visits(n=30)		Patients discontinued group visits (n=29)		
	First measurement	Last measurement		p [#]	p [*]
	Mean±SD	Mean±SD	Mean±SD		
External	29,4 ± 4,5	28,6 ± 3,5	30,5 ± 3,8	0,411	0,684
Internal	21,4 ± 6,2	21,5 ± 5,1	21,8 ± 5,6	0,829	0,684
Chance	15,2 ± 5,3	14,5 ± 4,6	17,5 ± 6,3	0,424	0,190
Total	65,8 ± 12,1	64,7 ± 10,0	69,9 ± 10,3	0,465	0,183

Patients completed and discontinued group visits. Mann- Whitney U test @ First and last measurements of patients completed the group visits. Wilcoxon sign test

P-0169

Impact of body size on risk factors and target organ damage

Ioannis A Kyriazis¹, Manolis S Kalistratos², Athanasios J Manolis²

¹1st Internal Medicine Department - Voula General Hospital, Athens, Greece

²Cardiology Department - Voula General Hospital, Athens, Greece

INTRODUCTION: Although increased body size represents an established risk factor for cardiovascular disease development, there is an ongoing research as to whether or not there is a threshold above of which the association of obesity and cardiovascular risk becomes less evident. This type of concern which is graphically represented by a J-type curve is also extended at the lower values of body size measures.

OBJECTIVE: To differentiate the sub-clinical impact of adiposity on risk factors, target organ damage, including cardiac adaptations, especially beyond hypertension.

METHODS: In this observational study with a cross-sectional design, 231 patients referred or self-referred to our outpatient institution were prospectively enrolled. In all patients, medical history and physical examination as well as routine biochemical exams, clinic and 24-h blood pressure (BP) evaluation and finally echocardiography was performed.

RESULTS: Patients enrolled were mainly females (51%) aged $49,81 \pm 10$ years. 34,8% of the patients were obese while 38% overweight. Body mass index (BMI) was highly related to office and 24-hours blood pressure levels, lipidemic and glucose profile, but not with central BP levels, pulse wave velocity (PWV) and renal function. More precisely, overweight, obese but also underweight patients had increased mean 24 hours systolic and diastolic BP levels in comparison to normal weight patients (127/76 mmHg, 126/75 mmHg, 129/74 mmHg vs 118/71 mmHg ($p < 0.001$), higher morning and evening 24 hours mean BP levels ($p < 0.001$), higher office diastolic BP levels ($p < 0.001$) without any significant difference in office systolic BP levels, central BP and PWV levels ($p = ns$). As expected, glucose as well as lipidemic profile was highly related to BMI since the higher the BMI the higher the levels of glucose, LDL and triglycerides ($p < 0.001$).

CONCLUSIONS: Obese overweight and underweight patients presents increased cardiovascular risk factors and seems that a J type curve is present as expected.

Keywords: Obesity, J curve, Cardiovascular risk factors, Hypertension

P-0170

The effect of nutritional behavior change and regularly exercise in body weight of obese patients

Ioannis A Kyriazis¹, Kostantinos Sgouros², Dimitra Stefani², Sofia Tsaousi², Athanasios Kordalis¹

¹Obesity Outpatient Clinic - Voula General Hospital, Athens, Greece

²Internal Medicine Department - KAT General Hospital, Athens Greece

INTRODUCTION: The primary role in weight loss plays a change in eating behavior and increasing physical activity.

OBJECTIVE: To examine and record the result of the effect of the change in eating behavior and exercise in obese patients.

MATERIAL-METHODS: We followed for 1 year 164 patients [Men: 46 Women: 118, mean age 56.2 years old, from our Hospital

Outpatient Obesity clinic. All were given hypo caloric diet (minus 700 cal / day) and exercise program (1/2 hour brisk walking a day).

RESULTS: Our intervention resulted in significant weight loss and less abdominal obesity (Table 1).

CONCLUSIONS: The problem of obesity is dramatically increasing and so becomes more imperative to change dietary behaviors and increase physical activity in general population.

Keywords: Obesity, Weight loss, Eating behavior, Exercise

Table 1

Initial BMI	36,9 (8,7)
Men/Women	44,7(11,6)/35(6,8)
BMI at 12 months	33,5(7,4)
Men/Women	39,6(9,1)/32 (6,3)
p value	<0,0001
Initial Waist (cm)	112,1(19,5)
Men/Women	133,8(27)/106,7(13,1)
Waist(cm) at 12 months	106,4(17,4)
Men/Women	124,2(24,8)/101,9(12,3)
p value	<0,001

The results are given as mean and standard deviation: mean (SD)

P-0171

Treatment of Reynaud's Phenomenon with VATS: A Case Report

Orkide Kutlu¹, Yasemin Alagöz², Samil Ecirli¹, Atilla Can³, Fatma Selek Demirel², Hayriye Senturk², Humeyra Yaka², Sule Erayman Demirbaş², Abdulkadir Basturk¹

¹Department of Internal Medicine, Konya Training and Research Hospital

²Department of Family Medicine, Konya Training and Research Hospital

³Department of Chest Surgery, Konya Training and Research Hospital

INTRODUCTION: Raynaud's phenomenon (RP) is a three-phase (paleness/cyanosis/erythema) reaction often at the hand fingers, the ears and the nose tip which can be occur spontaneously or triggered by cold, physical and emotional stresses. If it is not associated with underlying vascular or connective tissue disease, it is defined as primary Raynaud's syndrome. RP is seen 3-4% in the general population often in women. Pathophysiologically, changes in number or effect of postsynaptic and presynaptic alpha and beta adrenergic receptors; up-regulation of the sympathetic nervous system; changes in the release of vasoactive substances such as prostaglandins, calcitonin-gene linked peptide, nitric oxide, endothelin and serotonin; changes in blood viscosity; abnormal serum proteins and hypomagnesemia can be responsible for RP. Primary Raynaud's syndrome variant may be associated with angina attacks and migraine-like symptoms. The prognosis is usually benign but digital gangrene or tissue loss is rarely encountered. Here we report a case of serious RP who treated with video-assisted thoracoscopic surgery (VATS).

CASE: A 20 year old male patient was admitted to hospital with complaints of considerable pain, brusing, swelling and parestesia of the hands continuing for last 2 months. He was a soldier. On physical examination, the fingers were swollen and cyanotic. System examination and laboratory tests were normal. He has not any rheumatic disease. He was a smoker. Sympathectomy was performed with VATS method. In control examination prominent decline was observed in his complaints.

CONCLUSION: Conservative preventive methods, medical and surgical treatment options are available for the treatment of Raynaud's phenomenon. Video assisted thoracoscopic surgery (VATS) sympathectomy is another alternative surgical method. In the treatment of Raynaud's disease, VATS sympatectomy may provide fast, safe, economical and effective treatment option. Keywords: Raynaud's phenomenon, VATS, Sympathectomy.

Reynaud's Phenomenon



P-0172

Closing the prevalence gap: identifying chronic obstructive pulmonary disease (COPD) in people with serious mental health issues

Nicola Joanna Higgins

Department of Primary Care and Population Health, University College London

BACKGROUND: 9-10% of people in the world may have COPD, but even in developed countries only a quarter are diagnosed. There is a strong association between mental and physical ill health. People with mental health issues are also more likely to smoke than the general population, so may be at greater risk of COPD. A family practice in England tested whether it was worthwhile to target people with serious mental health issues for COPD screening. **AIMS:** A large family practice in England tested inviting patients over 40 years old with serious mental health diagnoses and a history of smoking for spirometry screening. This may help to diagnose COPD earlier so smoking cessation, pulmonary rehabilitation, pharmacological therapy, and self-management can be promoted to improve people's quality of life.

METHOD: People with a serious mental health diagnosis or current anti-psychotic prescription were identified from electronic records. Those under the age of 40, those who had never smoked and those already diagnosed with COPD were excluded. People were invited by telephone and letter for screening spirometry with a doctor or practice nurse.

RESULTS: Fifty-four people were identified for spirometry. Thirty-two attended (59%) and of these three new cases of COPD were diagnosed. Two further people with abnormal spirometry were offered respiratory referral. Everyone screened was given smoking cessation advice and two people stopped smoking after spirometry. This means that 10% of people were diagnosed, received a referral or changed their behaviour as a result of this simple case finding initiative.

CONCLUSIONS: It is feasible and worthwhile to invite people at risk for spirometry in family practice. Targeting the vulnerable mental health patient group seems particularly worthwhile as their physical health needs are often overlooked. Opportunistic case finding is likely to be cost effective, estimated at £814 (\$1260) per quality adjusted life year.

Keywords: COPD, mental health, family practice

Figure 1

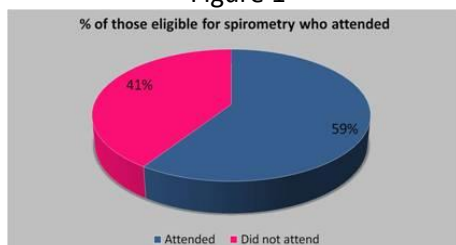


Figure 2

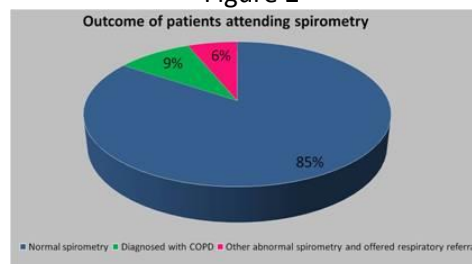
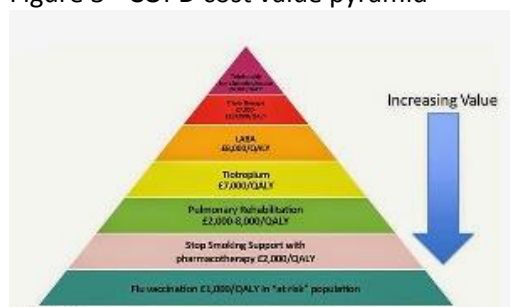


Figure 3 - COPD cost value pyramid



References

R. J. Halbert, J. L. Natoli, A. Gano, E. Badamgarav, A. S. Buist, D. M. Mannino. Global burden of COPD: systematic review and meta-analysis. *Eur Respir J* 2006; 28: 523–532

London Respiratory Team Value Pyramid accessed via IMPRESS Guide to the relative value of interventions for people with COPD. British Thoracic Society and the Primary Care Respiratory Society UK 2012.

National Clinical Guideline Centre (UK). Chronic Obstructive Pulmonary Disease: Management of Chronic Obstructive Pulmonary Disease in Adults in Primary and Secondary Care [Internet]. London: Royal College of Physicians (UK); 2010 Jun. (NICE Clinical Guidelines, No. 101.) Available from: <http://www.ncbi.nlm.nih.gov/books/NBK65039/>

P-0173

Evaluation of The Results of Ambulatory Blood Pressure Monitoring In Outpatient Clinic of Family Practice

P Gamze Erten Bucaktepe, Vasfiye Demir, Ahmet Yılmaz, Hamza Aslanhan, Necmi Arslan, Veysel Kars
Family Medicine Department, Dicle University Medical Faculty, Diyarbakır, Turkey

Introduction

Hypertension is a chronic health problem that affected one third of people in the whole world and leads to a numerous systemic disorders if couldn't be managed properly. Furthermore it is one of the most seen diseases in the primary care. Since ambulatory blood pressure monitoring is very useful in detecting undiagnosed patients and evaluating the effectiveness of the treatment, we aimed to evaluate our Family Practice Outpatient Clinic's results of the ambulatory blood pressure monitoring.

Material and Method: The study included ambulatory blood pressure monitoring results of 64 patients who applied between 2011 and 2014 were evaluated retrospectively. The data including age, gender, height, weight, smoking, drug usage and chronic illness status as well as mean values of systolic and diastolic blood pressure (MSBP and MDBP), arterial pressure (MAP), pulse (MP), pulse pressure (MPP) and valid measurement numbers of the patients were recorded.

Results: Fifty six (87.5%) of 64 patients were women. Of the patients 8 (12.5%) were smokers, 43 (67.2%) were have chronic diseases and 31 (48.4%) were using antihypertensives. Mean values of the measurements were presented in the Table. There wasn't any statistical differences between gender, chronic disease, smoking status and MSBP, MDBP, MAP, MP, MPP values ($p > 0.05$). There was statistical significance between antihypertensive drug usage and MPP ($p = 0.013$). After ambulatory blood pressure monitoring, antihypertensive therapies of 13 (20.3%) patients changed, the dose increased or a new drug added. Antihypertensive treatment started to ten patients (15.6%) and 41 patients (64.1%) didn't have any intervention.

Conclusion: It was seen that the management procedure of hypertension carried out better with the ambulatory blood pressure monitoring. Moreover the patients were more satisfied with the application and their treatment compliance increased. It is concluded that ambulatory blood pressure monitoring would be useful and had to be expanded in primary care.

Keywords: Primary care, hypertension, ambulatory blood pressure monitoring

Mean Values of Measurements

	Mean±Standard Deviation
Age (year)	55.1±10.8
BMI (Body mass index-kg/m ²)	29.9±5,5
Systolic blood pressure (mmHg)	122.8±15.8
Diastolic blood pressure (mmHg)	77.4±9.5
Arterial pressure (mmHg)	97.9±12.1
Pulse (mmHg)	73.9±8.8
Pulse pressure (mmHg)	45.5±9.4
Valid measurement numbers	41.8±14.0

P-0174

Are we making a appropriate diagnosis and treatment of heart failure in primary care?

María Del Mar Forés Chacori¹, María Dolors Riera Cervera¹, Nerea Trecet Yarzabal³, Jose Romero Tamara², Patricia Oscanoa Huamán², Susana Elisabeth Riesgo¹, Max Alexander Encarnación Minaya³

¹CAP Amadeu Torner

²ABS Santa Eulàlia Sud

³ABS Santa Eulàlia Nord

Background & Aim: Analyze the optimization in diagnosis and treatment of patients with heart failure (HF).

METHOD: Retrospective study in urban primary care center. People with diagnosis of heart failure in computerized medical history between 2003-2015.

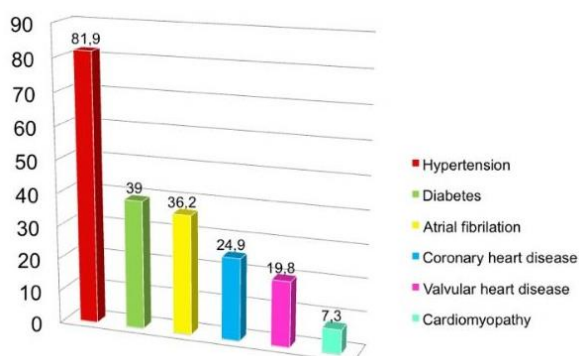
Those were the variables collected: Sex,age,duration,cardiologist visits,hospital admissions due to HF in 2014,cardiovascular risk factors,registration of clinical symptoms in medical history:dyspnea,fatigue,decreased mictorution,physical exam registration: cardiac auscultation (CA),pulmonary auscultation (PA) and lower limb edema,echocardiogram performed 3 months before or after the diagnosis and treatment: ACE inhibitors,ARBs,beta-blockers BB,AA aldosterone,diuretics.

RESULTS: 177 patients. 59.9% women,mean age 77.8 (SD 9.4),years evolution 3.44 (SD 3.13),cardiologist visits / year 0.94 (SD 1.26),hospital admissions 2014 0.5 (DE: 1). Cardiovascular risk factors: Hypertension 81,9%,Diabetes 39%,Coronary heart disease 24,9%, Valvular heart disease 19,8%,cardiomyopathy 7,3% y atrial fibrillation 36,2%. Anticoagulants 33.9% and antiplatelet 38.4%.Physical exam: pathological (29.4% CA, 46.9% PA, 47.5% lower limb edema),no data (29.4% AC, 22.6% AP, 26.6% lower limbs). An echocardiogram was done in: 53.7% (48.1 % Men 62% Women) p: 0.07. Treatment: 1- Systolic HF NYHA:I ACE inhibitor and BB 52.2%;II ACE inhibitor 11.9%, ACE inhibitors and BB 31.3%, ARB and BB 22.4%; III ACE inhibitor 15,2%, ACE inhibitor and BB 33,3%,ACE inhibitor and BB and AA 15.2%;IV ACE inhibitor and BB and AA 100%. 2- Diastolic IHF ACE inhibitor 17,2% ARBs 17,2% ACE inhibitor +BB 25,9% ARBs +BB 17,2.% 3- The diuretics 68.6% NYHA I 43.5%, II 72.5%, III 84.8%, IV 100% p: 0.015.

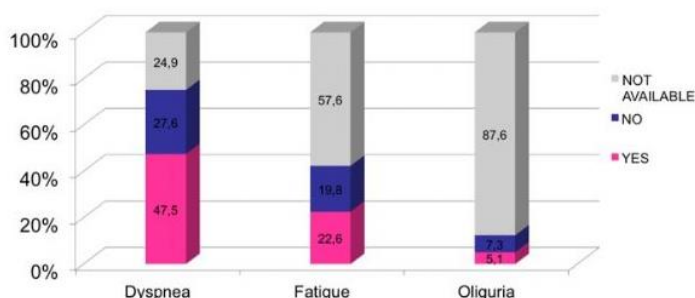
CONCLUSIONS: Patient symptoms and physical examination should be grater registered in medical history. Besides we should perform more echocardiograms for diagnostic confirmation. Treatment is suitable according to NYHA but should increased the use of aldosterone antagonist in Class III. Regarding the associated pathologies related with HF occurrence, we should detect, treat and control as soon as possible to prevent that occurrence.

Keywords: Heart fallure, Cardiovascular risk factors, treatment

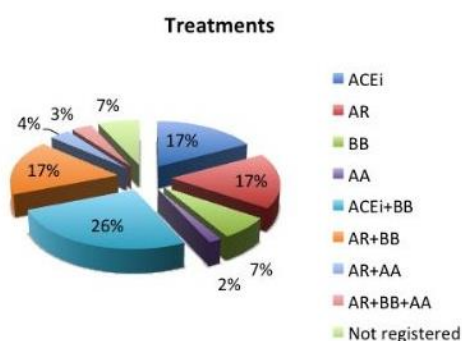
Cardiovascular risk factors for HF



Register of symptoms in medical records



Treatment of diastolic HF



P-0175

A Case Admitted To Family Physicians With Diffuse Pain Complains: Psoriatic Arthritis

Ayşe Rana Platin¹, Fatma Keren², Duygu Kurtuluş³, Hatice Selcen Biçer²

¹Department of Family Medicine, Umraniye Training And Research Hospital, Istanbul, Turkey

²Department of Intenal Medicine, Umraniye Training And Research Hospital, Istanbul, Turkey

³Department of Physical Therapy, Umraniye Training And Research Hospital, Istanbul, Turkey

AIM: Psoriatic arthritis is a chronic inflammatory arthropathy characterized with peripheral joint, spine and enthesis involvement. Most of the cases are severe and progressive. The diseases affect patients' quality of life and leads functional limitation.

MATERIAL-METHOD: A forty-year-old Syrian man admitted to outpatient service with pain complains localized in knees, elbows, back and neck. Patients physical examination revealed psoriasis type skin lesions localized in elbow and knees. Also there was arthritis induced sensitivity in both knees. Patient's laboratory tests were in normal ranges; Erythrocyte sedimentation rate: 20mm/h, C-reactive protein: 3mg/dl, ANA: negative, Anti-CCP: negative and HLA b27: negative.

With existing laboratory findings and physical examination diagnosis differentiation for rheumatoid arthritis and ankylosing spondylitis has been made. Additionally patient's radiographic evaluation with x-ray was also normal. There was no joint space narrowing but there was widening in knee joints which was proving our diagnosis of arthritis.

In order to treat patient's skin lesions and arthritis we have started topical steroids, non-steroidal anti-inflammatory drug, methotrexate 10mg/week, folic acid and proton pump inhibitor.

RESULTS: Psoriatic arthritis generally diagnosed in divisions of rheumatology, physical therapy and rehabilitation or dermatology. This case was admitted to our clinic with diffuse pain complains. Patients diagnosed with anamnesis and physical examination. His treatment planned with physical therapy and rehabilitation specialists. We have started DMARDs like methotrexate, leflunomide. For unexpected loss of response we have consulted to rheumatology service to start biologic drugs basically the anti-TNFs. For the skin manifestation we have consulted to dermatology department. This patient is successfully diagnosed and followed in consultation with related specialties.

CONCLUSION: In this case we have diagnosed the patient through physical examination without radiography or laboratory parameters. As in most of the chronic diseases, the importance of anamnesis and correct physical examination has been reunderstood.

Keywords: Pain, Psoriatic Arthritis, Diagnose

Image 1



psoriasis type skin lesions localized in knees.

Image 2



Arthritis in knee

P-0176

Post Polio Syndrome

Alfredo Quiles Raga, Enrique Almenar Cubells, Enriqueta Hernandez Hernandez, Diana Diaz Gil, Oscar Perez Quintana, Jose Espuig Aviño, Daniel Casiano Palacios Martorell, Juan Matamoros Hernandez, Amparo Ridaura Marti, Federico Vendrell Torres
Centro de Salud de Benifaio, Valencia, Spain

Introduction

Post-polio syndrome (PPS) refers to a clinical condition that can develop in patients who suffered polio in childhood, is a clinical diagnosis that is made by exclusion, and current diagnostic criteria set by the March of Dimes in 2010, include

- History of previous polio
- stabilization period after clinical symptoms of acute poliomyelitis least 15 years
- Establishment of acute or progressive new muscle deficit or abnormal fatigability (decreased endurance), with or without generalized fatigue, new muscle atrophy, or muscle or joint pain
- New symptoms should stay at least a year

-Reason for consultation:

Weakness, loss of strength and falls

Personal history

Polio, osteoporosis treated with raloxifene.

-Current disease:

Patient 52 years old, diagnosed with polio at age two, who used batons to wander English, referring for over a year, picture of weakness, loss of strength, fatigue and falls, but lately occasional arthralgia requires a more continuous use of NSAIDs (dexketoprofen) for control.

-Physical examination:

Flaccid paralysis and atrophy of the lower limbs

-Investigations:

Biochemistry and CBC, not objective liver, musculoskeletal disorders (CRP, FR), infectious or metabolic disorders (including iron and TSH profile)

-Diagnostic trial:

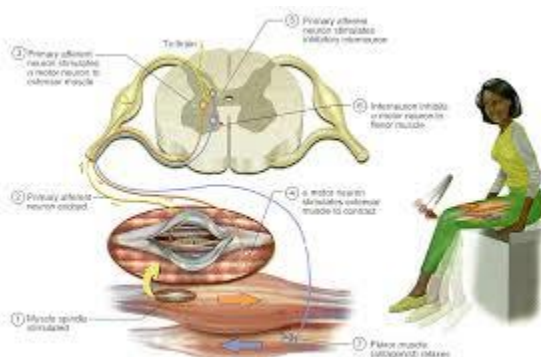
Post-polio syndrome (PPS)

Diagnosis of exclusion of other neurological processes, medical and orthopedic

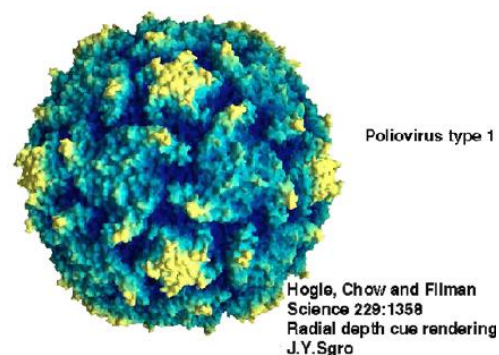
There is no specific pharmacological treatment for PPS and approach must be multidisciplinary, including Family Doctor, Neurology, Psychologist and Social Worker

Keywords: Polio, Flaccid paralysis, Weakness

Motor neurone



Polio Virus



P-0177

Respiratory disease consultation in Primary Care Setting: A three year experience

Rui Miguel Gigante Manso, Mafalda Cerqueira, Raul Marques Pereira, Cecilia Oliveira Abreu
USF Lethes, Centro de Saúde de Ponte de Lima, Unidade Local de Saúde do Alto Minho, Viana do Castelo, Portugal
Background

Chronic Obstructive Pulmonary Disease (COPD) presents a diagnostic and therapeutic challenge for primary health care, requiring an individualized and multidisciplinary approach in order to achieve an early diagnosis, appropriate monitoring and consequent reduction of exacerbations and decline in lung function. In Portugal prevalence is estimated in 5.3%, reaching 14.2% in adults 40 years or older.

Aim: The main aim of this study was to determine the prevalence of COPD in our Primary Health Care unit. Secondary objectives included: characterization of patients, classification according to Global Initiative for Chronic Obstructive Lung Disease (GOLD) criteria and treatment management.

Methods: We performed an observational, retrospective study. Since 2012 our health care unit implemented an integrated respiratory illness consultation (nurse and doctor). Individuals 40 years and older with history of smoking (10 years or more) were invited to attend this consultation. All collaborators received previous training regarding diagnostic criteria and treatment options.

All participants completed an assessment Test (CAT) at initial visit and were required to perform a spirometry. Patients were re-evaluated and classified using the 2013 Global Initiative for Chronic Obstructive Lung Disease (GOLD) criteria. Characterization and stratification of patients as well as treatment options were registered in a purposely formulated database.

Results: 273 patients were invited to attend the respiratory consultation. 201 patients attended (presence rate of 74%). The prevalence of COPD found in 2014 was 1 %. 82% presented recent spirometry and 86% undergoing inhaled corticosteroids and /or bronchodilation therapy.

Discussion: Despite the effort in implementing this particular consultation to identify COPD patients who were not previously diagnosed, the prevalence of COPD in our Primary care setting remains below our national numbers. It was however possible to increase the number of patients with updated spirometry update diagnosis and optimize therapeutic strategies.

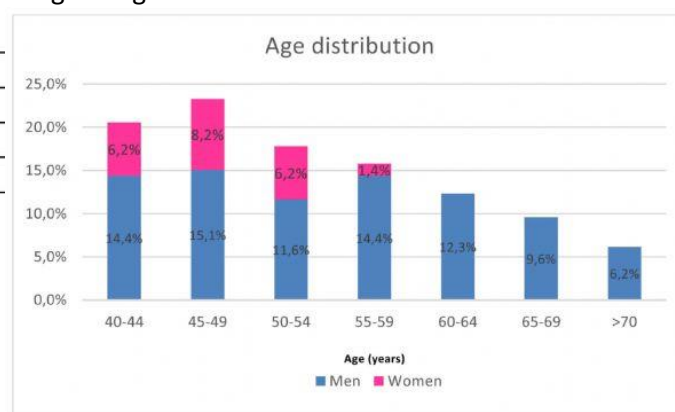
Keywords: Chronic Obstructive Lung Disease, Primary Health Care, spirometry

Table 2: Characterization by genre

	Men	Women	Total
Distribution (%)	78,6%	21,4%	
Mean Age (Years)	55,3	47,7	53,6
IMC (kg/m ²)	26,2	24,5	25,85

Characterization by genre of the patients

Image 1: Age distribution



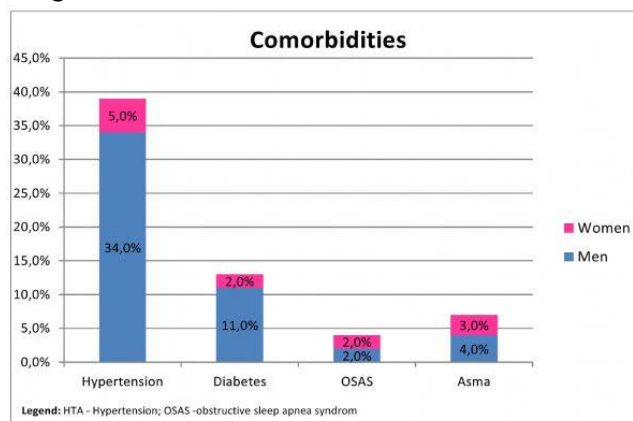
Distribution by age and sex

Table 1: Chronogram of the intervention program

Date	Tasks
April 2012 to October 2012	Theoretical and practical training of doctors and nurses - discussion of COPD diagnostic criteria's and management options – Monthly reunion (1 hour) Evaluation of COPD diagnosis and treatment: % of patients with COPD diagnosis % of COPD patients with spirometry (up to two years) % of COPD patients with bronchodilators and or inhaled corticosteroids
November 2012	Knowledge Assessment (theory multiple choice test)
December 2012	Presentation of annual results. Strategies to improve.
January 2013 to August 2013	Elaboration of a clinical practice manual
September 2013 to September 2014	Implementation of COPD consultation
October 2014	Assessment of COPD consultation ...% of patients with COPD diagnosis % of COPD patients with spirometry % of COPD patients with bronchodilators and or corticosteroids

Chronogram of the intervention program

Image 2: Comorbidities



Comorbidities of patients

Table 3: Parameters of COPD patients

	Min	Max	Mean
Pack-year cigarettes	0	101	26,7
COPD Assessment Test (Score)	0	29	8,8
FEV ₁ (%)	44	123	80,2
Peak Flow (l/min)	60	670	368

Parameters of COPD patients

P-0178

Headache in Hyperlipidemia Patients

Funda Yıldırım Baş¹, Seden Demirci², Bahriye Arslan¹, Zeliha Salman³

¹Department of Family Medicine, Süleyman Demirel University, Isparta, Turkey

²Department of Neurology, Süleyman Demirel University, Isparta, Turkey

³Eğirdir Community Health Center, Isparta, Turkey

BACKGROUND: Headache is the most common complaint of the patients, who applied to general outpatient clinics. In recent years, association between metabolic syndrome, obesity, and primary headaches has attracted much attention. Our aim was to investigate the association between headache and hyperlipidemia.

METHODS: 92 participants having hyperlipidemia and 100 healthy controls were enrolled in this study. All participants were checked for their total cholesterol, HDL and LDL cholesterol, and triglyceride levels. The diagnosis of hyperlipidemia was made according to National Cholesterol Education Program Adult Treatment Panel III (NCEP ATP-III) criteria. We investigated the presence of headache, the duration, frequency of headache, the duration of headache attack, and the severity of headache. The diagnoses of tension type headache and migraine were defined based on International Classification of Headache Disorders-II criteria.

RESULTS: Mean age of the participants was 37 ± 13.8 years. Of all participants, 106 (%55.2) were females, 86 (%86) were males. Two groups were similar in terms of gender and years. In hyperlipidemia group, 30 (%32.6) patients had headache, in control group 16 (%16.0) had headache. This difference was statistically significant (p=0.06). 7 (%23.3) patients were migraine, 21 (%70.0) were tension type headache, 2 were (%6.7) mixed type headache in hyperlipidemia group. 3 (%18.8) were migraine, 12 (%75.0) were tension type headache, 1 (%6.2) mixed type headache in control group. There was no statistically significant difference between the groups according to headache type (p=0.9). The patients with hyperlipidemia had significantly higher VAS and duration of headache attack compared to the controls (p = 0.003, p = 0.04, respectively).

CONCLUSIONS: Our study suggests that headache may be frequent in hyperlipidemia patients. Therefore, clinicians should be aware of headache in hyperlipidemia patients.

Keywords: headache, hyperlipidemia, migraine

P-0179

Prevalence of insomnia and associated factors in the general population of Thrace, North-Eastern Greece

Eleni Leontidou¹, Grigorios Trypsianis², Evangelia Nena⁴, Pashalis Steiropoulos³, Apostolos Manolis¹

¹Health Center of Iasmos, Komotini, Greece

²Department of Laboratory of Medical Statistics, Democritus University, Alexandroupolis, Greece

³Department of Pneumology, Democritus University, Alexandroupolis, Greece

⁴Department of Laboratory of Hygiene and Environmental Protection, Democritus University, Alexandroupolis, Greece

Background-AIM: Insomnia is an important public health challenge due to its high prevalence, estimated between 10-20% in the general population, and its subsequent impact on individuals and societies. Aim of this study was to assess the prevalence of insomnia as well as the association between insomnia symptoms and different socio-demographic characteristics, behaviors and health-related conditions.

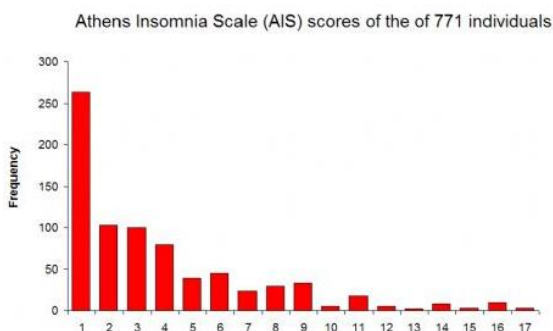
METHODS: A population-based sample of 771 individuals aged 24 to 89 years (mean age, 58.16 ± 13.12 years; 43% women) was selected randomly from the area of Thrace, North-Eastern Greece, using a multiple-stage sampling method with stratification according to gender, age and residence. Socio-demographic data, sleep habits and morbidity were recorded. Insomnia was evaluated with Athens Insomnia Scale (AIS), an 8-item scale assessing: sleep induction, awakenings, final awaking, sleep duration, sleep quality, daytime wellbeing, daytime functioning capacity and daytime sleepiness. Additionally, the Epworth Sleepiness Scale for Excessive Daytime Sleepiness, the Stop-Bang Questionnaire and the Berlin Questionnaire for Obstructive Sleep Apnea risk were also used. Insomnia was defined when AIS score was ≥ 6.

Results. The prevalence of insomnia in the total sample was 18.1% (n=141); difficulty in maintaining sleep was the most frequent symptom (26.2%). Multivariate logistic regression analysis revealed that insomnia was independently associated with female gender (aOR=1.76, p=0.005), age >70 years (aOR=1.61, p=0.040), high Body Mass Index (aOR=2.91, p=0.005), presence of a chronic disease (aOR=1.55, p=0.043), snoring (aOR=1.61, p=0.020), midday napping (aOR=1.58, p=0.025) and divorced/widowed marital status (aOR=2.23, p=0.002). In particular, mental and respiratory disorders, as well as chronic pain were significantly more frequent in subjects with insomnia.

Conclusions. Insomnia prevalence in North-Eastern Greece is in line with previous European and international reports. Different socio-demographic and anthropometric characteristics and chronic health disorders predispose to the prevalence of insomnia.

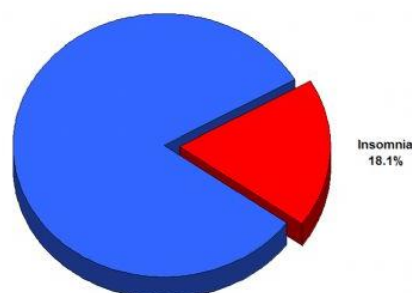
Keywords: Insomnia, associated factors, general population

Athens Insomnia Scale (AIS) scores of the of 771 individuals

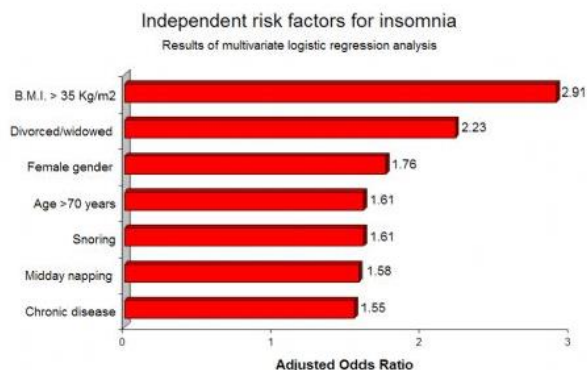


The prevalence of insomnia in the sample of the of 771 individuals

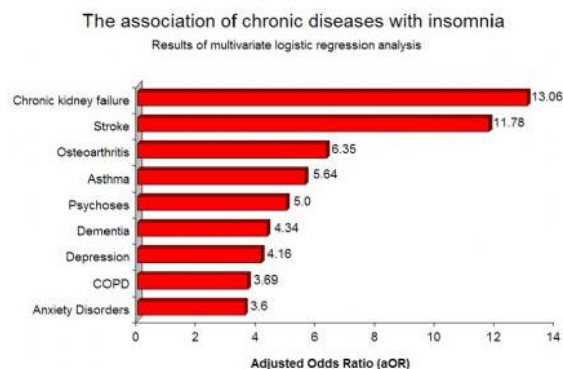
The prevalence of insomnia in the sample of the of 771 individuals



Independent risk factors for insomnia (Results of multivariate logistic regression analysis)



The association of chronic diseases with insomnia (Results of multivariate logistic regression analysis)



P-0180

Prevalence and risk factors of excessive daytime sleepiness in the general population of Thrace, North-Eastern Greece

Apostolos Manolis¹, Grigorios Trypsianis², Pashalis Steiropoulos³, Evangelia Nena⁴, Eleni Leontidou¹

¹Health Center of Iasmos, Komotini, Greece

²Department of Laboratory of Medical Statistics, Democritus University, Alexandroupolis, Greece

³Department of Pneumology, Democritus University, Alexandroupolis, Greece

⁴Department of Laboratory of Hygiene and Environmental Protection, Democritus University, Alexandroupolis, Greece

Background–AIM: Excessive daytime sleepiness (EDS) is a common condition worldwide affecting negatively individuals' quality of life, daytime activities and having impact on occupational and transport safety. Aim of this study was to assess the prevalence of EDS and to correlate it with different socio-demographic, anthropometric characteristics and health conditions.

METHODS: A population-based sample of 771 individuals, aged 24 to 89 years (mean age, 58.16 ± 13.12 years; 43% women), was selected randomly from the area of Thrace, Northern Greece, using a multiple-stage sampling method with stratification according to gender, age and residence. Socio-demographic data, sleep habits and comorbidities were recorded. EDS was assessed with the use of Epworth Sleepiness Scale (ESS), a self-rating scale on the likelihood of dozing in eight situations of everyday life. Additionally, the Stop-Bang Questionnaire and the Berlin Questionnaire for the assessment of Obstructive Sleep Apnea risk were answered by the participants. ESS ≥ 10 was used to define EDS.

Results. Prevalence of EDS was 8.2% (n=63); excessive sleepiness "Watching TV" (71.4%) and "Sitting and reading" (47.6%) were the most frequent symptoms. Multivariate logistic regression analysis revealed that sleepiness was independently associated with male gender (aOR=1.90, p=0.044), high Body Mass Index (aOR=1.83, p=0.050), snoring (aOR=4.32, p<0.001), midday napping (aOR=3.54, p<0.001), high Stop-Bang score (aOR=6.95, p=0.002), high Berlin Questionnaire score (aOR=2.04, p=0.042) and low (aOR=3.41, p=0.001) or high (aOR=2.30, p=0.034) education level compared to medium education level. Regarding chronic conditions, mental disorders, diabetes mellitus, arterial hypertension, allergic rhinitis, migraine, dementia, benign prostate hyperplasia and hypothyroidism were significantly more frequent in subjects with sleepiness.

Conclusions. A significant proportion of residents in the area of Thrace, NE Greece, reported excessive daytime sleepiness. Various associations with anthropometric and socio-demographic characteristics were revealed, as well as with the presence of numerous chronic conditions.

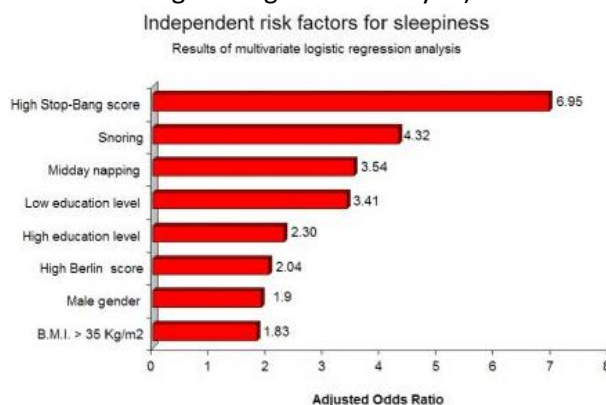
Keywords: excessive daytime sleepiness, associated factors

The prevalence of sleepiness in the sample of the of 771 individuals

The prevalence of sleepiness in the sample of the of 771 individuals



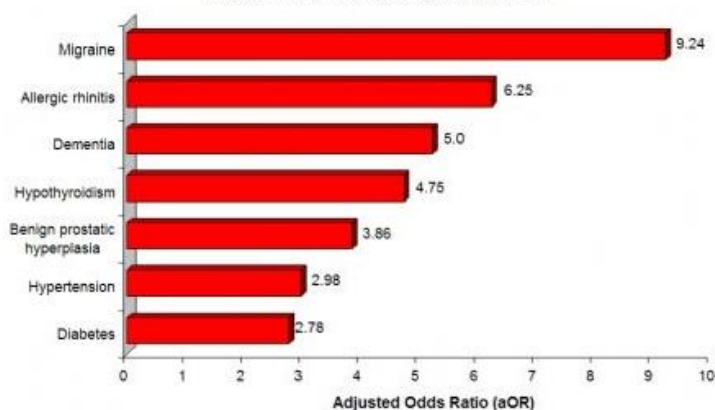
Independent risk factors for sleepiness (Results of multivariate logistic regression analysis)



The association of chronic diseases with sleepiness (Results os multivariate logistic regression analysis)

The association of chronic diseases with sleepiness

Results of multivariate logistic regression analysis



P-0181

Patient-centered Approach To a New Onset Diabetes Patient: Case Report

Yasemin Kılıç Öztürk, Ayşegül Bayad, Yusuf Adnan Güçlü
Izmir Tepecik Training and Research Hospital, Izmir, Turkey

INTRODUCTION

Diabetes is a chronic metabolic disease that requires continuous medical care. Patient-centered approach is important during treatment of patients with diabetes medication and lifestyle changes. Patient-centered approach to a new onset diabetes patient will be presented.

CASE REPORT

46-year-old male patient was admitted to our clinic with general fatigue and nonspecific abdominal pain. He had a past history of smoking and alcohol abuse for 25 years. He quit smoking because of chronic cough, he'd inhaled the intense solvents because of working in the furniture-polishing industry. There were no specific physical examination findings. Laboratory tests showed fasting blood glucose(FBG):227 mg/dl, postprandial blood glucose(PBG):335 mg/dl, hbA1c:%10, triglycerides:85 mg/dl, ldl cholesterol:220 mg/dl, hdl cholesterol:59 mg/dl. He was diagnosed as diabetes and hyperlipidemia. He was advised to use insulin due to guidelines, stop alcohol, have poor dietary saturated fat and carbohydrates, regular exercise, aerating the environment at workplace. He refused using insulin treatment so Metformin+sitagliptin and atorvastatin were prescribed. He was provided psychological support and called for check-up visit a month later. During the first check-up visit we learned that he applied diet, did exercise regularly, used drugs properly. He developed anxious symptoms after stopped drinking. Control laboratory tests showed FBG:105 mg/dl, PBG:177 mg/dl, ldl cholesterol:53 mg/dl, triglycerides:

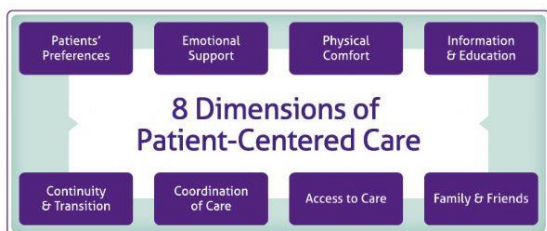
85 mg/dl, hdl:65 mg/dl. The HbA1C levels decreased to 7.5 than 6.3 at the continuous check-ups. The patient was advised to continue the current treatment and prescribed escitalopram for anxiety. Erectile dysfunction occurred during escitalopram treatment and so is changed with sertraline, erectil dysfunction disappeared.

CONCLUSION

Patient-centred approach increases patients adherence to therapy for chronic illnesses such as diabetes. The diet and exercise in the treatment as well as environmental factors should be regulated, and followed at regular intervals as supportive care. Biopsychosocial and patient centered model should be the basic approach for diabetes patients.

Keywords: diabetes guidelines, insulin, alcohol, life style changes

Dimensions of Patient Centered Care



Healthy Life Style Choices



Life Style Changes and Drug Therapy During Chronic Diseases



Patient Centered Care



P-0182

Epidemiology, Complications, Extraintestinal Manifestations and Treatment of Inflammatory Bowel Diseases in Area of Sanliurfa

Ahmet Uyanikoglu¹, Timucin Aydogan¹, Elif Burcu Yavuz², Dursun Cadirci², Ibrahim Arslan¹, Necati Yenice¹

¹Department of Gastroenterology, Harran University, Sanliurfa, Turkey

²Department of Family Medicine, Harran University, Sanliurfa, Turkey

BACKGROUND&AIM: Epidemiological, clinical and treatment characteristics of inflammatory bowel diseases (IBD) cases that followed in Harran University Hospital, Clinic of Gastroenterology were studied.

METHOD: The data of 90 IBD patients that followed in between January 2012 and May 2014 were evaluated retrospectively.

RESULTS: 44 of patients(49%) is women, average age is 32.19±11(16-68) years, average body mass index is 24.1±2.8(17.5-29.4) kg/m². 68 of patients(75%) have ulcerative colitis(UC), 20 of patients(22%) have Crohn's disease(CD) and 2 of patients(3%) have indeterminate colitis. Median age is 9(1-120) months. Serious

complications developed in 9 patients(10%) that followed in; 2 of these had fistulizing CD, 3 patients had bowel resection; 2 with serious bleeding and one had toxic megacolon, one patient had short bowel syndrome due to bowel resection and one patient using infliximab because of fistulizing CD died due to sepsis. Extraintestinal manifestations (EIMs) was determined in 4 patients, including three of ankylosing spondylitis(AS) and other one had peripheral arthritis. On admission 56 of patients(60%) had activated disease. 74% of patients were using 5-amino salicylic acid(5-ASA), 23% of patients were using 5-ASA and immunosuppressives and 3% of patients were using single immunosuppressive in the maintenance treatment. The most commonly used immunosuppressive drug is azathioprine(AZA) and about 25% of patients were using it. Cortisone or budenofalk are used or are being used in approximately 30% of patients. 4 of patients(4%) were using infliximab(2 CD, 2 UC), one of patients(%1) were using adalimumab.

CONCLUSIONS: Our patients with IBD average is in third decade, three-quarters of patients have UC. Complications were observed in 10% of patients including one mortal. EIMs was determined at a low rate according to literature and the most common EIM is AS. Three-quarters of patients were using 5-ASA, one-quarter of patients were using 5-ASA and/or immunosuppressive drugs (most commonly AZA) in the maintenance treatment.

Keywords: inflammatory bowel diseases, epidemiology, complications, treatment

P-0183

Pneumoconiosis in a Couple of Cat Litter Packaging Worker- A Case Report

Meşide Gündüzöz¹, Murat Büyükşekerci², Türkan Nadir Öziş³, Engin Tutkun⁴, Ömer Hınç Yılmaz⁵

¹Department of Family Medicine, Ankara Occupational Diseases Hospital, Ankara, Turkey

²Department of Pharmacology, Ankara Occupational Diseases Hospital

³Department of Chest Diseases, Ankara Occupational Diseases Hospital

⁴Department of Occupational Toxicology, Ankara Occupational Diseases Hospital

⁵Department of Public Health, Yıldırım Beyazıt University Faculty of Medicine Ankara, Turkey

INTRODUCTION

Silicosis is a chronic pneumoconiosis disease that develops following prolonged inhalation of silica (SiO₂) substance. A six months duration period of exposure to silica dust is enough for the development of the disease. Dyspnea and fatigue are common symptoms. Miners, denim sandblasters, ceramic workers, cat litter production workers, etc. are under risk for silicosis.. Cat litter is produced from a type of clay called the diatomite and contains at least silicon 90%. In this study, we present a cat litter packaging worker couple with pneumoconiosis.

CASE

A couple, 47 years old female patient and 43 years old male patient were admitted to our hospital for dyspnea and productive cough ongoing for one year. They have been both working in a cat litter packaging factory for 10 years and 7 years respectively. History of the patients revealed that they had been occupationally exposed to silica dust and protective equipments in the work place were insufficient. Both patients were diagnosed as pneumoconiosis according to occupational history, pulmonary function tests and HRCT findings.

RESULT

Pneumoconiosis develops as a result of environmental or occupational exposure to silica. Respiratory failure, pulmonary hypertension, cor pulmonale are some complications of this disease. It may progress to progressive massive fibrosis and emphysema. The presence of pneumoconiosis increases the risk of mycobacterium infection. Workplace air must be monitored regarding the occupational exposure limit values of dust concentration. The protective equipments should be regularly used by workers and the work place owners should take preventative precautions.

Keywords: Pneumoconiosis, silica, cat litter.

P-0184

A Mercury Intoxication Case with a Hand-Made Skin Cream

Meşide Gündüzöz¹, Murat Büyükşekerci², Ceylan Bal³, Engin Tutkun⁴, Ömer Hınç Yılmaz⁵

¹Department of Family Medicine, Ankara Occupational Diseases Hospital, Ankara, Turkey

²Department of Pharmacology, Ankara Occupational Diseases Hospital,

³Department of Biochemistry, Ankara Occupational Diseases Hospital,

⁴Department of Occupational Toxicology, Ankara Occupational Diseases Hospital

⁵Department of Public Health, Yıldırım Beyazıt University Faculty of Medicine Ankara, Turkey

INTRODUCTION

Mercury is a toxic substance. Fucus red, used as a lipstick in the past, was mercury sulfide. Hand-made cosmetic products may contain mercury. The maximum permissible level of mercury in cosmetic products is 1 ppm. In this study, we present a patient with multiple non-specific symptoms who has been exposed mercury by dermal route and had a history of using handmade skin cream for one year.

CASE

A 30-year-old female patient admitted to our clinic for generalized muscle pain, joint pain, abdominal pain, burning sensation in both legs, difficulty in walking and weight loss. She had a white filling in her tooth which was applied last month. She thought it would contain a mercury amalgam and this would worsen her symptoms. The patients' detailed history revealed that she had been using a handmade skin care cream for one year. On physical examination; peeling in both palms, papular eruptions on the face, mild sensitivity on lower extremities and on spinal muscles were observed. No amalgam filling was detected. Urine mercury level was higher than reference value (61.3 µg/L and <10 µg/L respectively). The chelation therapy with DMPS was started. At the end of two months her urine mercury level was 2.3 g/L and she was discharged. After six months she had no previous complaints and her dermal signs disappeared.

RESULT

Exposure to mercury by cosmetic products via dermal route is not a rare case in developing countries. These cases are usually asymptomatic, but muscle spasms, abdominal pain, amnesia, skin eruptions may be nonspecific symptoms. Concerning a heavy metal exposure detailed history should be taken and blood/urinary mercury levels should be monitored.

Keywords: Mercury, cosmetic creams, chelation therapy.

P-0185

Evaluating the Effect of Education about Diabetes and Foot Care on the Development of Diabetic Foot Ulcer

Esra Demir, Sabiha Banu Denizeri, Ayşe Palanduz

Department of Family Medicine, Istanbul University, Istanbul, Turkey

BACKGROUND&AIM

Diabetes Mellitus (DM), is a chronic disease that requires a regular follow-up, treatment and patient compliance from the moment it is diagnosed. Since, the importance of foot care education is overlooked in DM, diabetic foot ulcer (DFU) remains an important problem. In our study, we aimed to evaluate the effect of education in diabetic patients with or without DFU.

METHOD

A total of 403 patients, 200 of them with DFU followed up in the general surgery or hyperbaric medicine clinics (Group1), and 203 without any DFU followed up in the diabetes department outpatient clinics of Istanbul Faculty of Medicine (Group2), were admitted to our study from July to September 2014. After written consent was taken, a survey with 54 questions about the patients' demographic properties, and their knowledge and attitude about DM was conducted.

RESULTS

The average age of our patients was 62.7±9.95 years in Group1 and 57.4±12.3 years in Group2 (Table-1). The rate of males, uneducated people and people living alone was higher in Group1; whereas, tobacco smokers and alcohol drinkers were significantly lower (all p<0.05). In Group1, the rate of patients having a diabetes duration

exceeding 16 years (50%), receiving an insulin therapy (55.5%) and having comorbidities was higher (all $p < 0.05$) (Table-2). The rate of patients who received foot care education was found 15.5% in Group 1, while it was 61.5% in Group2 ($p < 0.05$). The awareness rate about the educational requirements was 76% in Group1 and 92.1% in Group2 ($p < 0.05$).

CONCLUSIONS

A comprehensive and standardized diabetes and foot care education should be given to all patients right from the day they are diagnosed with DM. Their knowledge and attitude should be evaluated regularly and any insufficiency should be fulfilled. The family doctor leading the primary care team, should help patients develop awareness and preventive health behaviours.

Keywords: Diabetes mellitus, diabetic foot, primary care

Table-1 The Social and Demographic Properties In Two Groups

Property	Patients with DFU (n=200)	Patients w/o DFU (n=203)	p value
Average age (years)	62.7± 9.95	57.4 ±12.3	<0.05
Male, n (%)	137 (68.5%)	95 (46.8%)	<0.05
Uneducated, n (%)	24 (12%)	12 (5.9%)	<0.05
Tobacco smokers, n (%)	17 (8.5%)	39 (19.2%)	<0.05
Alcohol drinkers, n (%)	9 (4.5%)	21 (10.3%)	<0.05
Living alone, n (%)	15 (7.5%)	7 (3.4%)	<0.05

Table-2 Some Variables Related to Diabetes In Two Groups

Variable	Patients with DFU (n=200)	Patients w/o DFU (n=203)	p value
Patients with DM duration >16 years, n(%)	100 (50%)	70 (34.5%)	<0.05
Patients receiving insulin therapy, n(%)	164 (82%)	116 (57%)	<0.05
No diet, n(%)	50 (25%)	40 (19.7%)	<0.05
No exercise, n(%)	164 (82%)	94 (46.3%)	<0.05
Patients who had foot care education, %	15.5%	61.6%	<0.05

P-0186

Chronic kidney disease with alveolar hemorrhage

Cristina Ana Baquer Sahun¹, Patricia Sanchez Galan², David Ruiz Martinez³, Araceli Fernandez Revuelta¹

¹C.S. Delicias Sur, Zaragoza

²Emergency Department Hospital Barbastro

³C.S. Puente La Reina

Case Description: 77-year-old male with medical history of hypertension, sigmoid diverticulosis and chronic kidney disease (CKD) (diagnosed by Nephrology as secondary to nephrosclerosis, without histologic diagnosis). He was admitted at the Emergency Department because of hemoptysis and dyspnea with oliguria.

Exploration and additional tests: On physical examination the patient was afebrile with 88% oxygen saturation and blood pressure 100/60 mmHg. The pulmonary auscultation showed decreased breath sounds and crackles in both lungs. The blood tests showed: hemoglobin 8,8gr/dl, hematocrit 27%, creatinine 15,6mg/dl, urea 3,08 g/dl, pO₂ in arterial blood gases 65mmHg. Torax Rx ray: cardiomegaly, alveolar-interstitial involvement.

The patient was admitted in Nephrology Department to continue the study. To reach the final diagnosis, several complementary tests were requested:

- Renal biopsy: rapidly progressive glomerulonephritis, with 100% of epithelial crescents

- cANCA 1,04u/ml
- pANCA 20,75u/ml
- Anti-glomerular basement membrane antibodies: positive 3 times

Differential diagnosis: pulmonary-renal syndromes, such as Wegener's granulomatosis, Goodpasture syndrome, Churg Strauss syndrome, polyarteritis nodosa and microscopic polyangiitis, systemic lupus erythematosus, Goodpasture syndrome, essential mixed cryoglobulinemia. We also should keep in mind as differential diagnosis infectious disease.

Diagnosis: Alveolar hemorrhage with rapidly progressive glomerulonephritis and anti-glomerular basement membrane antibodies is diagnostic of Goodpasture syndrome.

CONCLUSION: During admission in nephrology, the patient was treated with plasmapheresis and prednisone, with favorably evolution. Goodpasture syndrome is an autoimmune disease with glomerular basement membrane antibodies that mainly affects the kidneys and alveoli. It is a rare disease and a lower incidence is estimated at one case per million population. This case shows the difficulty of early diagnosis of reno-pulmonary syndrome in cases where there is only kidney clinic, as was our case. Therefore it is very important a thorough medical history along with a detailed physical examination and appropriate complementary tests to make a correct differential diagnosis with chronic kidney disease.

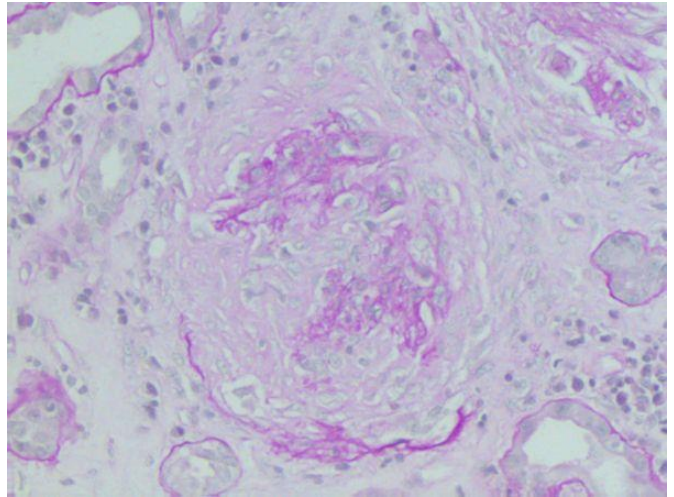
Keywords: Chronic kidney disease, Alveolar hemorrhage, Goodpasture syndrome

Figure 1



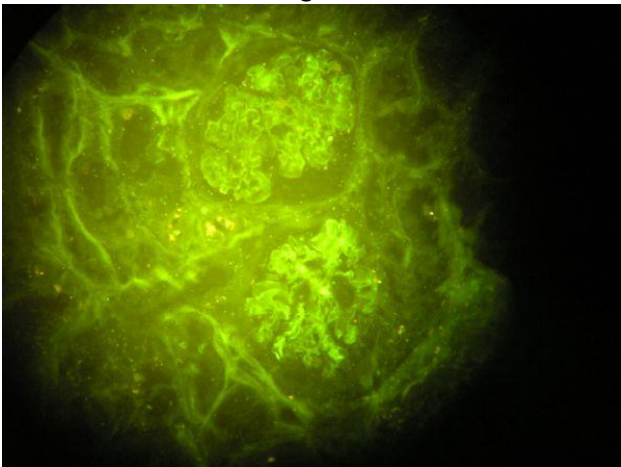
Torax X-ray: alveolar hemorrhage

Figure 2



Histology: epithelial crescents

Figure 3



Inmunofluorescence: deposition of glomerular basement membrane antibody

P-0187

Diabetes and Psychosocial Factors: a Case Report

Catarina Viegas Dias, Catarina Mariano Leal

USF Dafundo, ACES Lisboa Ocidental e Oeiras, Oeiras, Portugal

Background & Aim

Diabetes is beyond doubt a multifactorial pathology, where both physical and psychological factors play an important role. When treatment goals are not met, it is fundamental to understand the underlying causes. Psychological and social problems may be key contributors to a poor diabetes control. The aim of this case report is to highlight the importance of psychological and social assessment as part of the medical management of diabetes.

Case report

We report a case of a 61 year-old male, born in Mozambique, unemployed, and part of a nuclear family (Duvall cycle stage V). He presented as active health problems insulin-treated Diabetes type II with macrovascular and microvascular complications, hypertension, obesity and anxiety. He presented to a routine appointment complaining of knee pain, did not bring self-monitoring records and had a A1C hemoglobin of 8.7%. Since his blood glucose levels were not controlled, the patient was instructed to bring self-monitoring results on the next visit. However, once again the patient did not present adequate blood glucose records. When the physician started to explore disease management expectations and mental wellbeing, the patient reported frequent sadness and anhedonia, which he thought to be related to being away from his family and friends from Mozambique and a loss of social support system.

After this disclosure, the physician further explored the psychosocial environment, optimised psychiatric treatment (since the patient was being treated for anxiety) and referred the patient to a multidisciplinary diabetes consultation. During the following appointments, a social approach was planned to facilitate social integration.

Conclusions

When facing therapeutic non-compliance, it is important to explore the attitudes about the illness, disease management expectations, mental wellbeing and resources. The identification of symptoms of depression and immigrant adjustment problems in this case, allowed the physician to carry an effective patient-centered approach.

Keywords: Diabetes Mellitus Type 2, Social Support, Patient-Centered Care

P-0188

HOW to DIAGNOSE GILBERT DISEASE?

Selma Pekgör¹, Orkide Kutlu², Hayriye Şentürk¹, Abdulkadir Baştürk³

¹Konya Training and Research Hospital, Family Medicine, Konya, Turkey

²Konya Training and Research Hospital, Internal Medicine, Konya, Turkey

³Konya Training and Research Hospital, Hematology, Konya, Turkey

Introduction: Gilbert disease is a clinical condition characterized by mildly elevated indirect bilirubin, without findings of hemolysis or liver disease. Basic disorder is a partial failure in glucuronil transferase enzyme and a reduction in hepatic uptake of bilirubin. We present a patient who was easily diagnosed as Gilbert's disease by the identification of indirect hyperbilirubinemia and regression of indirect bilirubin levels one week later.

CASE: 52 years old woman was admitted to the emergency department with complaints of jaundice, weakness, and fatigue. Patient had similar complaints from time to time. Jaundice was improving in a period. On physical examination: general condition was good, arterial blood pressure was 120/70 mmHg, and pulse rate was 70 /dk. Other system examination was normal except jaundice. In laboratory FINDINGS: Total bilirubin 4.9 mg/dl (0.3-1.2), direct bilirubin 0.5 mg/dl (0-0.2), indirect bilirubin 4.4 mg/dl, AST, ALT, GGT, ALP, LDH, CBC, TSH, vitamin B12, TIT within normal limits. Gilbert disease was suspected. One week later the patient was evaluated again. Total control bilirubin was 0.9 mg / dL, and indirect bilirubin was 0.7 mg / dL. So he was diagnosed as Gilbert disease.

Discussion-CONCLUSION: Gilbert disease is a hereditary benign and is the most common cause of chronic indirect hyperbilirubinemia in society. It is an autosomal dominant genetic disorder. It is present at birth but is generally diagnosed the ages of 15-45. Infections, fatigue, sleeplessness, hunger, excitement, sadness as physical and psychological stress can cause to the indirect hyperbilirubinemia or may lead to an increase in existing hyperbilirubinemia. Usually there is no hepatosplenomegaly. Histological examination of the liver does not show pathological findings. Total bilirubin is usually increase to the range of 1-4 mg/dl and rarely exceed 5 mg/dl. In conclusion, as primary care physicians, if we find jaundice and indirect hyperbilirubinemia with out no other abnormality, before referring to the other hospital, we can control the patient one week later. Significant decrease in total bilirubin and indirect bilirubin will show us no further investigation is required.

Keywords: indirect hyperbilirubinemia, Gilbert disease, jaundice

P-0189

A Case Report of A Silver Ore Worker With Five Different Heavy Metal Exposure

Meşide Gündüzöz¹, Mehmet Erdem Alagüney², Murat Karakurt³, Ceylan Bal⁴, Murat Büyükşekerci⁵, Engin Tutkun⁶, Ömer Hınç Yılmaz⁷

¹Department of Family Medicine, Ankara Occupational Diseases Hospital, Ankara, Turkey

²Department of Internal Medicine, Division of Occupational Medicine, Hacettepe University Faculty of Medicine Ankara, Turkey

³Department of Internal Medicine, Ankara Occupational Diseases Hospital, Ankara, Turkey

⁴Department of Biochemistry, Ankara Occupational Diseases Hospital,

⁵Department of Pharmacology, Ankara Occupational Diseases Hospital,

⁶Department of Occupational Toxicology, Ankara Occupational Diseases Hospital

⁷Department of Public Health, Yıldırım Beyazıt University Faculty of Medicine Ankara, Turkey

OBJECTIVE: The silver ore and processing unit are usually in nearby places. In silver mine the ore is taken away with diggers. Because silver is together with arsenic in the ore the operators of diggers are exposed to arsenic. The ore is distilled with cyanide. The ore contains lead, cadmium, mercury, arsenic, manganese and copper. In the production solvents and silicates are used. The heavy metals and solvents can effect hematological system, central nervous system, kidneys, liver and others.

This case report aims to reveal multiple exposure of a patient working in a silver ore who was monitored with only blood lead levels.

Clinical features: 36 years old male who was working in gold and silver mine for three years applied to our hospital because of high lead level detected in periodic health monitoring. Because of the multiple exposure nature of the work heavy metal profile of the patient is ordered. Blood lead level was 48 µg/l, hair cadmium 6,4 µg/gr (<3 µg/gr normally), 24 hours urinary manganese 3.2 µg/l (<2 µg/l normally), urinary mercury 85 µg/l (<10 µg/l normally), urinary arsenic 50 µg/l (<35 µg/l normally) and urinary thrychloroacetic acid 17 µg/l. The patient was exposed to lead, manganese, cadmium, mercury, arsenic and solvent. Fortunately the patient did not have any end organ damage and discharged with counselation for preventive measures.

CONCLUSION: When toxicological analysis of patients with multiple exposure are done not only a single metal should be analysed but a panel of these metals should be assessed. The physical examination and analysis towards the potential organ damages should be performed. The patients should be followed for future effects of these toxic metals.

Keywords: Silver ore, arsenic, manganese, mercury, lead, occupational exposure

P-0190

A Case Of Lung Cancer With Chronic Occupational Exposure To Nickel And Asbestos (A Concept For Multiple Exposure)

Meşide Gündüzöz¹, Ceylan Bal², Mehmet Erdem Alagüney³, Murat Büyükşekerci⁴, Türkan Nadir Öziş⁵, Engin Tutkun⁶, Ömer Hınç Yılmaz⁷

¹Department of Family Medicine, Ankara Occupational Diseases Hospital, Ankara, Turkey

²Department of Biochemistry, Ankara Occupational Diseases Hospital,

³Department of Internal Medicine, Division of Occupational Medicine, Hacettepe University Faculty of Medicine Ankara, Turkey

⁴Department of Pharmacology, Ankara Occupational Diseases Hospital,

⁵Department of Chest Diseases, Ankara Occupational Diseases Hospital,

⁶Department of Occupational Toxicology, Ankara Occupational Diseases Hospital

⁷Department of Public Health, Yıldırım Beyazıt University Faculty of Medicine Ankara, Turkey

OBJECTIVE: Lung cancer is the leading cause of deaths from cancer in the world. Nickel is considered to be Group 1 carcinogen for lung cancer according to International Agency for Research on Cancer. This poster presents a patient with lung cancer with occupational exposure to nickel and asbestos.

Clinical Features: 43 years old male was diagnosed lung cancer. He was disassembling isolation material with content of nickel and asbestos. He used to smoke 1 package a day of cigarette for 25 years. Routine laboratory, radiologic and toxicologic analysis were ordered. The metal analysis were performed with Agilent ICP-MS. Routine laboratory workup were normal. The chest x ray revealed 5 cm diameter mass lesion in right hilus, in the distal part of the mass lesion right lung mid and lower zones showed diffuse nodular infiltration and reticulation. Thorax computer tomography showed 45 millimeters irregular lobulated shaped solid mass lesion in right infrahilar region. There was millimetric nodules alongside with peripheral interlobular septum thickening and reticular pattern in the right lung lower lobe (metastasis?, lymphangitic dissemination?). There was pleural thickening in posterior of the lower zone of right hemithorax. The abdominal sequences showed a 80 millimeters hypodense mass lesion in splenic region. The pathology of the mass lesion in the lung was non-small cell carcinoma. The toxicological analysis were in normal reference ranges but nickel was above reference level with 12 ug/L (<8 ug/L normal).

CONCLUSION: Lung cancer is one of the most important causes of cancer deaths. Occupational exposures are very important in the etiology of lung cancer. In these cases alongside with cigarette smoking these factors should be addressed in the perspective of multiple exposure and preventive actions should be taken in order to eliminate the risk due to these agents and exposed groups should be followed closely.

Keywords: Lung cancer, toxicology, metals, nickel, asbestos

P-0191

From Chronic Constipation to the Celiac Diagnosis

Hayriye Şentürk¹, Saliha Tokgöz², Selma Pekgör¹, Hümevra Yaka¹, Sule Erayman Demirbaş¹, Abdulkadir Baştürk³

¹Konya Training and Research Hospital, Family Medicine, Konya, Turkey

²Konya Training and Research Hospital, Internal Medicine, Konya, Turkey

³Konya Training and Research Hospital, Hematology, Konya, Turkey

INTRODUCTION: Celiac is an autoimmune disease of the small intestine which is triggered by the gluten containing food in patients with a genetic predisposition. It's characterized by malabsorption that is triggered with rye, wheat, barley, and oats intake because of gluten content. Here we present how the diagnosis of celiac disease is performed in an elderly patient with complaints of chronic constipation and iron-deficiency anemia.

CASE: A 71 year old female patient was admitted to the internal medicine clinic with complaints of bloating and constipation. She had constipation for a long time and had been previously received treatment due to iron deficiency anemia. Physical examination was normal except pale appearance. The laboratory assays: Hgb: 10.5 g / dL (12-17), MCV: 79.6 fl (80-96.1), Ferritin: 7.66 ng / mL (13-150), Folate: 5.72 ng / mL (3.8-16), Vitamin B12: 292 pg / mL (191- 663). Endoscopy and colonoscopy were planned to investigate the etiology of anemia. Duodenal biopsy

was taken because the view is compatible with celiac. Biopsy results came in line with celiac disease. TTG IGA:379 (0-20), TTG IGG:negative, Anti-gliadin IgA:positive, anti-gliadin IgG:negative, anti-endomysium:positive, anti-endomysium IgG:negative arrived. The patient was referred to gastroenterology after proposing gluten-free diet. DISCUSSION: Celiac disease can occur at any time during the life. It may lead to typical symptoms such as weight loss, diarrhea, abdominal pain, and nausea but also it may lead to mild or no symptoms for years in some patients. In our case with no symptoms except chronic constipation we diagnosed celiac disease while the etiology of iron deficiency anemia was investigated. As the iron-deficiency anemia due to impaired absorption is common, celiac disease should be considered in the differential diagnosis. Screening for celiac disease should be done in patients with gastrointestinal symptoms, growth retardation, delayed puberty, iron-deficiency anemia, infertility, in women who recurrent miscarriage.

Keywords: celiac disease, malabsorption, constipation

P-0192

Occupational Health Assessment and Awareness Among Firefighters

Meşide Gündüzöz¹, Murat Büyükşekerci², Ceylan Bal³, Servet Birgin İritaş⁴, Engin Tutkun⁵, Ömer Hınç Yılmaz⁶

¹Department of Family Medicine, Ankara Occupational Diseases Hospital, Ankara, Turkey

²Department of Pharmacology, Ankara Occupational Diseases Hospital,

³Department of Biochemistry, Ankara Occupational Diseases Hospital,

⁴Specialist Doctor of Toxicology, Council of Forensic Medicine, Branch Office for Ankara

⁵Department of Occupational Toxicology, Ankara Occupational Diseases Hospital

⁶Department of Public Health, Yıldırım Beyazıt University Faculty of Medicine Ankara, Turkey

INTRODUCTION

Firefighters can be exposed to toxic metals, pesticides, volatile organic compounds, polyaromatic hydrocarbons by fire fume inhalation. The major metal exposure is arsenic due to copper chrome arsenate (CCA) treated wood. As a result of exposure to fire fume lung and liver functions can be affected. Also long term exposure can lead to a wide range of known and suspected carcinogenic effects. In this study we evaluated 645 firefighters laboratory results retrospectively.

METHODS

Six hundred and forty five firefighters who applied to Ankara Occupational Disease Hospital for medical examination in 2015 were included to this study. Pulmonary function tests, toxicological analyze and radiologic imaging results were obtained from hospital database (FONET). Toxicological results were evaluated according American Conference of Governmental Industrial Hygienists (ACGIH) threshold values.

RESULTS

77 firefighters' urine arsenic levels, 3 firefighters' cadmium levels, 2 firefighters' mercury levels were higher than ACGIH threshold values. Also Hydroxypyrene levels of 2 firefighters and hippuric acid levels of 5 firefighters were higher than laboratory reference range. 21 firefighters' liver enzymes (alanine aminotransferase and aspartat aminotransferase) were above laboratory reference range. 70 firefighter have obstructive type pulmonary function disorder. We detected micro nodules in 68 firefighters' posterior-anterior lung X-ray graphics.

CONCLUSION

Firefighters are under risk of exposure to various noxious materials. So they should be examined thoroughly by clinicians concerning these risk factors. According to symptoms and signs they must be referred to specialized centers for toxicological evaluation.

Keywords: firefighters, arsenic, cadmium, mercury, spirometry, chest radiography,

P-0193

Multi-Morbidity Management in Family Medicine: A Case Report

Rahşan Bulut, Funda Ekimci Deniz, Ayşe Semra Demir Akça, Nejat Demircan, Tuğba Beyazçiçek
Department of Family Medicine, Faculty of Medicine, Bulent Ecevit University, Zonguldak, Turkey

INTRODUCTION: Comorbidity is the occurrence of a new, distinct medical condition in an individual with a chronic disease or, comorbidity is defined as occurrence of specific disease components or additional diseases apart from the investigated disease, whereas multi-morbidity is defined as co-occurrence of the diseases. The aim of the study is to elucidate the significance of multi-morbidity and co-morbidity in primary health care, and to discuss management of the patients with multi-morbidity at primary care and how to follow-up.

Case Presentation: Thirty-seven year old male patient uses metformin (Diaformin®)1000 mg 2x1 regularly for 5 years for type 2 DM. He presented with high blood glucose levels during the last month, malaise, unwillingness and depression. In the physical examination, BP was 130/70 mmHg, pulse rate was 90 bpm, body temperature was 36.5 °C, respiratory rate was 22/min. BMI was 30.5 kg/m². Among biochemical parameters; blood glucose level was 145 mg/dl, 25-Hydroxy Vitamin D was 17.4 ng/ml, HbA1C was 6.3% and VitB12 was 324 pg/ml. In addition to type 2 DM, patient had vitamin D deficiency and obesity. Vitamin D replacement treatment was initiated. Diet and exercise recommendations were made. Patient was referred to a psychiatrist for evaluation of his general depressive state.

DISCUSSION: Family physician can manage patients with multi-morbidities; they act as a conductor in primary care.. When the patient presented to outpatient clinic with diagnosis of DM, he had concurrent obesity, vitamin D deficiency and depression. A family physician who encounters many patients with comorbidities such as this case should consider patient's problems as a whole, and follow patient-oriented-holistic approach.

CONCLUSION: In order to follow up the patient with co-/multi-morbidities, the best choice is the family physician with holistic and psychosocial approach.

Keywords: co-morbidity, multi-morbidity, family medicine, continuous care, holistic, primary care

P-0194

How to deal with chronic Low Back Pain

Mara Matos Dias

Unidade Saúde Familiar Fiães, ACES ENTRE DOURO E VOUGA I - Feira/Arouca, Aveiro, Portugal

Background & AIM:

After twelve weeks of continuity, low back pain (LBP) is defined as a chronic condition, which corresponds to approximately 2-8% of all LBP. It also represents a prevalent cause of physical disability and work absenteeism, providing a high socio economic impact.

Primary care physicians are struggling to treat chronic LBP, therefore the aim of this work will be a clear and brief exposure of the latest therapeutic options in order to proceed to the most appropriate treatment for the patient concerned.

METHOD: Literature search of systematic reviews and scientific articles from Pubmed database, and Medline. Restricted to articles published between the period 2008 to 2015, in English.

Results: The general approach of the LBP should be performed in a multidisciplinary way, due to multiple mechanisms of chronic pain. The most effective recommendations are exercise and proper posture education, which requires to the patient an active role in their recovery, supervised by a physical therapist in order to, within the wide range of available interventions, select the most suitable.

Drug treatment is superior to non-pharmacological treatments, however, its side effects are greater, implying their use in a very limited time. For example, the continued use of NSAIDs and paracetamol can lead to gastrointestinal problems or renal toxicity. When these treatments fail you can apply low dose of tricyclic antidepressants. Opioids are considered the last resort drug for the treatment and only if all other treatments have failed, given the significant side effects exhibited.

Other therapies such as acupuncture, massage, and mobilization, aren't consensual and fully regulated.

Conclusions

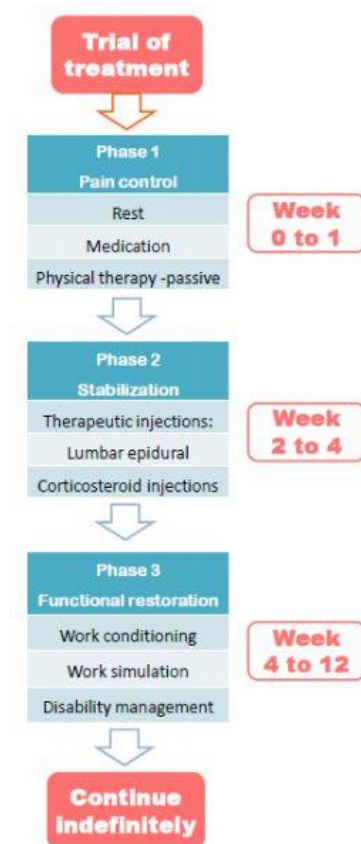
To ensure success, LBP approach must be multidisciplinary and personalized. Such strategies as exercise and postural education have proven efficacy for the treatment, which can be used in combination with pharmacotherapy in the exacerbations or as a adjunct to pain control.

Keywords: low back chronic pain; evidence-based practice; pain management;

Chronic low back pain



Treatment of chronic low back pain



P-0195

Current prevalence of major cardiovascular risk factors and coronary heart disease in a sample of Greek population

Aristofanis Gikas¹, Nikolaos Tsakountakis², Theodoros Vasilopoulos², Eleni Moreti¹, Chrysanthi Doukareli¹, Chariklia Chatziioannidou¹

¹Health Centre of Kalivia, Kalivia, Attiki, Greece

²Health Centre of Malia, Malia, Crete, Greece

Background and AIM: Cardiovascular diseases represent the leading cause of mortality and a public health economic burden. Comprehensive data regarding prevalence of coronary heart disease (CHD) and associated factors in different geographical regions are very important to our understanding of global distribution and evolution it. This study aims to assess the current situation on self-reported prevalence of conventional risk factors and CHD in Greek adult population.

METHOD: A community-based cross-sectional survey was conducted in May 2014, during an election day, among adult residents of Saronikos municipality (Attica region). Data were collected from face-to-face interviews. The study sample included 2636 subjects (men, 49.5%; mean age, 50.5; range 20-95 years), with similar age and sex distribution to the target population.

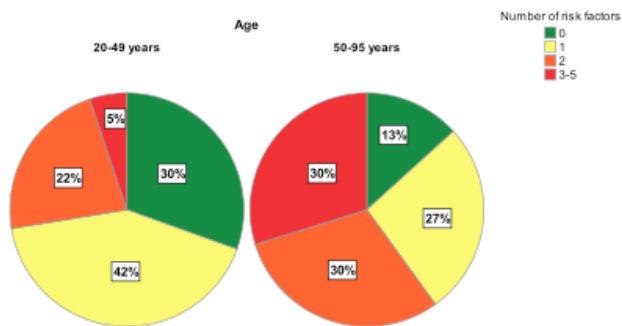
RESULTS: The age-standardized prevalence rates of five major risk factors were as follows: type 2 diabetes 11.1%, hypercholesterolemia (cholesterol>240 mg/dl or using cholesterol-lowering medication) 23.8%, hypertension 27.2%, current smoking 38.9% and physical inactivity 43%. Of the participants, only 21% were free of any of these

factors. Clustering of two to five risk factors was more frequent among persons aged 50 years and older as compared with younger ones (60% vs 27%, $P=0.000$). At the same time, the age-adjusted prevalence of CHD was 6.3% (in men, 8.9%; in women, 3.8%) and myocardial infarction 3.6% (in men, 5.2%; in women, 2.1%). According to multivariate analysis age, gender, education level, obesity, diabetes, hypercholesterolemia, hypertension and ever smoking were strongly associated with CHD.

CONCLUSIONS: Classic risk factors are highly prevalent and frequently clustered, especially in adults aged 50 years and older. These findings raise concerns about future trends of already increased rates of CHD. Consequently, more effective interventions are needed, focusing on smoking cessation, promotion of traditional Mediterranean diet and increased physical activity.

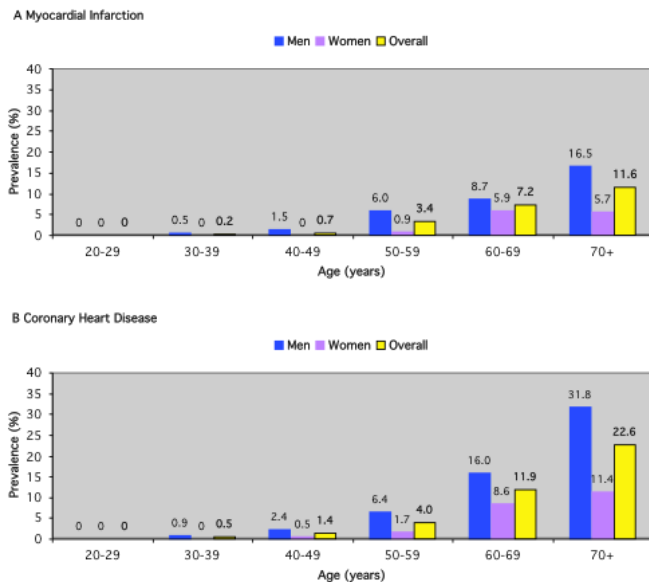
Keywords: Cardiovascular risk factors; coronary heart disease; prevalence

Figure 1. Prevalence of clustering of major cardiovascular risk factors in the age groups of <50 and ≥50 years.



Note: The 5 risk factors include diabetes, hypertension, hypercholesterolemia, smoking and physical inactivity

Figure 2. Age- and gender-specific prevalence of MI and CHD among Greek adults aged 20 years and older.



P-0196

Evolution of hypertensive patients in a family health unit. Do we make a difference?

Joana Gonçalves¹, Sérgio Aleixo¹, Ana Baptista¹, Stéphane Jorge¹

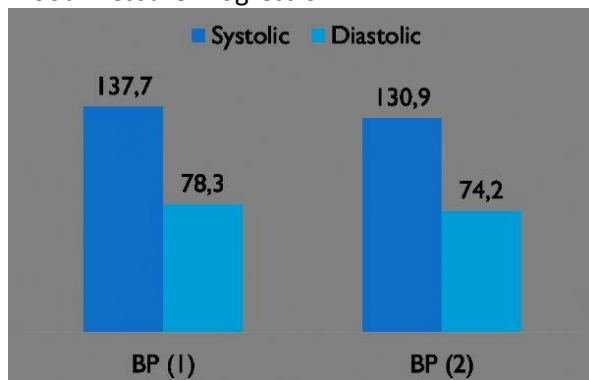
¹Familiar Health Unit Viseu-Cidade, Viseu, Portugal

²Familiar Health Unit Infante D. Henrique

Arterial Hypertension constitutes a cardiovascular risk factor with great global impact. A recent study has shown that it affects 42% of the portuguese population. Aware of this problem, there were organized specific hypertension consultations in Primary Health Care. The purpose of these consultations were blood pressure monitoring, treatment in conformity and control of other cardiovascular risk factors. This study aims to determinet if the inclusion of our patients in these consultations is reflected in a reduction of blood pressure values. Thus we performed a retrospective observational study in a Portuguese Family Health Unit in order to assess the progression of the blood pressure of a sample of patients followed in specific Hypertension program. We included patients followed for at least one year and who attend the consultations at least twice a year. The sample was then comprised 158 individuals. Then we compared the first blood pressure value at the time of the inclusion in the program with the last value of blood pressure registered. We observed a decreased in average blood pressure of 5%. Taking into account that for each percentage of blood pressure reduced the patient will benefit we consider advantageous the existence of this organized hypertension consultations.

Keywords: Arterial Hypertension, Program actions, Primary Health Care

Blood Pressure Progression



P-0197

Is It Asthma or COPD?

Muhteber Çolak¹, Olgu Aygün², Özden Gökdemir¹, Nilgün Özçakar¹

¹Dokuz Eylül University, Medical Faculty, Family Medicine Department, İzmir, Turkey

²Karabağlar, The Second Family Health Care Center, İzmir, Turkey

BACKGROUND: Asthma is characterized with reversible airway obstruction and hyper reactivity. Chronic obstructive pulmonary disease (COPD) is characterized with progressive airway obstruction and limitation in expiratory airflow. The difference among these two diseases is not always with clear boundaries. Some individuals can show properties of both asthma and COPD. This situation is called as "The asthma-COPD overlap syndrome (ACOS)". This clinic situation took place in international guidelines (GINA-GOLD); it is associated with increasing diversity in the airflow symptoms and described with an incomplete reversible airflow obstruction. ACOS patients are characterized with increased reversibility of airflow obstruction, bronchial and systemic eosinophilia and better response to the corticosteroid therapy compared to patients with COPD. ACOS patients have more wheezing and dyspnea, but cough-sputum characteristics are identical for patients with COPD.

CASE: A 45 year old female patient was admitted to pulmonary diseases clinic with shortness of breath. She has

evaluated as asthma, treated for asthma. She could not have a complete relief of symptoms and had been evaluated as COPD two years ago at a different pulmonary disease clinic. In her history she had dyspnea for 6 years, had pneumonia during childhood and had bronchitis attacks till 12 years old in winters. Our patient has no smoking history, but unfortunately there is passive smoking.

DISCUSSION: In recent years, interest for ACOS associated with asthma and COPD increased. Researches have been done based to determine the ACOS phenotype for patients. Asthma and COPD are chronic and inflammatory pulmonary diseases associated with structural changes of large and small airway. Family doctors should be careful about ACOS patients who has worse clinical situation compared to patients who has only asthma or COPD.

Diagnosis is supported with eosinophilia in diagnostic tests. Awareness and appropriate approach of physicians can avoid losing time with patients seeking diagnosis.

Keywords: asthma, obstructive pulmonary disease, asthma-COPD overlap syndrome, awareness

P-0198

Development of severe hyperbilirubinemia during the FMF attack of a patient with Gilbert's syndrome: Case report

Orkide Kutlu¹, Samil Ecirli¹, Muharrem Keskin¹, Abdulkadir Basturk¹, Sevil Fisekci Oktar¹, Sule Erayman Demirbas², Humeyra Yaka²

¹Department of Internal Medicine, Konya Training and Research Hospital

²Department of Family Medicine, Konya Training and Research Hospital

INTRODUCTION: Familial Mediterranean Fever (FMF) is characterized by attacks of fever and inflammation of serous membranes. Gilbert's syndrome is characterized by indirect hyperbilirubinemia caused by the decrease in the enzyme UDP-glucuronyltransferases. Here we present development of severe indirect hyperbilirubinemia during the FMF attack of a patient with Gilbert's syndrome.

CASE: A 21-year-old male patient was admitted with severe abdominal pain for last 2 days. He had had complaints of fever, abdomen, chest and joint pain intermittently since 17 year old. In physical examination there was a significant conjunctival jaundice. Defense and rebound was detected. Blood pressure 110/70, Fever 38°C, WBC 11.22 10⁹/L (N=3.98-10.04), fibrinogen 430 g/L (N=180-350), CRP 65.5 mg/L (N:0-5) total bilirubin 6.4 mg/dL (0.3-1.2), indirect bilirubin 6 mg/dL (0.3-1.0), LDH 278 U/L (0-248), AST 16 U/L (0-35), ALT 5 U/L (0-35). Abdomen USG was normal. Direct and indirect Coombs were negative. The patient was diagnosed as FMF and colchicine 1.5 mg / day was started. After nearly 24 hours of attack, total bilirubin and indirect bilirubin were decreased to 2.4 and 2.05 mg / dL, respectively. Detection of homozygous M680 (G> C) mutation of FMF gene was confirmed the diagnosis.

CONCLUSIONS: Mild mixed type hyperbilirubinemia (both direct and indirect) can be seen in FMF patients. In a study, total bilirubin and indirect bilirubin levels were detected up to 2.3 and 1.7 mg / dL, respectively in 41 FMF patients. In Gilbert's syndrome indirect bilirubin usually does not exceed 3 mg / dL. And as in our case, it may rarely reaches 6 mg/dL. The difficulty of diagnosis may occur in the presence of unconjugated hyperbilirubinemia higher than expected and in such conditions coexistence of multiple causes should be considered.

Keywords: Familial Mediterranean Fever, indirect hyperbilirubinemia, Gilbert syndrome

P-0199

Chronic hepatitis B and C in Raval Sud, epidemiological characterisation and prevalence in population attended: HEPACRON STUDY

Adriana James¹, Francisco Montoya¹, Marta Arcarons¹, Berta Tió¹, Oriol Vallcorba¹, Nuria De Villasante², Anna Massana³, Dani Roca¹, Isabel Plaza⁴, Francisca Panadero¹, María Teresa Fuertes¹, Josep Franch¹, Marta Sendra¹

¹Primary Healthcare Centre Raval Sud, Barcelona, Spain

²Centre for Emergency Primary Health Care (CEPHC) Manso, Barcelona, Spain

³Primary Healthcare Centre Clot, Barcelona, Spain

⁴BASIQ; Unit for Assessment, Information Systems and Quality, Barcelona, Spain

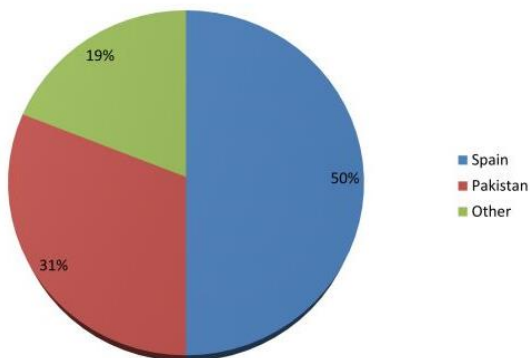
Background & AIM: The Raval Sud Primary Healthcare Centre (PHC) attends a young population (80% between 15-64 years of age), with 30% of Hindustani origin (countries endemic for viral hepatitis), a high prevalence of IDU and STI (common risk factors for hepatitis) and a low socioeconomic index (MEDEA 2.29). There are few studies of prevalence of chronic hepatitis (CH) in our region. The prevalence of CH in Spain according to ASSCAT (Catalan association of persons with hepatitis) is 3%, with an under-diagnosis of infection of more than 50%. We are amongst the high prevalence countries in the European Union (>3%). A retrospective observational study done by our research group at the Raval Sud PHC in May 2012 found a prevalence of 2.34 of CH types B and C in the adult population attended. Our aim therefore is to undertake an epidemiological characterisation of these patients.

METHOD: We have initiated a longitudinal descriptive study (3 years of follow-up). A random sample of 59 patients with CH B and/or C was selected in order to estimate a population prevalence of 2.34%. We obtain informed consent in writing from the participants, who complete a questionnaire on risk habits, are submitted to a clinical examination including a physical, and subsequently undergo blood work and abdominal ultrasound.

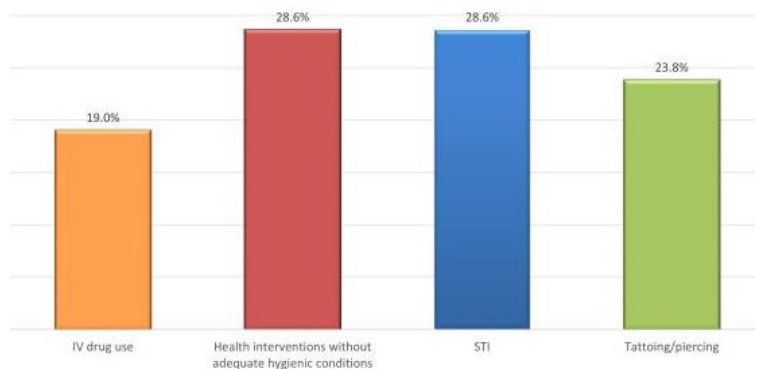
Results and CONCLUSIONS: Project currently underway. 26 patients with CH C were recruited in the first phase, not having yet reached the required sample size. In this paper we describe the characteristics of the patients thus far: 65.4% men; average age: 55 years; 38% present positive serology for hepatitis without a history of inoculation; 28.6% STI (43% syphilis). Of note is the contribution of abdominal ultrasound to the descriptive study: 50% present hepatic steatosis of which 62% was not previously detected.

Keywords: Chronic hepatitis B, Chronic hepatitis C, epidemiologic study

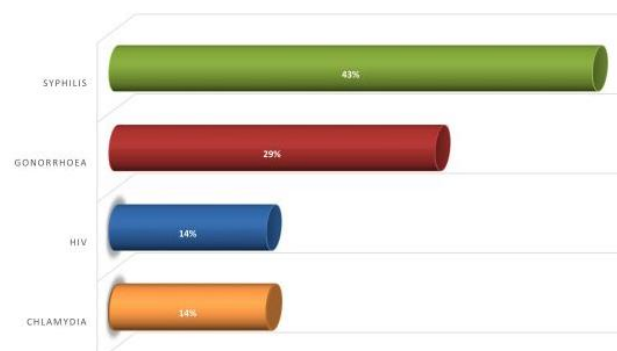
Patient origin



Risk factors



Types of STI



P-0200

Chronic viral hepatitis and diabetes mellitus, an emerging association. HEPCRON cohort study

Adriana James¹, Francisco Montoya¹, Marta Arcarons¹, Berta Tió¹, Oriol Vallcorba¹, Nuria De Villasante², Anna Massana³, Dani Roca¹, Isabel Plaza⁴, Francisca Panadero¹, María Teresa Fuertes¹, Josep Franch¹, Marta Sendra¹

¹Primary Healthcare Centre Raval Sud, Barcelona, Spain

²Centre for Emergency Primary Health Care (CEPHC) Manso, Barcelona, Spain

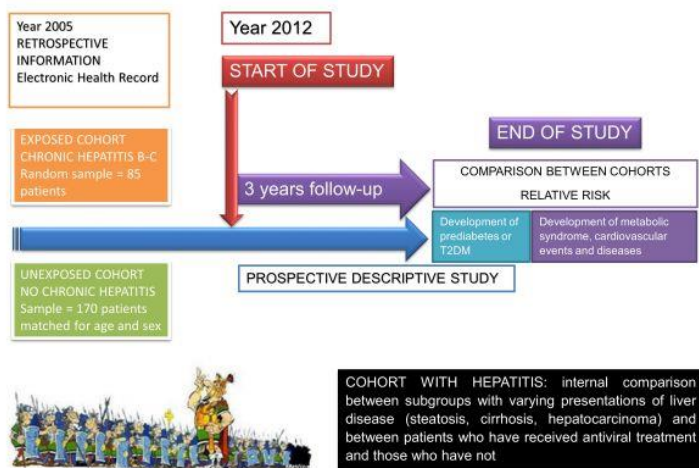
³Primary Healthcare Centre Clot, Barcelona, Spain

⁴BASIQ; Unit for Assessment, Information Systems and Quality, Barcelona, Spain

Background & AIM: Chronic hepatitis (CH) constitutes a global health problem with long-term health consequences (liver cirrhosis, liver failure and hepatocellular carcinoma). There is evidence that CH C is a risk factor for the development of insulin resistance and type 2 diabetes mellitus (T2DM); the role of type B is as yet unclear. In a previous observational study (done by our research group at the Raval Sud Primary Healthcare Centre in 2012) we found the prevalence of T2DM to be three times greater among adult attended patients with CH compared to those without (prevalence ratio=3.02, p <0.00001). No significant differences were observed between CH B and C. Our aim is to analyse the association between CH B and C, and prediabetes and T2DM. **METHOD:** A retrospective cohort study (11 years follow-up) was done by carrying out a search of the electronic health record for diagnostic, follow-up and control parameters of CH B and C, prediabetes and T2DM recorded since 2005. Exposed cohort: adults attended with a diagnosis of CH B and/or C. Random sample of 85 patients. Unexposed cohort: adults attended without CH. Sample of 170 patients individually matched for age and sex. Study initiated in 2013 and prospective follow-up of patients for 3 years. Intervention: participants complete a questionnaire on risk habits, a clinical examination including a physical, blood work and abdominal ultrasound. **Results and CONCLUSIONS:** Required sample size not yet reached. To date we have recruited 36 patients: 26 with CH C, 3 with CH B and 6 from the unexposed cohort (2 being intention-to-treat). 27% of CH C patients developed prediabetes or T2DM after 7.9 mean years compared with 17% of the control group. None of the 3 CH B patients developed prediabetes or T2DM. These results, though tentative, lend support to the hypothesis of our study.

Keywords: Chronic hepatitis C, Diabetes mellitus, Insulin resistance

Study design



Characteristics of groups

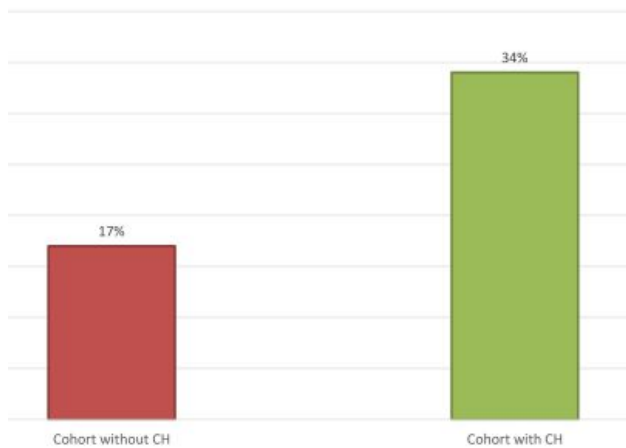
Group	Sex (% men)	Age (mean and SD)	Years since diagnosis (mean and SD)
Unexposed (healthy) cohort	50	54.6 (13.15)	--
Patients with CH B	100	49.1 (10.93)	15.1 (9.4)
Patients with CH C	58	56.2 (12.95)	13.1 (11.2)

Relationship of waist to height ratio (WHtR) with diagnosis

WHtR	Mean and SD
Patients with CH C without T2DM nor prediabetes	0.55 (0.098)
Patients with CH C and prediabetes	0.59 (0.000)
Patients with CH C and T2DM	0.66 (0.099)

Biometric index which predicts the risk of developing diabetes and cardiovascular disease. A WHtR of over 0.5 is critical and signifies an increased risk. The WHtR is higher in patients with CH C and T2DM vs patients with CH C without prediabetes or T2DM.

Cases of prediabetes and diabetes mellitus Type 2 according to cohort



Relative risk = 2.06 (95% CI, 0.32-13.26; p=0.37). The preliminary results lend support to the hypothesis of our study but statistically significant results have not yet been obtained having not yet reached the required sample size. Average length of time between the development of CH and T2DM: 13.33 years

P-0201

case report: uncontrolled type 2 diabetes and hypertension

Ege Özince, Mehmet Ziya Gencer, Seçil Arıca

department of family medicine, okmeydanı eğitim ve araştırma hastanesi, istanbul, turkey

58 years old, a male patient, retired officer;

He has diagnosed with type-2 diabetes in 1989 and oral-anti diabetic drug has been begun.

Long years, patient has come to control irregular in terms of diabetes.

Patient's diagnosed with hypertension in 1998 and salt-free diet was recommended to the patient

Patient hasn't come to control for long years.

He smoke for 44 pack/year, he doesn't use alcohol.

He was admitted to the emergency department because of increased swelling in the legs, intermitant kladikasyo, shortness of breathe fort he last 6 months.

Weight:85 kg, Height:1.75 m.

TA:155/100, tachycardia, orthopnea, tachypnea,

S2 hard, ventricular gallop rhythm.

Bilateral basal crackles in the lung.

Positive godet 2-3 in the bilateral legs edema available.

Hb:11.4 mg/dl Creatinin:3 mg/dl BUN: 43 mg/dl Na:136 mEq/dl

K:4,1 mEq/l Glucose:383 mg/dl HbA1c:% 11.7 Albumin:3,1 total

Cholesterol:137 mg/dl Triglycerides:100 mg/dl

LDL:86 mg/dl HDL:31 mg/dl

Urine Analysis; Density:1009 pH:5.5 Protein:100 mg/dl Glucose:50 mg/dl

24 hour urine sample; Proteinuria: 3410 mg/gün

24 hour urine output: 1200 ml

(PA) Chest-X-ray filmed in emergency, detected increased cardiothoracic ratio,
In thorax CT detected existing bilateral pleural effusions.

EKG; the changes have seen; in which will be compatible with left ventricular ischemia.

ECHO; EF:37%, grade 2 mitral regurgitation, left ventricular hypertrophy, left ventricular wall hypokinesia.

The diuretic treatment was started to the patient. In addition to beta-blocker therapy by the patient receives, ACE-inhibitor was started. The patient whose pre-tibial edema, pleural effusion regressed, shortness of breath got better; TA reached 120/75 mmHg. Oral-antidiabetic drugs have been cut because of insulin treatment was started. The patient whose GFR calculated 32.27, has been evaluated as stage 3 renal failure. Nephrology control has been proposed to the patient. Patient was invited regular policlinic control to family doctor for 3 months period.

Keywords: diabetes, hypertension, renal failure

P-0202

Clinical phenotypes of Chronic Obstructive Pulmonary Disease in Primary Care

Eulalia Borrell¹, Teresa Rivera¹, Mger Shafrazym¹, Javier Mezquiriz¹, Nuria Montella¹, Jordi Forcada¹, Eva Muñoz¹, [Maria Teresa Alzamora](#)²

¹Primary Healthcare Centre Sant Roc, Catalan Health Institute

²Primary Healthcare Centre Riu Nord-Riu Sud, Catalan Health Institute

BACKGROUND AND AIMS: COPD is a heterogeneous disease. In 2012 the Spanish guide GESEPOC classified patients in 4 distinct phenotypes, allowing a better individualized treatment.

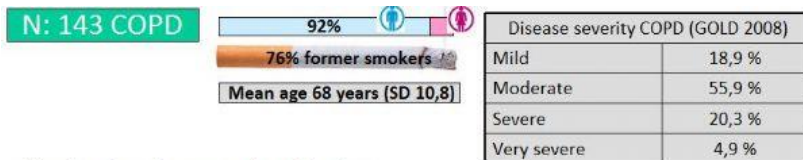
The aim of our study was to classify by phenotypes and severity COPD patients attended in two primary care centers.

METHODS: We performed a cross-sectional retrospective clinical study in 2012. We reviewed primary care and in-hospital clinical charts of all smoker or former smoker COPD patients (FEV1/FVC<70%). We measured disease severity (GOLD 2008) and classified patients in 4 phenotypes: non exacerbator, overlap COPD-asthma, exacerbator-emphysema and exacerbator-chronic bronchitis following the GESEPOC criteria. The exacerbator patient is characterised by the presence of, at least, two exacerbations the previous year.

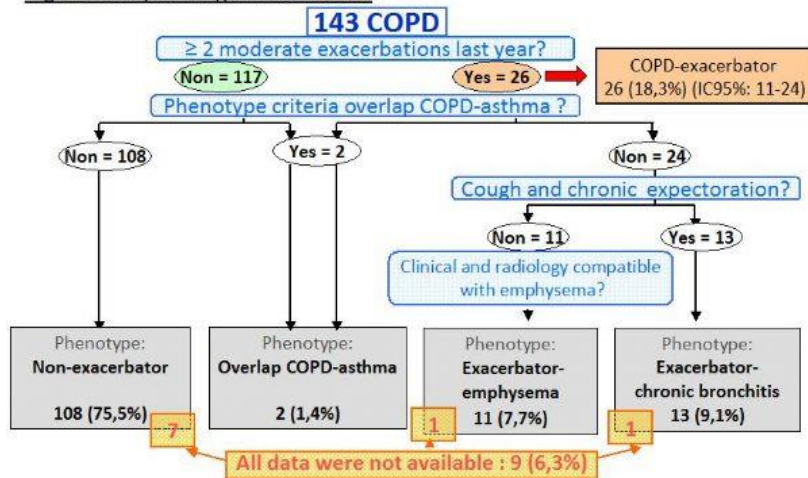
RESULTS: We included 143 COPD patients, 92% male and 76% former smokers. Severity was mild in 18,9%, moderate in 55,9%, severe in 20,3% and very severe in 4,9%. 26 patients (18,3%) were exacerbator patients. They were classified in: non-exacerbator 108 (75,5%), overlap COPD-asthma 2 (1,4%), exacerbator-emphysema 11 (7,7%) and exacerbator-chronic bronchitis 13 (9,1%). We can not classify 9 patients (6,3%) because all data were not available.

CONCLUSIONS: We found similar rates of exacerbators or patients with positive bronchodilator test than previously reported. The absence of some variables, specially related with asthma or atopia, may be produced an over classification in the non-exacerbator group. A good classification of patients and the knowledge of peculiarities of the different phenotypes will allow us to implement a better and more personalized treatment of COPD patients.

Keywords: Primary Care, Chronic Obstructive Pulmonary Disease, Phenotypes



Algorithm for phenotype classification:



P-0203

A case of cryptogenic liver cirrhosis developed on the ground of occult Hepatitis B

Mukaddes Pekgenç Abatay¹, Yusuf Üstü¹, Basri Furkan Dağcıoğlu¹, Aylin Baydar Artantaş², Mehmet Uğurlu¹

¹Department of Family Medicine, Yıldırım Beyazıt University, Ankara, Türkiye

²Department of Family Medicine, Atatürk Training&Research Hospital, Ankara, Türkiye

CASE

78 years old woman attended to gastroenterology outpatient clinic with the complaints of abdominal distension and constipation. Overall situation of the lady was intermediate, she was orientated and cooperating. In the examination of vital signs, fever was 36,5 °C, BP: 120/80 mmHg, pulse:98/min, Weight:77 kg, waist circumferens:117cm. In physical examination, abdomen was visibly distended, percussion showed generalized dullness and Traube zone was closed. Both feet dorsum had edema and bilateral pretibial edema (++/++) was observed. In abdominal ultrasound, generalized ascites was observed and the patient was followed for investigating the etiology. In blood analysis, AST:37 ALT:15 GGT:25 ALP:111 Total Bilirubin:0,8 Direct bilirubin:0,4. In Serologic analysis; Anti HBsAg:2.88(negative) Anti HBe:1.03(negative) Anti HBcIgM:0.1(negative) HBsAg:0.5(negative), Anti HBe (IgG)Total:0,004(positive),Anti HCV: negative, Anti HIV: negative, HBeAg:0.094 (negative) and HBV DNA:3,73*10 copy/ml. Cryptogenic liver cirrhosis developed on the ground of occult hepatitis B diagnosed in the light of the findings.

DISCUSSION: Occult Hepatitis B is defined as; detecting HBV DNA(+) in blood or tissues while HBsAg is negative (except window period) usually accompanied by anti HBs(+) or anti HBe IgG (+) antigens. OHB can develop by decreasing of HBsAg to unmeasurable levels after long years of HBV carriage. It is known that OHB may cause HBV transmission by blood transfusions. Transmission by organ transplantation or perinatal way is also possible. Even the new techniques on HBsAg measurement, it is still misleading to use it as a marker for HBV infection in some cases. Apart from HBV transmission by blood transfusion, OHB should be remembered in ALT elevated patients with unknown etiology, cryptogenic liver diseases, liver transplantation donors and hemodialysis patients. While screening of anti-HBe seems to be cost effective in blood transfusions or organ transplantations, screening all the cases with PCR should be recommended by becoming inexpensive of PCR in the future.

Keywords: occult hepatitis B (OHB), cryptogenic liver cirrhosis

P-0204

Primary Hiperaldosteronism: Case Report

Ahmet Ünal¹, Yunus Gürel¹, Engin Güney², Hatice Özer²

¹Department of Family Physician, Adnan Menderes University, Aydın, Turkey

²Department of Endocrinology, Adnan Menderes University, Aydın, Turkey

INTRODUCTION

Hypertension (HT), showing a high prevalence in the whole world, is a major public health problem that increases the risk of cardiovascular and cerebrovascular disease. In 2025, 1.5 billion people are affected by hypertension on the world. Also, it ranks as the foremost cause of death in the world. Identified in approximately 5% of patients with hypertension can show a reason, that is called secondary hypertension. We present a case of primary hiperaldosteronism were being overlooked in primary care.

CASE REPORT

A 63-year-old man with an 8-year history of hypertension, which had previously been moderately controlled with several classes of antihypertensive drugs. The patient was admitted to the emergency room of our hospital with complaints of weakness in his left hand 3. 4. and 5. finger, the complaints started yesterday. He was using nebivolol 5 mg and amlodipine 10 mg. His blood pressure was 200/120 mmHg with hypokalemia (2.1 mmol/L). He did not have any history of weakness or numbness due to hypokalemia. Venous blood gas pH: 7.46. Glycerol trinitrat was given with IV infusion for hypertension. His plasma aldosterone concentration (PAC) was elevated (122 ng/dl; reference value, 3.6 to 24.0) with suppressed plasma renin activity (1.7 ng/ml/h; reference value, 0.3 to 4.2), PAC/PRA: 71.76. Abdominal CT scanning showed nodular increase in thickness in the left adrenal gland. 14 mm thick was measured in the adrenal glands. Abdominal MR showed adrenal myelolipoma. Medical treatment was planned, because it's not adenoma. His treatment with spironalacton 2 x 100 mg was continued. In follow-up, blood pressure and potassium was measured in normal range.

CONCLUSION

In primary care, be careful about the causes of secondary hypertension which can be treated.

Keywords: primary hiperaldosteronism, hypertension, primary care, hypokalemia

P-0205

Prevalence and assesement of hypersexual disorder in primary health care

Erik Lindqvist, Lena Nordeman

FoU centrum Södra Älvsborg, Västra Götalandsregionen, Sweden

Background & AIM: There is a lack of knowledge about the number of patients consulting for and/or discussing the problems that can be characterized as hypersexual disorder (HD) with healthcare providers in primary care. Through a comprehensive survey including all persons within three professions in a geographical area, the study will describe the proportion of those health care professionals who encountered patients with the problem, and with good probability present the degree to which profession, gender and working years/experience can explain if one encountered patients with the problem or not. It will also bring to light how the problem is assessed.

METHOD: Cross-sectional study, web-based questionnaire.

All general practitioners, psychotherapists and district nurses in primary care within the region of Västra Götaland, Sweden will be invited to participate by e-mail. The e-mail will contain information about the study and a link to a web-based questionnaire including eight items.

Data will be analyzed and presented descriptively. Logistic regression will be used to analyze the association between participants answering that they had encountered patients with the problem (1) or not having encountered patients with the problem (0) as the dependent variable and the profession; physician (1) other professionals (0), sex and work experience as explanatory variables.

Expected RESULTS: This study aims to provide knowledge about the prevalence of HD among patients consulting primary care and will provide insights about the intervention being offered. In time the results will hopefully have an impact on the awareness of the problem and the development of history taking and how the history reveals symptoms consistent with HD.

Keywords: Hypersexual Disorder, Primary Care, Cross-sectional study

6Brain



Region VGR



REGION
VÄSTRA GÖTALAND

R&D Primary Health Care Center of Clinical Education in Family Medicine.

Praktikertjänst



Praktikertjänst

P-0206

COPD patients know the proper use of inhalation devices?

Hector Leonardo Lugo Ramos, Jose Maria Fernandez Gonzalez, Rocio Lobato Martinez
Hospital Jerez de la Frontera - Cadiz

OBJETIVES

Evaluate the use of inhaled therapy in COPD patients of a Health Center: What inhalers are easier to handle and if the technique It is properly explained by the family doctor and understood by the patient.

MATERIAL AND METHODS

Survey of 150 patients diagnosed With COPD Treated With different devices(pressurized metered dose, single-dose dry powder multidose dry powder and spray without Propellants). The survey collected age and sex, type of device, if there was an explanation for His medical technique in the prescription medication and Which of them find it Easier to apply.

RESULTS

The survey shows male patients 68.7 +/- 8.3 years of age profile. It shows that in 51.9 % of cases the patient has not received explanation technical by their doctor or not well understood.Among the devices easier application is in first place pressurized metered dose device (61.3%), followed by Breezhaler (36.5%) and the Easyhaler (2.2%). 39.5 % of those using the pressurized system makes with Inhalation chamber. It notes that 25.4 % of patients abandoned treatment occasionally by difficulties in implementing the product.

CONCLUSION

Most COPD patients are elderly and need simple systems for easy application. They require time in the query to the explanation of the technique that the treatment is effective and reduce exacerbations and especially because adherence to treatment will be improved. Nearly a third has left the therapy device difficulties.

Keywords: Pulmonary Disease, Chronic Obstructive, Metered Dose Inhalers, Primary Health Care
Inhalation Devices



P-0207

The role of rehabilitation (motivation) on patient recovery after hypoxic brain damage caused by epi status

Vesna Tabak¹, Damir Tabak², Mladenka Vrcic Keglevic³

¹Family Practice „Dr. Vesna Tabak“, Brescenskog 3, 10 000 Zagreb, Croatia

²University of Zagreb, Salata 3, 10 000 Zagreb, Croatia

³Foundastion for the Developmnet of Family Practice, Cresnnjevec 32, 10 000 Zagreb, Croatia

INTRODUCTION: Besides headache, epilepsy is the most common neurological disease. The aim of this paper is to present the role of the patient and his family in a long term rehabilitation after hypoxic brain damage.

CASE: During a travel, a 34-year patient was found uncouncious in a hotel. The patient recieved CPR, was hospitalized for a month and being in coma for three weeks. The cause of the epileptic attack wasn't found. During hospitalization many complications ocurred: rabdomyolysis, acute kidney failure treated by hemodialysis, liver function impairment and a bilateral pleural effusion. The effusion was drained during which the intercostal artery ruptured caused hematothorax accompanied with asistoly and five minute resuscitation. The MRI findings described bilateral hypoxic lesions in the upper frontal lobe and cortically. After he awoke from the coma he was hospitalized in Zagreb for two and a half months during and he was treated with antiepileptics. After being discharged the patient was orientated in time and space with ataxic, impaired walk, as well as periodical involuntary movements. The speech was disartric and the sight was weakend and blurred. Rehabilitation began in the hospital, contiuned at home and then in physical therapy facility. He recieved physical, speech and sight therapy. Two years later he returned to work. He has a mild leftsided hemiparesis with normal walk. His speech is somewhat slower but normal as well as his sight. He is on antiepileptics even though the primary epilepsy cause remained unknown. He got married and fathered a boy in 2013.

CONCLUSION: This is a case report of the patient in who's successful recovery the crucial role had his personality and family. He's an example where the primary care physician should apply the bio-psycho-social approach, use not only medical, but every other patient's abbility in achiving the goals.

Keywords: epilepsy, hypoxic brain damage, rehabilitation, bio-psycho-social, family practice

Doctor's room



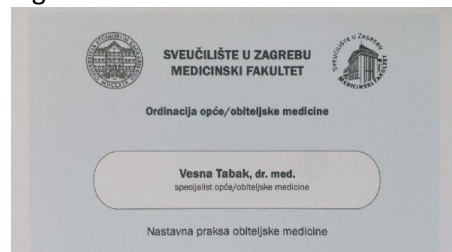
Family practice Dr Vesna Tabak



Nurse' room



Sign on the door



P-0208

A Case Report of Diffuse Panbronchiolitis Diagnosed within 6 Months in Southern Taiwan

Lee Meng Tse¹, Ou Ling Chun¹, Lin Chi Cheng², Lin Chao Li¹, Chou Hsin Tan¹, Tung Chih Kang¹, Tseng Hsu Hung¹

¹Department of Family Medicine, Antai Medical Cooperation Tien Sheng Memorial Hospital, PingTung, Taiwan

²Department of Chest, Antai Medical Cooperation Tien Sheng Memorial Hospital, PingTung, Taiwan

Background & Aim

Diffuse panbronchiolitis (DPB) is a kind of progressive obstructive lung disease of unknown etiology. It always takes one to four years in average to diagnose DPB since onset of symptoms from literature review. We presented an experience about diagnosing the 62-year-old female patient with advanced stage of typical DPB within 6 months in southern Taiwan.

Method

The 62-year-old female visited for chronic productive cough, recurrent wheezing, rhinorrhea and breathlessness. After history taking and thorough physical examination, white blood cell with differential count and arterial blood gas were checked. Chest x-ray, acid-fast stain and sputum culture were checked for ruling out pulmonary tuberculosis infection. Arrangement of pulmonary function test was for dyspnea, follow-up of treatment effect, and high resolution computed tomography for ruling out interstitial lung diseases and malignancy. Ear-Nose-Throat specialist was also consulted.

Results

DPB was diagnosed because of fulfilling the 1st, 2nd, 3rd, 4th and 5th criteria of DPB, showed as following: (1) Persistent cough, sputum and exertional dyspnea (2) History of chronic sinusitis (3) Bilateral diffuse small nodular shadows on plain chest x-ray or centrilobular micronodules on chest computed tomography (4) Coarse crackles (5) FEV1/FVC < 70% and PaO2 < 80mmHg (6) Titer of cold hemagglutinin ≥ 64. The patient clinically improved by erythromycin treatment thereafter not only symptoms relief but also improvement of pulmonary function test and chest x-ray.

Conclusions

DPB mainly occurs in East Asia and sporadic case reports in Western countries. The prevalence rate is 11 per 100,000 populations among the Japanese. The prognosis was poor, with 5- and 10-year survival rate of 62.1 and 33.2%. Long-term therapy with macrolide antibiotics resulted in clinical significant improvement. This was the first patient diagnosed within 6 months in Southern Taiwan. The earlier diagnosis of DPB, the better prognosis in such kind of patient is.

Keywords: Diffuse panbronchiolitis, Asthma, Erythromycin

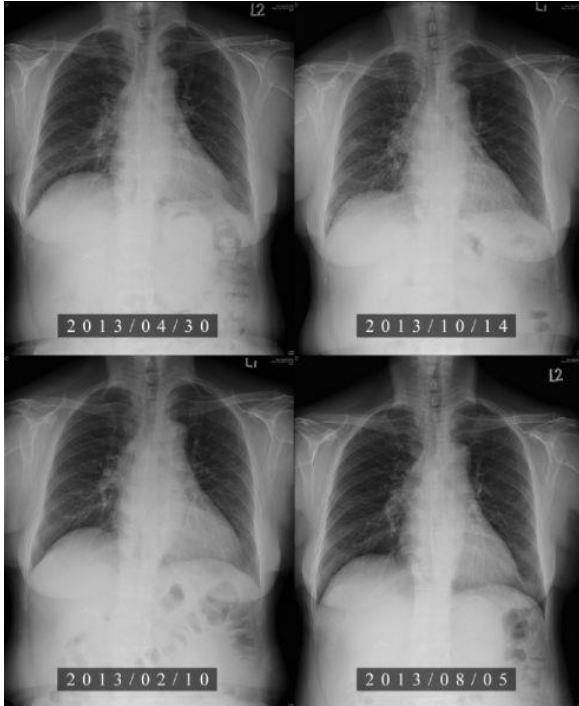
Clinical sequence diagram: series studies & treatment course

OPD date	Symptoms	Key series Studies	Assessment
2013/04/30 <small>Chest OPD</small>	Copious productive cough, sneezing, rhinorrhea, DOE, wheezing	Allergy test: mite (weak positive) CXR: Infiltration of left lower lungs, bilateral peribronchovascular thickening HRCT: bronchiectasis with tree-in-bud, infiltrations on both lungs PFT: severely restrictive ventilatory impairment, FEV ₁ : 1.01L (60.8%)	Asthma, exacerbated Suspected TB, ILD is less likely → sputum culture 3 sets
2013/05/02 <small>Chest OPD</small>			
2013/05/09 <small>Chest OPD</small>	Recurrent difficult breathing still cough and rhinorrhea	3 sets AFS/TB culture: negative	R/O TB infection Asthma, partial control
2013/07/29 <small>Chest & ENT OPD</small>	Rhinorrhea worsen	ENT referral Nasal discharge culture: <i>Pseudomonas species</i>	Chronic sinusitis
2013/10/14 <small>Admission</small>	Exacerbation of dyspnea Cough with mucoid sputum Sneezing and marked rhinorrhea Wheezing and crackles	CXR: patch infiltrations over right lung, bilateral peribronchovascular thickening HRCT: bronchiectasis, bronchiolectasis, with tree-in-bud infiltration on both lungs Sputum culture: <i>Ps. Aeruginosa</i> (heavy) 3 sets AFS/TB culture: negative Eosinophil count: 0% ENT endoscope: mucopus over bilateral middle and inferior meatus PaO ₂ : 78.9mmHg	Community-acquired PN → Anti with Gemifloxacin Asthma with AE → SABA + corticosteroid → shift to Levofloxacin → R/O TB infection → HOB is less likely → Chronic sinusitis Revised diagnosis: DPB → Add on erythromycin
2013/10/22 <small>Discharge</small>			
2014/01/08 <small>Chest OPD</small>	Seldom breathless Less cough and rhinorrhea	PFT: FEV ₁ : 1.06L (62%) CXR: peribronchovascular infiltration, reduced	Diffuse panbronchiolitis Asthma, total control
2014/08/18 <small>Chest OPD</small>	No more breathless little cough and rhinorrhea	PFT: FEV ₁ : 1.64L (98.8%) CXR: peribronchovascular infiltration, fadeout	Diffuse panbronchiolitis Asthma, total control

Follow-up of pulmonary function test

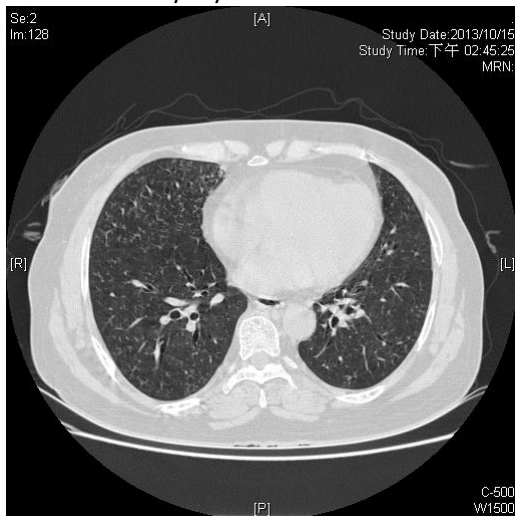
Pulmonary function test			
PFT / Test date	2013/05/02	2014/01/08	2014/08/18
FVC (% PRED)	1.27L (56.4%)	1.09L (47.8%)	1.90L (84.4%)
FEV ₁ (%PRED)	1.01L (60.8%)	1.06L (62%)	1.64L (98.8%)
FEV ₁ /FVC (%PRED)	79.53% (104.7%)	97.25% (128%)	86.32% (113.6%)
Erythromycin treatment since Oct, 2013			

Follow-up of series chest x-ray



DPB was diagnosed and on Oct, 2013; then erythromycin treatment started and continued for nearly 8 months. Series chest x-ray revealed significant improvement of infiltration on both lungs.

HRCT on 2013/10/15



bronchiectasis, bronchiolectasis, with tree-in-bud infiltration on both lungs

P-0209

{The Process of Accepting the Diagnosis of a Chronic Illness}

Saliha Şahin, Saliha Serap Çifçili, Yeliz Özendi, Kübra Nur Demir
Department of Family Medicine, Marmara University, İstanbul, Turkey

It's established that, when a person face the diagnosis of a chronic disease, he/she can go through the stages for mourning of Kubler Ross (shock, denial, anger, bargaining, withdrawal – depression, acceptance). Lacroix and Assal also described two other stages named; obedience and pseudo-acceptance. If one of these stages prolongs, the process of treatment adherence may delay as well. Non-compliance to diet and insulin injections in patients with type 2 diabetes is well-defined in the studies.

With a case report, we want to open discussion about the effects of prolonged treatment non-compliance process in chronic diseases. The case is a 59-year old female with type 2 diabetes, diagnosed 10 years ago. She has presented with Herpes Zoster infection, has had hypertrophic lichen planus lesions on both feet and autonomic neuropathy symptoms, presented with urinary incontinence. Fasting blood glucose was 329 mg/dl and also had cataract operation. She expressed that she did not want to use insulin injections. More importantly, although many years had passed since the first diagnosis, she was still questioning why she has had this illness. After two appointments, fasting blood glucose levels were regulated. However, she did not come to her follow-up visits. What kind of approach do you recommend in such patients?

Keywords: type-2 diabetes, Kubler Ross, treatment non-compliance, pseudo-acceptance

Herpes Zoster Infection



Hypertrophic Lichen Planus



Hypertrophic Lichen Planus



P-0210

Relationship Between Red Cell Distribution Width and Mean Platelet Volume with Rheumatoid Arthritis

Lutfullah Cakir¹, Gulali Aktas², Oznur Berke Mercimek³, Ozgun Enginyurt¹, Yasemin Kaya⁴, Kutsal Mercimek⁵

¹Department of Family Medicine, Ordu University Faculty of Medicine, Ordu, Turkey

²Department of Internal Medicine, Abant Izzet Baysal University Faculty of Medicine, Bolu, Turkey

³Department of Physical Therapy and Rehabilitation, State Hospital, Ordu, Turkey

⁴Department of Internal Medicine, Ordu University Faculty of Medicine, Ordu, Turkey

⁵Department of Internal Medicine, State Hospital, Ordu, Turkey

BACKGROUND & AIM: The aim of this study was to investigate the correlation between rheumatoid arthritis (RA) and mean platelet volume (MPV) and red cell distribution width (RDW), which are parameters of routine hemogram tests, that are suggested to be related with inflammation.

METHODS: We included 81 patient with RA in this retrospective study. Control group was consisted of 80 healthy subjects admitted to our instutation for a routine check up. White Blood Cell Count (WBC), Hemoglobin (Hb), RDW, Platelet Count (PLT) and MPV values of the participants obtained and analyzed.

RESULTS: We found that, RDW and MPV values were significantly diffrent in patients with RA compared to control subjects.

CONCLUSIONS: We think that, MPV reduction and RDW elevation is associated with RA. However, prospective studies with larger population are needed to reveal the relationship between the disease activity and RDW and MPV.

Keywords: Rheumatoid Arthritis, RDW, MPV

Characteristics and data of study population

		RA GROUP	Control Group	P
Gender	Men (n)	17	27	0.07
	Women (n)	64	53	0.07
		Median (min-max)		
Age (Years)		53 (16-95)	57.5 (28-81)	0.71
WBC (k/mm ³)		7.9 (2.3-9.6)	6.8 (4.4-14)	0.07
Hb (g/dl)		12.7 (11-16.5)	13.2 (10.8-14.7)	0.13
RDW (%)		13.8 (12-18)	13.7 (10.2-15.2)	0.04
PLT (k/mm ³)		258 (131-689)	260 (109-509)	0.83
MPV (fl)		8 (5.2-14.2)	8.9 (6.9-16.4)	< 0.001

P-0211

The evaluation of Bone mineral Density in Thalassemic Patients

Esra Akyüz Özkan¹, Zeynep Tuba Özdemir², Ayşe Neslin Akkoca³, Halil İbrahim Serin⁴, Meral Ekim⁵, Hakan Oğuzhan⁶, Ebru Sivaslıoğlu⁷, Fatma Gökşin Cihan⁸

¹Esra Akyüz Özkan, Department of Pediatrics, Bozok University Medical Faculty, Yozgat Turkey

²Zeynep Tuba Özdemir, Department of Internal Medicine, Bozok University Medical Faculty, Yozgat Turkey

³Ayşe Neslin Akkoca, Hereditary Blood Disease Center, İskenderun State Hospital, Hatay, Turkey

⁴Halil İbrahim Serin, Department of Radiology, Bozok University Medical Faculty, Yozgat Turkey

⁵Meral Ekim, Department of Biochemistry, Bozok University Medical Faculty, Yozgat Turkey

⁶Hakan Oğuzhan, Department of Physical Therapy and Rehabilitation, İskenderun Private Palmiye Hospitals, Hatay, Turkey

⁷Ebru Sivaslıoğlu, Hereditary Blood Disease Center, İskenderun State Hospital, Hatay, Turkey

⁸Fatma Gökşin Cihan, Department of Family Medicine, Necmettin Erbakan University Medical Faculty, Konya, Turkey

AIM: Osteopathies are an important cause of morbidity in thalassemia major (TM). We aimed to evaluate osteopathy in thalassemia and biochemical indices and to emphasize the precautionary measures or awareness in the early diagnosis of osteoporosis.

METHODS: 37 TM patients (18 female, 19 male) were included in the study. Bone mineral densitometry (BMD) was determined using dual energy X-ray absorptiometry from lumbar vertebrae. Z scores of; <-1 Normal, -1-2 osteopenia, > -2 was considered as osteoporosis.

RESULTS: The mean age was 15.48 ± 6.96 (5-33) years. 9 patient's Z scores (24.3%) were normal, 5 of osteopenic (13.5%), 23 patients were osteoporotic (62.2%).

In osteoporotic group following parameters were high; ALP in 6 patients (16.2%), AST in 5 patients (13.5%), ALT in 8 patients (21.6%), TSH in 2 patients (5.4%), fT4 in 6 patients (16.2%), fasting blood glucose in 4 of (10.8%), ferritin in all. Ca and P values were normal in all. PTH was low in 2 patients (5.4%), vitamin D deficient in 12 (32.4%) of. Lumbar BMD was positively correlated with age (r = 0.696 p = 0.000), height (r = 0.822 p = 0.000), weight (r = 0.852 p = 0.000), BMI (r = 0.725 p = 0.000), negatively correlated with ALP (r = -0.565 p = 0.006) and AST (r = 0.494 p = 0.014).

In osteopenic group; vitamin D deficient in 2 patients (5.4%) and other biochemical parameters were found normal. Lumbar BMD was positively correlated with age (r = 0.951 p = 0.013), weight (r = 0.916 p = 0.029) and BMI (r = 0.932 p = 0.021), negatively correlated with ferritin levels (r = -0.906 p = 0.034).

CONCLUSION: Osteopathy rates were high in TM. Measure of BMD and metabolic profile during routine follow-up of TM patients and early treatment will reduce complications.

Keywords: Bone mineral density, osteoporosis, Thalassemia Major

P-0212

Evaluation of Peripheral Lymphadenopathy with Excisional Biopsy; Six-Year Experience

Esra Akyüz Özkan¹, Ceren Canbey Göret², Zeynep Tuba Özdemir³, Serdar Yanık⁶, Nuri Emrah Göret⁴, Meryem Doğan⁷, Fatma Gökşin Cihan⁸, Ayşe Neslin Akkoca⁵

¹Department of Pediatrics, Bozok University Medical Faculty, Yozgat Turkey

²Department of Pathology, Haydarpaşa Numune Training and Research Hospital, Istanbul, Turkey

³Department of Internal Medicine, Bozok University Medical Faculty, Yozgat Turkey

⁴Department of General Surgery, Kartal Dr. Lutfi Kırdar Education and Research Hospital, Istanbul, Turkey

⁵Department of Family Medicine, İskenderun State Hospital, Hatay, Turkey

⁶Department of Pathology, İskenderun State Hospital, Hatay, Turkey

⁷Department of Pathology, Atatürk University School of Medicine, Erzurum, Turkey

⁸Department of Family Medicine, Necmettin Erbakan University Medical Faculty, Konya, Turkey

BACKGROUND: Lymphadenopathy may be the first symptom of many diseases and an important cause of morbidity if late diagnosed. We aimed to investigate peripheral lymphadenopathy results taken by excisional biopsy.

METHODS: Histopathological examination of 185 lymph node biopsy specimens was evaluated during 6 years of follow-up.

RESULTS: The average age of patients ranged from 1 to 86 was 41.01+20.62 years. 87 of were female, 98 of male. 62 (%33.5) of excisional biopsy materials were benign lesions and 123 (% 66.5) of malignant. Benign lesions were consisted of reactive hyperplasia, cat-scratch disease, toxoplasmosis, necrotizing /non-necrotizing granulomatous. Of these patients, 40 had nodes with reactive hyperplasia (15 female/25 male, mean age: 27.35 y), 14 had necrotizing granulomatous disease (9 female/5 male, mean age: 39.86y), 2 non-necrotizing granulomatous disease (1 female/1 male mean age: 43y), 4 had cat-scratch disease (1 female/3 male mean age: 54.25y), 1 toxoplasmosis (26 y, female), 1 kikuchi disease (25 y, female). In the evaluation of malign lesions; 38 were hodgkin lymphoma (HL) (%20.5, 17 female/21 male, mean age: 34.89y) (18 nodular sclerosane type, 12 mixt cellular type, 8 lymphocyte predominant), 77 had nonhodgkin lymphoma (NHL) (%41.6, 37 female/40 male, mean age: 52.26y) (54 of diffuse large cell, 10 of follicular lymphoma, 4 of peripheral T-cell, 3 of mantle cell, 3 of B cell rich T cell lymphoma, 2 of small cell lymphocytic lymphoma, 1 with marginal zone lymphoma), 8 metastasis (%4.3, 5 female/3 male, mean age: 53.5y). Reactive lymphadenopathy observed most common in cervical region, NHL in axillary-abdomen-inguinal-mediastinum and HL in the supraclavicular region.

CONCLUSION: Excisional biopsy can be applied safely with minimal morbidity and mortality and a gold standard diagnostic method of lymphadenopathy. Although lymphadenopathy is mostly related with benign lesions, malignancy should be kept in mind in the differential diagnosis.

Keywords: Benign, excisional biopsy, lymphadenopathy, malignant

P-0213

Secondary prevention and treatment of depression episodes in Patients with Diabetes in a rural area of Greece

Foivos Evangelos Kakavitsas¹, Emilia Grammenandi², Ioannis Perakis¹, Spyros Zoupas¹

¹Health Center of Aghios Athanasios Kerkyra - Greece

²private practice Kerkyra - Greece

BACKGROUND & AIM: Evidence from studies demonstrates that the presence of diabetes increases the risk of comorbid depression. Preventing depression recurring episodes in diabetic patients is clinically relevant. The purpose of the study was to determine in a rural area of Greece, if the diabetic patients are receiving the recommended secondary prevention care for depression episodes from primary care physicians and the effectiveness of the intervention in those patients.

METHOD: We used a randomized clinical trial (RCT) study of 681 adults with diabetes living in rural areas of Corfu island, that filled in the Patient Health Questionnaire (PHQ-9) for depression screening. Patients with a positive depression screening were invited to provide access to their health care clinical records.

RESULTS: 217 (31.86%) of diabetes patients screened positive for minor, moderate or major depression. Among these, 132 (60.83%) had a new depression diagnosis. Diabetes patients with mild depression symptoms were less likely (23.47%) to be at a conventional antidepressant management (H=6,971, p=0.033). In addition conventional antidepressant management strategies for mild and moderate depression were received in 47.2% of the patients with major depression (H=9,526, p=0.029). 45 (52.94%) of 85 treated patients (according to their medical records) responded to antidepressant treatment, with a reduction in depressive symptoms (H=6,820, p=0.007).

CONCLUSIONS: The optimal depression screening and treatment in rural primary care in Greece of diabetic patients still has some way to achieve. Despite guidelines, many patients fail to receive recommended secondary prevention care for depression episodes. Detection of depression episodes in those patients is important as it improves patient care, quality of patients life and reduces other signs and symptoms of depression in the majority of patients.

Keywords: Diabetes, Depression, prevention

P-0214

Raynaud's Phenomenon - Case Report

Clara Mendes¹, Vanessa Sá², Nicole Marques¹, Ana Filipa Dias¹, Janine Correia³, Mafalda Salvador¹

¹USF Monte Pedral, ACES-Lisboa Central, Portugal

²Centro Hospitalar Lisboa Central, Portugal

³USF Oriente, ACES-Lisboa Central, Portugal

Raynaud's phenomenon (RP) is a common clinical manifestation (3 to 5% of world population) which is characterized by episodes of transient ischemia digital of one or more fingers or toes. It may be primary or secondary to several diseases or conditions, often being the first manifestation of such diseases. The differential diagnosis between primary and secondary RP is made by clinical history, physical examination, immune analysis and capillaroscopy. Most patients with primary RP needs only behavioral therapy and smoking abstinence. When these measures are ineffective blockers of calcium channels are the first line.

The objective is to present the clinical case of a 30-year old female, with asthma and smoker, who came for a consultation because of swelling and digital cyanosis in both hands associated with cold. The physical examination only revealed cold fingers with sharply demarcated cyanotic skin (without findings suggesting tissue ischemia). In this first consultation we requested blood analysis (CBC, ESR, ANA, TSH and protein electrophoresis) and explain how important it was to stop smoking and prescribed nifedipin, as the diagnosis impression was the RP. Two weeks later she was better and brought the blood analysis results which only showed a positive ANA (1/200 specklet). Because in primary care set we could not ask for a capillaroscopy we sent her for a hospital consultation where she repeated the blood analysis. The results were normal (including ESR) and she's still waiting for capillaroscopy.

The purpose of this case report is to alert for this condition, listing the diagnosis criteria, facilitating their suspicion and forwarding timely and adequately the patient. The family doctor has the advantage, due to the holistic nature of his practice, of being able to carry out a longitudinal follow-up of these users, as 12.6 % of patients with RP develop associated disease.

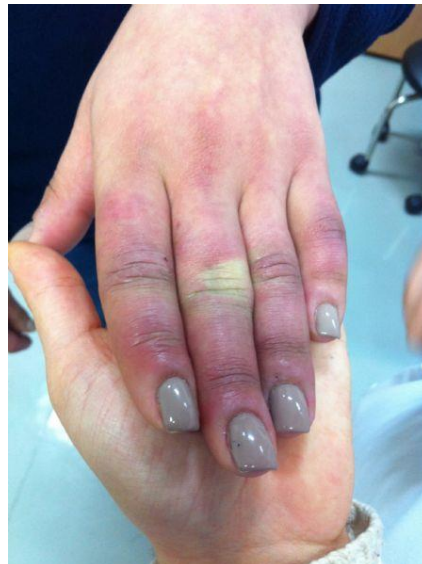
Keywords: raynaud's phenomenon

Improvement of both cyanosis and swelling after 14 days of nifedipin (30mg)



notice that she can wear the ring and how skin is wrinkled

Cyanosis and oedema (first consultation)



P-0215

Effects of Sleep Disorders On Quality of Life among Type 2 Diabetes Patients

Mehmet Akman¹, Ahmet Said Dünder², Ayşe Eren², Banu Çelik², Furkan Batuhan Güven², Gürkan Ayaz²

¹Department of Family Medicine, Marmara University, Istanbul, Turkey

²Medical Student, Marmara University, Istanbul, Turkey

Background & AIM: The prevalence of type 2 diabetes is increasing significantly in Turkey and in the world. It is reported that diabetes causes decline in quality of life. The aim of this project is to determine whether sleep disturbances are seen more predominantly among diabetic patients compared to patients seen in primary care with acute problems. Secondly possible relation between sleep disturbances and quality of life among diabetic patients is explored.

METHOD: This study was conducted in Marmara University Training and Research Hospital. Among 160 patients contacted 135 gave consent to participate (diabetic: 70; control: 65). A pre-prepared questionnaire together with Epworth, Berlin, COOP/WONCA and Pitsburg scales were filled by participants.

RESULTS: 74.5% of the participants were female. The average age was 43.8±14.8 years. According to Berlin scale results possible sleep apnoea was detected in 87.1% of the diabetic patients and day time sleepiness was 51.4% (Epworth scale). Compared to control group, Diabetic patients between age of 30-49 have significantly more day time sleepiness (10.3 vs 55.6%) and possible sleep apnoea rate is significantly higher among the diabetic patients aged over 50 years (60% vs 95.3%). Among diabetic patients having higher 'daytime sleepiness degree' have also more depressed mood and higher anxiety (p<0.05).

CONCLUSION: The low quality of sleep and sleep disorders such as sleep apnoea seen more frequent among diabetes patients. Sleep disturbances seems to worsen quality of life of diabetic patients. During routine primary care visits, we advice primary care doctors to screen their diabetic patients for sleep disturbances.

Keywords: sleep disorders, diabetes, quality of life

Table1

Table 1. Association of diabetes and sleep apnea risk among patients over 50
(p=0,031)

		Sleep Apnea Risk		Total
		-	+	
Diabetes	-	n=3 33,3%	n=6 66,7%	n=9 100,0%
	+	n=2 4,7%	n=41 90,4%	n=43 100,0%
Total		n=5 9,6%	n=47 90,4%	n=52 100,0%

P-0216

Dilated miocardiopathy associated with breast cancer therapy – Case report

Vitor Esteves¹, Melanie Ferro², Luís Semedo³, Catarina Bettencourt¹

¹USF Buarcos, Figueira da Foz, Portugal

²UCSP Montemor-O-Velho, Montemor-O-Velho, Portugal

³Hospital Distrital da Figueira da Foz

BACKGROUND: Dilated cardiomyopathy (DCM) is a progressive disease characterized by ventricular chamber enlargement and contractile dysfunction with normal left ventricular wall thickness. DCM has multiple etiologies being the third cause of heart failure (HF) and the most frequent reason for heart transplantation. Doxorubicin (DOX), an anthracycline anticancer drug, is an effective and frequently used chemotherapeutic agent for various malignancies. However, its usefulness is limited by the cumulative cardiotoxicity that can lead in the long term to DCM and HF.

METHODS: We describe the case of MHDB, a 70-year-old caucasian female, with a bachelor's degree in business administration, retired, belonging to a nuclear family, highly functional, in Phase VIII of Duvall's cycle. Medical

history of left radical mastectomy due to infiltrative ductal breast carcinoma in 2009, adjuvant chemotherapy with doxorubicin and radiotherapy. Follow-up with oncology appointments since then. In March 2015 had an appointment due to shortness of breath with four months of evolution, fatigue, functional class II NYHA, orthopnea and palpitations. On physical examination pulse rate was 126/min, blood pressure 136/88mmHg, normal cardiopulmonary auscultation, peripheral venous congestion and edema and ECG showed sinus tachycardia.

RESULTS: An echocardiogram was ordered showing decreased global systolic function, with severe diffuse hypokinesis (ejection fraction 21%). Carvedilol 6.25mg/day, lisinopril 8mg/day and furosemide 40mg/day were initiated. One month later the patient came to our attention as symptoms persisted, aggravated by cough of recent onset, which led to abandon all medication. Carvedilol and furosemide were reintroduced and candesartan 8mg/day added and progressive clinical improvement was observed.

CONCLUSIONS: DOX induced DCM leads to severe morbidity and mortality, being essential to assess cardiovascular events and establish early diagnosis in these patients. Thus, close cooperation between cardiologists, oncologists and family physicians is crucial, to balance the risks and benefits of cardiotoxic anticancer therapy and ensure adequate follow-up plans.

Keywords: dilated cardiomyopathy, heart failure, doxorubicin, cardiotoxicity

Echocardiography

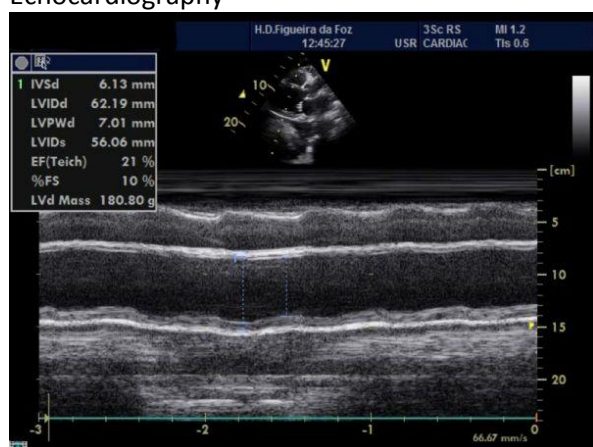


Figure 2 - M Mode Echocardiogram showing poor left ventricle contractility (24/04/2015).

Genogram

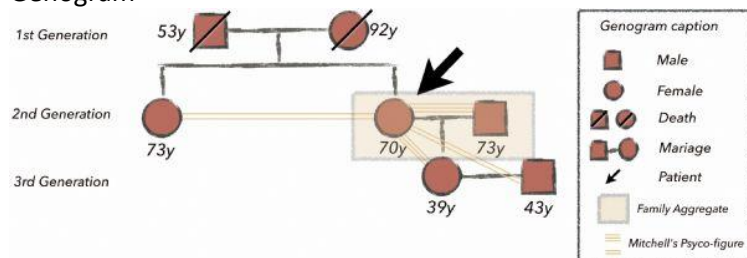


Figure 1 - Genogram and Mitchell's Psyc-figure (2015/04/24).

Echocardiography

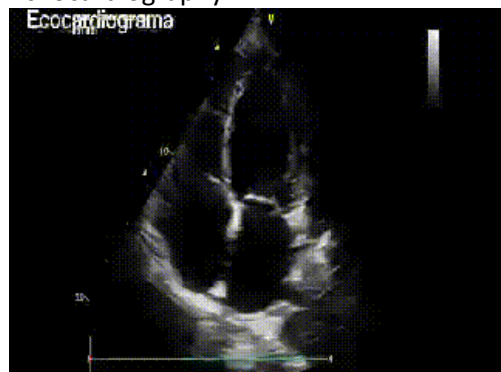


Figure 3 - Apical four-chamber view echocardiogram with severe diffuse hypokinesis (24/04/2015).

P-0217

Lowering and Monitoring Serum Urate Levels in Gout

Maryam Ahmed

North Hampshire Hospital, Basingstoke, United Kingdom

Hyperuricaemia (serum urate level [sUA] $\geq 360\mu\text{mol/l}$) is prerequisite for development of gout. Reducing, maintaining low sUA levels prevents re-accumulation of urate crystals, development of complications, improves physical function. Allopurinol, a urate-lowering therapy (ULT), is traditionally first line treatment used in long-term control of gout. Once therapeutic sUA level is achieved, annual assessment of levels recommended for optimal long-term gout management. This re-audit assesses current sUA monitoring according to guidelines and if whether patients are being treated to target.

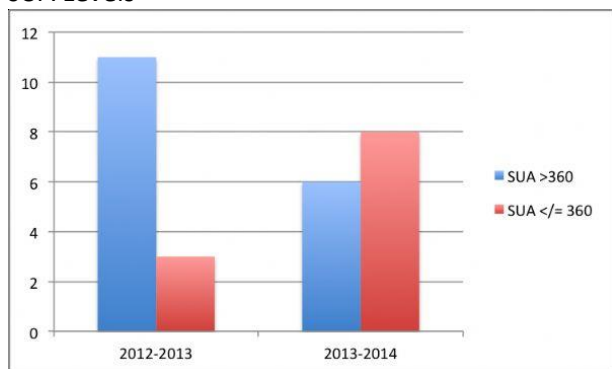
METHOD: This retrospective study uses EMIS Web Healthcare System, containing medical records of all primary care patients at Furnace Green Surgery. Patients ≥ 18 years old, with a diagnosis of gout (code C340 - 1443) and on Allopurinol from 3/12/13 – 3/12/14 were included. Patients with a first presentation of gout between 3/12/13 – 3/12/14 were excluded.

RESULTS: There are 7000 registered patients. 178 (2.5%) patients were ≥ 18 years old with diagnosis of gout. This is a 1.2% reduction from 3/12/12 – 3/12/13. Of 178 patients, 63 had Allopurinol prescribed on their repeat prescription (35.4%, 64% males, mean age 65 +/- 21 years). This is a 9.7% increase from 3/12/12 – 3/12/13. 14 patients (22.2%) had their sUA monitored between 2013-2014 of which 6 patients (42.9%) had a raised sUA. 3 patients had their dose adjusted with no subsequent sUA follow up, 3 had no dose adjustment.

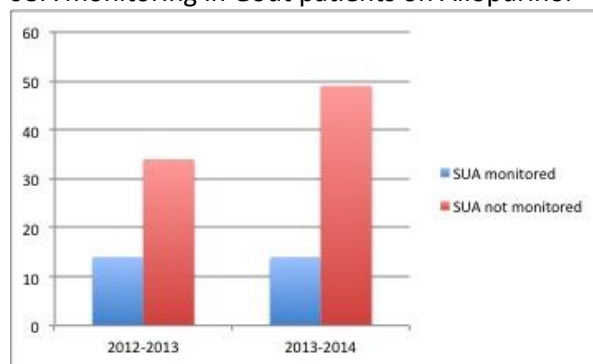
CONCLUSION: Gout monitoring has fallen below standards. Dosing Allopurinol appears to be happening as a sole event after an acute attack and sUA levels are being used as a diagnostic test than a measurement of treatment efficacy. Although this only represents one practice, with relatively small patient numbers on a specific ULT, it is extremely important that clinicians are familiar with current guidelines for gout in order to improve the quality of care for patients.

Keywords: gout,management,lowering

sUA Levels



sUA monitoring in Gout patients on Allopurinol



sUA monitoring in Gout patients on Allopurinol

	2012-2013	2013-2014
sUA Monitored	14	14
sUA Not Monitored	34	49
Total	48	63

The total number of patients who had their sUA monitored between 2013-2014 are 14 (22.2%). This total number remains unchanged from 2012-2013 despite there being an increase number of patients with a diagnosis of gout and taking Allopurinol.

sUA Levels

	2012-2013	2013-2014
sUA ≥ 360	11	6

sUA <360	3	8
Total	14	14

14 patients that had their sUA monitored between 2013-2014, 8 had their SUA level with target (57.1%), which is considerably more patients within target then the previous year.

P-0218

Barriers to diagnosing and management of COPD in GP/FM

Nena Kopcavar Gucek

Department of Family Medicine, Medical School, University of Ljubljana, Slovenia

BACKGROUND: The diseases of the respiratory system remain important public health burden, the chronic respiratory diseases are particularly important. Regarding their prevalence, limited data exist in the population and in primary care. As COPD is greatly underdiagnosed and undertreated in all environments, this abstract brings an overview of various possibilities of managing COPD in the GP/FM.

Contents: A short validated patient-completed questionnaire, the COPD Assessment Test (CAT) presents a possibility of assessing the impact of COPD on health status. It has good measurement properties, is sensitive to differences in state and should provide a valid, reliable and standardised measure of COPD health status with worldwide relevance. San Diego Shortness of Breath Questionnaire (SOBQ), a 24-item measure that assesses self-reported shortness of breath while performing a variety of activities of daily living, has been proved to be a valuable assessment tool in both clinical practice and research in patients with moderate-to-severe lung disease. A simple computer algorithm has also been considered by UK General Practice Research Base (GPRB) to identify patients with COPB and assess the severity of the diseasee. Routine screening/spirometry of all patients, who are smoking, also presents a reliable follow-up of already diagnosed patients. Due to the overload and difficult access to spirometry of GP/FM in several EU countries, it is not allways feasible. As an example of good practices in Slovenia, the introduction of model practices, a trained nurse has been introduced to assist in the early diagnosing as well as in the follow up of the COPD patients.

CONCLUSION: Although office spirometry significantly improves early detection of COPD in general practice, freely accessible and reliable questionnaires as well as task division within the GP/FM team could help to overcome the barriers to diagnosing and management of COPD.

Keywords: COPD, diagnosing, chronic diseases

CPC english logo



This poster was designed as a part of CPC+ program, which results from collaboration with Norwegian Grant.

P-0219

There is evidence of the fixed combination of Cinnarizine and Dimenhydrinate in the treatment of vertigo?

Sónia Manuela Rodrigues Moreira, Daniela Pedrosa, Duarte Pinto, Catarina Soares, Gilberto Guimarães
Unidade Saúde Familiar Torrão

Background & Aim

Vertigo is one of the most common complaints reported by patients of all ages, with an estimated prevalence in the primary care of 5-7%. It may arise from dysfunction in the peripheral and/or the central vestibular system and can lead to great limitations on patients' ability to meet their daily responsibilities causing frequent falls and other injuries. The initial approach to a patient with vertigo is symptomatic treatment to provide immediate relief.

Drugs from various pharmacologic classes have been used for this purpose.

Our aim was to review the evidence of the efficacy of a fixed low dose combination of cinnarizine and dimenhydrinate in adult patients with central, peripheral or combined central/peripheral vestibular vertigo in comparison with other therapeutics or placebo.

Methods

We searched for guidelines, meta-analysis, reviews and randomized controlled trials (RCT) in the medical literature databases published in English, Portuguese and Spanish between January 2005 and May 2015 using the mesh terms "cinnarizine" AND "dimenhydrinate" AND "vertigo". The Strength of Recommendation Taxonomy (SORT) scale of the American Family Physician was applied to assess the level of evidence (LE).

Results

A total of 11 articles were identified, 5 of which met the selection criteria. All were RCT's with LE 1, that demonstrated that the fixed low-dose combination of cinnarizine and dimenhydrinate are more effective and clinically beneficial in patients with peripheral (3 RCT) or combined central/peripheral vestibular vertigo (2 RCT) in comparison with other therapeutics widely used, as betahistine.

Conclusions

Although the number of studies have demonstrated that cinnarizine and dimenhydrinate are effective in vertigo of various causes, in Portugal is only available a fixed association that is more expensive than other options, such as betahistine. More studies that can show that there is an economic advantage in comparison to other available drugs are required.

Keywords: "cinnarizine", "dimenhydrinate", "vertigo"

USF Torrão



Vertigo



Articles



Inside results

Conclusions

P-0220

IBD - Learning and Teaching about Rare Diseases

Tatjana Cvetko¹, Dušan Baraga²

¹Department of Family Medicine Medical Faculty Ljubljana, Slovenia

²Primary Health Centre Cerknica, Slovenia

BACKGROUND: IBD is a rare disease, which runs a chronic and relapsing phase for years. Besides physicians in-depth knowledge about the disease the varied clinical picture requires also multidisciplinary and holistic approach, when good and supportive relationship with patient and well-established pathways of communication and cooperation with specialists improve the management of disease and timely prevent relapses. IBD patients' association find the empowered patients better involved in the treatment. Organization of interprofessional symposia for family doctors and other IBD specialists improve understanding of the disease and patient care.

AIM: to demonstrate the successful model of learning about rare diseases in FM.

METHODS: A review of data on the lectures and lecturers, content and presentation techniques used in learning and teaching process.

RESULTS: In 4 years 35 different speakers were carried out 65 lectures related to IBD forms, guidelines and monitoring of treatment. From an average of 163 participants per symposium, 107 was FM doctors or other specialists and 56 were patients. Introductory lectures were devoted to FM marked by stories of patients and their management in FM. Besides lectures, we used a variety of techniques - such as video-story, consilium of specialists, pro-et-contra debate, phone forum, which were well accepted by participants. IBD Association every year presents to doctors a number of activities organized by them for newly diseased and the chronically ill.

DISCUSSION: On annual meeting experts of all specialties and levels meet each other and learn together on rare diseases. In formal and informal meetings they use the opportunity to harmonize views and clarify dilemmas in the field of IBD.

CONCLUSIONS: Learning and teaching all together about rare diseases where the patients become experts for their disease, is a challenge for professionals of different levels and excellent way to improve the management of IBD in family medicine.

Keywords: IBD - chronic disease, rare disease, IBD in family medicine, interprofessional learning and teaching

P-0221

Monitoring Program of Heart Failure

Gemma Comas Arnau, M Jose Font Alonso, Anna Santeugini Bosch, M Belen Rosa Zambrana, Adriana Ramos Ordoñez, Esther Casanovas Cuquet, A Carolina Berengue González
Institut Català de la Salut, ABS Pineda de Mar, Barcelona, Spain

Summary: The training in self-care of patients with Heart Failure (HF) reduces the decompensations and hospitalization.

INTRODUCTION: In our primary care team (PCT) isn't carried out monitoring of these patients. Therefore, this program is launched, which monitors nursing (MN) of these patients, encouraging self-care of them.

OBJECTIVE: The follow up for each MN of patients with HF promoting self-care of them. Improving the registry of patients with HF. Assess whether having better self implies to a best life's quality.

METHODS: Bimonthly, the nursing program performs was applied monitoring these patients.

Each patient received a booklet with information on his HF, recording sheets blood pressure, weight and schedule visits. In the first visit, MN explain the illness, recommendations and warning signs.

In subsequent visits, evaluates: control blood pressure, weight, New York Heart Association escale (NYHA) signs of overload, adherence to the medication schedule and remember recommendations and warning signs.

Annually, realized the Minnesota scale and European Heart Failure Self-care Behaviour scale.

The doctor evaluates the patient every six months, just before if had decompensation.

The PCT was performed by HF training to professionals.

RESULTS: Before implementing the nursing program performs, wasn't monitored and the patients weren't received training in self-care.

In January 2015, 369 patients was diagnosed with HF in our PCT, 180 of them, had completed the program. The patients with HF was: HF distolic 76% and HF in functional type NYHA II was 54%.

Conclusions:

In our PCT, 48.7% of patients with HF had received training in self-management of their illness.

The professionals who received more training, detected and recorded more patients with HF.

There is a positive trend (better life's quality and the patient self-care), but only significant in the NYHA II group.

Keywords: heart failure, booklet, monitoring program

P-0222

Does insulin therapy turn the pink lights on for patients with Diabetes Mellitus?

Emre Yalçıntaş, Yusuf Karayürek, Ufuk Akkaya, Aziz Yılmaz, Dilber Ertaş, Özkan Yusufoglu, Nuh Esad Uyanık, Özer Kelemci, Hakan Demirci

Department of Family Medicine, Sevket Yilmaz Training and Research Hospital, Bursa, Turkey

AIM: Insulin therapy is usually preferred when the other options failed in treatment of Diabetes Mellitus (DM).

Transfer to insulin therapy is generally decided by the results of clinical parameters such as fasting plasma glucose, postprandial glucose and HbA1c. In the present study we aimed to compare success rates of treatment options.

METHODS: Family physicians participated in the study. They were part time trainees in family medicine in Turkey. They checked their computer documents related to patients with DM. Ages, genders, drugs prescribed to the patients at present and HbA1c values (analyzed in last 2 months) were documented.

RESULTS: In the study group, there were 375 patients with DM. Three hundred and eighteen of them were using oral antidiabetic drugs, 32 of them were using insulin and 25 of them were using combination of OAD and insulin. Mean HbA1c values of men (8 ± 2.2) were statistically significantly higher than HbA1c of women (7.5 ± 1.7) ($p=0.026$). The mean HbA1c values of the insulin group (9.6 ± 2.1) was also considerably high compared to the other group (7.3 ± 1.7) ($p=0.000$).

CONCLUSIONS: Starting insulin therapy does not mean a recovery. Insulin users still have a greater blood glucose regulation problem. Follow up of the patients by their family physicians has a critical importance for patients with DM.

Keywords: HbA1c, insulin, oral antidiabetic agents, treatment, part time trainees

P-0223

The Anticoagulation Challenge in Recurrent Deep Venous Thrombosis

Ana Luísa Borges¹, Miguel Ângelo Almeida²

¹USF Santa Maria Benedita, ACES Oeste Norte, Portugal

²USF Costa Campos, ACES Oeste Sul, Portugal

Deep venous thrombosis (DVT) has a high incidence worldwide, associated with high morbi/mortality rates. The core of this pathology is the Virchow triad (endothelial lesion, hypercoagulability, venous stasis). Standard treatment is 3 months of anticoagulation with LMWH and/or oral anticoagulants; however an indefinite treatment option may be valid in situations with persistent risk factors.

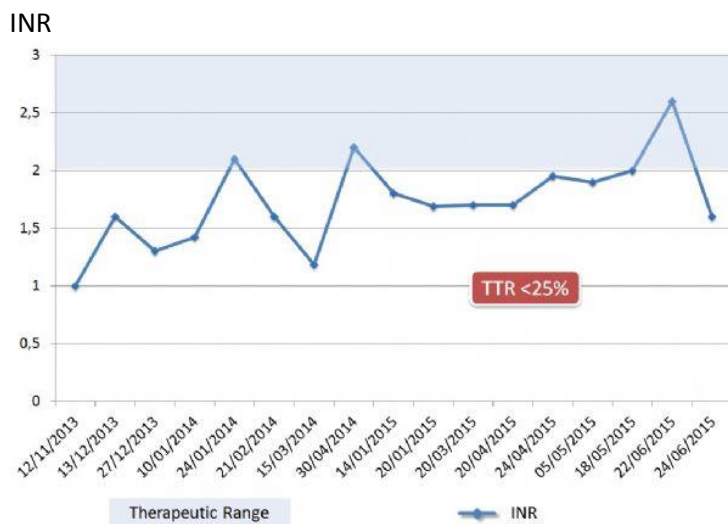
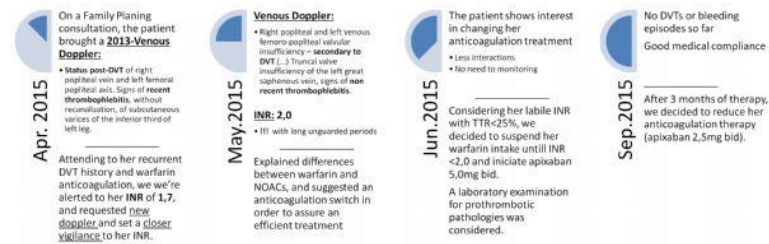
A 50-year-old Caucasian woman, non-smoker, autonomous, with past history of chronic venous insufficiency (CVI), with almost 30 years of evolution and multiple episodes of DVT, treated with subcutaneous enoxaparin, under warfarin treatment since November 2013. She had 2 vascular interventions (bilateral and left saphenectomy). Her family background includes CVI and multiple cerebrovascular accidents in young age. On April 2015, she presented with worsening lower limb pain, swelling and tiredness. On examination, there were

multiple varicose veins bilaterally, no edemas or tenderness on palpation in the popliteal fosse behind the knee. The lower extremity echo-doppler ultrasound demonstrated sequelae and signs of past DVT. Concerning her anticoagulation records, she had a labile INR (TTR<20%) – HASBLED=1.

It is known that an indefinite treatment reduces the risk for recurrent VTE by about 90%, but this benefit is partially offset by a 1% or higher annual risk of major bleeding. Considering our patient history of recurrent DVT without defined cause, it would be beneficial to choose a long treatment option with periodic assessments. Attending to her TTR, a change to a new oral anticoagulant would be an option; in fact several studies indicate that NOACs are both effective and safe in terms of prevention of DVT. Moreover, concerning to her family background, it would be interesting to persue further studies in order to exclude prothrombotic pathologies.

Keywords: deep venous thrombosis; VTE treatment; indefinite treatment; VTE anticoagulation

Timeline



P-0224

Suitability of metformin in the treatment of type 2 diabetes mellitus

João Rocha Moutinho, Diana Almeida Ferreira

UCSP Mealhada, Portugal

Background & AIM: treatment and glycemic control in patients with type 2 diabetes mellitus are important to delay the appearance and evolution of micro and macrovascular complications. In the treatment of type 2 diabetes, metformin is the drug of choice, but its use should be limited in case of chronic kidney disease. The objective of this study is to assess renal function and glycemic control of type 2 diabetic patients treated with metformin.

METHOD: cross-sectional study. Data of all users in a Primary Health Care Unit with ICPC-2 codification of type 2 diabetes mellitus being treated with metformin. The data collected included sex, age, estimated glomerular filtration rate (eGFR), presence or absence of microalbuminuria, systolic and diastolic blood pressure values.

RESULTS: 137 patients with a diagnosis of type 2 diabetes mellitus were identified, 100 of them are actually to pharmacological treatment with metformin, 51♂ and 49♀. Metformin exclusive is being used by 57 patients, metformin in combination with another oral antidiabetic on 34 patients and 9 in combination with insulin. Age 65,2±11,7 years old. 91% of then presents a eGFR≥ 60ml/min but 3 patients have eGFR less than 30ml/min and 6 have eGFR between 30-60ml/min.

CONCLUSIONS: In 3 patients metformin would be contraindicated because of an eGFR lower than 30ml/min so should be discontinued at increased risk of lactic acidosis. 6 patients have eGFR between 30 and 60ml/min and should therefore be studied adverse effects and should be considered substitute another oral anti-diabetic.

Keywords: Metformin,Diabetes mellitus,Chronic kidney disease

Anti-diabetic medication.

Treatment	Nº	%
Metformin	53	44,9
Metformin + Insulin	9	7,6
Metformin + another oral antidiabetic	45	38,2
Metformin + another oral antidiabetic + insulin	11	9,3

Distribution of the diabetics for the eGFR

eGFR (mL/min)	Nº	%	Age (years)	HbA1C	BMI	Years with Diabetes Mellitus	LDL	Blood Pressure
≥90	72	61,1	60±10	6,8±1,3	30±5	9±6	102±32	136/76
60-89	36	30,5	72±7	6,7±1,1	30±4	12±8	98±29	136/71
30-59	7	5,9	76±7	6,2±0,9	28±5	13±6	78±16	144/69
≤30	3	2,5	90±3	7,0±1,0	26±1	25±3	103±43	126/60

P-0225

Results of Smoking Cessation Program

Ayşe Semra Demir Akca¹, Fatih Akca², Murat Altuntaş², Pınar Alagöz²

¹Department of Family Medicine, Bülent Ecevit University Faculty of Medicine, Zonguldak, Turkey

²Uzun Mehmet Chest and Occupation Hospital Zonguldak, Turkey

The aim of this study was to evaluate the demographic characteristics and the success rates of the smokers who had completed one year follow-up in our smoking cessation clinic. A full medical history was taken and Fagerström Nicotine Dependency Test was performed at the first appointment. The subjects were given counseling regarding the hazards of smoking and a booklet for motivation was provided.

RESULT: Patients received different treatments including behavioral therapy (BT; 27.4%), BT+NRT (8.2%), BT+bupropion (23%), BT+varenicline (50.2%) and BT+bupropion+NRT (4.6%).

CONCLUSION: The process of smoking cessation should be considered individually for each case and it is a difficult process. In this process, adequate behavioral therapy and appropriate pharmacological treatment for individuals in sufficient time will increase the success rate

Keywords: Smoking cessation, smoking cessation outpatient clinic, cigarette quitting methods

P-0226

Corelation of apnea hypoapnea index concerned with body mass index in patients with obstructive sleep apnea syndrome

Ayşe Semra Demir Akca¹, Fatih Akca², Pınar Alagöz²

¹Department of Family medicine, Bülent ecevit üniversity, zonguldak, turkey

²Uzun Mehmet Chest and Occupation Hospital Zonguldak, Turkey

OBJECTIVES: Respiratory disorders during sleep is a common public health problem. OSAS consists of the vast majority of this group of disorders. PSG is the golden standart diagnostic technique. However PSG is an expensive, time consuming, special team requiring test and the psg laboratory quantity is very restricted. BMI is important parameters to differantiate the cases who are going to be referred to PSG. In our study the contribution of BMI has been evaluated in the OSAS diagnosis.

RESULTS: The study is in process. Results will be discussed at the congress.

Keywords: Respiratory disorder:obstructive sleep apnea syndrome; body mass index

P-0227

A very resistant diabetes

Isabel Solha, Jonathan Santos

usf terras de souza, aces tamega 2, paredes, porto, portugal

Background and AIM: According to WHO, global prevalence of diabetes Diabetes Mellitus was estimated to be 9% among adults in 2014, projected to be the 7th leading cause of death in 2030. Disease management and control of cardiovascular risk factors prevents early onset of micro a macrovascular complications. When managing seems impossible, this case aims to remind practitioners the importance of perseverance.

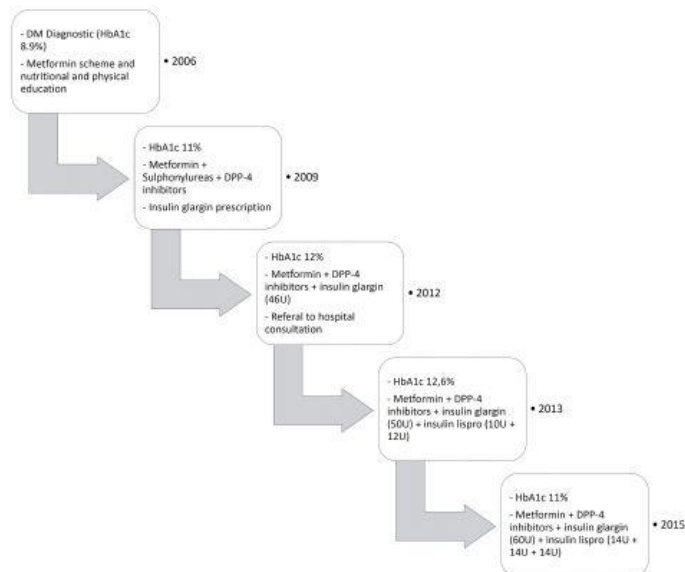
Case description: Female, 61, caucasian, married, with hypertension and obesity (BMI = 42 kg/cm²) who in 2006 was diagnosed with DM. Eating and physical activity education were made and oral antidiabetic drugs prescribed. Glycated hemoglobin (HbA1c), after a slight improvement, returned to baseline. The combination therapies recommended were implemented without success and HbA1c raised to 11%. An insulin regimen was instituted with consecutive dosage increases, that did not improve glycemic control, so it was referenced to an hospital consultation. She is currently treated with metformin (850mg 2id), insulin lispro (14U + 14U + 14U) and insulin

glargine (60U). The injectable anti-diabetic wasn't tolerated by the patient, keeping HbA1c values up far above the target therapeutic (11%). However, the patient developed other co-morbidities, such as dyslipidemia, multiple osteoarthroses, anxious disorder, peripheral arterial disease, diabetic retinopathy and moderate aortic stenosis, being accompanied by a multidisciplinary team.

CONCLUSIONS: Despite multiple medical approaches, different specialists and teachings, it seems impossible to achieve a suitable metabolic control for this patient with multiple comorbidities. The role of the Family Doctor is crucial not only in continuing therapeutic education, but also reminding the importance of healthy life style measures and promoting therapeutic adherence. Taking care of these patients is more effective when primary health care articulate with hospital's multidisciplinary teams.

Keywords: diabetes, management, continuous care

SCHEDULE



P-0228

Alzheimer's disease – Criteria for Diagnosis and Therapeutics The role of Family Physician

Maria Teresa Pereira Rodrigues Gaudêncio Silva, João Pedro Tomaz
ACES Sintra

INTRODUCTION: Alzheimer's disease (AD) ranks among primary dementia with insidious evolution, progressive and irreversible, characterised by increasing memory loss and cognitive decline.

Estimates indicate 90,000 portuguese have AD. Mainly affecting female individuals over 65 years old.

PURPOSE: To identify signs and symptoms of AD and updated evaluation criteria regarding diagnostic and therapy aiming to assess Family Physician degree of involvement in such evaluation.

Applied METHOD: A systematic research has been conducted on UpToDate® and PubMed/MEDLINE® databases looking for articles in Portuguese and English languages, published over the last decade, considering: review articles, meta-analysis and random clinical trials. MeSH terms used to the search: "dementia", "Alzheimer disease". The articles were selected according to the previous purpose.

Revision: Alzheimer's disease presents itself over 3 stages of evolution each showing specific characteristics. Strong genetic influence is related to AD with recently discovered biomarkers providing a key towards early diagnosis. Nevertheless, tests (e.g. Mini-Mental), scales (e.g. Blessed), questionnaires (e.g. FAQ, IQCODE) and criteria for diagnosis still hold the main role in diagnosing and prognosing AD.

DISCUSSION: Alzheimer's disease is an incapacitating illness for which the main symptom is memory loss which is by itself a frequent motivation for appointment with a Family Physician / GP. Hence, clinical practice should aim early diagnosis of AD.

It can be achieved by means of anamneses' collection directed towards both patient and caregiver and by applying those cognitive tests relevant within the context of Portuguese population. Therapeutics is accomplished

via early intervention by a multidisciplinary team.

The role of the Family Physician is utmost important at assessment, diagnosis and therapeutics stages of the process as well as by supporting and counselling patients and caregivers throughout the process.

Keywords: Alzheimer's disease

P-0229

Evaluation of Obese Patients Who Admitted to Outpatient Clinic of Mersin University Faculty of Medicine Department of Family Medicine

Esra Akkoca, Damla Demiray, Yücel Uysal, Ertan Mert

Department of Family Medicine, Mersin University, Mersin, Turkey

Background and Aim

Aim of the study is to evaluate obese patients who admitted to outpatient clinic of family medicine department according to the diagnoses of hypertension, diabetes, hyperlipidemia and thyroid-stimulating hormone abnormality.

Method

Medical records of the obese patients who admitted to outpatient clinic to lose weight have been evaluated retrospectively. 199 obese patients have been selected randomly among the patients who admitted in twelve months period between January 2012 and January 2013. These patients had no complaint except high body weight. Gender, blood pressure, blood glucose level, lipid levels, body mass index, waist circumference, thyroid-stimulating hormone level and follow up duration data of the patients were recorded, analyzed and evaluated.

Results

The results showed that mean follow up time time was $7,85 \pm 9,7$ months (range 1-42), mean age of patients was $42,89 \pm 14,6$ (range 13-75). Evaluation of data showed these abnormalities in patients; high blood pressure in 82 patients (41,2%), high blood glucose level in 77 patients (38,7%), high lipid level in 126 patients (63,3%), high thyroid-stimulating hormone level in 19 patients (9,5%).

Conclusion

The study showed that prevalence of certain diseases are very high in obese patients. As obesity is an important risk factor for many diseases obese patients should be examined and evaluated carefully although they had no complaint or apparent findings.

Keywords: obesity, chronic conditions

P-0230

Platelet rich plasma (PRP) is a novel therapeutic tool with the grate theoretic and experimental potential in osteoarthritis (OA) treatment

Liudmyla Khimion¹, Liudmyla Smolina², Svetlana Danyliuk³

¹L. Khimion, National Medical Academy of Postgraduate Education named after P.L. Shupyk, Kyiv, Ukraine

²L. Smolina, National Medical Academy of Postgraduate Education named after P.L. Shupyk, Kyiv, Ukraine

³S. Danyliuk, National Medical Academy of Postgraduate Education named after P.L. Shupyk, Kyiv, Ukraine

Methods. The study was conducted in 2 gr. of patients with diagnosed knee OA. 28 patients (9♂ (30.8%) and 19♀ (69.2%), mean age $44,7 \pm 1,2$ years were divided on 2 gr. Gr1 included 14 patients who consented to receive standard OA treatment and 3 intra-articular injections of PRP (total volume 12 ml, mean platelets number $860,2 \pm 32,1 \times 10^9 / \mu\text{l}$) weekly; gr2 consisted of 14 patients with the same diagnosis-received only standard OA treatment. The CRP-level, WOMAC scale, Lequesne index was analyzed before treatment and 1, 3, 6 months after course of treatment in both groups.

Results. CRP level was modestly abnormal in the 42,9% patients of gr1 and 35,7% patients of gr2; during the

treatment period CRP got to normal in all patients, but during the follow-up period, after 3 and 6 months of treatment in the study group it was significantly ↓ ($7,34 \pm 0,52$) and ($4,34 \pm 0,22$) mg/L, than in the control group ($9,56 \pm 0,67$) and ($6,92 \pm 0,57$) mg/L ($p < 0,005$); in addition in 3 patients of gr2 CRP level had increased again after 3 months which was the sign of OA exacerbation; in gr1 there were no OA exacerbations during 6 months of follow-up. At month 6 functional status of the patients in gr1 improved by 23% in stiffness (at the beginning of the study it was $3,8 \pm 1,0$) which had significant difference with patients of control group ($3,6 \pm 0,1$) - at the beginning of the study and ($2,4 \pm 0,1$) in 6 month after treatment. Pain during movement and after passing the distance decreased after treatment by 37.8% in gr1; pain and discomfort when climbing and descending the stairs decreased by 38.6% (these indicators in gr1 at the beginning of the study were $10,9 \pm 1,3$) (in gr2 - $10,2 \pm 0,9$) and in 6 month after treatment - $2,3 \pm 0,3$ in gr1 and $4,5 \pm 0,3$ in gr2 ($p < 0,05$). At the end of follow up period patients functional activity increased by 44.1% in gr1 which was ↑ then positive changes in gr2 and was accompanied by a significant reduction of restrictions in daily activities.

Conclusion. The course of 3 intra-articular injections added to the standard treatment of knee OA improves functional activity, reduces pain and probably can prolong remission in patients with the early stages of disease.

Keywords: Platelet rich plasma (PRP), osteoarthritis (OA), WOMAC

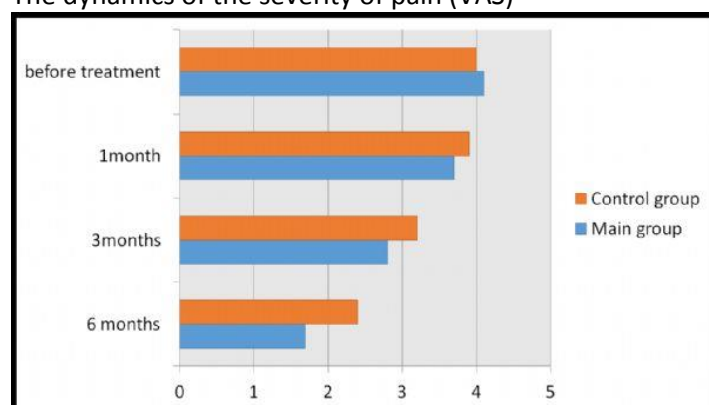
WOMAC

Dynamics of the WOMAC indicators during the study

Indicator	Pain	Stiffness	Function	Total score
Main Group				
before treatment	$11,9 \pm 1,3$	$3,8 \pm 1,0$	$41,8 \pm 3,2$	$55,5 \pm 2,8$
• 1 month	$8,0 \pm 1,8$	$2,5 \pm 0,8$	$37,8 \pm 3,9^*$	$48,3 \pm 0,8$
• 3 month	$6,8 \pm 1,5^*$	$2,1 \pm 0,4^*$	$24,7 \pm 3,8^*$	$33,2 \pm 0,4$
• 6 month	$5,3 \pm 1,3^*$	$1,7 \pm 0,7$	$18,4 \pm 3,1^*$	$22,4 \pm 2,6^*$
Control Group				
before treatment	$10,2 \pm 1,0$	$3,6 \pm 1,0$	$42,8 \pm 3,0$	$56,0 \pm 3,5$
• 1 month	$8,03 \pm 1,1$	$3,3 \pm 0,8$	$39,1 \pm 3,2$	$52,4 \pm 4,7$
• 3 month	$7,9 \pm 1,3$	$2,5 \pm 0,4$	$28,0 \pm 3,7$	$38,4 \pm 3,2$
• 6 month	$6,5 \pm 1,3$	$2,4 \pm 0,8$	$24,6 \pm 3,2$	$32,0 \pm 2,2$

* - $p < 0,005$

The dynamics of the severity of pain (VAS)



{Clinical and Biochemical Assessment of Hypogonadism in Men With Type 2 Diabetes}

Buket Tekin Vatansever¹, Sakin Tekin², Şule Temizkan³, Tülay Karabayraktar⁴, Berfu Çinkit⁵, Asuman Orçun⁶, Mustafa Tekçe⁷, Mehmet Ali Ustaoglu⁷, Mehmet Sargin⁸

¹Cevizli Family Health Center, Istanbul, Turkey

²Department of Endocrinology, Istanbul University

³Division of Endocrinology and Diabetes, Department of Internal Medicine, Kartal Training and Research Hospital, Istanbul

⁴Tuzluca Public Hospital, Iğdır

⁵Department of Family Medicine, Kartal Training and Research Hospital

⁶Department of Biochemistry, Kartal Training and Research Hospital

⁷Department of Internal Medicine, Kartal Training and Research Hospital

⁸Division of Endocrinology and Diabetes, Internal Medicine and Family Medicine Departments, Kartal Training and Research Hospital

Background and AIM: Hypogonadism is a clinical condition comprising both symptoms and biochemical evidence of testosterone deficiency. It has been reported that testosterone levels are lower in diabetic men compared with nondiabetic subjects. The aim of our study was to assess the prevalence of hypogonadism, based on both symptoms and biochemical available measures of testosterone deficiency in men with type 2 diabetes and compare with control group.

Research Design and METHOD: A cross sectional study was carried out in type 2 patients who attended the outpatient clinic of Diabetes Kartal Training and Research hospital. Between the 1th July and 15th July 2012, 65 consecutive patients were included to the study. Control group is created by age matched 40 non diabetic patients. Blood pressure, waist circumference, height, weight and testosterone levels were measured. Body Mass Index (BMI) was calculated. Bioavailable testosterone and free testosterone levels were calculated by using the levels of albumin, total testosterone and sex hormone binding protein. The Aging Males' Symptoms scale (AMS) was used to measure symptoms of hypogonadism.

RESULTS: Diabetic patients and control group's mean age was respectively 52.2 ± 5.0 and 50.8 ± 6.0 year, mean BMI 27.8 ± 2.9 and 27.9 ± 3.9 kg/m² and mean waist circumference 100.8 ± 7.3 and 97.9 ± 17.5 cm. Men with type 2 diabetes had significantly lower total testosterone and SGBH than control group. According to chemical hypogonadism based on total, bioavailable and calculated testosterone levels, there were no statistically difference between groups. Men with type 2 diabetes had significantly higher severe and moderate complaints of hypogonadism than control group. In diabetic group waist circumference, BMI and in control group waist circumference were negatively correlated with testosterone levels.

CONCLUSION: This study demonstrates that men with type 2 diabetes had significantly lower total testosterone but not significantly higher biochemical hypogonadism than control group.

Keywords: Clinical and biochemical hypogonadism, men with type 2 diabetes

Baseline characteristics of subjects

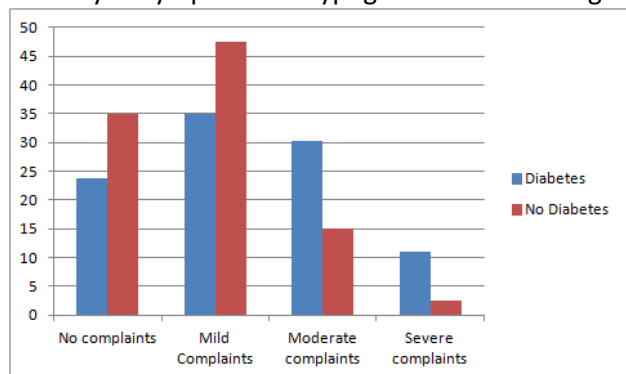
	Diabetes	No Diabetes	p
Age (year) mean±SD	52.2±5.0	50.8±6.0	NS
Height (cm) mean±SD	171.4±6.3	170.0±6.2	NS
Weight (kg) mean±SD	81.7±9.5	81.3±11.7	NS
BMI(kg/m ²) mean±SD	27.8±2.9	27.9±3.9	NS
Waist circumference(cm) mean±SD	100.8±7.3	97.9±17.5	NS
Systolic blood pressure (mmHg) mean±SD	132.4±19.4	133.2±17.4	NS
Diastolic blood pressure (mmHg) mean±SD	80.2±10.8	83.1±8.5	NS
Heart Disease n (%)	13 (81.3)	3 (18.8)	NS
Hyperlipidemia n (%)	37 (82.2)	8 (17.8)	0.000

Hypertension n (%) 33 (78.6) 9 (21.4) 0.003

The biochemical parameters of patients

	Diabetes	No Diabetes	p
SHBG (nmol/L)	33.8±15.1	42.3±20.2	0.02
LH (IU/L)	4.9±2.3	4.1±2.4	NS
Total testosterone (ng/dL)	399.9±145.2	510.0±225.8	0.005
Bioavailable testosterone (ng/dL)	192.6±57.6	210.9±68.8	NS
C. free testosterone (ng/dL)	8.3±2.8	8.9±2.7	NS

Severity of symptoms of hypogonadism according to diabetes status



Men with type 2 diabetes had significantly higher severe and moderate symptoms of hypogonadism than control group ($p < 0.05$)

P-0232

Pancytopenia due to a lack of vitamin B12 in chronic atrophic gastritis secondary to alkaline reflux in developing common; Case Reports

Türkan Paşalı Kilit¹, Süleyman Coşgun², Yasemin Korkut³, Serdar Üçgün¹

¹Department of internal Medicine, Dumlupınar University, Kütahya, Turkey

²Department of Gastroenterology, Dumlupınar University, Kütahya, Turkey

³Department of Family Medicine, Dumlupınar University, Kütahya, Turkey

OBJECTIVE: Chronic alkaline reflux gastritis is a rare cause of chronic atrophic gastritis. Chronic atrophic gastritis reduces plasma vitamin B12 and folic acid levels and increase homocysteine level. Vitamin B12 deficiency is a common cause of macrocytic anemia and pancytopenia.

CASE: Seventy-five-year-old male was admitted to the internal medicine department with complaints of numbness in hands and anorexia. In his laboratory test; ALT: 55U/l, AST: 163 U/l, indirect bilirubin: 1.59 mg/dl, direct bilirubin: 0.79 mg/dl, WBC: 4200/mm³, hemoglobin: 7.3 g/dl, hematocrit: 28%, MCV: 127 fl and PLT: 51.000/mm³. Increases in AST, MCV and indirect bilirubin levels were thought to be due to vitamin B12 deficiency. A Vitamin B12 level was 12.44 pg/ml. Erosive antral gastritis and alkaline reflux gastritis were found in upper gastrointestinal endoscopy. Chronic atrophic gastritis was detected in gastric biopsy. Helicobacter Pylori was negative in biopsy. An antiparietal cell antibody was negative (1/20). Vitamin B12 deficiency associated with atrophic gastritis caused by alkaline reflux was considered and parenteral vitamin B12 was given to the patient. Test results following three months were as follows: WBC: 6700/mm³, hemoglobin: 10.2 g/dl, PLT: 122.000/mm³, MCV: 93 fl, AST: 28 U/l, ALT: 15U/l, direct bilirubin: 0.55 mg/dl, indirect bilirubin: 0.9 mg/dl. Complaints of patient were improved.

RESULT: In patients with pancytopenia, vitamin B12 deficiency should be considered if AST, MCV and indirect bilirubin levels were elevated and neurological symptoms exist. Consequently; evaluation of the peripheral blood smear as the first laboratory test is extremely important in patients with pancytopenia that found in CBC made for any reason. Further testing for etiologic research should be planned according to the results of peripheral blood smear. Because of the increased risk of developing gastric cancer in patients with atrophic gastritis compared to the normal population, these patients should be followed by endoscopy at regular intervals.

Keywords: Atrophic gastritis, vitamin B12 deficiency, pancytopenia.

P-0233

Is it possible correlation between anthropometric measurements with microalbuminuria in the general population?

Türkan Paşalı Kilit¹, Celal Kilit², Yasemin Korkut³

¹Department of Internal Medicine, Dumlupınar University, Kütahya, Turkey

²Department of Cardiology, Dumlupınar University, Kütahya, Turkey

³Department of Family Medicine, Dumlupınar University, Kütahya, Turkey

OBJECTIVE: The most commonly used parameters in anthropometric measurements are waist circumference, hip circumference, waist-hip ratio and the body mass indexes (BMI). Cardiovascular risk is known to increase with waist circumference increase. BMI of 30 or greater is considered obese. The presence of microalbuminuria in spot urine test is an early indicator of target organ damage. Microalbuminuria has been shown to be an important risk factor for atherosclerosis and cardiovascular disease in many studies. Likewise, increase in waist circumference is associated with increased visceral adiposity and increased risk of cardiovascular disease. In this study, we investigated whether there is a relationship between microalbuminuria and anthropometric measurements in the general population.

METHOD: Anthropometric measurements of 206 patients admitted to our hospital internal medicine outpatient clinic were made. Patients with diseases that can cause microalbuminuria such as chronic renal failure or nephrotic syndrome were excluded from the study. Patients with diabetes and hypertension were included in this study with subjects completely healthy. Microalbuminuria levels of patients were measured in the spot urine. The association between microalbuminuria levels and height, weight, BMI, waist circumference, hip circumference and waist-to-hip ratio were investigated.

RESULTS: The mean age of patients was 45 (18-72 years). BMI was between 18 and 53 kg/m². There was no significant correlation between anthropometric measurements with microalbuminuria values.

RESULTS: The incidence of microalbuminuria increases with age in obese patients. Obesity accompanied by hypertension and diabetes Mellitus, increases the risk of microalbuminuria. In the evaluation performed without exclusion of diseases which may cause microalbuminuria such as hypertension and diabetes, a significant correlation has not been determined between anthropometric measurements and microalbuminuria level. Increased risk of microalbuminuria in obesity seems to be dependent on factors such as hypertension and diabetes associated with obesity.

Keywords: Anthropometric measurements, microalbuminuria, body mass index

P-0234

Isolated Hemihypertrophy: Case Report

Ahmet Ünal¹, Mediha Akcan², Refik Emre Çeçen²

¹Department of Family Medicine, Adnan Menderes University, Aydın, Turkey

²Department of Pediatric Hematology and Oncology, Adnan Menderes University, Aydın, Turkey

INTRODUCTION

Isolated Hemihypertrophy(IHH) increased risk of embryonal cancer that watch in childhood,especially Wilms tumor. Although name is hyperplasia,it used as hypertrophy.Limbs,body,face or entire body is characterized by asymmetric growth.The most common syndrome accompanied by Beckwith-Wiedemann syndrome,also can be seen as part of the Proteus syndrome,Russell-Silver syndrome,neurofibromatosis type I and Klippel-Trenaunay-Weber syndrome.The incidence is between 1:13000-1:86000 live births.

CASE REPORT

10 month old baby girl,her left half of the body was larger than the right.Her complaint had since birth.It was learned that following the 35-week gestation period she was born by cesarean section 1500 grams birth weight.On physical examination,weight 7500 grams (3-10 percentile),height 70 cm (25-50 percentile),head circumference of 44 cm (25-50 percentile).Her left upper and lower extremities was hypertrophic according to right extremities.Left forearm circumference 16.5 cm (the widest place),right forearm circumference 14 cm (the widest place),left leg circumference 23 cm (the widest place),right leg circumference at 22 cm (the widest place) were measured.She don't have dysmorphic facial features,macroglossia,abdominal wall defects,vascular abnormalities and cutaneous manifestations.There was no organomegaly.Laboratory examination revealed kidney function tests,liver function tests,thyroid function tests and alpha-fetoprotein was normal.There was no evidence of a complete blood count except for anemia.Hypochromia detected in peripheral blood smear made from the patient were consistent with iron deficiency anemia.Oral iron therapy was started.Abdominal and renal ultrasound examination was normal.The patient was considered isolated hemihypertrophy and she was transferred to the pediatric oncology.

CONCLUSION

IHH is important,because Wilms tumor,hepatoblastoma,adrenal cortical carcinoma, neuroblastoma,pheochromocytoma,rhabdomyosarcoma is seen in IHH more common compared to normal population. In such cases, a complete physical examination, a good story and laboratory examining, you will be able to diagnosis and follow up. They followed by pediatric oncology up to 7 years to be is important for early diagnosis and treatment. The cases detected hemihypertrophy should be directed to oncology children immediately.

Keywords: Isolated hemihypertrophy, Wilms tumor, cancer, primary

P-0235

Evaluation of chronic disease, and demographic characteristics of patients who admitted for periodic health examination

Elif Erdoğan Cenik¹, Rabia Dane Kocasaç¹, Mahcube Çubukçu², Mustafa Kürşat Şahin³

¹Department of Family Medicine, Medical Faculty, Ondokuz Mayıs University, Samsun, Turkey

²Department of Family Medicine, Samsun Education and Research Hospital, Samsun, Turkey

³Canik Community Health Center, Samsun, Turkey

AIM: The purpose of the periodic health examination is to evaluate health status, screen for risk factors and disease, and provide preventive counseling interventions in an age-appropriate manner. The goal of screening and evaluation is to prevent the onset of disease or the worsening of an existing disease. In this study, the chronic disease, and demographic characteristics of patients who admitted for periodic health Examination was investigated.

METHODS: The following study was performed on 185 patients who admitted to Samsun Education and Research Hospital Family Medicine outpatient polyclinic January 2012 to December 2013. Data were analyzed using SPSS

22.0 package program. In the analysis, frequency and percentage from descriptive criteria were used.
RESULTS: There were 100 (54%) female and 85 (46%) male patients. Patients average age was $45,63 \pm 13,9$ (range: 14-80). Four of the five patients were married. Nearly half of patients came from urban. One to eight patient admitted in 2013. Five most common disease was hypertension (%16,2 n=30), diabetes (%11,9 n=22), respiratory disease (%8,6 n=16), anemia (%8,1 n=15), psychiatric disease (%7,5 n=14). Hypertension was commonly observed in women, diabetes was commonly observed in men.

CONCLUSION: Women admitted to periodic health examination more than men. Patients age was generally at middle age. Married patient significantly had more chronic disease than others ($P=0.008$). Most participants didn't have any disease. Most common diseases are hypertension and diabetes. We planned to focus more on patient needs and improving the quality of care.

Keywords: Periodic health examination, hypertension, diabetes, chronic diseases

P-0236

Effect of the depression and anxiety status of cancer patients on their caregivers

Elif Altunbaş Ateş¹, Emine Canyılmaz², Turan Set¹, Nahide Gökçe Çakır¹, Ceyhun Yurtsever¹, Adnan Yöney²

¹Karadeniz Technical University Medical Faculty, Department of Family Medicine, Trabzon, Turkey

²Karadeniz Technical University Medical Faculty, Department of Radiation Oncology, Trabzon, Turkey

BACKGROUND & AIM: Today, cancer became a chronic disease that requires long-term treatment and care at home that affects the whole family. In our study, we aimed to investigate the impact of the depression and anxiety status of cancer patients on family members responsible to provide care.

METHODS: This study was conducted as a cross-sectional study between November 2014 and May 2015. A questionnaire containing demographics and Hospital Anxiety and Depression Scale (HADS) was applied to 76 patients who came to receive radiotherapy and their caregivers at Karadeniz Technical University Medical Faculty Radiation Oncology Unit using face-to-face interview.

RESULTS: The mean age of patients was 55.2 ± 14.5 , while the average age was 42.5 ± 13.2 at caregivers. Female rate of patients was 57.9% and 52.6% of caregivers were women. Anxiety and depression scores were significantly higher than men in female caregivers ($p=0.001$, $p=0.028$ respectively). Depression levels of patients were positively correlated with anxiety levels of the caregivers ($r=0.308$, $p=0.008$). There was no correlation between anxiety levels of patients and caregivers anxiety levels and also between caregiver's depression and the patient's depression and anxiety levels.

CONCLUSION: It has been shown that patient's depression levels affect caregiver's anxiety in our study. To provide optimal health care of a patient, considering mental health status of caregivers will be useful.

Keywords: Cancer patient, caregiver, anxiety, depression

P-0237

Positivity rates of thyroid antibodies (anti-TPO and anti-TG) in patients with thyroid disorder

Murat Atmaca, Zeynep Tuzcular Vural, Işık Gönenç, Merve Esen Arslan

Haydarpaşa Numune Training And Research Hospital Family Medicine Department

Background & AIM: Thyroid disorders are common endocrinopathies frequently encountered in primary health care settings. Otoimmune thyroiditis is a group of disorders causing thyroidal inflammation. Antibodies that attack the thyroid are what causes most types of thyroiditis. Anti-thyroid peroxidase (anti-TPO) antibodies are the most common thyroid autoantibody. Thyroglobulin antibodies (anti-TG) are specific for thyroglobulin. In this study, we aimed to retrospectively evaluate positivity rates of thyroid antibodies in patients presenting to our outpatient clinics with thyroid disorder.

METHOD: In this study, 473 patients examined during a 12 month period in the Haydarpaşa Numune Training and

Research Hospital Family Medicine Department who had both antibody results and had at least one positive result were evaluated retrospectively. Results higher than the normal range of the tests were considered as a 'positive' result. Patients whose antibodies were not evaluated simultaneously were excluded. In cases where antibodies were measured more than once, the most recent results were evaluated.

RESULTS: A total of 473 patients: 412 female (%87) and 61 male (%13) were evaluated for antibody positivity. Fifty patients had only anti-TPO (10,57%) and 106 patients had only anti-TG 106 (22,41%) positivity. In 317 patients (%67,02), both antibodies were positive.

CONCLUSIONS: Endocrinology guidelines state that in most patients with anti-TPO positivity, anti-TG is also positive; therefore it is not cost effective to measure anti-TG antibodies. It is claimed that cases which are anti-TPO negative, but anti-TG positive constitute approximately only 1-5% of autoimmune thyroiditis patients. Our results show that, in our study sample, 22,41% had only anti-TG positivity. This result is much higher than expected. We believe that antibody rates may differ for the Turkish population. Our results suggest that looking at only anti-TPO titrations for diagnosing autoimmune thyroiditis, may cause some patients to be left undiagnosed. Widespread research is necessary for more definite results.

Keywords: thyroid antibodies, anti-TPO, anti-TG

Olguların tiroid otoantikör pozitiflik dağılımı
Positivity rates of thyroid antibodies

	Anti-TPO (+) ve Anti-TG (-)		Anti-TPO (-) ve Anti-TG (+)		Anti-TPO (+) ve Anti-TG (+)	
	n	%	n	%	n	%
Kadın (n=412)	41	9,95%	98	23,79%	273	66,26%
Erkek (n=61)	9	14,75%	8	13,11%	44	72,13%
TOPLAM (n=473)	50	10,57%	106	22,41%	317	67,02%

P-0238

A Silent Danger: Awareness in Coronary Artery Disease

Suat Bıçak, Ayşe Semra Demir Akça, Tuğba Beyazççek, Yunus Müdüroğlu
Bülent Ecevit University Department of Family Practice, Zonguldak

Chronic ischemic heart disease is the main reason for myocardial ischemia. In epicardial coronary arteries, the level of mechanical obstruction generated by atheromatous plaque in vascular lumen is the most important determinant of prognosis. An obstruction at a rate of 50%-70% is needed for the patient to give symptoms. In symptomatic patients, typical angina which may spread over the neck, jaw, left arm and hand could be seen in a postprandial retrosternal, pressure-clamp and style due to exertion and emotional stress. The present case is about subjecting a hypertensive patient to advanced examination and diagnosis of ischemic heart disease considering positive immediate family history and high LDL level, despite the fact that the patient has no symptoms which may suggest ischemic heart disease.

The 50-year old male patient who has no chronic disease other than hypertension applied to the Family Medicine Polyclinic of Bülent Ecevit University for advanced examination by reason of the fact that his immediate relatives (father 57 MI, uncle 43 MI) died of coronary artery disease. Physical examination and EKG results of the patient were found normal and the patient was subjected to advanced examination due to positive family history. After the MPS, reversible perfusion defect was found at mid-basal level in the inferolateral region and the patient was subjected to coronary angiography

DISCUSSION

Coronary artery disease may clinically manifest itself in the form of silent ischemia, angina pectoris, acute coronary syndrome and sudden death. For protection against this disease, positive changes should be made in recoverable risk factors (hypercholesterolemia, physical activity, smoking, smoking...). In terms of recoverable risk factors, our patient had hypercholesterolemia but no others. As is known, family practice is a discipline that primarily evaluates both individual and society under the protective treatment.

Keywords: coronary artery disease, angina pectoris, hypercholesterolemia

P-0239

Validity and Reliability of Morisky Medication Adherence Scale in Patients with Hyperlipidemia

Rana Gündoğan, Kübra Uyar, Nilgün Özçakar, Mehtap Kartal
Department of Family Medicine, Dokuz Eylül University, Izmir, Turkey

BACKGROUND&AIM: Although benefits of cholesterol lowering treatment on prevention and treatment of the cardiovascular diseases documented, potential benefits of the treatment depends on drug adherence. In people with medium/high cardiovascular disease risk, treatment nonadherence deprive individuals benefits of prevention and causes serious increased costs in health systems as a result of increased preventable cardiovascular events.

Assessing adherence for primary care and in chronicle diseases, Morisky Medication Adherence Scale-8 (MMAS-8) is preferred as an easy, cheap method. Our aim was to evaluate the validity and reliability of the Turkish version of MMAS-8 in hyperlipidemic patients.

METHODS: In our methodological study, Turkish form of MMAS-8 is used, consisting 8 questions related to drug use, with necessary allows. Totally 194 participants who applied a family medicine center, agreeing participate study and was prescribed cholesterol lowering drugs in last year administered questionnaires containing socio-demographic characteristics, MMAS-8 with face to face method.

SPSS 15.0 is used for analysis and significance is $p < 0.05$. Cronbach 's alpha coefficient was calculated for internal consistency. Kaiser-Mayer-Olkin (KMO) and factor analysis was performed.

RESULTS: The mean age was 65.23 ± 9.43 , 59.3% were women ($n=115$), 63.4% were married ($n= 123$), 58.8% was retired. By MMAS-8 53.1% ($n=103$) were consistent mid-to-high.

The average LDL-cholesterol level was 117.8 mg/dL in compatible group, 167.6 mg/dl in incompatible group, difference was significant ($p < 0.05$).

The last 10 days of drug use rate of the patients (medication possession ratio-MPR), MPR mean was 9.66 in compatible group, 4.09 in incompatible group, difference was significant ($p < 0.05$). Cronbach's alpha reliability coefficient of the scale was 0.738. Factor analysis for construct validity KMO value was 0.68. Load factor of all questions is above 0.40, total variance explained by the scale was 69.689%.

CONCLUSION:

Turkish version of MMAS-8 was found to be reliable, valid clinical instrument in primary care for evaluation of hyperlipidemic drug use.

Keywords: validity, reliability, hyperlipidemia, Morisky Medication Adherence Scale

P-0240

Triggers, therapeutic attitudes and degree of disability of patients with migraine in primary Care

Susana Elizabeth Riesgo, Brenda Elizabeth Riesgo Escudero, M Dolores Moriano García, Rosa M. Viñas Vidal, M. Mar Forés Chacori, Marta Bandrés Minguenza, Ramón J. Gonzalez Alonso, Isabel Zamora Casas, Marielle Fernndez Fernandez, Max Encarnación Minaya
Institute Catalán de la Salud - Barcelona- Spain

OBJECTIVE: To identify the triggers, the degree of disability, and therapeutic approaches adopted in patients with migraine at an urban CAP (primary care center).

MATERIAL-METHODS: Descriptive cross-sectional study. Randomly recruited 206 patients between 15 and 65 years of age that were diagnosed with migraine according to International Headache Society. Patiens registered in the database (E-CAP) of our health center located in the urban area of Barcelona (Spain). 15 patients were excluded for various reasons.

VARIABLES: sex, age, pain location, age of onset, duration, type, intensity, crisis frequency, triggers, treatment, degree of disability by MIDAS (Migraine dissability Assessment Scale) questionnaire

Exclusion criteria: age < 15 or > 65 years, other types of headache, and refusal to participate.

Exploiting data with SPSS 18.0

RESULTS: Of all patients (n=206),191 were included and 15 excluded because of refusal to participate (n=2), and other types of headache (n=13). Female predominance was observed. (82.2%). The average age of first seizure was 44.4 years (DE12.65) with a average duration of 2.6 days (SD 2.46). 69.6% of patients reported throbbing quality and 79% predominantly unilateral location.

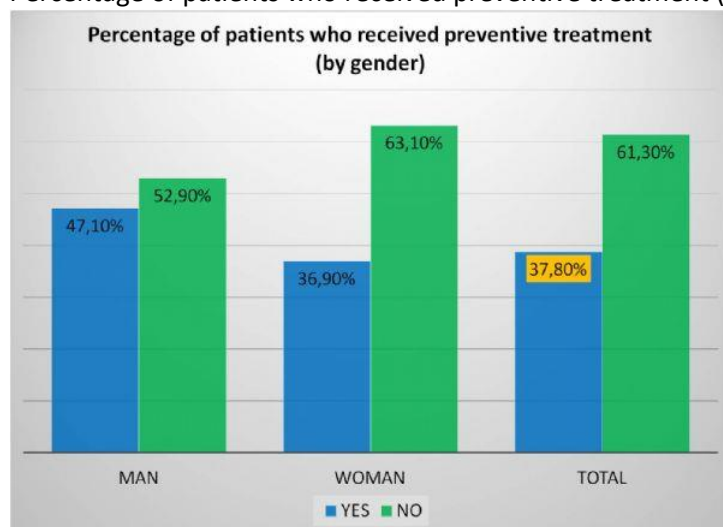
61.2% of patients had pain of severe intensity.44% performed preventive treatment (p-value:0.037) and 50.4% symptomatic treatment with triptans (p-value:0.078). The triggers were associated to stress by 31.1%. 38.7% of patients received preventive treatment, of which 47.1% were male. The most commonly used drugs were:Nadolol (5.6%),flunarizine (2.8%) and topiramate (1.4%).In Symptomatic treatment the most commonly used drugs were NSAIDs (87.4%), followed by paracetamol (79.0%) and triptans (43.9%). According to the MIDAS scale,68.5% of patients had little or no disability.

CONCLUSION: Severe disability was lower than expected. Given the large proportion of patients with pain of severe intensity,we must strength preventive and symptomatic treatment with triptans.

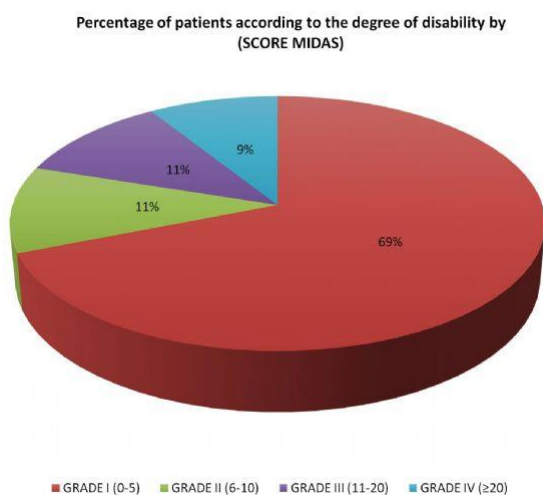
The migraine characteristics of our area are consistent with other published studies

Keywords: Migraine/MIDAS scale/Primary Care

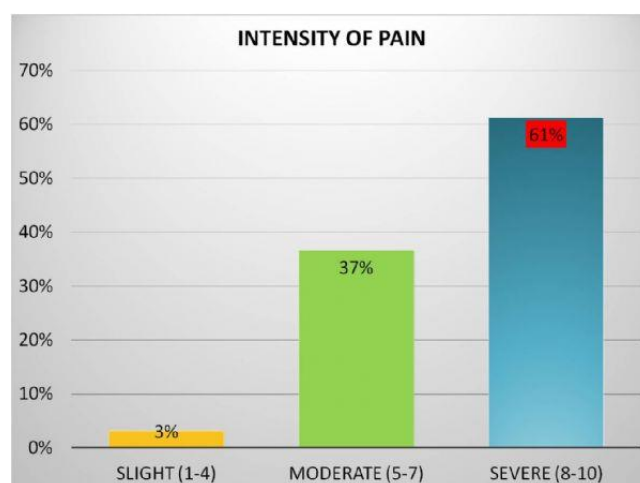
Percentage of patients who received preventive treatment (by gender)



Percentage of patients according to the degree of disability by (SCORE MIDAS)



Intensity of pain



P-0241

Study of the degree of agreement in referrals for surgery from primary medical care

Alvaro Perez Martin¹, Maria Jose Agueros Fernandez², Victor Ovejero Gomez⁴, Jose Ramon Lopez Lanza⁵, Monserrat Gago Bustamante², Alfredo Avellaneda Fernandez³, Cecilia Traspuesto Pascual¹, Isabel Muñoz Franco¹, Patricia Noemi Aguilera Samaniego¹, Maria Antonia Gandara Revuelta², Luis Rioja Zarrabeitia², Maria Angeles Pereda Garcia²

¹Primary Health Center Centro. Santander. Spain

²Primary Health Center Zapaton. Torrelavega. Spain

³Primary Health Center Los Carmenes. Madrid. Spain

⁴Sierrallana Hospital. Torrelavega. Spain

⁵Primary Health Center Alisal. Santander. Spain

Background&AIM: To analyse the characteristics of referrals for surgery from primary medical care, and the degree of agreement on the diagnoses..

METHOD: Analysis of patients referred to general surgery from an urban primary medical care centre over 2012, comparing the quality of the referral note, clinical assistance, and the diagnoses made at each level. Statistical analysis: averages were used for variables and percentages for qualitative elements and the Kappa index was used to assess the degree of agreement.

RESULTS: 177 referrals were made. The average age was 56(SD17.3), mainly male (50.3%). The main reasons for referral were inguinal hernia (21.5%), varicose veins in lower limbs (14.7%), skin cysts (10.7%) and hemorrhoids (8.5%). 59.3% were referred after the first consultation, with 3.4% having some kind of diagnosis test carried out, mainly ultrasound scans(66.7%). 17.5% were prescribed a treatment before referral(venotonics 43.3%). In general surgery, 38.4% received surgical intervention and 51.2% received some kind of treatment (local dressing (65.6%)). In 52% of cases in primary care centres the pathology was well described; at hospital level this figure was 50.3%, and the medical records were later completed in 45.2% of the cases. The Kappa index of diagnosis agreement between levels was 0.61, which is considered to be good.

CONCLUSIONS: There is a good degree of agreement between levels, which means there is knowledge regarding the pathologies. What needs to be highlighted is the poor description of the pathology on the referral note, from primary medical care as well as in the response, and the lack of information later entered onto the medical records. Diagnosis tests or prior treatments in primary medical care are seldom used. Almost half of the referrals received surgical intervention. It is necessary to become aware at both levels that the information has to be correctly registered onto the medical records.

Keywords: Surgery, Concordance, Primary Health Center

P-0242

Doctor, my nail is green !

Madalina Beatrice Morna

CAP Viladecans, Catalan Institute of Health, Barcelona, Spain

BACKGROUND: we present the clinical case of a patient 64 years old, housekeeper, which consults for green pigmentation and pain in the right thumbnail for 1 week long. Physical exploration: green discoloration and distal onycholysis, peripheral erythema and deep pain on the nail and paronychia palpation. No evidence of exudate.

Clinical diagnosis: Nail infection by *Pseudomonas aeruginosa* confirmed by the microbiological nail culture.

Treatment: ciprofloxacin 500mg /12h oral administration and topical treatment with acetic acid 2% solution for 14 days, with disappearance of pain and normalization of the nail color.

Discussion.

Green Nail Syndrome (GNS) is caused by a bacterial infection with *Pseudomonas aeruginosa*: a Gram negative bacillus which flourishes in wet environments and is enhanced by repetitive contact with water and cleansing products, particularly in abnormal nails. Housewives, dishwashers, cooks, and health care personnel may be more likely to have GNS. Also, it has been associated with the use of acrylic nails. It frequently is a complication of

onycholysis and chronicle paronychia. The green nail pigmentation is given by the presence of 2 fluorescent pigments called pyocyanin and pyoverdin produces by *Pseudomonas aeruginosa*. It is usually not painful, confined to one or two nails and could be accompanied by adjacent skin erythema. The diagnosis is clinical. However, if there is doubt, a nail sample can be taken for culture. Treatment consists of cutting the detached portion of nail and keeping nails dry. Topical treatment with acetic acid 1-2%, 3-4 times daily is effective in 2-3 weeks. Other topical therapies are neomycin, polymyxin B or tobramycin. An oral antibiotic, such as ciprofloxacin, is often prescribed and shorten the healing time. Despite the correct treatment, the green pyocyanin pigmentation could persist for months. The clinical appearance of GNS makes it an easy diagnosis for a general practitioner and avoids unnecessary referrals.

Keywords: *Pseudomonas aeruginosa*, Onycholysis, Green Nail Pigmentation.

Green nail syndrome



P-0243

Quick guide: Life pack 12

Diana Dominguez Jimenez, Antonio Rodriguez Trujillo, Abel Serrano Gil
 Estepa Health Centre

We have designed a fast scheme of use for the monitors on our health center, so that all staff even if they are new in the area and might not know it, trainees and even trained personnel wich because of the circumstances of the rural area where we practice can spent a while without using it, by a quick glance they can follow the steps to use the monitor in an emergency situation so vital time is not lost

Keywords: lifepack, emergencies, vital suport, reanimation

life pack 12

P-0244

Tolosa-Hunt syndrome versus Nocardia

M. Carmen Ruiz Martín, Andres A. Martínez Arias, Purificación Jordana Ferrando, Laura Pons Pons, Jesús García Palacios, Andrés R. Parra Rojas

ABS Indianes.Montcada i Reixac.Barcelona. Spain.

INTRODUCTION:

Tolosa-Hunt syndrome (THS) incidence is 1 per million.No sex or age predilection.

Etiology is unknown, although it involved a granulomatous inflammation of carotid sinus that causes pressure on the structures of the cavernous sinus (cranial nerves III, IV, V, VI).

It ´s clinically characterized by periorbital or hemicranial pain with ophthalmoplegia and good response to corticosteroid treatment.

Diagnosis by exclusion (neoplastic, vascular, traumatic, metabolic, endocrine, infections and autoimmune diseases).

The Nocardia is a saprophytic organism that infects by air the central nervous system and other organs opportunistically and asymptomatic with an indefinite stay. Faced a deficit of lymphocytes T, crosses the blood-brain barrier without altering it, may be in the form of granulomas or abscesses asymptomatic. In immunosuppression´ s states cause pulmonary, neurological or systemic symptoms

CASE CLINIC: 57 year old man, with obesity, hypertension and dyslipidemia.Two weeks ago, has right retroocular headache and horizontal diplopia,unresponsive to conventional analgesia.

After discarding neoplastic, vascular, traumatic, metabolic, endocrine, infections and autoimmune diseases.

Magnetic resonance detected discrete asymmetry between both cavernous sinuses and slight diffuse thickening at right. THS diagnosed, clinical improvement occurred with corticosteroid treatment.

Two months later, starts diarrhea, pleuritic costal pain and fever. Radiologically shows middle lobe pulmonary condensation, doesn´ t improve clinically with levofloxacin and later with amoxicillin / clavulanic acid.

Thoracic CT shows involvement of upper and middle right lobes pulmonary with central cavitation and right pleura. PAFF with infectious features and cultere insulated Nocardia.

Trimethoprim / sulfamethoxazole is initiated with clinical and radiological improvement.

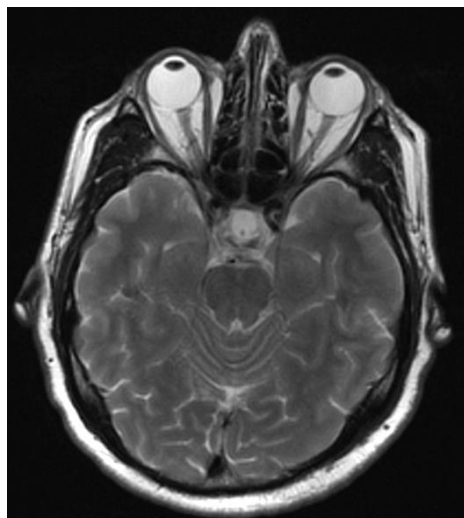
CONCLUSIONS: Since the THS, most of the time, is clinical presented only as a painful ophthalmoplegia, although its incidence is low and the etiology is remains unknown; clinicians should know, because mostly it ´s a diagnosis of exclusion and can sometimes be involved primary or secondary opportunistic infections.

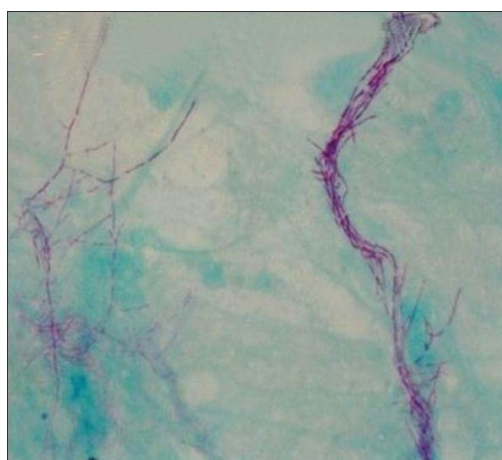
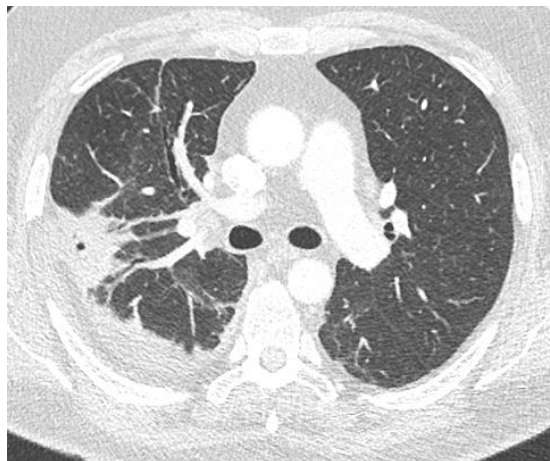
Keywords: Tolosa-hunt syndrome. Tolosa-hunt syndrome AND Nocardia. Nocardia.

A-One or more episodes of unilateral orbital pain persisting for weeks without treatment
B-Paralysis of one or more of the oculomotor nerves (III, IV or VI) and / or demonstration of granuloma in brain MRI or biopsy.
C- The ophthalmoparesis coincides with the onset of pain or follows it in less than two weeks.
D- The pain and the paralysis resolved within 72 hours when a correct corticosteroid treatment is started.
E Exclusion of other causes through appropriate investigations.

Table 1. Diagnostic criteria for STH (revised in 2004 by the

International Classification of diseases headaches second edition).





P-0245

Comparative study of calcific longus colli tendinitis in the past year at our hospital

Mikio Hayashi¹, Masanari Shiigai²

¹Department of General Medicine and Primary Care, Tsukuba Medical Center Hospital, Ibaraki, Japan

²Department of Radiology, Tsukuba Medical Center Hospital, Ibaraki, Japan

[Background and Aim]

Calcific longus colli tendinitis is a non-infectious, inflammatory myositis, presenting with acute cervical pain and odynophagia. Because fever sometimes accompanies this disorder, differentiation from a retropharyngeal abscess and vertebral osteomyelitis is necessary. From reviewing cases with a confirmed diagnosis of calcific longus colli tendinitis, we surmised that there is a need to clearly articulate the medical care environment and the circumstances leading to the diagnosis, not just the clinical signs and clinical course.

[Method]

We reviewed 5 cases of calcific longus colli tendinitis diagnosed at our hospital within the past year, and performed a comparative study about the medical care environment, clinical signs, circumstances leading to diagnosis, and clinical course.

[Results]

Concerning the medical care environment, there were more visits to the emergency outpatient department than the general outpatient department. Concerning clinical signs, cervical pain and odynophagia were observed in all cases; cases with fever were also noted. However, to differentiate from retropharyngeal abscess and vertebral

osteomyelitis, imaging was performed in all cases, and the diagnosis was mostly based on indications from the radiologist. Concerning the clinical course, improvement of the condition was seen after about 1 week in all cases.

[Conclusions]

In calcific longus colli tendinitis, the symptoms develop suddenly. In many cases, we observed that the time of the first patient presentation was not a general outpatient visit but an emergency outpatient visit. When cervical pain and odynophagia were the main complaints during the outpatient visit, calcific longus colli tendinitis was inconclusively diagnosed in many cases; follow-up was conducted for those cases. Primary care physicians should consider calcific longus colli tendinitis in the differential diagnosis when the main patient complaint is acute cervical pain and odynophagia.

Keywords: calcific longus colli tendinitis, cervical pain, odynophagia

Characteristics of the Patients

Case 1 : Age - 31 / Sex - Male / Clinical Signs - cervical pain , odynophagia , fever
Medical Care Environment - emergency outpatient visit
Time between presentation and diagnosis - 2 days (hospitalization)

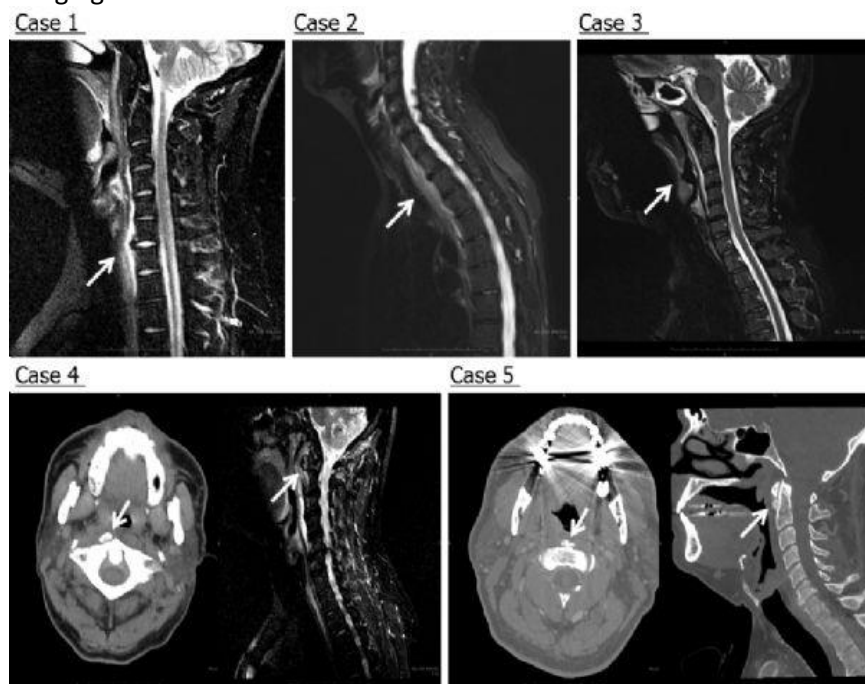
Case 2 : Age - 62 / Sex - Female / Clinical Signs - cervical pain , odynophagia , fever
Medical Care Environment - emergency outpatient visit
Time between presentation and diagnosis - 3 days (no hospitalization)

Case 3 : Age - 43 / Sex - Female / Clinical Signs - cervical pain , odynophagia
Medical Care Environment - general outpatient visit
Time between presentation and diagnosis - 1 day (no hospitalization)

Case 4 : Age - 45 / Sex - Male / Clinical Signs - cervical pain , odynophagia
Medical Care Environment - emergency outpatient visit
Time between presentation and diagnosis - 3 days (no hospitalization)

Case 5 : Age - 50 / Sex - Male / Clinical Signs - cervical pain , odynophagia , fever
Medical Care Environment - emergency outpatient visit
Time between presentation and diagnosis - 3 days (no hospitalization)

Imagings



References

- 1) Horowitz G, Ben-Ari O, Brenner A, Fliss DM, Wasserzug O. Incidence of retropharyngeal calcific tendinitis in the general population. *Otolaryngol Head Neck Surg* 2013; 148: 955 - 958.
- 2) Park R, Halpert DE, Baer A, Kunar D, Holt PA. Retropharyngeal calcific tendinitis: case report and review of the literature. *Semin Arthritis Rheum* 2010; 39: 504 - 509.
- 3) Offiah CE and Hall E. Acute calcific tendinitis of the longus colli muscle: spectrum of CT appearances and anatomical correlation. *Br J Radiol* 2009; 82: e117 - e121.
- 4) Zibis AH, Giannis D, MalizosKN, Kitsioulis P, Arvanitis DL. Acute calcific tendinitis of the longus colli muscle: case report and review of the literature. *Eur Spine J* 2013; 22: S434 - S438.
- 5) Chung T, Rebello R, Gooden EA. Retropharyngeal calcific tendinitis: case report and review of literature. *Emerg Radiol* 2005; 11: 375 - 380.

Clinical Features

Case 1 : Inflammatory response - WBC 10000 / μ l , CRP 2.05 mg/dl
 Images - C 6/7 , Soft tissue inflammation (+), Calcification (+), Effusion (-)
 First visit diagnosis - vertebral osteomyelitis / Improvement of the condition - 5 days

Case 2 : Inflammatory response - WBC 9900 / μ l , CRP 9.08 mg/dl
 Images - Th 1/2 , Soft tissue inflammation (+), Calcification (-), Effusion (-)
 First visit diagnosis - unknown / Improvement of the condition - 5 days

Case 3 : Inflammatory response - WBC 11000 / μ l , CRP 1.75 mg/dl
 Images - C 2/3 , Soft tissue inflammation (+), Calcification (+), Effusion (-)
 First visit diagnosis - calcific longus colli tendinitis / Improvement of the condition - 6 days

Case 4 : Inflammatory response - unknown
 Images - C 1/2 , Soft tissue inflammation (-), Calcification (+), Effusion (+)
 First visit diagnosis - cervical sprain / Improvement of the condition - 4 days

Case 5 : Inflammatory response - WBC 11400 / μ l , CRP 3.92 mg/dl
 Images - C 1/2 , Soft tissue inflammation (-), Calcification (+), Effusion (-)
 First visit diagnosis - unknown / Improvement of the condition - 6 days

P-0246

Creatine kinase elevation in a hypercholesterolemic patient. It's not always the statins' fault!

Madalina Beatrice Morna

Catalan Institute of Health, Primary Health Care Center CAP Viladecans, Barcelona, Spain

We present the case of a 65 years old woman, dyslipemic treated with simvastatine, which in a routine analyse has found creatine kinase(CK) elevation 665U/L, 4x normal value. No myalgias or muscle weakness. Statin is removed, but CK elevation persists. For one month long she presents facial rash. Physical exploration: heliotrope erythema, Gottron`s papules on the hands and difficulty on getting up from squatting. Suspected diagnosis: dermatomyositis(DM), confirmed by positive blood analysis for Nuclear Antibodys, Rheumatoid Factor and Mi2 Antibodies(associated to DM). Electromyogram reveals muscle fibres affectation. Cutaneous and muscle biopsy are inconclusive. Tumour tracking and marker tests CA125, CA19.9 without evidence of neoplasia. Treatment initiated with high dose of prednisone 80 mg/day and ulterior progressive reduction till 30mg with CK normalization.

DISCUSSION: Dermatomyositis is an idiopathic inflammatory myopathy characterized by progressive symmetrical proximal muscle weakness, characteristic skin lesions (heliotrope erythema, Gottron`s papules) and specific autoantibodies. Diagnosis is based on compatible cutaneous findings, elevation of muscle enzymes (creatine kinase, aldolase, lactic dehydrogenase, or alanine aminotransferase) positivity of myositis-specific autoantibodies, electromyography, and muscle and skin biopsy. Magnetic Resonance Imaging completes the study if other tests are inconclusive. Patients may have skin disease, without clinically apparent muscle injury, but this disorder is a

systemic process with frequent manifestations in gastrointestinal tract and pulmonary system and is associated with underlying malignancy in a 30%, especially in the first 3 years of diagnosis. Therefore, all patients with skin lesions need appropriate evaluation for muscle disease, esophageal dysfunction, cardiopulmonary disease, and potential internal malignancy.

Therapy includes photoprotection, topical and systemic corticosteroids and immunomodulatory agents (methotrexate, azathioprine, ciclosporina), although biologics are frequently prescribed.

CONCLUSION: Although DM is a rare disease, the suspected diagnosis is clinical and the general practitioner has to maintain alert to the clinical features.

Keywords: Dermatomyositis, inflammatory myopathy, heliotrope erythema.

Dermatomyositis Diagnostic Criteria

Table 1

Bohan and Peter Diagnostic Criteria^{21,22}

A	Proximal and symmetrical muscle weakness of the pelvic and scapular girdle, anterior flexors of the neck, progressing for weeks to months, with or without dysphagia or involvement of reparatory muscles.
B	Elevation of the serum levels of skeletal muscle enzymes: creatine phosphokinase, aspartate aminotransferase, lactate dehydrogenase, and aldolase.
C	Electromyography characteristic of myopathy (short and small motor units, fibrillations, positive pointy waves, insertional irritability and repetitive high-frequency firing).
D	Muscle biopsy showing necrosis, phagocytosis, regeneration, perifascicular atrophy, perivascular inflammatory exudate.
E	Typical cutaneous changes: <ul style="list-style-type: none"> • heliotrope with periorbital edema and violaceous erythema; • Gottron's sign: vasculitis in the elbow, metacarpophalangeal, and proximal interphalangeal joints.

Criteria for DM

Definitive	Three criteria (A, B, C or D) + E
Probable	Two criteria (A, B, C or D) + E
Possible	One criterion (A, B, C or D) + E

Gottron's papules



heliotrope erythema



Sarcoma Giant Gluteal. A case report

Rosa M^a Palacios Fort, Beatriz Soria Navalón
CSI Campello, Department of health 17 San Juan, Alicante, Spain

BACKGROUND: Soft tissue sarcomas (STS) are malignant tumors derived from connective tissue. They may appear in any part of the body, although they are more common in the legs and arms. They constitute about 1% of the total number of malignant tumors, and are responsible for 2% of deaths due to cancer. The annual incidence in adults in Europe is 14,000 new cases. They are slightly more common in men and can be seen in all ages with higher incidence between 40 and 60 years.

METHOD: 62 year old woman with a history of bilateral knee osteoarthritis notes that in September of 2014 the appearance of a lump in her buttock that hurt, but no reference it to her family doctor until December 2014 where the mass is already very large. She is urgently sent for an ultrasound: heterogeneous mass, with center anechoic and hipoechoic periphery. Lobed outlines well defined. Possible sarcoma for which is send her urgent to Traumatologist who applies for biopsy, Abdominal CT, bone scan, MRI of the pelvis that confirms the sarcoma (18 x 15 x 12 cm) plus lymph nodes in left hemi pelvis, and chest CT that shows pulmonary metastases.

RESULTS: Pathology: necrotic mesenchymal spindle cell tumor, compatible with Sarcoma NOS of high-grade. Nuclear pleomorphism: moderate. Immune: Vimentin: positive. S-110, Desmin, Actin, EMA, CK, CD34: negative. Index of cell proliferation Ki67 (MIB1): 40%.

Diagnosis: Sarcoma NOS left gluteus G3cT2bN0M1 (lung). Chemotherapy and local tumor surgery. Bad prognosis.
CONCLUSIONS:

Despite the low incidence of the STS we must investigate any suspicious mass since the prognosis will depend on histological grade, size, location in the tissue and in the organism and the presence or absence of metastases.

Keywords: Soft tissue sarcoma, metastases, extremities, prognosis, therapy

Gluteal left mass (Abdominal CT)



Gluteal sarcoma (MRI)



P-0248

Acute bacterial meningitis. A case report

Beatriz Soria Navalon, Rosa M^a Palacios Fort
CSI Campello, Department of health 17 San Juan, Alicante, Spain
BACKGROUND AND PURPOSE

Acute bacterial meningitis is an infectious disease that causes inflammation of the leptomeningeals, the surrounding tissue and spinal cord.

The most common causes of meningitis are viral infections that usually get better without treatment. However, bacterial infections are extremely serious and an important cause of morbidity and mortality. Hence the importance of rapid diagnosis to start an immediate antibiotic therapy.

METHOD

65 year old woman with Diabetes Mellitus, Hypertension, Dyslipidemia and Hypertensive heart disease, went to the Emergency Health Center for a holocranial headache, a fever of 38 degrees that lasted for 12 hours and a disorientation in space and time with agitation. She has also presented vomiting and nausea.

Physical examination: Regular general condition, dyspnea at rest, sweaty.

Blood pressure: 210/96; Heart Rate: 110 bpm; Oxygen saturation: 90%

Conscious and disoriented in space and time with preserved language. Psychomotor agitation. No meningeal irritation. Isochoric and normorreactivities pupils. Preserved cranial nerves. Strength and sensitivity not evaluated because a bad patient cooperation. Romberg and march not evaluated. Reflex Babinski bilateral flexor.

Patient was sent to the emergency department of the hospital to rule out infectious disease:

Additional tests:

- Analysis: Leukocyte 19.3 10e9 / L.
- Cranial CT: frontal cortical atrophy.
- Analysis of Cerebrospinal Fluid: glucose 265 mg / dl, proteins 577.9 mg / dl, leukocytes 8032 mm3, Polynuclear 92, 3%.

RESULTS

Acute Bacterial Meningitis

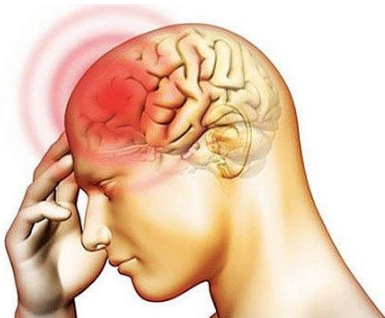
CONCLUSIONS

Broad spectrum antibiotic therapy was started immediately and the patient was sent to Neurology, improving neurologically during her stay at the hospital.

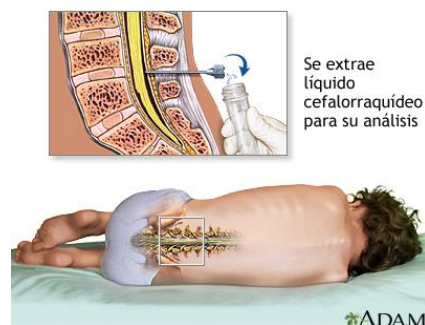
The intravenous antibiotic therapy with rapid diagnosis has proven effective in lowering mortality and reducing subsequent neurological consequences.

Keywords: bacterial meningitis, meningitis, meningitis treatment

HEADACHE



LUMBAR PUNCTURE



Analysis of Cerebrospinal Fluid: -glucose 265 mg / dl - proteins 577.9 mg / dl - leukocytes 8032 mm3 - Polynuclear 92, 3%.

P-0249

Consequences of not anticoagulated Atrial Fibrillation in a patient with vertigo resistant to medical treatment. A case report

Beatriz Soria Navalon, Rosa M^a Palacios Fort

CSI Campello, Department of health 17 San Juan, Alicante, Spain

BACKGROUND AND AIMS: Atrial fibrillation (AF) is more common cardiac arrhythmia in the clinical practice, increasing five times the risk of stroke and thromboembolic attacks. The mortality rate is double that of patients with sinus rhythm. Antithrombotic therapy reduces the risk of stroke and AF related deaths.

METHOD: A 78-year-old woman that presents Dyslipidemia, hypertension and non-anticoagulated atrial fibrillation. Independent for activities of daily living. The usual medical treatment is acetylsalicylic acid 100mg / 24 h, Flecainide 100mg / 24 h, Nimodipine 30mg / 24 h, came to the emergency department of the Healthcare Centre for dizziness that lasted for a few hours of evolution. No sensation that objects in the environment are moving, with nausea and vomiting together with gait instability and no tolerance for standing. She has no other symptomatology.

The general condition is not good. Eupneic at rest.

Blood pressure: 180/90, temperature: 36,2^o; Glucose: 68mg/dl.

Conscious and oriented to three areas with preserved language. Campimetry by confrontation is normal. No horizontal or vertical nystagmus. Preserved cranial nerves. No meningeal irritation. Maintained strength and sensitivity. Cutaneous-plantar reflexes in flexion. She does not show dysmetria. Negative results in the Romberg test. Ataxic gait.

Relevant complementary tests:

- Analytical test: glucose 152mg/dl, PCR 4, 12mg/dl.
- Brain tomography: low attenuation level in the lower back part of the left cerebellar hemisphere that suggests an ischemic process of the posterior inferior cerebellar artery (PICA) territory. No bleeding.

RESULTS

Ischaemic cardioembolic brain infarct in the left inferior cerebellar artery territory.

CONCLUSION

The patient progressed positively being capable of walk autonomously. In addition, it was recommend to suspend the Acetylsalicylic Acid and start with Apixaban 2.5 mg every 12 hours.

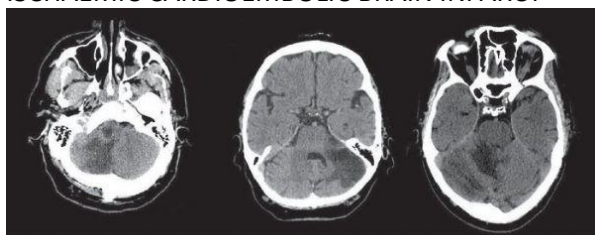
We have to remember that central vertigo is a cause of cerebellar ischaemic as a consequence of not anticoagulated AF.

Keywords: Hypertension, Atrial Fibrillation, Vertigo, Central vertigo, Anticoagulants

ATAXIC GAIT



ISCHAEMIC CARDIOEMBOLIC BRAIN INFARCT



P-0250

Iliofemoral-popliteal deep venous thrombosis – a diagnosis not to forget

Iva Lopes¹, Joana Leça²

¹UCSP de Macedo de Cavaleiros

²USF Terras do Ave

BACKGROUND: Deep venous thrombosis (DVT) and pulmonary embolism are manifestations of a single disease named venous thromboembolism. DVT is the presence of a thrombus in one of the deep veins, most commonly involving the leg or arm. Usually affects patients who are over 40 years old, obese, bedridden, who have had major operations or have hypercoagulable states. The common presenting features of painful, tender, swollen limb which is warmer than the other limb are non specific.

AIM: To describe a case of DVT in a young woman.

METHOD: Review of medical records.

Case description: Young female of 23 years old, healthy, medicated with oral contraception, with 5 hospital visits within a month. First presented with complains of pain in the right popliteal region, without other signs of inflammation, which she associated with her gym workout. Then appealed twice for chest pleuritic pain without dyspnea, and a fourth time for pain at right iliac fossa. During these visits, she was seen by Family Physicians, Orthopaedics and General Surgeons, and all discharged the patient with muscle relaxants, tranquilizers and anti-inflammatory drugs. At the fifth visit, in addition to pain on the right lower limb, she had unilateral swelling. It was suspected thrombophlebitis of the right lower limb and the patient was transferred to the Vascular Surgery Team. Venous ultrasonography confirmed the presence of right iliofemoral-popliteal DVT.

CONCLUSION: Although healthy and young people aren't usually affected by DVT, we have to be aware that it can happen at any age. It can be difficult to diagnose, and in most cases requires a high index of suspicion. It took about 1 month and several observations by different physicians to properly diagnose this patient and it could have turned into a more severe case as she could have had a pulmonary embolism.

Keywords: Venous thromboembolism, deep vein thrombosis, pulmonary embolism

P-0251

A nightmare of a family physician; Headlice; a case report and literature review

Duygu Ilke Yıldırım, Ayşe Selda Tekiner, Ayşe Gülşen Ceyhun Peker, Mehmet Urgan

Department of Family Medicine, Ankara University, Ankara, Turkey

Head lice commonly alert feelings of disgust, detestation, anger, and shame among parents and patients. Head lice infestation, or pediculosis capitis, caused by *Pediculus humanus capitis*, is a common health concern especially in childhood. In the US, where pediculosis capitis is the most prevalent parasitic infestation of children, 6 to 12 million people are affected every year. *Pediculus capitis* remains a health problem in schoolchildren also in Turkey. In addition to improvement in socioeconomic status, collaborative and participation efforts among physicians, nurses, teachers, and parents are necessary to maintain effective epidemiological surveillance and provide treatment.

Our case report may be the unique example of an infected family physician on her pediatrics emergency duty. 29 years old family medicine resident who has assigned pediatrics rotation; infected by head lice because of a patient. Scalp pruritus is her cardinal symptom, especially at her preauricular and occipital region. Pruritus with impetiginization prompted her husband who is also a doctor; orthopaedics surgeon. He had seen lice and viable nits. All close contacts also examined. Proper application of topical pediculicidal agents', chiefly permethrin lotion and wet combing with a fine toothcomb were chosen as medical management of that infestation. Spraying or fogging home with insecticides or pediculicides was not applied.

After a big struggle; a succesful treatment has obtained. This case will be a very useful sample for the doctors who are examining the childhood profile to protect theirselves from the parasites.

Keywords: Headlice, family medicine, pediatrics, pruritis, impetiginization

figure 1a



Diagnosis of head-lice eggs

figure 1b



Immediate and reliable diagnosis of head-lice eggs

figure 1c



Another angle of immediate and reliable diagnosis of head-lice eggs

figure 2



Chosen medication for the treatment

figure 3



Toothcomb that used for the treatment

P-0252

Attention to Diabetes in Children! Diabetic Ketoacidosis: A Case Report

Aslıhan Çiflik Bolluk, Candan Kendir Çopurlar, Vildan Mevsim
Department of Family Medicine, Dokuz Eylül University, İzmir, Turkey

Introduction

Family physicians are the point of first contact and manage conditions that may present early and in an undifferentiated way. The prevalence and incidence of illnesses is different from that which appears in a hospital setting and serious disease presents less frequently in general practice than in hospital.

In childhood, infections are the first reasons of diabetic ketoacidosis (DK) both initial diagnosis of diabetes and diabetic patients under treatment.

In this case report, a DK case that is initially undiagnosed will be discussed.

Case presentation

8 years-old girl, had complaints of chills in hands and feet, paleness on face and fatigue which started two days ago. The patient with complaints of frequent breathing and vomiting applied to family medicine health care centre. The family physician she is registered was off duty and for that reason she took health care by another doctor in health centre. She had diagnosis of otitis and give a prescription. She was called for control visit the next day. Because when she arrived home, her complaints of vomiting and breathing were increased, the patient applied to emergency service and had a chest x-ray, it was interpreted normal. She was discharged. When the patient arrived home, her shortness of breath has increased and pupils were dilated and applied to emergency service again. When her fasting blood glucose was measured, it was 382 mg/dl. Beside Kussmaul breathing, there was not additional symptom in her physical examination. She was diagnosed DK and treatment started.

Conclusion

Incidence and prevalence of type 1 diabetes and DK in children are rare, diagnosis of this disease is difficult in general practice. When the family physician find out infection and respiratory distress in children patient, he should think of the diagnosis of diabetes and measure blood glucose level.

Keywords: Type 1 diabetes, Diabetic Ketoacidosis, Children

Diabetic Ketoacidosis



Type 1 Diabetes



P-0253

Introduction of Stroke code in an emergency department

Pedro Guijo González, José María Fernández González, Hector Leonardo Lugo Ramos, Juan Jesús Rodríguez Vallejo
Hospital Jerez de la Frontera, Spain

The Acute coronary Syndrome is a time dependent illness whose prognostic is related to the precocity of its detection and treatment. The objectives of the present study are to analyze the experience of the implantation of the Stroke Code and describe the features of the patients that have been treated.

Materials and methods.

Prospective and observational study in a sanitary area of a Second level hospital. The time of study was of 7 months. It included patients with acute coronary syndrome with ST elevation in whom the Stroke code was activated.

The variables included were age, sex, mode in how the attention was demanded, treatments applied and clinical results. The variables were analyzed with SPSS 22 (statistic program).

Results

In 72 times was the Stroke code activated, 30% of them treated with fibrinolysis and 70% of them with primary angioplasty. In 30,6% of the patients treated with fibrinolysis, 86% of them were males, medium age 59,3. Of those, 9% arrived to the hospital by themselves whereas 91% rest needed help from the Extra-hospital EM service. The service showed in our study an effectiveness of 51% whereas the 49% rest needed a Rescue angioplasty.

The 69,4% of the patients who were treated with primary Angioplasty, 88% of them were males, medium age 62. Of those, 38% arrived without help whereas the rest (62%) required the EM Service.

Conclusions

In our study, the implantation of the Stroke Code has increased the number of patients treated with Primary Angioplasty, improving at the same time the clinical aspects at its arrival to the hospital. Moreover, the Stroke code was activated mostly in young patients with cardiovascular risk antecedents.

Keywords: Acute coronaty sindrome, Emergency department, Thrombolysis in myocardial infarction

P-0254

Fibrinolysis, a real outpatient alternative

Pedro Guijo Gonzalez, José María Fernández González, Juan Jesús Rodriguez Vallejo, Hector Leonardo Lugo Ramos
Hospital Jerez de la Frontera, Spain

The aim of this study is to analyze and compare times of performance between Primary Angioplasty and Fibrinolysis.

We pretend to underline the importance of the knowledge and results of the Fibrinolysis therapy due to the benefit it gives to the patient.

Method

We analyze during a period of 6 months, a total number of 72 Stroke Code patients in a Second level hospital. We compare Fibrinolysis and Primary angioplasty by analyzing times between first medical contact and appliance of the treatment and time between pain and treatment. We also analyze the need of rescue in patients treated with Fibrinolysis.

Results

Medium age was of 60 years, 88% of them were males whereas 12% of them were women.

The time between pain and appliance of Fibrinolysis was averaged 120 minutes, median of 97 minutes. Time between first medical contact and appliance of fibrinolysis was averaged 53 minutes, median of 47 minutes. The total effectiveness of fibrinolysis was in 50% of the patients, medium aged 59 and 86% of them male sex.

Primary angioplasty was applied 69,4% of the times, patients medium aged 62 and 88% of them male sex. Time between pain and appliance of the therapy was averaged 220 minutes, median of 195 minutes. On the other hand, time between first medical contact and Angioplasty was averaged 128 minutes, median of 110 minutes.

Time between initiation of pain and first medical contact was averaged 91 minutes, median of 46 minutes.

Conclusions

Fibrinolysis has an effectiveness of 50% which implies the removal of the obstruction in less time with the subsequent decrease in posterior morbimortality.

If we apply Fibrinolysis we get to a decrease in performance time not only since the beginning of the pain but also since first medical contact to the appliance of the therapeutic procedure.

Keywords: chest pain, acute coronary syndrome, emergency department

P-0255

Patient and investigator ratings of flurbiprofen 8.75 mg spray as a treatment for sore throat

Marc Russo¹, Fred De Looze², Mark Bloch³, Barney Montgomery⁴, Gary Smith⁵, Adrian Shephard⁵, Sue Aspley⁵

¹Hunter Pain Clinic, Newcastle, NSW, Australia

²AusTrials Pty Ltd, Sherwood, QLD and School of Medicine, University of Queensland, Brisbane, QLD, Australia

³Holdsworth House Medical Practice, Sydney, NSW, Australia

⁴Optimal Clinical Trials, Auckland, New Zealand

⁵Reckitt Benckiser Healthcare Ltd, Slough, UK

BACKGROUND & AIM: Patients with sore throat who visit a healthcare professional are looking for an effective treatment to reduce their symptoms. Using traditional pain measurements, we evaluated flurbiprofen 8.75 mg spray as a treatment for sore throat, from the perspective of the patient and the investigator. **METHOD:** This randomised, double-blind, placebo-controlled, multicentre study enrolled patients with recent onset (≤ 4 days) sore throat due to an upper respiratory tract infection. Patients took one dose of flurbiprofen 8.75 mg cherry mint flavoured spray or placebo spray without added flavour or odour and were instructed not to re-dose for 6 hours. At 3 hours post-dose patients completed the patient satisfaction scale (SATIS) and the global evaluation of the study medication (GLOBAL). The investigator also completed the practitioner's clinical assessment of drug efficacy scale (CLIN). All adverse events (AEs) were recorded. **RESULTS:** 505 patients (mean age 25.6 years, 44% female) were randomised (flurbiprofen spray n=249, placebo n=256). For the SATIS evaluation, 132/248 (53.2%) of patients reported they were either 'satisfied, very satisfied or extremely satisfied' with the study medication in the flurbiprofen spray group compared with 83/254 (32.7%) in the placebo group ($p < 0.0001$). For the GLOBAL evaluation, 222/248 (89.5%) of patients reported the study medication as 'fair, good, very good or excellent' in the flurbiprofen spray group compared with 178/255 (69.8%) in the placebo group ($p < 0.0001$). For the CLIN evaluation, investigators reported the study medication as either 'fair, good, very good or excellent' for 203/238 (85.3%) patients in the flurbiprofen spray group and 166/248 (66.9%) in the placebo group ($p < 0.0001$). No significant differences in AEs were reported between treatment groups over 6 hours (flurbiprofen 6.8%, placebo 3.1%; $p = 0.061$). **CONCLUSIONS:** Flurbiprofen 8.75 mg spray is an effective treatment for sore throat and is rated favourably by patients and healthcare professionals.

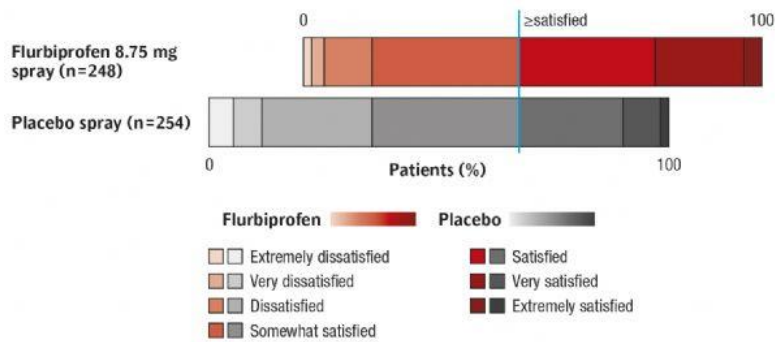
Keywords: Pharyngitis, Self Care, Acute Pain

Table 1. Baseline characteristics and demographics

	Flurbiprofen 8.75 mg spray (n=249)	Placebo spray (n=256)	Overall (N=505)
Age, mean (SD), years	25.5 (9.9)	25.7 (10.3)	25.6 (10.1)
Male, %	58.2	53.9	56.0
TSS, mean (SD)	6.93 (0.895)	6.99 (0.838)	6.96 (0.866)
DSS, mean (SD), mm	68.60 (10.91)	69.66 (10.21)	69.14 (10.57)
SwoTS, mean (SD), mm	66.53 (13.63)	67.62 (11.80)	67.09 (12.73)
TPS, %			
Mild pain	8.4	8.2	8.3
Moderate pain	79.9	89.6	82.8
Severe pain	11.7	6.3	8.9
TPA score, mean (SD)	7.76 (2.17)	7.71 (2.21)	7.73 (2.19)
PAIN, %			
Mild inflammation	36.1	38.7	37.4
Moderate inflammation	58.2	57.4	57.8
Severe inflammation	4.8	3.5	4.2

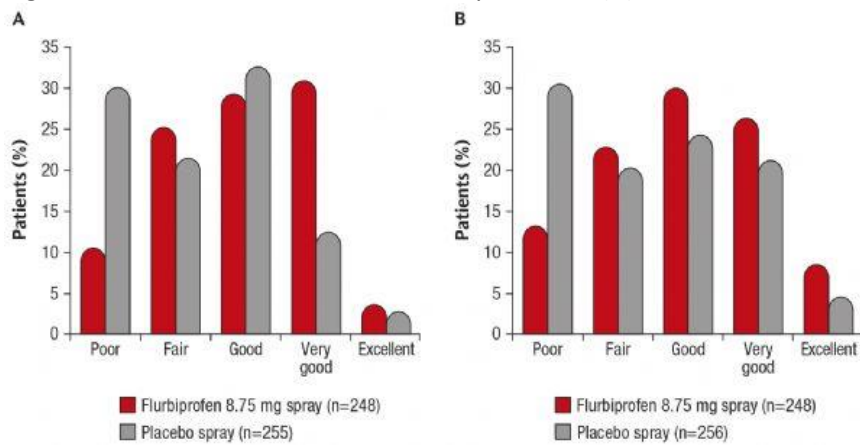
DSS, Difficulty Swallowing Scale; PAIN, Practitioner's Assessment of Pharyngeal Inflammation; SD, standard deviation; SwoTS, Swollen Throat Scale; TPA, Tonsillo-Pharyngitis Assessment; TPS, Throat Pain Scale; TSS, Throat Soreness Scale

Figure 1. SATIS evaluation at 3 hours post-dose



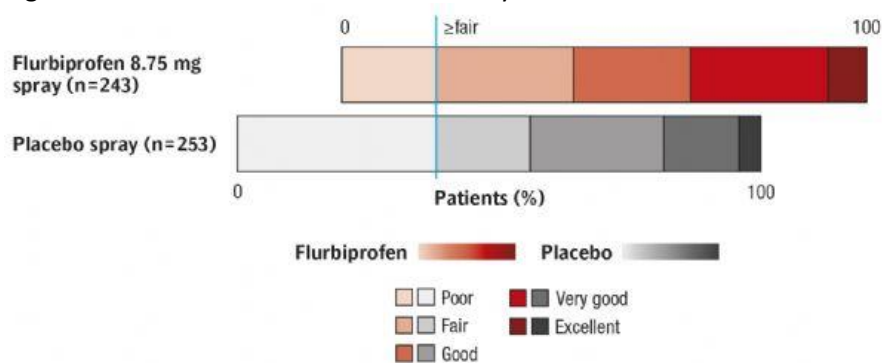
SATIS, patient satisfaction scale

Figure 2. GLOBAL evaluation at 3 hours post-dose (A) and at the end of Day 3 (B)



GLOBAL, global evaluation of the study medication

Figure 3. CLIN evaluation at the end of Day 3



CLIN, practitioner's clinical assessment of drug efficacy

P-0256

Funicular Myelosis: Regarding a case

Giovanna Lovatón¹, Jorge Hidalgo², Angeles Ortega¹, Celia Quiroz¹

¹Consorti Sanitari de Terrassa

²Hospital Mutua de Terrassa

Case Presentation

A 50-year-old patient with no allergies and no toxic habits, presents in July of 2013, one year of tingling fingers that was studied as carpal tunnel syndrome finally discarded. After a few weeks, symptoms as tingling feet were described with no electromyographic alterations. Finally, instability and heel gait were observed. He was derived to rapid diagnosis unit in our reference Hospital.

The patient had a medical relevant history of hypertension, anxious depressant syndrome, both, in medical treatment since 2012. Once before, he presented numbness in palms that were described as symptoms related to anxiety.

Physical examination: mild paresis of the left lower limb, hyperreflexia of lower limbs, ataxic gait in heels with increased support base and altered proprioception.

Brain CT scan and MRI were normal.

Spinal MRI showed hyperintense lesions in the posterior columns, most evident at the cervical spine, which extends the entire length of the spine, without contrast enhancement.

Fibrogastroscopy and biopsy showed atrophic gastritis without *Helicobacter Pylori*.

Blood test: megaloblastic anaemia with decreased serum vitamin B12 levels (22.14 g/L [141-489]) confirmed diagnosis of funicular myelosis.

The patient was treated with intramuscular vitamin B12 three times a week for one month, then, once a week for two months and finally once a month.

After three months during monitoring visits, ataxic gait has improved, but not proprioception.

After one year the physical examination is normal, although patient describes dysesthesia at the column.

Discussion

Funicular myelosis is considered to be the main neurological syndrome in vitamin B12-deficiency.

Clinical and functional symptoms of funicular myelosis and chronic gastritis in patients with B12-deficiency anemia, are most subjective, includes paresthesia, limb weakness, while objective ones includes impaired limb sensitivity. These findings are often related with pathologic changes in gastric mucous membrane.

Keywords: Funicular Myelosis, B12-deficiency, chronic gastritis

Cervical MRI



Hyperintense áreas on T2 weighted images in the posterior columns of the cervical and thoracic cord without contrast.

Thoracic MRI



Hyperintense áreas on T2 weighted images in the posterior columns of the cervical and thoracic cord without contrast.

P-0257

Applicant With Acute Kidney Failure Abdominal Aortic Aneurysm Thrombosis

Ihsan Ateş¹, Nisbet Yılmaz¹, Ömer Akca², Iskender Bülbül², Adem Bahadır², irfan Şencan², Adem Özkara³

¹Department of Internal Medicine, Ankara Numune Training and Research Hospital, Ankara, Turkey

²Department of Family Medicine, Ankara Numune Training and Research Hospital, Ankara, Turkey

³Department of Family Medicine, Çorum Hitite University, Çorum, Turkey

Acute thrombosis abdominal aortic aneurysm (AAA) is a rare complication that can be progressed with paralysis, lower limb ischemia, acute renal failure (ARF), mesenteric ischemia, and aortic aneurysm. We have present applicant with ARF and acute thrombosis case which progress related to infrarenal abdominal aorta aneurysm. Sixty-five years old male patient applied to emergency service, began four hours before sudden loss power and inability to walk. He has got cure lung cancer and hypertension in his biography. On physical examination; vital symptoms are stabil. Heart and respiratory examination were normal but abdominal examination wasn't effective because of obesity. In laboratory, hemogram normal, urea 83mg/dL, creatinine: 5.9mg/dl, AST 744IU/L, LDH: 2222U/L, CK Total: 82700U/L. In renal artery doppler: in abdominal aorta origin of right renal artery approximately 23mm, distal to origin of left artery 19mm approximately 10cm segments, mural thrombus situated on its wall AP diameter reaching 49mm fusiform aneurysm was detected. In CT angiography: in abdominal aorta starting distal about 1.5cm to renal artery ostial, approximately 10cm segment, measured 57x51mm sized in the widest part, measured in thickest part of lumen 22mm, aneurysmal dilatation that has mural thrombus which surrounding aorta was observed. Stent was placed to abdominal aortic part by interventional radiology and anticoagulation therapy was started. 4 weeks after his hospitalization kidney function tests were completely regressed and the patient mobilized.

Abdominal aortic aneurysm in patients with acute aortic aneurysm thrombosis is a rare complication that can be seen in 0.7-2.8%. In the literature, it is emphasized that mortality is over 59%. In the cases that admit with ARF when AAA thrombosis is detected and treated, it is mentioned that the improvement of kidney function of patients in short term. As a matter of fact in our case, after detected AAA thrombosis then stent operation ARF has improved in a short term.

Keywords: Acute thrombosis abdominal aortic aneurysm, acute renal failure, acute thrombosis

P-0258

Rhabdomyolysis Case based on Hypothyroidism

Ihsan Ateş¹, Nisbet Yılmaz¹, Ömer Akca², Adem Bahadır², Iskender Bülbül², İrfan Şencan², Adem Özkara³

¹Department of Internal Medicine, Ankara Numune Training and Research Hospital, Ankara, Turkey

²Department of Family Medicine, Ankara Numune Training and Research Hospital, Ankara, Turkey

³Department of Family Medicine, Çorum Hittite University, Çorum, Turkey

Muscle involvement in hypothyroidism is a rare complication. These patients are often present with decreased muscle mass, cramps and myalgia. With these clinical symptoms increasing muscle enzyme (creatinine kinase, aspartate aminotransferase, lactate dehydrogenase..) suggests the rhabdomyolysis table. Rhabdomyolysis based on hypothyroidism is not a common condition. In these cases, acute kidney failure based on rhabdomyolysis may also be seen. In this case report, a case which detected rhabdomyolysis based on deep hypothyroidism will be discussed.

Seventy-two years old male patient applied to our clinic with the complaints of increasingly widespread muscle pain, muscle weakness and leg cramps. The patient who had total thyroidectomy based on multinodular goiter did not proceed using levothyroxine after surgery. The patient's vital signs during the application; fire: 37.3°C, pulse 55 / min, BP: 130/90 mmHg, respiratory rate 13 / min. On physical examination, cardiac and respiratory were normal, dry skin, decreased turgor tone, bilateral lower extremity trace edema and palpation tenderness in the legs were available. In examined laboratory findings; Urea: 50 mg / dL (17-43), creatinine: 1.3 mg/dL (0.5 to 1.2), AST 94 IU/L, LDH 796 U/L, CK Total: 4370 U/L, Troponin I: 0.021 ng/ml, CK-MB: 8 U/L. TSH: >100 µIU/ml, FT4: <0.15 ng/dL (0.61 to 1.12), St3: 1.04 pg/ml (2.5 to 3.9). 0.6 mcg/kg of levothyroxine treatment was started considering that the patient has rhabdomyolysis based on deep hypothyroidism.

Rhabdomyolysis myoglobin is characterized by muscle cells element escaping into the circulation which include electrolyte and sarcoplasmic proteins (creatinine kinase, aldolases, lactate dehydrogenase, alanine aminotransferase and aspartate aminotransferase) (2). Rhabdomyolysis(3) also known as injuries, crush syndrome, may also present rare with hypothyroidism while it is a situation usually seen after major trauma. Rhabdomyolysis based on deep hypothyroidism, developed in this patient who did not proceed using levothyroxine after total thyroidectomy in this case report.

Keywords: Rhabdomyolysis, Hypothyroidism, creatine kinase

P-0259

Medical Management of Patients Admitted To Family Medicine Clinic with Upper Respiratory Tract Infections Symptoms

Zehra Aslan Aydoğdu, Elif Altunbaş Ateş, Turan Set

Department of Family Medicine, Karadeniz Technical University, Trabzon, Turkey

Background&AIM: Upper respiratory tract infection(URTI) is one of the most experienced diagnosis by family physicians. Although majority of these are viral diseases; they treated with antibiotics. In this study, patients admitted to family medicine clinic with URTI were evaluated as symptomatic or antibiotic treatment approaches.

METHODS: Our study was performed between January-March 2015 period as a cross-sectional study. We evaluated 95 people (consisting of 46 women and 49 men) with the symptoms of URTI. We included patients who are 18 years and older. We performed a short questionnaire which consists of patients age, gender, symptoms, time elapsed since the onset of symptoms, finding and treatment. The data were analyzed.

RESULTS: The median age of patients was 23 (minimum 18- maximum 60). There was no difference between mean age by gender (p:0.455). Complaints in order of frequency were cough, sore throat, fatigue, nasal drip, headache, sputum, fever, postnasal drip and other complaints (Table 1). %69.5 of the patients was treated with symptomatic

drugs and %30.5 with antibiotics. There was no significant difference between the kind of treatment and time elapsed since the onset of symptoms ($p>0.05$).

DISCUSSION: URTI are the most common reasons among patients consulting a physician. While usage of antibiotics ranks fourth in the world, ranks first in Turkey. While in one study which made with examining physician diagnosis of prescriptions of URTI written by general practitioners, antibiotic prescribing rate is 73.8%, in our study this rate is 30.5%. This result shows positive effect of being specialized; but needs to be evaluated with large series. May be reason of writing less antibiotics is detailed history and physical examination. The reason why antibiotics prescribed less in Family Medicine Department could be detailed history and physical examination.

CONCLUSION: Detailed history and physical examination is essential in family medicine. The use of algorithms such as McIsaac (Table 2), Centor criteria's provide convenience in making clinical decisions.

Keywords: Infections, Upper Respiratory Tract, Family Medicine

Table: 2

Criteria	Point
Temperature > 38 °C	1
No cough	1
Tender anterior cervical adenopathy	1
Tonsillar swelling or exudate	1
Age 3-11 years	1
Age 15-44 years	0
Age > 45 years	-1

McIsaac Criteria's

Table: 1

Symptoms	Frequency
Cough	%57.9
Fever	%18.9
Sore throat	%51.6
Postnasal drip	%16.8
Sputum	%24.2
Nasal drip	%34.7
Headache	%32.6
Fatigue	%36.8
Others	%11.6

Complaint Frequencies

P-0260

Clinically meaningful relief of severe sore throat with flurbiprofen 8.75 mg lozenge

Bernard Schachtel¹, Adrian Shephard², Sue Aspley², Gary Smith², Tim Shea³, Kathleen Sanner¹, Laurie Savino¹, Emily Schachtel¹

¹Schachtel Research Company, Jupiter, FL, USA

²Reckitt Benckiser, Slough, Berkshire, UK

³Reckitt Benckiser, Parsippany, NJ, USA

Background & Aim

Patients with sore throat, especially those with more severe symptoms and findings, are the patients who frequently expect antibiotic treatment. However, most of these sore throats are of viral aetiology. Furthermore, the practitioner may be unsure if a non-antibiotic treatment can provide clinically meaningful relief for these patients. One standard for assessing this endpoint is the double-stopwatch (DSW) methodology (Desjardins, Clin Pharmacol Ther 1996;59:130). Using the structure of a randomised, double-blind, placebo-controlled DSW trial, we evaluated the median time to meaningful relief (TMR) by treatment with flurbiprofen 8.75 mg lozenge in patients with relatively severe sore throat.

Method

Adults with sore throat were evaluated for evidence of pharyngitis on the Tonsillo-Pharyngitis Assessment (TPA), an index of seven objective indicators of pharyngeal inflammation. Patients rated the severity of throat soreness on the 0–10 Sore Throat Scale (STS). Patients with relatively severe sore throat (STS >7) and relatively severe pharyngitis (TPA >7) were randomised to suck one flurbiprofen or placebo lozenge. Two stopwatches were started when patients took their assigned lozenge. Patients depressed one stopwatch when they first perceived any relief and the other when they experienced meaningful relief. The TMR was measured for both treatment groups.

Results

There were 51 patients evaluated (flurbiprofen n=43, placebo n=8) with STS >7 and TPA >7. For flurbiprofen-treated patients, TMR was 47.2 minutes, significantly better than placebo (p<0.05). TMR could not be calculated for the placebo group because 87.5% of placebo-treated patients did not experience meaningful relief.

Conclusion

Flurbiprofen 8.75 mg lozenge provides meaningful relief to patients with relatively severe sore throat. Because these are the patients most likely to seek antibiotic treatment, practitioners should consider recommending a treatment such as flurbiprofen 8.75 mg lozenge as many of these patients will experience meaningful relief and unnecessary antibiotics can be avoided.

Keywords: pharyngitis, flurbiprofen, non-steroidal anti-inflammatory agent, antibiotics, upper respiratory tract infection

Table 1. Objective features on the Tonsillo-Pharyngitis Assessment

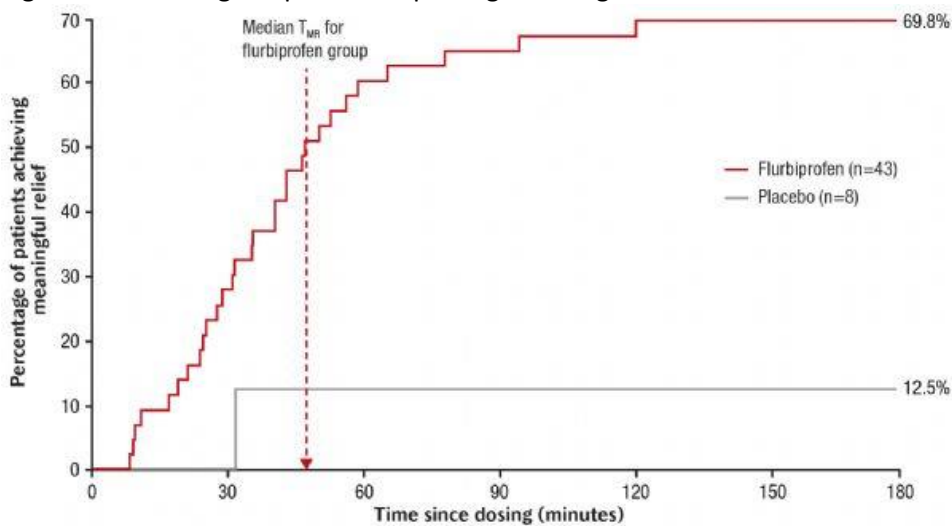
Item	0 Point	1 Point	2 Points	3 Points
Oral temperature	≤98.6°F	98.7–98.9°F	99.0–99.9°F	≥100.0°F
Oropharyngeal colour	Normal/pink	Slightly red	Red	Beefy red
Size of tonsils	Normal/absent	Slightly enlarged	Moderately enlarged	Much enlarged
Number of oropharyngeal enanthems (vesicles, petechiae or exudates)	None	Few	Several	Many
Largest size of anterior cervical lymph nodes	Normal	Slightly enlarged	Moderately enlarged	Much enlarged
Number of anterior cervical lymph nodes	Normal	Slightly increased	Moderately increased	Greatly increased
Maximum tenderness of some anterior cervical lymph nodes	Not tender	Slightly tender	Moderately tender	Very tender

Table 2. Baseline demographics and characteristics

Characteristic	Flurbiprofen 8.75 mg (n=43)	Placebo (n=8)	Overall (N=51)
Age, mean (SD), years	19.5 (2.0)	19.6 (1.3)	19.5 (1.9)
Female, n (%)	22 (51.2)	6 (75.0)	28 (54.9)
TPA total score, mean (SD)	9.8 (2.6)	10.3 (2.8)	9.9 (2.6)
PAIN, n (%)			
No inflammation	0	0	0
Mild inflammation	9 (20.9)	2 (25.0)	11 (21.6)
Moderate inflammation	29 (67.4)	6 (75.0)	35 (68.6)
Severe inflammation	5 (11.6)	0	5 (9.8)
STS score, mean (SD)	7.4 (1.0)	7.3 (1.0)	7.4 (1.0)
STPIS score, mean (SD), mm	73.8 (9.7)	73.8 (9.4)	73.8 (9.7)

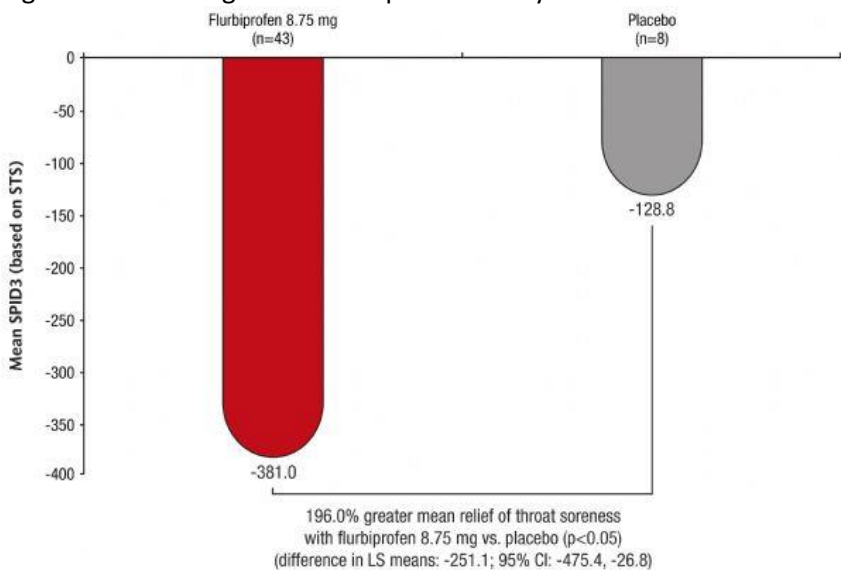
PAIN, Practitioner's Assessment of Pharyngeal Inflammation; SD, standard deviation; STPIS, Sore Throat Pain Intensity Scale; STS, Sore Throat Scale; TPA, Tonsillo-Pharyngitis Assessment

Figure 1. Percentage of patients reporting meaningful relief



TMR, time to meaningful relief

Figure 2. Time-weighted sum of pain intensity differences over 3 hours



CI, confidence interval; LS, least square; SPID3, time-weighted sum of pain intensity differences over 3 hours; STS, Sore Throat Scale

Table 3. Adverse events during the 3-hour observation period

	Flurbiprofen 8.75 mg (n=43)	Placebo (n=8)	Overall (N=51)
Patients with AEs, n (%)			
Any AE	4 (9.3)	0	4 (7.8)
Most common AEs*			
Nausea	2 (4.7)	0	2 (3.9)

AE, adverse event *AE affecting >1 patient in either treatment group

P-0261

Meningioma, guilty or just a random finding?

Sara Matos Moreira, Gabriela Silva Poças, Luis Monteiro Magalhães
USF Leça, Unidade Local de Saúde de Matosinhos, Matosinhos, Porto, Portugal

BACKGROUND: 45 year old Woman, smoking history; dyslipidemia; persistent anxiety with hypochondriacal traits; depressive syndrome; mixed urinary incontinence; fibrocystic breast disease; multinodular goiter (hemithyroidectomy); endometriosis (adnexectomy).

Medication: Trazodone; Mirtazapine; Alprazolam; Simvastatin

AIM: Reflection on the clinical practice aiming to improve the health care's quality.

METHOD: Case report.

RESULTS: Recurrent fainting with four months evolution, when lifting the arms above shoulder level, caused by hyperextension of the upper limbs. Without loss of consciousness. Summary neurological exam without changes. Asked for an opinion to the Neurology, which suggested performing Doppler Carotid for exclusion of thoracic outlet syndrome. The examination revealed no relevant clinical changes.

By persistent complaints of sporadic fainting, 15-20 episodes since start, with variable intensity and frequency, is referred to Neurology, which requested tests to exclude vascular, structural and epileptic causes.

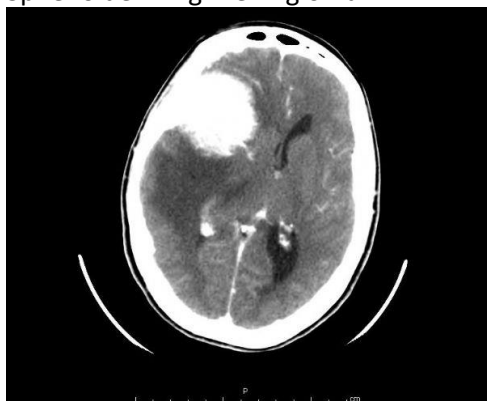
On the day of Computed Tomography (CT) skull-brain scan was referred to the emergency for it was found an occupying lesion of extra-axial space, frontobasal and right temporal lobe, suggestive of sphenoid wing meningioma, with extensive vasogenic edema and mass effect. Right lateral ventricle and third ventricle collapsed and subfalcine herniation. Left ventricular dilation presenting bulging contours indicating hydrocephalus in formation. Contacted the Neurosurgery, which by looking at imaging findings and despite the patient being asymptomatic gave order for hospitalization for further macroscopic resection of the meningotheial meningioma.

CONCLUSIONS: The differential diagnosis of this clinical case is most likely of vascular etiology. However, ruling this etiology out and assuming other entities, such as epilepsy, it is excluded due to clinical and normal electroencephalogram.

Other hypothesis could be structural pathology, which is why we asked for CT skull-brain scan to confirm the diagnosis.

Keywords: Recurrent fainting; meningotheial meningioma

Sphenoide Wing Meningioma



Computed tomography skull-brain scan with an intravenous contrast agent.

P-0262

An evidence-based overview with a primary care perspective on piriformis syndrome causing sciatica

Kevork Hopayian

Norwich Medical School, University of East Anglia, Norwich England

Background and Aim

Nerve root compression by a herniated intervertebral disc or spinal canal stenosis has long been the disease model for sciatica. A cause is not found in a significant proportion of cases. Entrapment of the sciatic nerve, piriformis syndrome (PS), as a cause remains controversial yet potentially could explain many cases for which no cause is found. This study was designed to provide an overview of the evidence on the prevalence, diagnostic criteria and treatment of PS.

Method

Medline, Embase, CINAHL and AMED databases were searched using a broad search strategy. All types of observational and intervention studies were eligible for inclusion. Study heterogeneity was too great for pooling so a descriptive synthesis was planned. The quality of studies was evaluated by assessment of risk of bias.

Results

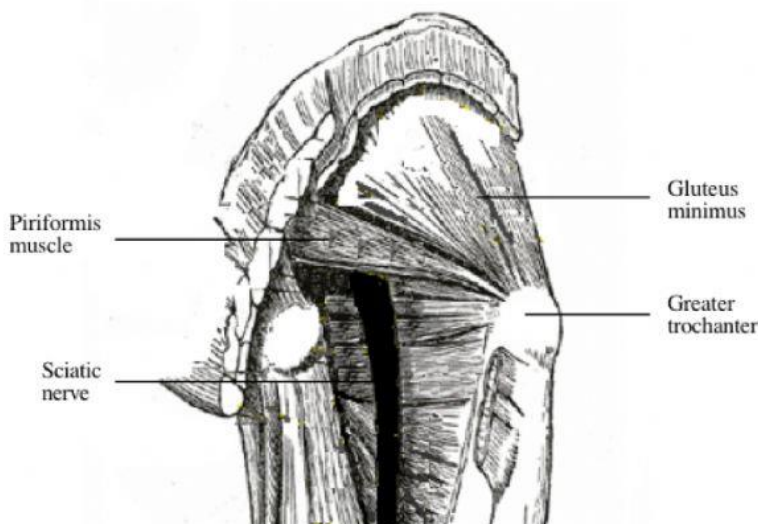
The number of related publications has multiplied in the past three decades. Modern imaging studies provide strong evidence for the condition. Only two out of 23 reviews have used systematic methodology. The quality of primary studies was generally poor to moderate. Moderately strong evidence suggests that PS accounts for 6 to 10% of sciatica cases. Moderately strong evidence suggests that diagnosis can be made on clinical grounds using techniques for localising soft-tissue disorders already familiar to family physicians. Weak to moderate evidence exists for the effectiveness of physiotherapy and injection therapy. Before-and-after studies provide evidence for surgical release in selected cases.

Conclusions

PS is a real entity. While it may be uncommon, it may form a significant proportion of unexplained cases of sciatica. The evidence suggests that clinical diagnosis by family physicians is feasible and that appropriate treatment in the form of physiotherapy can be provided in primary care. Future research should be directed at establishing the accuracy of diagnosis and improving the quality of studies of treatment.

Keywords: Sciatica, piriformis syndrome, diagnosis, treatment, overview.

Fig 1 Anatomical relations of sciatic nerve and piriformis muscle



Posterior view, glutei maximus & medius resected

Table 1 Epidemiology Age and Sex

Study	Michel 2013(1) N = 250	Singh 2013(2) N = 182
More common in women	1.3% (1.02, 1.58)	5.5 (3.69, 8,29)
♀:♂ ratio		
More common in middle age	Average 46 years (± 11)	Peak 41-50

Results from secondary care

Fig 2 Prevalence

Figure 2 Prevalence in secondary care from case reports and series

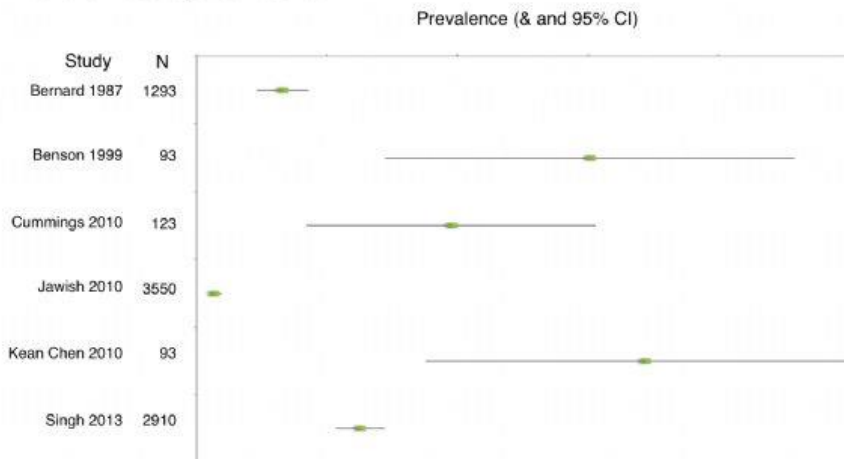


Fig 3 Frequency of clinical features

Figure 3 Summation of frequency of reported clinical features in case reports and series with individual data

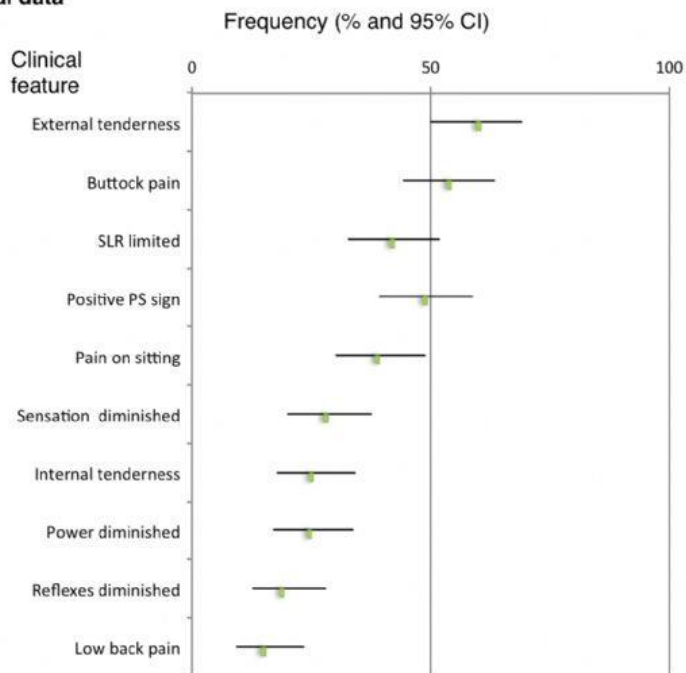


Table 2 Results from trials

Study (Type)	Experimental (N)	Control (N)	Outcome	Result
Childers 2002(11) (crossover trial)	Botulinum toxin A injection into PM crossover to placebo (9)	Placebo injection into PM cross over to botox (9)	Pain, Spasm, Activities, Disability 10 point VAS	All VAS scores lower at end of BTX-A phase than placebo
Masala 2010(12) (Open, pragmatic trial)	Steroid + local anaesthetic injection into PM (13)	Usual care (10)	Pain on 10 point VAS	At 2 months VAS botox 1 vs usual care 5
Michel 2013(1) Open trial	122 patients not improved by physiotherapy in open trial	No control	Pain relief categorical	Good or very good 94 (77%) average 8 (7%) poor in 19 (16%)

Results from 3 trials, VAS = Visual Analogue Scale

P-0263

Evaluation of Corrosive Esophagitis and Importance of Preventive Medicine

Aysenur Alper Gurz¹, Fusun Artiran Igde¹, Yasemin Bilgin Buyukkarabacak², Aysen Taslak Sengul², Selcuk Gurz²

¹Department of Family Medicine, Ondokuz Mayıs University, Samsun, Turkey

²Department of Thoracic Surgery, Ondokuz Mayıs University, Samsun, Turkey

Background&AIM: Accidents are one of the main factors that shorten healthy life. All over the world, corrosive esophagitis is a serious problem that threatens life. These accidents increase by accessing generic cleaning supplies easily and taking preventive medicine measures inadequately. The aim of this study was to determine the demographic characteristics of people who had corrosive esophagitis and ensure the public awareness about these accidents.

Material&METHOD: We reviewed patients' files who hospitalized about corrosive esofagitis between January 2002 and December 2013, in Ondokuz Mayıs University, Department of Thoracic Surgery. 33 of 264 patients were excluded from the study because of taking corrosive for suicide.

RESULTS: 120 of the patients were women and 111 were men. Their age varied between 17 and 88 and the mean age was 40.2 years. 3% of them had a history of mental retardation and 33.6% of them smoked. The highest amount of accidents occurred in summer (38.5%). The ingested materials were bleaches (38.5%), nitric acid (21.6%), muriatic acid (8.2%). Only 3.9% of these products were branded. Patients were subjected wrong practices such as feeding with yogurt (14.8%) and drinking water(4.4%). Patients were hospitalized for 1 to 33 days. Also, average of 9.9 days in this period, they had prohibited oral intake.

Conclusions: It can be concluded that the subject of 'securing the living space' which is included in primary preventive medicine is one the main practice of family physicians. The role of the family physicians is very crucial since they are the first step of the health system.

Keywords: Caustics; Esophagitis; Preventive Medicine

P-0264

The optimization of the nurse competencies in the management of acute disease in Primary Health Care

Gemma Puig Ponsico, Esther Díaz Salcedo, Cristina Gallardo Sánchez, Mònica Torremorell Núñez, Yolanda Espinosa Nieto, Maria Carmen Serrano Lozano, Asunción Juste Marin, Maria Rosario Mateo Gambarte, Carmen Úbeda García, Jaime Hernández Fernández, Alicia Blanco Díaz
Institut català de la Salut

Background and AIM

Primary health care (PHC) teams are the gateway in our health care system(HCS). Therefore, it is reasonable thinking about new organizational strategies to improve the efficiency of HCS and optimize the potential of each professional without implying a decrease in the quality of patient care. The nurse has a portofolio of own services among which care for people in acute pathology is contemplated.

The main objective is to analyze the results after designing a protocol where the nurse can provide coverage to the demand for acute pathology in a autonomous way.

Method

A retrospective cross-sectional descriptive study of the years 2013-2014 included all visits/year resolved by the nurse of patients who consult for acute pathology in our center. The motives for consultation that were included in the protocol were: anxiety attacks, emergency contraception, burns, diarrhea, acute low back pain, epistaxis, wounds, skin lesion zone fold, urinary discomfort, sore throat, toothache, elevated blood pressure, respiratory symptoms, ankle sprains, red eye, ear pain, flu, neck pain, contusions, fever, dizziness and bites.

Results

The population assigned to our heath area was 19,777 users, the average total visits/year in the period 2013-2014 were 119,846 (79,494 made by medical professionals and 40,352 nursing) Nursing solved 2,378 visits/year corresponding acute pathology consultations (5.89% of total visits made by nurses). The motives for consultations most visited were: wounds (34.29%), urinary tract symptoms (16.57%), respiratory symptoms (8.54%), neck pain (5.98%), acute diarrhea (5, 33%), burns (4.3%), back pain (3.7%), elevated blood pressure (3.59%).

Conclusion

The nurse has the necessary competencies to visit acute pathology.

Pathologies that nurses resolved more are wounds, urinary discomfort, respiratory symptoms, sore throat, diarrhea, burns, back pain and elevation of blood pressure.

The fact of having a protocol designed, helps keep the quality standards in this care process.

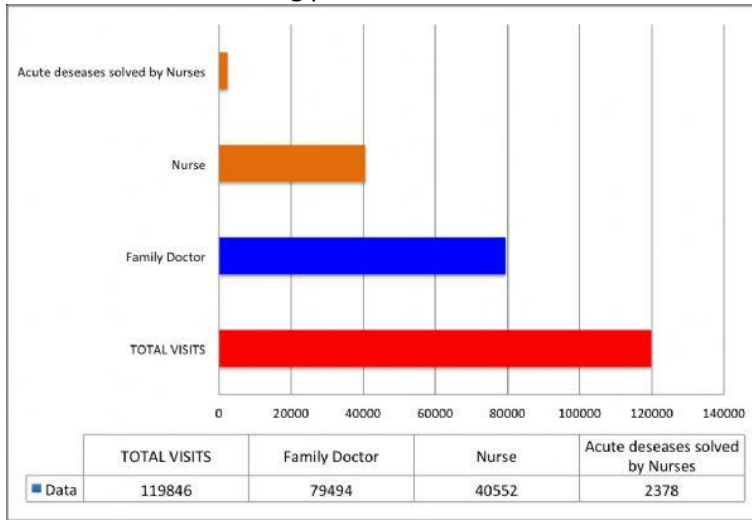
Keywords: nurses, primary health care, acute diseases

Protocol management of spontaneous demand

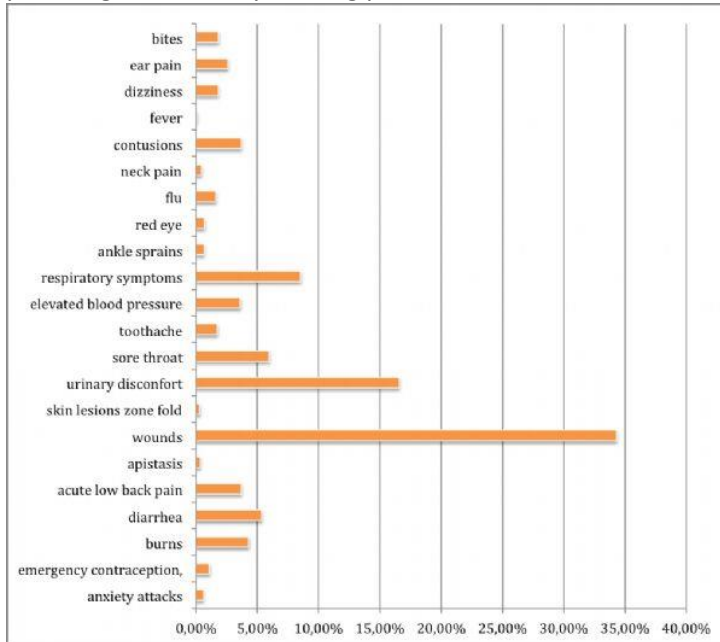
(http://www.gencat.cat/ics/professionals/pdf/gestio_demanda_espontania.pdf)



Visits distribution among professionals



pathologies solved by nursing professionals



P-0265

Chronical cough: The most unthinkable diagnosis

Gaston Ezequiel Vazquez, [Gemma Rovira Marcelino](#), Beatriz Jimenez Muñoz, Jordi Joseph Vilaplana, Helena Ferrer May, Rodrigo Perla San Martin, Clara Madueño Garro
EAP Sardenya, Barcelona, Spain

A 50 year-old female with gastroesophageal reflux history, presented to our health center referring non-productive cough started three weeks ago with no other symptomatology. The examination was normal, and omeprazole and loratadin was started as symptomatic treatment. Three month later, she is still with cough adding episodic acute left chest pain so chest X-ray was demanded for chronic caught study as per local guide. The examination revealed a homogenous mediastinal density in the left cardiophrenic angle. Continuing the study of mediastinal density a thoracic CT was performed finding a pericardial effusion located in the left cardiophrenic angle of 72 x 40 mm corresponding to a possible pericardial cyst. Pericardial cysts are usually asymptomatic. Symptoms are usually due to compression of adjacent organs and include atypical chest pain, dyspnea, and persistent cough. Pericardial cyst have an incidence rate of 1/100.000, they are rare mediastinal abnormalities. Most are congenital. The size varies from 2 to 28cm and the most common locations are middle mediastinum and right cardiophrenic angle (3/4), but in our case the location is unique, in the left cardiophrenic angle. Routine X-ray generally makes diagnosis incidentally. The confirmation is made by contrast Computed Tomography (CT) or echocardiography imaging.

CLINICAL TRIAL:

Pericardial cysts (72 x 40 mm)

DIFERENTIAL DIAGNOSIS:

Common causes: Gastroesophageal reflux, rhinitis, sinusitis, post-infection, tuberculosis, Iatrogenic/Drugs

Uncommon causes: Lung cancer, congestive heart failure, chronic aspiration, B. pertussis, pulmonary embolism, pleural effusion or other pleural or mediastinal tumors.

FINAL COMMENT:

Chest X-ray is needed to make differential diagnosis of atypical chronic cough and chest pain because incidental findings like mediastinal abnormalities could be a rare but possible finding. We describe an unusual presentation, which was diagnosed during the evaluation of non-productive chronic cough. GP should be persistent in common pathology study to rule out rare but treatable causes of them.

Keywords: Chronical cough, pericardial cyst, mediastinal abnormality

Pericardial cysts (72 x 40 mm)

P-0266

Prolonged "tonsillitis" in a young woman

Diogo Alves, [Gui Santos](#)

Unidade de Saúde Familiar Villa Longa

Background and AIM: In primary healthcare the family Physician must frequently manage illness which presents in an undifferentiated phase and has the additional responsibility of making efficient use of health-care resources. This case aims to illustrate these competences of the family physician who must often coordinate care work with other professionals and take an advocacy role for the patient.

METHODS-RESULTS: 27 year old female, belonging to a Duval phase 3 nuclear family, allergic to penicillin, who, in an urgent consultation, complains of pain in the right hemiface, exacerbating with mastication, and presenting oedema and pain in the right cervical region. A dental abscess is diagnosed and medicated with cefuroxime. 18 days later, due to progressive worsening, with fever, tonsillar purulent exudate, odynophagia and painful right-side cervical adenomegalia, she is referenced to the local hospital, for observation by otorhinolaryngology. In the emergency room the patient was not observed by otorhinolaryngology, but discharged with instructions

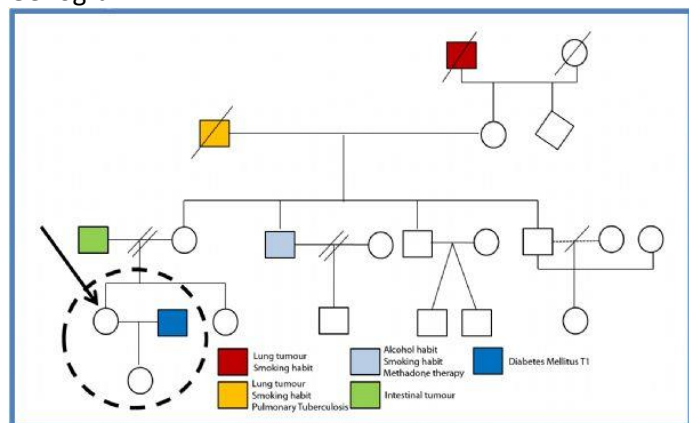
touse a mouthwash. 38 days after the initial symptoms, the patient presents right side cervicalgia, poliartralgia, weight loss, fever and a 3cm tumefaction in the right cervical region.

The clinical condition did not improve and led, 61 days after the initial symptoms, to the diagnosis of Hodgkin Lymphoma confirmed by ganglion biopsy.

CONCLUSIONS: This case emphasizes the importance of a better articulation between family physicians and hospital doctors regarding the patients' best interest.

Keywords: Family Medicine; Primary Healthcare; Hodgkin Lymphoma; Otolaryngology

Genogram



P-0267

Angiotensin-converting enzyme inhibitor-induced angioedema: an undiagnosed case report

Erica Mendes

UCSP de Tarouca, ACES Douro Sul, Tarouca, Portugal

BACKGROUND & AIM: Angiotensin-converting enzyme inhibitors (ACEi) are one of the most effective, well tolerated and prescribed antihypertensive drugs worldwide. Like other medications, there are some adverse effects and angiotensin-converting enzyme inhibitor-induced angioedema (ACEiIA) is one of them, with a reported incidence ranging from 0,1 to 2,2%. The ACEiIA normally resolves without treatment within hours or days but it can potentially be fatal and is commonly underdiagnosed. This report aims to describe an undiagnosed case of ACEiIA.

METHOD: To make this report we used the clinical process complemented with a bibliographical research.

RESULTS: A hypertensive 71 year old man patient was medicated in December 2013 with an ACEi (lisinopril). In 2014 he presented 3 episodes of unilateral upper lip swelling that were resolved. In January 2015 he presented to the emergency service with an 8 hours history of tongue swelling. There was no rash, pruritus or another symptom. He was treated with oral corticosteroid and his symptoms improved within 24 hours. After, he was observed by his family physician (FP) who reviewed his history and prescription. He was diagnosed an ACEiIA, confirmed after lisinopril suspension and resolution of the angioedema.

CONCLUSION: The ACEiIA diagnosis is clinical and is frequently undiagnosed, especially in patients with mild clinical presentation. This case highlights the importance of clinical history and evaluation of these patients in order to make an early and appropriated diagnosis. It is essential to immediately discontinue any ACEi therapy and provide supportive care. The efficacy of epinephrine, antihistamines, or corticosteroids remains controversial. Antagonists of bradykinin or concentrates of C1 inhibitor are being studied to use in the ACEiIA treatment. The FP plays a crucial role in the diagnosis and treatment of ACEiIA, and sometimes only the integration of information by the FP allows a correct diagnosis of undiagnosed cases.

Keywords: Angioedema, Angiotensin-Converting Enzyme Inhibitors, Drug-Related Side Effects

P-0268

Case Report: Choroidal Melanoma Presented as Unilateral Angle Closure Glaucoma

Milica Brkic, Kristina Markovic, Marko Stankovic, Veroslava Maksimovic, Ana Krivokapic
Department of General Medicine, Health Center "Dr Simo Milosevic", Belgrade, Serbia

INTRODUCTION: Choroidal melanoma is the most common eye malignancy, but still a rare condition (2-8 cases per 1000000 people in Europe). Most patients are asymptomatic, others may experience flashing light, floaters or loss in visual field. There are few reported cases of choroidal melanoma presented as angle closure glaucoma.

CASE: 80 years old man consulted GP for pain and redness of his left eye, pupil dilatation and visual loss that he developed during last 3 days. He had no previous medical history, but family history of cutaneous melanoma. The affected eye showed fixed mydriasis, conjunctival chemosis and no light perception. Intraocular pressure was 40 mmHg in the left and 14 mmHg in the right eye. He was referred to ophthalmologist who prescribed medical therapy. The pain continued despite medication and after initial decrease of intraocular pressure as low as 28 mmHg, it rapidly increased up to 55 mmHg. Eye ultrasonography revealed choroidal melanoma complicated with retinal ablation and intraocular hemorrhage. Due to complete visual loss and uncontrolled intraocular pressure causing severe pain, enucleation was performed. Histopathology confirmed choroidal melanoma with transscleral penetration and vorticosae vein infiltration. After 3 months follow-up, no metastases occurred.

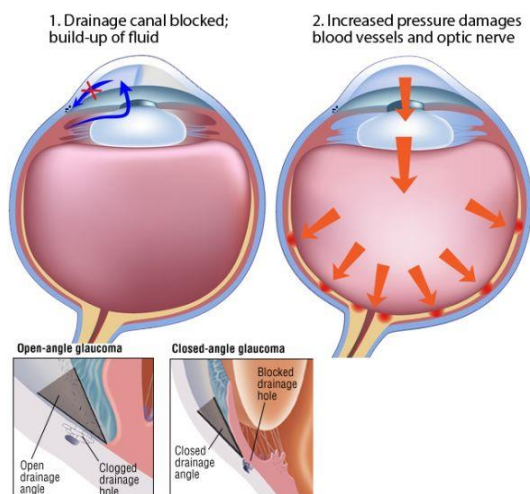
CONCLUSION: Every case of angle closure glaucoma should be evaluated carefully with insisting on imaging methods in order to rule out secondary causes, especially because early diagnosis and smaller intraocular melanomas are associated with better prognosis. Family history of melanoma should always draw our attention.

Keywords: choroid, melanoma, angle closure glaucoma

clinical presentation



pathophysiology of glaucoma



choroidal melanoma



Choroidal melanoma is the most common eye malignancy, but still a rare condition (2-8 cases per 1000000 people in Europe). Most patients are asymptomatic, others may experience flashing light, floaters or loss in visual field. There are few reported cases of choroidal melanoma presented as angle closure glaucoma.

P-0269

Abdominal pain and longstanding constipation without improvement

Antonio Ubiña Carbonero¹, Julian Zarco Manjavacas², Carmen Maria Lopez Rios¹, Francisco Jose Cervilla Suarez²

¹CS Victoria

²CS El Palo

Personal History: No known drug allergies. In tamsulosin for BPH. No other relevant history. Smoking 4-5 cigarettes / day.

Anamnesis: 61 year old male who came to casualty with abdominal discomfort and constipation 9 days duration with 2 isolated episodes of rare and hard defecations. No vomiting or fever during the process. Previously consulted with diagnosis of urinary tract infection and was prescribed him antibiotics amoxicillin-clavulanate without improvement. Denies expulsion of gases in recent days. Hyporexia associated with abdominal discomfort.

Physical examination: Abdomen: globular, soft and palpable, no masses or organ enlargement. Bowel sounds present. Murphy negative. Positive Blumberg. Pain on deep palpation and irritation voluntary defense in hypogastric region and right iliac fossa. Digital rectal: sphincter competent, no palpable masses, dedil goes stained dregs remains, no other medical products. Rest of examination: no significant findings.

Complementary tests: Blood test: leukocytes 15900 (N 80.5%, L 9.8%), C-reactive protein 172. Abdomen X-ray: without significant disturbance. Abdominal US: wall thickening of bowel loops in pelvis. Abdominal CT with contrast: complicated appendicitis with plastron and collections.

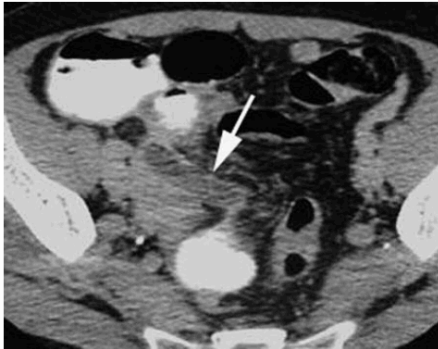
Diagnosis: appendicitis vs intestinal obstruction.

Evolution: according to the findings, is contacted Surgery for case valuation by deciding to conservative management.

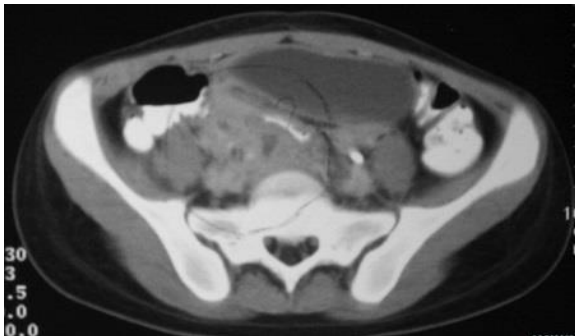
CONCLUSION: the occurrence of appendicitis in patients of advanced age between symptoms may include bowel obstruction, so that in these cases the physical examination is a useful tool to guide the diagnosis.

Keywords: abdominal pain, constipation, intestinal obstruction

Abdominal CT



Abdominal CT



P-0270

Abdominal pain in patient with hyperglycemia

Antonio Ubiña Carbonero¹, Julian Zarco Manjavacas², Carmen Maria Lopez Rios¹, Francisco Jose Cervilla Suarez², Gloria Amaranta Martinez Alonso²

¹CS Victoria

²CS El Palo

Personal History: No known drug allergies. Unremarkable history. Family history of diabetes (mother and father insulin therapy, siblings oral antidiabetic treatment).

Anamnesis: Man of 35 years admitted with symptoms of pain in the left abdomen of 5 days duration that appears after ingestion and is accompanied by dry mouth, polydipsia, polyuria, weight loss (8 kg in a week), heartburn, nausea and vomiting of food content that does not relieve pain. Pain unirradiated. No fever. No changes in bowel habits. No voiding syndrome. Similar episode a month earlier, which partially resolved with use of omeprazole

Physical examination: Abdomen soft and palpable, no masses or organ enlargement, tenderness to palpation in epigastric region, left upper quadrant and flank, without defense or peritonitis, Blumberg and Murphy negative. Rest of exploration without findings.

Complementary tests: Blood test: glucose 358 mg/dl, pH 7.22, HCO₃ 11.2 mmol/L, EB -14.9 mmol/L. Urinalysis: glucosuria (4+), ketonuria (3+). Chest X-ray: no significant findings. Abdomen X-ray: no significant findings.

Diagnosis: diabetic ketoacidosis in debut

Evolution: fluid therapy is initiated and insulin infusion with rapid-acting insulin to control blood glucose levels and normalize the pH. After several hours with this treatment, the analytical tests show improvement in the numbers of blood gases (pH 7.33) with good diuresis and good overall condition. After that, patient admission charge of Endocrinology for diabetes education.

CONCLUSION: abdominal pain associated with the cardinal symptoms may be one of the symptoms of diabetic ketoacidosis appearance in both diabetic debut and decompensation in a poorly controlled diabetes.

Keywords: abdominal pain, hyperglycemia, metabolic acidosis

Chest X-ray



Abdominal X-ray



P-0271

Dyspnea in women with reduced mobility

Antonio Ubiña Carbonero¹, Julian Zarco Manjavacas², Carmen Maria Lopez Rios¹, Francisco Jose Cervilla Suarez²

¹CS Victoria

²CS El Palo

Personal History: No known drug allergies. Schizophrenia. Current treatment: clomipramine, topiramate, Adiro, trimipramine, alprazolam, propranolol.

Anamnesis: 78 year old woman who comes to the emergency department brought by ambulance by feeling fatigue of recent onset. The family refers pallor and decay. In the last 48 hours she has submitted hip pain for which has taken anti-inflammatory. Concerns in recent days dyspnea with ambulation with a walker. Discuss cold symptoms in previous days without expectoration, well tolerated. 112 ambulance objectives hypotension (70/38) and 94% O2 Sat at initiating perfusion with saline and transferred to Hospital.

Physical examination: mucocutaneous pallor. Cardiac auscultation: rhythmic and regular tones, no murmurs.

Respiratory auscultation: vesicular murmur preserved without stridor or wheezing. Rest of examination: anodyne.

Complementary tests: Blood test: leukocytes 19610 (N 94.4%, L 3.1%), D dimer 19261.9, urea 109, creatinine 2.97, LDH 342, lactate 3.7, C-reactive protein 206. Gas analysis: pH 7.252, PCO2 43, PO2 22.9, HCO3 18.6, EB -7.3.

Angio-CT: no signs of PTSD are objectified.

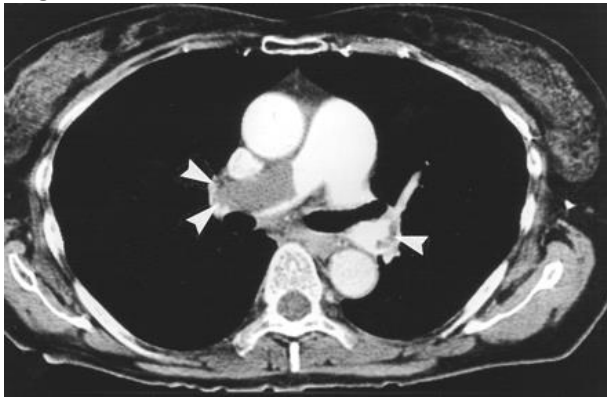
Diagnosis: respiratory origin likely sepsis

Evolution: the patient is admitted to the observation area to start treatment with fluid therapy, antibiotics; blood and urine cultures being filed.

CONCLUSION: the differential diagnosis of dyspnea in an immobilized patient should include screening for PTSD.

Keywords: dyspnea, hypotension, reduced mobility

Angio-CT



P-0272

Gait disturbance in polymedicated patient

Antonio Ubiña Carbonero¹, Carmen Maria Lopez Rios¹, Julian Zarco Manjavacas², Francisco Jose Cervilla Suarez², Maria Vilchez Jaimez¹

¹CS Victoria

²CS El Palo

Personal History: No known drug allergies. Ex smoker for 40 years. Dependent for basic activities of daily living. Hypertension, Chronic obstructive pulmonary disease, permanent atrial fibrillation, acute myocardial infarction in 2007, senile dementia, prostate cancer 15 years ago. Current treatment: pantoprazole, Adiro, triflusal, torasemide, amiodarone, spironolactone, isosorbide mononitrate, Atrovent, Ventolin, Spiriva, lorazepam, Tardyferon.

Anamnesis: 85 year old male who came to emergency department with gait disorders and swallowing liquids difficulties. 8 days prior consultation regarding benzodiazepine poisoning episode. Since then, her daughter refers that he did not complete improvement of the medical picture with persistent unstable gait and exacerbation of symptoms of dementia with worsening at night. It is derived from the Primary Care Centre to screen for new cerebrovascular event.

Physical examination: Neurological examination: no alteration of cranial nerves. No alterations in the strength or sensitivity, unstable gait with small shuffling steps. Osteo-tendon reflexes present. Rest of exploration: anodyne.

Diagnosis: stroke vs pharmacological intoxication.

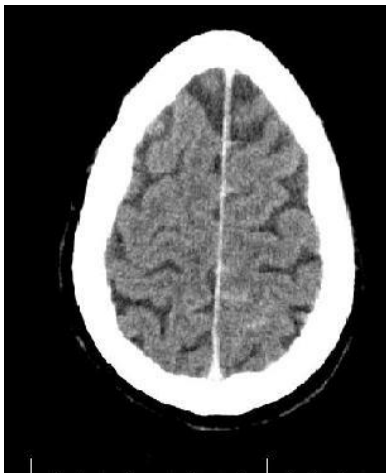
Complementary tests: Blood test: no significant findings. Urinalysis: nitrites +, leukocytes +++. Benzodiazepines positive. Cranial CT: marked enlargement of the lateral ventricular system and of the third ventricle, which could be related to normal pressure hydrocephalus; hypoattenuation of the periventricular white matter; marked sulcus along convexity in relation to cortical atrophy.

Evolution: the patient was discharged with follow-up by Neurology consultation in the Memory Unit for organization of further tests and follow-up by Neurosurgery consultation.

Conclusion: the appearance of symptoms of dementia in elderly patients with polypharmacy forces us to look for possible causes such as infection or intoxication, in addition to rule out a cerebrovascular event.

Keywords: ataxia, polymedicated patient, dementia

Cranial CT



P-0273

Be careful with metoclopramide

Julián Zarco Manjavacas¹, Antonio Ubiña Carbonero², Carmen María López Ríos², Juan Pablo García Paine³, Juan Paz Galiana⁴, Gloria Amaranta Martínez Alonso¹

¹C.S. El Palo, Málaga, Spain

²C.S. Victoria, Málaga, Spain

³Department of Emergency, H. Parque San Antonio, Málaga, Spain

⁴Department of Emergency, H. General de Tomellos, Tomelloso, Ciudad Real, Spain

Personal History: female, 18 years. In the current moment in treatment with metoclopramide by vomiting

Present Illness: patient come with difficult to mobilize both hands and jaw.

Physical Examination: Good overall condition. Muscular spasms in jaw and in both hands.

Diagnosis: extrapyramidal symptoms.

Evolution: after treatment with biperideno the patient presents disappearance of symptoms.

CONCLUSION: sanitary professionals have to be careful with adverse reactions of medications we prescribe because the problems they can cause.

Keywords: Extrapyramidal symptoms, drugs adverse effects, metoclopramide

Muscular spasm



P-0274

Progressive edema of lower limbs and choloria in patients with Diabetes Mellitus

Antonio Ubiña Carbonero¹, Nerea Canton Cuadrado³, Julian Zarco Manjavacas², Carmen Maria Lopez Rios¹, Francisco Jose Cervilla Suarez²

¹CS Victoria, Malaga, Spain

²CS El Palo, Malaga, Spain

³CS Trinidad, Malaga, Spain

Personal History: No known drug allergies. Dyslipidemia, type-II diabetes. Current treatment: omeprazole.

Anamnesis: 48 year old woman was admitted to observation area to present lower limb edema following thighs until 2-3 months duration. Previously she had never submitted. Treated by her GP with diclofenac, but since then refers darker and turbid urine.

Physical examination: dryness of mucous membranes. Respiratory auscultation: bibasilar crackles. Abdomen: globular, wall edema, pain on deep palpation, positive left renal percussion. Pitting edema to root thighs. Rest of examination: anodyne.

Complementary tests: Blood test: leukocytes 15400 (N 14500), glu 567, C-reactive protein 109. Abdominal US: bilateral pleural effusion in abundant amount, left kidney with poor corticomedullary differentiation and air in the urinary tract. Abdominal CT: emphysematous cystitis, urethritis left emphysematous, left kidney emphysematous pyelonephritis (type II Wan), generalized edema of the subcutaneous cellular tissue, bilateral pleural effusion in abundant amounts. Portable echocardiography: no pathological findings.

Diagnosis: cystitis / urethritis / emphysematous pyelonephritis in poorly controlled diabetic patient with nephrotic syndrome associated probable.

Evolution: Urology valued by deciding nephrostomy catheter placement by Vascular Radiology, leaving frank hematuria. Subsequently, log in charge of Urology for IV antibiotic treatment, but during admission have worsening overall for decompensated heart failure recent diagnosis that requires transfer to ICU for hemodynamic stabilization.

CONCLUSION: urinary tract infections are very common in diabetic patients with poor control, so that before the appearance of signs of infection in these patients, physical examination and imaging tests realization is essential for the correct diagnosis of these pathologies with high rates mortality.

Keywords: choluria, edema, diabetes mellitus

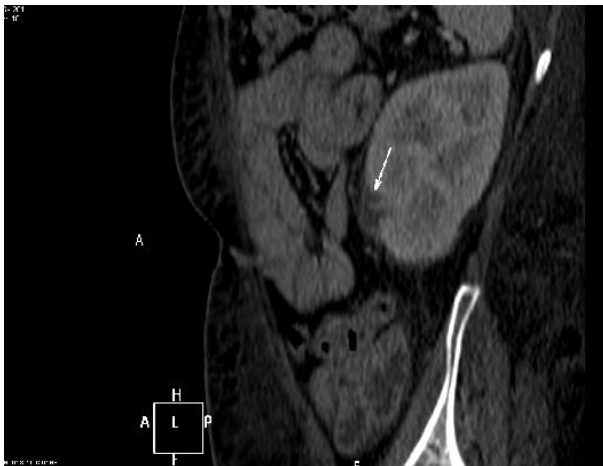
Abdominal CT



Abdominal CT



Abdominal CT



P-0275

The risks of urban sports

Julián Zarco Manjavacas¹, Carmen María López Ríos², Antonio Ubiña Carbonero², Juan Pablo García Paine³, Enrique Alarcón Pariente¹, Francisco José Cervilla Suárez¹

¹C.S. El Palo, Málaga, Spain

²C.S. Victoria, Málaga, Spain

³Department of Emergency, H. Parque San Antonio, Málaga, Spain

Personal History: male, 24 years.

Present Illness: patient come after crash while he was practicing skateboarding.

Physical Examination: Good overall condition. Pale. Pain in lower limbs and difficulty to move them. Pain to palpation in pubic region.

Complementary tests: no alterations in blood test. Pelvic CT: inferior left ramus pelvic fracture. Sacral wings bilateral compression fracture.

Diagnosis: sacrum and pelvis fracture.

Evolution: in control blood test, the patient present hemoglobine in 9.1 (previously 13.5) asymptomatic. Admitted in Traumatology plnat.

CONCLUSION: sports and lifestyle have consequences in health of our patients and produce atypical injuries unrelated with the age of the patient.

Keywords: lifestyle, pelvis fracture, anemia

P-0276

TRANSFUSIONS and PRIMARY CARE

Juan Jesus Rodriguez Vallejo¹, Hector Leonardo Lugo Ramos², Pedro Guijo Gonzalez¹, Jose Maria Fernandez Gonzalez¹

¹Hospital Jerez de La Frontera

²CS Delicias

OBJECTIVES

At present, the role of the family doctor in blood transfusions is poorly documented

In order to reflect this action, we have prepared this work with the following OBJECTIVES:

Describing blood transfusions performed in an emergency department.

Evaluate the adequacy of referrals from primary care for transfusion in patients at risk.

MATERIALS AND METHODS

Retrospective study in the emergency department of a secondary hospital with a time of ninety-day study, data were collected through the database of the blood bank and by "Diraya" program to analyze the clinical profile of patients. Variables analyzed were age, sex, hemoglobin, cause of transfusion, destination and referrals from primary care. Data were analyzed using SPSS v.21.

RESULTS

A total of 148 patients were transfused and analyzed, most men(61.49%) and women(38.51%). The average age was 71±16 years, provenance: by own means 55.41%, 29.05% primary care, UVI 10.14%, 5.41% other. The causes of transfusion: chronic anemia(66.22%), gastrointestinal bleeding(31.76%) and uterine bleeding(2.03%).

Cardiovascular risk factors were identified: Hypertension arterial 52%, 39.9% diabetes, dyslipidemia 25%, ischemic heart disease 11.5% 8.1% stroke. Pre-transfusional media Hb was 6.6g / dl ± 1.36 and Post-transfusional Hb 8.2g / dl±1.38. Patients referred from primary care Pre-transfusional Hb 6,06g/dl±1.07R3.8 to 7.9 patients admitted for other means Pre-transfusional Hb6,85g / dl±1.4R3,9 to 13.2. Of referred from primary care, causes: 83% chronic anemia, 11.6% gastrointestinal bleeding and 4.7% uterine bleeding, and who entered through other means: 59% chronic anemic, 40% gastrointestinal bleeding and 1% uterine bleeding. Subsequent destinations were: 54.05% admission to hospital plant, 44.59% discharge home and 1.35% exitus.

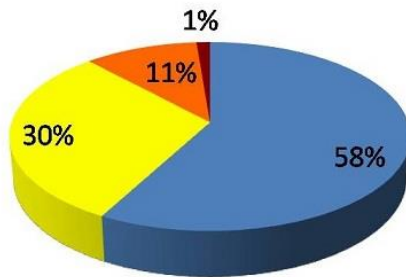
CONCLUSIONS

One third of transfusions performed in a hospital emergency department were indicated by referral from primary care. The main cause of transfusion was chronic anemia, being also the most common in patients referred from primary care. The ciphers for pre-transfusion of patients referred from primary care hemoglobin were lower than those of patients admitted from other origins.

Keywords: blood transfusion primary care hemoglobin

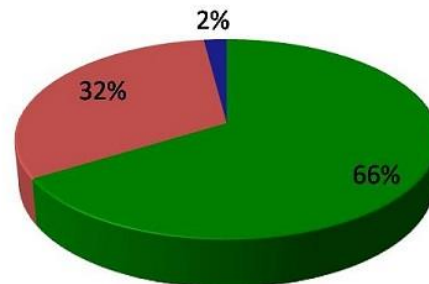
PROVENANCE

- Own means
- UVI
- Primary Care
- Others



CAUSE OF TRANSFUSION

- Chronic anemia
- Gastrointestinal bleeding
- Uterine bleeding



P-0277

Sudden headache in young patient

Antonio Ubiña Carbonero¹, Julian Zarco Manjavacas², Carmen Maria Lopez Rios¹, Francisco Jose Cervilla Suarez²

¹CS Victoria, Malaga, Spain

²CS El Palo, Malaga, Spain

Personal History: No known drug allergies. No clinical history.

Anamnesis: 25 year-old female was admitted to the Observation area for sudden headache in the afternoon. She reports that while she was watching TV at home, she has begun with abdominal pain that radiated to the back and then to the neck and head. No previous effort related. Her relatives comment disconnection of the medium episode. Cannabis in the last month in relation to stress by parental separation.

Physical examination: disorientation and somnolence with good response to painful stimuli. Unreactive mydriatic pupils. Bilateral extension plantar reflex. No alteration of cranial nerves. No alterations in the strength or sensitivity. Rest of examination: anodyne.

Complementary tests: Cranial CT: intraventricular bleeding in frontal and temporal horn of the left lateral ventricle, frontal horn of the right lateral ventricle and III and IV ventricles, with no signs of herniation and hydrocephalus at scan. Urinalysis: cannabis positive.

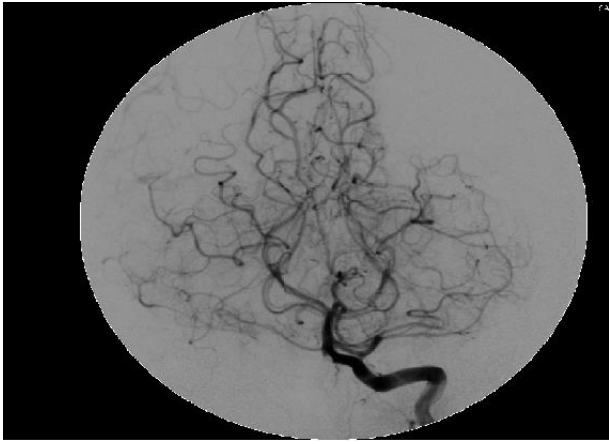
Diagnosis: hemorrhagic stroke.

Evolution: after valuation by Nuerosurgery and Neurology, she was decided to transfer to ICU for monitoring and follow-up assessment by Vascular Radiology, who performed arteriography where vascular nidus was found in the left posterior choroidal artery, with an aneurysm within the vascular tangle, possible cause of the bleeding.

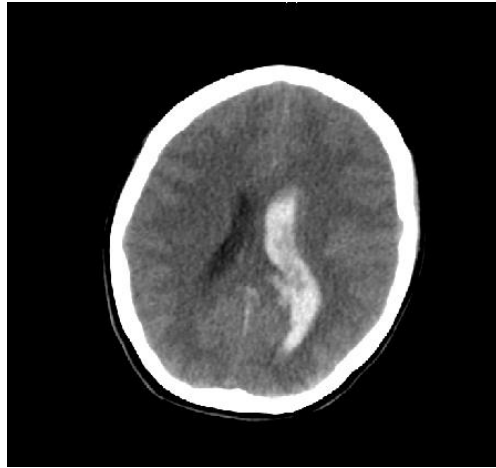
CONCLUSION: Any sudden headache with unusual appearance and characteristics should be studied to rule out the presence of subarachnoid or intracranial hemorrhage.

Keywords: sudden headache, young patient, intraventricular hemorrhage

Arteriography



Cranial CT



Cranial CT



P-0278

Excessive exercise can not be healthy

Julián Zarco Manjavacas¹, Carmen María López Ríos², Antonio Ubiña Carbonero², Juan Pablo García Paine³, Gloria Amaranta Martínez Alonso¹, Francisco José Cervilla Suárez¹

¹C.S. El Palo, Málaga, Spain

²C.S. Victoria, Málaga, Spain

³H. Parque San Antonio, Málaga, Spain

Personal History: male, 21 years. Without interest.

Present Illness: the patient consults for pain in upper limbs and coluric urine after intense exercise three days ago.

Physical Examination: Good overall condition. Impossibility to make complete extension in upper limbs.

Complementary tests: blood test with CK 67.275 without affectation of kidney function.

Diagnosis: rabdiomilisis.

Evolution: the patient stays in Observation Area for 24 hours. When it is objectified that he does not suffer kidney affectation is discharged.

CONCLUSION: excessive exercise ca have consequences against health patients which have to be prevented.

Keywords: rabdiomilisis, sport, young patient

P-0279

Unstable gait and paraparesis in lower limbs in young patient

Antonio Ubiña Carbonero¹, Carmen Maria Lopez Rios¹, Julian Zarco Manjavacas², Francisco Jose Cervilla Suarez², Nerea Canton Cuadrado³

¹CS Victoria, Malaga, Spain

²CS El Palo, Malaga, Spain

³CS Trinidad, Malaga, Spain

Personal History: No known drug allergies. No previous pathology of interest. No standard treatment.

Anamnesis: 24 year old male who presented at our Emergency episode of weakness in lower limbs with unstable gait 2 days duration. Difficulty recently added to move the toes. Left frontal dominance headache associated. No fever or vomiting. No visual or level of consciousness or difficulty in speech disorders. Episode 10 days before tympanic perforation that required antibiotics.

Physical examination: Glasgow 15/15, isochoric and reactive pupils, no nuchal rigidity, no alterations in cranial nerves. No limb differences. Decreased strength in both lower limbs with paresthesias. Upper limbs preserved and symmetrical sensitivity and strength. Abolished patellar reflex and Achilles reflex. Positive Romberg.

Unsteady gait with increased base of support. No alterations in language. Symmetrical palpable carotid pulse.

Rest of examination: anodyne.

Complementary tests: Blood test: no significant findings. Chest X-ray: no significant findings. Cranial CT: no significant findings.

Diagnosis: peripheral neuropathy ascending to rule Guillain-Barré syndrome

Evolution: Neurology is contacted for evaluation meanwhile, decides admission to the ward to complete the study with EMG and ENG and early empiric treatment with gamma globulin. During admission diagnosis of Guillain-Barré syndrome is confirmed.

CONCLUSION: the establishment of a Guillain-Barré syndrome can be difficult to diagnose, so the history is very important (history of infections). It should be noted if symptoms are symmetrical, speed of onset of symptoms, the disappearance of reflexes.

Keywords: unstable gait, lower limb paresis, Guillain-Barré syndrome

Cranial CT



Chest X-Ray



P-0280

Abdominal pain and fever like alarm symptoms

Julián Zarco Manjavacas¹, Carmen María López Ríos², Antonio Ubiña Carbonero², Juan Pablo García Paine³, Juan Paz Galiana⁴, Luis Antonio Calleja Cartón¹

¹C.S. El Palo, Málaga, Spain

²C.S. Victoria, Málaga, Spain

³Department of Emergency, H. Parque San Antonio, Málaga, Spain

⁴Department of Emergency, H. General de Tomellos, Tomelloso, Ciudad Real, Spain

Personal history: male, 67 years. No drugs allergies. Hypothyroidism.

Present illness: the patient consults for fever for 10 days. The patient has received treatment with Levofloxacin suspecting respiratory infection. Fever persists after finishing the treatment. In the current moment, he presents abdominal pain in the right lower quadrant and asthenia and anorexia.

Physical examination: Not fever. Good overall condition. Profuse sweating. No breathing noises. Pain to palpation in right lower quadrant where there appears to be a mass.

Complementary tests: abdominal CT: mass in right colon complicated with inflammatory plaques of the adjacent fat with little abscesses and liver injuries that seem like an abscess and another injury that looks like a metastasis.

Evolution: the patient is admitted by General Surgery to study the mass and start a new treatment.

CONCLUSION: many times the patient comes to us with a diagnosis that we have to confirm or refuse, but if the treatment does not work correctly, we have to investigate it, because it can be a mistake.

Keywords: Fever, abdominal pain, colon cancer

P-0281**Consciousness crisis**

Slavica Vrtarić, Darko Vrtarić

Department of Public health, University of Josip Juraj Strossmayer, Osijek, Croatia

A 23-year-old male student was admitted urgently to the Neurology Clinic for experiencing a 1-minute grand mal epileptic seizure. According to the heteroanamnesic data, the young man was asleep when he suddenly jerked and fell off the bed, all of his limbs were convulsing, he also bit his tongue and foamed out of his mouth, with no loss of control of bowel or bladder functions. After the seizure he felt confused for a while. This was the first time he had ever experienced a seizure.

Over the past two weeks he has been stressed out and under intense pressure having slept only 3 to 4 hours per day, spending his days studying all the time and in front of the computer. According to his girlfriend, every day for the last two weeks he would have recurring episodes of becoming absent-minded, staring blankly during the conversation and becoming briefly unaware. He denied consuming alcohol, drugs or any medications and did not have a fever.

On physical examination, the patient is alert, conscious, responsive, oriented, is able to move the neck, normally innervated cranial nerves, able to maintain all four extremities symmetrically against gravity, with symmetrical myotatic reflexes, normal bilateral plantar response, all sensations are normal, able to normally perform the coordination tests, the Romberg test is negative, normal ability to walk, the tongue bite is visible, no external head injuries, blood pressure 145/95.

Diagnostics: MSCT of the brain, MR of the brain, Color Doppler of carotid arteries, EEG and ECG, all of which indicate normal results, biochemical results are within normal values.

CONCLUSION: Risk behaviour, which is in this case associated with a lack of sleep and spending too much time in front of the computer, can lead to severe consequences even in healthy people, such as an epileptic seizure described in this case.

Keywords: epileptic seizure, lack of sleep, computer

P-0282**Musculoskeletal persistent pain with no logic cause should be exhaustively studied**

Cristina Vidal Ribas, Pedro Vidal Vaz, María Albaladejo Blanco, Ignacio Ramírez Manent, Eduardo Hernández Deleón

primary care center, Mallorca, Spain.

COMPLAINT:

36 year old female, consults for several week evolution right shoulder pain that worsens when lifting her arm and with nocturnal predominance. She associates it with exercise.

CLINICAL HISTORY:

- Smoker 1 pack/day
- No other interesting records

PHYSICAL EXPLORATION:

Right shoulder: no deformities, generalized pain in proximal third part of the humerus that worsens with mobilization.

DIFFERENTIAL DIAGNOSES:

Musculoskeletal pain.

COMPLEMENTARY TESTS:

- X-Ray: given as normal.

EVOLUTION AND FINAL DIAGNOSE:

2 months later the patient comes back to consult for persistence of the symptoms with aggravated dysfunction of the shoulder, besides she presents hip pain and loss 7Kg in this last 2 months. We ask for blood testing and reassess the x-ray where a loss of density is seen, we decide to repeat the x-ray.

- Blood: no abnormalities
- X-Ray: Lithiasic process in right greater tubercle.

When the patient comes for the results we performed new physical complete exploration finding a mass in left breast and axillar lymphadenopathies. The patient is admitted to the hospital where breast cancer diagnose is confirmed and extension studies reveal pulmonary, hepatic bone, peritoneal, renal and suprarenal

DISCUSSION:

Breast cancer is the most frequent cause of bone metastasis. In some occasions bone pain can be its first symptom, therefore, although the pain is diagnosed as musculoskeletal, if it doesn't show any improvement with analgesics, the patient should be submitted to further testing and complete physical exploration.

In this case the patient was only 36 with no familiar history, so she wasn't included in the breast cancer screening program. However we should consider that about 95% of Breast Cancer cases have no genetic disposition.

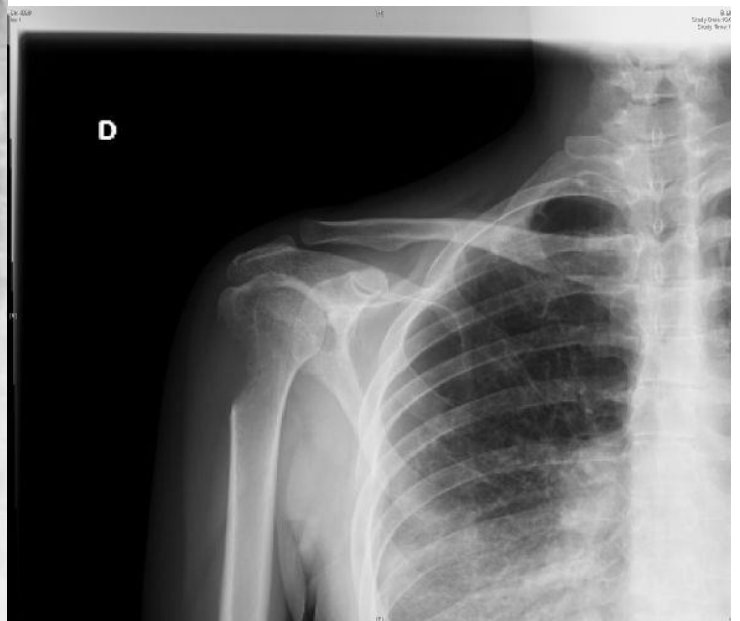
Keywords: Breast Cancer Metastasis Musculoskeletal Pain

X-Ray 1

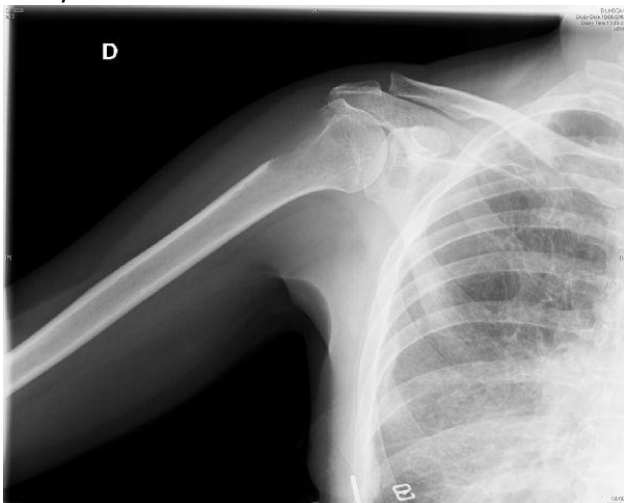


explained from emergency room as normal

X-Ray 2



X-Ray 3



P-0283

Fever and back pain in a patient with Psoriatic Arthritis

Gui Santos¹, Ricardo Antunes², Cláudia Penedo³

¹USF Villa Longa

²USF Quinta da Lomba

³USF Emergir

BACKGROUND-AIM: Family Medicine, usually the point of first contact with Healthcare Services, manages undifferentiated pathology that may require urgent intervention. With this case we aim to show the need to differentiate usual chronic complaints from new pathology that may present with unspecific symptoms.

Methods/RESULTS: 61 year-old male, unemployed, married, in a Duvall phase VI nuclear family, a history of Hypertension, Psoriatic Arthritis (PA) and Generalised Anxiety Disorder, with no significant family history; medicated with naproxene, prednisolone, metotrexate, omeprazole, lisinopril+hydrochlorothiazide and diazepam.

A frequent user of Healthcare Services, often complaining of articular pain related to PA associated with anxiety. In August the patient complains of fever and joint pain, common in him, being medicated with anti-pyretic and anti-inflammatory, and blood-work is requested.

The patient returns in September due to maintenance of fever and dorsal discomfort. Previous white-cell count is normal, negative C-reactive protein, and Sedimentation Rate of 60, to be expected in psoriatic arthritis. He is medicated with tramadol. He returns very anxious with fever and generalised pain, and goes to his Rheumatologist who confirms PA crisis and escalates medication.

In October symptoms remain, now accompanied with lower limb paresthesia, muscle strength asymmetry and Laségue sign. Exacerbation of PA is assumed.

Three months after initial complaints, due to exacerbation of dorsalgia, the patient is referred to the Emergency Room. A Computerized Tomography reveals epidural abscess with medular compression, treated with decompressive laminectomy of D5-D7 and abscess drainage which revealed Acid Alcohol-Resistant Bacilli.

CONCLUSIONS: This is a patient whose PA masked the presentation of Vertebral Tuberculoma. Given his frequent use of services due to pain, complicated by anxiety, it became difficult to differentiate acute from chronic symptoms. We demonstrate the need of high clinical suspicion in patients with chronic conditions, given the risk of neglecting acute pathology that may go unnoticed.

Keywords: Family Medicine, Psoriatic Arthritis, Acute disease, Chronic disease, Tuberculosis

P-0284

Not always a cough and thoracic pain is a cold

Cristina Vidal Ribas, Padro Vidal Vaz, María Albaladejo Blanco, Ignacio Ramírez Manent, Eduardo Hernández Deleón, Adriana Helmfelt Minobis
primary care center, Mallorca, Spain.

COMPLAINT: 58 year old male consults for 1 week cough and throbbing right thoracic pain that worsens with cough and deep inspiration. It is diagnosed as pharyngitis and muscular pain. After less than a week patient returns complaining of dyspnea and low fever. He has had Ibuprofen (no improvement).

CLINICAL HISTORY:

- Former smoker, 20 packs/year.
- Arterial Hypertension.
- Mix dyslipidemia.
- Diabetes mellitus type II.

- Normocytic normochromic anemia. Diagnosed months before because of weakness. In blood test Hb: 11.5mg/dL, with negative test for blood on stools. We agreed new Hb determination in 3 month that was not performed.

Usual treatment: amlodipine 5mg; Lisinopril 20mg; metformin 850mg; simvastatin-ezetimib.

PHISICAL EXPLORATION (2nd consulting):

- TA 171/91, FC 89, SatO2 98%
- Normal cardiologic examination.
- Respiratory auscultation with bilateral basal.

DIFFERENTIAL DIAGNOSIS:

- Respiratory tract infection
- Pulmonary embolism

Because of bad evolution we send him to the emergency department.

COMPLEMENTARY TESTS:

- ECG: SR, 98bpm, repolarization syndrome.
- Thoracic X-Ray: normal.
- Blood: Dimer D 261, urea 78, creatinine 3,23 (before 1,29), non-ionized calcium 11.4, chlorine 113.

EVOLUTION AND FINAL DIAGNOSE:

Unknown Kidney Insufficiency (secondary to Ibuprofen)

Hyperkalemia and hiperchloremia.

Facing a possible pulmonary embolism heparin treatment was initiated and the patient was assigned to the nephrology unit for kidney function deterioration and persistent hyperkalemia. An hematological neoplasia was suspected and after observation of a "salt and pepper" (photo 1) pattern in cranial bone series and both kidney and bone marrow biopsy confirmation, Multiple myeloma was confirmed.

DISCUSSION:

A normocytic anemia can be the first manifestation of systemic disease. Unspecific signs and symptoms should be studied and additional tests performed. Blood determinations as reticulocytes count, iron profile and leucocytes and platelets anomalies have special meaning when dealing with cases like these. Patients with non-affiliated normocytic anemia neither associated to chronic disease should be sent to hematology unit for further testing.

Keywords: Common cold Chest pain Multiple Myeloma

Thoracic X-Ray



Thoracic X-Ray: normal.

cranial bone series



salt and pepper pattern in cranial bone series

P-0285

Muscle pain, no dyspnea... Can it be a pneumothorax?

Cristina Vidal Ribas, Pedro Vidal Vaz, María Albaladejo Blanco, Ignacio Ramírez Manent, Laura Medrano
primary care center, Mallorca, Spain.

Complaint: Chest pain

Personal history: 10 cigarettes per day; no interesting medical records.

Anamnesis/interrogation: 18 years old male, consults the doctor for 5 hour mild chest pain, especially with deep breathing. Describes it as sharp, non-radiating, increasing with efforts. No dyspnea. He explains that he is doing exercises with weights and, in the past, he had felt the same feeling; on those occasions the doctor said it was due to muscle strain.

Physical examination: TA 135/80, FC 80, SatO2 96-97%. Hypo phonetic right thorax.

Investigations:

- Arterial blood gas analysis: pO2 78, PCO2 35, pH 7.47
- ECG: anodyne
- Chest X-ray: lung collapse

Diagnostic impression: pneumothorax.

Differential diagnosis: mechanical pain (prior to physical examination and investigations).

Treatment: In the emergency room, a drainage needle is inserted, oxygen, and advise resting. In our consult, we advise to stop smoking.

Evolution:

Until now, he has not presented a similar episode.

CONCLUSIONS:

When we see a young a tall patient with smoking habit and with dyspnea we should always think of pneumothorax. In spite of this, sometimes the patient doesn't complain about dyspnea, they consult only for chest pain. For this reason vital signs monitoring, physical examination and some simple complementary tests, like ECG or X-ray are quite important diagnosing tasks.

In this kind of pathology, the recurrences are very common. Therefore we have to work on risk factors such as smoking, diving or excessive exercise

Keywords: Musculoskeletal pain Dyspnea Pneumothorax

pneumotorax



Approach of Male Breast Symptoms in Primary Care: an Algorithm

Ana Sofia Pena¹, Ana Matos², Ana Paula Cardoso¹, Mariana Anete Mira¹, Susana Cordeiro Rita¹

¹USF Samora Correia, ACES Estuário do Tejo, ARSLVT, Portugal

²UCSP Benavente, ACES Estuário do Tejo, ARSLVT, Portugal

BACKGROUND-AIM:

Although less frequent, breast symptoms and pathology occur in men too, so they should be considered and assessed in male.

Motivated by clinical cases, we thought useful to perform a literature review upon this topic to establish an approach algorithm of these situations for Primary Care.

METHODS:

We performed a literature review searching the MeSH terms “breast symptoms”, “breast pathology”, “primary care” “man” and “male” in the databases Pubmed, Medline, ScienceDirect, Medscape e UptoDate.

RESULTS:

We selected articles written in english between 2000 and 2014. We excluded several that not comprised the male population.

The majority of breast male pathology is benign. Gynecomastia is the most frequent problem. Breast male cancer is rare (<1% of breast cancers) but deserves our concern, as its incidence is rising and early diagnosis happens seldom. Other breast male pathologies are related to skin and subcutaneous tissue.

The main reasons that lead men to seek medical advice are: rise in breast volume, breast lump and breast pain.

The approach of these patients should include: anamnesis comprising age, race, family history, personal history of disease or trauma, exercise habits, medication, alcohol and drug use and symptoms characterization; examination, including feminization signs, signs of liver, thyroid or kidney disease, evaluation of lymph nodes, testicles and breast.

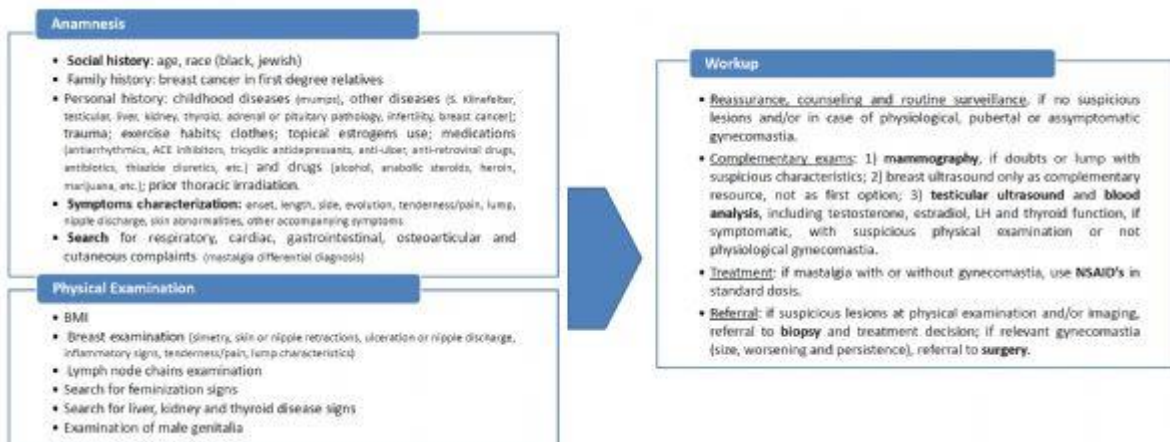
This assessment will guide the complementary exams to request (lab and/or imaging tests). The referral for biopsy and therapeutic guidance is necessary in some cases. In others the tranquilization of patient and education for surveillance and re-evaluation will be enough.

CONCLUSION:

Though uncommon, breast male pathology exists and we should be aware to perform a systematic approach in order to detect on time and characterize correctly the condition. A structured anamnesis and a complete observation will guide the need for complementary tests and enable early diagnosis and action plan decision.

Keywords: breast male symptoms, breast lump, breast pain, gynecomastia, breast male cancer

Approach of Male Breast Symptoms



In section "Results" following the sentence "As a systematic assessment of these symptoms we propose:"

P-0287

{Heart aches} – the importance of taking a step back and looking in perspective

Isabel Santos Solha, Lisete Aires Silva

Usf Terras de Souza, Aces Tamega II - Vale de Sousa Sul, Paredes, Portugal

Setting: Family Medicine is known for its patient centered approach, guided by family and community contexts. Family Doctors have the ability to juggle multiple complaints, in view of health promotion, disease prevention, treatment, palliative care and rehabilitation. Cough and dyspnea are very common symptoms that require a systematic and thorough evaluation of the patient in order to determine the most probable cause of illness. Case description: J.A.B.J., male, 49 years old, construction worker, married, nuclear family, stage 5 of Duvall, Class II of Graffar. His history also includes smoking (35 pk-yr), alcohol consumption (70 g/day) and illicit drug use. This man comes for a consultation cough and dyspnea on light exertion. Physical examination was normal and he was treated symptomatically. On a second consultation, the complaints persisted and there weren't any alterations on the requested chest x-ray. Few days later, he was medicated with several antibiotics and bronchodilators in a ER consultation, with no improvement of his symptoms. In another consultation, with another doctor, he presented with persistent cough for two months, mucous sputum, dyspnea on moderate exertion, orthopnea and chest pain. ECG and echocardiogram suggested dilated cardiomyopathy, with severe ventricular dysfunction (EF=22%). He was then medicated with furosemid (60mg id) and carvedilol (6,25mg id), requested a workup including Pulmonary Function Tests, and sent to an urgent cardiology consultation. Patient improved his symptoms from a NYHA class III to class II.

Discussion: Ischemia is the main cause for dilated cardiomyopathy (50%); substance abuse (mainly alcohol and cocaine) account for nearly 3% of the causes. This case reminds us the importance of a global approach of patient history. Searching for signs and symptoms from another point of view allows us to determine the correct diagnosis and proper orientation to other specialists, with a positive impact on patient's quality of life.

Keywords: Dyspnea, Cardiomyopathy Dilated, Diagnosis Differential

Case description



P-0288

Baker cyst. A rare case

Juan Manuel García López, Verónica Parent Mathias

Department of Emergencies, Regional Hospital, Málaga, Spain

OBJECTIVE: to present an unusual case of Baker's cyst.

METHOD: case.

It is a 24 year old male with no known pathology that goes to ER for pain in the right calf region of more than 1 week duration. He reports that he has received tumor in the area has increased over time (months). No recalls previous trauma. On examination, tumor ranging from upper third to the middle third of twin without observing involvement of posterior aspect of the knee is appreciated. No functional impairment or hematoma and palpation perceived stony consistency with mild displacement of the structure. X-leg where injury is seen in upper third tibia compatible with chondroma is performed. It requesting consultation with trauma ultrasound tumor area proving to be compatible with Baker cyst tension. The orthopedic surgeon proceeds to needle aspiration thereof, introduced betamethasone and outpatient appointment for review.

CONCLUSION: This is an unusual case because Baker cyst is related to patients middle-aged, with arthritis or osteoarthritis or meniscal history of involvement, facts that do not occur in this case.

Keywords: Baker, cyst, young

aspiration



Baker



P-0289

Syncope. What to look for in the electrocardiogram

Juan Manuel García López, Verónica Parent Mathias

Department of Emergencies, Regional Hospital, Málaga, Spain

OBJECTIVE: To identify electrocardiographic tracings that can justify the cause of syncope.

METHOD: literature review.

For a patient who comes in for syncope, we must make a electrocardiograma, but what we find in the plot to justify syncope?

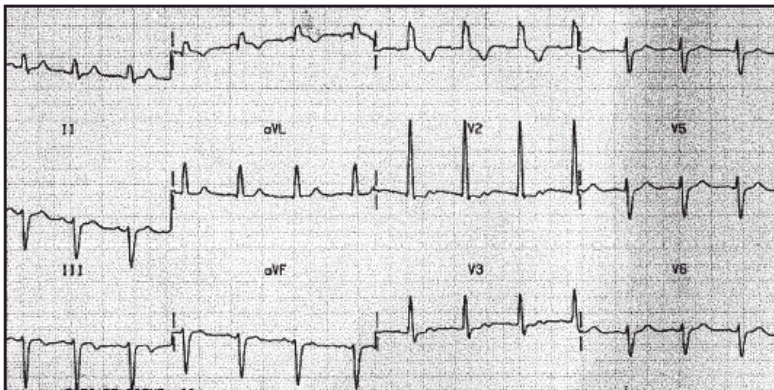
Paths that can explain what happened are:

- Persistent sinus bradycardia (<40 bpm).
- Sino-atrial block or equal to or greater than 3 sec sinus pauses.
- Complete atrioventricular block or second degree Mobitz type I or II.
- Right bundle branch block and left bundle alternating.
- Sustained or uncontained ventricular tachycardia.
- Rapid supraventricular tachycardia.
- Long or short QT syndrome.
- Brugada pattern type I.
- Bifascicular bundle branch lock (LBBB or right bundle branch block with left anterior hemiblock or left posterior hemiblock).
- Intraventricular conduction disorders with QRS> 120 ms.
- Wolf-Parkinson-White.
- Paths suggestive of ischemic heart disease.
- Q waves suggestive of myocardial necrosis.

If we see any of these patterns, we must refer the patient to the ER for evaluation by a cardiologist.

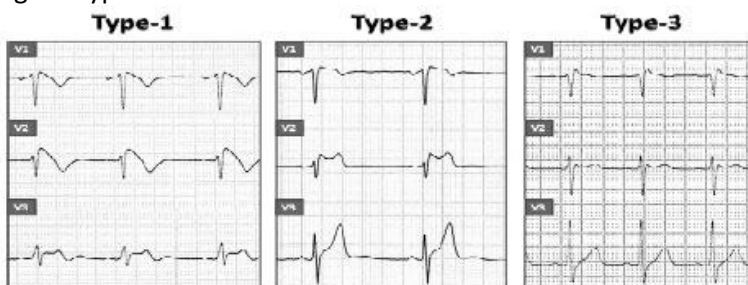
Keywords: syncope, arrhythmias.

Bifascicular block

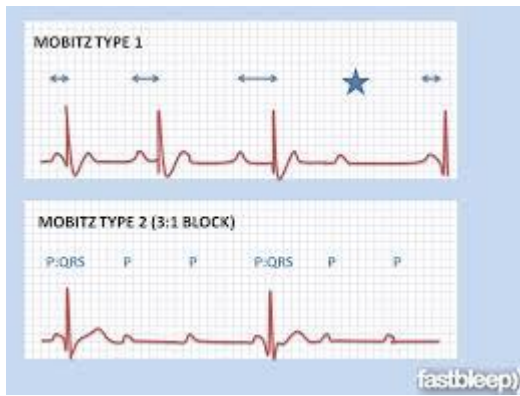


RBB with AHB

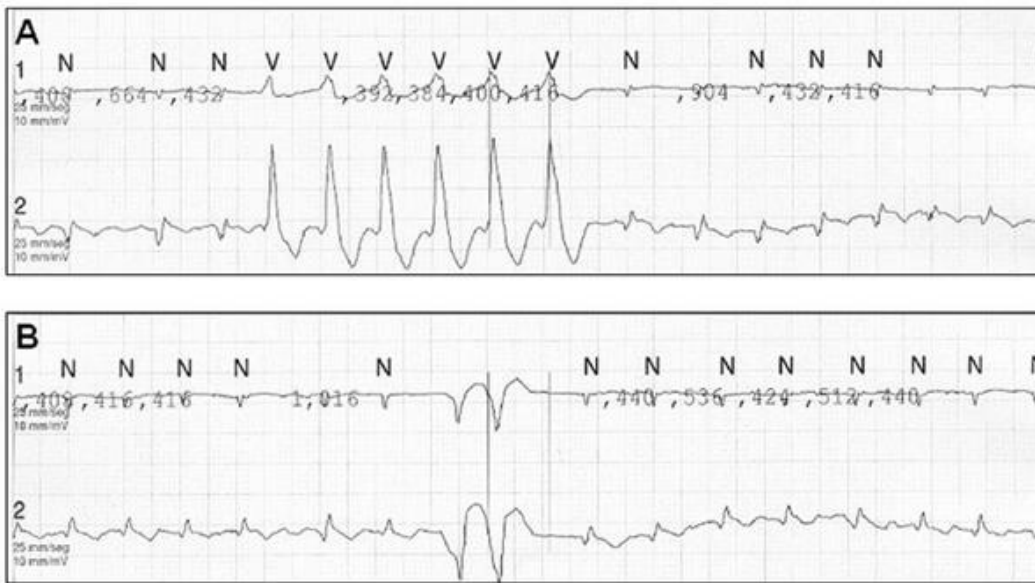
Brugada type I



Mobitz 1 and 2



uncontained VT



P-0290

Doctor, I am not able to talk as usual, I can't hang up the clothes anymore!

Cristina Herranz Martinez¹, Miriam Rey Seoane¹, Ana Belén Montero Alvaredo¹, Gerson Redondo Berná², Rabea Kazan³

¹Hospital Viladecans, Barcelona, Spain

²Hospital Moises Broggi, Barcelona, Spain

³Hospital Mutua de Terrasa, Terrasa, Spain

Fahr disease is a rare finding in a primary care consultation, has a low prevalence and unknown etiology and only a complementary test could offer a correct diagnosis. We present a 68 years-old woman, consulted her family doctor about some speech difficulties she had been having for around 3 months. She commented some other difficulties that follow that problem like impossibility of doing the basic homework or having the sensation of moving around from left to right and some short-term memory problems. No headache, no loss of strength or sensory alteration, but her husband referred some clumsiness that had not been there before. Medication: metformin, treatment for Diabetes Mellitus type 2. No other illness. Physical exploration was normal, neurological assessment without alterations and ECG in sinus rhythm. A CT-SCAN was demanded in a quick circuit, in a week the results said that exits bilateral calcification of basal ganglia and cerebellums surface, with clinic exploration could be a Fahr disease. A citation with Neurology has been made and some analysis with Ca 2 ++ levels. Nowadays, the patient has been attending the follow-ups, analysis were normal without significative alterations and the difficulties continues. Treatment was not supported, but in literature is said that lithium or antidepressives could be used. In front of a patient with memory and coordination problems it is necessary exclude infection disease, endocrine alteration or neoplastic tumours and complementary test are a must in primary care.

Keywords: memory lost, Fahr disease, basal ganglia

Brain CT scan



Bilateral calcification of the basal ganglia

Brain CT scan



Calcifications in the cerebellum

P-0291

Time-dependent variations in physicians' information needs during working hours

Jukkapekka Jousimaa, Heidi Alenius, Nora Berghem, Ilkka Kunnamo

Duodecim Medical Publications Ltd, Helsinki, Finland

Background & Aim

The patients' reasons to visit a doctor's practice can be expected to vary considerably depending on the appointment time. This could also influence the physicians' information needs during the working hours. To verify this hypothesis, we checked hour - by - hour 50 most popular searches done to EBMG, an electronic point-of care database for primary care physicians, during a 12-month period. The main question was, if there were time-dependent differences in searched topics.

Method

From a log file, we collected retrospectively a Top-50 list of all searched topics hourly. The collection period was 4.3.2014 – 3.3.2015. The searched topics were divided in 24 hour-by-hour groups, starting from 24.00 and ending 23.59 and analyzed by their relative reading frequency during each time period.

Results

During the data collection period, altogether 14 million searches were done to the database. The quietest hour was between 4-5 a.m. (Top-50 contained 4362 searches) and the busiest time interval was between 10-11 a.m. (Top-50 contained 241779 searches). The nature of searched topics varied greatly diurnally. During normal office hours (8-16) searches containing chronic disease conditions like asthma and diabetes were prominent, while during duty hours, acute conditions like laryngitis and pneumonia were the most common in relation to each other. Some common examples are shown in Figure (to be added in presentation).

Conclusions

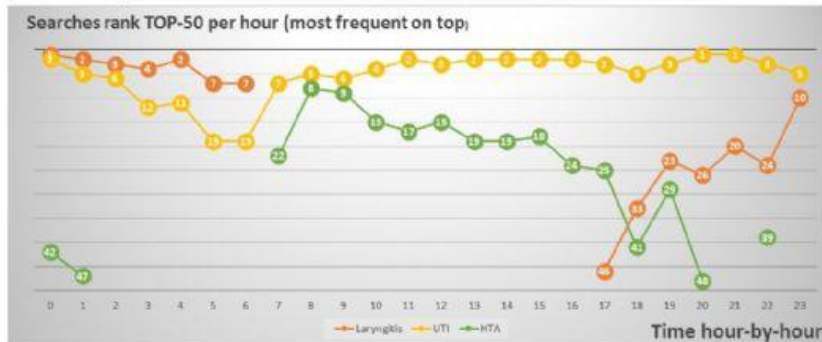
Automatically collected log files provide evidence from patients' visiting reasons and physicians' information needs depending on the timing of the visit. This information can be used in optimizing electronic database performance as well as planning how to provide resources optimally.

Keywords: Guidelines, information needs, log files

Laryngitis, urinary tract infection (UTI) and arterial hypertension (HTA) rank in Top-50 of EBMG searches hour by

hour

Laryngitis, urinary tract infection (UTI) and arterial hypertension (HTA) rank in Top-50 of searches hour by hour



P-0292

Indomethacin-induced Psychiatric Disorder

João Fernando Martins Machado, [Mariana Fidalgo Ferreira Leite](#)
Unidade de Saúde Familiar Saúde no Futuro. Vila Nova de Gaia. Portugal
INTRODUCTION/BACKGROUND

Non-steroidal anti-inflammatory drugs are commonly used in general practice; indomethacin is one of the most potent drugs of this class. Psychiatric adverse events, even though not frequent, have been described with indomethacin, particularly in elderly and patients with previous psychiatric disorders.

CASE REPORT

The authors present the case of a 44 year-old female with medical history of dysthymia, previous ovarian cancer and urinary incontinence, currently treated with paroxetine 20 mg, alprazolam 1,5 mg and temazepam 20 mg daily.

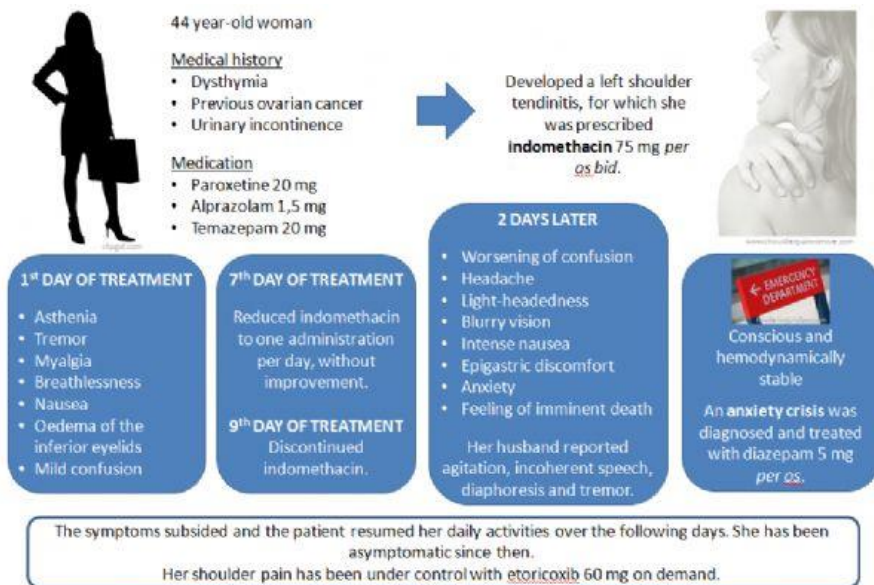
Shortly after being medicated by her family doctor with indomethacin 75 mg per os bid, to treat a left shoulder tendinitis, the patient developed asthenia, tremor, myalgia, breathlessness, nausea, oedema of the inferior eyelids and mild confusion. On the seventh day of treatment, she reduced indomethacin to one administration (75 mg) per day, without improvement; she discontinued indomethacin two days later.

The next day, she experienced worsening of confusion, accompanied by headache, light-headedness, blurry vision, intense nausea, epigastric discomfort, anxiety and a feeling of imminent death. Her husband reported agitation, incoherent speech, diaphoresis and tremor. She was taken to the local emergency department, where she arrived conscious and hemodynamically stable; she was treated for an anxiety crisis with diazepam 5 mg per os. The symptoms subsided and the patient reassumed her daily activities over the following days. She has been asymptomatic since then. Her shoulder pain has been under control with etoricoxib 60 mg on demand.

DISCUSSION/CONCLUSION

The mechanism through which indomethacin induces psychiatric adverse events is not yet well understood; however it may reside on the similar molecular structure between indomethacin and serotonin. Family doctors should be aware of the possibility of these adverse events, particularly in elderly and in patients suffering from psychiatric disorders, whom may be at higher risk.

Keywords: Indomethacin, Adverse Effects, Mental Disorders



P-0293

Are antibiotics, for patients presenting with sore-throat symptoms in primary care, correctly prescribed?

Kuresh Khodatars, Soleman Begg

St George's University of London, London, United Kingdom

Background and AIM:

Antibiotic use has become increasingly important and controversial. Their necessity and benefit for health is widely known. However current antibiotics are becoming ineffective. Their high usage is linked to an increase in antibiotic resistant bacterial populations. The rate of resistance development is higher than antibiotic replacement production. This issue's seriousness is recognised by WHO as a major public health threat. One solution is to slow rates of resistance through reducing the number of antibiotics in circulation, by implementing efficient prescribing guidelines. Pharyngitis has been subjected to such regulations. The majority of afflicted patients do not need antibiotics. However, over cautiousness caused over-prescribing in previous years. This audit aims to evaluate whether antibiotics, for patients with sore-throat symptoms, are correctly prescribed after modified guidelines were introduced.

METHOD: All relevant consultations, from a GP surgery serving 4000 people, were recorded and scrutinised against NICE guidelines. Selection was based on all GP consultations where, within the past three months, patients presented with sore-throat symptoms and were prescribed a relevant antibiotic.

RESULTS: 31 prescriptions, of which 14 were for delayed prescriptions, were in accordance with NICE guidelines. One prescription was not in accordance; it should have been for delayed, rather than immediate, dispensing.

CONCLUSIONS: During the winter season, the GP surgery had done well to prescribe pharyngitis related antibiotics in accordance with NICE guidelines. The adoption of delayed prescriptions, with the overall benefit of reducing antibiotic use, has been successful. However the single exception emphasises the need to reinforce, to both patients and clinicians, the importance and benefit of using delayed prescriptions through clear and concise explanations. Patients should receive this from clinicians and easily accessible awareness information. This may help tackle patient expectations of immediate antibiotics, whilst reducing unnecessary delayed prescription redemptions. The authors have no competing interests to declare.

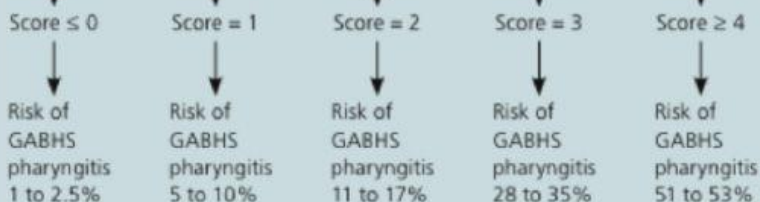
Keywords: audit, pharyngitis, antibiotics, guidelines

Diagnosis and Treatment of Streptococcal Pharyngitis

Clinical Decision Rule for Management of Sore Throat

Patient with sore throat
Apply streptococcal score

Criteria	Points
Absence of cough	1
Swollen and tender anterior cervical nodes	1
Temperature > 100.4°F (38°C)	1
Tonsillar exudates or swelling	1
Age	
3 to 14 years	1
15 to 44 years	0
45 years and older	-1
Cumulative score:	_____



The above image has been adapted from Choby, BA. (2009) "Diagnosis and Treatment of Streptococcal Pharyngitis", *American Family Physician*, 79(5), p.385 who has, in turn, adapted this from McIsaac WJ, White D, Tannenbaum D, Low DE (1998) "A clinical score to reduce unnecessary antibiotic use in patients with sore throat", *CMAJ*, 158(1) p.79.

P-0294

Coluria as acute epigastric pain and symptoms of acute Hepatitis B

Carmen María López Ríos¹, Antonio Ubiña Carbonero¹, Julián Zarco Manjavacas², Juan Pablo García Paine³, Juan Paz Galiana⁴, Luis Antonio Calleja Cartón²

¹C.S. Victoria, Málaga, Spain

²C.S. El Palo, Málaga, Spain

³Department of Emergency, H. Parque San Antonio, Málaga, Spain

⁴Department of Emergency, H. General de Tomellos, Tomelloso, Ciudad Real, Spain

Personal History:

Female 37 years. Allergy to Penicillin. No surgical medical history of interest.

Present Illness:

She came to the emergency Epigastralgia seven days of evolution accompanied by malaise and fatigue, nausea without vomiting, no diarrhea or fever. Also referred darker than usual urine.

Physical Examination:

Cardio-pulmonary auscultation average. Abdomen nondescript except hepatomegaly two traverses. No edema in legs. I request blood tests for virus serology.

Complementary tests:

Analytical count and normal coagulation. Biochemistry with Total Bilirubin 4.84, 3.89 Direct, GOT 1386, GPT 1149, VHA 148. FA negative, positive Agc HBV, HBV positive Ags

Diagnosis: Acute hepatitis HBV

Evolution: It quoted the patient and contact history on risk. She is single, born in Russia, lived in Spain since 2012. She is administrative. Sexual activity, oral sex a month ago with a stranger and she tattooed eyebrows two months ago. Share floor with an old woman.

Protocol: Declare Notifiable disease, we conducted epidemiological survey of hepatitis B and asked about close contacts prophylaxis if needed. Lower labor and Digestive derivation. We use to guide bedrest with residue diet. Repeat analytic in two months to assess treatment. Notified from M. Preventive places to study contacts and health inspection of address where the tattoo was done.

Keywords: Epigastralgia, dark urine, hepatitis

P-0295

Acute Viral Hepatitis A in Young Male Adults at southeast region in Turkey

Mehmet Aytug Dikililer¹, Umit Aydogan², Oktay Sari², Salim Ozenc³, Bayram Koc²

¹Family Medicine Clinic, Ankara Military Hospital Anittepe Polyclinic, Ankara, Turkey

²Department of Family Medicine, Gulhane Military Medical Academy, Ankara, Turkey

³Family Medicine Clinic, Diyarbakir Military Hospital

Introduction and AIM: Acute viral hepatitis (AVH), is the most common liver disease and continues to be a major health problem in public health all throughout the world. In this study, we aimed to investigate the duration of hospital stay and examining the laboratory findings because of hepatitis A virus infection (HAVI) which cause for the significant loss of labor in our country. The Files of Patients that were treated for diagnosis of HAVI in January 2010 – December 2011 were examined in internal medicine clinic of Sırnak Military Hospital.

RESULTS: Sixtysix male patient included the study. Mean age was $22,05 \pm 2,81$. Mean hospitalization time was $10,55 \pm 5$. According to the patient complaints there were % 63,6 nausea/vomitting, % 43,9 weakness, % 10,6 fever, % 42,4 darkening of urine, % 57,6 jaundice, % 40,9 anorexia, % 6,1 diarrhea, % 7,6 headache. In physical examination there were % 84,8 jaundice, % 12,1 hepatomegaly, % 13,6 splenomegaly, % 9,1 right upper quadrant tenderness, % 3 roughing in breath noises. Biochemical parameters were wbc: $6,61 \pm 2,08$ hgb: $15,44 \pm 2,28$, plt: $220,98 \pm 81,05$ alt: $1080,65 \pm 1532,48$ ast: $869,67 \pm 1598,73$, alp: $165 \pm 112,07$, havIgM: $8,33 \pm 6,94$ Tblb: $6,63 \pm 3,91$, d.blb: $3,14 \pm 2,59$. The complications were % 3 bicytopenia, % 10,5 trombocytopenia, % 1,5 elevated liver enzymes, % 3 cholecystitis.

CONCLUSIONS: HAVI is an important community health problem in regions that have infrastructure problems and low hygienic conditions. HAVI which was expected to occur in older ages in our country, may present with more severe disease and its complications and it must be evaluated carefully by the family physicians.

Keywords: acute, hepatitis A, Liver, community health

Limitations on approach of secondary hypertension in Primary Health Care

Teresa Pereira Martins, Bruno Vaz, Helena Ribeiro, Samuel Pedreira
 USF Novos Rumos - ACES Alto Ave, Portugal

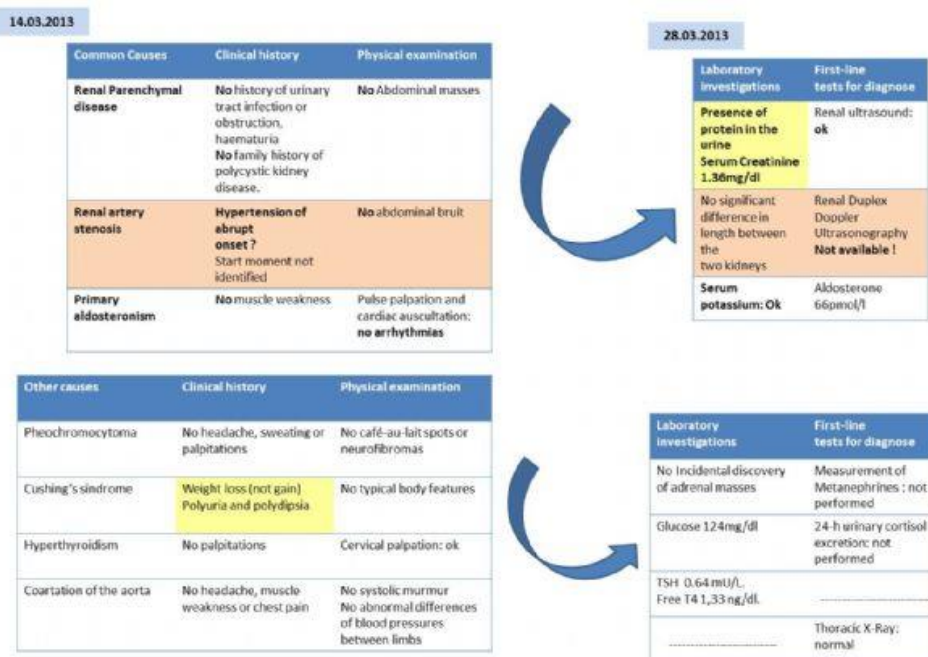
BACKGROUND: Secondary hypertension is about 5 % to 10 % of all cases of hypertension. The existence of a secondary cause should be considered in all hypertensive patients, and patient approach, through clinical history, physical examination and study diagnose, can confirm their presence. It is up to family physician, as a first line in health care, the detection and proper orientation of these situations.

Case description: Male of 38-years-old, healthy, complains of polydipsia, polyuria and a recent weight loss (about 3kg in 2 weeks), with no reasonable cause. During the meeting, he reports high values of blood pressure (some of 190/90mmHg), confirmed in the physical examination. There were no physical signs indicate possible causes for secondary hypertension. The initial study included laboratory investigations, electrocardiogram, chest radiography and renal ultrasound. Once in a referral center, the study indicated renal arteries stenosis.

DISCUSSION: Hypertension guidelines of 2013, from European Society of Hypertension, recommend the screening and study of possible reversible causes of hypertension on all patients. Almost all kind of initials studies may be performed in Primary Health Care in Portugal, with the only exception of renal duplex doppler ultrasonography. When stenosis of renal arteries is suspected or no other cause of secondary hypertension is determined, the patient should be referred to a specialized center for further studies. Will we have more benefits if that kind of study were available in Primary Care? And if we cannot totally conduct a study of identifiable causes of hypertension, should we start the study at all, or simply refer the patient?

Keywords: secondary hypertension, primary health care

Figure 1



Follow up plan in this case of secondary hypertension

P-0297**Acute headache with neurological symptoms like sentinel symptom of cerebral injury**

Carmen María López Ríos¹, Antonio Ubiña Carbonero¹, Julián Zarco Manjavacas², Juan Pablo García Paine³, Juan Paz Galiana⁴, Luis Antonio Calleja Cartón²

¹C.S. Victoria, Málaga, Spain

²C.S. El Palo, Málaga, Spain

³Department of Emergency, H. Parque San Antonio, Málaga, Spain

⁴Department of Emergency, H. General de Tomellos, Tomelloso, Ciudad Real, Spain

Personal history: female, 80 years. Hypertension, dislipemia.

Present illness: acute headache for three hours with aphasia and right hemiplegia.

Physical examination: Blood pressure 175/100. Gaze deviation to the left. Right central facial paralysis. Aphasia.

Force preserved in arms and legs.

Complementary tests: skull CT: Parieto-temporal intraparenchymal hemorrhage left perilesional edema with mass effect produced by shifting the midline about 8mm. Findings possibly related to space-occupying lesion unable to rule out hemorrhagic transformation of an ictus.

Diagnosis: hemorrhagic ictus. Cerebral mass vs. arterial malformation.

CONCLUSION: differential diagnosis of headache is important to choose the right treatment in the different causes of cerebral accidents.

Keywords: Headache, neurological symptoms, cerebral pathology

P-0298**Unstable gait and hemiparesis in lower limbs in young patient**

Carmen María López Ríos¹, Antonio Ubiña Carbonero¹, Julián Zarco Manjavacas², Francisco José Cervilla Suárez², Juan Pablo García Paine³, Juan Paz Galiana⁴

¹C.S. Victoria, Málaga, Spain

²C.S. El Palo, Málaga, Spain

³Department of Emergency, H. Parque San Antonio, Málaga, Spain

⁴Department of Emergency, H. General de Tomellos, Tomelloso, Ciudad Real, Spain

Personal history: no drugs allergies. No previous pathology.

Present illness: 24 year old male who presented weakness in lower limbs with unstable gait for 2 days. Difficulty to move the toes. Left frontal headache. No fever or vomiting. No visual or level of consciousness or difficulty speech disturbances.

Physical exploration: Decreased strength in both lower limbs with paresthesias. Abolished patellar reflex and Achilles. Positive Romberg. Unsteady gait with increased base of support. No other alterations in neurological exploration.

Complementary tests: no alterations in blood test or skull CT.

Evolution: the patient is admitted in Neurology Plant to study alterations, been diagnosed during the admission of Guillain-Barré syndrome.

Keywords: Unsteady gait, paresthesias, Guillain-Barré

P-0299

Varicella Encephalitis In Patient Coming With Afebrile Convulsions: Case Report

Nadiye Karabulut¹, Özlem Sazak¹, Seçil Günher Arıca¹, Bahar Çalışkan², Murat Eleveli²

¹Haseki Eğitim ve Araştırma Hastanesi, Aile Hekimliği Kliniği, İstanbul

²Haseki Eğitim ve Araştırma Hastanesi Pediatri Kliniği, İstanbul

Introduction:

Chickenpox (varicella), often a self-limiting disease, is characterized by a vesiculobullous rash and its infectious agent is varicella zoster virus. Neurological complications of the varicella infection often occur within 2 to 6 days after the rash onset. Meningoencephalitis is the second most common Neurological complication of varicella, and its mortality rate varies between 5-20%. The clinical course goes with the changes in the level of consciousness, convulsions, fever, headache, and neck stiffness. In this case report we will describe a case of meningoencephalitis seen after varicella infection

CASE: 12-year-old girl was brought to the emergency department with afebrile convulsions and minor head trauma. Glasgow Coma Skale score was 8 but vital signs, cerebrospinal fluid (CSF), hemogram, blood electrolyte levels, kidney and liver function tests were within normal limits. Brain CT scan was also normal. A few crusted varicella vesicles were observed on her back associated with varicella infection she had 5 days ago and the results of the Brain MRI with contrast was consistent with meningoencephalitis.. The minor head trauma in her anamnesis was also tricky. When we questioned her parents deeply, it was clear that she lost her consciousness prior to falling down and crushing her head. Varicella encephalitis was diagnosed and acyclovir, levetiracetam treatment was started. She fully recovered without sequelae.

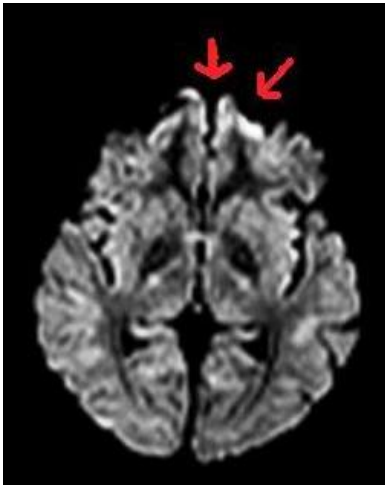
RESULT: In our case, the lab, CSF results and the Brain CT scan was normal. There were no specific findings in the CSF and blood lab result for diagnosis. As shown in this case; anamnesis, physical examination are more important than advanced laboratory examinations for the diagnosis and treatment of diseases.

Keywords: Varicella, convulsions, diagnosis, anamnesis, lab

crusted vesicles



Dural contrast enhancement in Cranial MRI with Contrast



P-0300

Acute intoxication for metformine

Julián Zarco Manjavacas¹, Antonio Ubiña Carbonero², Carmen María López Ríos², Juan Pablo García Paine³, Juan Paz Galiana⁴, Luis Antonio Calleja Cartón¹

¹C.S. El Palo, Málaga, Spain

²C.S. Victoria, Málaga, Spain

³Department of Emergency, H. Parque San Antonio, Málaga, Spain

⁴Department of Emergency, H. General de Tomellos, Tomelloso, Ciudad Real, Spain

Personal history: female, 71 years. No drugs allergies. Diabetes mellitus type 2. in treatment with metformine. Bipolar disorder.

Present illness: patient presented to the emergency after ingesting 50 metformine tablets (42,5 gr.) with autolytic notion. Good diuresis. Normal blood pressure. Good oxygen saturation.

Blood test: lactic acidosis with increasing blood creatinine (from 0.6 to 1.4 mg/dl).

Diagnosis: kidney failure after acute drug intoxication with autolytic notion.

Evolution: the patient is admitted in ICU to make hemofiltration having a good response to treatment, presenting afert it a normal kidney function.

CONCLUSION: any medication can be used with autolytic notion. Although is not very common in attempted suicide, metfformine can have serious consencuencias in big doses.

Keywords: Metformine, acute intoxication, autolytic.

P-0301

Vertigo and acute headache in a patient with pre-existing renal disease

Carmen María López Ríos¹, Antonio Ubiña Carbonero¹, Julián Zarco Manjavacas², Juan Pablo García Paine³, Juan Paz Galiana⁴, Francisco José Cervilla Suárez²

¹C.S. Victoria, Málaga, Spain

²C.S. El Palo, Málaga, Spain

³H. Parque San Antonio, Málaga, Spain

⁴Department of Emergency, H. General de Tomellos, Tomelloso, Ciudad Real, Spain

Personal history: Male 56 years. Hypertension treated with Carvedilol 6.25 mg / 12h and Irbesartan 300 mg / 24h. Right nephrectomy for renal neoplasia 18 months ago. He did not need adjuvant chemotherapy; monitored for Urology

Present Illness: holocraneal oppressive headache 24 hours of evolution associated with nausea and vomiting food.

No fever. Unstable gait and sense of rotation of objects. No other symptoms

Physical exploration: Cardio-pulmonary auscultation normal, abdomen without alterations. Neurological: Ratio and oriented. Language without alteration. Pupils undisturbed, no alteration of cranial nerves, No motor or sensory disturbances.

Complementary test: Blood test and ray X: without pathological changes. CT skull: Area finger-affecting parieto-temporo-occipital lobe left with mass effect on left lateral ventricle

Diagnosis: Brain injury to discard metastasis.

Keywords: Oppressive headache, vertigo, metastasis

P-0302

A strange X-ray with an unusual sign

João Rocha Moutinho, Diana Almeida Ferreira

Unidade de Cuidados de Saúde Personalizados da Mealhada

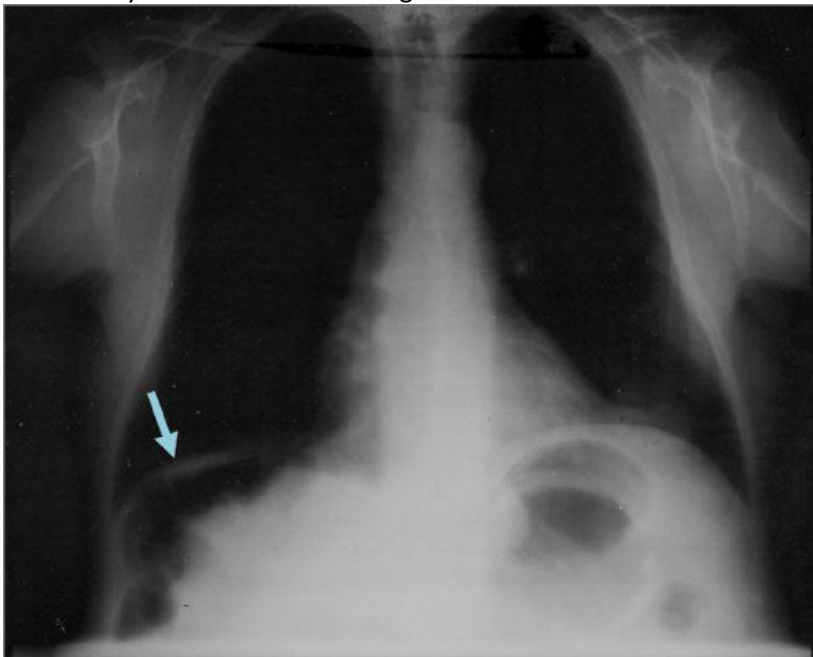
INTRODUCTION: The Chilaiditi's sign is a rare radiological sign, asymptomatic, which is characterized by the presence of temporary or permanent hepatodiaphragmatic interposition of the bowel, involving specially the transverse colon and that can be seen on a chest X-ray. It's incidence in radiographs is between 0.025% and 0.28% including all age groups, increasing slightly in over 60 years of age and is more common in men than in women, in a ratio of 4:1. Chilaiditi's sign can be attributed to various anatomical variations, including absence of the suspensory ligaments of the transverse colon and falciform ligament of the liver, redundant colon, right diaphragmatic paralysis and enlargement of the thorax leaving extra space for potential colon migration.

Case description: ♂, 67 years old, caucasian, belonging to a nuclear family, in Phase VIII of Duvall Cycle, lives with his wife. Currently has hypertension, dyslipidemia and obstructive sleep apnea, treated with enalapril 5mg, atorvastatin 40mg and nasal continuous positive airway pressure (CPAP). Consulted emergency rescue because of headaches, chest pains, permanent cough. dyspnea and fever and a diagnosis of community-acquired pneumonia was made. After the complete empirical antibiotic treatment, consulted the family doctor to a clinical, laboratory and radiological reevaluation, where he presented a chest X-ray with Chillaiditi's sign.

DISCUSSION: The Chilaiditi's signal is a rare entity, usually found incidentally on imaging tests. Usually is a benign and asymptomatic signal but requires a differential diagnosis of the right subphrenic airspace included pneumoperitoneum, diaphragmatic hernia and subdiaphragmatic abscess. Despite being benign it requires medical vigilance because when symptoms are involved it is called Chillaiditi's syndrome and can be accompanied by abdominal pain, nausea, retrosternal pain, respiratory symptoms vomiting, bloating, intestinal obstruction or subocclusion and in this case an extensive medical evaluation is vital and in some situations surgery is required.

Keywords: Chilaiditi, pneumonia, X-ray

Chest X-ray with the Chilaiditi's sign.



Presence of a bowel loop in the hepato-diaphragmatic space.

P-0303

Electrocardiogram and chest pain in real practice - A retrospective cohort study in Family Practice in Portugal

Paulo Santos¹, Carlos Martins¹, Paulo Pessanha², Manuel Viana², Luísa Sá¹, Alberto Pinto Hespanhol¹, Altamiro Costa Pereira³, Luciana Couto¹

¹General & Family Medicine Unit - Department of Social Sciences and Health, Faculty of Medicine of University of Oporto, Portugal

²Family Health Unit of S. Joao of Porto, Porto, Portugal

³Information Sciences and Decision on Health Department (CIDES), Faculty of Medicine, Centre for Research in Health Technologies and Information Systems (CINTESIS), University of Porto, Porto, Portugal

BACKGROUND: Electrocardiogram (ECG) plays a major role in the study of chest pain.

AIM: To measure the impact of making an ECG in patients with chest pain (CP) in Primary Care.

METHODS: We conducted a retrospective cohort study of patients with CP that made an ECG in a Primary Care setting by comparison with those who made the ECG as a routine test, in order to measure the change of cardiovascular clinical guidance up to 6 months after ECG. Cases were categorized in atypical or typical CP. Secondary a clinical practice analysis was performed, counting the number of medical visits 12 months before and after ECG.

RESULTS: We studied 480 patients, consecutively selected during 4 years, 333 in CP group (286 with atypical CP), and 147 controls. Patients with typical CP presented higher changing in clinical guidance (RR=4.299; 95%CI:2.378–7.772, p<0.001) than patients with atypical CP (RR=1.116; 95%CI: 1.008–1.235, p=0.047), when compared with controls. In the routine group there wasn't any variation of visits counting, as in the typical CP group, but a reduction of 0.59 visits (95%CI: -0.90 to -0.29;p<0.001) occurred in the atypical CP patients one year after the ECG. Anxiety was significantly associated to atypical CP orientation.

CONCLUSIONS: Making an ECG leads to a higher referral to hospital care, but doesn't affect the therapeutics or the request of other tests in CP patients, with a decrease in office visits among those with atypical pain, reflecting a significant impact on its health status, thus justifying its use.

Keywords: Chest pain; Primary care; Electrocardiography; Physician's practice patterns, Disease management; Health impact assessment

Sample characteristics

Sample characteristics

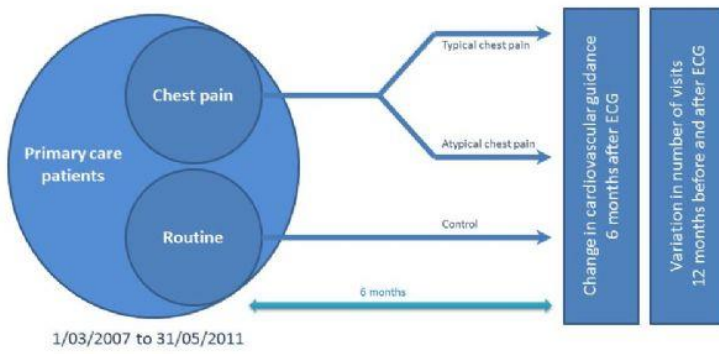
	Routine n=147	Atypical chest pain n=286	Typical chest pain n=47		Correlation (Spearman)
Patients	142	271	42		
Male	80 (56,3%)	111 (41,0%)	15 (35,7%)	p=0,002 *	
Age (mean, SD)	52,9 (±17,7)	52,4 (±18,7)	67,0 (±14,1)	p<0,001 **	
Urgency (%)	0,7	21,3	51,1	p<0,001 *	0,364 §

* Qui-quadrado; ** Kruskal Wallis teste; § p<0,05

Demographic data of included participants

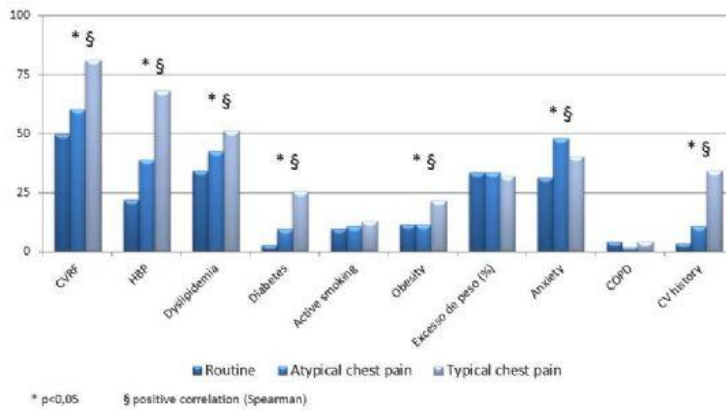
Study design

ECG and chest pain in real practice



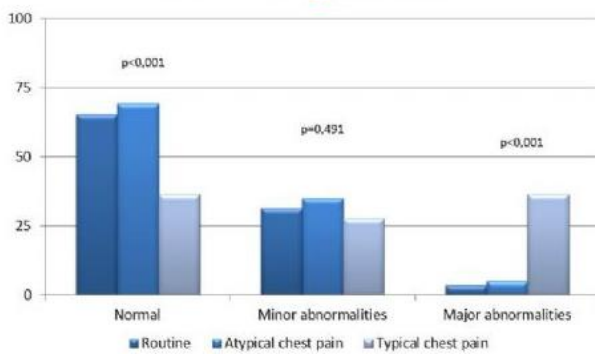
Comorbidities

Comorbidities



ECG diagnosis

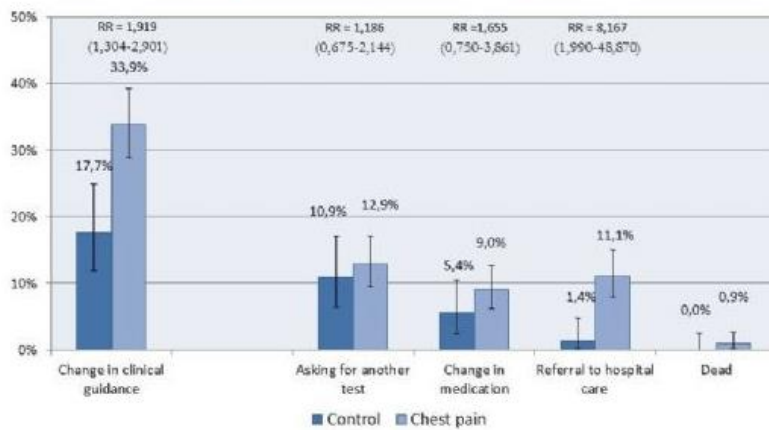
ECG diagnosis



Results of ECG in included patients

Change in clinical guidance

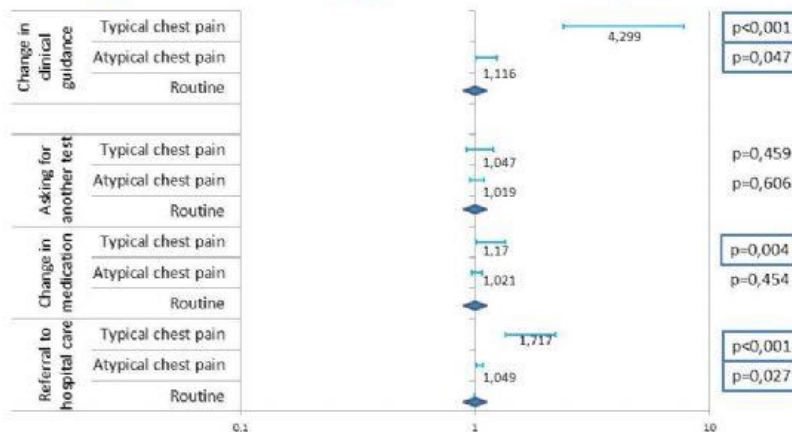
Change in clinical guidance



In patients with chest pain, the change in clinical guidance depends mainly of the reference for hospital care. There's no change in medication or asking for another test in both groups.

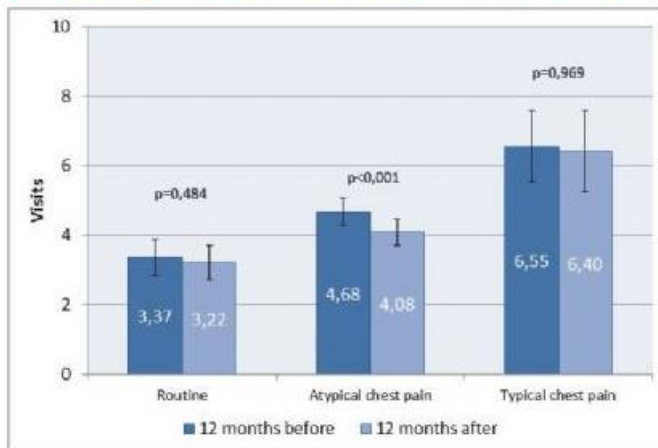
Typical vs atypical chest pain

Typical vs atypical chest pain



The direct comparison of patients with typical and atypical chest pain. The key factor for decision making is the presence of anxiety together with an abnormal ECG. This brings to the discussion the need for reassurance that a normal test can strengthen.

Clinical practice activity analysis



Patients of routine group didn't show differences in the counting of visits before and after making the ECG. The same occurred in the patients with typical chest pain, which maintained the pattern of access to their doctors. On the other hand, patients with atypical chest pain had a reduction of 0,6 visits 12 months after the test. This is consistent with the hypothesis of the ECG have a positive therapeutic effect on reassurance of patients, reflected in the improvement of the demand of health care

P-0304

Pemphigus Vulgaris vs Bullous Pemphigoid

Teresa Pereira Leite¹, David Rodrigues², Marta Lopes², Nidia Nunes², Susana Grilo Lourenço²

¹USF Alcoides, ARS Alentejo, Montemor-O-Novo, Portugal

²USF Planície, ARS Alentejo, Évora, Portugal

Pemphigus are autoimmune bullous dermatosis that affect 0,5 to 3 per 100.000 individuals. They are characterized by the presence of autoantibodies against desmosomes of keratinocytes leading to acantholysis and formation of intraepidermal bubble. These are severe diseases with a mortality rate of 5 to 15%. Pemphigus vulgaris is the most common form, accounting for about 80-85% of cases. Pemphigoid are also autoimmune bullous dermatosis, whose resemblance to the pemphigus justifies its designation. In those cases bubble formation results from cleavage of the dermal-epidermal junction, affecting the hemidesmosomes. Prognosis is favorable in most situations. Bullous pemphigoid is the most common form, being the most prevalent bullous dermatosis, with an estimated incidence of 7 million cases per year in Western Europe. Despite the similarity between the clinical presentation of pemphigus vulgaris and bullous pemphigoid, these conditions have distinct prognosis and severity, so it is crucially important to differentiate them. The aim of this work is to briefly describe these dermatosis, highlighting the main features that distinguish one from another.

Literature search was undertaken in February 2015 in Dermatology textbooks and Medline database of review articles published between 2010 and 2015 in portuguese and english, using the MeSH terms "pemphigus vulgaris" and "bullous pemphigoid".

Of the 263 articles that met the inclusion criteria, 5 were relevant to the realization of this work. The main differences observed between pemphigus vulgaris and bullous pemphigoid reside in: epidemiological aspects (incidence, prevalence, age and gender of affected individuals); clinical manifestations (symptoms, usual location and characteristics of the lesions); physical examination findings; etiology; histopathology; immunopathology; disease progression and prognosis. The treatment of both dermatosis is based on corticotherapy.

The distinction between pemphigus vulgaris and bullous pemphigoid can be a diagnostic challenge. However, these conditions have specific characteristics, allowing a definitive diagnosis based on clinical aspects and histopathological examination.

Keywords: "Pemphigus Vulgaris" "Bullous Pemphigoid"

Table 1 - Main differences between Pemphigus Vulgaris and Bullous Pemphigoid

		PEMPHIGUS VULGARIS	BULLOUS PEMPHIGOID
Epidemiological Aspects	Incidence	1/1.000.000 person year	21/1.000.000 person year
	Age	between 40 and 60 years	> 50 years, mostly between 75 and 80 years
	Gender	no predominance	male predominance
Clinical Manifestations	Typical Signs/Symptoms	severe pain in erosion areas (mucosal and cutaneous), anorexia and sialorrhoea	prodromal pruriginous uncharacteristic dermatitis
	Lesions Usual Location	oral mucosa (first weeks), upper torso, head, neck, pressure zones and large cutaneous folds	large skin folds, inner surfaces of thighs, lower abdomen, often with symmetry
	Lesions Characteristics	sero-haemorrhagic flaccid blisters, millimetric and fragile that increase peripherally causing large erosion areas	tense blisters, some large and confluent, with sero-haemorrhagic content and erythematous base
Physical Examination Findings		positive Nikolsky sign	negative Nikolsky sign
Etiology		genetic factors combined with triggering factors (drugs, infections, vaccines, stress)	genetic factors combined with triggering factors (drugs, cancer, UV radiation)
Histopathology		intraepidermal suprabasal cleavage (acantholysis)	dermal-epidermal cleavage (basal lamina)
Immunopathology		antibodies "pemphigus type" against desmoglein 1 and 3 of the desmosomes of acanthocytes	antibodies against bullous pemphigoid 1 and 2 antigens of hemidesmosomes
Disease Progression		severe, chronic and persistent	usually self-limited
Disease Prognosis		bad prognosis, high mortality associated	favorable prognosis in most situations

P-0305

Paracetamol Effect on Blood Pressure: What is the Evidence?

Sara Quelha, Bruno Morrão
 USF Arca d'Água; ACeS Porto Oriental; Porto; Portugal

Background and AIM: Paracetamol is one of the most consumed drug in the world, and its use is due to its antipyretic and analgesic activity of mild to moderate pain. In view of the fact that the anti-inflammatory non-steroids are associated with increased blood pressure and interfere with antihypertensive drugs, paracetamol was taken as a safe and recommended as first-line analgesic in patients with cardiovascular morbidities. However, recent studies call into question their safety. The objective is to evaluate the safety and effect of paracetamol on the level of blood pressure.

METHODS: Systematic review through electronic search engines Cochrane, DARE, Bandolier, National Guideline Clearinghouse, Guidelines finder, Canadian Medical Association Practice Guidelines Infobase and Medline.

RESULTS: In the total of 154 articles were analyzed 4 articles (1 systematic review, 1 randomized trial and 2 cohort studies). The only systematic review included 19 holds articles in which two of them demonstrate a significant increase in systolic blood pressure between 3 to 4 mmHg (p <0.05) and the other items did not found any change. In the randomized clinical study there was an increase of 4.4 mmHg in systolic blood pressure and 2,9mmHg in diastolic blood pressure (p <0.05). The two analyzed cohort studies have shown a blood pressure increase in relation to the use of paracetamol reaching a level difference in systolic blood pressure of 1,6mmHg.

CONCLUSION: The effect of paracetamol in blood pressure and its safety in patients with cardiovascular risk factors is unclear. Blood pressure should be strictly monitored whenever the paracetamol use in these situations. In the future will require more homogeneous and consistent studies to tackle the weaknesses of the current evidence.

Keywords: paracetamol; acetaminophen; blood pressure

Systematic Reviews

Study	Reference	Study type	Study	Population	Intervention	Results	Conclusion	Evidence Level
Systematic Review	Emma J Turtle, James W Dear and David J Webb (2012)	2 Reviews					The paracetamol effect in arterial pressure and his cardiovascular safety is not clear The paracetamol must be used with precaution in patients with coronary disease.	3
		7 Cohort Studies						
		6 Randomized Controlled Trials	Chalmers et al.	AH/n=22	Ig. 8/8h, 45	Increase 4mmHg in BP (p<0,05)		
			Lewis et al.	AH/n=21	Ig. 6/6h, 25	No effect in BP		
			Radack et al.		Ig. 6/6h, 35			
			Chau et al.		650mg, single dose			
			Pavlicevic et al.		Ig. 8/8h, 1M			
		Sudano et al.	Acute Coronary Syndrome	Ig. 8/8h, 25	Increase 3mmHg in SBP (p<0,02)			
3 Case Reports								
1 Opinion Article								

Randomized Controlled Trial and Cohort Studies

Study	Reference	Population	Intervention	Results/Conclusions	Evidence level
Randomized Controlled Trial	Dawson J, Fulton R, McInnes GT, Morton R, Morrison D et al (2013)	AH treated with ramipril vs valsartan or lisicren	Blood pressure evaluation in patients treated with paracetamol vs naproen	Increase 4.4mmHg in Systolic Blood Pressure and 2.9mmHg in Diastolic Blood Pressure in patients previously treated with ramipril, valsartan or lisicren, when treated with paracetamol (P <0.05). The blood pressure must be monitored in patients treated with paracetamol	1
Cohort	Dawson J, Fulton R, McInnes GT, Morton R, Morrison D et al (2013)	>65 years + AH/ n=2754/United Kingdom	Blood pressure in patients treated with paracetamol through 3 months vs basal Clinic	Increase: -1.8mmHg SBP (p=0,001; 95% IC: 0,7-2,5) +0,5mmHg DBP (p=0,02; 95% IC: 0,1-1)	3
	Qingqing Huang, Wangwen Li, Nan Li et al (2013)	Adults with chronic headache/China/ n=308	Analgesic drugs overuse vs not overuse in chronic headache and subtypes	AH increase frequency: RR 2,468 (p=0,01)	

P-0306

Corticosteroid injection for adhesive capsulitis in primary care: a review

Koh Kim Hwee

Tampines Polyclinic, Singhealth Polyclinics, Singapore

Background & AIM:

Adhesive capsulitis is a common condition causing shoulder pain and stiffness. Most patients can be managed with non-operative treatment in the primary care setting & corticosteroid injections are among the more commonly used intervention. However, there is currently a lack of good evidence to support its efficacy, especially in the long term, and its use compared to other modalities. The objective of this review is to assess the efficacy of corticosteroid injections for adhesive capsulitis.

METHOD:

PubMed and CENTRAL databases were searched from Dec 1994 to Dec 2014. Randomised controlled trials (RCTs) reporting the efficacy of corticosteroid injections in adhesive capsulitis versus placebo and other non-operative treatment modalities, as well as those that investigated different doses and different injection techniques were included. JADAD scoring system was used to assess the methodological quality of the included studies. The conclusions and results of the identified studies based on their outcome measures were then summarised.

RESULTS:

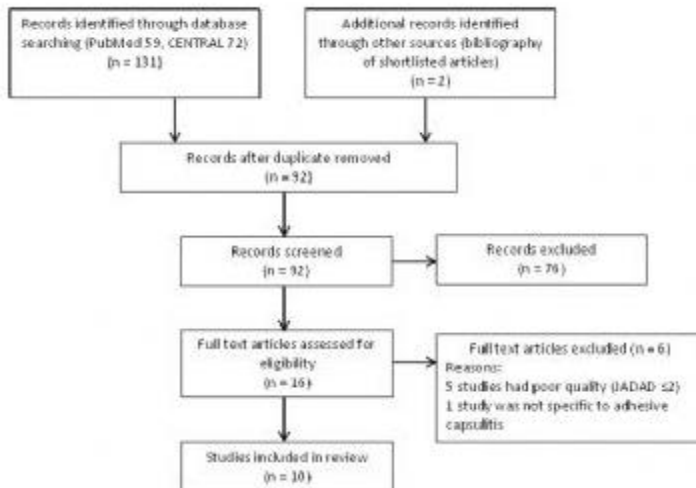
Fifteen RCTs were reviewed. Intra-articular corticosteroid was found to be superior to no treatment (1 trial) and normal saline (1 trial) up to 12 weeks. Corticosteroid injection led to more rapid improvement compared to physiotherapy and their combination was better than either modality alone. Use of 40mg triamcinolone acetonide was superior to 10mg but there were no difference between 20 and 40mg use. Subacromial injection had similar outcomes as glenohumeral injection. Intra-articular corticosteroid injections led to faster improvement compared to oral steroids but there were no difference when compared to oral NSAIDs. Ultrasound guidance also led to improved outcomes compared to blind injections.

CONCLUSIONS:

In the primary care, physicians should consider corticosteroid injection as the first line treatment and consider concurrent physiotherapy for greater improvement. Subacromial injection may be used as an alternative to glenohumeral injection. Ultrasound guidance would also be useful.

Keywords: Adhesive capsulitis, corticosteroids, injection

Figure 1: PRISMA diagram



References

1. Bal A, Eksioglu E, Gulec B, Aydog E, Gurcay E, Cakci A. Effectiveness of corticosteroid injection in adhesive capsulitis. *Clin Rehabil.* 2008 Jun;22(6):503-12.
2. Roh YH, Yi SR, Noh JH, Lee SY, Oh JH, Gong HS, Baek GH. Intra-articular corticosteroid injection in diabetic patients with adhesive capsulitis: a randomized controlled trial. *Knee Surg Sports Traumatol Arthrosc.* 2012 Oct;20(10):1947-52.
3. Ryans I, Montgomery A, Galway R, Kernohan WG, McKane R. A randomized controlled trial of intra-articular triamcinolone and/or physiotherapy in shoulder capsulitis. *Rheumatology (Oxford).* 2005 Apr;44(4):529-35.
4. Carrette S, Moffet H, Tardif J, Bessette L, Morin F, Frémont P, Bykerk V, Thorne C, Bell M, Bensen W, Blanchette C. Intraarticular corticosteroids, supervised physiotherapy, or a combination of the two in the treatment of adhesive capsulitis of the shoulder: a placebo-controlled trial. *Arthritis Rheum.* 2003 Mar;48(3):829-38.
5. van der Windt DA, Koes BW, Devillé W, Boeke AJ, de Jong BA, Bouter LM. Effectiveness of corticosteroid injections versus physiotherapy for treatment of painful stiff shoulder in primary care: randomised trial. *BMJ.* 1998 Nov 7;317(7168):1292-6.
6. Dehghan A, Pishgoei N, Salami MA, Zarch SM, Nafisi-Moghadam R, Rahimpour S, Soleimani H, Owlia MB. Comparison between NSAID and intra-articular corticosteroid injection in frozen shoulder of diabetic patients; a randomized clinical trial. *Exp Clin Endocrinol Diabetes.* 2013 Feb;121(2):75-9.
7. Yoon SH, Lee HY, Lee HJ, Kwack KS. Optimal dose of intra-articular corticosteroids for adhesive capsulitis: a randomized, triple-blind, placebo-controlled trial. *Am J Sports Med.* 2013 May;41(5):1133-9. doi: 10.1177/0363546513480475.
8. de Jong BA, Dahmen R, Hogeweg JA, Marti RK. Intra-articular triamcinolone acetone injection in patients with capsulitis of the shoulder: a comparative study of two dose regimens. *Clin Rehabil.* 1998 Jun;12(3):211-5.
9. Shin SJ, Lee SY. Efficacies of corticosteroid injection at different sites of the shoulder for the treatment of adhesive capsulitis. *J Shoulder Elbow Surg.* 2013 Apr;22(4):521-7.
10. Oh JH, Oh CH, Choi JA, Kim SH, Kim JH, Yoon JP. Comparison of glenohumeral and subacromial steroid injection in primary frozen shoulder: a prospective, randomized short-term comparison study. *J Shoulder Elbow Surg.* 2011 Oct;20(7):1034-40.

Table 1: Characteristics of included studies

Study	Setting	Population	Intervention / co-intervention group	Comparison / control group	Injection technique	Outcome measures	Follow-up
Bal, 2007 [1]	Outpatient, Turkey	<p>n = 80*</p> <p>Inclusion criteria: 18 to 70 years, newly diagnosed adhesive capsulitis, shoulder pain with limitation of active and passive ROM $\geq 25^\circ$ in at least 2 directions, duration of symptom 6 weeks to 6 months, no prior treatment other than analgesia</p> <p>Exclusion criteria: uncontrolled DM, contraindications of injections, previous shoulder surgery</p> <p>Mean age: 56.3 to 56.9 years Duration of symptoms: NR Stage of disease: NR Number of DM patients included: NR</p>	<p>40mg (1ml) methylprednisolone acetate (n = 40)</p> <p>Co-intervention: home exercise program x 12 weeks, oral paracetamol (1500mg/day) when needed</p>	Intra-articular injection with 1ml 0.9% normal saline (n = 40)	Blind intra-articular injection, posterior approach, single injection	SPADI score, UCLA end-result score, passive ROM (measured with goniometer), night pain (100mm VAS)	2, 12 weeks
Roh, 2012 [2]	Actual site NR, Seoul, South Korea	<p>n = 45*</p> <p>Inclusion criteria: diabetic patients with adhesive capsulitis, shoulder pain with passive</p>	<p>40mg (1ml) triamcinolone acetonide + 3ml 2% lignocaine (n = 23)</p> <p>Co-intervention: home stretching</p>	No injection (n = 22)	USG intra-articular injection, posterior approach, single injection	Pain (10cm VAS), passive ROM (measured with goniometer), ASES score	4, 12, 24 weeks

ROM limitation >25° or 30° in at least 2 directions compared to opposite shoulder or normal value, unresponsive to stretching exercise with NSAIDs for 3 months or if unable to participate in home stretching exercise

Exclusion criteria: shoulder trauma, cerebrovascular accident, endocrinal abnormality other than diabetes, significant glenohumeral arthritis, blood coagulation disorder, previous intra-articular therapy

Mean age: 54.4 to 55.3 years
 Mean duration of symptoms: 6.2 to 6.5 months
 Stage of disease: freezing and frozen stage
 Number of DM patients included: 45

n = 78*
 Inclusion criteria: Age >18 years with

Injection & physiotherapy group: 20mg (1ml) triamcinolone + 2ml normal saline

Physiotherapy group: 3ml normal saline injection + 4 weeks

Blind combined approach (1.5ml anterior

Pain at rest (100mm VAS), global improvement (100mm

6, 16 weeks

Ryans, 2005 [3]

Outpatient, UK

<p>diagnosis of shoulder capsulitis, shoulder pain in C5 dermatome, limitation of passive and active abduction and external rotation > 25% compared with opposite shoulder, duration of symptom 4 weeks to 6 months</p>	<p>+ 4 weeks physiotherapy (n = 20)</p> <p>Injection only group: 20mg (1ml) triamcinolone + 2ml normal saline only (n = 19)</p> <p>Co-interventions: oral paracetamol, home exercise program</p>	<p>physiotherapy (n = 20)</p> <p>Placebo group: 3ml normal saline injection only (n = 19)</p>	<p>glenohumeral injection and 1.5ml lateral subacromial injection), single injection</p>	<p>VAS), passive external rotation (measured with goniometer), SDQ score</p>
--	--	---	--	--

Exclusion criteria: pain <4 weeks or >6 months, previous intra-articular injection or physiotherapy, evidence of glenohumeral osteoarthritis on x-ray, clinical evidence of complete rotator cuff tear, significant cervical spine disease, significant shoulder trauma, inflammatory joint disease, cerebrovascular accident, bilateral adhesive capsulitis, contraindication to steroid injection

Mean age: 52.3 to 56.3 years
Duration of symptoms: 12.2

		to 14.9 weeks Stage of disease: NR Number of DM patients included: 5 n = 93*					
		Inclusion criteria: Age >18 years with adhesive capsulitis, shoulder pain with ≥25% loss of active and passive ROM in at least 2 direction compared with contralateral shoulder, duration of symptom <1 year, SPADI score ≥30	Injection & physiotherapy group: 40mg (2ml) triamcinolone hexacetonide + 4 weeks physiotherapy (n = 21)	Physiotherapy group: 2ml normal saline injection + 4 weeks physiotherapy (n = 26)	Fluoroscopic guided intra-articular injection, single injection	SPADI, SF-36, active and passive ROM (measured with goniometer)	6 weeks, 3, 6, 12 months
Carette, 2003 [4]	Outpatient, Quebec & Ontario, Canada	Exclusion criteria: secondary adhesive capsulitis (except DM), known coagulation disorder, contrast allergy	Injection only group: 40mg (2ml) triamcinolone hexacetonide only (n = 23) Co-intervention: home exercise program	Placebo group: 2ml normal saline injection only (n = 23)			
		Mean age: 54.2 to 56.5 years Mean duration of symptoms: 20.3 to 22.1 weeks Stage of disease: NR Number of DM patients included: 6 n = 109*	40mg triamcinolone acetone (n = 53) No co-interventions	Physiotherapy (12 sessions for 6 weeks) (n = 56)	Blind intra-articular injection, posterior approach. No more	Pain associated with main complaint, day pain, night pain	3, 7, 13, 26, 52 weeks
van der Windt, 1998 [5]	Outpatient, general practice, Netherlands	Inclusion criteria: Age >18 years, painful stiff shoulder					

(capsular syndrome), painful and limited passive ROM, with external rotation more restricted than abduction and internal rotation

than 3 injections (average 2.2 injections) in 6 weeks

(100 mm VAS), SDQ score Overall clinical severity (clinician rated 100mm VAS), passive external rotation and abduction (measured with inclinometer)

Exclusion criteria: bilateral symptoms, corticosteroid injections or physiotherapy in preceding 6 months, contraindications to treatment, shoulder surgery, dislocation or fracture, Type 1 DM, systemic musculoskeletal or neurological disorders

Mean age 57.3 to 60.2 years
Duration of symptoms: ranges from < 1 month to > 12 months
Stage of disease: NR
Number of DM patients included: NR
n = 75*

Dehghan, 2013 [6]

Outpatient, Yazd, Iran

Inclusion criteria: diabetic patients with adhesive capsulitis, shoulder pain and limited shoulder ROM in all direction

40mg triamcinolone acetonide (n = 40)

Co-intervention: home exercise

Oral naproxen 500mg BD for 1 month (n = 35)

USG intra-articular injection, anterior approach, single injection

Pain (10cm VAS), ROM (measured with goniometer) 2, 6, 12, 24 weeks

Exclusion
 criteria:
 symptoms >6
 months,
 secondary
 adhesive
 capsulitis, active
 peptic ulcer
 disease, history
 of GI bleeding,
 coagulopathies,
 renal failure

Mean age:
 52.78 to 55.31
 years
 Duration of
 symptoms: NR
 Stage of
 disease: NR
 Number of DM
 patients
 included: 75
 n = 53*

Inclusion
 criteria: Age 20
 to 70 years,
 primary
 adhesive
 capsulitis,
 shoulder pain
 with restricted
 passive ROM
 >30o in 2 or
 more plane of
 movement,
 duration of
 symptoms at
 least 1 month,
 average pain ≥
 3/10 on VAS

40mg (4ml)
 triamcinolone
 acetone + 1ml
 1% lignocaine) (n =
 20)

Co-intervention:
 home exercise
 program x 12
 weeks

20mg (2ml)
 triamcinolon
 e acetone +
 3ml 1%
 lignocaine (n
 = 20)

Placebo
 group: 5ml
 1%
 lignocaine (n
 = 13)

USG intra-
 articular
 injection,
 posterior
 approach,
 single
 injection

SPADI score,
 global
 shoulder
 pain (10cm
 VAS),
 passive ROM
 (measured
 with
 goniometer)

Yoon,
 2013
 [7]

Outpatient,
 Suwon,
 Korea

1, 3, 6,
 12
 weeks

Exclusion
 criteria:
 secondary
 adhesive
 capsulitis,
 rotator cuff
 lesions,
 previous
 corticosteroid
 injections, use
 of antiplatelet

or anticoagulant

Mean age: 52.2
to 55.9 years
Mean duration
of symptoms:
4.7 to 5.5
months
Stage of
disease:
freezing stage
Number of DM
patients
included: NR
n = 57*

Inclusion
criteria:
shoulder
capsulitis, pain
in shoulder and
arm, restriction
of passive
external
rotation $\geq 45^\circ$,
waking up at
night due to
pain when lying
on afflicted
shoulder, no
clinical or
radiological
evidence of
other pathology

Exclusion
criteria: cervical
radiculopathy,
paresis or other
neurological
changes in
involved arm,
Type I DM

40mg
triamcinolone
acetonide (n = 25)

No co-
interventions

10mg
triamcinolon
e acetonide
(n = 32)

Blind intra-
articular
injection,
posterior
approach, 3
injections (0,
1, 3 weeks)

Pain (100cm
VAS),
disturbance
of sleep (4
point scale),
functional
impairment
(4 point
scale),
passive ROM
(measured
with
goniometer)

1, 3, 6
weeks

De Jong, 1998
[8] Outpatient,
Netherlands

Mean age: 54.5
to 55.0 years
Mean duration
of symptoms:
6.8 to 8.0
months
Stage of
disease: NR
Number of DM
patients
included: NR

		n = 191*					
		Inclusion criteria: age ≥18 years, primary adhesive capsulitis, shoulder pain with limitation of active and passive ROM in at least 2 directions, duration of symptoms >3 months		Group II: 40mg (1ml) triamcinolone + 4ml 2% lignocaine into glenohumeral joint (n = 48)			
Shin, 2013 [9]	Actual site NR, Seoul, South Korea	Exclusion criteria: Other subacromial or glenohumeral shoulder disorder, bilateral adhesive capsulitis, shoulder injury or surgery, glenohumeral arthritis	Group I: 40mg (1ml) triamcinolone + 4ml 2% lignocaine into subacromial space (n = 49)	Group III: 40mg (1ml) triamcinolone + 4ml 2% lignocaine divided into both subacromial and glenohumeral space (n = 47)	USG injection, posterior or lateral approach, single injection	ASES score, pain (10cm VAS), patient satisfaction (10cm VAS), active ROM (measured with goniometer)	2, 4, 8, 16, 24 weeks
		Mean age: 53.9 to 57.3 years Mean duration of symptoms: 6.8-7.7 months Stage of disease: NR Number of DM patients included: NR	Co-intervention: home exercise program	Group IV: Oral aceclofenac 100mg BD for 6 weeks (n = 47)			
		n = 71*					
Oh, 2011 [10]	Actual site NR, Seoul, South Korea	Inclusion criteria: primary frozen shoulder, shoulder pain and limitation of active and passive ROM in at least 2 directions, no improvement after conservative	40mg (1ml) triamcinolone + 4ml 2% lignocaine + 4ml normal saline into glenohumeral joint (n = 37)	40mg (1ml) triamcinolone + 4ml 2% lignocaine + 4ml normal saline into subacromial space (n = 34)	USG injection, posterior or lateral approach, single injection	Pain (10cm VAS), Constant score, passive ROM (measured with goniometer)	3, 6, 12 weeks
			Co-intervention: NSAIDs, analgesia, home exercise program				

management
for at least 6
weeks

Exclusion
criteria:
secondary
frozen shoulder

Mean age: 55.7
to 58.3 years
Mean duration
of symptoms:
6.2 to 6.9
months
Stage of
disease: NR
Number of DM
patients
included: 11

* number of patients who were randomised DM: diabetes mellitus; NSAID: non-steroidal anti-inflammatory drugs; NR: Not recorded; ROM: range of motion; USG: Ultrasound guided; SPADI: Shoulder Pain and Disability Index; VAS: Visual Analogue Score; ASES: American shoulder and elbow score; SDQ: Shoulder Disability Questionnaire; UCLA: University of California-Los Angeles

Table 2: Quality assessment of included studies using the JADAD score

Study	Randomisation	Method of randomisation	Blinding	Method of blinding	Account of all patients	Total score
Bal, 2007 [1]	1	1	1	0	1	4
Roh, 2012 [2]	1	1	0	0	1	3
Ryans, 2005 [3]	1	1	0	0	1	3
Carette, 2003 [4]	1	1	0	0	1	3
van der Windt, 1998 [5]	1	1	0	0	1	3
Dehghan, 2013 [6]	1	1	0	0	1	3
Yoon, 2013 [7]	1	1	1	1	1	5
De Jong, 1998 [8]	1	1	1	1	1	5
Shin, 2013 [9]	1	1	0	0	1	3
Oh, 2011 [10]	1	1	0	0	1	3

P-0307

When seems one thing but is another

Joana Palmira Magalhães

Centro de Saúde Miranda do Douro - ULS Nordeste, Bragança, Portugal

Background & AIM: Hypoglycemia is a complications of diabetes therapy, especially if the patient is medicated with insulin or a sulfonylurea. Each person's reaction to hypoglycemia is different, the signs and symptoms can be autonomic: sweating, shaking, hunger or palpitations and neuroglycopenic: difficulty concentrating, confusion, drowsiness, odd behavior (irritability, aggressiveness), speech difficulty or coma.

We seek to expose a case report that shows how the symptoms of hypoglycemia can be mistaken by psychiatric disease.

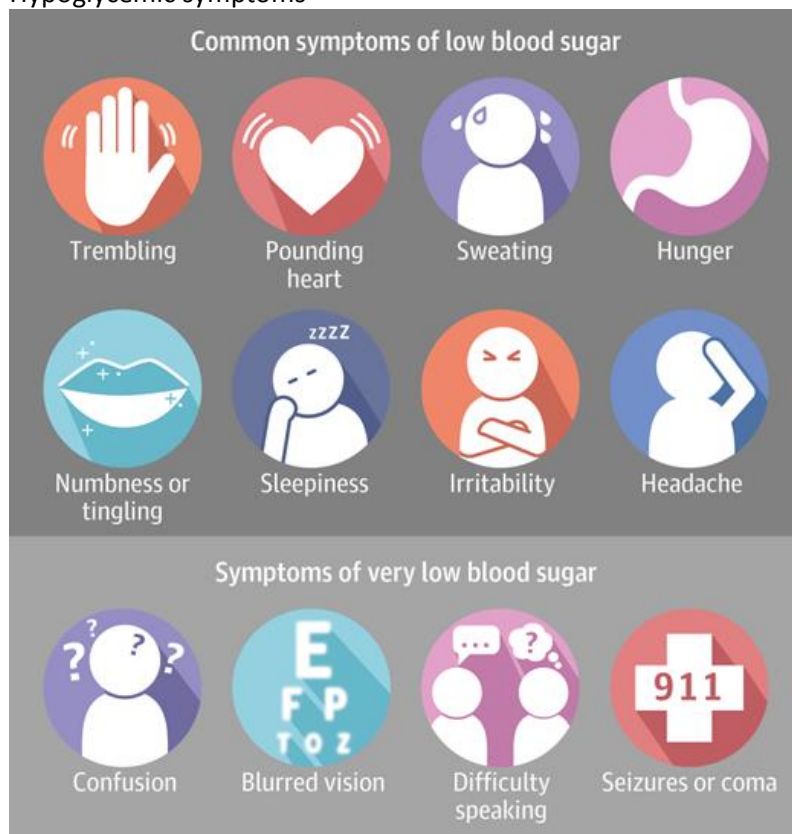
METHOD: Man, 66 years, history of insulin-dependent diabetes and dyslipidemia, brought by medical emergency service, to the urgency service, with sudden onset of disorientation, sporadic aggression and inappropriate speech. After observation was performed objective examination and cranial CT scan. With a normal physical examination described, was sent for reevaluations by different medical specialties, where chest X-ray and blood test were requested. The specialist evaluated the brain CT scan and decided that the changes detected didn't justify the clinical state. Than requested observation by psychiatry.

RESULTS: At the psychiatry urgency the patient was restless, confused, aggressive and with incoherent speech. After observation of the tests results, was measured capillary glucose and resulted in 36 mg/dl. Therapeutic approaches were applied to treat hypoglycemia and the patient quickly recovered consciousness, orientation, calmness and cooperation.

CONCLUSIONS: Hypoglycemia secondary to the use of insulin or insulin secretagogues is important to recognize and treat as early as possible. Individuals may need to adjust their insulin regimen to lower the risk. The frequency and severity of hypoglycemia has a negative impact on quality of life, promotes fear of future hypoglycemia and could be associated with increased mortality. It is related with reduced self-care and poor glycemic control. Therefore the prevention of hypoglycemia and its prompt and effective treatment is essential.

Keywords: Hypoglycemic symptoms, Psychiatric disease, Diabetes.

Hypoglycemic symptoms



The variability in symptoms of hypoglycemia.

Insulin injection



Injecting insulin into subcutaneous abdominal tissue.

P-0308

Life saving early detection of aneurysmal rupture

Rabee Kazan¹, Isabel Santsalvador Font², Miriam Rey Seoane³, Cristina Herranz Martinez³, Ana Rascón García⁴, Julio Verategui Cordova⁴

¹Hospital Mutua de Terrassa, Barcelona, Spain

²CAP Valldoreix, Valldoreix, Spain

³Hospital Viladecans, Barcelona, Spain

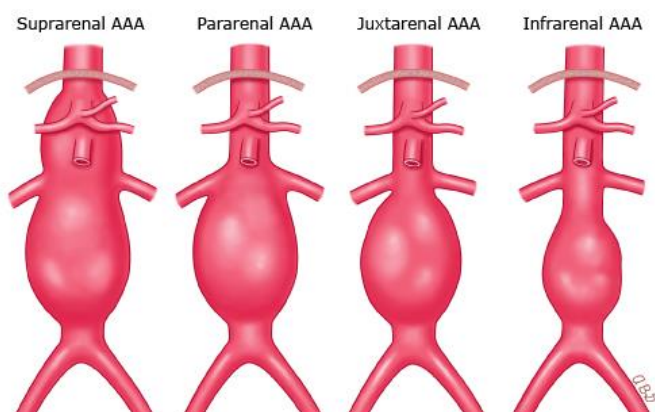
⁴CAP El Castell, Castelldefels, Spain

We present a poster showing types of abdominal aneurysm on adults, based on a case we managed to detect in our primary care center. A 67 years-old male with a history of hypertension, diabetes mellitus type II and ischemic heart disease, who consulted referring hypogastric abdominal pain of rapid onset with nausea but no vomiting or diarrhea. While visited he suffered a syncopal event with persistent hypotension even to volume replacement, it decided to transfer him to the Emergency Care of our reference Hospital. Once arrived there, he had a CT-Scan imaging that showed aneurysmal rupture of the left common iliac artery.

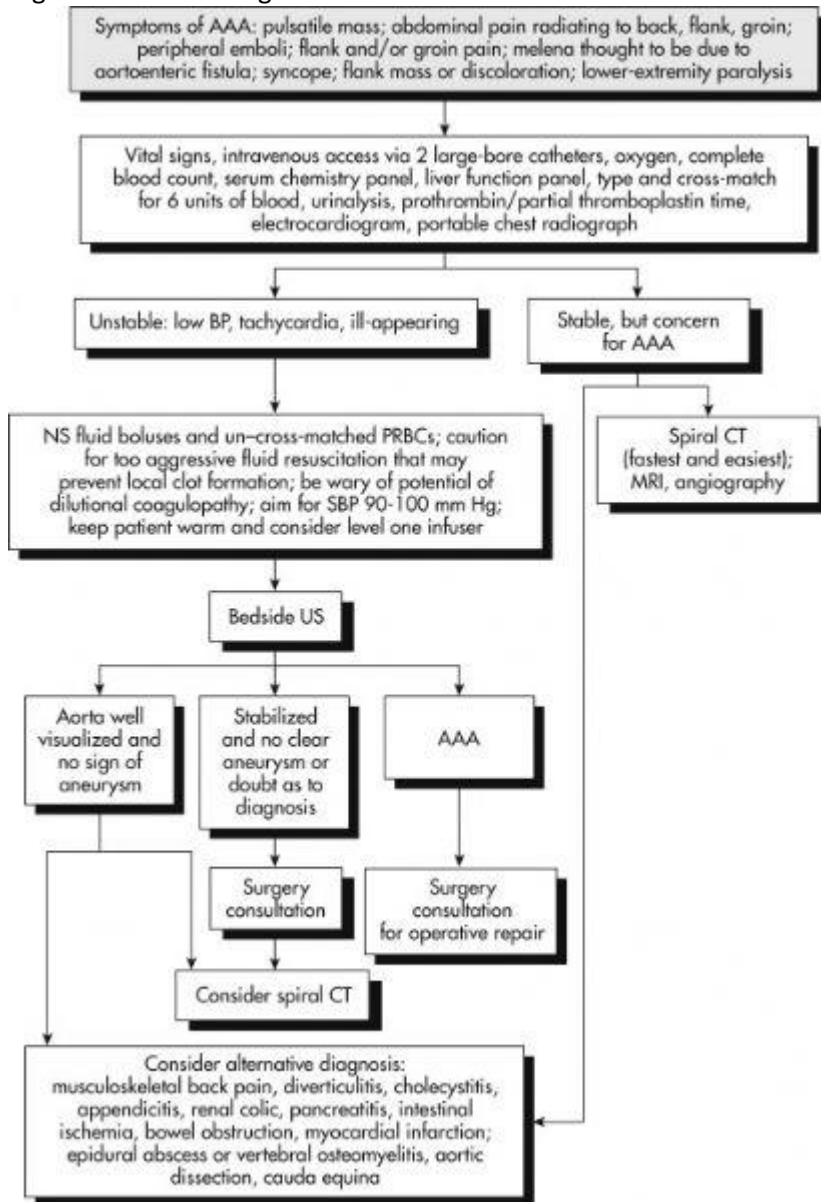
The Intensive Care Unit received him in a volumic shock state. It was managed to maintain blood pressure levels after vasoactive support with noradrenaline. Transferred to the vascular surgery department for an urgent intervention with a Dacron By-pass of the left common iliac artery and the left external iliac artery. Once stable he was discharged from the hospital and we attended him for a follow up visit in our consult. From a primary care point of view this case shows us that even though a life threatening condition could be overlooked easily, the suspicion and rapid management could save lives.

Keywords: aneurysmal rupture, hypotension, aneurysm, volumic shock.

Classification of abdominal aortic aneurysm

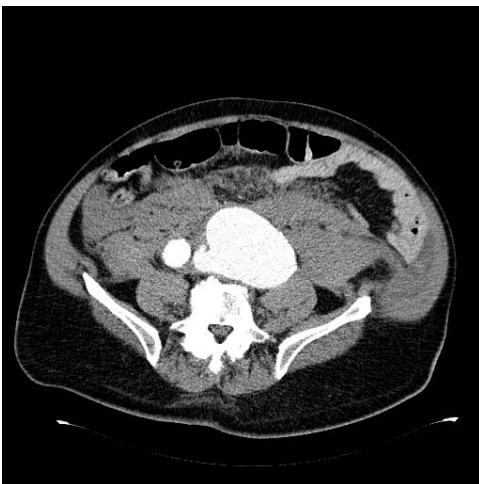


Algorithm for the diagnosis and treatment of abdominal aortic aneurysms (AAAs)

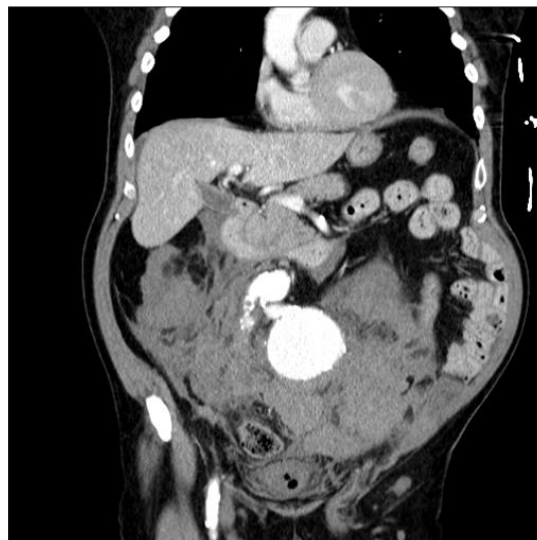


BP, Blood pressure; CT, computed tomography; MRI, magnetic resonance imaging; NS, normal saline; PRBCs, packed red blood cells; SBP, systolic blood pressure; US, ultrasonography. (From Adams JG et al: Emergency medicine, clinical essentials, ed 2, Philadelphia, 2013, Elsevier.)

abdominal CT with contrast



abdominal CT with contrast



abdominal CT with contrast



Large saccular aneurysm of the left common iliac artery with a maximum diameter of approximately 80 mm

P-0309

A case of post-infectious irritable bowel syndrome in a young patient

Bruno Reis¹, Vitor Lopes¹, Gulsara Balabayeva¹, Cláudia Basto², Miguel Cancela²

¹UCSP Montemor-o-Velho

²USF Araceti

A case of post-infectious irritable bowel syndrome in a young patient

Background

Irritable bowel syndrome is a common gastrointestinal disorder, within the large group of people affected, there is a small subgroup whose symptoms begin suddenly after what appears to be gastroenteritis and is termed post-infectious irritable bowel syndrome.

Both host and pathogen related factors, such as pre-existing psychological disorders and duration of initial infection, have been associated with an increased risk for the development this pathology. Clinical management of this condition encompasses dietary, lifestyle advice and pharmacological therapy.

Aim

Increase the knowledge of family doctors about post-infectious irritable bowel syndrome.

Method

Clinical case presentation.

Results

The subject is a 26 year old male, works as a dentist and has no relevant medical antecedents and as surgical antecedents he was submitted to an appendectomy.

He recurred twice to emergency department in June 2014 with the complaints of nausea and vomiting for more than 20 days, the blood test was normal and he was diagnosed with gastroenteritis and was medicated with Metoclopramide and discharged.

Despite this medication he recurred to the hospital in August 2014 maintaining complaints of nausea, generalised and recurrent abdominal discomfort, urgency and frequent bowel movements with less consistent stool. He was then referred to a specialized gastroenterology consultation for further study. The stool and blood exams, endoscopy with biopsies were negative. He was then medicated with Alprazolam SOS and Domperidone SOS and referred to his family doctor for treatment maintenance and following.

Conclusions

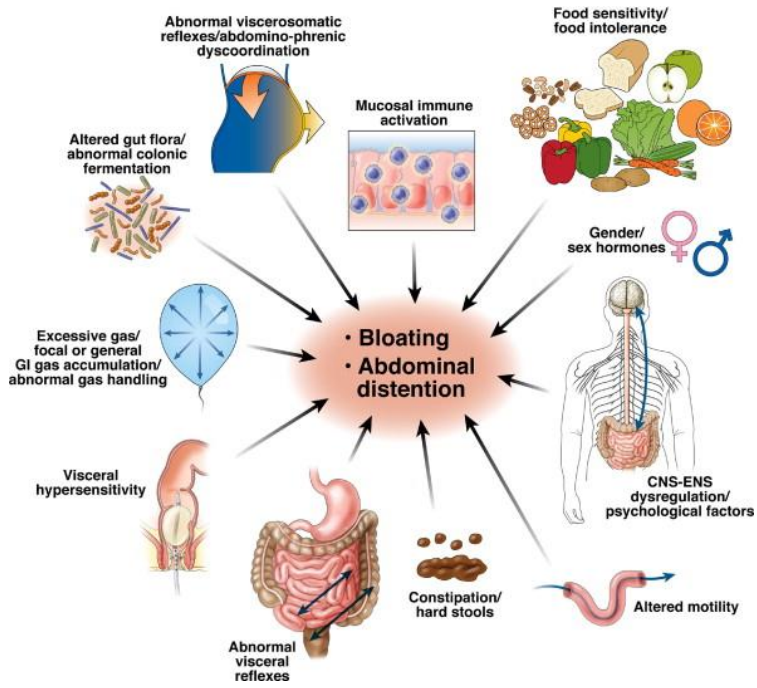
The family doctor has a major role in the treatment of people with irritable bowel syndrome. The patients should be given information that explains the importance of self-help in effectively managing their condition, which includes information on general lifestyle, physical activity, diet and symptom targeted medication.

Keywords: post-infectious, irritable bowel syndrome, young patient, family doctor

Patient with Irritable Bowel Syndrome



Irritable Bowel Factors



P-0310

CHRONIC PAIN OR DEPRESSION? After all it was a Neurinoma. A case-report

Maria Manuela Bernardo, Mariana Gayo, Ana Beatriz Figueiredo, Ana Magalhães

USF das Conchas, Lisbon, Portugal

BACKGROUND: Depression is the most common psychiatric illness in Primary Health Care and almost two-thirds of patients present somatic symptoms such as chronic pain. To diagnose depression, the General Practicer (GP) has to distinguish somatization from an organic cause of pain.

Neurinoma is a slow-growth, benign tumor of CNS, which affects patients mainly between the third and sixth decades, that can mimic an osteoarticular pain and it is very often incidentally diagnosed.

CASE PRESENTATION: A 46 year old woman with a diagnosis of major depression since she was 20, also followed in Psychiatric, and history of suicide attempted. The patient had a history of cervical pain since 2012 affecting both upper limbs, associated with decreased muscle strength and bilateral paresthesias. Meanwhile, she was medicated with analgesic therapy and long-term physiotherapy without significant improvement.

After multiple visits to the doctor, a CT-scan was performed in 2014, which showed a mass of unknown etiology located between C3-C4. The patient was referred to Neurosurgery for further investigation, and the final conclusion was a cervical neurinoma presenting with spinal cord compression that could justify her symptoms. Months later, the patient was submitted to surgical excision of the tumor and she began a slow recovery with symptoms improvement. Her depressed mood also improved considerably.

COMMENT: Due to the complexity of clinical manifestations of depression, the diagnosis of other important pain causes can be challenging on these patients. We intend to draw your attention to the importance of clinical history and physical examination when consulting since the role of the GP is to provide adequate clinical and imagiologic investigation to all patients keeping in mind less frequent diagnoses such as neurinoma, that often go unnoticed causing distress to the patient.

Keywords: Neurinoma, Depression, cervical pain, upper limbs paresthesias

Case Report

Identification	Health Problems (ICPC-2)	Medication
<ul style="list-style-type: none">• Gender: Female• Age: 47 years old• Marital status: Divorced• Job: Domestic• Duvall cycle: VI stage	<ul style="list-style-type: none">• Major depression (P76)• Urticaria (S98)• Active smoker (P17) of 40 A	<ul style="list-style-type: none">• Quetiapine 50 mg id• Bromazepam 6 mg id• Fluoxetine 20 mg id

References

Nutt DJ, et al. International consensus statement on major depressive disorder. J Clin Psychiatry. 2010;71 Suppl E1-w06 ; Ito K, et al. Surgical Strategies for Cervical Spinal Neurinomas. Neurol Med Chir (Tokyo). 2015 Jul 15;55(7):557-63.; eh KT , et al. Surgical outcome of spinal neurilemmomas: two case reports. Medicine (Baltimore). 2015 Feb;94(5):e490.; Patrick D. Wall, et al. Ongoing activity in peripheral nerves: The physiology and pharmacology of impulses originating from a neuroma. Experimental Neurology. Vol 43, Issue 3, Jun 1974. Pages 580-593.

Case Report

	Case Report
1989	S: Divorce; Major depression and suicide attempted P: Hospital - Psychiatry
12/12	S: Cervical and lombar pain P: NSAIDs e physiotherapy
04/14	S: Persistent cervical pain with decreased muscle strength and upper limb paresthesias; Right lateral epicondylitis; Rash allergy to NSAIDs P: Physiotherapy , treatment with tramadol associated with paracetamol and cervical CT-scan
09/14	O: Cervical CT-scan— C3- C4 mass lateralized to the right P: Hospital - Neurosurgery
11/14	S: Persistent cervical pain and epicondylitis. STOPS physiotherapy until diagnostic clarification. P: Tramadol; Hospital - Orthopedics
12/14	S: Neurosurgery: cervical MRN; Economic insufficiency to maintain physiotherapy and pain medication; P: Smoking cessation program; Hospital - Psychiatry
01/15	O: Cervical MRN – Cervical Neurinoma P: Surgery to remove Neurinoma
02/15	S: : After surgery began transitory headache and insomnia P: Rest and immobilization with cervical collarS

P-0311

Bilateral Optic Neuritis as the initial manifestation of Sarcoidosis: A Case Report

Sara Nieto Sánchez¹, Irene Pérez González¹, Yolanda González Silva⁴, Carmen Fernández², Claudia Bujedo Ortiz¹, Eva Sierra Quintana¹, Susana Sánchez Ramón³, Beatriz Martín Pérez³, Juan Carlos Sánchez Rodríguez³, Virginia Carbajosa Rodríguez³, André Duque Chau³, Sandra Calvo Sardón⁵, Sandra Casado De Andrés¹

¹Primary Care, Centro de salud Casa del Barco, Valladolid, Spain

²Gerencia Regional de Salud, Valladolid, Spain

³Emergency Department, Hospital Universitario Río Hortega, Valladolid, Spain

⁴Primary Care, Centro de Salud Plaza del Ejército, Valladolid, Spain

⁵Primary Care, Centro de Salud Parquesol, Valladolid, Spain

Sarcoidosis is an inflammatory disease characterized by non-caseating granulomas that can be present in diverse organ system. We report a case of sarcoidosis with bilateral optic neuritis as the initial manifestation.

A 31-year-old caucasian woman was seen in the emergency ophthalmology department because of bilateral sudden vision loss. She also had a cold with runny nose, fever and malaise.

Full physical examination was not pathological; laboratory testing showed leukopenia, without anemia or thrombocytopenia; negative tuberculin skin test; posteroanterior chest radiography with the presence of bilateral hilar adenopathy, and right paratracheal node enlargement.

The eyes examination included the following elements: general inspection (no erythema, no tearing, no proptosis, no ptosis, but light sensitivity), visual acuity (which was decreased, 0.1 for the right eye and 0.2 for the left eye), evaluation of the extraocular movement (which was right), confrontation visual fields, pupils (were symmetrical, reactive to light, pupillary reflex preserved), fluorescein test negative, intraocular pressure in both eyes was 12, slit lamp exam (with examination for red-reflex symmetry), ophthalmoscopic examination (minimum papillitis with hyperemia and swelling of the disc, blurring of disc margins, and distended veins).

The patient was admitted, and the study was completed with nuclear magnetic resonance, and Gallium-67 scintigraphy (showing a pattern of diffuse uptake). Transbronchial biopsy and histopathology examination were performed to confirm the diagnosis: the presence of granuloma was confirmed (a focal, chronic inflammatory reaction formed by the accumulation of epithelial cells, monocytes, lymphocytes, macrophages, and fibroblasts). The patient began taking glucocorticoids and her visual acuity was recovered. She was discharged 4 days after admission, has done well after discharge from the hospital and is without any known sequelae.

Keywords: Sarcoidosis, Optic Neuritis, Non-caseating granuloma

Chest Radiography



P-0312

Investigating the seasonal trend of stroke frequency in a rural area

Constantinos Mihas¹, Andreas Katrapas¹, Aikaterini Mpahara¹, Maria Rifouna², Eleni Petropoulou², Panagiotis Andriopoulos², Anargiros Mariolis²

¹Health Centre of Areopolis, Mani, Greece

²General Hospital-Health Centre of Kimi, Evia, Greece

Background & AIM: The seasonality in the appearance of strokes has been discussed in the international literature and the results are not considered absolutely clear taking into account the small number of relevant publications. The purpose of this study was to investigate the trend in the frequency of strokes, using data coming from a rural area in the second larger island of Greece, Evia.

METHOD: For the purpose of analysis, the data used were pooled from the admission records in the General Practice/Internal Medicine Department of the local public hospital-health centre from 1/9/2011 to 08/31/2014.

This hospital is the only primary and secondary health care provider, serving a population of approximately 10,000 residents of eastern Evia. The incidents were classified as stroke, regardless of their pathology (ischemic or bleeding) or if they were transient or not. Statistical analysis included the Mann-Kendall and seasonal Mann-Kendall statistics. Statistical package R v.3.1.1. © The R Foundation for Statistical Computing was used.

RESULTS: The overall relative frequency of strokes was 9.2%. According to the results of the analysis, no time trend was observed when the data were grouped by day of week or year (Kendall's tau: -0,195, -0,401, p-value: 0,649, 0,092, respectively). There was however a significant trend when the data were grouped by month of admission weighting for seasonality (Seasonal Mann-Kendall test, Kendall's tau: -0,636, p: 0,001)

CONCLUSIONS: These initial results suggest a time trend in the frequency of strokes at least in this sample, forming the basis for correlation with environmental factors in the future in order to further illustrate their frequency pattern.

Keywords: stroke, rural, trend

P-0313

Doctor, I have a bad taste in my mouth for several months

João Rocha Moutinho, Diana Almeida Ferreira

Unidade de Cuidados de Saúde Personalizados da Mealhada

INTRODUCTION: Mouth cancer is one of several types of cancer grouped in a category called head and neck cancers. Oral cancer consistently ranks as one of the top ten cancers worldwide, with broad differences in geographic distribution. They represent approximately 5% of cancers in men and 2% in women. Some factors that can increase the risk of mouth cancer include tobacco use of any kind, heavy alcohol use and papillomavirus. More than 90-95% of oral cancers are squamous cell carcinoma or one of its variants. They typically presents as a persistent mass, nodule, or indurate ulcer. The three most common sites of involvement are tongue, lip and floor of the mouth.

CASE: ♂, 69 years old, caucasian, retired, belonging to a family in phase VIII of Duvall cycle. Presents hypertension and dyslipidemia, treated with simvastatin 40 mg and with valsartan 160mg + hydrochlorothiazide 12.5 mg. Smokes 20 cigarettes per day since he was 25 years old. One day consulted his family doctor because a bad taste in the mouth for the last couple of months. His medical inspection showed a voluminous tumefaction under the right jaw. The computed tomography of the salivary glands showed "on the anterior pole of the right submaxillary gland one nodule with 34x31.7mm compatible with a right submandibular gland tumor". He was sent to a Hospital, to be consulted for maxillofacial surgery with the final diagnosis a squamous cell carcinoma on the right paving of the floor of the mouth. The surgery consisted on a median mandibulotomy, right hemipelvectomy, ventral glossectomy and extensive cutaneous reconstruction. One year before surgery the patient is functionally fully recovered, with an annual consult in maxillofacial surgery.

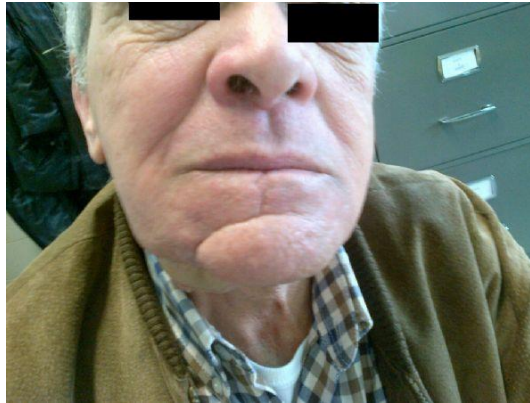
This case illustrates that oral cancer is sometimes asymptomatic initially, so oral screening is useful for early diagnosis on high risk patients.

Keywords: Submandibular Gland Neoplasms, Mouth Neoplasms, Glossectomy

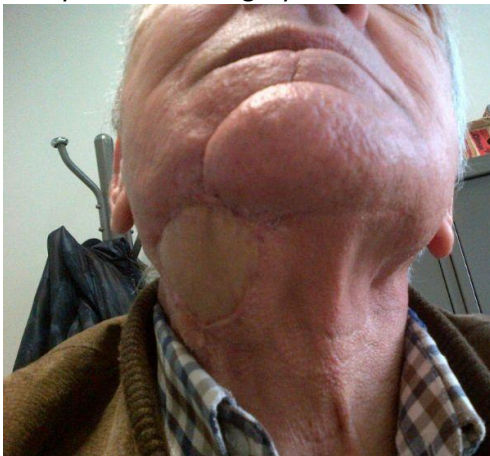
One year before surgery



One year before surgery II



One year before surgery III



P-0314

When investigating back pain

David Tomaz Rodrigues¹, Marta Lopes¹, Susana Grilo Loureço¹, Nídia Nunes¹, Teresa Pereira Leite²

¹USF Planície, ARS Alentejo, Évora, Portugal

²USF Alcáides, ARS Alentejo, Montemor-O-Novo, Portugal

Introduction

Low back pain is a very common cause in a family medicine consultation. It often become disabling, requiring analgesic treatment and complementary diagnostic procedures for etiological investigation.

Case description

Patient male, 50 years old, Caucasian, metallurgical, inserted into nuclear family in the phase VI of Duvall Cycle. Previous history of hypertension, dyslipidaemia, inguinal hernia and carpal tunnel surgeries.

On 2014, July 25th, he uses to open consultation for left low back pain, with a mechanical rhythm, over 10 days of evolution, there's no history of trauma. It was medicated with naproxen, esomeprazole and thicolchicoside.

In the next six days, he uses for two more times the open consultation with left back pain, with more intensity at morning, accompanied by left upper quadrant pain. Physical examination always unchanged. Complementary examinations were applied and he was referenced to the emergency service (ES). In the ES has been described a pain in the left rib cage and it was detected an anaemia of 12g/dl of haemoglobin. He was treated with diclofenac and acetaminophen.

He returned to consultation on August 20th, 2014, keeping complaints, with the result of complementary examinations, with anaemia (Hb - 12.1g/dL); high sedimentation rate (121); Total protein 9.1 and globulin 41.2. It were requested immunoglobulins (A / G / M); Beta2-microglobulin, Rx chest and lumbar spine CT, associating Metamizol and thicolchicoside the proposed therapy.

No improvement appealed to the US having been admitted to etiological investigation and was diagnosed multiple myeloma after viewing lytic lesions of ribs and vertebrae lumbar L1 and 3.3% plasma cells of medullary

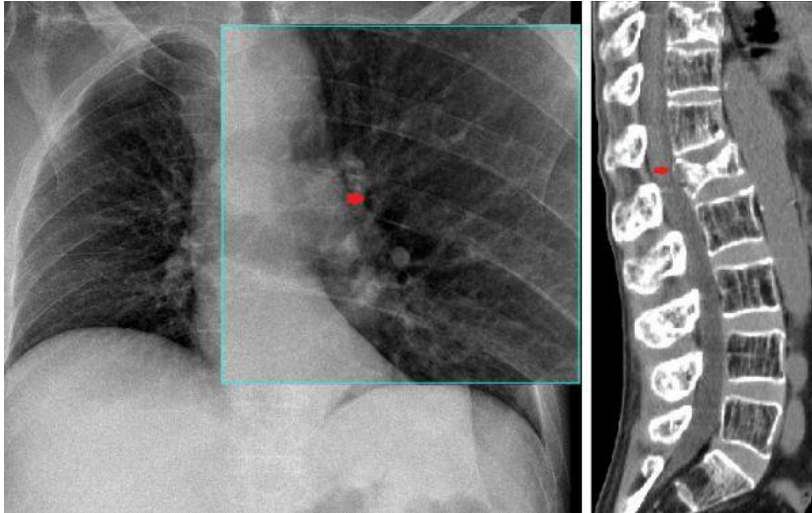
blood during hospitalization. He died after 5 months.

Discussion

Although there is often a range of low back pain causes, the family physician must be aware of diagnostic hypothesis, the seriousness require timely and targeted intervention.

Keywords: low back pain; multiple myeloma

Lytic lesions of the ribs (X-ray) and Fracture of the lumbar vertebra (TC)



P-0315

Paraneoplastic thromboembolism in lung cancer patient

Marija Marjan Zaric, Bojan Zoran Pavkovic, Marina Slobodan Brankovic
Department of general practice, Health Center "Dr Simo Milosevic", Belgrade, Serbia

CASE:

A 63-year old female, without comorbidities, smoker for over 40 years, presented to GP with weak cough, haemoptysis and sudden onset of life-threatening dyspnea.

Patient was hospitalized through the emergency department in the regional oncology center.

MSCT pneumoangiography showed thrombotic masses in main arteries of lower right and left lobes of the lung, and their segment and subsegment branches. Anticoagulant therapy for pulmonary embolism was administered and treatment was followed by quick improvement of general condition.

CT scan: tumor in the left lung with metastases in right lung, with enlarged paraaortic lymph nodes.

Bronchoscopy: adenocarcinoma of the lung.

Due to thrombosis of the main arteries of lower lobes, patient was initially treated with anticoagulant therapy (Nadroparin, then Acenocoumarol), and after stabilization of thrombotic masses, chemotherapy was started.

Fifteen days after 4th chemo cycle, patient came to GP because of deterioration of general condition, fever up to 39.4°C and dyspnea. Laboratory results showed presence of infection and elevated D-dimer: 2933ng/ml. Patient was hospitalized.

Chest X-ray: shadow of soft tissue consistency in the middle region of left lung with left hilar enlargement.

CT scan showed decreased size of tumor mass, but also pneumonic infiltration of the laterobasal and posterior regions of left lung. The patient was treated for bronchopneumonia with pulmonary re-thrombosis, and after antibiotic and intensified anticoagulant therapy (Acenocoumarol was replaced with Nadroparin), general condition and symptoms was improved.

Doppler ultrasound showed some old organized thromb in pelvic vessels, and revealed new thrombosis of deep veins of right arm, and both legs from the position of bifurcation of iliac vein.

Two months afterwards CT scans of the lung and brain were done – brain metastases were confirmed, and also worsening of pulmonary thromboembolism. Palliative irradiation of brain is in progress.

Keywords: lung cancer, paraneoplastic thromboembolism, anticoagulant therapy

P-0316

Cold Urticaria: Report of A Case

Duygu Ayhan Başer¹, Serdar Başer², Elçin Katı³, Aybuke Demir³, Zeynep Sayın Dinçer³, Gökhan Dinçer⁴

¹department of family medicine, Kocaeli Derince Public Health Center, Kocaeli, Turkey

²department of ear nose throat diseases, Derince Training and Research Hospital, Kocaeli, Turkey

³department of family medicine, Ankara Numune Training and Research Hospital, Ankara, Turkey

⁴department of family medicine, Ankara Training and Research Hospital, Ankara, Turkey

INTRODUCTION: Cold urticaria is a skin reaction to cold which is subtype of physical urticaria. The severity of cold urticaria symptoms varies widely; some people have minor reactions to cold, while others have severe reactions. Swimming in cold water is the most common cause of a whole-body (systemic) reaction. Its diagnosis, mainly clinical, is based on the clinical history of urticariform exanthema and/or angioedema after skin exposure to cold stimuli, confirmed by the “ice cube” test and by the exclusion of other diseases.

We emphasized the importance of the early diagnosis of this disease especially in primary care with this case.

Case Presentation: 14-year-old male patient was admitted in family medicine clinic with complaints of urticaria with dyspnea after exposure to cold sea water. He had a personal history of asthma and allergic rhinitis from the age of 3; controlled with inhaled corticosteroid, montelukast and salbutamol treatment in crises. He had a family history of asthma in his mother and sister. 4 years ago the patient presented generalized urticariform exanthema with dyspnea, pallor, nausea and dizziness, after cold sea water exposure. These symptoms disappeared spontaneously. A positive “ice cube” test (in the 3rd minute) and analytical tests with no relevant changes (except the presence of peripheral eosinophilia (1100/ μ L) and an increase in the IgE (310 KU/L)), led to the diagnosis of acquired idiopathic cold urticaria. It was recommended that she avoid exposure to cold and undergo pharmacologic treatment with a second generation antihistaminic.

CONCLUSION: Cold urticaria can be associated with severe systemic symptoms. The early diagnosis of this disease especially in primary care is very important in order to prevent potential lifethreatening situations.

Keywords: Cold Urticaria, Primary care, family physicians, physical urticaria

Figure 1



ice cube test

Figure 2



cold urticaria

Figure 3



DVT, clinical findings meet the guidelines

Luis Magalhaes, Sara Moreira, Gabriela Poças
USF Leça - ULS Matosinhos, Porto, Portugal

BACKGROUND: 33 year old man, caucasian.

Obesity, smoking history. Unknown allergies. No usual medication.

AIM: Reflection on the clinical practice aiming to improve health care's quality.

METHOD: Case report.

RESULTS: Patient attends physician with a sudden left calf swelling. Initially interpreted as superficial thrombophlebitis, was sent home with relief medication.

Two days later, he attends his family physician. He mentions no trauma history. The clinical findings included assymmetric edema, warmth, tenderness and a palpable, indurated, cordlike venous segment. Assuming deep vein thrombosis (DVT), the doctor referred him to the hospital, where an ultrasonography of the lower limb showed no signs of thrombosis. Five days after the initial presentation of the symptoms, the patient consults again with his family physician, whom after consulting the ultrasonography report, tranquilizes the patient prescribing compression socks and scheduling a new ultrasonography.

The next day, the patient was admitted at the hospital urgency with acute abdominal pain. While waiting for the initial workup he developed chest pain, shortage of breath and oxygen desaturation. Further exams revealed portal vein thrombosis and a massive pulmonary embolism.

CONCLUSIONS: Evidence-based literature supports the practice of determining a clinical pretest probability of DVT (eg. Wells). In patients with intermediate to high pretest probability of DVT, ultrasonography is recommended. If negative, the ultrasonography should be repeated within a week. Here, a pulmonary embolism occurred before the referred time. Distal DVT (infra-popliteal) are less likely to progress than proximal DVT's. In these cases, ultrasonography is more operator-dependent and less sensitive than proximal vein examination. Changing from a expert-oriented system to a guideline-oriented system allows a standardization of the health care provided, but may incur in failures in the recognition of individual differences between patients and between courses of disease. Therefore, the physician should look for an individualized approach to each patient.

Keywords: Deep vein thrombosis, Guidelines, Adverse event

Pretest probability for DVT

Low probability of DVT -2 - 0

Intermediate probability of DVT 1 – 2

High probability of DVT 3 - 9

WELL'S SCORE

CLINICAL FINDINGS	SCORE
Bedridden for more than 3 days or surgery within the last 4 weeks	+1
Tenderness along line of femoral or popliteal veins	+1
Entire limb swollen	+1
Calf more than 3cm bigger circumference	+1
Pitting edema, confined to symptomatic leg	+1
Dilated collateral superficial veins (non-varicose)	+1
Previously documented DVT	+1
Active cancer (including treatment up to 6 months previously)	+1
Paralysis, paresis, or recent plaster immobilization of lower limb	+1
Alternative diagnosis as more likely than DVT	-2

P-0318

When seizures are disguised

Mariana Almeida Pinto Moura Relvas, Margarida Pereira, Nina Monteiro, Maria Do Carmo Gonçalves
Unidade de Saúde Familiar PortoCentro, Porto, Portugal

BACKGROUND: An epileptic seizure is a clinical event presumed to result from an excessive neuronal discharge. Nearly 5-10% of the population will have at least one seizure. The clinical symptoms may include impaired consciousness and motor, sensory, autonomic, or psychic events. Patients with seizures may report a prodrome, including mood changes, sleep disturbances, lightheadedness, anxiety, irritability and difficulty concentrating. Automatism may also be present, as nonpurposeful, stereotyped, and repetitive behaviors. Due to the variety of clinical manifestations, misdiagnosis is common in a setting of primary care. There must be a high level of suspicion amongst general practitioners to ensure a correct diagnosis. **Clinical CASE:** Female, 61 years old, 6th grade, residing in Porto, house-wife, divorced. The patient is a smoker and has a history of dyspepsia, anxiety, COPD and edema of the larynx with dysphonia accompanied by an ENT. On the 3rd of September of 2013, the patient comes due to a feeling of throat obstruction with 1 month of evolution and aphonia. She was referred to the Hospital. On the 13th, the patient recurred again by dysphagia and fear of a thyroid condition. The ENT didn't detect a problem and she left with advice for vocal rest and a benzodiazepine. On the 4th of October, she returned with an intense feeling of throat obstruction, dyspnea and dysphagia. Because of the anxious component of the patient, she was given a benzodiazepine with improvement. An Endoscopy was requested. On the 23rd of November, the patient went to the ER due to lipothymia and CET. She was observed by a Neurologist and diagnosed with vascular epilepsy. She medicated with Lamotrigine and clopidogrel. On the 20th of December we observed the patient and the symptoms had stopped. **DISCUSSION:** This case focuses on the importance of a patient centered approach, characteristic of Family Medicine. It demonstrates the need for the general practitioner to be aware of less frequent pathologies, in order to conduct a good differential diagnosis.

Keywords: seizure, automatism, epilepsy

P-0319

Statins and Sun: a bad relationship - a case report

Diana Vaz De Miranda¹, Cátia Pereira Da Silva², Ana Sofia Alves¹, Olga Pereira³

¹Unidade de Saúde Familiar S. Nicolau, Guimarães, Portugal

²Unidade de Saúde Familiar Aqueae Flaviae, Chaves, Portugal

³Department of Dermatology, Centro Hospitalar do Alto Ave, Guimarães, Portugal

Background & AIM: Drug-induced photosensitivity is determined by the capacity of some medications to modify an individual's sensitivity to solar radiation or artificial light and present clinically as dermatoses in the exposed areas. Photosensitivity reactions may result from commonly used systemic medications but because of their rarity, they are often clinically neglected. With this report the authors intend to describe a case of photosensitivity reaction to statins.

METHODS: Data were gathered from clinical records using the electronic medical record system SClinic®.

RESULTS: A 39-year-old male was sent by his Family Doctor to the Dermatology Department due to a non pruriginous facial erythema, with escalation in the last 6 months. The patient had a personal history of Psoriasis since he was 16 years-old, treated with topic medication. About a year ago, in a routine appointment, he was diagnosed with Hyperlipidemia, Hypertension and Hyperuricemia and medicated with Symvastatin 20mg id, Lisinopril 5mg id, Allopurinol 100mg id. Physical examination showed a violaceous erythema of the exposed areas of head and neck, drawing the neckline and also a descamative erythema of the back of the hands and wrist. The characteristics and distribution of these lesions are compatible with a photosensitive reaction. After a rigorous anamnesis and therapeutical review, the most likely diagnostic hypothesis was Drug-induced Photosensitivity by Symvastatin. The anti-lipidemic was suspended and a sunscreen with a sun protection factor of 50+ was prescribed, with gradual clinical improvement.

CONCLUSIONS:

When dealing with a skin photosensitivity reaction, it is important to know the most commonly implicated drugs.

Diagnosis of photosensitivity due to statins requires a high degree of suspicion but since these are one of the most worldwide prescribed drugs, clinicians should be aware of this side effect.

Keywords: Drug-induced photosensitivity, Statins, Dermatology

Erythema of sun-exposed areas (Back)



Erythema of the exposed areas of the neck.

Erythema of sun-exposed areas (Front)



Erythema of the exposed areas of head and neck, drawing the neckline.

P-0320

Urinary tract schistosomiasis: a case report

Ana Sofia Alves, Diana Vaz De Miranda, Carla Costa, Francisca Caetano, Cláudia Teixeira, Luísa Pinto
Unidade de Saúde Familiar S. Nicolau, Guimarães, Portugal

BACKGROUND: Urinary schistosomiasis caused by *Schistosoma haematobium* worms is endemic to tropical regions where it is the most common cause of hematuria. However, the intermediate snail hosts *Bulinus truncatus*, have been described in Portugal, Spain, Sardinia and Corsica. It can induce lesions in the urinary and genital tract epithelia, as eggs pass through or get trapped in the tissue. With this report the authors intend to describe a case of *S. haematobium* infection occurring in an otherwise asymptomatic woman.

METHODS: Data were gathered from clinical records using the electronic medical record system SAM®.

RESULTS: A 51-year-old woman with hypertension and dyslipidemia showed a *S. haematobium* infection in a routine urine sediment. Microscopic examination of the urine revealed the presence of red blood cells and showed live and dead ova of the parasite. She was afebrile and had no urinary symptoms. Complete blood count was normal without eosinophilia. She reported not having traveled outside Portugal. No *S. haematobium* eggs were found in the urine of the other family members. Because of the recognised risk of urogenital complications the patient was therefore referred to the Urology department for further investigation.

CONCLUSIONS: Urinary schistosomiasis is not endemic in Europe, although sporadic cases have been described. Most individuals with schistosomiasis infection are asymptomatic and have a low parasite burden, but severe damage of urinary tract organs can occur. Since the competent intermediate host is established in Portugal, this entity should be considered as differential diagnosis, especially in patients presenting with hematuria.

Key-words: *Schistosoma haematobium*, urinary tract, asymptomatic haematuria

Keywords: *Schistosoma haematobium*, urinary tract, asymptomatic haematuria

Schistosoma haematobium



P-0321

Rare complications of acute otitis media in an elderly woman: report of a case

Duygu Ayhan Başer¹, Serdar Başer², Elçin Katı³, Meltem Koç⁴, Hilal Aksoy⁵, Rabia Kahveci³, Adem Özkara³

¹department of family medicine, Kocaeli Derince Public Health Center, Kocaeli, Turkey

²department of ear nose throat diseases, Derince Training and Research Hospital, Kocaeli, Turkey

³department of family medicine, Ankara Numune Training and Research Hospital, Ankara, Turkey

⁴department of family medicine, Mamak Public Health Center, Ankara, Turkey

⁵department of family medicine, Etimesgut Cancer Early Diagnosis, Screening and Education Center, Ankara, Turkey

Introduction

Acute otitis media (AOM) is defined as an inflammatory process of the middle ear associated with an effusion. AOM is a frequent condition seen in primary care. It often appears with otalgia, fever and headache after an upper respiratory infection. Serious complications such as mastoiditis, meningitis are rare but can be life-threatening.

Case report

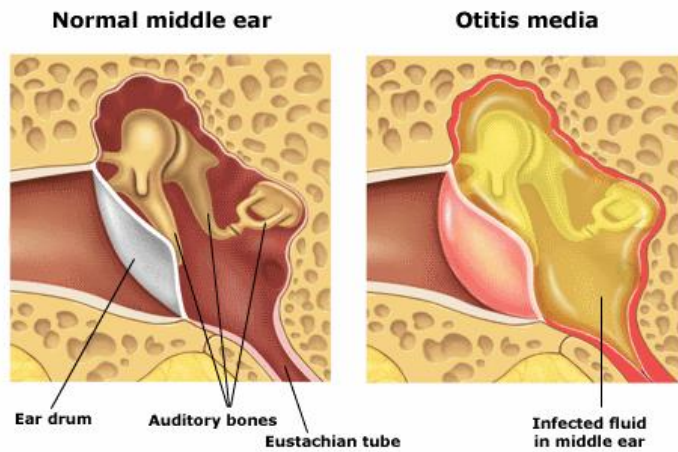
A 85 year-old woman with hypertension, type 2 diabetes mellitus, was admitted in family medicine clinic with complaints with left for 5 days. Physical examination led to a diagnosis of AOM, a treatment with amoxicillin 1000 mg/ clavulanate 125 mg every 8 hours was prescribed. 1 day later, the patient developed antibiotic intolerance, for this reason the antibiotic was changed to cephalosporin and oral corticosteroids were given. 2 days later due to deterioration, the patient was sent to the ear nose throat clinic. A cranial CT scan revealed a bilateral AOM, bilateral otomastoiditis and left maxillary sinusitis. She was admitted to the hospital and broad-spectrum intravenous antibiotics were given. After 3 weeks, she was discharged with wellness.

Conclusion

Elderly people especially diabetics are at a higher risk of developing complications of AOM. A comprehensive physical examination and follow up are very important in primary care to prevent or early detect the complications.

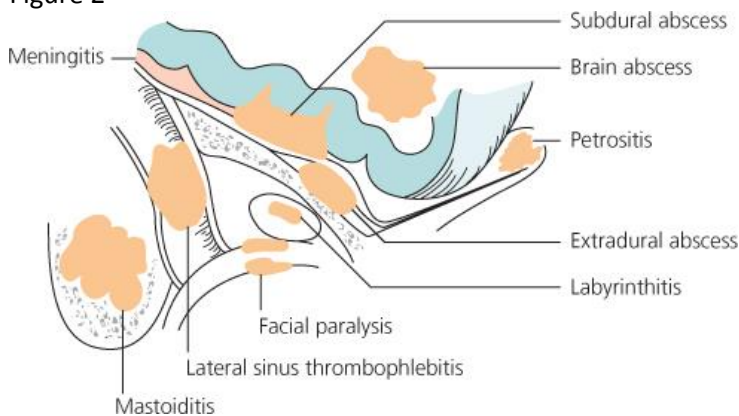
Keywords: ,acute otitis media, elderly, primary care, mastoiditis

Figure 1



acute otitis media

Figure 2



acute otitis media complications

Table 1

Infra-temporal infections	Intracranial infections
Tympanic membrane perforation.	Meningitis.
Mastoiditis.	Encephalitis.
Facial nerve palsy.	Brain abscess.
Acute labyrinthitis.	Otitic hydrocephalus (hydrocephalus associated with AOM, usually accompanied by lateral sinus thrombosis but the exact pathophysiology is unclear).
Petrositis.	Subarachnoid abscess.
Acute necrotic otitis.	Subdural abscess.
Chronic otitis media.	Sigmoid sinus thrombosis.
AOM complications-infra-temporal and intracranial infections	

P-0322

Case of Bonzai Intoks Tracking and Management in The Emergency Department

Nadiye Karabulut¹, Sündüs Görükmez¹, Seçil Günher Arıca¹, Selman Yeniocak²

¹Haseki Eğitim ve Araştırma Hastanesi, Aile Hekimliği Kliniği, İstanbul

²Haseki Eğitim ve Araştırma Hastanesi Acil Servis Kliniği, İstanbul

Background and AIM:

Synthetic kannabioids (SK) have psychoactive effects similar with cannabis. Overall abroad "Spice," "K2", while in Turkey "Bonzai" or "Jamaica" is released. In this study is aimed to determine common symptoms, clinical findings and lab results in cases of bonzai intox.

METHOD: Bonzai intoks 61 cases that brought to Haseki Training and Research Hospital Emergency service between the months of November to August of 2014 were analyzed retrospectively. The case of age ranging between 15 to 53, were found to be the most common range of 20-25 years old (70%). Arrival Glasgow coma scale (GCS): in 88.4% (n = 54) 8 points (E2, V2, M4), in 10% (n = 6) 9 points (E2, V2, M5), 1.6% (n = 1) in the 4 points (E1, V1, M2) were evaluated. The Pupil reflexes in 90% (n = 52) fixdilate, in 10% (n = 9) were normal. Venous blood glucose average of 120 ± 29 mg / dl and were hyperglycemic. The average blood gas pH was found to be 7.35 ± 0.07 . In all cases, EKG, Troponin-I coagulation, Kidney, liver function tests and blood electrolyte levels were normal. A case was intubated. All patients were followed closely for at least 24 hours and was given support treatment. After the treatment; GCS 15 points (E4, V5, M6) were evaluated in all cases.

Results and DISCUSSION:

SK type and quantity of the substances, frequency and use of personal susceptibility may cause to toxicity and can affect all systems of the body. All patients were followed closely for at least 24 hours, was given to the support treatment and was discharged uneventfully. Bonzai intoxication can lead to death. So should be kept in mind that the person who brought the change of consciousness especially young people may have used these substances.

Keywords: Bonzai, emergency, loss of consciousness, spice

bonzai agent



Bonzai intox Case



P-0323

Male with progressive dysphagia

Nuria Luquin Ciuró¹, Rafael Luquin Martínez², Alfonso Piñana López², José Miguel Bueno Ortiz³, Concepción Alonso García², Encarnación Ros Martínez², Beatriz Guerrero Díaz², Jesús Fernández Lorenzo²

¹Hospital General University of Santa Lucía. Cartagena (Murcia Health Service-SMS).

²Health Center West-Cartagena. (SMS).

³Health Center Fuente-Álamo. (SMS).

Background & AIM: A 73-year-old with a history of hypercholesterolemia; Allergic rhinitis; Right inguinal hernia repair; Venous insufficiency of lower extremities with thrombophlebitis left leg 10 months ago; Colonic Diverticulosis (2 episodes of diverticulitis) and excised colon tubular adenoma 1 year featuring progressive dysphagia to solids liquid two months lost about 6 kgs ago. weight, aerophagia and dyspepsia. In the last 15 days has added difficulty to swallow any liquid. Given its status, the goal is to process diagnostics for the most appropriate treatment.

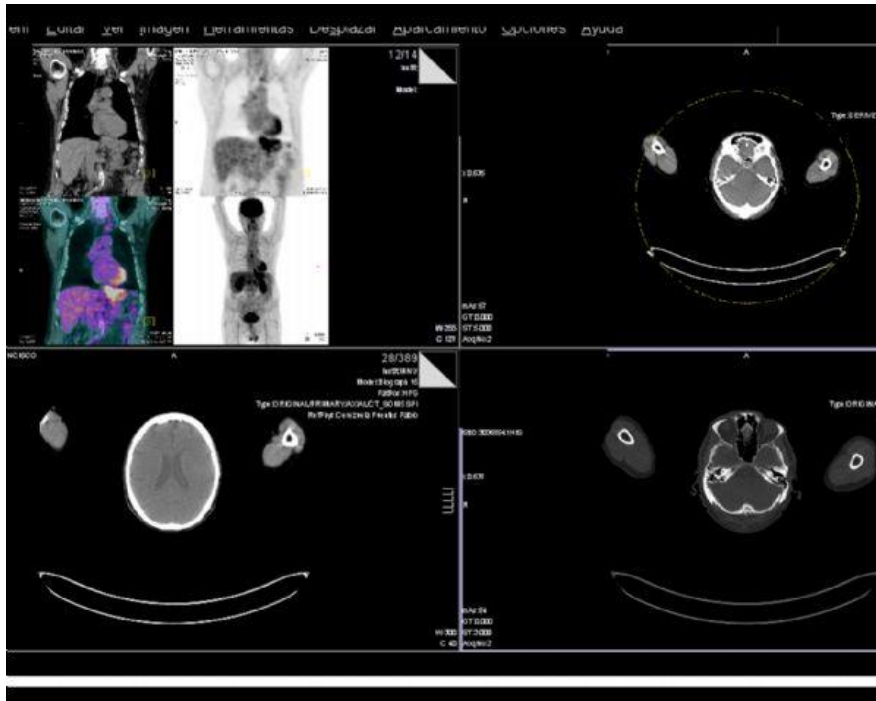
METHOD: Exploration-Physics: Conscious and oriented. Good general condition with good nutrition and hydration. Constants normal clinics. Head, neck, trunk, abdomen and extremities without pathological findings. Exploration-Complementary: Analysis-Blood: Within normal limits. Esophagogastroscopy: Presents in distal third of the esophagus one papillary and friable mass to the passage of the endoscope hard consistency occupying the entire circumference and stenotic orifice thready light with a length of 4 cm. extending to Cardia. Stomach and duodenum without notable injuries. TAC-thoraco-abdominal: Chest unchanged. Ground level gastro-esophageal junction 60 mm with infiltration of the lesser curvature of the upper stomach with lymphadenopathy in celiac trunk. Remaining unchanged.

RESULTS: Anatomy-Pathology: poorly differentiated adenocarcinoma infiltrating. Her2 negative (1+) stenosing at the gastroesophageal junction at high risk of malnutrition. PET-CT: viable tumor tissue at the gastroesophageal junction and mediastinal lymph nodes (with metabolic increase) and left region retroclavicular discarded neoadjuvant combination treatment of chemotherapy and radiotherapy.

CONCLUSIONS: Given the patient's endoscopic gastrostomy (PEG) is performed for enteral nutrition and chemotherapy cycles as EOX scheme. We highlight the existence of these conditions the need for early diagnosis based on clinical history.

Keywords: Dysphagia. Esophageal Cancer. Gastrostomy.

THORAX-ABDOMINAL PET-TAC



PET-CT: viable tumor tissue at the gastroesophageal junction and mediastinal lymph nodes (with metabolic increase) and left region retroclavicular discarded neoadjuvant combination treatment of chemotherapy and radiotherapy.

P-0324

ANCA MPO Vasculitis: a long diagnostic journey

Nuno Guerra, Joana Almeida

Health Unity Camélias, Health Center Porto VII

Background - Microscopic polyangiitis (MPA) is a small-vessel necrotizing vasculitis with involvement of the glomerular and pulmonary capillaries. It represents a diagnostic challenge due to its nonspecific symptomatology and insidious evolution.

Objective – Report of a case of ANCA MPO vasculitis, highlighting the role of the general practitioner (GP) in the diagnosis and management of these diseases.

Description – 67 years old man with a personal history of chronic gastritis. He presented to his GP in an urgency consultation with a one-month clinical picture of dyspnea to small efforts, dry cough, abdominal discomfort and anorexia. Laboratorial exams were carried out, displaying a mild anemia (11,8 g/L), and a spirometry was performed, with a result compatible with asthma. Inhaled corticosteroids were started. One month later he returned due to maintenance of abdominal discomfort, although exhibiting improvement of the respiratory symptoms. A colonoscopic examination was awaiting scheduling at this time. Two months later an episode of haemoptysis motivated a visit to a private pulmonologist, with the patient undergoing a lung CT scan, with no pathological findings. Ten days later he was admitted to the Emergency Department exhibiting rectal bleeding, with colonoscopy revealing signs compatible with acute vasculitis. Severe anemia and acute renal failure were detected, with requirement of hemodialysis. Laboratorial examination revealed ANCA MPO positivity, and the diagnosis of ANCA MPO vasculitis with rapidly progressive acute renal failure was assumed. He was initially treated with high dose corticosteroids and cyclophosphamide, with clinical improvement but without renal function recovery, and is currently under maintenance therapy with oral corticosteroids and azathioprine, with follow-up by his GP and nephrologist.

DISCUSSION: Small vessels vasculitis are multisystemic disorders with nonspecific symptoms as manifestations, leading to a delay in the diagnosis. This case emphasizes the importance of GP awareness to these early and undifferentiated presentations.

Keywords: ANCA MPO Vasculitis

01/04/2014

Soap - Weakness/general tiredness, dyspnea to small efforts, dry cough, abdominal discomfort and anorexia with about 1 month of evolution

sOap - Physical Examination: Abdominal pain with deep palpation of left hypochondrial and epigastric region

soAp - Weakness/tiredness general

soaP - Laboratorial exams and spirometry

21/04/2014

Soap - Weakness/tiredness general. Maintain the abdominal symptoms. Exams results.

sOap – Physical Examination: overlap. Exams results: Anemia (11g/dl) and asthma with no other findings

soAp – Anemia + Asthma

soaP – Fluticasone (250 ug/dose) + Salmeterol (50 ug/dose) inhaled twice a day. Colonoscopy. Reevaluation in 3 months

16/05/2015

Soap – Abdominal pain with one month of evolution in the left lumbar and hypochondrial region

sOap – Physical Examination: Abdominal pain with deep palpation of left hypochondrial and epigastric. No defense

soAp – Weakness/tiredness general, Abdominal pain

soaP – Colonoscopy still waiting scheduling

July

An episode of haemoptysis motivated a visit to a private pneumologist. The CT Scan didn't show any pathological findings.

Some days later the patient phoned his Family Physician because he was having rectal bleeding. He was then advised to go to the hospital urgency. He was admitted in the emergency room presenting with rectal bleeding, and the emergency colonoscopy revealed signs of vasculitis. He was hospitalised with a severe anemia (7 Hb/g) and in acute renal failure, so he started hemodialysis. During the investigation the exams revealed ANCA and MPO positive values, suggesting a small vessels vasculitis ANCA and MPO positive, with rapidly progressive acute renal failure.

At this moment he is still on hemodialysis.

P-0325

Protocol of Clinical Action in Primary Attention Care of the Traumatism of the Elbow

Leticia Sierra Martinez¹, Iker Sierra Martinez², Rosario Martine Fuerte¹, Natalia Sanz Gonzalez³

¹Valladolid Este Primary Assistance Gerency, Castile and Leon Sacyl, Valladolid, Spain

²Traumatology Department, Hospital of Medina de Campo (Valladolid), Spain

³Parquesol Senior Center, JCYL Social Serices Gerency, Valladolid, Spain

Background

Centring the professionals of primary care on the managing of the Traumatism of the elbow

Methods: Develop a Protocol of Clinical Action in Primary Attention Care of the Traumatism of the elbow

RESULTS: So much the different accidents (of traffic, labor, fallen, etc.) as the sports practice they carry, in some occasions, injuries in the elbow Though many of them, specially the bony fractures or the affections you will articulate they need a hospitable treatment and a follow-up on the part of an orthopedic surgeon, it is necessary that the doctor of primary care knows the semiology of the most serious traumatic and frequent disease, as well as the different therapeutic options. In addition, often, the patient appeals his doctor of family in search of advice and information in reference to his recovery, sequels, etc., without forgetting the follow-up of the labor disability that often he accompanies on the injury. But, undoubtedly, it is in the injuries of soft parts where paper of the family doctor has a more important paper, not because it is traumatism in general serious, but because they are injuries that, if they are not solved adequately, can concern seriously the quality of life of the patient.

CONCLUSIONS: The authors propose this protocol with the intention of centring to the professionals of primary care on the managing of the traumatism of the elbow of major demand on the consultations, across "keys" or "keys" for his correct diagnostic suspicion, complementary necessary tests, signs of alarm of complications, initial attention, how and when to derive to the specialist, treatment of choice, time of immobilization and type of later rehabilitation, as well as the time foreseen of labor disability of his patients with traumatism in the anatomical area of the elbow

Keywords: Primary Attention Care; Traumatism of the elbow; Protocol of Clinical Action.

P-0326

Case report: PULMONARY EMBOLISM

Rümeysa Macit¹, Gökçen Külahlı¹, Semih Başçı², Abdulkadir Koçanoğlu², Zuhal Aydan Sağlam¹, Banu Mesçi²

¹Department of Family Medicine, Istanbul Medeniyet University

²Department of Internal Medicine, Istanbul Medeniyet University

INTRODUCTION:

Pulmonary embolism is a common and potentially lethal disease. In spite of advanced diagnostic techniques, diagnosis is often delayed. This paper aims to remind of the possibility of pulmonary embolism which is facilitated by oral contraceptives and postoperative immobilization.

CASE:

A 32-year-old female patient presenting with stomach pain, epigastric burning and cough for five days was prescribed for gastroesophageal reflux but was readmitted to the emergency service with additional palpitation and dyspnea. In her physical examination, she was pale: her BP was 90/50 mmHg and pulse rate was 95/min. Her respiratory system examination revealed normal. No pathology was observed in PA chest radiography and electrocardiogram. The only pathologic value was Hb: 9.9 g/dL; the other biochemical values were normal. According to her medical history, she had been using OC for three months and had a cosmetic breast operation 20 days ago. Her detailed history revealed that OC was not discontinued before and after operation. This information led us to further analysis as serum D-dimer and fibrinogen levels for preliminary diagnosis of pulmonary embolism which were recorded as >20 ng/ml and 508 mg/dL respectively. Echocardiography and thoracic CT angiography were both consistent with pulmonary embolism due to the thrombus on bilateral main pulmonary artery. There was no pathologic source of emboli in bilateral lower extremity venous Doppler ultrasound examination. Drugs used by the patient were discontinued and warfarin sodium was initiated. At the 14th day of admission she was discharged from the hospital with chest disease monitoring.

DISCUSSION: OC use may cause oncological and cardiovascular risks by affecting directly to blood vessel wall and hemostatic system. Long term immobilization may also cause embolism due to deep vein thrombosis. Pulmonary embolism is difficult to diagnose if it is not kept in mind for differential diagnosis in patients at risk. This case emphasizes the importance of getting detailed medical history when having elective or urgent surgical decisions.

Keywords: : PULMONARY EMBOLISM, OC

P-0327

D-Dimers, a strong negative predictive value and a strong positive treatment factor in acute situations with suspected pulmonary embolism?

Gerard Nguyen, Camille De Franceschi, Dominique Le Mout

Cabinet Marcel Monny Lobe, Soisy Sous Montmorency, France

Plasma D-Dimer measurement is commonly used as the first test in patients suspected of having acute pulmonary embolism (PE). Specificity is typically between 40% and 60%, leading to a high rate of false positive results.

Several factors are associated with positive D-Dimer results.

We reported 2 clinical cases as landmark and complex situations seen in primary care where D-Dimer measurements have been contributive for treatment decision in suspicion of PE.

Mrs J.P. 88 yo, having a pleural mesothelioma with chemotherapy abstention was treated by antibiotics for a common pulmonary bronchitis. One week after the recovery, she complained of a thoracic pain and a mild dyspnea without fever and an oxygen saturation of 92%. Blood analysis showed a normal white cells count, a CRP=118 mg/L and D-Dimers=3143 ng/mL. She refused to be hospitalised. Left pleural syndrome was persistent contra-indicating contributive thoracic imaging. Ambulatory treatment by subcutaneous Tinzaparin 10.000 UI daily for 1 month was undertaken. D-Dimers kinetic showed an important decrease during one month (2246 mg/mL at day 15 and 890 mg/mL at 1 month) and symptoms disappeared.

Mrs J.R. 87 yo had an isolated persistent nocturnal cough after 5 days of symptomatic treatment. She became dyspneic without fever and an oxygen saturation of 90%. Blood count was normal, CRP=1 mg/mL and D-

Dimers=3069 ng/mL. She refused to have thoracic imaging because she had to care her husband at home. She accepted to be treated at home with Tinzaparin 10.000 UI daily for one month. D-Dimers kinetic showed a significant decrease over one month D-Dimers=437 ng/mL at day 21 associated with clinical improvement. In conclusion, D-Dimers has a known strong negative predictive value, Increased values could be in some ambulatory situation of suspected PE and treatment decision marker and D- Dimers kinetic associated with clinical improvements could confirm afterwards the decision taken.

Keywords: D-Dimers, Pulmonary embolism,

P-0328

Guillain Barre' Syndrome in a patient with hepatopathy

Silvia Sánchez Casco, Pedro Alejandro Gonzales Flores

Catalan Health Institute, Barcelona. Spain

INTRODUCTION

Guillain-Barré' Syndrome is an autoimmune disorder without a clear trigger that affects nerve endings causing demyelination. It often occurs after one minor infection. Symptoms can be very serious. Existing treatments do not cure but they improve symptomatology, treat complications and accelerate recovery.

DESCRIPTION OF THE CASE

46 year old patient with pathological history of moderate alcoholism and smoking, since a month ago launches a distal paresthesias in the 4 extremities with progressive hypoesthesia of proximal to distal home accompanied by alteration of the march. Physical exploration: distal dominance with areflexia tetraparesis. Vibrating and painful hypoesthesia of distal dominance in all four extremities. Three traverses hepatomegaly. Rest of exploration without alterations Complementary explorations: analytical hemoglobin 9.2. Hematocrit 26.8%. VCM 93. Platelets 133. 53% quick index (v.n: 70-130). 1.48 (0.85-1.15) prothrombin time GGT 21. GGT 159. Direct coombs test is positive. Iron 24 (vn 50-170). Ferritin 23(vn 10-120). Cerebrospinal fluid (CSF): total protein 47 (vn: 15-45). Microbiology and stain Gram negative (CSF). Electrocardiogram: sinus, 80x', no alterations in repolarization rate. Electromyogram: Discrete alteration in the form of overall increase of normal F-wave with a peripheral sensory study and motor latencies. Liver Ultrasound: chronic liver disease without occupying lesions of space or ascites. Fibrogastroscopy: erosive antritis and esophageal varicos veins grade II. The patient was diagnosed by progressive clinic, physical and neuropsychological examination and discret protetinas increase in CSF of Guillain Barre ', while compatible with chronic liver disease findings not previously studied in patient with chronic enolico habit were detected during her hospitalization.

ACTION

Started treatment with immunoglobulins 20 g for 5 days which was well tolerated and rehabilitation treatment with good response, obtaining an independent ambulation. In turn iron ev was administrated and then oral and a treatment with beta-blockers was begun recommending absolute abstention from alcohol

Keywords: Guillain Barre' syndrome, patesthesia, hepatopathy

P-0329

When prevention is not enough

Joana Relva, Rui Caramelo, Manuel Sousa
Canelas Family Health Unit, Canelas, Portugal

Context:

Pulmonary embolism is a blockage in the pulmonary arterial territory. In most cases, pulmonary embolism is caused by blood clots that travel to the lungs from the legs or, rarely, other parts of the body (deep vein thrombosis). Although anyone can develop deep vein thrombosis and pulmonary embolism, factors such as immobility, cancer and surgery increase the risk. Pulmonary embolism can be life threatening, but prompt treatment can greatly reduce the risk of death. Taking measures to prevent blood clots will help protect against pulmonary embolism.

Case description:

DFC, 56 years, male, without pathological relevant past medical history. In December 23th 2014 (Day 1), he fell and fractured his left leg and had to be immobilized with a splint. For prevention of thromboembolism, was medicated with Low-Molecular-Weight Heparin (LMWH). Later, in December 31st (Day 8), he complained of malaise with vomiting and sudoresis. On Day 13, he started having posterior right thoracic pain with anterior irradiation, which worsened with deep inspiration, associated with dyspnea. On Day 17, while waiting for an orthopedic consultation, he felt intense chest pain, dyspnea, diaphoresis and fainting. In the ER, he was diagnosed with acute massive pulmonary embolism.

DISCUSSION:

It is well known that immobilization leads to local venous stasis by accumulation of clotting factors and fibrin, resulting in thrombus formation. The risk of pulmonary embolism increases with prolonged bed rest or immobilization of a limb with a cast. The use of LMWH is one of the ways to prevent pulmonary embolism but, as shown before, may not be enough. The recognition of signs and symptoms of thromboembolism is important to a prompt identification and treatment, even if primary prevention had taken place.

Keywords: prevention; immobilization; pulmonary embolism;

Case description

DFC, 56 years, male, without pathological relevant past medical history.

In December 23th 2014 (Day 1), he fell and fractured his left leg and had to be immobilized with a splint. For prevention of thromboembolism, was medicated with Low-Molecular-Weight Heparin (LMWH).

Later, in December 31st (Day 8), he complained of malaise with vomiting and sudoresis. On Day 13, he started having posterior right thoracic pain with anterior irradiation, which worsened with deep inspiration, associated with dyspnea. On Day 17, while waiting for an orthopedic consultation, he felt intense chest pain, dyspnea, diaphoresis and fainting. In the ER, he was diagnosed with acute massive pulmonary embolism.

P-0330

Incidence of adult Community Acquired Pneumonia in Primary Care in Spain (NEUMO-ES-RISK project)

Irene Rivero¹, Jacobo Pardo², Pablo Aldaz³, Diego Agustín Vargas⁴, Enrique Mascarós⁵, Esther Redondo⁶, Jose Luis Díaz⁷, Manuel Linares⁸, María José Fierro⁹, Ángel Gil¹⁰, Jesús Molina¹¹, Daniel Ocaña¹², Federico Martín Torres¹, On Behalf Of Neumoexpertos¹³

¹Translational Pediatrics and Infectious Diseases Section Pediatrics Department, Hospital Clínico Universitario de Santiago de Compostela, Santiago de Compostela, Spain

²Genetics Vaccines Infections and Pediatrics Research Group (GENVIP), Healthcare Research Institute of Santiago de Compostela, Santiago de Compostela, Spain

³Member of the preventive infectious disease group PAPPS-SEMFYC. Primary Health care Center San Juan. Pamplona. Spain

⁴Versatile unit hospitalization, Hospital for High Resolution El Toyo. Public Sanitary Agency. Hospital de Poniente. Almería. Spain

⁵Health Care Center Fuente de San Luís, Hospital Dr Peset Health Department Valencia, Spain

⁶Preventive and Public Health Activities Group SEMERGEN. International Health Center. Madrid. Spain

⁷Primary Care Health Center, Guadalajara, Spain

⁸Infectious Diseases Group SEMERGEN. Fundación io.

⁹Primary Care Health Center El Olivillo. Cádiz. Spain

¹⁰Professor of Preventive Medicine and Public Health at the Rey Juan Carlos University. Madrid. Spain

¹¹Primary Care Respiratory Group. Health Care Center Francia. Fuenlabrada. Madrid, Spain

¹²Primary Care Respiratory Group. Health Care Center Algeciras, Spain

¹³NEUMOEXPERTOS group is composed by: F. Martín-Torres; P. Aldaz, D. Vargas, E. Mascarós, E. Redondo, JL. Díaz Maroto, M. Linares, MJ Fierro, A. Gil, J. Molina, D. Ocaña

Background & AIM: Community-acquired pneumonia (CAP) is a major cause of morbidity and mortality in adults even in developed countries. The annual incidence of CAP in adults in Europe is between 1.07 and 1.2 per 1,000 person/year. The aim of this study is to assess the incidence of CAP in primary care adults in Spain.

METHOD: Retrospective observational study in adults (>18 years-old) with CAP diagnosed and attended at primary care in Spain between 2009-2013, using the National Surveillance System of Primary Care Data (BiFAP).

RESULTS: 28.413 patient records were retrieved and analysed. Global incidence of CAP in adults was estimated at 4.63 per 1000 persons/year. CAP incidence increased progressively with age, ranging from a 1.98 at 18-20 years of age to 23.74 in patients above 90 years of age. According to gender, global CAP incidence was slightly higher in males (5.04) than females (4.26): CAP incidence from 18 to 65 years-old up was comparable between males (range: 2.18-5.75) and females (range: 1.47-5.21), whereas from 65 years of age, CAP incidence was noticeable higher in males (range: 7.06-36.93) than in females (range: 5.43-19.62).

CONCLUSIONS: Annual incidence of adult CAP in primary care in Spain is higher than that reported for Europe. CAP incidence is comparable between males and females up to 65 years of age, but clearly increases in males from that age.

Keywords: Community acquired pneumonia, Incidence, Primary care

CAP INCIDENCE ACCORDING TO AGE AND SEX

CAP INCIDENCE ACCORDING TO AGE AND SEX

	Males				Females				Total			
	Cases	n	p-y	Rate	Cases	n	p-y	Rate	Cases	n	p-y	Rate
18 a 20	175	61333	70412,87	2,49	101	61303	68905,12	1,47	276	122636	139317,98	1,98
20 a 25	433	79410	196125,36	2,21	329	89087	204046,95	1,61	762	168497	400172,31	1,90
25 a 30	566	111187	260050,38	2,18	458	122885	275279,73	1,66	1024	234072	535330,11	1,91
30 a 35	818	134560	332654,60	2,46	796	140318	343610,41	2,32	1614	274878	676265,01	2,39
35 a 40	1070	123355	336083,56	3,18	1157	125302	341845,69	3,38	2227	248657	677929,25	3,29
40 a 45	1074	108836	306130,49	3,51	1060	110765	309832,41	3,42	2134	219601	615962,90	3,46
45 a 50	823	93700	272812,94	3,02	833	98233	280717,22	2,97	1656	191933	553530,15	2,99
50 a 55	874	81114	239243,53	3,65	903	88311	256471,30	3,52	1777	169425	495714,83	3,58
55 a 60	917	71745	207713,86	4,41	937	77261	222700,73	4,21	1854	149006	430414,59	4,31
60 a 65	1097	64835	190729,33	5,75	1080	71241	207353,03	5,21	2177	136076	398082,36	5,47
65 a 70	1098	48791	155627,10	7,06	935	54759	172088,42	5,43	2033	103550	327715,52	6,20
70 a 75	1214	41283	116993,45	10,38	890	51806	143029,88	6,22	2104	93089	260023,33	8,09
75 a 80	1604	36855	109640,33	14,63	1115	52422	149267,10	7,47	2719	89277	258907,43	10,50
80 a 85	1472	25189	75766,96	19,43	1204	43904	125031,08	9,63	2676	69093	200798,03	13,33
85 a 90	978	12965	39021,71	25,06	1081	28978	83030,03	13,02	2059	41943	122051,74	16,87
90 a 110	514	4952	13917,42	36,93	873	15937	44495,90	19,62	1387	20889	58413,33	23,74
Total	14727	1100110	2922923,88	5,04	13752	1232512	3227704,99	4,26	28479	2332622	6150628,88	4,63

*Rate expressed per 1000 person-years

P-0331

Acute abdominal pain: never say never!

Nelson Gentile, Camilla Bersani

Department of Primary Care, Bologna, Italy

BACKGROUND and AIM: Acute abdominal pain is a changeling complaint, frequently benign, but can herald serious acute pathologies (table1). Due to the difficulty to identify which patient could be safely treated symptomatically and which should require further investigation or specialist referral, the authors'd like to focus on accurate diagnostic and therapeutic pathway.

METHODS: E.L.Y., 26 years old, from Morocco, abdominal pain unlocated since the evening before after eating a pizza. He's living in Italy for almost two years and first time visiting his doctor. Past history, reported unlikely due to linguistic barrier, not significant for important previous pathologies or allergies. Physical examination: body temperature 35,8° C, mild sweating, blood pressure 110/70 mmHg, 74 beats/minute, pain score 4/10, soft defense reaction in epigastrium after deep palpation, abdominal bruits presents, vigorous muscles, SaO2 99%. The General Practitioner prescribes anti-acid agents, paracetamol and antiemetic drugs and fixes an appointment for next week. During the day the man stay worse, so decides to go to the hospital. In the emergency room the patient undergoes abdominal ultrasound which underlines abdominal effusion, immediately after tc highlights free air in peritoneum. Neutrophilic leukocytosis is detected. After a few hours the young male is operated for a perforated gastric ulcer.

DISCUSSION: When a patient refers abdominal pain first medical evaluation should include accurate history and targeted physical examination to decide how to act. When doctor is even minimally suspicious for "surgical abdomen" (both peritonitis and obstruction) laboratory measurements, radiography and ultrasound should be required. Furthermore the patient could undergo TC and laparoscopy (image1). This sequence gives the possibility for a reasonable choice on management.

CONCLUSION: Clinical acumen could be misleading in acute abdominal pain. Following carefully a logic and evidence-based diagnostic and therapeutic step-by-step lane is the way to positively impact short and long term patient prognosis.

Keywords: acute abdominal pain, accurate evaluation, "surgical abdomen", diagnostical and therapeutic pathway

Image 1



Flowchart acute abdominal pain

Table 1

Location	Causes
Right upper uadrant	Hepatitis, Cholecystitis, Biliary colic, Pancreatitis, Budd-Chiari syndrome, Pneumonia/empyema pleurisy, Subdiaphragmatic abscess.
Right lower quadrant	Appendicitis, Salpingitis, Ectopic pregnancy, Inguinal hernia, Nephrolithiasis, Inflammatory bowel syndrome, Mesenteric adenitis
Epigastric	Peptic ulcer disease, Gastroesophageal reflux disease, Gastritis, Pancreatitis, Ruptured aortic aneurysm.
Periumbilical	Early appendicitis, Gastroenteritis, Bowel obstruction, Ruptured aortic aneurysm
Left upper quadrant	Splenic abscess or infarct, Gastritis, Gastric ulcer, Pancreatitis
Left lower quadrant	Diverticulitis, Salpingitis, Ectopic pregnancy, Inguinal hernia, Nephrolithiasis, Irritable bowel syndrome, Inflammarty bowel disease
Diffuse	Gastroenteritis, Mesenteric ischemia, Metabolic (eg, DKA, porphyria), Malaria. Familial mediterranean fever, Bowel obstruction, Peritonitis, Irritable bowel syndrome

Causes of abdominal pain by location

P-0332

Acute pulmonary edema display case

Tamara Draskovic¹, Xenia Pantic¹, Anelya Roshu²

¹medical centre zitishte, emergency unit

²medical centre zitishte, general practice

CAPTION:

Acute pulmonary edema is one of the most urgent conditions in medicine. The clinical picture is dominated by a sudden dyspnea caused severe degree, audibly gurgling in his chest, pallor, cold, sweaty skin, weakness, adynamia and foamy sputum, The auscultation can hear medium or large damp crackles diffuse the lungs.

PURPOSE:

Is to describe the diagnosis and adequate care for patients with acute pulmonary edema with respect good clinical practice in primary health care.

DESCRIPTION CASES:

A man, aged 74, was admitted to the clinic around midnight due to suffocation. Home difficulties before two o'clock in the form of chest pain and shoulders.

Status: conscious, oriented, communicative, pale, drenched, cold sweat, visible peripheral cyanosis of the lips and earlobes, without fever, dyspnoea, orthopnea, use auxiliary respiratory muscles with retraction above collarbone cavity.

Vital parameters: TA 240 /140 mmHg SpO₂ 81 %, fr: 105 / min. sug.: 14.2 mmol /l tt 36.7 °C No respiration: 25/min auscultatory FINDINGS: cardiac action rhythmic, quieter tones, damp diffuse crackles on both sides of the lung.

ECG: rhythm sin HR 105/min, the initial ST elevation in V1, V2, Q u d3, AVF, QS V2, V5 signs of LVH

Therapy: open two venous lines, we applied two amp. furosemide lvi one amp. nyrmin ^{**}(1&2 + 1&2) IV, O₂ administered through a mask 5 l, transportation time from the beginning of the review to the hospital 20 min.

CONCLUSION:

Adequate and timely therapy at primary health care level leads to good patient response, improving health and a shorter hospital stay.

KEY WORDS: acute pulmonary edema, adequate therapy, the primary health care level.

Keywords: acute pulmonary edema, adequate therapy, the primary health care level

P-0333

Soft tissue metastases as first clinical manifestation – Case Report

Sara Raquel Magalhães, Érica Viana Rocha

USF Alphamouro, Sintra, Portugal

Background: Soft-tissues metastases are uncommon and rarely reported. This diagnosis should be suspected in the presence of a cutaneous lesion of difficult resolution. They are identified in 1.3-4% of lung cancer patients.

Following lung cancer, kidney and colon carcinoma are the most associated with these invasive disease manifestations. This case report illustrates how severe illness can present itself as an apparently benign lesion, reminding us of the relevance of patient follow-up.

Case Presentation: A 78 years old Caucasian overweight male, ex-smoker of 100 smoking pack-year, with a history of hypertension, dyslipidemia, COPD presents to his GP referring painless skin lesion with 15 days of evolution. Physical examination revealed a tender mass, with inflammatory signs suggesting an inflamed sebaceous cyst or lipoma, for which he was treated with antibiotic therapy. One week later the patient returned with the persistent lesion, which had become ulcerated, draining pus and exudate. Further investigation with ultrasonography revealed a lesion suggestive of metastatic dissemination. Blood work revealed iron-deficiency anemia and elevated inflammatory protein levels. The lung CT scan divulged a solitary nodule compatible with primary lung cancer. The patient was promptly sent to oncology for follow-up.

CONCLUSION: Soft tissues metastases, given their low incidence and nonspecific presentation can easily be misdiagnosed at first examination. This clinical case demonstrates the value of the available and accessible

continuous care provided by GPs. The close follow-up of patients' complains by an attending physician leads to a more timely and correct diagnose.

Disclosure: No conflict of interest declared

Keywords: Soft-tissue, metastases, lung cancer

Image 1 - Lesion progress by the time of second medical consultation



Image 2 - Chest X-ray



P-0334

Síndrome de Miller-Fisher

Enrique Almenar Cubells, Edelmira Moreno Perez, Enriqueta Hernandez Hernandez, Alfredo Quiles Raga, Diana Diaz Gil, Perez Quintana Oscar
Centro de Salud de Benifaio, valencia, Spain

Introductory

The Miller-Fisher syndrome is an atypical variant of Guillem Barre syndrome.

The establishment of the table usually acute in hours or days It is characterized clinically by ataxia, areflexia and ophthalmoplegia. In 72% of cases there is a previous infectious respiratory and enteric second place expense.

CASE:

Patient begins with of congestion and sneezing accompanied by mild fever the next day, headache and cold sores so went to the family doctor that pattern paracetamol and ciprofloxacin after making these the next day

dysarthria ataxia, dysphagia double vision, numbness in hands and feet

Login with suspected Guillem Barre Syndrome

TAC within normal

EMG mildly affected the bilateral median nerve within the normal rest

Normal Evoked Potentials

MRI within normal limits but there are areas of white matter ischemia

Analytical dissociation CSF albumin-cytology and increased anti Ac GQ1b

Diagnosis of Miller-Fisher syndrome

Action Strategy:

The patient evolves favorably to treatment with immunoglobulin and with oropharyngeal and respiratory symptomatic improvement, stable ride and rehabilitation therapy and speech therapy

It must be taken into account from the Primary Care complications of viral and digestive processes which sometimes can give clinical complications

Keywords: Miller Fisher syndrome, Guillem Barre syndrome, ataxia, respiratory infection

mielina



ophthalmoplegia.



P-0335

A case of choleduocholithiasis and weight loss

Adela Ioana Uta¹, Claudia Elena Uta¹, Lia Anguelova Valentinova²

¹Aragon Service of Health, Sector II, Zaragoza, Spain

²National Institute of Endocrinology CI Parhon, Bucharest, Rumania

INTRODUCTION: Disturbances in lipid metabolism, which occur during weight loss lead to formation of gallstones. The aim of this work is to report the case of a woman with a 30 kg weight loss and acute cholecystitis.

Case presentation: A 26-years old female presented in the emergency department with right upper abdominal pain, accompanied by nausea and vomiting for 6 days. That same morning she presented jaundice and clay colored stools. She denied fever. No history of any illness or drug use. The only significant past history is of 30 kg weight loss in the last 12 month with a low-fat, low carb diet (1000Kcal per day mostly salads, fish and lean meat) and exercise.

Physical exam revealed a soft but tender upper abdomen. Full blood count with white cell was normal, inflammatory markers as well, but liver enzymes were mildly elevated.

The ultrasound showed gallbladder with multiple calculi and common duct dilatation (11 mm).

The abdominal CT scan, performed one week later, revealed signs of cholelithiasis, with no choledocholithiasis.

A magnetic resonance cholangiopancreatography was also performed and it confirmed the diagnosis of cholelithiasis.

The patient underwent surgery, with full recovery.

CONCLUSIONS:

Two most commonly suggested mechanisms for gallstone formation are supersaturation of bile with cholesterol, as a result of reduced biliary bile, salt secretion and enhanced mobilization of cholesterol and the insufficient gallbladder emptying due to impaired motility.

Common way of achieving insufficient gallbladder emptying is a low fat, low fibre diet without the preventive use of ursodeoxycholic acid.

It would be very sensible for the general practitioner to supervise the patients that are losing weight through regular blood checks and abdominal ultrasound as a reference before commencing a diet. And also it would be advisable to be done in joint team with an endocrinologist or a dietician.

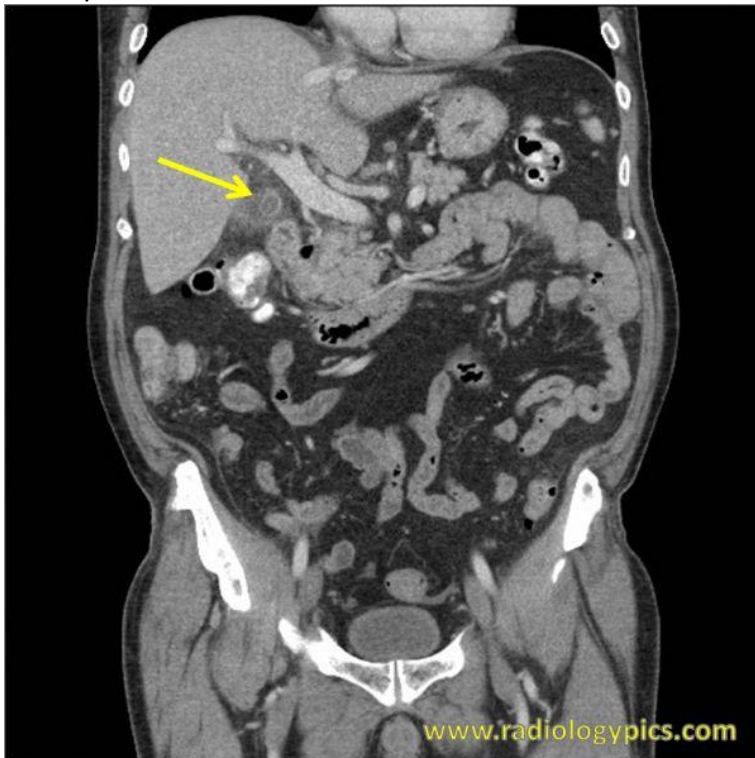
Keywords: cholelithiasis, weight loss, choleduocholithiasis

cholecystitis



CT image of a gallstone

cholecystitis



cholecystitis CT

P-0336

A Different Case of Fever - A Case Report of Chikungunya Fever

Céline Raposo Gama, Sara Margarida Cunha, Sophie Amandine Sousa
USF Oceanos, ULS Matosinhos, Porto, Portugal

BACKGROUND & AIM:

With the increasing popularity of international travel to exotic locations, family physicians are encountering more febrile patients who have recently returned from a tropical country. These patients' assessment is often impaired by the clinician's lack of familiarity with the infections that they may have contracted while travelling to these locations. The aim of this case report is to raise awareness for the importance of conducting a systematic approach in the evaluation of fever in the returned traveler.

METHODS: A case report based on patient's interviews and electronic clinical records. A research was conducted for clinical review.

RESULTS: Female patient, 31 years old, with a personal history of hypothyroidism and allergic rhinitis. She's been living in Angola for the past year, for work-related purposes. A few days after she returns to Portugal, she made an appointment with her family physician due to the onset of fever, poliarticular pain, generalized muscle pain and headache. The only finding on physical examination was the presence of submandibular lymphadenopathies, so she was treated with supportive care. After four days she returns to her family physician. She had no fever, but still complained with poliarticular pain, and had developed a generalized rash. The blood work showed leukocytosis, thrombocytosis and elevated C-reactive protein levels. The patient was then referred to Secondary Health Care, Chikungunya and Dengue's serologies were asked, and the diagnosis of Chikungunya Fever was confirmed.

CONCLUSION: Chikungunya is a virus endemic to West Africa that causes acute febrile poliarticular pain and arthritis. Although in most cases a fever is caused by a common infectious disease, like urinary or upper respiratory tract infections, fever in returned travelers should always raise the suspicion of a tropical infection. Family physicians play an important role in the preventive care that must be taken before travelling to exotic locations.

Keywords: Chikungunya fever, Travel, Arthralgia, Exanthema

Medical appointment

Date Local

21/04/14 Primary Health Care

Fever (39° C), polyarthralgia (wrists, knees and ankles), generalized myalgias and headache, since yesterday. Without any respiratory, urinary or gastrointestinal symptoms. She has returned from Angola 5 days ago.

Physical examination: painless submandibular lymphadenopathies; ears, oropharynx, heart and lungs auscultation: normal

Treatment: supportive care + ibuprofen 600 mg, acetaminophen 1000 mg

24/04/14 Primary Health Care

Generalized pruritic rash. The fever has passed, but she still complains with polyarthralgia.

Physical examination: maculopapular rash (trunk and extremities); heart and lungs auscultation: normal

Treatment: bilastine 20 mg

07/05/14 Primary Health Care

Polyarthralgia (knees and ankles)

Physical examination: pain with joint mobilization and minor edema

Complete blood count and C reactive protein levels à leukocytosis, thrombocytosis and elevated C reactive protein levels

Treatment: ibuprofen 600 mg. The patient was referred to Secondary Health Care

15/05/14 Secondary Health Care

Chikungunya and Dengue's serologies were asked, and the diagnosis of Chikungunya Fever was confirmed

Evaluation of unfocal fever in the returned traveler

How to evaluate unfocal fever in the returned traveler

♣ Medical history

♣ Pre-travel history (immunization, chemoprophylaxis)

♣ Travel history (travel itinerary, purpose of travel, description of the accommodations, sexual history, list of exposures and risks factors)

♣ Physical examination (vital signs, skin, heart and lungs, abdomen, lymph nodes and neurological system)

♣ Always consider common causes first (upper respiratory and urinary tract)

♣ Exclude non-travel causes (the fever may have nothing to do with the trip)

♣ Incubation period <21 days (malaria, typhoid fever, dengue fever or rickettsial diseases) vs >21 days (malaria, hepatitis A or tuberculosis)

♣ Consult with an infectious diseases specialist if the patient is particularly ill, with altered mental status, or when the diagnosis isn't clear

P-0337

Ecchymosis in Young Women: Gardner Diamond Syndrome

Fatma Selek Demirel¹, Ilkay Özer², Yasemin Alagöz¹, Fatma Gökşin Cihan³

¹Konya Training and Research Hospital FM Clinic

²Konya Training and Research Hospital Dermatology Clinic

³Necmettin Erbakan University Meram Medical Faculty FM Department

Background and AIM: Gardner Diamond Syndrome (GDS) is a rare disease distinguished with painful ecchymosis, skin and mucosal bleeding throughout different parts of the body. Skin lesions and bleeding appear in most cases following an emotional stress, are seldomly preceded by small traumas and can recur. Hemostatic tests are generally normal. It is mostly observed in irate young women. In most patients a correlation between tissue lesions and psychiatric problems was detected and it was suggested to name the syndrome as “psychogenic purpura”. Ecchymosis, generally appears as erythema, edema, fever and pain respectively. It is developed in 2-6 hours (maximum 24 hours) following tingling, burning and stinging. This period lasts about 24 hours and inflammation transforms to ecchymosis while the swelling shrinks.

CASE: 24 years old woman patient applied to the dermatology clinic due to bruises on her body. Her history indicated that she had upper respiratory tract infection 2 weeks ago and in the following week ecchymosis, reaching up to size of 3 cm, with irregular borders were developed. There was not any other concomitant pathology in physical examination except ecchymosis. She committed a suicide previously. She had been followed at psychiatry clinic for anxiety disorder. There was no medication history. In blood tests her Hb: 10,6gr/dl, PLT: 354000 K/uL, WBC: 8750 K/uL. Bleeding tests were in normal limits.

CONCLUSIONS: In this syndrome, bleedings in different regions such as nose, ear, eye, and digestive system can accompany tissue lesions. Intra-dermal tissue test can be diagnostic. Antihistaminic, antimalarial, immunosuppressive drugs, steroids, antibiotics, estrogens, and vitamin C were tried but the best treatment is the psychotherapy and psychotropic medication. The patients applying with recurring spontaneous and painful ecchymosis and with normal bleeding and coagulation test results, should be referred to psychiatrists.

Keywords: Gardner Diamond Syndrome, ecchymosis, women

Ecchymosis



P-0338**Vitamin B12 Deficiency in Primary Care: A Case Presented with Pancytopenia**

Yeliz Özendi, Çiğdem Apaydın Kaya, Sevim Aksoy Kartçı, Saliha Şahin, Kübranur Demir
Department of Family Medicine, Marmara University, Istanbul, Turkey

Background and AIM: Vitamin B12 deficiency which is seen commonly in Primary Care could be presented with hemotological and neurological symptoms. We would like to remind that B12 deficiency can be detected with pancytopenia in primary care.

CASE: A 64 year-old male consulted his Family Physician with diarrhea without blood or mucus. He has no disease and medication. At the doctor visit, he had malaise for 3 months with no weight-loss, fever or night-sweat. At laboratory workup hemoglobin was 5.4. Then, he was referred to an emergency care center. At the emergency room Hb:4.8, Htc:13.9, MCV:105, WBC:2800, Plt:62000. After taking blood specimen for blood smear, he was given 1U erythrocyte transfusion and referred to Hematology department. On his physical examination: patient was conscious, vital signs were stable, skin was pale no petechia or purpura, no active bleeding, no hepatosplenomegaly and other system examination was normal. On blood smear there's no blast, normochromic and macrocytic erythrocytes, rarely teardrop cells, PNLs with 5 lobes, 8-9 platelets in every area; LDH:6414, Vit B12:<50 pg/mL, Haptoglobin:<0.0583, reticulocyte:2.8. T.bil:1.61, D.bil:0.24, Fe:104, TFBC:306, Ferritin:384, Folic acide:6.46. Hepatitis serology and HIV antigen negative, Direct-Indirect Coombs negative. Patient was diagnosed as Vitamin B12 deficiency and given 1000 mcg/day cyanocobalamine IM. After 1 week later laboratory findings were Hb:6.9, MCV:102, WBC:3300, Plt:62000, LDH:2872. He benefited from vitamin B12 replacement. To find out the etiology, gastroscopy was performed and erosive antral gastritis was detected. At follow-up with parenteral vitamin B12 treatment, pancytopenia and his symptoms were regressed.

Conclusion and RESULT: Vitamin B12 deficiency could be detected and treated in Primary Care, but this patient had Hb value of 5.4 and pancytopenia that required to refer a tertiary care center for further investigation. Our case has the importance for showing Vitamin B12 deficiency firstly presented with pancytopenia rather than megaloblastic anemia.

Keywords: Vitamin B12 Deficiency, Pancytopenia, Primary Care

P-0339**Case Report: Using of Antibiotic is cause of false-negative rapid antigen test**

Funda Ekimci Deniz, Tuğba Beyazçiçek, Ayşe Semra Demir Akça, Nejat Demircan
Department of Family Medicine, Faculty of Medicine, Bulent Ecevit University, Zonguldak, Turkey

Acute tonsillopharyngitis is one of the most common disorders encountered by primary care physicians. Various classifications, clinical diagnostic procedures and laboratory tests are used in order to make the distinction between bacterial and viral. Rapid antigen tests are commonly used for this purpose. This case is presented for reminding that antibiotic use affects the results of rapid antigen testing and highlight the need to evaluate antibiotic use based on the situation. A week ago, because of high fever, acute tonsillopharyngitis is diagnosed in a seven-year-old male patient who was admitted with complaints of cervical lymphadenopathy on off-center and amoxicillin clavulanate treatment was started. On the third day of treatment, his fever reduced but swelling in the neck developed. Family again admitted to the same doctor and they were said it was due to acute tonsillopharyngitis lymphadenopathy and the patient, who was advised to continue antibiotic treatment, is referred when swelling in the neck didn't persist. Rapid antigen test of the throat swabs taken from patient was negative. Rapid antigen tests give us information in short time periods as 10 minutes in diagnosis of acute tonsillopharyngitis. Patient's history should be listened by considering frequent use of antibiotics without the supervision of physicians and it should be known that negative result doesn't provide us any idea in situation of antibiotics use in the last one week. In such cases where the test is negative we must not forget that we need to take advantage of other clinical scoring.

Keywords: tonsillopharyngitis; rapid antigen test; primary care

P-0340

Sciatica or Pseudosciatica? A Case Report

Catarina Viegas Dias, Catarina Mariano Leal
USF Dafundo, ACES Lisboa Ocidental e Oeiras, Oeiras, Portugal

Background & Aim

Low-back pain (LBP) is one of the most frequent complaints in the Primary Care setting. Piriformis syndrome is an underdiagnosed cause of LBP, that can present with irradiating pain, mimicking radiculopathy. We present a case report that highlights the importance of early identification of symptoms and signs that are unique to piriformis syndrome, enabling appropriate treatment in a timely manner.

Case report

We report a case of a 47 year-old female, currently unemployed, part of a monoparental family. The patient presented as active health problems an ovarian cystadenoma and Hashimoto's thyroiditis. She attended to an urgent appointment complaining of right gluteal pain, irradiating to the hamstring, that worsened with prolonged sitting. Physical examination revealed right buttock tenderness, limited medial rotation of the ipsilateral lower extremity, positive piriformis sign and positive Lasègue sign. Piriformis Syndrome was considered the most probable diagnostic hypothesis, and analgesic therapy was prescribed. The patient returned to a routine appointment, 2 weeks later, still complaining of persistent gluteal pain, partially resistant to naproxen. The physician decided to optimize the treatment plan, combining analgesia with stretching exercises of the piriformis muscle, and referred the patient to a Physiotherapy clinic. After 15 sessions of Physiotherapy treatments the patient improved significantly and was able to resume physical activity.

Conclusions

Piriformis syndrome is a complex condition that should be considered in the differential diagnosis of subacute or chronic hip and low back pain. This patient presented with irradiating pain and revealed a positive Lasègue sign, which could mislead the clinician. However, a thorough and directed clinical examination, as well as a high clinical suspicion, led to the diagnosis of Piriformis Syndrome.

Keywords: Pseudosciatica, hip socket neuropathy, piriformis muscle syndrome

Piriformis stretch



Stretching of the piriformis muscle

P-0341

Analysis of antibiotic use in adults with CAP in primary care (NEUMO-ES-RISK project)

Irene Rivero¹, Jacobo Pardo², Pablo Aldaz³, Diego Agustín Vargas⁴, Enrique Mascarós⁵, Esther Redondo⁶, Jose Luis Díaz⁷, Manuel Linares⁸, María José Fierro⁹, Ángel Gil¹⁰, Jesús Molina¹¹, Daniel Ocaña¹², Federico Martínón Torres¹, On Behalf Of Neumoexpertos¹³

¹Translational Pediatrics and Infectious Diseases Section Pediatrics Department, Hospital Clínico Universitario de Santiago de Compostela, Santiago de Compostela, Spain

²Genetics Vaccines Infections and Pediatrics Research Group (GENVIP), Healthcare Research Institute of Santiago de Compostela, Santiago de Compostela, Spain

³Member of the preventive infectious disease group PAPPS-SEMFYC. Primary Health care Center San Juan. Pamplona. Spain

⁴Versatile unit hospitalization, Hospital for High Resolution El Toyo. Public Sanitary Agency. Hospital de Poniente. Almería. Spain

⁵Health Care Center Fuente de San Luís, Hospital Dr Peset Health Department Valencia, Spain

⁶Preventive and Public Health Activities Group SEMERGEN. International Health Center. Madrid. Spain

⁷Primary Care Health Center, Guadalajara, Spain

⁸Infectious Diseases Group SEMERGEN. Fundación io.

⁹Primary Care Health Center El Olivillo. Cádiz. Spain

¹⁰Professor of Preventive Medicine and Public Health at the Rey Juan Carlos University. Madrid. Spain

¹¹Primary Care Respiratory Group. Health Care Center Francia. Fuenlabrada. Madrid, Spain

¹²Primary Care Respiratory Group. Health Care Center Algeciras, Spain

¹³NEUMOEXPERTOS group is composed by: F. Martínón-Torres; P. Aldaz, D. Vargas, E. Mascarós, E. Redondo, JL. Díaz Maroto, M. Linares, MJ Fierro, A.Gil, J. Molina, D. Ocaña

Background & AIM: Community-acquired pneumonia (CAP) is a major cause of morbidity and mortality in adults even in developed countries. The emergence of new pathogens and the variation of resistance over time require studies that reveal the actual antibiotic therapy approach in CAP. The aim of this study is to assess the antibiotic use in adults with CAP at primary care in Spain.

METHOD: Retrospective observational study in adults (>18 years-old) with CAP diagnosed and attended at primary care in Spain between 2009-2013, using the National Surveillance System of Primary Care Data (BiFAP).

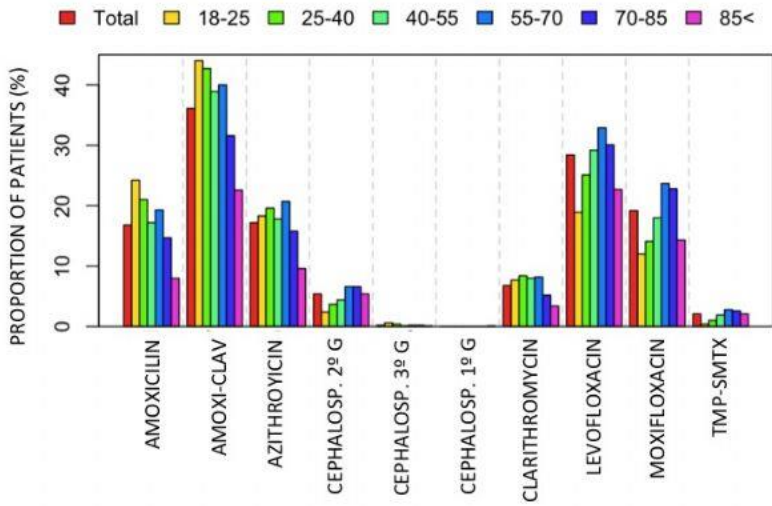
RESULTS: 28.413 patient records were retrieved and analysed. The distribution of the main antibiotics used was: amoxicillin-clavulanate (36.0%), levofloxacin (28.5%), moxifloxacin (18.5%), azithromycin (15.0%) and amoxicillin (14.5%). Combined therapy was used in 37.3%, mainly with the association amoxicillin-clavulanate + levofloxacin (10.6%) and in 55-70 years age group (44,4%). Amoxicillin-clavulanate was the first choice of treatment independent of age or sex, followed by levofloxacin and moxifloxacin in patients 55 years old or over, while amoxicillin and levofloxacin was used in patients under 25 years. Distribution according to age and underlying disease: a) <65 year old without any chronic conditions: amoxicillin-clavulanate (37.2%), levofloxacin (25.2%); b) >65 years old or with the presence of chronic conditions: amoxicillin-clavulanate (32.1%), levofloxacin (30.2%).

CONCLUSIONS: The antibiotic election adequacy in primary care adults with CAP is low according to national and international guidelines. Amoxicillin-clavulanate is the main antibiotic prescribed. Second choice treatment options are quinolones in older patients and amoxicillin for the younger.

Keywords: Community acquired pneumonia, antibiotics, Primary care

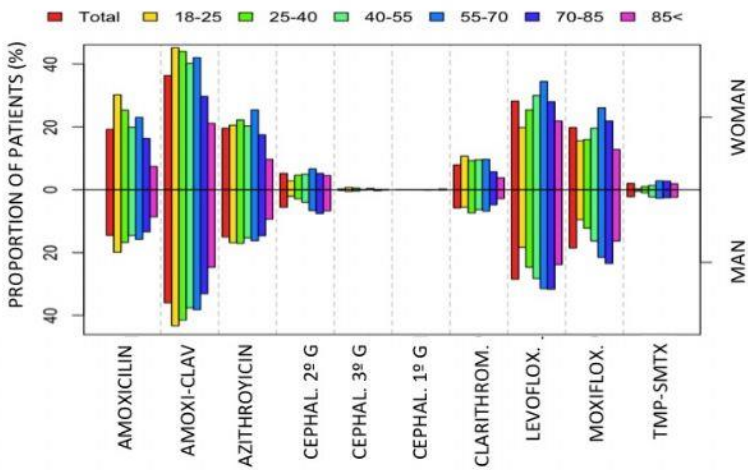
DISTRIBUTION OF ANTIBIOTIC USE ACCORDING TO AGE

DISTRIBUTION OF ANTIBIOTIC USE ACCORDING TO AGE



DISTRIBUTION OF ANTIBIOTIC USE ACCORDING TO AGE&SEX

DISTRIBUTION OF ANTIBIOTIC USE ACCORDING TO SEX & AGE



P-0342

Orally or intramuscularly?

María Del Socorro Fernández Guillén¹, Carmen Celada Roldán², Alexandru Claudiu Coman³, Madalina Daniela Graure³, Esther Cañada Cámara⁴

¹Mar Menor health center, Cartagena, Spain

²Los Dolores health center, Cartagena, Spain

³Cartagena casco health center, Cartagena, Spain

⁴San Anton health center, Cartagena, Spain

• Background and aim: A 45 year-old woman is attended by her general practitioner for fever, polyarticular joint pain and malaise in the last week. She took Paracetamol and Anti-inflammatories without any improvement. No important medical history.

Clinical examination: Blood pressure: 90/50 mmHg, Fever (39.5°C), pale skin, malaise, joint pain with the passive and active mobilization.

She is remitted to the Emergency Room for investigation.

• Method: Blood analysis: Urea 116 mg/dl, Creatinine 2.36, Na 125 mmol/l, Ca 6.6 mg/dl, LDH 517 UI/l, CK245 UI/L, PCR 41 mg/dl, Hb 9.3 g/dl, Leucocytes 18.81 x10e9/L, Neutrophils 18.16 x10e9/L, Platelets 105 x10e9/L

Thorax X-Ray, Abdominal Echography: Normal

Blood and urine culture: Negative

Left gluteus echography: a 5x3cm abscess with echogenic content

Collection culture: S. Aureus

The patient is admitted in the Intensive care unit, where an antibiotic and supportive treatment is initiated, with the improvement of the patient's situation.

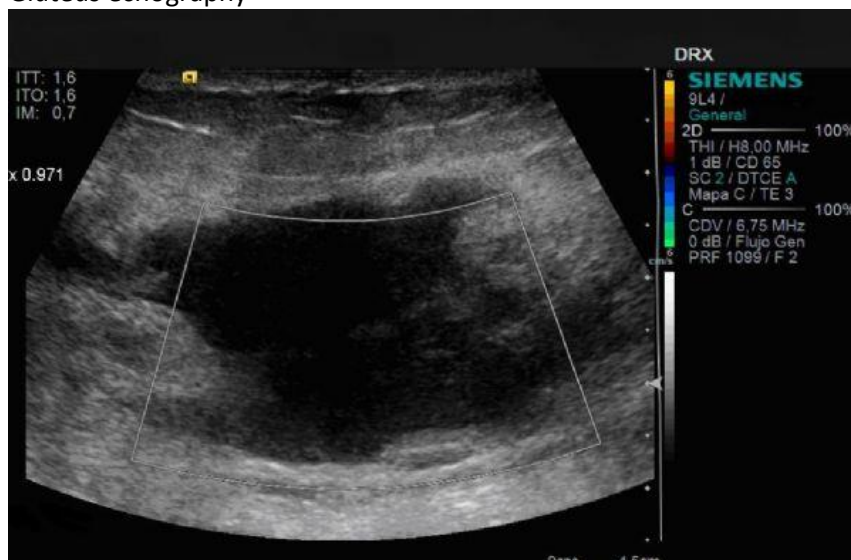
• Results: Diagnosis: Sepsis due to gluteal abscess, with acute renal failure

Differential diagnosis: Infections, any type of shock, acute suprarenal failure

• Conclusions: Sepsis is a systemic inflammatory response syndrome caused by an infection, which presents various symptoms. The treatment must be supportive, to prevent organ failure and to treat the primal infection. It has a very high mortality, a quarter of the patients with severe sepsis and half of the patients with septic shock pass away in the first 30 days. To ensure a quick diagnosis and treatment it is mandatory to do a good medical history and a thorough clinical examination.

Keywords: Sepsis, intramuscular injection, polyarthralgia

Gluteus echography



Collection with echogenic content. Measures 5x3 xm. The wall does not show doppler flow. These findings are compatible with abscess.

P-0343

Antibiotic prescribing in primary care for upper respiratory tract infections

Attila Altiner¹, Martin Duerden², Roman Kozlov³, Ashok Mahashur⁴, Laura Noonan⁵, Aurelio Sessa⁶, Adrian Shephard⁷

¹Rostock University Medical Center, Rostock, Germany

²Bangor University, Bangor, UK

³Smolensk State Medical Academy, Russia

⁴University of Mumbai and Banaras Hindu University, Mumbai, India

⁵Respiratory Tract Treatment Forum, Ireland

⁶Società Italiana di Medicina Generale, Lombardy, Italy

⁷Reckitt Benckiser PLC, Slough, UK

BACKGROUND AND AIM:

Antimicrobial resistance (AMR), a WHO-recognized threat to global health, is perpetuated by non-rational antibiotic prescribing, particularly upper respiratory tract infections (URTIs). Most are self-limiting; for 60-90%, antibiotics provide neither resolution of the condition nor symptomatic relief. Greater emphasis on educational resources and non antibiotics symptomatic therapies is needed.

METHODS:

In 2014, Reckitt Benckiser conducted an online multinational consumer study (total 17,302 interviews ~530 per country, 33 countries) to investigate the patient pathway for minor ailments in the preceding 12 months. We report URTI results, including specifics for UK, Italy, India, Russia, Germany and Ireland..

RESULTS:

Overall, 65% of subjects (11,261) reported a URTI symptom in the previous 12 months (56% UK-71% India), multiple URTI symptoms were often reported. 35% (6135) contacted a healthcare professional (HCP) for URTI symptoms (16% UK-49% India) with physicians (31%; 5303) the preferred HCP for consultation (12% UK-45% India).

Of subjects contacting a physician for URTI, 59% (3140) were recommended a product (UK 44%-Italy 71%), of which 85% then obtained the recommended product. 49% (2612) were prescribed a product (Italy 33%-Russia 55%), with 81% then having the prescription dispensed.

20% (1047) of physician consultations resulted in antibiotic recommendation that was then obtained (9% UK-27% India); 18% (969) resulted in an antibiotic prescription that was then filled (6% Italy-29% Ireland).

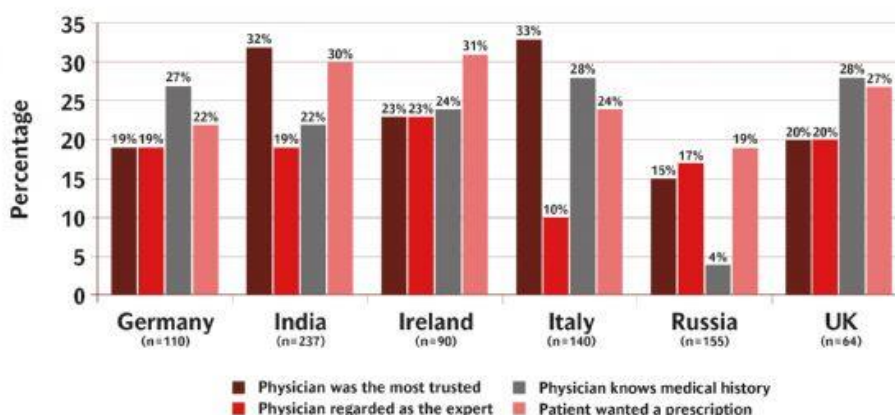
Primary reasons for HCP consultation were trust, familiarity and prescription need. Easy product access and lack of concern were the main reasons for no HCP contact.

CONCLUSIONS:

Results confirm physicians' pivotal role in providing advice and treatments to URTI patients because they are seen as experts. Antibiotics continue to be used for URTIs, mostly inappropriately. The Global Respiratory Infection Partnership (GRIP) has developed educational materials based on what we call a 1,2,3 approach to facilitate physician-patient discussion on URTI conditions, antibiotics and appropriate symptomatic self-management.

Keywords: Antibiotics, Respiratory tract infections, Primary healthcare

Figure 1: The most common reasons for physician consultation, by selected market*



*Percentage of all respondents that consulted a physician with an URTI

Figure 2A: Patients recommended a product/products

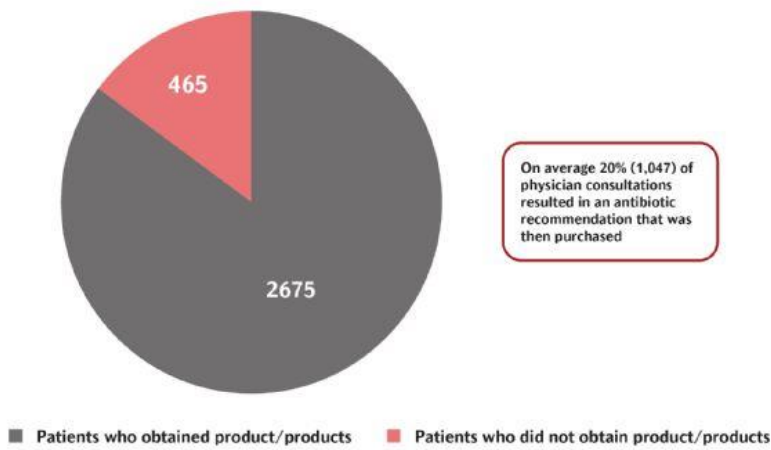


Figure 2B: Patients prescribed a product/products

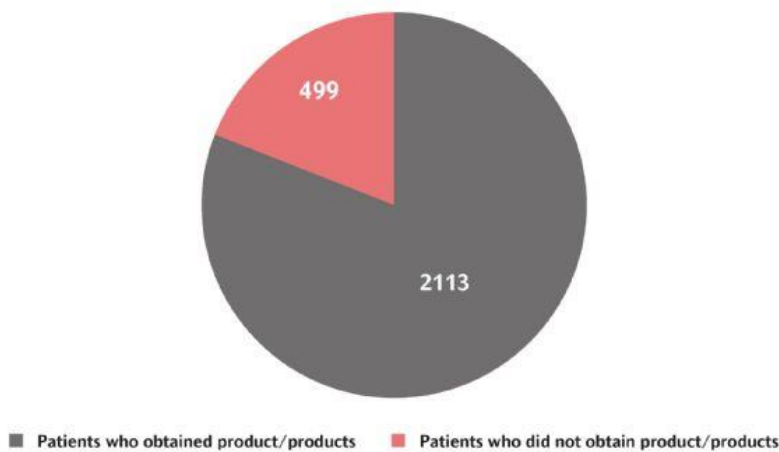
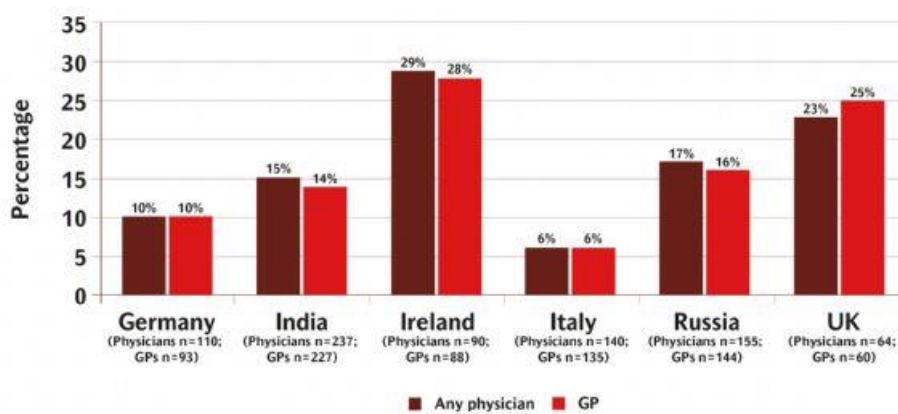


Figure 3: Reported physician and GP antibiotic prescribing for URTIs, by selected market*



*Percentage of patients receiving a prescription for an antibiotic that was subsequently dispensed

Figure 4: Global Respiratory Infection Partnership 5P Framework

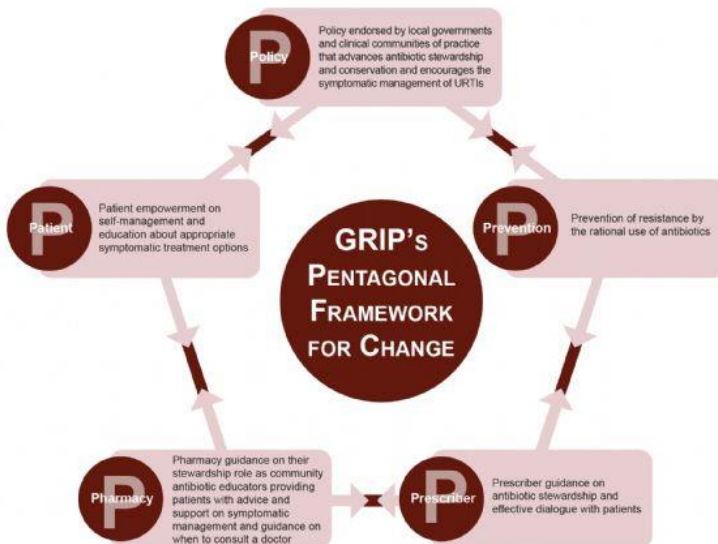


Figure 5: GRIP's 1,2,3 approach for HCPs



Box 1: Changing behaviour in practice - Ireland, Laura Noonan

- In Ireland the majority of antibiotics are prescribed in primary care. As shown in this new study, Ireland had the highest number of URTI patients reporting they had received and filled an antibiotic prescription (29%) of the six countries analysed. Yet, implementation of a patient-centred, enhanced consultation could reduce this figure.
- A previous patient-intervention study in a single clinical practice in Ireland assessed patient knowledge and attitudes towards antibiotic use for URTIs. Some 26.6% of patients reported feeling the doctor did not understand the severity of their symptoms when they did not receive an antibiotic prescription, with 30% consulted with the express purpose of obtaining a prescription for an antibiotic. The majority consulted for symptom relief (43.3%), with others seeking diagnostic clarification (13.3%) or to get certificate for absence from work (13.3%).
- A patient information sheet was used during consultations in the intervention group to provide them with knowledge on the appropriate use of antibiotics and the side effects and potential risks of antibiotics. The control group had a standard consultation.
- The intervention reduced immediate antibiotic prescribing from 47.5% to 13.3% and delayed prescription rates increased from 15% to 43.3%. Inappropriate prescribing was reduced from 10% to 3.7%.
- In addition, consultation time was reduced from 11 minutes to 10 minutes and fewer patients re-consulted.
- The study illustrates the benefit of having an enhanced dialogue with patients. Local, up-to-date evidence based guidelines should also be available for GPs to recognise the benefit within their community.

Box 2: Changing behaviour in practice - Italy, Aurelio Sessa

- As shown in this new study, Italy had the lowest number of GPs prescribing antibiotics for an URTI (6%) of the six countries analysed. It should be noted, however, that under-the-counter antibiotic sales occur in Italy, which may account for the low figure here, in addition to possible confusion in patient self-reporting in the study.
- A previous study considered the impact of the GRIP antibiotic prescribing toolkit on prescribing rates in clinical practice. This patient-intervention study assessed use of the toolkit among consecutive patients presenting with sore throat from September 2013-November 2013, inclusive.
- In total 165 adults were included, with an even gender split and median age of 39 years. On average, sufferers had 2.9 days with a sore throat prior to consultation, with median severity of 2.96 (maximum score = 5).
- Antibiotics were prescribed in 41.2% of cases, with a marked reduction in antibiotic prescribing where the GRIP toolkit materials were used in the patient consultation: 29% vs. 44%.

Box 3: Changing behaviour in practice - GRIP support

GRIP provides a range of support materials that can be downloaded from its website:
www.grip-initiative.org

P-0344

Glomus Tumor: an unusual cause of finger pain

Ana Raquel Cunha¹, Sandrina Costa¹, Daniela Pinto², Daniela Pedrosa³

¹USF Bracara Augusta, Braga, Portugal

²USF MaxiSaúde, Braga, Portugal

³USF Torrão, Lousada, Portugal

Background

Glomus tumor is a rare benign neoplasm, arising from the neuromyoarterial smooth muscle receptors that are sensitive to temperature and regulators of microvascular circulation. It is more common in young adults and in females, accounting for 1-5% of neoplasms of the soft tissues of the hand. Usually presents as a solitary lesion, subungueal or in the fingertips, but may be found in other locations. Diagnosis is clinical, presenting as an acute pain in the fingertip triggered by palpation and cold sensitivity. X-rays, ultrasound or MRI can help, but the definitive diagnose is determined by histopathology. Differential diagnosis includes melanoma, neuroma, angioma, melanocytic nevi and arteriovenous malformations. Surgical excision is the only known definitive treatment.

Case Report

REMD, male, 40 years old, clerk, with no relevant past medical history. He belongs to a nuclear family, with a moderate dysfunction of familial APGAR and within class VI of Duvall life cycle. He attended several times his health unit in December 2014 due to acute pain in the 4th fingertip of the left hand, triggered by touch and cold, complicating his job. On inspection he had a reddish area of 1 mm diameter on the ulnar side of the 4th finger. X-ray and ultrasound were normal. He was then referred to Dermatology consultation, and subsequently to Orthopaedic consultation. Due to high clinical suspicion, surgical excision was performed, whose histological exam revealed a Glomus tumor. Patient symptoms were completely reversed after surgery.

Discussion

Although Glomus tumor is a rare benign entity, it can be quite disturbing due to pain triggered by the slightest touch or hypersensitivity to cold, and therefore it can interfere with the patients daily life activities. Family physician should be aware of this condition, in order to provide optimization in diagnosis and early treatment, maintaining quality of patients health.

Keywords: glomus tumor, fingerpain, cold sensitivity

P-0345

Mucocutaneous Bleeding Due to Usage Coumadin and Clopidogrel: A Case Report

Ali Ramazan Benli¹, Murat Koyuncu², Mustafa Koroglu³, Senay Demir Yazıcı⁴, Mustafa Cortuk⁵, Orhan Onalan⁶

¹Department of Family Medicine, Medical Faculty, Karabuk University, Karabuk, Turkey

²Department of Emergency Medicine, Medical Faculty, Karabuk University, Karabuk, Turkey

³Department of Hematology, Medical Faculty, Karabuk University, Karabuk, Turkey

⁴Department of Physical Examination and Rehabilitation, KBU Karabuk Education and Research Hospital, Karabuk, Turkey

⁵Department of Chest Disease, Medical Faculty, Karabuk University, Karabuk, Turkey

⁶Department of Cardiology, Medical Faculty, Karabuk University, Karabuk, Turkey

Today thromboembolism (TE) is one of the most important mortality and morbidity cause. For TE, in high risk conditions combined therapy (CT) is preferred considering that these drugs are not sufficiently protective solely. When CT is applied, increased bleeding as a side effect is observed. In this report, CT's side effects are discussed in the light of a case who applied to hospital with broad skin rash due to usage of clopidogrel and warfarin combination.

CASE: A male patient age of 65 is applied to clinic of family medicine with broad skin rash on proximal extremity areas. History of warfarin and clopidogrel was exist as anticoagulant medication therapy due to coronary by-pass surgery with aorta and mitral valve replacement ten years ago. Rash was observed on interior thigh areas by physical examination (Fig. 1). There wasn't a finding except skin lesions in general examination. Prothrombin time was 25 sec. INR was 2.09, thrombocyte count was 186,000 μ L and bleeding time was increased (>15 sec.). In peripheral blood smear thrombocyte morphology and count was normal but aggregation of thrombocytes couldn't observed. Clopidogrel medication was ended considering mucocutaneous bleeding related to it. On 10th day of follow-up fading and on 3rd week total vanishment of petechies was observed.

DISCUSSION: In case of usage of both antiaggregant and anticoagulant drugs they may potentialize each other's effect. As a consequence, there may occur bleeding in varying locations and ratings. It is important of which medication's side effect is it when a complication arises due to usage of KT. Diagnosis and medical intervention must be immediately made due to risk of morbidity and mortality. Thus, family medicine specialized physicians must know well the effects and side effects of drugs in primary care health service with patients who use combined drug medication.

Keywords: Mucocutaneous Bleeding, Combined Therapy, Complication

Figure 1



P-0346

Malaria again! Fourth Time In a Healthcare Provider, Despite Prophylaxis

Yusuf Üstü¹, Salih Molahaliloğlu², Zeliha Tufan Koçak³, Basri Furkan Dağcıoğlu¹, Dilek Öztaş², Mehmet Uğurlu¹

¹Yıldırım Beyazıt University, Faculty of Medicine, Department of Family Medicine

²Yıldırım Beyazıt University, Faculty of Medicine, Department of Public Health

³Yıldırım Beyazıt University, Faculty of Medicine, Department of Infectious Diseases and Clinical Microbiology

Introduction

Malaria is a parasitic infectious disease which is common in tropical and subtropical regions, caused by different obligate intracellular Plasmodium species (*P. Vivax*, *P. Falciparum*, *P. malariae*, *P. ovale* and *P. knowlesi*). Since 2010 no new local malaria case has been reported in Turkey except relapsed or foreign cases. An imported malaria case has been presented here.

Case

A 47 years old man admitted to our outpatient clinic with complaints of fatigue going on for 1 week, occasional fever, headache, cold sweats, diarrhea and loss of appetite, which were mimicking viral diseases. In physical examination, he seemed exhausted, overall situation was good, orientated and cooperating. BP:120/70 mmHg, pulse:94/min and rhythmic, axillary fever:38,2 0C with normal systemic examination. It is learned that he was diagnosed for malaria 3 times after international travels and treated for it. He told that he had gone to Gambia 20 days ago and stayed there for a week. He had been taking Malaron for prophylaxis so that fever was not prominent and the clinical course was suppressed. In laboratory tests; Hgb: 12.6 g/dl (13,5-18), MCV: 79,6 fL, MCH: 26,2 pg (27-33), WBC: 12,97 K/uL (4-11), Neu: 9,87 K/uL (1,8-7,7), PLT:314K/ul (150-450), AST: 25 U/L (0-40), ALT: 31 U/l (0-41), LDH: 262 U/L (135-225), T. Bilirubin: 0,69 mg/dl (1,4) D. Bilirubin: 0,22 mg/dl (0,3). Hepatitis markers were in normal range.

In peripheral blood thick drop smear during fever, *P. falciparum* ring form was detected. Follow-up protocol was initiated for the patient after starting Artemether tablets.

Result

It is important to inform people about malaria and prevention, especially those who travel internationally. In symptoms like fatigue after travel and diarrhea, malaria should always kept in mind, even in cases with history of 3 times diagnosis for malaria before or still taking prophylaxis for it.

Keywords: Malaria, Preventive medicine, Infectious diseases, Travel associated diseases

P-0347

Gynecomastia in a young male

Ángel Hurtado De Mendoza Medina¹, Carmen María Jiménez Herrera², Ruth Muñoz Maya³, Elvira García Martín⁴

¹CS Doña Mercedes, Dos Hermanas. AGS Sevilla-Sur. Andalussia, Spain.

²CS Nuestra Señora de la Oliva, Alcalá de Guadaíra. AGS Sevilla-Sur, Andalussia, Spain

³CS Don Paulino García Donas, Alcalá de Guadaíra. AGS Sevilla-Sur, Andalussia, Spain.

⁴CS Virgen de Consolación, UGC Utrera Sur, Utrera. AGS Sevilla-Sur, Andalussia, Spain

Case Description: Male aged 29 years old comesto our office with bilateral gynecomastia, greater in his left breast of 6-8 months of evolution.

No drug allergies, not other medical history, no home treatment, non smoker, non drinker.

The general physical examination was normal except for bilateral gynecomastia without secretion from the nipple. No axillary alterations.

Complementary Tests:

- Blood general test: normal. There weren't any alterations in renal or hepatic test.

- Breast ultrasound: fibro-glandular tissue without nodules or calcifications found to suggest malignancy.

- Blood hormones: T4, prolactin and estradiol normal. Free testosterone 65 (normal: 89-280 pg / ml), FSH 2 IU / L (normal 1-10 IU / l), LH 2 IU / l (normal range (1-9 IU / l) with hypogonadism.

In his next consultation, we re-asked the patient about drug use (opiates, marijuana...). Finally, he tells us that

he's been using natural protein supplements and intramuscular injections with nandrolone and estanozolol when he does workout at the gym.

Diagnosis: Anabolic gynecomastia.

Treatment: We recommended the patient ceasing anabolic treatment. In more advanced cases we can use oral tamoxifen (in our patient was finally not necessary) or even surgical treatment.

Discussion:

- 1) The main causes of gynecomastia are: tumor (testicle, adrenal...), familial gynecomastia, drugs...
- 2) There are studies that show increased use of anabolic in young people who exercise and athletes, around 9.1% of males and 2.1% for women.
- 3) It is essential to perform a good medical history to avoid costly and unnecessary studies. The profile of this condition are young patients with athletic physical form.

Keywords: Gynecomastia, Anabolic drugs, Medical History, Breast tumor

Bilateral Gynecomastia



Before and months after ceasing hormone intake

P-0348

Clinical impact of rapid point-of-care tests for acute sore throat

Jukka Vakkila¹, Minna Mäki², Maija Riitta Lindberg², Tuula Siljander², Anne Marie Ackermann², Jaana Raussi², Kristina Hotakainen¹

¹Mehiläinen Oy, Pohjoinen Hesperiankatu 17 C, 00260 Helsinki, Finland

²Orion Diagnostica Oy, P.O. Box 83, 02101 Espoo, Finland

Background

We investigated (1) clinicians' and (2) patients' expectations on rapid point-of-care (POC) tests for *Streptococcus pyogenes* (Strep A); (3) frequency of ordering Strep A and other tests for patients with pharyngitis; and (4) the performance of QuikRead go Strep A (Orion Diagnostica) against culture at two sites of a private healthcare service provider in Finland.

Methods

Questionnaires were used for gathering information from general practitioners, paediatricians and patients. QuikRead go Strep A tests were performed according to manufacturer's instructions and culture on selective blood media using one day incubation at 37°C.

Results

Altogether 55 clinicians responded. Forty-seven clinicians (85%) requested also blood tests, C-reactive protein and blood count most frequently. Twenty clinicians (36%) always order a Strep A test for a patient with symptoms. Fifty-two clinicians (95%) reported the Strep A test result to guide their decision on antibiotic prescription. Altogether 114 patients responded. Based on replies, 87% clinicians had considered a Strep A test necessary before treatment. Eight patients requested a Strep A test themselves. Twenty-eight physicians (25%) had prescribed the antibiotics before the test result.

130 samples were tested using QuikRead go Strep A and culture showing an overall agreement of 87% between these methods.

Conclusions

Even though only one third of responding clinicians always order a Strep A test to a patient with pharyngitis, the patient replies demonstrated that nearly 90% of treatment decisions were supported by Strep A test. Thus, the use of Strep A POC testing is highly driven by the clinicians. Only 7 % of patients demanded the test by themselves. Not surprisingly, the reported most important features of POC Strep A tests were rapidity, reliability and specificity which were accomplished by QuikRead go Strep A.

Keywords: Strep A, Point-of-care diagnostics, Streptococcus pyogenes, Clinical impact

P-0349

"{"Affright or death: the importance of anamnesis in Primary Health Care "}"

María Jose Gamero Samino¹, Francisco Luis Pérez Caballero², Jose Maria Tena Guerrero³, Fatima Mora Monago¹, Francisco Buitrago Ramirez², Nuria Rivera Jimenez², Cristina Gato Nuñez², Laura Araujo Marquez¹, Glenda Salguero Abrego¹, Veronica Bejarano Moguel¹, Virginia Bueno Garcia², Laura Muñoz Abad², M^a Jesus Tena Huertas²

¹Primary Care Center "San Fernando", Badajoz, Spain.

²Primary Care Center "La Paz", Badajoz, Spain.

³University Hospital Complex, Badajoz, Spain.

One morning on June, came to our consulting room, María. She's 50 years old, and she hasn't got any medical history. Her father died due to an ischemic heart disease.

She was worried about a sudden chest pain radiated to her back, accompanied with palpitations, shortness of breath and nausea, lasting 3 hours. She had a similar episode 2 days ago, and in the last week, she has been having insomnia because of an important emotional stress.

In that moment, the physical examination revealed: blood pressure 90/50, heart rate 110, oxygen saturation 90%; crackles heard in lung bases, with no more signs. We performed an electrocardiogram that revealed an inverted T wave in I, aVL, II, III, aVF, V2-V6, QTc 492 ms.

After this results, we decided to derive her our Referral Hospital, with the suspicion of Acute Coronary Syndrome with left heart failure signs.

The laboratory results highlighted an elevated troponin and creatinine kinase-MB, and a normal chest x-ray. Then, the echocardiogram showed an akinesia of the apical and mid-ventricular segment while the basal segments were hypercontractile, with 35% ejection fraction. Coronariography was normal, and ventriculography showed an apical ballooning akinesia with basal hyperkinesis.

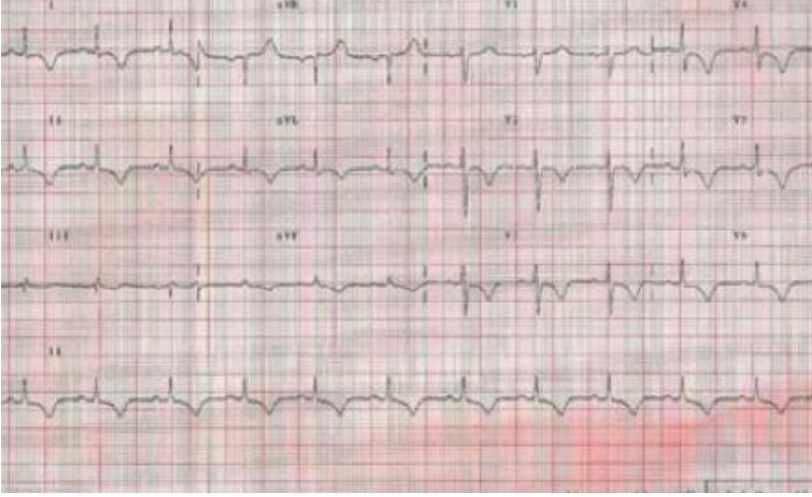
The diagnosis was Takotsubo cardiomyopathy (TC).

The treatment of TC is generally supportive (bradycardia and low blood pressure); she was discharged after 7 days with this treatment: a beta-blocker (2 times/day) and a de-aggregating agent (1 time/day).

TC is a transient cardiac syndrome that involves left ventricular apical akinesia and mimics acute coronary syndrome. It was first described in Japan by Sato. Patients often present with chest pain, have ST-segment elevation on electrocardiogram, and elevated troponin levels consistent with a myocardial infarction. However, when the patient undergoes cardiac angiography, left ventricular apical ballooning is present and there is no significant coronary artery stenosis.

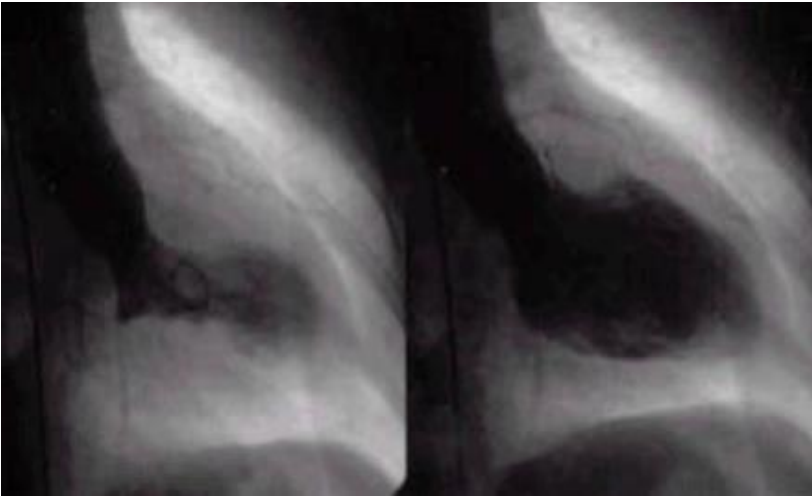
Keywords: Chest Pain; Acute Coronary Syndrome; Heading Stress, Psychological.

Picture 1.



Electrocardiogram that revealed an inverted T wave in I, aVL, II, III, aVF, V2-V6, QTc 492 ms.

Picture 2.



Ventriculography showed an apical ballooning akinesis with basal hyperkinesis.

P-0350

Pulmonary Thromboembolism in Patient That Admitted With Atypical Clinic: A Case Report

Zeynep Sayın Dincer¹, Gökhan Dincer², Aybüke Demir Alsancak¹, Duygu Ayhan Başer¹, Hatice Küçükceran¹, Yakup Alsancak³, İrfan Şencan¹, İsmail Kasım¹, Rabia Kahveci¹, Adem Özkara⁴

¹Ankara Numune Training and Research Hospital, Department of Family Medicine,

²Ankara Training and Research Hospital, Department of Family Medicine,

³Ankara Atatürk Training and Research Hospital, Department of Cardiology

⁴Hitit University Faculty of Medicine, Department of Family

INTRODUCTION: Pulmonary thromboembolism (PTE) is a major clinical problem that has a high mortality and morbidity. For the diagnosis of PTE, firstly physicians should suspect the disease. PTE is a difficult disease to diagnose because of the illusive, nonspecific and varied symptoms upon presentation. The major challenge for primary care is the lack of equipment for definitive diagnosis of the condition and all patients suspected to have a PTE must be referred to a higher center. We aim to present an interesting case of PTE in this case report and would like to discuss management of the condition in primary care.

CASE: Seventy-two-year-old woman was admitted to our outpatient clinic of outpatientclinic of with cough that has started a week ago. She had effort dyspnea for 3 years but recently there has been no significant increase in dyspnea noticed. Also she had stabbing pain on left side of back. She has no chronic disease history other than

COPD. She had a blood pressure of 140/85, heart rate 82, respiratory rate 18, temperature 36.1 C. Her chest examination revealed rhonchi bilaterally, but was clear at percussion. No accessory muscle use was noticed and there was no sign of cyanosis. Rest of the physical exam did not reveal anything remarkable. Laboratory data revealed an elevated white blood cell, sedimentation rate and CRP. There was a clinical suspicion for PTE in the patient because she was obese and we measured D dimer and determined elevated. (352ng/ml) Diagnosis of PTE was confirmed by CT angiography.

CONCLUSIONS: PTE has a wide range of courses from asymptomatic to sudden death. Except patients have the highest degree of clinical suspicion, it is also possible to diagnose pulmonary embolism in patients with non-specific clinical findings. To identify these patients may prevent pulmonary embolism induced morbidity and mortality.

Keywords: Pulmonary thromboembolism, Atypical Clinic, back pain,

P-0351

Single-Dose Intramuscular Methotrexate Treatment of Ectopic Pregnancy

Ahmet Ünal¹, Burcu Bıçakçı², Hamit Alper Tanrıverdi², Yetkin Şentosun¹

¹Department of Family Physician, Adnan Menderes University, Aydın, Turkey

²Department of Obstetrics and Gynecology, Adnan Menderes University, Aydın, Turkey

INTRODUCTION

Ectopic pregnancy is the most common life-threatening condition in early pregnancy. Implantation elsewhere is considered ectopic and comprises 1 to 2 percent of all first-trimester pregnancies in the United States. The ampulla is the most frequent site, followed by the isthmus. Ectopic pregnancy is the leading cause of first trimester pregnancy-related morbidity and mortality (38 deaths/100,000 events). It is a life-threatening pregnancy complication; so early diagnosis becomes very important in treatment. Diagnosis is based on a combination of ultrasonographic findings, consecutive levels of human chorionic gonadotrophin (hCG) and also clinical suspicion.

CASE REPORT

A 33-year-old woman presented with irregular and scanty bleeding with occasional abdominal pain for 3 days. There was 2 history of missed periods. She had a period of amenorrhea of 5 weeks and 3 days before which her menstrual cycle was regular with normal flow. She has had two full-term vaginal deliveries. There was no history suggestive of pelvic inflammatory disease, previous laparotomy or intake of fertility-enhancing drugs.

On examination, the patient was pale, although her vitals were stable. Her pulse rate was 78 beats/min, and blood pressure was 130/ 80 mm Hg. Her abdomen was soft; there was no tenderness or guarding. In pelvic examination there was no bleeding per vagina. Beta hCG was 657.71 mIU/mL.

Pelvic sonographic examination was done to localize this pregnancy, the uterine cavity was found empty and there was massive pelvic fluid collection. Beta hCG was 737.11 mIU/mL. The diagnosis of ectopic pregnancy was diagnosed.

Single-dose protocol of methotrexate (50 mg/m²) is administered intramuscular on day 1, and the hCG value is measured 647.86 mIU/mL and 354.25 mIU/mL respectively on days 4 and 7.

CONCLUSION

In primary care, Early diagnosis of ectopic pregnancy would be life-saving.

Keywords: Ectopic pregnancy, Methotrexate, Primary care

P-0352

Listen to Young Hearts

Rana Gundogan, Kubra Uyar, Burcu Aslan, Nilgun Ozcakar
Department of Family Medicine, Dokuz Eylul University, Izmir, Turkey
Background&Aim

Palpitation is a disturbing feeling of heartbeats and hard work, sleep disorders, stress, alcohol&smoking and over-consumption of tea and coffee are common causes. Patients with palpitation for any reasons (cardiac, psychological, systemic such as hyperthyroidism, anemia..) should be evaluated by electrocardiogram(ECG) of first priority. Wolff-Parkinson-White(WPW) Syndrome is a birth defect causes tachycardia, evolved by an additional electrical path. Seen in society is 1/100000 and more on males, cause palpitations, dizziness, syncope, dyspnea, chest pain and rarely(less than %1) ventricular fibrillation and death. Our goal is to draw attention to evaluation of young patients with palpitations.

CASE: No known disease, 21-year-old female medical student was admitted to emergency complaining of palpitation. She felt palpitation 2 hours before at home and noted blood pressure:130/80mmHg, pulse rate:165/min. It's the first time that she had palpitations and stated that she had been exercising since 1 year, consumed more coffee recently and was under intense stress during her examination dates. At her application; blood pressure:125/80mmHg, heart rate:78/min and body temperature:36.6°C. Physical examinations found regular including cardiac examination.

ECG:Sinus rhythm, Heart rate:83/min, PR<0.12sec and delta wave at the beginning of QRS complex. Hb:13.2g/dL, WBC:8.0x10³/mm³, LFT, KFT, CRP, electrolytes and cardiac enzymes are normal and blood glucose was 64 mg/dl. After held 8 hours in cardiology consultation with diagnosis of WPW Syndrome, she was discharged by recommendation of 24-hour Holter ECG control and no medical treatments were recommended.

Discussion and CONCLUSION:

Some arrhythmias can be simple while cause of others is serious. ECG evaluation after physical examination and a careful cardiac examination has a great importance on young patients who come with palpitations without thinking it's caused by neither psychological complaints nor stress&caffeine.

Family physicians should be cautious on patients who have the symptoms of arrhythmia. These symptoms should be assessed in detail, regardless of any health-care condition.

Keywords: Palpitation, WPW Syndrome, arrhythmia

P-0353

"{" Doctor, do I have a frequent back pain?: a case of Cauda Equina Syndrome. "}"

Maria Jose Gamero Samino¹, Francisco Luis Pérez Caballero², Jose Maria Tena Guerrero³, Fatima Mora Monago¹, M^a Jesús Tena Huertas², Maria Soledad Pineda Pérez⁴, Romualdo Roncero Vidal⁵, Jose M^a Gonzalez Sánchez⁵, M^a Jose Lozano Fernández², Inmaculada Rodriguez Gómez², Francisco Buitrago Ramirez², Nuria Rivera Jimenez², Crisitna Gato Nuñez², Laura Dominguez Piriz²

¹Primary Care Center "San Fernando", Badajoz, Spain.

²Primary Care Center "La Paz", Badajoz, Spain.

³University Hospital Complex, Badajoz, Spain.

⁴Primary Care Center "San Roque", Badajoz, Spain.

⁵Primary Care Center "Pueblonuevo del Guadiana", Badajoz, Spain.

José is a 50 years old man, with a history of hypertension and dyslipidemia, with no more previous illness. He came to our consulting room worried about an intense lower back pain, radiating to the lower limbs, because of an important effort performed 3 days ago. Besides, he's feeling numbness in both feet and pelvic girdle, intermittently, and difficulties to walk and at the beginning of urination.

The physical examination revealed: blood pressure 150/80, oxygen saturation 98%, heart rate 75, without fever. The neurological examination was abnormal: patellar hyperreflexia in both sides, with an absent achilles reflex;

left foot dorsal flexion 1/5 and right 0/5; left foot plantar flexion 1/5 and right 0/5; no loss of sensitivity in lower limbs; negative Lasegue; the rest of examination is within normal limits.

With the suspicion of some medullary disease, we decided to derive our patient to the Emergency Room to complete the study.

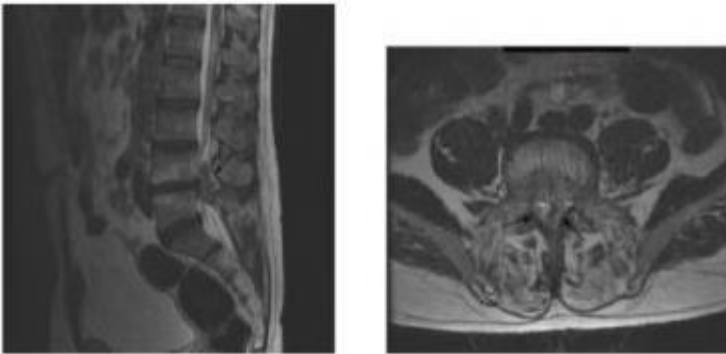
There, the tests results were normal, including an electrocardiogram and a chest and an abdominal x-ray. In spite of that, the decided to perform a magnetic resonance objetifying a lumbar disc herniation at the level of L4-L5.

The diagnosis was Cauda Equina Syndrome due to a lumbar disc herniation. When the diagnosis was clarify, an urgent surgery was indicated (partial laminectomy and resection of disc herniation), with significant functional recovery in the following days.

CES is a rare condition, with serious consequences if not treated promptly. It is most often caused by a large disc herniation in the lower back that compresses the nerve roots. Unlike most back problems that are longstanding or chronic, CES is an acute event which develops rapidly, within 6-10 hours. Classic symptoms of back pain, coupled with a sudden onset of numbness in the genital area and urinary retention. Relieving compression quickly is decisive.

Keywords: Low back pain; Cauda equina; Intervertebral Disc Displacement.

Picture 1 and 2.



Magnetic resonance objetifying a lumbar disc herniation at the level of L4-L5.

P-0354

Ruptured Pacemaker Lead-Induced Repetitive Case Of Infective Endocarditis

Yaşar Koşar¹, Esengül Ünal¹, Ahmet Akçay², Mustafa Çelik¹, Mustafa Haki Sucaklı¹

¹Department of Family Medicine, Kahramanmaraş Sütçü İmam Universty, Kahramanmaraş, Türkiye

²Department of Cardiology, Kahramanmaraş Sütçü İmam Universty, Kahramanmaraş, Türkiye

INTRODUCTION: Pacemaker endocarditis is a life-threatening condition, early diagnosis and timing of treatment is important.

CASE: 37 year old male patient was admitted to our clinic with complaints of cold, rising fever with chills continued for a week. His past history, in 1998 he had been operated for ventricular septal defect and permanent pacemaker had been implanted. We learned that the rupture of the pacemaker lead was detected and a new pacemaker was re-implanted to him when he was presented to the hospital with complaining of palpitations and fatigue in 2003. Patient had been admitted to hospital again with complaints of fever, chills, cold and he had received medical treatment with the diagnosis of infective endocarditis in 2009.

During the last one week, patient had complaints of fever, chills, sweating and he was presented to emergency service. He hospitalized with the suspicion of infective endocarditis. His temperature was 38.2°C. Laboratory studies: white blood cell count 15900/mm³, erythrocyte sedimentation rate 40 mm/hour, C-reactive protein (CRP) 86 mg/dl.

Transthoracic Echocardiography: Around the pacemaker lead, there were mobile and immobile vegetations.

Blood cultures were taken 3 times in the first 24-hour period. 4*500 gr vancomycin, 2*160 mg gentamycin were started intravenously. On the second day, Staphylococcus hominis of coagulase negative staphylococci was

identified from blood cultures. After the medical treatment CRP and leukocytes decreased to normal levels. Patient was transferred to the heart and vascular surgery clinic for surgical removal of pacemaker leads and battery.

Discussion and CONCLUSION: In primary care, family medicine clinics are quickly and easily accessible units by individuals and have an important position in terms of early diagnosis of infective endocarditis, rapid organization of treatment, periodic evaluation of the patients in the risk groups and presentation of preventive health services.

Keywords: pacemaker, endocarditis, family medicine, preventive care

P-0355

Analysis of Family Physicians' Knowledge and Attitude of Cardiopulmonary Resuscitation in Turkish Primary Care: A multi-central Study Preliminary Results

Erdoğan Yavuz¹, Erol Yayla², Saide Eda Cebeci³, Serkan Özdemir⁴, Nurşah Özkan⁵, Serdal Kanuncu⁶, Bilge Sönmez⁷, Gökhan Eminsoy⁸, Cem Oktay⁹, Mehmet Akman¹⁰

¹1st Family Healthcare Center, Rize

²Mehmet Akif Ersoy Family Healthcare Center, Adana

³Serdivan Family Healthcare Center Sakarya, Turkey

⁴İnönü Family Healthcare Center Trabzon, Turkey

⁵Tepehan Family Healthcare Center Antakya

⁶Tanisma Family Healthcare Center Antakya

⁷Emir Karatekin Family Healthcare Center Çankırı

⁸Başkent University Department of Family Medicine Ankara

⁹Akdeniz University Department of Emergency Medicine Antalya

¹⁰Marmara University Department of Family Medicine İstanbul

Since the end of 2010, transition in primary care has been completed and it's now assumed that every citizen has a "family doctor" in Turkey. There are 21,750 family doctors in Turkey. Only 1048 (4.9 %) of the family doctors have post graduate training, so called specialists in family medicine. It is mandatory by legislation to have a defibrillator in 6,756 family healthcare centers throughout the country. However, family doctors once general practitioners came from different facilities to work in primary care. Some had no experience in emergency medicine. We aimed to analyze the knowledge level of family doctors in cardiopulmonary resuscitation (CPR) and their attitude toward it in order to help health managers to better evaluate the necessity of a country-wide post-graduate education program on this matter.

These are preliminary RESULTS: We have interviewed face-to-face with 164 family doctors and 15 emergency medicine specialists so far with a questionnaire consisting of 15 multiple-choice questions prepared from latest CPR guideline by a selective group of academicians in emergency medicine seeking for information and 15 questions about their attitude towards CPR. Questions were targeted especially to the topics recently changed substantially in order to analyze how up-to-date the doctors were. The results of family doctors and emergency medicine specialists were compared. We found that the correct number of answers were $5,6 \pm 2,9$ (max:13 min:1) in family doctors group and $10,66 \pm 2,6$ in emergency medicine specialists group. The difference between the groups in terms of giving correct answers was significant. ($p < 0,0001$)

Our preliminary results clearly suggested that primary care doctors in Turkey are outdated in terms of CPR. A country-wide training seems to be necessary to correct this issue.

Keywords: primary care CPR training emergency

P-0356

After Trauma: Acute Appendicitis or Not?

Özden GÖKDEMİR¹, Eren Güzeloğlu², Nilgün Özçakar¹

¹Dokuz Eylül University, Medical Faculty, Family Medicine Department, İzmir, Turkey

²Dokuz Eylül University, Medical Faculty, Pediatrics Department, İzmir, Turkey

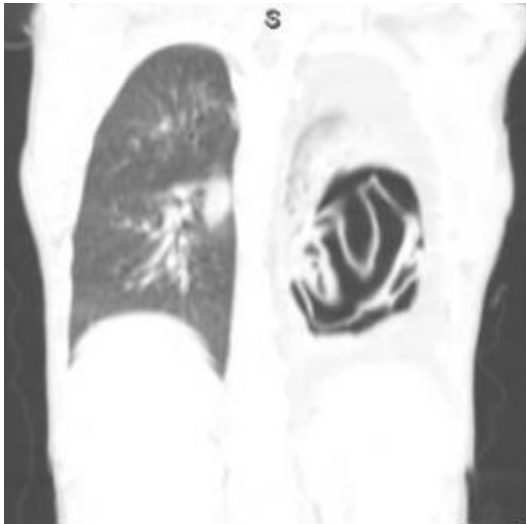
Appendicitis is the most common condition in children requiring emergency abdominal surgery. A successful outcome would be early diagnosis followed by appendectomy before gangrene or perforation develops. Older children and adolescents develop appendicitis more often than younger children. Their clinical features are similar to those seen in adults. Laboratory testing and imaging studies, primarily ultrasound and computed tomography or magnetic resonance imaging, are helpful adjuncts in selected children undergoing evaluation for appendicitis. One of the differential diagnosis is cystic lesions of the liver. This represents a heterogeneous group of disorders. Most liver cysts are found incidentally on imaging studies and tend to have a benign course. Larger cysts are more likely to be symptomatic and cause complications. The rupture into the peritoneal cavity or bile duct, infection or compression of the biliary tree are some of them. However cystic lesions could be lung lesions, too.

CASE: 15 year-old Caucasian boy has attended to the pediatrics emergency service because of his stomach ache. In history of patient; he was assaulted by a school friend 5 days ago and he had vomiting, abdominal pain for 3 days. He was suspected as appendicitis at another health center. Due to the trauma history of the patient; contrast-enhanced CT examination of the thorax and abdomen has been made. The findings were considered as the rupture of cystic hydatid. He was diagnosed as rupture of a lung hydatid cyst. There's no finding of acute pancreatitis.

CONCLUSION: "Acute abdomen" is a common reason to attend at health centers. To manage this paradigm is not only the response of emergency service health workers but also the GPs/FMs. The objective is to describe a patient with hydatidosis, who seemed to be acute pancreatitis and with a trauma history is the best way to manage the case to take patient history and physical examination.

Keywords: cyst hydatid, traumatic rupture, lung hydatid, acute abdomen

Thorax CT



The sections were evaluated with pulmonary parenchymal window, the long axis of the left lung lower lobe (craniocaudal) cystic membrane detachment in the air and about 10 cm measured changes in the structure and showed atelectasia. There's pleural effusion on the left hemithorax, reaching up to 3 cm thick at the widest part and in the basal segments was observed thickening of the pleura. The findings were evaluated primarily as cystic hydatid rupture. Pancreas, spleen, liver, both kidneys placement in the section of the abdominal parenchymal density levels were normal.

P-0357**Efficiency of management of urinary tract infections at a university hospital family medicine outpatient clinic**

Zehra Dağlı, Duygu Ilke Yıldırım, Ayşe Selda Tekiner, Ayşe Gülsen Ceyhun Peker, Mehmet Urgan
Department of Family Medicine, School of Medicine, Ankara University, Ankara, Turkey

OBJECTIVE: Urinary tract infection (UTI) is one of the most common bacterial infections that can be managed at primary care setting. The study aimed to determine whether the patients with pre-diagnosis of UTI were investigated and treated adequately at a university hospital family medicine outpatient clinic.

METHODS: Retrospective, descriptive, cross-sectional study included the patients who applied to Ankara University İbni Sina Hospital Family Medicine outpatient clinic and were pre-diagnosed for UTI for the first time between January 2013 and December 2014. Descriptive statistics were given as mean±standard deviation and percentage. Chi-square test was used for differences between the groups. Any $p < 0.05$ was considered statistically significant.

RESULTS: Mean age of 177 patients (10.7% male, 89.3% female) was 36.80 ± 17.70 years. Only 83.6% had symptoms. While the most common symptoms were dysuria (58.7%), nausea (22%), and frequency (14.6%), 32.7% of the patients had two or more symptoms. Blood, urine, and imaging tests were performed in 94.4%. The most common tests utilized were urine analysis (dipstick and microscopy) (93.2%), complete blood count (CBC) (57.6%), and urine culture (53.7%), and majority of the patients (79.6%) were investigated with two or more tests. Only comparisons between treatment choice and presence of symptoms, urine analysis results, and urine culture results were statistically significant. Of the patients with symptoms, 55.4% were treated with antibiotics, but 30.4% received no treatment ($p = 0.004$). Antibiotics were choice of treatment in 65.8% of the patients with urine analysis results indicating UTI, whereas 23.7% of those remained untreated ($p = 0.018$). While 81.5% of the patients with growth in urine cultures were treated with antibiotics, no treatment was given to 14.8% ($p = 0.018$).
CONCLUSION: The results of the study suggested that UTIs were managed quite efficiently. Yet, guidelines for UTIs should be followed carefully to treat the patients properly and to prevent emergence of resistance to antibiotics.

Keywords: urinary tract infection, management, primary care

P-0358**Neurological Side Effects Caused by Lithium Toxicity: A Case Report**

Esra Ceylan¹, Pınar Şen Gökçeimam², Mehmet Fatih Akdoğan³, Gül Babacan Abanonu³

¹Department of Family Medicine, Beyhekim State Hospital, Konya, Turkey

²Department of Psychiatry, Erenköy Training and Research Hospital for Psychiatry, Istanbul, Turkey

³Department of Internal Medicine, Haydarpaşa Numune Training and Research Hospital, Istanbul, Turkey

AIM: Lithium has been commonly used for the treatment of several mood disorders particularly bipolar disorder over the last 60 years. Lithium has been shown to accumulate especially in nerve cells; it is known that side effects occur at normal serum lithium levels even at non-therapeutic levels in the central nervous system. The aim is to emphasize the importance of diagnosing of neurological side effects of lithium in a 55-year-old female patient with a history of schizoaffective disorder.

CASE: A 55-year-old woman with 15-year history of schizoaffective disorder was staying in the nursing home for 6 years. The patient presenting to Haydarpaşa Numune Training and Research Hospital was taking lithium 600 mg/day, olanzapine 10 mg/day, chlorpromazine 100 mg/day due to general poor health and lack of oral intake for the last three days. The patient's physical examination revealed that vital signs were normal, but she opened her eyes briefly while calling but not willing to cooperate, had dehydration, significant rigidity and gearwheel. The laboratory examinations were as follows: creatinine; 1.23 mg/dL, creatinine clearance; 63.56 ml/min, uric acid 1.6 mg/dL. Liver, thyroid function tests, complete blood count, serum electrolytes, glucose, blood gases, creatine kinase (CK), CK-MB values were within normal limits. The patient had no acute pathologic findings on non-contrast-enhanced cranial computed tomography. ECG showed sinus rhythm and was within normal limits. Serum

lithium level was 2.21 mmol/L(Normal:0,6-1.2 mmol/L).We learned that she was not taking the drugs regularly prior to admission to our hospital.No growth was observed in urine, CSF, blood cultures.Lithium level decreased 0.05 mmol /L following treatment with 0.9% NaCl infusion and forced diuresis (4000 cc of saline daily).At discharge creatinine 0.58 mg/dL, creatinine clearance;113 ml/min, she had orientation and cooperation, and with no rigidity, gearwheel findings.Specialists in psychiatry diseases prescribed the drugs.
RESULT: Considering the frequent use of lithium, its adverse effects on the nervous system should not be ignored.

Keywords: Lithium, neurological side effects, intoxication

P-0359

Clinical Case - Are corticosteroids recommended in acute urticaria?

Maria Teresa Pereira Rodrigues Gaudêncio Silva¹, João Pedro Tomaz²

¹Maria Teresa Silva

²João Tomaz

Context: Antihistamines and intravenous corticosteroids (CC) are commonly used for preventing emergent episodes of acute urticaria symptoms such as anaphylaxis and laryngitis angioedema.

CASE: 81 years old male, married, in a nuclear middleclass family household, with clinical history of hypertension, dyslipidaemia, allergic rhinitis and benign prostatic hyperplasia. Medicated with acetylsalicylic acid, enalapril, esomeprazole, simvastatin; no known allergies. Came to consultation by the Family Physician due to maculopapular pruriginous rash on the torso; diagnosed as urticaria and medicated with intramuscular 200mg hydrocortisone and clemastine. On outpatient service, was medicated with ebastine administered twice a day. Returns to consultation 3 days later due to dissemination of urticary-like plaques, new edema on both hands and periorbital area, being referenced to appointment by dermatology; further medicated with 20mg prednisolone for 5 days and 25mg hydroxyzine which kept for over 2 weeks following the disappearance of symptoms.

DISCUSSION: Despite urticary being a frequent form of anaphylaxis (80% to 90% displaying skin manifestation) such situation is emergent but also rare and expectably related to immediate contact with the allergen (maximum up to 2 hours), being treated with adrenaline. Angioedem, may or may not present itself alongside urticaria, larynx angioedema being the most frequent. Acute urticaria usually presents a benign evolution, symptoms being controlled within 24 to 72 hours. Second generation antihistamines are the first line of treatment and dosage may be increased by 4 times the usual amount. Single dosage use of corticosteroids is often associated with exacerbation of initial urticaria symptoms (rebound effect), wich may have been the case in the clinical situation presented above. Such treatment must be reserved to situations of exacerbation, non-responsiveness to antihistamines or urticaria associated with angioedema and should only be applied over a very short period (3 to 7 days). Keywords: acute urticaria; corticosteroids

Patient's urticary-like plaques on the torso.



P-0360

Rare and interesting cause of acute coronary syndrome

Turyan Abdulhalikov¹, Hakan Akilli³, Ayşe Yilmazer², Tuncer Kılıç²

¹Department of Cardiology, Bilgi Tıp Merkezi, Ankara, Turkey

²Department of Family Medicine, Yıldırım Beyazıt Üniversitesi, Ankara, Turkey

³Department of Cardiology, Necmettin Erbakan Üniversitesi,

Acute coronary syndrome (ACS) is a life-threatening emergency. Kounis syndrome includes both severe allergic reactions and acute coronary syndrome.

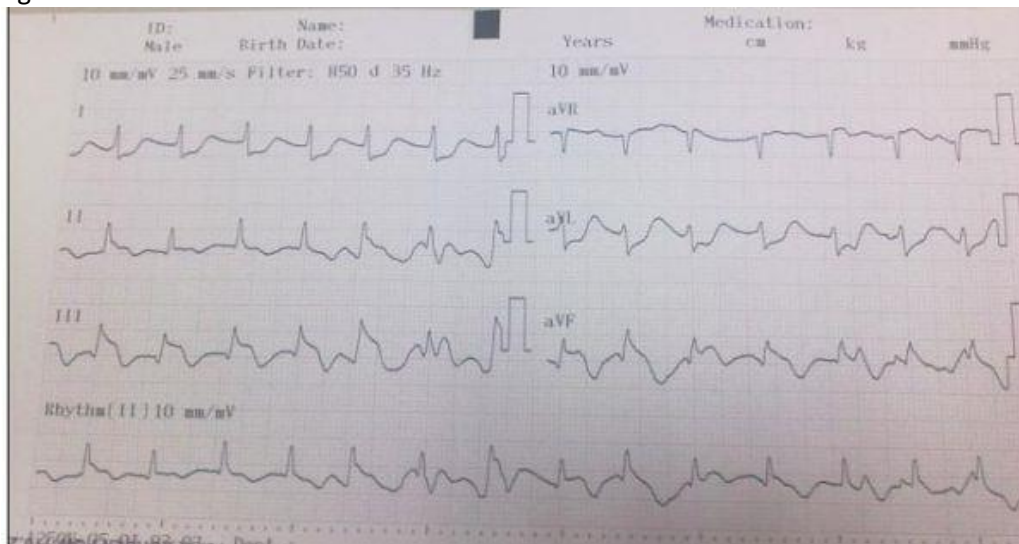
A 48-year-old gentleman admitted to the emergency department (E.D) with sudden cardiac arrest after a bee sting. He did not have any history of previous cardiovascular disease, and other major risk factors. At the E.D patient was intubated and lost consciousness. His systolic blood pressure was 65 mmHg. Immediately inotropes and fluid replacement were administered. An electrocardiogram revealing ST elevation in inferior leads and reciprocal depression (fig-1). In coronary angiography normal coronary arteries were observed (fig-2,3,4). After coronary imaging another cause of sudden cardiac arrest (such as acute aortic dissection, acute pulmonary embolism and intracranial hemorrhage) were excluded. Several days later patient died due to lactic acidosis and multi-organ failure.

There are no uniform guidelines in this syndrome and all data were derived from case reports and personal experiences. Two types of Kounis syndrome are present. Kounis syndrome is a manifestation of endothelial dysfunction due to severe coronary vasospasm. Aspirin should be administered to all patients with ACS but unfortunately it may cause allergic reactions and induce anaphylaxis. Therefore the utility of aspirin in Kounis syndrome is uncertain. If it is not contraindicated an oral beta-blocker should be administered. Coronary spasm is very responsive to calcium channel blockers so in Kounis syndrome they may be first-line when an anti-ischemic drug is needed. In the absence of contraindications nitrates are recommended for persistent ischemia. In ACS heparins are indicated but both can cause allergic reactions. The management of anaphylaxis in ACS patients is another challenging problem. Fluid replacement is essential in the treatment of anaphylaxis. In ACS, severe left ventricular dysfunction may be possible so volume overload must be avoided.

Finally, more investigation is needed for the treatment of this situation.

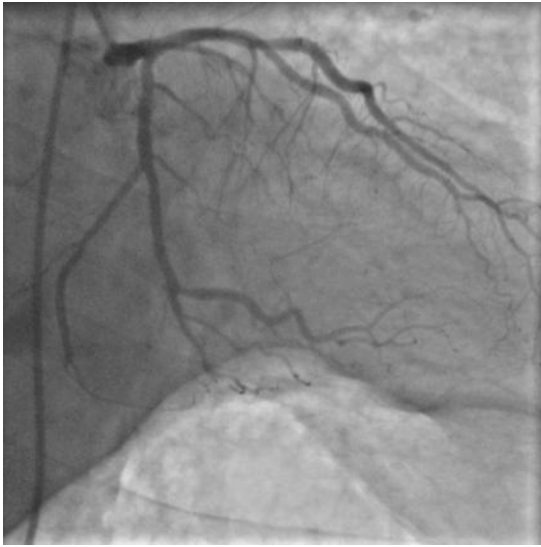
Keywords: Kounis syndrome, acute coronary syndrome, bee sting

figure 1



ECG in emergency department

figure2



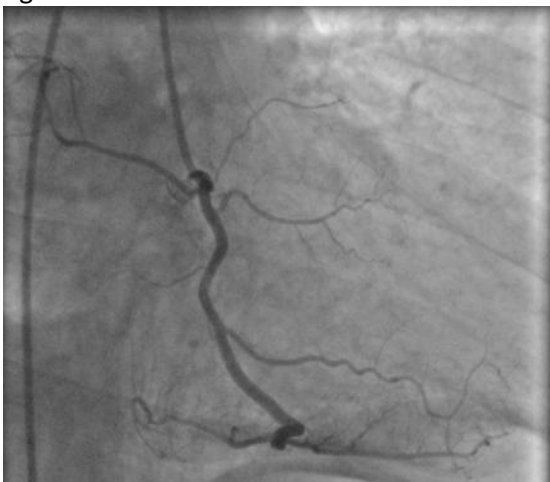
no occlusive lesion in left system

figure3



no occlusive disease in right coronary artery

figure4



normal RCA

P-0361

MERS VIRUS and UMRAH VISIT

Kubra Uyar, Rana Gundogan, Nilgun Ozcakar
dokuz eylul university, department of family medicine

Introduction and OBJECTIVE: Corona virus family is major pathogens of human and animals. Mers virus, a member of this family is cause of 1/3 of community acquired upper respiratory diseases and possible causes of severe respiratory disease in both adult and children. Virus source is not exactly known but some assumptions about bat and camels. Diseases caused by virus have usually seen in Saudi Arabia, Qatar, Jordan and United Arab Emirates. Incubation period is 9-12 days and shows similar symptomatology with upper and lower respiratory tract infections: fever, cough, respiratory distress, sore throat.

Laboratory: pancytopenia, elevated ALT, AST, urea, creatinin and LDH levels. In almost all cases radiology is varying minimal lesions to large pathologies: increased bronchovascular image, opacities in the airways, reticulonodular shadows.

CASE: 23 year old female patient was admitted to emergency with cough, sweating, weakness, sore throat and respiratory distress. Patient's vital FINDINGS: Blood pressure: 130/85 mmHg, heart rate: 86/min, body temperature: 38°C, O₂ saturation: 96%. In detailed history learnt that she returned from a visit to Umrah 3 days ago. Complaints have started 4 days before and painkillers didn't make any decline in complaints.

Pharynx was hyperemic, tonsils were hypertrophic and there were bilateral crackles in both lower zones.

Hb: 13,7 g/dl WBC: 15x10³/mm³, Plt: 230x10³/mm³, CRP: 65. Liver enzymes, urea-creatinin and serum electrolyte levels were normal. In chest X-ray there were paracardiac infiltrations. Consulted by infectious disease department, pre-diagnose of Mers virus infection. Infectious disease department decided to take endotracheal aspirate, sputum samples and received disease pursuit.

Discussion and RESULTS: Upper and lower respiratory tract infections takes priority among the reasons to refer primary care physicians. Fever, cough, fatigue, sore throat symptoms are initial symptoms of respiratory infections but underlying disease can occur with similar symptoms. Family physicians should evaluate each patient taking their detailed history. Infectious diseases which have high mortality should firstly followed by family physicians before a specialist!

Keywords: mers virüs, umrah visit, upper respiratory tract infection

P-0362

Anaphylaxis related to bee sitting

Ahmet Ünal¹, Ayşe Yenigün², Faruk Demir²

¹Department of Family Medicine, Adnan Menderes University, Aydın, Turkey

²Department of Pediatric Allergy and Immunology, Adnan Menderes University, Aydın, Turkey

INTRODUCTION

Anaphylaxis is a life threatening reaction that occurs in between 0.05 to 2% of the general population. It is estimated to cause death in 1 to 3 per million people. Pathophysiologically, it is mediated by substances released systemically during mast cell and basophil degranulation, which cause increased vascular permeability, tachycardia, bronchospasm, pruritus, rhinorrhea, vasodilation, hypotension, flushing and headache.

CASE REPORT

We report the case of a 8-year-old girl who developed anaphylaxis after bee sting. The patient has spring allergies, and no family history of allergic disease. She has under the eye edema at 30 minutes later bee sitting. In the other hospital, dexamethasone and pheniramine was injected to patient.

On examination, extremities were cool, and there was an urticarial rash involving the lower limbs. His heart rate was 108 bpm and regular, his blood pressure was 100/60 mm Hg and his respiratory rate was 28/min.

Auscultation reveals bilateral diminished sibilant rhonchi. Physical examination was otherwise unremarkable. Laboratory investigations revealed elevated erythrocyte sedimentation rate (ESR) (42 mm, normal range 0-20 mm) with normal full blood count and serum biochemistry. Chest x-ray and electrocardiogram (ECG) were

normal.

A diagnosis of anaphylaxis was then made. The patient was treated with IV fluid, steroids, antihistamines and IM epinephrine. The patient was discharged from the hospital 5 days after hospitalization.

CONCLUSION

Anaphylaxis can present with similar features to other life-threatening medical emergencies with the cardinal features of hemodynamic compromise, cardiac dysfunction and hypoxia, as well as abnormal investigation results. Careful clinical assessment is important so that appropriate treatment can be instituted promptly to avoid further morbidity and mortality. Epinephrine is the first and most important treatment for anaphylaxis; considering its relative safety, when in doubt, epinephrine should be administered.

Keywords: Anaphylaxis, bee sitting, hypersensitivity, primary care

P-0363

Bullous Erythema Ab Igne: A case report

Ömer Göcen¹, İsa An², Hamza Aslanhan¹, Vasfiye Demir¹

¹Department of Family Medicine, Dicle University, Diyarbakır, Turkey

²Department of Dermatology and Venereal Diseases, Dicle University, Diyarbakır, Turkey

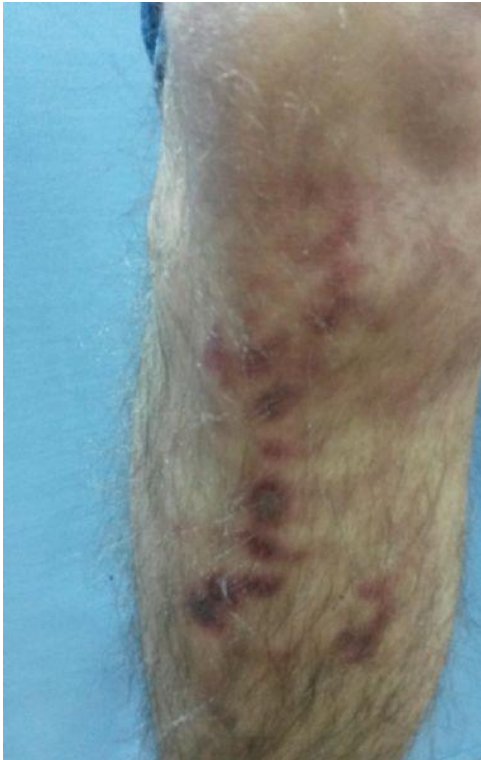
INTRODUCTION: Erythema Ab Igne (EAI) is a cutaneous, macular dermatosis caused by chronic and repeated exposure to heat which initially presents with erythema and telangiectasia and later develops a reticular pigmentation which is also precancerous. EAI is associated with chronic use of hearths, stoves, hot water bottles, electric blankets, and laptop computers. We present a case with bullous erythema ab igne caused by the use of electric heaters.

CASE: A 19-year-old man presented to the family physician with a brown discoloration skin with several bullae on the right leg existing for 15 days. The patient had no history of chronic disease and drug use. He had used an electric heater for heating his legs for over 1 hour each day over the last two months. The patient was consulted to Dermatology and the examination revealed multiple hyperpigmented brown regions with a reticular, livedoid appearance and bullous lesions on the anterior surface of the right leg (Figure 1). Laboratory examinations were normal. Punch biopsy was performed on the lesions. Mild atrophy in epidermis, vacuolar alteration at the basal layer, and mononuclear cell infiltration in the upper dermis and the patient was diagnosed as having bullous erythema ab igne. No treatment was performed and the patient was only followed up.

DISCUSSION: EAI is a dermatosis caused by long-term and chronic exposure to heat which can present as pigmented, reticular and also telangiectasic. EAI is more common in patients with hypothyroidism; however, the association of EAI with systemic diseases remains unknown. EAI is easily diagnosed due to its characteristic clinical manifestations. The lesions in EAI are often asymptomatic and rarely bullae occur on the lesions. The development of Merkel cellular carcinoma or squamous cell carcinoma is the most important complication. Common treatment includes hydroquinone, topical steroids, topical retinoids, and Nd:YAG laser.

Keywords: ab, erythema, igne

Figure 1



Hyperpigmented brown regions with a reticular and livedoid appearance and bullous lesions on the anterior surface of the right leg

P-0364

A Case: Paraquat (Pesticide) and Skin Involvement

Bahadır Yazıcıoğlu, Füsün Ayşin Artıran İğde

Department of Family Medicine, Faculty of Medicine, Ondokuz Mayıs University, Samsun, Turkey

Introduction

Pesticides are chemical materials used in order to destroy or decrease the harmful effects of creatures such as insects, weeds, fungi and rodents which survive in and around the human habitat and decrease the nutritional value of agricultural nutritional sources or harm them. Paraquat is a pesticide which was started to be used in agriculture and gardening around the world since the middle of 1960's and considered industrially safe. Paraquat taken in the body mostly orally and transdermal, inhalation and although rarely intravenous way is a dipyridinium compound which may cause poisoning. It causes erythema, swelling and ulceration on the skin.

Case

Erythema, itching, swelling and bullae with exudative discharge in almost all of the left foot and leg was observed in a 56 year old man for fifteen days. On the day his complaints started, he used agricultural pesticide while it was raining. The erythema in his left ankle started to spread upwards toward his knee in 2-3 days. His itching became very intensive.

The patient was in a good general condition. Significant amount of edema, hemorrhagic erythema and burst bullae were present under the left knee. The patient was put on bed rest. Left leg elevation and ice compress for 15 minutes at least two times a day was given in order to decrease edema. Consultation was made with dermatology department and steroid treatment was given in order to decrease inflammatory effect. Topical and systemic anti-biotherapy was started. Hemorrhagic lesions started to scab on the third days after resting and treatment were started. The cure was completed in two weeks.

Discussion

Paraquat taken in the body mostly orally and transdermal, inhalation and although rarely intravenous way. Especially learning the exposure way by anamnesis and providing an anti-inflammatory and symptom-based treatment would be appropriate for these patients.

Keywords: Pesticide, Paraquat, Skin Involvement, Allergy

Skin Lesions



P-0365

Sudden cardiac arrest, Long QT syndrome, Arrhythmia

Ahmet Ünal¹, Semiha Terlemez², Ebru Ataş Aslan³, Deniz İncaman¹, Yasin Bulut³

¹Department of Family Medicine, Adnan Menderes University, Aydın, Turkey

²Department of Pediatric Cardiology, Adnan Menderes University, Aydın, Turkey

³Department of Pediatrics, Adnan Menderes University, Aydın, Turkey

INTRODUCTION

Sudden cardiac arrest, sudden finish or stoppage of the heart's pumping function. The most common cause of sudden cardiac arrest in children; acute myocarditis, cardiomyopathy, cyanotic and non-cyanotic congenital heart disease, valvular heart disease, congenital complete heart block, Wolf-Parkinson-White syndrome, long QT syndrome, Marfan syndrome, coronary artery disease. We present our experience applying returned with cardiopulmonary resuscitation (CPR) from a 12-year-old patient, who is here with no known health problems before.

CASE REPORT

When entered the room in the morning by the family of our patient, has been noticed that his breathing and 112 emergency medical services were sought. Patient is diagnosed as pulseless cardiac arrest and applied CPR. In our hospital, he turned sinus rhythm into 30-minute emergency resuscitation results. Glasgow Coma Scale score is 8, patients in neurological assessment; pupillary regular, bilateral and corneal light reflex. Unable to retrieve the patient's deep tendon reflexes, Babinski were negative on the and right positive on the left. Cranial magnetic resonance imaging (MRI) and diffusion MRI of the brain was normal. It is not a disease known prior to our patients, not drug use, had learned that exposure to pesticides. After cardiac arrest that may cause respiratory and neurological causes were excluded focused on cardiac causes. Echocardiography was normal. When questioned in terms of long QT syndrome, deafness and in patients with a history of syncope, there was no family history of sudden cardiac death. But it is in the patient's ECG electronically calculated QTc0,36 Bazzet state formula calculating the QTc intervals were calculated with 0,54. Other ECG findings, normal sinus rhythm, heart hızı 112/min, PR: 0,12 sec QRS was evaluated as 0,06 sec. Because patients with a history of drug use that could

cause QT interval length and head trauma, congenital long QT syndrome was not considered. The patient's laboratory values were normal value except (table-1). High-dose β -blocker therapy was started to patient. The patient was referred to another hospital and ICD fitted. The patient's mother in the long QT (QTc490ms) were, β -blocker therapy was started.

CONCLUSION

Should be seen firstly electrocardiogram of patients by us, that sudden presenting cardiac arrest and syncope, must be evaluated in terms of long QT syndrome. QTc should be calculated with Bazzet formula (QT/VR) for an accurate diagnosis.

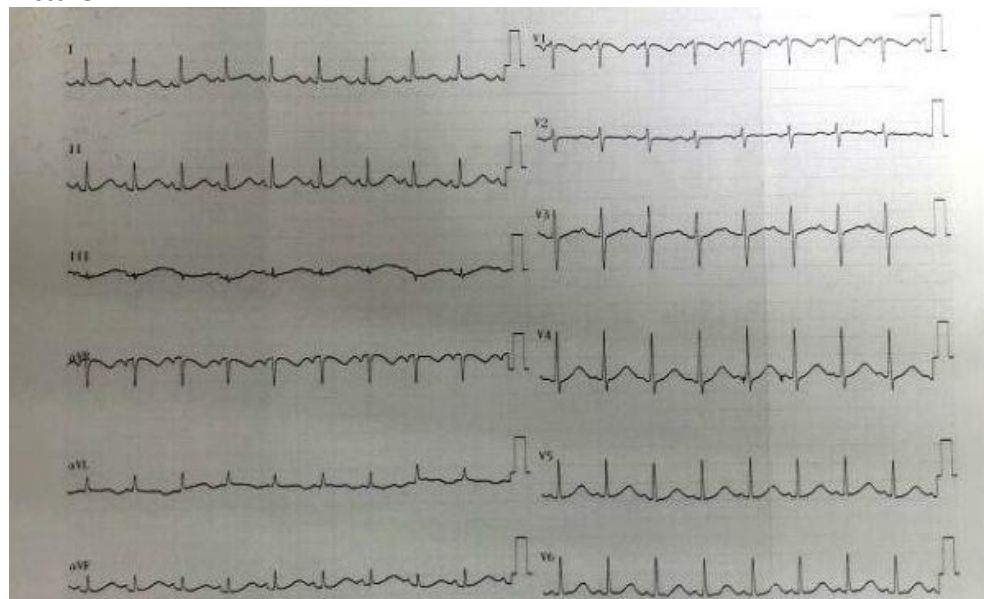
Keywords: Sudden cardiac arrest, Long QT syndrome, Arrhythmia

Table-1

Hemoglobin	13,7 gr/dL
Leukocyte	27960 10 ³ /mkrL
Platelet	465000 10 ³ /mkrL
Uric acid	9,2 mg/dL (2,6-6)
Magnesium	1,87 mg/dL (1,9-2,6)
Alanine transaminase	196 U/L (0-55)
Aspartate transaminase	206 U/L (5-34)
Alkaline Phosphatase	178 U/L (40-150)
Lactate Dehydrogenase	702 U/L (125-243)
Troponin I	2,557 ng/mL (0-0,08)
Myoglobin	370,1 ng/mL (0-146,9)

Anormal labaratuvar bulguları
Abnormal laboratory findings

Picture-1



Electrocardiography

P-0366

Severe hypoalbuminemia in two pediatric cases with parapneumonic pleural effusion

Mahir İğde¹, Banu Gülcan Öksüz², Levent Üstün³, Onur Öztürk⁴

¹Samsun Education and Research Hospital, Department of Pediatric Allergy and Immunology, Samsun, TURKEY

²Samsun Education and Research Hospital, Department of Pediatrics, Samsun, TURKEY

³Samsun Maternity and Children's Hospital, Department of Pediatric Surgery, Samsun, TURKEY

⁴Atakum Community Health Center Samsun, Samsun, Turkey

Serious Hypoalbuminemia Detected in Two 8 and 9 year old Child Cases with different degrees of Parapneumonic Pleural Effusion were covered in this study. In the clinical complaints of the patients, a dramatic recovery was observed after albumin treatment.

Case 1

An eight year old male patient was taken to the hospital with breathing difficulty, fever and coughing complaints. There was a decrease in pulmonary auscultation. C-reactive protein (CRP) level was 38.2 mg/dl and erythrocyte sedimentation level was detected as (ESR) 40 mm/h. Oxygen, IV vancomycin and ceftriaxone were given to the patient. Parapneumonic consolidation and pleural effusion were detected in thoracic usg pulmonary CT and chest tube was located. The albumin level in the liquid taken was measured 2.2 g/dl and serum albumin level was measured 3.2 g/dl. On the eighth day, the albumin level decreased to 1.7 g/dl and on the tenth day, 1 g/kg IV albumin was replaced. The level increased to 2.6 g/dl and a dramatic decrease was observed in pleural collection in the follow-up and the patient whose complaints were over was discharged on the 15th day.

Case 2

A 9 year old male patient was presented with fever, cough, breathing difficulty and chest pain. Pulmonary auscultation had decreased. ESR 70 mm/h and CRP level was determined as 46.9 mg/dl. In thoracic usg, parapneumonic consolidation and pleural effusion were observed and thoracentesis was applied. IV vancomycin and ceftriaxone were started. Serum albumin levels were found 2.0 g/dl on second and third days. 1 g/kg IV albumin was replaced daily on the fourth day. The patient who had a dramatic recovery in clinical findings was discharged on the 14th day.

As albumin treatment effectivity was observed in this study, it was considered as a good parameter in the related disease follow-up.

Keywords: Hypoalbuminemia, Pleural effusion, Child

P-0367

Clinical Results and the Gait Parameters after Total Hip Arthroplasty Surgery

Ahmet Yıldırım¹, Selçuk Bölükbaşı¹, Erdiñç Esen¹, Ulunay Kanatlı¹, Duygu İlke Yıldırım²

¹Gazi University Medical School Orthopaedics and Traumatology Department

²Selçuk University Medical School Family Medicine Department

We were looking for the clinical results and the differences at the patients who had unilateral total hip arthroplasty surgery with two different lateral surgical approaches. We analyze three different parameters between the patients; first, the plantar pressures by the help of dynamic pedobarography, second Trendelenburg's sign and third cilnical results by Harris hip score.

We selected 28 patients who had been operated in our clinic; Gazi University Faculty of Medicine, Department of Orthopaedics

and Traumatology. Plantar pressures have maesured by EMED-SF pedobarography device; that seperates the foot to the four different parts which are called masks. Trendelenburg's sign has been estimated as grade 1 and grade 2 by the method which was described by Hardcastle and Nade. Clinical outcome was measured by comparing Harris Hip Scores pre-operatively and at last clinic visit. All the parameters were compared as preoperatively and postoperatively at the sixth month. SPSS 15.0 was used to analyze the results.

In both groups after the six months from the surgery; total contact time has increased at the operation side when the results were compared before the surgery at the same side and at the other side after the surgey. Also when we looked at the first and second masks which show the significant part of the stance phase; contact areas have

similarly increased and the changes at the peak pressures were similar as contact areas.

For whole the patients the average preoperative Harris hip score was 41,50 points. At the time of the last visit, the average Harris hip score was found as 86,68 points.

The functional and clinical early results are similar in both when superior gluteal nerve protection, conjoint tendon repair and postoperative rehabilitation have done well. Pedobarography is an effective, cheap and easy way to analyse the changes at the hip muscles.

Keywords: Total hip arthroplasty, pedobarography, Trendelenburg's sign, Harris hip score, gait analyses

P-0368

Migraine and Puberty

Nevruz Yıldırım, Hakan Demirci, Beyza Demirbaş, Mehtap Gömleksiz

Department of Family Medicine, Sevket Yılmaz Training and Research Hospital, Bursa, Turkey

Background

Migraine is an important public health problem, especially for the young people. Its frequency is high and it causes disability and loss of performance. In this study, our aim was to examine relationship between migraine headaches and puberty among school age children in rural part of Bursa.

Methods

In this cross-sectional study, study population was composed of students attending primary school in rural part of Bursa. There were 544 students participated for the study, of these 270 students were female and 274 were male. Participants who had two or more headaches in the last 3 months formed the headache group. Afterwards, ID-Migraine™ test was asked to the students in the headache group. Presence of puberty was examined for all the children.

Results

The mean age of the participants were 9.57 ± 2.12 (6-14 years). There were 68 (12.27 %) students suffered from headache of any time in last three months. Migraine-type headache was detected in 12 subjects (2.2%) based on the ID-Migraine™ test. Of the migraine group, six were male (50%) and six were female (50%) as well. Puberty did not affect the frequency of migraine in the study group ($p=0.77$).

Conclusions

Migraine prevalence in the study group was 2.2%. This result is low compared to the previous studies in the literature. Migraine is not affected from puberty. Up to 82% of headaches in children is not migraine type and the etiologies of headaches in the non migraine group should be identified.

Keywords: migraine, puberty, headache, gender, rural

P-0369**Hypertension among primary school children at high altitude**

Ali Candar, Hakan Demirci, Yakup Akpınar, Fatih Çiftçi, Hayri Bozkurt

Department of family Medicine, Sevket Yilmaz Training and Research Hospital, Bursa, Turkey

AIM:

Hypertension is an independent risk factor for cardiovascular disease. It is known that essential hypertension begins at a very early age. Recently, there have been reports of an increase in childhood hypertension, which has been attributed to an increase in the prevalence of childhood obesity. It is also known that high altitude is related with high blood pressure. In this study, we aimed to investigate the frequency of asymptomatic hypertension among children living in Buyukorhan district located at 850 meters high.

METHODS:

Two hundred twenty eight children living in Buyukorhan district were enrolled in this study. Blood pressure measurements were performed in two separate visits and average results were calculated. The average blood pressure results were evaluated according to the fourth report criteria. Body mass index (BMI) was calculated as weight/height² (kg/m²). Neck circumference measurements were performed.

RESULTS:

Twenty five children (10.9%) out of 228 were determined to be hypertensive. Among them only four children were male (16%). Gender distribution showed a statistically significant difference ($p=0.004$). There were 10 children diagnosed as pre-hypertensive. BMI was statistically significantly higher ($p=0.007$) among hypertensive children (17.73 ± 3.3) compared to normal subjects (16.09 ± 2.12). The average neck circumference in hypertensive children was 27.4 ± 2.19 cm and it was 26.59 ± 1.73 cm in normal children ($p=0.016$).

CONCLUSIONS:

The frequency of hypertension is high among school-age children living in high altitude in Turkey. There is a female predominance in hypertension. Both BMI and neck circumference were higher in children with hypertension.

Keywords: High altitude, hypertension (high blood pressure), paediatrics, primary care, public health.

P-0370**Analysis of accidents among children which occur in one region of Spain**

Maria Jose Agueros Fernandez¹, Alvaro Perez Martin², Jose Ignacio Gutierrez Revilla³, Jose Ramon Lopez Lanza⁴, Alfredo Avellaneda Fernandez⁵, Maravillas Izquierdo Martinez⁵, Maria Jose Diaz Gago¹, Cecilia Traspuesto Pascual², Isabel Muñoz Franco², Maria Antonia Gandara Revuelta¹, Flora Perez Hernandez³, Rocio Lopez Videras⁴

¹Primary Health Center Zapaton. Torrelavega. Spain

²Primary Health Center Centro. Santander. Spain

³Primary Health Gerencia

⁴Primary Health Center Alisal. Santander. Spain

⁵Primary Health Center Los Carmenes. Madrid. Spain

Background & AIM: To establish the profile of accidents among children in one region of Spain.

METHOD: Analysis of the diagnoses of all the emergency cases given by the pediatric emergency service at the most famous hospital in the Autonomous Community, over the period from November 2012 and April 2013. The diagnoses given by the emergency service of children between the ages of 0–15 were analysed.

RESULTS: 4801 accidents were attended to, 19.3% of the total number (24874 pediatric emergencies). If we classify the types of accident, 77.4% were traumas, 12.66% were injuries caused by sharp objects, 4.76% were the extraction of foreign objects, 1.53% were poisonings, 1.48% were injuries caused by domestic pets, 0.93% were burns, and 0.87% were traffic accident injuries. April (21.3%) and March (19.3%) were the months with the highest number of incidents, and Friday (14.9%), Monday (14.58%) and Tuesday (14.35%) were the days with the highest number of incidents, and there were no significant differences when analysing the month or the day when the accident took place. 43% of the accidents involved children under the age of 6. 2.51% of the accidents required hospital admission.

CONCLUSION: Accidents involving children comprise a high percentage of pediatric emergencies. Most cases are traumas. There is not a higher incidence at weekends. Few cases require hospital admission.

Keywords: accidents, children, emergencies

P-0371

The Heterozygote Mutation of Glukose 6 Phospate Dehydrogenase İn The Three Case of Girls That Have Acute Hemolytic Crisis [G6pd Med;563c>T (P.Ser188phe)]

Ebru Yılmaz Keskin¹, Sema Çetin Ayhan², Celeste Bento³, Leticia Ribeiro³

¹Paediatric Haematology and Oncology, Samsun Training and Research Hospital, Samsun, Turkey

²Department of Family Medicine, 19 Mayıs University, Samsun, Turkey

³Haematologia, EPE, Centro Hospitalar de Coimbra, Coimbra, Portugal

INTRODUCTION: Glucose 6-phospate Dehydrogenase (G6PD) deficiency is one of the most frequent form of erythrocyte enzyme disorders. Clinic symptoms are ocured oxidative stress in erythrocyte. The most common symptom of G6PD deficiency is acute haemolytic anaemia. Clinical signs are seen in more hemizygous males because the encoding gene of G6PD is on the X chromosome. The clinical findings in homozygous girls is similar to hemizygotous males in areas of high prevalence. However, clinical signs may be seen in some heterozygous girls depending on the lack of cell population. (Lyon hypothesis)

CASE: Three daughters collected from two unrelated families (aged 2, 5 and 8) applied complaints with abdominal pain, nausea, vomiting, pallor, yellowing of the skin and removing cola-colored urine. Every three children had a history of eating beans two days before of the complaints. It was learnt that these complaints previously appeared two times in aged years of 5 and 8 siblings descended from Iraq. However, it was not though that the reason was the G6PD deficiency because the test of G6PD deficiency was resulted negatively. Normocytic anemia (haemoglobin 7.0, 6.9, 9.4 g/dl), unconjugated hyperbilirubinemia, haemoglobinuria were seen in the laboratory findings of patients who initiated treatment. Direct Coombs test was negative. One times erythrocyte suspension was given to only one patient. In the monitoring, symptoms were improved in all cases. The requested screening test for G6PD deficiency was also negative in the 2-year-old patient. However, the results of molecular analysis in three cases, G6PD Med; 563C>T(p.Ser188Phe) mutation was found to be heterozygous.

Result-DISCUSSION: G6PD deficiency is hereditary transmission based on X sothat the test of G6PD deficiency is usually found to be negative in heterozygoute girls. Quantitative determination of G6PD levels and / or the analysis of mutation may confirm the diagnosis in girls that have typical stories and clinical findings.

Keywords: G6PD deficiency, acute hemolysis

Tablo 1: The laboratory findings of G6PD screening and mutation analysis results for all three girls' cases

	Age (year)	Hb (g/dl)	MCV (fl)	Qualitative G6PD deficiency test	G6PD mutation analysis
Case 1	2	7,0	81,3	Deficiency is not seen.	Heterozygous G6PD Med; 563C>T (p.Ser188Phe)
Case 2	5	6,9*	92,0	Deficiency is not seen.	Heterozygous G6PD Med; 563C>T (p.Ser188Phe)
Case 3	8	9,4	89,3	Deficiency is not seen.	Heterozygous G6PD Med; 563C>T (p.Ser188Phe)

*Patients received transfusions of red blood cell concentrates.

Tablo 2: Intra-erythrocyte G6PD levels in various clinical situations

Clinical case	Sex	Results of screening test	G6PD level	Assessments
Normal	E or K	Normal	8,1	Normal
Normal	E	Abnormal	0,4	G6PD deficiency, stable state

Normal	K	Abnormal	2,1	Heterozygous G6PD deficiency
Normal	K	Normal	4,9	Heterozygous G6PD deficiency
Acute haemolysis	E	Abnormal	2,3	G6PD deficiency in male AHK
Acute haemolysis	K	Normal	7,2	G6PD deficiency in female AHK
Chronic haemolysis	E	Normal	15,5	Unrelated haemolysis with G6PD deficiency
Chronic haemolysis	E	Abnormal	1,4	KNSHA; possible reason is GPDP deficiency

AHK, acute haemolytic crisis; KNSHA, nonsferositik congenital haemolytic anemia

P-0372

A case of Prepubertal Extragenital Lichen Sclerosus et Atrophicus

Adem Parlak¹, Nehir Parlak², Yusuf Emrah Eyi³, Salim Ozenc⁴

¹Department of Family Medicine, President Guard Regimen, Ankara, Turkey

²Department of Dermatology, Etimesgut Public Hospital, Ankara, Turkey

³Department of Emergency Medicine, President Guard Regimen, Ankara, Turkey

⁴Department of Family Medicine, Diyarbakır Military Hospital, Diyarbakır, Turkey

INTRODUCTION: Lichen sclerosus is a chronic inflammatory dermatosis that results in white plaques with epidermal atrophy and scarring. Lichen sclerosus has both genital and extragenital presentations and also goes by the names lichen sclerosus et atrophicus, balanitis xerotica obliterans and kraurosis vulvae. An increased risk of squamous cell carcinoma may exist in genital disease, but the precise increase in risk and what cofactors (human papillomavirus infection or prior radiotherapy) may be involved are not yet completely defined. Lichen sclerosus et Atrophicus usually affects the genital area of postmenopausal women between ages 40 and 60 years. There are extragenital forms of the disease with a prevalence of 15% to 20%. Such presentations are unusual in children (only 5%-9% of cases) and a challenge to treat. We report herein a 10 year old patient with Lichen Sclerosus et Atrophicus.

CASE: 10-year-old girl presented with a 2 -month history of a asymptomatic, whitish, crinkled, shiny and atrophic plaques surrounded by eritematous halo on her posterior neck, back, abdomen and malleol of left foot. A biopsy revealed lichen sclerosus

CONCLUSION: Inpatient care generally is not required unless for surgery for malignancy or to relieve urinary obstruction is planned. If potent topical steroids are to be used, regular follow-up is required to monitor for the occurrence of steroid atrophy. Monitor female lichen sclerosus patients for any sign of secondary or associated genital malignancy. Extragenital cases require no specific follow-up.

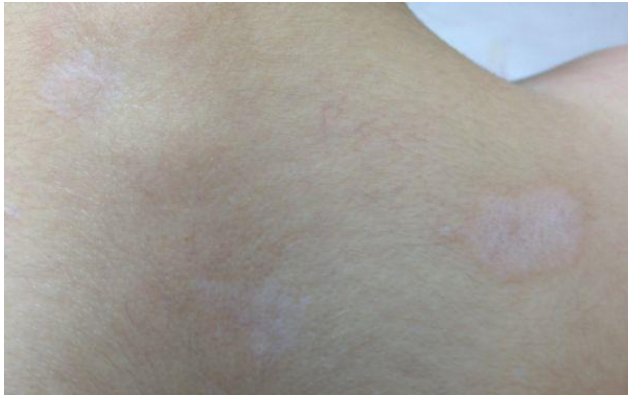
Keywords: Prepubertal, Extragenital, Lichen Sclerosus et Atrophicus

Figure 1. Extragenital Lichen Sclerosus et Atrophicus



Whitish, crinkled, shiny and atrophic plaques surrounded by eritematous halo on her malleol of left foot

Figure 2. Extragenital Lichen Sclerosus et Atrophicus



Whitish, crinkled, shiny and atrophic plaques surrounded by erythematous halo on her posterior neck

P-0373

Infantile Acne: report of three cases

Adem Parlak¹, Nehir Parlak², Salim Özenç³, Yusuf Emrah Eyi⁴

¹Department of Family Medicine, President Guard Regiment, Ankara, Turkey

²Department of Dermatology, Etimesgut Public Hospital, Ankara, Turkey

³Department of Family Medicine, Diyarbakır Military Medicine, Diyarbakır, Turkey

⁴Department of Emergency Medicine, President Guard Regiment, Ankara, Turkey

INTRODUCTION: Infantile acne is a rare inflammatory dermatosis that usually starts at the age of 1 to 16 months and may lead to scarring. It persists throughout infancy and occurs mainly on the cheeks and sometimes the forehead and chin, and its morphology includes all typical elements of acne, including comedo, papules, pustules and even cysts. It is more common in boys and is usually mild to moderate in severity. In most children it settles down within a few months.

Case 1: 30-month-old presented to our department with a history of comedones, papules, and pustules on the cheeks since the age of 6 months.

Case 2: A healthy boy presented with an infantile acne with inflammatory nodules, and cysts, ice-pick scars on the cheeks.

Case 3: A 2-year-old boy presented with a 3-month history facial papules on the cheeks. None of the patients had other signs of androgenization or systemic disease. There was no clinical evidence of androgen excess and this was not further investigated.

CONCLUSION: The most common course of treatment for infantile acne is the "wait it out" approach. Since most cases of infantile acne clear up without treatment this is probably what your family physician will recommend, especially if acne is mild. If acne is more severe, or if it's leaving scars, your baby may be prescribed an acne treatment to help get it under control. Actual treatment usually consists of gently cleansing the skin and treating it with topical agents. Only rarely, in very severe cases, are antibiotics or isotretinoin prescribed. Therapy is required for as long as the acne persists. As in adolescent and adult acne, any underlying condition must also be treated.

Keywords: Infant, acne, dermatology

Figure 1. Infantile acne



Comedones, papules, and pustules on the cheeks

Figure 2. Infantile acne



Inflammatory nodules, and cysts, ice-pick scars on the cheeks.

Figure 3. Infantile acne



Facial papules on the cheeks

P-0374

Treatment differences among several family medical centers in Vilnius in children with acute tonsillitis

Indrė Baužienė¹, Veronika Sruogaitė¹, Kazys Simanauskas¹, Eglė Simanauskienė²

¹Faculty of Medicine, Vilnius University, Lithuania

²Children’s Hospital, Affiliate of Vilnius University Hospital Santariskiu Klinikos

Objective. Acute pharyngotonsillitis is one of the most common infections encountered by pediatricians and general practitioners. The aim of the research is to analyze differences of treatment in children with acute tonsillitis among several family medical centers in Vilnius.

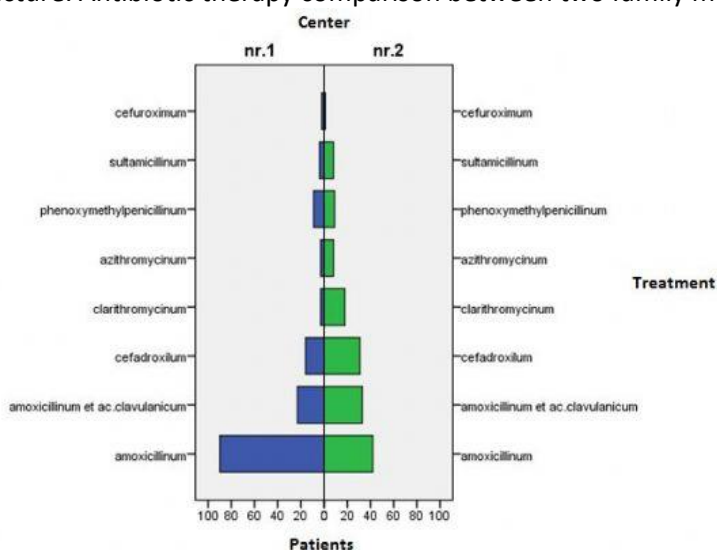
Materials and methods. A retrospective study comprising 300 children in two Vilnius primary health care centers was undertaken to assess the treatment differences among centers. A statistical analysis was done and the significance assessed by a X-square test. The statistical difference was considered significant if the p value was below 0.05.

Results. Both family medical’s center’s doctors as a first-line treatment phenoxymethylpenicillin appointed only 17 (5.66%) and usually both centers selected amoxicillinum 131 (43.6%) and amoxicillinum et acidum clavulanicum 56 (18,66%). Reserve antibiotics atypical agents - as Clarithromycinum center of No. 1 was appointed to three (2%) children in the center of No. 2-18 (12%) of children in the center No.1 Azithromycinum 4 (2.66%), the center no. 2 -9 (6%).

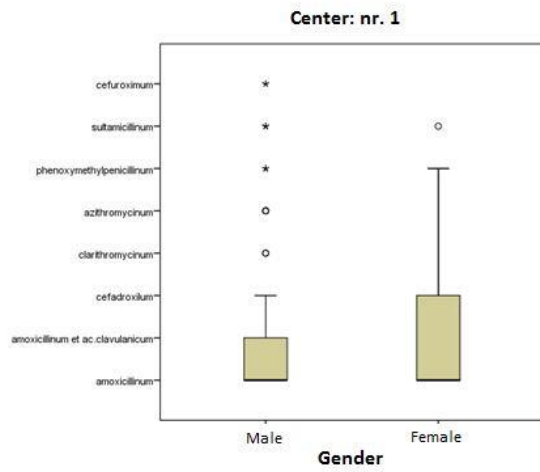
Conclusions. According to our a study general practitioners prescribe antibiotics solely to the symptoms (high fever, increased strangles lymph nodes, sore throat, hyperaemic, hypertrophic tonsils), without making the Strep test or culture of the tonsils, or common blood test, in most cases.

Keywords: acute tonsillitis, treatment differences, general practitioners.

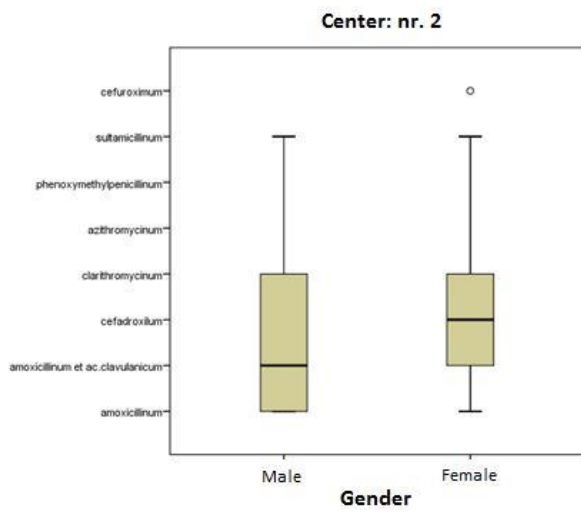
1 picture. Antibiotic therapy comparison between two family medicine centers



2 picture. Antibiotic therapy is the first family medicine center (by gender).



3 picture. Antibiotic therapy is the second family medicine center (by gender).



P-0375

Graves' disease in pediatric age – a therapeutic challenge

Iva Lopes¹, Joana Leça²

¹UCSP de Macedo de Cavaleiros

²USF Terras do Ave

BACKGROUND: Graves' disease is responsible for over 90% of cases of hyperthyroidism in children. It is more common in women, has a peak between 11 and 15 years old and an incidence of 0.1-3 / 100.000 children. Hyperthyroidism is caused by antibodies directed against the TSH receptor, known as TRAb, which mimics the effects of TSH. Virtually 100% of patients present with diffuse goiter. Behavioral changes are more frequent in children than in adults and include irritability, nervousness and decreased performance at school. The diagnosis is based on clinical history and physical examination and it is confirmed through an analytical study. Treatment includes antithyroid drugs, radioactive iodine and / or thyroidectomy.

AIM: To describe a case of relapsing hyperthyroidism in pediatric age.

METHOD: Review of medical records.

Case description: Fourteen years old female, set in a nuclear family stage IV of Duvall, Graffar III. Diagnosed since she was 10 years old with autoimmune thyroiditis with hyperthyroidism. At the time, she presented an analytical study with elevated thyroid hormones, decreased TSH and positive anti-thyroid antibodies. Thyroid ultrasound showed increased thyroid size. Treatment was initiated with metibazol and over 2 years, she was clinically and biochemically euthyroid. The reduction of the drug dosage was progressively made, until discontinuation of therapy. Six months after discontinuation, in a follow-up visit, symptoms like weight loss, insomnia and easy irritability returned. Analytical control was performed, demonstrating the recurrence of hyperthyroidism.

CONCLUSION: Although less common than in adults, thyroid autoimmune diseases also exist in children. It is important that the family physician is properly informed about this condition in order to make an early diagnosis. From the three alternative treatments, none meets all the criteria of safety, effectiveness and establishment of a permanent euthyroidism, which makes this disease difficult to manage.

Keywords: Graves' disease, autoimmune thyroiditis, hyperthyroidism

P-0376

Relationship of Musculoskeletal System Examination Results with Obesity in Children and Adolescents

Demet Merder Coşkun¹, Arzu Uzuner¹, Mehmet Akman¹, Alp Eren Çelenlioğlu², Özge Keniş Coşkun², Evrim Karadağ Saygı²

¹Marmara University Faculty of Medicine Department of Family Medicine

²Marmara University Faculty of Medicine Department of Physical Medicine and Rehabilitation

BACKGROUND: The relation between childhood obesity and musculoskeletal health problems is not yet fully demonstrated. The aim of this study was to demonstrate the relationship between obesity and musculoskeletal development and functionality on 5-16 years old school children by comparing musculoskeletal examination findings and functionality scores between overweight/obese children and their normal weight peers.

METHOD: This is a descriptive, cross-sectional study. Sample was selected from a previous study carried out between 2013-2014, in which prevalence of obesity among 6-15 years old school children in the province Istanbul Pendik district in Turkey investigated. Informed consents were sent to 3934 parents of children who were assessed as normal weight, overweight and obese in the previous study. They were invited to hospital for a detailed pediatric musculoskeletal examination including posture, gait, balance, muscle strength, range of motion assessment. Turkish version of Pediatric Outcomes Data Collection Instrument "Bedensel İşlevsellik Aracı (BİDA)" was used to assess musculoskeletal functionality. Participants were divided in two groups as overweight/obese and normal weight. Musculoskeletal examination findings and BIDA scores of two groups were compared.

RESULTS: Data of 318 participants was analyzed; 193 (60,7%) were overweight/obese and 125 (39,3%) were normal weight. There was no significant difference within age and gender distribution between two groups. Pes

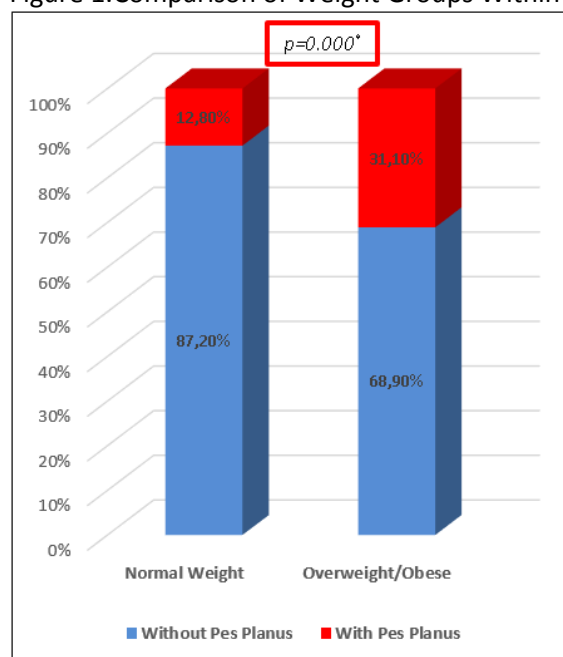
planus was more common, standing time on one leg was shorter, time to complete timed up and go test (TUG) was longer, scores of "happiness" subscale of BIDA was lower and Range of motion (ROM) was decreased in many joints especially on the lower extremity in overweight/obese children than normal weight peers ($p < 0,005$). Body Mass Index (BMI) values showed inverse correlation with both ROM and "happiness" subscale scores ($p < 0,005$). CONCLUSION: Musculoskeletal problems are more common in overweight/obese children than in normal weight children. Interventions to decrease BMI could protect overweight/obese children from severe musculoskeletal diseases.

Keywords: childhood obesity, musculoskeletal, functionality, balance

Table 1. Comparison of Weight Groups Within Gender and Average Age

		Normal Weight	Overweight/Obese	Total	p		
Gender	Female	n	67	91	158		
		Gender%	42.4	57.6	100.0		
		Weight Group%	53.6	47.2	49.7		
		Total%	21.1	28.6	49.7		
		Male	n	58	102	160	
			Gender%	36.2	63.8	100.0	
	Weight Group%		46.6	52.8	50.3	>0.05	
	Total%		18.2	32.1	50.3		
	Total		n	125	193	318	
			Gender%	39.3	60.7	100.0	
		Weight Group%	100.0	100.0	100.0		
		Total%	39.3	60.7	100.0		
Average Age±SD		10.15±2.26	10.21±2.25	10.19±2.25	>0.05		

Figure 1. Comparison of Weight Groups Within Pes Planus



* $p < 0,05$ Chi-square

Table 2. Inspection Results of Musculoskeletal Examination

	Yes		No	
	n	%	n	%
Pes planus	76	23.9	242	76.1
Increased thoracic kyphosis	43	13.5	275	86.5
Shoulder asymmetry	33	10.4	285	89.6
Plano valgus	29	9.1	289	90.9
Scapular wing	8	2.5	310	97.5
Antalgic gait	5	1.6	313	98.4
Genu valgum	4	1.3	314	98.7
Genu varum	3	0.9	315	99.1
Pelvic asymmetry	3	0.9	315	99.1
Increased cervical lordosis	2	0.6	316	99.4
Persistent femoral anteversion	2	0.6	316	99.4
Circumduction gait	1	0.3	317	99.7
Trendelenburg	0	0.0	318	100.0
Recurvatum	0	0.0	318	100.0
Toe Walking	0	0.0	318	100.0

Table 3. Comparison of Weight Groups Within Standing Time On One Leg, Timed Up and Go Test and Pediatric Outcomes Data Collection Instrument Subscale Scores

	Normal Weight	Overweight/Obese	p
	Mean/Median	Mean/Median	
STOLL (sec)			
Right	140.0±111.3	90.0±105.5	0.013***
Left	162.0±114.1	90.0±106.2	0.002***
TUG (sec)	7.4±1.2	8.1±3.9	0.004**
PODCI			
	93.0±8.7	92.4±9.7	0.600
	98.6±3.4	97.8±4.1	0.073
	90.8±10.6	88.8±11.9	0.121
	77.5±19.4	80.9±20.4	0.142
	90.3±14.4	81.4±22.2	0.000**
	89.9±7.8	89.9±8.6	0.976

STOLL: Standing Time On One Leg, TUG: Timed Up and Go Test, PODCI: Pediatric Outcomes Data Collection Instrument, **p<0,05 (Independent t-test), ***p<0,05 (Mann-Whitney U)

Table 4. Comparison of Weight Groups Within Range of Motion

	Normal Weight	Overweight/Obese	p
--	---------------	------------------	---

Neck		59.4±8.8	56.6±7.7	0.002**			
		Right					
		Normal Weight	Overweight/Obese	p	Normal Weight	Overweight/Obese	p
Shoulder							
	Flexion	179.9±0.7	180.0±0.0	0.036**	179.9±0.8	180.0±0.0	0.031**
Elbow							
	Flexion	144.4±6.2	139.0±6.4	0.000**	144.4±6.2	139.0±6.4	0.000**
Wrist							
	Flexion	82.5±4.0	80.6±4.7	0.000**	82.2±4.8	81.6±4.7	0.000**
Hip							
	Flexion	133.6±11.4	121.7±10.4	0.000**	133.8±11.0	121.9±10.3	0.000**
	Extension	42.6±5.8	38.0±7.7	0.000**	42.6±5.8	38.0±7.7	0.000**
	Abduction	67.5±9.1	60.9±10.9	0.000**	67.4±9.1	60.9±11.0	0.000**
	Adduction	48.2±9.3	41.3±8.7	0.000**	48.2±9.3	41.5±8.6	0.000**
	External Rotation	57.4±10.3	45.7±10.1	0.000**	57.4±10.3	45.6±10.1	0.000**
	Internal Rotation	48.9±9.6	36.2±10.7	0.000**	48.9±9.6	48.9±10.7	0.000**
Knee							
	Flexion	142.3±5.4	134.6±7.2	0.000**	142.3±5.4	134.7±7.0	0.000**
Foot							
	Flexion	51.5±6.6	48.2±5.9	0.000**	51.5±6.6	48.2±6.1	0.000**
	Extension	27.5±3.9	23.5±3.6	0.000**	27.6±4.0	23.6±3.6	0.000**
	Pronation	21.9±3.5	19.3±4.9	0.000**	21.8±3.4	19.1±5.0	0.000**

**p<0,05 (Independent t-test)

Table 5. Correlation of Range of Motion with Body Mass Index

		Correlation p			
Neck		Right		Left	
		Correlation	p	Correlation	p
Shoulder					
	Flexion	0.096	0.086	0.096	0.087
Elbow					
	Flexion	-0.327	0.000****	-0.338	0.000****
Wrist					
	Flexion	-0.186	0.000****	-0.182	0.000****

Hip

Flexion	-0.488	0.000****	-0.508	0.000****
Extension	-0.333	0.000****	-0.337	0.000****
Abduction	-0.318	0.000****	-0.318	0.000****
Adduction	-0.359	0.000****	-0.358	0.000****
External Rotation	-0.407	0.000****	-0.409	0.000****
Internal Rotation	-0.464	0.000****	-0.457	0.000****

Knee

Flexion	-0.505	0.000****	-0.509	0.000****
---------	--------	-----------	--------	-----------

Foot

Flexion	-0.235	0.000****	-0.236	0.000****
Extension	-0.442	0.000****	-0.449	0.000****
Pronation	-0.237	0.000****	-0.344	0.000****

****<0.05 (Pearson Correlation)

P-0377

{I'm fatty, can I use Orlistat?} - An evidence-based revision

Maria Miguel Sá¹, Carla Pina², Juliana Pais²

¹USF Famílias, ACeS Entre Douro e Vouga, Santa Maria da Feira, Portugal

²USF Cuidar, ACeS Entre Douro e Vouga, Santa Maria da Feira, Portugal

Background & Aim

Obesity is an epidemic disease and a public health issue. Child obesity is a rising concern in the medical society especially because of the impact this disease in the future.

The Portuguese government considers this disease to be of serious concern, so much that they have organized a especial task force whose main goal is to invest in the epidemiological investigation related to this issue.

The main treatment is based on the alteration of life style measures such as weight control and exercise programs adapted to children and family routines.

Pharmacological treatment is sometimes seen as the easiest solution and the growing number of drugs launched for weight control can give the illusion of a short term solution. In Europe only one drug is approved for adults, orlistat and there are no drugs approved for children. In the USA orlistat is also approved for children between 12 and 18 years of age.

The goal of this revision is to determine the evidence of efficacy of orlistat in obese teenagers.

Method

Article search during the month of February 2015 using several evidence-based medical databases, in a time period between January 2005 and February 2015, using MeSH terms. For the evidence classification, the OXFORD of Center for evidence-based medicine was used.

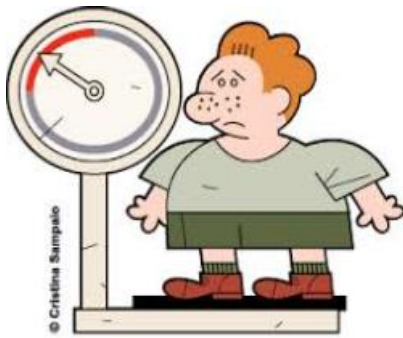
Results

In a total of 109 articles identified, 5 were selected, two of which are guidelines, one systematic review and two meta-analysis.

Conclusions

All studies reinforce that the use of pharmacological drugs for weight control in the paediatric population should be of a very exceptional character. The follow-up period of the studies are short which doesn't allow them to be a base for stable recommendations. The guidelines emphasize the specific characteristics that should be present in those individuals that could initiate this kind treatment.

Keywords: obesity, orlistat, adolescent



Systematic Reviews and Meta-Analysis

Reference	Type	Sample	Population	Intervention	Results
Whitlock et al	Systematic Review	7 RCT ↓ 2 about orlistat	Obese individuals between 12 and 18 years (N = 579)	Orlistat (120mg, 3 times a day) Follow-up between 6 and 12 months.	Concludes there is a significant decrease in BMI compared with the institution of behavioral measures. Level 2
Viner et al	Meta-analysis	6 RCT ↓ 2 about orlistat	Obese individuals between 12 and 18 years.	Orlistat (120mg, 3 times a day) Follow-up of 54 weeks .	BMI showed significant decrease compared to placebo. Level 1
Czernichow et al	Meta-analysis	8 RCT ↓ 5 about orlistat	Obese individuals between 10 and 18 years.	Orlistat (120mg, 3 times a day) Follow-up between 6 and 15 months. Drop out: 33, 8%.	This analysis showed no evidence of significant difference in the decrease in BMI, changes in lipid profile or tension profile. High heterogeneity, only one study was subject to MA. Level 2

Guidelines

Reference	Type	Recommendations
"Overweight and obesity. In: Expert panel on integrated guidelines for cardiovascular health and risk reduction in children and adolescents."	Guideline (USA) (2011)	<p>Recommends the use of orlistat :</p> <ul style="list-style-type: none"> - In individuals aged over 12 years with a BMI ≥95 percentile and - Co -morbidity (hypertension, type 2 diabetes or dyslipidemia) or - IMC≥35Kg / m2. <p>According to the guideline is awarded the Grade A (strong recommendation).</p>
"Prevention and management of obesity for children and adolescent"	Guideline (Australia) (2013)	<p>Recommends the use of orlistat :</p> <ul style="list-style-type: none"> - In individuals aged over 12 years and - A BMI ≥99 percentile and - Co -morbidity <p>Together with other measures (diet, exercise and behavioral program).</p> <p>According to guideline is awarded the degree that confers a high force recommendation.</p>

P-0378**Decision of antibiotics cure in children diagnosed as acute tonsillopharyngitis**

Polat Nerkiz¹, Mehmet Saldır², Kadir Aracı¹

¹Department of family medicine, Gümüşsuyu Asker Hastanesi, İstanbul, Turkey

²Department of pediatrics, Gülhane Military Medical Faculty, Ankara, Turkey

Background&AIM: Antibiotics are used frequently for acute respiratory tract infections. We aimed to reveal the portion of group-A beta hemolytic streptococci (GABHS) causing tonsillopharyngitis upon throat culture applied on children complaining from high fever and sore throat and diagnosed clinically as acute tonsillopharyngitis in this study.

METHOD: Children applying with the complaint of high fever, sore throat and diagnosed as acute tonsillopharyngitis and obtained throat culture were examined. All of the patients were diagnosed as acute tonsillopharyngitis and antibiotic cure was initiated.

RESULTS: 56 children who applied to our medical center were taken to the study. They were between the ages 3-11 and the average age was 6,6. 30 of them were girls and 26 of them were boys. GABHS has been found to be reproduced in 12 (21%) of the patients who have been subjected to throat culture due to acute tonsillopharyngitis diagnosis, whereas normal throat flora was found in 44 (79%) of the patients. It was determined that 79% of the patients had been subjected to unnecessary antibiotic cure.

CONCLUSIONS: Rapid and accurate diagnosis of infectious diseases reduces unnecessary use of antimicrobial therapy. Rapid diagnostic tests suitable for the evaluation of patients in the office or clinics would be helpful for this unsuitable situation.

Keywords: Throat culture, group A beta hemolytic streptococcus, tonsillopharyngitis

P-0379**The difficult differential diagnosis of psychogenic asthma in children**

Theodoros Vasilopoulos¹, Georgia Arseni², Dionysios Varthalis², Eirini Trachanatzis², Dimitrios Vasilakis², Nikolaos Kontarakis¹

¹Health center of Ag.Barbara, Herakleio, Crete, Greece

²Venizeleio Gen. Hospital, Herakleio, Crete, Greece

BACKGROUND-AIM: Bronchial asthma is a common disease state of childhood of varying etiology.

Psychopathological conditions may have a duration in time and trigger an asthmatic crisis of varying gravity each time.

The aim of the study was to show that psychogenic asthma exists as a clinical entity in everyday life, but rarely is recognized and treated in its proper dimension.

METHODS: We studied 11 children aged 7-12 years who presented at the medical center with at least four episodes of asthmatic crisis of 48 hours duration, the last two months, treated with one or more anti-asthmatic medications. All children had sudden onset of crises, severe clinical presentation and symptoms. Initially, the common treatment of asthma attack was applied. However, the repeatability of the crisis led to a more cautious history taking. In seven of the eleven children, psychogenic etiology of asthma was suspected. Analytically, two girls, of recently divorced parents, a boy with walking difficulties who suffered the laugh track behavior of peers, two children who repeatedly witnessed episodes of domestic violence, and two girls aged with difficulties in their daily lives due to recent unemployment of both parents. By suspicion of psychogenic etiology of the attacks, common asthma treatment was applied in the emergency department, while social support and psychological treatment was provided by family physician and social services for a period of 3 months.

RESULTS: Gradually, the frequency of asthma attacks in these children was reduced, although no changes in their antiasthmatic therapy was made.

CONCLUSIONS: Psychogenic asthma rarely is rightly approached, resulting in unsuccessful treatment and maintenance at its base. The need for mutual cooperation of the general physician and the family environment is underlined, and the contribution of other social actors as well.

Keywords: factor psychological, asthma, children

P-0380

Pediatric Emergency in Sport. A case report

Veronica Parent Mathias¹, Lorea De Unamuno Lumbreras², Irina Yezerska³, Juan Manuel García López¹, Raquel Gomez Bravo⁴

¹Emergency Department Regional Hospital, Málaga, Spain.

²Andalusian Health Public Service, Spain.

³Cantabria Public Health Service, Spain

⁴Semfyc, Spanish Family Medicine Society.

Background

12 years old patient arrive at our health center cause of syncope playing handball at 50m.

During the game he gets hit in the chest by the ball, after that he falls immediately unconscious. At his arrival cardiopulmonary arrest is diagnosed, and we start CPR, we send someone to search the Automated external defibrillator (AED). Resuscitation was initiated and the defibrillator provides 2 defibrillations. He was transferred to the hospital. The electrocardiogram on admission shows Ventricular Fibrillation so he gets the third defibrillation. It appears sinus rhythm. He gets hemodynamically stable without arrhythmias. Color echocardiogram shows no cardiac structural alterations and ECG-Holter 24 h was normal too.

Results: Sudden death due to cardiac shock is caused by a direct hit to the chest, in the absence of underlying cardiovascular disease, and it is an event known as commotio cordis, one of the most frequent causes of sudden death in young athletes. In USA most victims are men (95%) and ethnic "white" (78%). 50% of events take place in Sports in the high competition. It must be a hit in the chest by a blunt object, a ball or body contact with another player, directly on the heart, and it has to take place in the electrically vulnerable period of the cardiac cycle (rising part of the T wave, just before its peak).

The treatment is defibrillation. There is no evidence that survivors of commotio cordis event present new high risk of arrhythmic events and secondary prevention is not indicated.

CONCLUSIONS (and applicability for family medicine)

Family physicians work in health care centers and they can be near sports centres. They must have an AED. They can save lives like in our case.

Keywords: Sudden Death, Commotio Cordis, Defibrillation

P-0381

When everything seemed to be ok... - A clinical case of adolescent idiopathic scoliosis

Vera Pires Da Silva, Ana Luísa Gomes

USF Ramada, Loures, Portugal

Background and AIM:

Pediatric scoliosis is a relatively uncommon condition, defined as a structural alteration of the spine with a lateral curvature greater than 10°. It includes a broad range of conditions with or without clear etiology. Adolescent idiopathic scoliosis (AIS) is the most common form (approximately 3%) but only 10% require treatment and it is uncommon to need more than intermittent clinical and radiographic observation. We present a case of AIS with an extremely sudden curvature progression causing a marked deformity and requiring surgical treatment.

METHOD:

Data was gathered during an office visit with the adolescent and her mother; analysis of patient's clinical records including medical history, physical examination, diagnostic procedures, treatment and evolution; and discussion of the case with the orthopedic surgeon. A literature review regarding AIS was also performed.

RESULTS:

Thirteen year old girl, normal birth and development history, Tanner Stage III, no menarche, no relevant family history. Scheduled by her Family Physician (FP) for routine evaluation considering that her last visit was over 2 years ago. Without any complaints. On physical examination marked asymmetry was detected of shoulder, scapula and posterior thoracic cage; Adams forward

bend test showed marked rib prominence; no leg length discrepancy. Spine X-ray revealed scoliosis with Cobb angle greater than 70°. Referred to Orthopedic Surgery where, due to severe curvature, was submitted to surgery with good outcome and evolution. Presently maintains regular FP follow-up.

CONCLUSION:

This case reinforces the importance of FP's evaluation on regular basis. Early spine deformity detection might allow a non-operative management of scoliosis. FP need to maintain high suspicion and provide continued monitoring, particularly during adolescence's growth spurts when scoliosis curves have the highest risk for progression.

Keywords: Scoliosis, Pediatric Care, Primary Care Physicians

Figure 1. Shoulder, scapula and posterior thoracic cage with marked asymmetry



Table 1. AIS diagnosis criteria

Age	≥ 10 years
Cobb angle	≥ 10°
Other	Absence of other etiologies

Figure 2. Standing posteroanterior radiograph demonstrating right thoracolumbar scoliosis



Table 2. Indications for referral to an orthopedic surgeon

- Angle of trunk rotation (as measured with the scoliometer) of $\geq 7^\circ$ and inability to obtain a Cobb angle
- Cobb angle between 20° and 29° in premenarchal girl or boy aged 12 to 14 years
- Cobb angle $>30^\circ$ in any patient
- Progression of Cobb angle of more than 5° in any patient

P-0382

Hypercholesterolemia and statins in children: what impact on LDL cholesterol?

Juliana Pais¹, Maria Miguel Sá², Carla Pina¹

¹USF Cuidar, ACeS Entre Douro e Vouga, Santa Maria da Feira, Portugal

²USF Famílias, ACeS Entre Douro e Vouga, Santa Maria da Feira, Portugal

Background & aim

Hypercholesterolemia is a common disease in adults and rising in children. These changes are usually associated with cardiovascular events.

Various studies show that complications are reduced if lifelong hypolipidemic measures are taken prematurely.

The aim of this revision is to determine the efficacy of statins on reduced LDL cholesterol in pediatric patients compared with placebo or other pharmacological therapies.

Method

Comprehensive searches had been conducted in March 2015 on several evidence-based medical databases, between January 2005 and February 2015, using MeSH Terms. For the evidence classification was used the OXFORD.

Results

Were identified 19 articles and selected 8. Those were three guidelines, three systematic reviews and two meta-analyses.

Conclusions

All the studies incorporated in the revision are consistent with the fact of statins be are well tolerated, safe and efficacious in short-term, although long-term safety remains unclear.

Primordial prevention, which includes counseling diet and lifestyle modifications (not smoking and regular physical activity) are the most important component of the treatment. However many studies support

pharmacologic treatment, for children (between ages of 8 and 10, depending on studies) at higher cardiovascular risk, with statins.

The most part of the studies only included children with familial hypercholesterolemia and so is difficult to extrapolate to another population. There is no evidence of efficacy on prevention of morbidity or mortality related to adult-onset cardiovascular disease.

Large long-term randomized controlled trials are needed to establish the long-term safety issues of statins in this population.

Keywords: Adolescent, child, preschool, dyslipidemia, Hydroxymethylglutaryl-CoA Reductase Inhibitors

Systematic review

Study	Type of Study	Sample	Population	Intervention	Results	Level Evidence
Y. Leberthal et al (2010) Archives of Disease in Childhood	RS	7 RCT n= 884	Family Hipercholesterolemia (FH) patients aged 8-18 years	- statins vs. placebo - 28 week intervention	Statins have impact on the reduction of total and LDL Cholesterol	1
A. Vuorio et al (2014) The Cochrane Collaboration	RS	8 RCT n= 1074	FH patients aged 8-18 years	- statins vs. placebo - Diet 6 week- 2 years intervention	- Statins reduce LDL concentrations averaging 23-40% - We need to long-term studies in this age group.	2

Meta-analysis

Study	Type of Study	Sample	Population	Intervention	Results	Level Evidence
H. J. Avis et al (2007) Arterioscler Thromb Vasc Biol.	MA	6 RCT n=476	FH patients aged 8-18 years	- 476 patients received statins; - 322 received placebo - 12 a 104 week intervention	- All studies reported decreased LDL and total cholesterol in patients undergoing statin.	2
C. Arambelopa et al (2007) Atherosclerosis (Elsevier)	MA	8 RCT n= 947	FH patients aged 8-18 years	- Statins vs. placebo - Different types and doses of statins - 6 a 96 week intervention	- Statins decreased LDL by 32.5% - Statins are effective, safe and well tolerated short term.	2
C. S. O'Gorman et al (2009) Pediatrics Cardiology	MA	4 RCT N= 575	FH patients aged 8-18 years	- Statin vs. placebo - Different types and doses of statins - 24 week - 2 years intervention	- Statistically significant reduction in LDL with the use of statins.	2

Guidelines

Reference	Type of Study	Recommendations	SR
Family hypercholesterolemia in underdiagnosed and undertreated in the general population: guidance for clinicians to prevent coronary heart disease	Guideline (2013)	- Statins are effective in lowering LDL and well tolerated in children with FH over 8-10 years and are considered the first choice ; - Increased LDL is associated with atherosclerosis process, however it is not known at what age these lesions become irreversible - more long-term studies are needed.	A
Expert Panel on Integrated Guidelines for Cardiovascular Health and Risk Reduction in Children and Adolescents National Heart, Lung, and Blood Institute And American Academy Pediatrics	Guideline (2012)	Children <10 years: Treatment with statins is reserved for Hyperlipemias severe primary; Children 11-21 years <ul style="list-style-type: none"> . LDL > 190: It should be treated with Statins . LDL 160-189 Family with History positive or ≥ 1 severe risk factor or ≥ 2 moderate risk factor - should be treated with Statins . LDL 130-159 with ≥ 2 high risk factor or ≥ 1 high risk factor + ≥ 2 moderate risk factor - should be treated with statins. 	C A B B

P-0383

Pubertal development in adolescence - Comparative analysis of self-assessment and medical evaluation among adolescents at the University Hospital of Brasilia

Marilucia Rocha De Almeida PICANCO, Wander Alysson Santos De Carvalho, Tiago Artur Lyra Leite, Luciana Nakanishi
Universidade de Brasília - Brasil

Background and AIM: The study aimed to perform the analysis of the self-assessment of sexual maturation performed by adolescents in clinical consultation, comparing it to the objective medical evaluation. METHOD: This is a cross-sectional and double-blind study, carried with adolescents in the Health clinic of the University Hospital of Brasilia. RESULTS: It has been shown by the study that adolescents know little about their body and there is no global agreement between self-assessment and medical assessment of sexual maturation stages with percentage of 31.58%. It was found a frequent presence of pubic hair removal in adolescents of both sexes, considering of 21.05% in males and 78.95% in females. In the presence of trichotomy, there was an agreement of self-assessment and objective assessment regarding the pubic hair of 42.11%, and in the absence the agreement was of 57.89%. CONCLUSIONS: It is suggested that self-assessment of sexual maturation is unreliable and that teenagers do not know their body. Moreover, the high rate of pubic hair removal in adolescents can lead to a confusing factor when assessing the degree of sexual maturation considering the pubic hair factor.
Keywords: Adolescence, sexual maturation, self-assessment

Percentage of agreement in both sexes, taking into account the pubic hair in the presence and absence of trichotomy

Table 2: Percentage of agreement in both sexes, taking into account the pubic hair in the presence and absence of trichotomy		
	Discordance	%
Presence of Trichotomy (n = 19)	11	57,89
Absence of Tricotomy (n = 19)	8	42,11

P-0384

Assessment of nutritional status in children and adolescents in Malvinas Argentinas District, Buenos Aires, Argentina

Juan Emilio Casabella¹, Favio Flores², Zara Paiva³

¹Municipio de Malvinas Argentinas, Buenos Aires

²Municipio de Malvinas Argentinas, Buenos Aires

³Municipio de Malvinas Argentinas, Buenos Aires

Introduction and aim.

Overweight is an increasingly condition in childrens and teenagers in primary care consultations, in Malvinas Argentinas District, however health teams based on experience from previous years prioritized the investigation of malnourished children. It is the aim of this study to describe the prevalence of both malnutrition and obesity in children of this county.

.Primary OBJECTIVE:

⊗ To assess the nutritional status of schoolchildren in differents primary care units of Malvinas Argentinas district.

To carry on medical interventions if necessary.

Secondary OBJECTIVES:

⊗ Assess fullfilment of immunization schedule and initiate recovery scheme vaccine if necessary.

⊗ Assess Visual Acuity.

⊗ Detect the presence of caries.

METHODS:

Observational, descriptive cross-sectional study conducted in 20 functional units of the Municipality of Malvinas Argentinas, during and March 2014 during February.

3002 children between 2 and 20 years were evaluated.

Data were obtained from HC made in Aptos Physical Operational School. The Anthropometric Tables Z-score WHO were used for age and sex, evaluating weight / age, height / age and body mass index (BMI).

RESULTS:

3002 patients were evaluated, of which 55% (n = 1651) had adequate weight, 36% (n = 1081) Overweight / Obesity and 9% (n = 271) were underweight / malnourished.

The highest percentage of malnutrition was in the age range of 2-5 years.

The highest percentage of overweight / obesity was detected in the age range of 6-11 years.

The percentage of children with caries was similar in the 3 groups, overweight and obesity: 59%, right Weight: 55%, Low weight, Malnutrition: 62%.

CONCLUSIONS:

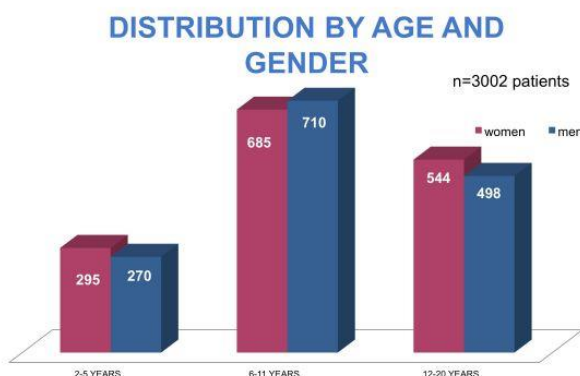
Among the data evaluated in our town we observed higher prevalence of overweight / obesity in relation to underweight children.

Caries prevalence was similar in the three groups evaluated.

Almost all of the patients tested had full schedule of vaccines for age.

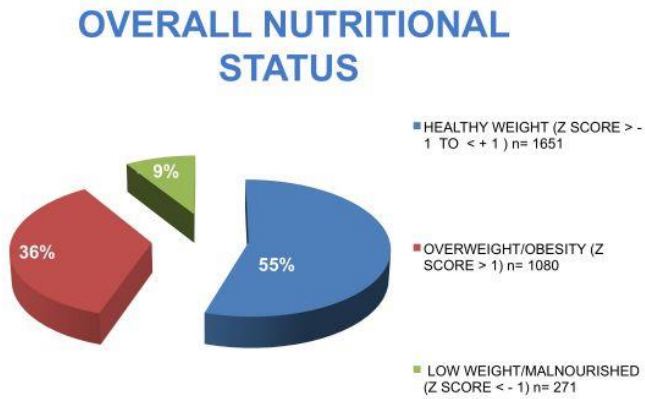
Keywords: obesity, malnutrition, overweight, vaccination, primary care intervention

DISTRIBUTION OF PATIENTS BY AGE AND GENDER



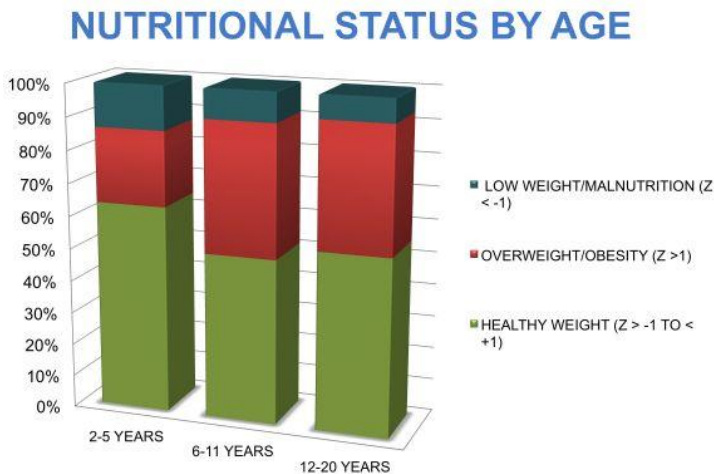
3002 patients were evaluated

OVERALL NUTRITIONAL STATUS



55% (n = 1651) had healthy weight, 36% (n = 1081) Overweight / Obesity and 9% (n = 270) were underweight / malnourished.

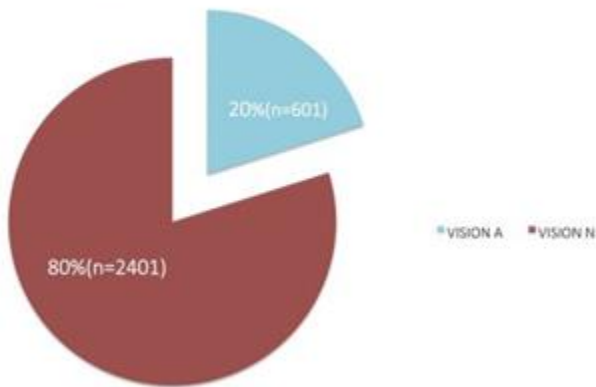
NUTRITIONAL STATUS BY AGE



The highest percentage of malnutrition was in the age range of 2-5 years. The highest percentage of overweight / obesity was detected in the age range of 6-11 years.

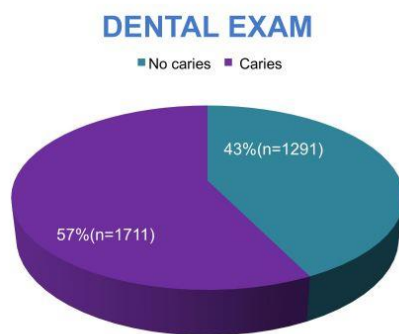
VISUAL ACUITY

VISUAL ACUITY EXAM



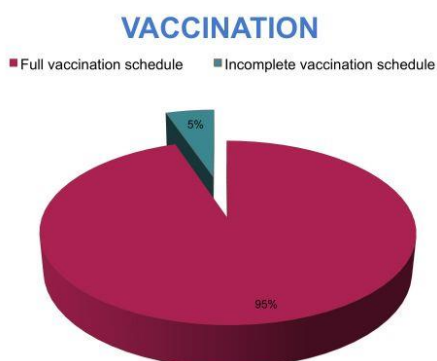
Regarding to visual acuity, 80%(n=2401) had normal visual acuity and 20% (n=601) had alteration in visual acuity.

DENTAL EXAM



In dental examination, 57% (n=1711) of children and adolescents had caries, while 43%(n=1291) did not.

VACCINATION



95%(n=2852) of children and adolescents had age appropriate vaccination/immunization schedule, 5%(n=150) of these did not.

P-0385

Prevalence of Hypertension in Patients referred to the General Pediatric Outpatient Clinics in Ege University Faculty of Medicine Hospital

Havva Polatci¹, Guldane Koturoglu², Asli Aslan², Zafer Kurugol², Huseyin Can¹

¹Department of Family Medicine Clinic, Izmir Katip Celebi University Atatürk Training and Research Hospital, Izmir, Turkey

²Department of Child and Diseases Clinic, Ege University, Izmir, Turkey

AIM: This study was performed in order to investigate the prevalence of hypertension among children between 3-18 years of age referred to Ege University Faculty of Medicine Hospital Child Health and Diseases Outpatient Clinics for any reason.

MATERIAL- METHOD: 488 children between 3-18 years of age referred to General Pediatric Outpatient Clinics between May - July 2014 were included in this study. Data were achieved via questionnaires by face to face interview technique. In the questionnaires, the age and sex of the patients, their complaints, presence of any chronic disease, history of drug use, family history of hypertension were questioned. Patients' measures of weight, height, body mass indices and blood pressure were performed by a detailed physical examination. **RESULTS:** 258 of patients (52.9%) were male, 230 of them (47.1%) were female. Mean age was 9.44 ± 4.22 years. Normotension was determined in 83.4% of the patients, prehypertension was determined in 15%, stage 1 hypertension was determined in 1.2% and stage 2 hypertension was determined in 0.4% of the patients. In 47.5% of the patients diagnosed with prehypertension and hypertension, obesity was determined. In the evaluation of family history of hypertension; 34,3% of normotensive patients, 36,9% of prehypertensive patients, 100% of stage 1 hypertension patients and 50% of stage 2 hypertension patients had a positive family history. In 37,5% of patients diagnosed with hypertension had a history of drug use. The most commonly used drug was methylphenidate.

CONCLUSION: Hypertension is a frequent clinical situation that is detected during childhood and may lead to serious mortality and morbidity. Blood pressure measurements as a part of routine physical examination especially in children older than 3 years of age and identification and treatment of these patients are life saving.

Keywords: Hypertension, Children, Prevalence

Hypertension in Childhood



Blood Pressure Chart

Tension Levels	Number of Patients	Percent(%)
Normotension	407	83.4
Prehypertension	73	15
Stage 1 Hypertension	6	1.2
Stage 2 Hypertension	2	0.4
Total	488	100

P-0386

Assessment Of Depression And Social Phobia Of Obese And Overweight Adolescents

Sara Akıcı¹, Dilek Toprak Evcik¹, Ibrahim Hakkı Aktan²

¹Family Medicine Clinic, Şişli Hamidiye Etfal Training and Research Hospital, Istanbul, Turkey

²Pediatric Clinic, Şişli Hamidiye Etfal Training and Research Hospital, Istanbul, Turkey

AIM: In this research, we aimed to investigate the relationship between adolescents' BMI with depression and social phobia.

MATERIALS-METHOD: This study is a case-control study which was conducted among 10-17 age adolescents in Şişli Hamidiye Etfal Training and Research Hospital General Pediatric Polyclinic. The research conducted between April 2014-October 2014. After investigating for sociodemographic features, Child Depression Inventory (CDI) and Çapa Social Phobia Scale for Child and Adolescent (CSPSCA) were applied. Every adolescent's length-weight measurement performed and BMI was calculated. Obese- overweight adolescents were defined as "case group" and normal weighted adolescents were defined as "control group".

RESULTS: In this study, out of 183 cases, aged between 10-17, 91 were male, 92 were female; 90 were normal weighted, 93 were obese-overweighted. Both groups were similar in the male-female ratio. Obese-overweight group's school scores were higher, they were attending school activities less, having breakfast more regularly, was doing less physical activity, were usually only child in the family, their parents had more chronic diseases, they perceived their families' financial situation better than it is compared to normal weight group ($p < 0.05$). Obese-overweight adolescent's mothers and fathers were more obese ($p = 0,016$ and $p = 0,0001$ respectively). There was no significant difference between the groups about CDI-CSPSCA scores ($p = 0,665$; $p = 0,100$). In normal weighted group there was a positive linear and intermediate level correlation between CDI-CSPSCA scores, but in Obese-overweighted adolescent group there was no correlation like that. Obese-overweight girls had higher scores of CDI than normal weighted girls.

Obese-overweight adolescents who didn't do physical activity regularly; the CDI scores ($p = 0,070$) and the CSPSCA scores were found to be higher ($p = 0,067$). In both groups, there was a significant negative weak correlation between family economic status and CSPSCA scores ($p_{\text{case group}} = 0,009$, $p_{\text{control group}} = 0,013$).

CONCLUSION: This study showed that parents' obesity and childhood obesity highly correlated. Adolescents' obesity is associated with social phobia and depression severity. Necessary measures should be taken to prevent possible psychological problems of over-weighted adolescents.

Keywords: Adolescent, obesity, Depression, Social phobia

P-0387

First year of Growth and development of children of primiparous teenage mothers - comparative study with children of adult mothers

Marilucia Rocha De Almeida PICANCO, Barbara Trapp, Juliana Carolina Martins Vissoci, Luciana Rodrigues Costa, Juliane Marchese

Universidade de Brasília - Brasil

Background and AIM: This study aimed to analyze the growth of children of teenage mothers (<19 years) in their first pregnancy, accompanied in the Pediatrics service in the University Hospital of the University of Brasilia - Brazil, during their first year of life compared with data from children of adult mothers (20-34 years). **METHOD:** The data were obtained by a standard questionnaire applied and collected longitudinally during routine pediatric consultations. We used the SPSS software and the chi-square test for significance analysis. 89 adolescent mothers in their first pregnancy / babies were analyzed, and 92 dyads of non-teenager, from 20 to 34 years, mothers / babies. **RESULTS:** The results showed that the children of adolescent mothers showed no significant differences regarding birth weight and length to the pattern of the children of adult mothers during their first year.

CONCLUSIONS: Adolescents mothers weaned their babies earlier and their babies grew up with lower monthly weight gain, but without statistical significance. Regarding the neuro psychomotor development, infants showed delays in some important marks only reaching them after intervention. Considering the social adaptability, they

showed more sleep disorders and more difficulty to establish bonds, when compared with the children of primiparous adult mothers.

Keywords: Growth and Development; Teenage Pregnancy; Pediatric Consultation

P-0388

Metabolic syndrome among adolescents treated at the University Hospital – Brasilia/DF: A comparative study using two diagnostic criteria: IDF and NCEP-ATPIII

Marilucia Rocha De Almeida PICANCO, Wander Alysson Santos De Carvalho, Tiago Artur Lyra Leite, Luciana Nakanishi
Universidade de Brasília - Brasil

INTRODUCTION: The number of pregnant teenagers is increasing in the country and particularly in the Federal District. Teenage pregnancy is today, in Brazil, the eighth leading cause of death among adolescents aged 10-19 years old and childbirth is the leading cause of hospitalization in the lowest range of 15 years. The project consists of the monitoring of primiparous adolescent mothers and their babies during the first year of life of their children. Its main objectives are: to identify their social and demographic profile; to welcome mothers in the group work; to follow the growth and development of children during the first year of their life by promoting comprehensive care to the baby and teenage mothers, while also carrying out the objective to reduce the chance of a second pregnancy by conducting them to the Family Planning service. **METHOD:** The first contact with teenage mothers occurs in the maternity ward, where a standard questionnaire with questions about social and obstetrical aspects of these mothers and their children is applied, for the preparation of a database on the profile of this group. **RESULTS:** They are, then, forwarded to the pediatric service in the supervision of a Professor, on Wednesdays and Fridays in the morning, to carry out the medical appointments for their children. **CONCLUSIONS:** On the same day of the appointments an educational meeting is carried out in which there is discussion about contraception, STDs, general baby care, breastfeeding, strengthening the mother-infant bond, postpartum depression, and the prevention of a second pregnancy. These mothers are also forwarded to meetings in the area of Family Planning and other specialties according to their needs.

Keywords: Pregnancy in Adolescence; Growth and Development; Family Planning

Prevalence of metabolic syndrome by NCEP/ATP III

CRITERIA	MS (%)	↑ AC(%)	↑ BP (%)
Male		13,6%	
Female	-	30,4%	-
Total	26,3%	22,2%	6,4%
Adolescents			

MS: Metabolic Syndrome; AC: Abdominal Circumference; BP: Blood Pressure.

Prevalence of metabolic syndrome by IDF Criteria

Table 2 - Prevalence of metabolic syndrome by IDF Criteria

CRITERIA	↑ Glyc	↑ Trigl	↓ HDL-c
Total	13%	4.3%	69,6%

Glyc: Glycemia; Trigl: Triglycerides; HDL-c: High Density Lipoprotein Cholesterol;

P-0389

The family doctor's knowledge about the ideal age to refer children for Pediatric Surgery: a quality evaluation

Bruno Reis¹, Vitor Lopes¹, Gulsara Balabayeva¹, Liliana Santos², Cláudia Basto³, Miguel Cancela³

¹UCSP Montemor-o-Velho

²Hospital Pediátrico de Coimbra

³USF Araceti

The family doctor's knowledge about the ideal age to refer children for Pediatric Surgery: a quality evaluation

Background

The referral of children to Pediatric Surgery, although infrequent, needs exceptional care by the family doctor. The referral in a timely manner increases the surgery's degree of success and decreases the potential complications for the affected child.

Aim

This work aims to evaluate and increase the knowledge of Family Doctors and interns of family medicine about children's ideal age of referral for Pediatric Surgery.

Method

The doctors in a Healthcare Unit filled an anonymous and voluntary survey, consisting of 12 questions, about the ideal age to refer children for Pediatric Surgery in December 2014. A brief clinical session was then performed explaining the authors choice of correct answer based on national guidelines and textbooks consulted. A second anonymous and voluntary survey was submitted to the same doctors in March 2015. The results were then analysed to evaluate if the clinical session increased the knowledge, measured by the percentage of correct answers to both surveys.

Results

The first survey was completed by a total of 26 doctors. There were a total of 12 questions made and the correct answers vary between 19% and 96%, with an average of 52% of correct answers. In the second survey answered 18 doctors and the correct answers vary between 23% and 100%, with an average of 58% correct answers.

Conclusions

When evaluating the results obtained we can conclude that the clinical session had a positive, although slight, impact on the knowledge of doctors about children's ideal age of referral for Pediatric Surgery. The results show an ample margin of improvement in the knowledge of family doctors about pediatric pathology.

Keywords: Pediatric Surgery, Age of referral, Family doctor's, Quality evaluation

Percentage of correct answers in both surveys

What's the ideal age to refer children for pediatric surgery due to:	Correct Answers 1 st survey	Correct Answers 2 nd survey	
Eyebrow tail cyst	19%	22%	
Cleft palate	96%	88%	😊
Imperforate hymen	42%	48%	
Prominent ears (bat ears)	46%	49%	
Umbilical hernia	65%	71%	😊
Hemangioma / Lymphangioma	35%	47%	
Inguinal hernia	65%	67%	😊
Hydrocele	42%	53%	😊
Phimosis	84%	78%	😊
Hypospadias	58%	71%	😊
Unilateral undescended testicles	19%	31%	
Bilateral undescended testicles	58%	66%	😊

P-0390

Case report: Sometimes is more than lack of education

Erica Mendes

UCSP de Tarouca, ACES Douro Sul, Tarouca, Portugal

BACKGROUND & AIM: Autism spectrum disorder (ASD) is characterized by persistent deficits in social communication and interaction, and by present of repetitive and restricted behaviors, interests and activities. It includes a broad variety of symptoms, skills and levels of disability. Normally it is diagnosed in the two first years of life. It has a prevalence of approximately 1% of the children and is four times more prevalent in males than females.

METHOD: To make this report we used the clinical process complemented with a bibliographical research.

RESULTS: Male child, 9 years old. When he was 4 years and 9 months old, he began to show behavioral change that included: isolation, strange behaviors, excessive activity, attention disorder and aggressive behavior with pairs. After being presented to the family doctor and pediatrician was referenced to the child and adolescent psychiatry. He was diagnosed with attention deficit hyperactivity disorder and was medicated with methylphenidate at the age of 5. After a mild improvement, at the age of 7, he became more isolated and demonstrated the following: inability to relate to others and didn't make eye contact, inappropriate playing with toys, inappropriate laughing and strange attachment with objects. After reevaluation by the child psychiatry, was diagnosed with ASD (Asperger syndrome), the prescription was adjusted and started specialized therapies.

CONCLUSIONS: This case demonstrates that the differential diagnosis of ASD can be difficult. It is essential to make an early diagnosis, in order to provide the best treatment and support to these children and to improve their development and prognosis. The role of family practitioner is crucial to provide an early diagnosis and adequate follow-up. It is also presented the importance of the relations between the society, family, medical specialties and patient, where the family practitioner plays a central role.

Keywords: Child Development Disorders Pervasive, Child, Asperger Syndrome, Diagnosis Differential

Primary Health Care approach of iron deficiency anemia in pediatric age: performance protocol

Helena Ribeiro¹, Cláudia Neto², Fernando Carvalho¹

¹USF Novos Rumos, ACES Alto Ave, Vizela, Portugal

²Pediatric Department, Centro Hospitalar do Alto Ave, Guimarães, Portugal

BACKGROUND: Anemia is an important public health problem, particularly in more susceptible groups such as pregnant women and children. The primary cause of anemia is iron deficiency, that may arise in many situations such as dietary errors, iron requirement increase, bleeding and intestinal malabsorption. In pediatric age, iron deficiency anemia has been associated with delayed physical growth and psychomotor impairment.

AIM: To review the literature regarding the approach to iron deficiency anemia in pediatric age in Primary Health Care.

METHOD: Articles research in Medline/Pubmed, guidelines and specific books in Portuguese or English, using the Mesh terms: anemia, iron deficiency.

RESULTS: The presumed diagnosis of iron deficiency anemia can be made through clinical history, physical examination and complete blood count with red blood cell indices (RBC indices). In patients where there is doubt regarding anemia's etiology, is recommended evaluation of iron parameters such as iron levels, ferritin and transferrin saturation. After beginning iron supplementation, the patient should be reevaluated in one month to verify if values of hemoglobin rise at least 1mg/dL. If the response is positive, the treatment should be maintain in order to replenish iron stores.

CONCLUSION: The iron deficiency anemia is a common condition that can be treated and oriented in Primary Health Care. The General Practitioner (GP) should be able to detect warning signs or other possible anemia etiologies that should motivate referral of the patient to the hospital. Other major role of GP is the prevention of anemia through iron supplementation according to age, type of feeding and physiological needs.

Keywords: anemia, iron deficiency, pediatric age

Primary Health Care approach of iron deficiency anemia in pediatric age: diagnosis

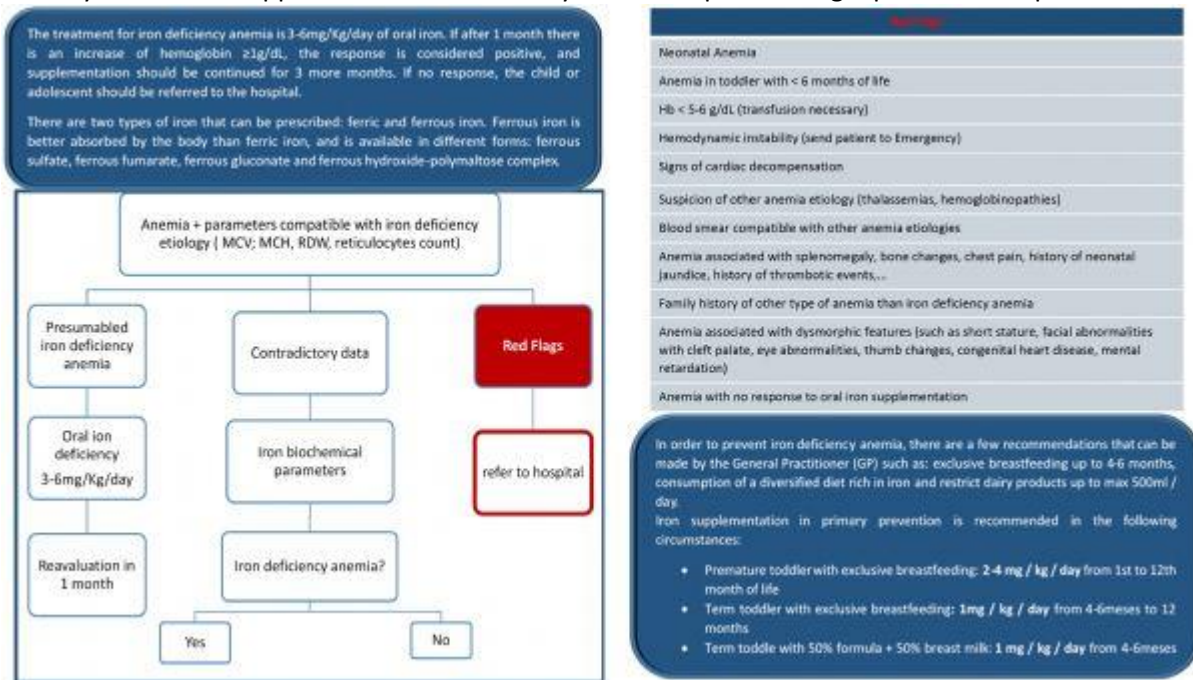
An adequate clinical history and physical examination are essential in the initial management of iron deficiency anemia.

Clinical history	<p>Personal Background Low birth weight; prematurity Breastfeeding after 4-6 months without iron supplementation Gynecological history Pathological history: inflammatory or infectious condition</p> <p>Toxic and Drugs History of exposure to lead; well water consumption (nitrates, parasites); drugs consumption.</p> <p>Family History Haematological disorders in the family Inflammatory bowel disease; polyps; cancer; jaundice; gallstones; splenomegaly.</p> <p>Diet Consumption of meat and vegetables; dairy products.</p> <p>Symptoms Frequently asymptomatic Muscle fatigue; apathy; irritability; lower exercise tolerance Suggestive of hemolysis: choluria, acholia, jaundice Blood loss</p>
Physical examination	Pale skin, Skin atrophy, koilonychia, angular stomatitis, glossitis, oesophageal and pharyngeal webs, Tachycardia and cardiac failure (in severe anaemia).

Although the history and physical examination can be helpful, the diagnosis of anemia and the type of anemia is achieved through laboratory parameters. In most cases for the diagnosis of iron anemia deficiency the parameters necessary are: hemoglobin concentration, mean corpuscular volume (MCV), mean corpuscular hemoglobin (MCH), red cell distribution width (RDW), reticulocytes count and reticulocyte hemoglobin concentration. When in doubt, other biochemical parameters may be evaluated such as serum iron (SI), total iron binding capacity (TIBC), transferrin saturation (TS), free erythrocyte protoporphyrin (Epp) and serum ferritin (SF). Through this evaluation it is possible to distinguish iron deficiency anemia from another type of anemia that may need immediate referral to hospital care.

Parameters	Iron Deficiency Anemia	β-Thalassemia	α-Thalassemia	Inflammatory Chronic Disease
Erythrocytes	↓	N/↑	N	N
MCV	↓	↓	↓	N/↓
RDW	↑	N	N	N
Reticulocyte	↓	↓	↓	↓
Mean Iron	>13	<13	N/A	N/A
Ferritin	↓	N	N	N/↑
Transferrin saturation	↓	N	N	↓
Hemoglobin electrophoresis	Normal	Increased (>3.5%)	HbA2 ↓ HbF ↑ Disease (H y chains)	HbE ↑ Normal
Blood smear	microcytotic	anisocytotic		
Response to iron treatment	Improvement	No improvement	No improvement	No improvement
Treatment	Iron supplementation	Parents evaluation, genetic counseling, periodic planning pregnancies	HbE ↑ Disease splenectomy	Blood

Primary Health Care approach of iron deficiency anemia in pediatric age: performance protocol



P-0392

Vaccine against "Neisseria meningitidis" serogroup B: what is the evidence?

Helena Ribeiro¹, Nuno Namora², Teresa Martins¹, Maria João Abreu²

¹USF Novos Rumos, ACES Alto Ave, Vizela, Portugal

²USF DuoVida, ACES Alto Ave, Guimarães, Portugal

BACKGROUND: Currently, "Neisseria meningitidis" serogroup B is the main responsible for invasive meningococcal disease and a new vaccine was developed against this bacterium.

AIM: The aim of this study was to review the scientific evidence on the immunogenicity, safety and reactogenicity of the vaccine against serogroup B (4CMenB or Bexsero®) in children.

METHOD: Literature search in the National Guideline Clearinghouse, Guidelines Finder, The Cochrane Library and PubMed using the terms "meningococcal B vaccines" and "serogroup B". Levels of evidence and strength of recommendation were assigned according to the Strength of Recommendation Taxonomy scale (SORT) from the American Family Physician.

RESULTS: Two Randomized Controlled Trials (RCT) and one Systematic Review (SR) were included. The studies considered the vaccine 4CMenB safe but more reactogenic when co-administered with other vaccines. Four studies concluded that the vaccine was immunogenicity in infants with 2 months of age. It was also considered immunogenic in infants with 6 months (one RCT), children (one RCT) and adolescents (one RCT). In the two RCTs, there was a decreased immune response in infants with three years of age who were vaccinated in the 1st year of life.

Discussion and CONCLUSION: In the published studies, the vaccine was considered safe (SORT A), more reactogenic when co-administered with other vaccines (SORT A) without affecting the immunogenicity of these (SORT A). The vaccine was considered immunogenic in infants with 2 months of age (SORT A), infants with 6 months (SORT B), children (SORT B) and adolescents (SORT B). However further studies are needed to evaluate the effectiveness, duration of immunity, long-term safety and cost-effectiveness for the Portuguese reality.

Keywords: 4CMenB, vaccine, serogroup B meningitis

Sistematic review

Reference	N	Intervention	Results	SR
Carter NJ. 2013	8 RCTs in pediatric age	<p>Immunogenicity</p> <p>Infants ≥ 2 meses (4 RCT; n=5662): 2 initial doses + 1 booster dose after 12 months</p> <p>Infants ≥ 6-8 meses (1 RCT; n= 60): 2 doses + 1 booster dose after 12 months</p> <p>Children (1 RCT; n=229): 2 doses at (12 and 14) or (13 and 15) months</p> <p>Adolescents (1ECA; n=1631; NE 2): 1,2 or 3 doses</p> <p>Safety and reactogenicity (8 RCT)</p>	<p>The 4CMenB vaccine is immunogenic and safe in infants, children and teenagers.</p> <p>When coadministered with other vaccines there is a higher reactogenicity (fever, local reactions).</p> <p>4CMenB does not affect the immunogenicity of other vaccines.</p> <p>Infants (≥ 2 months of age): immunogenicity with 3 doses + 1 booster at 12 months.</p> <p>Infants (≥ 6 months): immunogenicity with 2 doses + 1 booster.</p> <p>Children: immunogenicity with 2 doses.</p> <p>Adolescent: immunogenicity equal to 2 or 3 doses 4CMenB.</p>	B

RCT

Reference	N	Sample	Intervention	Results	LE
Snape MD. 2013	71	40-44 months old children previously vaccinated at 6, 8 and 12 months.	To determine the persistence of immune response at 40-44 months and evaluate immunogenicity of a booster dose.	Reduction of the immune response over time which is recovered after booster dose. Booster dose may be required during childhood and adolescence.	2
Snape MD. 2013	108	40-44 months old children previously vaccinated at 2, 4, 6 and 12 months.	<p>To determine the persistence of immune response at 40-44 months.</p> <p>2 intervention groups:</p> <p>1st group: administration of booster dose in previously vaccinated children</p> <p>2nd group: 2 doses of vaccine separated by two months in children without primary vaccination.</p>	<p>Previously vaccinated children: decline in immunogenic response after 13 months, which is recovered with the booster dose in preschool.</p> <p>Children without previous vaccination: immunogenic. Vaccine in preschool was well tolerated and safe.</p>	2

P-0393

"{" Evaluation of Adenovirus and Rotavirus Prevalence Among Inpatients at Child Infections Clinic Diagnosed as Gastroenteritis "}"

Cansu Öztürk, Aycan Topaloğlu, Dilek Toprak

Şişli Hamidiye Etfal Training and Research Hospital Family Medicine Clinics, Istanbul, Turkey

AIM: Acute gastroenteritis in children is the second important cause of infectious morbidity after the respiratory infections. Rotavirus and adenovirus are two of the most important infectious causes of childhood gastroenteritis. The purpose of this study is to determine the frequency of rotavirus and adenovirus of inpatient children who pre-diagnosed as acute gastroenteritis in child infectious diseases clinic.

METHOD: Rotavirus and adenovirus 40/41 antigens were investigated by immunochromatographic method in stool samples of 96 child inpatients admitted at our children infectious disease clinic in hospital with the diagnosis of acute gastroenteritis between June 2013-June 2014.

RESULTS: There are 96 patients of which %55,2 was male and %44,8 was female. Average age was 2.61 ± 2.90 (0-15). Rotavirus was positive in 33,3% (n=32) and adenovirus was positive in 4,2% (n=4) stool samples. 57% of patients having positive Rotavirus antigen were male, 75% of patients having positive adenovirus antigen were male. Patients of Rotavirus antigen positivity 57%, patients of adenovirus antigen positivity was 75% It has been observed that both rotavirus and adenovirus antigen at stool specimens are more common at boys. Meaningful relation is not observed between the genders having positive Adenovirus and Rotavirus $p=0,885$, $p=0,416$. It is observed that positive Rotavirus ratio is %38,5 and Positive Adenovirus ratio % 4,6 for the ages below 2 years old. There was no significant relationship between virus positivity and age.

CONCLUSIONS: Rotaviruses is the most common agent in childhood acute gastroenteritis. The detection of viral factors at acute gastroenteritis is important to prevent inappropriate antibacterial and antiparasitic drug usage. Detection of enteric viruses is important for patients since viral gastroenteritis may cause serious complications.

Keywords: Acute, adenovirus, child, gastroenteritis, infection, rotavirus

P-0394

Tonsillectomy, Adenoidectomy and Adenotonsillectomy Rates in School-aged Children: Relative Contributions of Socio-demographic and Clinical Features

Yusuf Cetin Doganer¹, James Rohrer², Umit Aydogan³, Mckennan Thurston², Kenan Saglam⁴

¹Department of Family Medicine, Turkish Military Academy, Primary Care Examination Center, Ankara, Turkey

²Department of Family Medicine, Mayo Clinic, Rochester, Minnesota, USA

³Department of Family Medicine, Gulhane Military Medical Faculty, Ankara, Turkey

⁴Department of Internal Medicine, Gulhane Military Medical Faculty, Ankara, Turkey

Background & AIM: The present study sought to investigate the frequencies of tonsillectomy, adenoidectomy and both adenotonsillectomy (T&A) among 6-12 year old children. In addition, we tried to find out the predictors associated with these previous upper respiratory tract (URT) surgeries.

METHOD: This cross-sectional study consisted of 1900 children educated in 3 different elementary schools in Ankara, Turkey. Data about demographics and health conditions were obtained from survey questionnaires completed by parents.

RESULTS: Of the 1900 children, 15 children (0.8%) previously underwent tonsillectomy, 43 children (2.3%) had adenoidectomy and 80 children (4.2%) had T&A surgical histories. Multiple logistic regression analysis revealed that older students compared to younger ones [Odds Ratio (OR) = 1.15, $p=0.011$], and those who had parent-reported apnea compared to subjects without apnea were more likely to have URT surgery histories [OR=2.34, $p=0.001$]. Those children with surgery histories were more likely to have fathers with a higher educational level [medium level: OR=2.07, $p=0.012$; high level: OR=2.79, $p=0.001$ vs. low level] and the subjects had greater BMI percentiles [overweight: OR=1.71, $p=0.036$; obesity: OR=2.32, $p=0.003$ vs. healthy weight]. Children who had 1-2 URT infections per year [OR=0.47, $p=0.019$] had less probability of URT surgery histories, whereas those children

with AOM ≥ 3 times per year [OR=2.52, p=0.003] had more probability of URT surgery history.

CONCLUSIONS: We conclude that a reasonable explanation for higher rates of URT surgery among children with a high level of paternal education may originate from their awareness about URT associated diseases and possibly due to the ease of access to health care services.

Keywords: tonsillectomy, adenoidectomy, adenotonsillectomy (T&A), children

Table 1. Descriptive statistics (N=1900)

	Frequency (N)	Percent (%)
Gender		
Male	922	48.5
Female	978	51.5
Sibling numbers		
None	266	14.0
1	962	50.6
≥ 2	672	35.4
Mother Education Level		
Low	839	44.2
Medium	727	38.3
High	334	17.6
Father Education Level		
Low	509	26.8
Medium	736	38.7
High	655	34.5
Household Income		
Low	459	24.2
Medium	949	49.9
High	492	25.9
BMI classification		
Underweight	118	6.2
Normal weight	1374	72.3
Overweight	230	12.1
Obesity	178	9.4
URT infections prevalence		
None	204	10.7
1-2 times per year	988	52.0
3-4 times per year	507	26.7
≥ 5 times per year	201	10.6
Parent-reported apnea	174	9.2
Asthma	48	2.5
Allergic diseases	318	16.7
AOM prevalence		
None	1313	69.1
1-2 times per year	483	25.4
≥ 3 times per year	104	5.5
Surgery history associated with URT	138	7.3
Age (mean \pm SD)		8.92 \pm 1.76

BMI, Body mass index; URT, Upper Respiratory Tract; AOM, Acute otitis media

Table 2. Comparison of children with and without previous URT surgeries including tonsillectomy, adenoidectomy and adenotonsillectomy (N=1900)

	URT surgery history (-) (%)	URT surgery history (+) (%)	X ²	p*
Gender			3.14	0.076
Male	91.6	8.4		
Female	93.8	6.2		
Sibling numbers			2.69	0.260
None	91.7	8.3		
1	92.1	7.9		
≥2	94.0	6.0		
Mother Education Level			1.11	0.572
Low	93.4	6.6		
Medium	92.2	7.8%		
High	92.2	7.8		
Father Education Level			13.24	0.001
Low	96.1	3.9		
Medium	92.4	7.6		
High	90.5	9.5		
Household Income			4.69	0.096
Low	95.0	5.0		
Medium	92.2	7.8		
High	91.7	8.3		
URT infections prevalence			17.03	0.001
None	92.2	7.8		
1-2 times per year	94.8	5.2		
3-4 times per year	90.9	9.1		
≥5 times per year	87.6	12.4		
Parent-reported apnea			12.12	<0.001
Yes	86.2	13.8		
No	93.4	6.6		
Asthma			0.08	0.772
Yes	91.7	8.3		
No	92.8	7.2		
Allergic diseases			2.67	0.102
Yes	90.6	9.4		
No	93.2	6.8		
AOM frequencies			18.38	<0.001
None	93.8	6.2		
1-2 times per year	91.9	8.1		
≥3 times per year	82.7	17.3		

*: Chi-square test

URT, Upper Respiratory Tract; AOM, Acute otitis media

Table3. Multivariate logistic regression analysis of predictors associated with previous URT surgeries (n=1900)

	p	OR	95%CI (Lower – Upper)
Female (vs. Male)	0.169	0.77	0.53-1.11
Age	0.011	1.15	1.03-1.28
Sibling numbers			
None	Reference	Reference	Reference
1	0.962	1.01	0.60-1.70
≥2	0.311	0.73	0.40-1.33
Maternal Educational Level			
Low	Reference	Reference	Reference
Medium	0.564	0.88	0.57-1.35
High	0.266	0.70	0.37-1.31
Paternal Educational Level			
Low	Reference	Reference	Reference
Medium	0.012	2.07	1.17- 3.65
High	0.001	2.79	1.48- 5.26
Household Income			
Low	Reference	Reference	Reference
Medium	0.371	1.27	0.74-2.16
High	0.585	1.20	0.61-2.38
BMI percentile classification			
Normal weight (5-85%)	Reference	Reference	Reference
Underweight (<5%)	0.183	1.65	0.78-3.46
Overweight (85-95%)	0.036	1.71	1.03-2.82
Obesity (>95%)	0.003	2.32	1.34-4.02
Parent reported apnea (Yes vs. No)	0.001	2.34	1.41-3.87
Asthma (Yes vs. No)	0.712	0.81	0.27-2.41
Allergic diseases (Yes vs. No)	0.471	1.18	0.75-1.86
URT infections prevalence			
None	Reference	Reference	Reference
1-2 times per year	0.019	0.47	0.25-0.88
3-4 times per year	0.424	0.76	0.40-1.46
≥5 times per year	0.781	1.11	0.53-2.33
AOM prevalence			
None	Reference	Reference	Reference
1-2 times per year	0.286	1.26	0.82-1.92
≥3 times per year	0.003	2.52	1.37-4.65

BMI, Body mass index; URT, Upper Respiratory Tract; AOM, Acute otitis media

P-0395

Alternated or combined use of paracetamol and ibuprofen in the treatment of fever in children: There's evidence?

Simão Costa Martins¹, Joana Andrade Barros², Lisete Aires Silva², Sabrina Pedone², Sonia Marcelo²

¹USF Hygeia, Lixa, Portugal

²USF Terras de Souza, Paredes, Portugal

Background & AIM: Fever is a very common reason for consultation in children. In general, this entity does not last for long, is benign and should be understood as an adaptive body sign. Despite being effective, safe and cost-effective, there are few studies that clearly recommend alternate / combined use of the commonly used antipyretics. The aim of this study was to review the recommendations and gather existing evidence into practice/use of alternate and combined therapy of paracetamol and ibuprofen in the treatment of fever in children.

METHOD: There were researched clinical guideline standards (NOC), systematic reviews, meta-analyzes and randomized controlled trials (RCT), from Medline / Pubmed, Clinical Evidence, Evidence Based Medicine Online, National Guideline Clearinghouse, National Library of Guidelines, Canadian Medical Association Practice Guidelines, Cochrane Library, DARE, and Bandolier Index of Portuguese Medical Journals, from the last 10 years, in Portuguese and English, using the MeSH terms: "Acetaminophen / administration and dosage ", " Acetaminophen / therapeutic use ", " Ibuprofen / administration and dosage ", " Ibuprofen / therapeutic use ", " Fever ". To assess the level of evidence and strength of recommendation assignment, Strength of Recommendation Taxonomy of the American Academy of Family Physicians was used.

RESULTS: There were found 299 articles, which 18 selected articles: 5 systematic reviews, 10 randomized controlled trials and 3 guidelines.

The randomized controlled trials refers that it seems to exist an upper effect in fever reduction in children, with alternate or combined antipyretic therapy, however, the included systematic reviews and guidelines results, shows that this evidence is not strong enough to recommend this practice.

CONCLUSIONS: Combined and alternating therapy seems to reduce fever in children, more consistently, especially in the initial phase. However, more studies are needed to evaluate the safety / toxicity of these regimens in the pediatric population.

Keywords: Acetaminophen; Ibuprofen; Fever

Table 1

Authors	Year	Population	Conclusions	EL
Wong T, et al. ¹³	2013	Children with fever	There is some evidence alternated and combined antipyretic therapy is more effective than monotherapy in temperature reduction; There are still doubts as to the benefit from its use	1
Pereira GL, et al. ⁵	2012	Children ≤ 12 years	Downward trend in average temperatures; There is not enough evidence to say that this practice is more effective than monotherapy	1
Purssell E. ¹⁴	2011	Crianças com febre	Short evidence in the combined therapy; There is no increased toxicity despite this studies have small populations; This analysis suggests that the practice of combined treatment should not be encouraged	1
Nabais M. ¹⁵	2009	Children with fever	In most of the studies included the combined therapy was shown to be slightly superior than monotherapy; Important questions: small samples, lack of placebo control group, double-blinded population, use of incorrect doses of medication	1
Hay AD, et al. ⁷	2006	Children (6 months-6 years)	Limited evidence under the safety profile, efficacy and cost-effectiveness of combined therapy with acetaminophen and ibuprofen	1
Table 1: Systematic Reviews EL: Evidence Level				

Table 2

Entity	Authors	Year	Recommendations	EL	SR
Italian Pediatric Society Guidelines ¹⁰	Chiappini E, Venturini E, Principi N, et al.	2012	Acetaminophen and ibuprofen are the only antipyretics recommended in children; Combined or alternated use of acetaminophen is not recommended	3	B
American Family Physician ⁸	Hoover, L	2011	Further evidence is necessary to verify that the use of combined treatment can be used routinely in children's fever	3	B
NICE ¹⁷	Richardson M, et al	2007 (revised 2013)	Consider using acetaminophen or ibuprofen in children with fever and that appearing discomfort; Only consider using these alternated antipyretics if discomfort persists before the next dose	3	B
Table 2: CGS EL: Evidence Level; SR: Strength of Recommendation					

Table 3

Authors	Year	Population	n	Conclusions	EL
Paul IM, et al. ¹⁰	2010	Children (6-84 months)	46	During the 6 hour observation period, the combined or alternated treatment promotes greater antipyretic effect than ibuprofen alone	2
Hay AD, et al. ¹⁴	2009	Children (6 months - 6 years)	156	Children in this ages should use ibuprofen first; However it must take into account the risks and benefits after more than 24 hour of ibuprofen and acetaminophen use	1
Hay AD et al. ²⁵	2008	Children with fever	156	The combination of acetaminophen and ibuprofen results in a greater fever reduction than acetaminophen isolated; The authors admit that safety has not been well studied	2
Hollingshurst S, et al. ⁴	2008	Children (6 months - 6 years)	156	There is no reliable evidence of cost differences between treatments; The combinations of clinical and cost analysis seems to indicate that combined treatment is more cost-effective	2
Hay AD, et al. ²	2008	Children (6 months - 6 years)	156	To maximize the time without fever, use ibuprofen first; After 24 hours, weigh risks and benefits of using ibuprofen over acetaminophen	2
Kramer LC, et al. ⁷	2008	Children (6 months - 6 years)	82	The alternated use of acetaminophen and ibuprofen significantly reduces fever for 4 to 5 hours compared to acetaminophen alone; The efficacy difference was not perceived by parents	2
Nabulsi MM, et al. ⁶	2006	Children (6 months - 14 years)	143	Alternated treatment with acetaminophen and ibuprofen appears to have superior antipyretic effect than ibuprofen alone	2
Erlewyn-Lajeunesse MD, et al. ⁹	2006	Children (6 months -10 years)	123	Combined therapy is superior in temperature reduction compared with acetaminophen alone; No difference was observed between combined therapy and ibuprofen alone	2
Sarrell EM, et al. ³	2006	Children (6- 36 months)	464	Combined therapy every four hours during three days is more effective in fever reduction	2
Table 3: RCT EL: Evidence Level					

P-0396**Montelukast and allergic rhinitis in children: is there evidence?**C. Pina¹, J. Pais¹, M. Lopes²¹Cuidar Family Health Unit, Santa Maria da Feira, Portugal²Famílias Family Health Unit, Santa Maria da Feira, Portugal**Background & Aim**

Allergic rhinitis (AR) is one of the most common chronic diseases of childhood. In Portugal, montelukast is not yet approved in symptomatic treatment of AR.

The aim of this review is to assess the effect of montelukast on the reduction of AR symptoms.

Methods**Data Sources**

A search for meta-analyses, systematic reviews, clinical guidance and controlled and randomized clinical trials was conducted in Medicine Based on Evidence databases (National Guideline Clearinghouse, Guidelines Finder, Canadian Medical Association Practice Guidelines Infobase, The Cochrane Library, Clinical Evidence, DARE, Bandolier and Pubmed).

Review methods

Articles included were published between January 2006 and February 2015 in English, Portuguese and Spanish To assess the quality of the studies and establish the strength of recommendation the Strength of Recommendation Taxonomy (SORT) scale of the American Family Physician was used.

Results

29 articles were obtained from the research, of which five met the inclusion criteria: one controlled and randomized clinical trials and four standards of clinical guidance. Montelukast appears useful in the treatment of AR with different recommendations between seasonal and perennial AR.

Conclusions

The majority of standards of clinical guidance analyzed showed a decrease of allergic symptoms with montelukast in seasonal AR. However, in perennial AR more studies with higher quality are needed to clarify evidences and establish recommendations.

Keywords: allergic rhinitis, montelukast, paediatrics

Table 1. Clinical Guidance

Reference	Conclusions	Strength of Recommendations	Evidence Level
"Management of rhinosinusitis and allergic rhinitis" Singapore Ministry of Health Feb 2010	montelukast - treatment option for seasonal allergic rhinitis in children over 6 years of age.	A	1
	It should not be used more than 4 weeks (limited data of its efficacy in persistent allergic rhinitis)	A	1
"Allergic Rhinitis and its Impact on Asthma" (ARIA) 2010 Revision	Suggests montelukast in children with seasonal allergic rhinitis.	Condicional	1
	Suggests in preschool children with perennial allergic rhinitis	Condicional	3
"Diagnosis and treatment of respiratory illness in children and adults". Institute for Clinical Systems Improvement. Bloomington Jan 2013	Montelukast is as effective as loratadine and less effective than nasal steroids.	A	1
	May be considered as a third line option to ad after the failure of a nasal corticosteroid as an oral antihistamine	A	1
"The diagnosis and management of rhinitis: An updated practice parameter" American Academy of Allergy 2008	Oral anti-LT agents alone, or in combination with antihistamines, have proven to be useful in the treatment of allergic rhinitis.	A	1

Table 2. Randomized Clinical Trial

Reference	Sample	Population	Intervention	Results	Evidence Level
Apassorn Watanasomsiri et al. "Efficacy of Montelukast and Loratadine as Treatment for Allergic Rhinitis in Children". Asian Pacific Journal of Allergy and Immunology (2008) 26: 89-95	n=178	Children 6 to 15 years old with a clinical history of perennial allergic rhinitis for at least 1 year.	<ul style="list-style-type: none"> Loratadine 5mg or 10mg (<30Kg and ≥ 30Kg, respectively alone Loratadine plus montelukast 5mg Loratadine and placebo <small>(For 2 weeks at bedtime)</small>	There appears to be a significant complementary benefit for nasal decongestion but not for other symptoms when montelukast and loratadine are co-administered	2

P-0397

Child sleep disorders in family medicine practice.Clinical study 2003-2014

Valeria V Herdea¹, Laura T Comnea(herdea)², Lidia T Soldea(herdea)³, Alexandru T Herdea⁴, Teodor Gh Herdea⁵

¹Herdea Valeria private practice Bucharest, Romania

²Comnea Laura private practice Bucharest Romania

³Soldea Lidia Emergency Hospital Bucharest Romania

⁴Herdea Alexandru Medicine University Bucharest

⁵Herdea Teodor private practice Bucharest

Background: The high frequency of sleep disorders in children, the negative mark on somatic and neuropsychological development, challenges in finding optimized solutions for early detection and correct treatment, determined this study.

Aim: Presenting the impact of sleep disorders in pediatric pathology

Objectifs

1. Children sleep disorders issue in family medicine practice
- 2.Cause–effect relation study in sleep pathology.
- 3.Prevention, diagnosis, early treatment correlation with quo ad vitam prognosis in patients with sleep disorders.

Study design

This retrospective observational study covered a period between 2003-2014. In that period we have 129,732 consultations, from 0-95 years old, in two family medicine practices(Total=3800 patients).70.5% of requests for medical services are children 0-18 years, from wich, age 0-5 years, represent approx.48%. 50% of children under 5 years present respiratory diseases, of which 24% -severe forms, mostly in cold season(Romania-7 months/year).We observed: consultations/years, age, sex, respiratory diseases (respiratory disfunction, ear infections, hearing loss, need for prosthetic, neurological simptoms, acute and chronic sleep disorders) About 35% from patients accused sleep disorders. Analysis revealed multiple causes: 34.5%organic causes(35% epilepsy, 21%enrolled in functional brain syndrome disorders, 2%tumors, post-traumatic states 8%, 20% infectious pathology, 7%autoimmune, 7% other causes)and 65.5% are functional.

We present: patient approach, decision tree/algorithm, co-morbidities, treatments, interdisciplinary communication role

Conclusion

- 1.In the past 6 years, the addressability to the GP’s in the issue of sleep disorders has increased by over 15% comparing with the first 6 years of the study as result of educational activities: for HCP=patient centered care and oriented especially to patients.

2.The "sleep disorder"="tip of the iceberg" that announce a large number of chronical diseases and whoose care are extremly burdening for the GP's.

3.Presentation, active early detection, diagnosis, monitoring of sleep disorders are vital, because long-term implications are severe, impacting the entire existence of the patient and high cost for society.

Keywords: sleep disorders, interdisciplinary team, communication, education, patient centered care

P-0398

"Why is my penis different?" HYPOSPADIAS DIAGNOSED IN PRE-ADOLESCENCE: A case report

Ana Beatriz Figueiredo, Mariana Gayo, Maria Manuela Bernardo, Pedro Alves
USF das Conchas, Lisbon, Portugal

INTRODUCTION: Hypospadias is one of the most common congenital anomalies, with a worldwide incidence between 0.3 to 0.7% of male births. It results in an abnormal opening of the male urethra on the ventral side of the penis or scrotum causing large impact on the genitourinary function.

This idiopathic disease has multiple risk factors associated to its development, such as advanced maternal age, gestational diabetes, exposure to estrogenic compounds, family history of hypospadias and toxic exposure.

Hypospadias is usually detected in the newborn examination and surgical correction should be performed within the first 18 months of life.

CASE PRESENTATION: An 11 year old boy, belonging to a nuclear family, with 2 siblings, denies any personal history of previous diseases or hospital admissions. Both parents are smokers. At the age of 8, he experienced a urinary tract infection with dysuria and haematuria and he was medicated with antibiotics. The boy began to mention to this mother that he was unable to void without straining. Furthermore, his father often commented that this penis was "crooked and very unusual". At the age of 11, during routine physical examination, it was diagnosed paraphimosis and hypospadias. He was referred to pediatric surgery for surgical correction.

COMMENT: The general practitioner or family doctor plays an extremely important role in the identification of hypospadias in global health examination during the first year of life in order to perform surgical correction on time. Late diagnosis is uncommon. Patients with hypospadias often develop low urinary tract symptoms like urinary stream changes and recurrent urinary tract infections. This disorder may also have an impact in patients' self-perception, particularly in preteens when they are starting to unveil their own body.

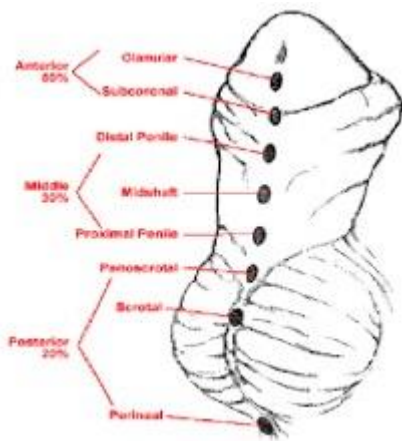
In case of late diagnosis and surgical correction, the risk of post-surgical complications increases significantly.

Keywords: Hypospadias, paraphimosis, preteen, late diagnosis, pediatric surgery

Case Report

IDENTIFICATION		HEALTH PROBLEMS (ICPC-2)	
<ul style="list-style-type: none"> • 11 year old boy •Nuclear family, with 2 siblings, IV-stage Duvall cycle, •No personal history of previous diseases or hospital admissions •Both parents are smokers 		<ul style="list-style-type: none"> •At 8-YEARS-OLD: UTI (U71) with dysuria and haematuria → Treatment: Antibiotics 	
REGULAR APPOINTMENT - 2015.01.14			
S	The children came for a regular appointment.		
O	When the doctor asked about his finding during the examination, the mother remembered that the boy often mentioned that he was unable to void without straining and his urinary stream resembled "jet spray" . Furthermore, his father often commented that his penis was "crooked and very unusual"		
A	Abnormal opening of the urethra and balanopreputial adhesions		
P	Hypospadias and Balanopreputial adhesions Pediatric Surgery		

Hypospadias Classification



Before Surgery



After 1st surgery - 27-04-2015



P-0399

A Sudden Onset of Bladder Bowel Dysfunction in a Child: A Case Report

Inês Domingues Teixeira, Ana Menezes Sanches

Unidade de Saúde Familiar Ribeira Nova, Acs Lisboa Central, Lisboa, Portugal

BACKGROUND & AIM: Lower Urinary Tract Symptoms (LUTS) in children are one of the most common conditions in Primary Care. They may cause considerable physical and psychological distress to children and their families. In this case, the sudden onset of LUTS, perceived by a worried mother, opens a wide range of differential diagnostics.

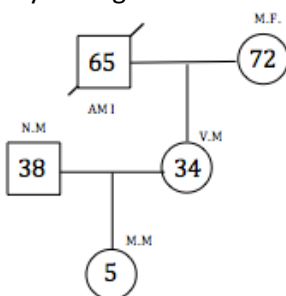
METHOD: We report the case of a 4-year-old girl who is brought by her mother because of urgency and pollakiuria with 15 days of evolution. She voids 15-20 times per day and has no history of enuresis, incontinence or other symptoms. The condition has started a week after taking an antibiotic for an upper respiratory tract infection. Her physical examination was normal. All the exams requested (urine and blood analysis, ultrasound of the urinary tract) were normal. One-month after closely work with her mother, to understand and identify symptom patterns and behaviors, the major cause identified was a chronic constipation. A treatment plan, based on positive reinforcement, behavioral techniques and dietary adjustments was established and, gradually, a clinical improvement was noticed.

RESULTS: The initial approach aimed at excluding acute or severe causes of LUTS through complementary exams. After normal results and a comprehensive approach of medical and behavioral factors, bladder bowel dysfunction (BBD) became the most probable cause. Although BBD is a frequent condition, the sudden onset of the symptoms is an unusual presentation. The respiratory infection seems to be the triggering factor. Most of the patients with BBD respond to urotherapy and don't need medications or surgical procedures.

CONCLUSIONS: This case report represents an example of the role of Family Doctor in evaluating and treating LUTS. The sudden onset of the symptoms allowed us to describe all the steps required to do this approach. At the end, this case revealed a less typical presentation of BBD.

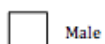
Keywords: Child, Lower Urinary Tract Symptoms, Constipation

Family Genogram. Date: 04.03.2015



Legend:

AMI - Acute Heart Infarction



Male



Female



Deceased

Schematic Example of BBD



P-0400

One door to open

Vítor Portela Cardoso¹, Paula Mendes², Cláudia Melo¹

¹USF Gualtar, ACES Cávado I, Braga, Portugal

²USF Maxisaúde, ACES Cávado I, Braga, Portugal

Background and AIM: Imperforate hymen (IH) is one of the most common congenital anomalies of the female genital tract (1/2000). A rare complication is the dilatation of the vagina (hematocolpos) secondary to retention of successive menstruation. The clinical presentation is highly variable: from an asymptomatic form until symptoms related to the obstruction and local compression. Timely treatment is important to prevent adverse consequences in the sexual and reproductive lives.

METHODS: Case report.

RESULTS: We report the clinical case of a 11 years-old teenager without a family doctor and a history of multiple episodes of use of health services in the last 4 months by pain in the lumbosacral region associated with pollakiuria and dysuria. On January 6, 2013, she came with his mother to an urgency medical consultation in primary health care with the same complaints. Faced to a female teenager on Tanner stage IV without menarche, the physical examination was performed, diagnosing an IH associated with hematocolpos. The teenager was quickly referred to the referral hospital, where it was conducted an himenotomia with a favorable outcome and resolution of complaints.

CONCLUSION: This case report shows on one hand the beneficial impact of the child and juvenile health programmes on the primary care settings by its periodic examinations. On the other hand, seeks to draw attention to inequalities in the primary care in Portugal.

Keywords: imperforate hymen, hematocolpos, primary care, adolescent health, child health

P-0401

Faint: Syncope... Rhabdomyolysis

Ibrahim Güneş¹, Özden Gökdemir¹, Gizem Çiçek², Nilgün Özçakar¹

¹Dokuz Eylul University Medical Faculty Department Of Family Medicine

²Dokuz Eylul University Medical Faculty Department Of Pediatrics

Aim-BACKGROUND: Rhabdomyolysis occurs by release of creatine kinase in an injury to muscle tissue. Triads of symptoms are myalgia, weakness and dark urine. Common cause of rhabdomyolysis among children is viral infections. Others include trauma, connective tissue diseases, toxins and exercise.

CASE: The patient admitted to Emergency Service because of fainting in changing room before sports lesson. He didn't remember syncope moment.

Physical examination: Conscious, Glasgow Coma Rating:15, Reflexes:Active, Systemic examinations:Normal. During follow-up he vomited 3 times. Right after syncope declared TA:160/90mmHg. ControlTA:125/75mmHg CKMB:300U/L, BUN:24mg/dl, Creatinine:2.27mg/dL, Aspartate transaminase:1328U/L, Myoglobinuria in spot urine(1miyoglob>1100) and proteinuria(p/cre 3.6). Hydrated (3000cc/m2 5%saline) and fluid intake and urinary output were noted.

Urinalysis: pH:6.0 HC03:200mEq Uric acid:9.52. Allopurinol was started for urinary alkalinization. rr' pattern and right axis deviation was noted on Electrocardiography and monitored. GFR was 66, calculated with Schwartz formula. Urine output was 0.9 cc/kg/h, single dose mannitol of 0.5 g/kg administered.

Renal Doppler Ultrasonography:Bilateral increased parenchyma echogenicity. Abdominal CT:Ordinary Patient was admitted to Pediatric intensive Care Unit with acute renal failure. Patient was stable during follow up. MAP was >65, RR:18/min. EEG:Normal. Urinalysis: Hb:10mg/L, protein:0.5g/L, erythrocyte:38, WBC:7. Daily urinalysis was performed.

DISCUSSION: Viral myositis is self-limited in children, but causes muscle weakness and rhabdomyolysis in rare cases. Many virus leads myositis, influenza is the most common. It leads benign acute childhood myositis, progresses to rhabdomyolysis rarely. It's presented with failure to active or passive dorsiflexion or refuse to walk.

Severe rhabdomyolysis presents serious complications such as renal failure, fluid-electrolyte abnormalities, cardiac arrhythmia etc. Other complications are respiratory failure due to necrosis in respiratory muscles/muscle weakness, infection and pulmonary embolism. Patients cure completely with adequate treatment in many cases. As family physicians, we want to emphasize in this case consideration myoglobinuria in macroscopic hematuria and although rare is to attempt preventing complications,

Keywords: rhabdomyolysis, macroscopic hematuria, viral myositis, acute renal failure

P-0402

Childhood Obesity – Management in Primary Care Setting

Pedro Cardoso Ferreira¹, Sara Cunha², Sophie Sousa²

¹Unidade de Saúde Familiar Dunas, Unidade Local de Saúde de Matosinhos

²Unidade de Saúde Familiar Oceanos, Unidade Local de Saúde de Matosinhos

Background & Aim

Childhood obesity is increasing at an alarming rate worldwide. According to the European Commission, Portugal is one of European countries with more overweight children, with one in three children being obese. The BMI percentile for age and gender in youths determines whether the child is overweight (BMI \geq 85th percentile and $<$ 95th percentile), or obese (\geq 95th percentile). Portuguese Association Against Childhood Obesity's 2013-2014 data shows that 33,3% of the children between 2 and 12 years old are overweight, and 16,8% of which are obese. It is imperative that health care providers identify overweight and obese children so that counseling and treatment can be provided.

The aim of this review is to propose an algorithm to help the management of overweight and obese children in the primary care setting.

Method

PubMed based review study was made. Review articles, guidelines and clinical orientation norms between 2010 and 2015 were included.

MeSH terms: children, overweight, obesity, pediatric obesity and primary care.

Results

If a child is overweight or obese, the evaluation should identify treatable causes and comorbidities, starting with a complete history and physical examination. The proposed algorithm enables these children's management, including eventual laboratory and radiological screening, therapeutic approaches and indications for referral.

Conclusions

Primary prevention is essential against overweight and obesity.

One of the six core competences of family physicians is primary care management, so it is important to master effective and appropriate health services utilization to reach efficiency.

Pediatric obesity is associated with long-term health consequences. The main focus of primary care physicians should be finding and changing behavioral and environmental factors, which can be modifiable during childhood. An early intervention is efficient and can delay or prevent a referral.

Keywords: MeSH terms: children, overweight, obesity, pediatric obesity and primary care.

P-0403

Protocol of Orthopaedic Infantile follow-up of the Upper Member in Primary Attention Care

Rosario Martinez Fuerte¹, Iker Sierra Martinez², Leticia Sierra Martinez¹, Natalia Sanz González³

¹Valladolid Este Primary Assistance Gerency, Castile and Leon Sacyl, Valladolid, Spain

²Traumatology Department, Hospital of Medina de Campo (Valladolid), Spain

³Parquesol Senior Center, JCYL Social Serices Gerency, Valladolid, Spain

Background

Centring the professionals of primary care on the managing of the orthopaedic infantile pictures of the upper extremities of major demand on the consultations.

Methods

Develop a Protocol of Orthopaedic Infantile follow-up of the upper Member in Primary Attention Care.

RESULTS:

The child skeleton is a cartilaginous sketch that, as it grows, is capable of suffering physiological alterations or not, in his development and correct formation, due to multiple factors, for what him knowledge of the normal thing and the abnormal thing for every phase of the musculoskeletal development will do us to feel more comfortable as doctors responsible for the primary care before an orthopaedic infantile problem. A precise diagnosis will take us to an appropriate treatment, that is to say, necessarily, in that the benefits are major that the risks and the negative psicosocial effects. So much Pediatricians, Doctors of Primary Care like Infantile Orthopaedists we have attended children controlled unnecessarily, or that have suffered the use and abuse of treatments ortésicos unnecessary.

CONCLUSIONS:

The authors propose this protocol with the intention of centring the professionals of primary care on the managing of the orthopaedic infantile pictures of the upper extremities of major demand on the consultations, frequently phases and variations of the physiological development of the child, for his correct follow-up, diagnosis and / or derivation the specialist if this way it proceeds.

Keywords: Orthopaedic Infantile; musculoskeletal traumatic; primary care.

P-0404

Assessment of Risk Factors for Hearing Loss and the Results of Hearing Screening Tests for the Newborn

Hacı Ömer Sezer¹, Kenan Topal¹, Çiğdem Gereklioğlu², Ümit Çelik³, İlhami Yıldırım⁴

¹Adana Numune Training and Research Hospital, Department of Family Medicine, Adana/Turkey

²Baskent University Medical Faculty, Department of Family Medicine, Ankara/Turkey

³Adana Numune Training and Research Hospital, Department of Pediatrics, Adana/Turkey

⁴Adana Numune Training and Research Hospital, Department of Otorhinolaryngology, Adana/Turkey

BACKGROUND: Hearing loss is the most common congenital defect worldwide and also the sensory loss affecting psychosocial and academic development of children most. We aimed to evaluate the risk factors in the babies undergoing hearing screening tests and to evaluate the adequacy of the services given to the mothers in primary care.

MATERIAL-METHOD: This cross-sectional study was conducted with 253 babies between 1 March 2014 and 30 April 2014. A structured questionnaire form was applied and the results of the Transient Evoked Otoacoustic Emissions (TEOAE) and the Auditory Brainstem Response (ABR) tests were recorded. Chi-square and Mann-Whitney U test were used for data analysis. Fisher's exact test was applied in 2x2 tables and Monte Carlo simulation was applied in r x c tables. A p level of <0.05 was accepted as statistically significant.

RESULTS: Mean age of the babies was 29.1±45.3 days. Ratio of failure increased as age increased (p=0.0001). The ratio of the mothers who experienced a systemic disease during pregnancy was higher among the babies who failed the test (p=0.031). Eighteen babies failed the tests and were referred to another institution for further evaluation. Consanguinity (25.7%), staying for longer than 5 days in newborn intensive care unit (23.7%) and the

mother's experiencing a systemic disease during pregnancy (10.7%) were the main risk factors. Of the mothers, 79.4% (n=201) stated that they were satisfied from the services given in primary care, 78.7% (n=199) stated that family physicians cared them much.

CONCLUSION: Hearing loss should be detected in the early period, because these children may achieve speech, cognitive, social and emotional development close to their peers through providing a proper hearing device and commencing regular hearing rehabilitation programs early.

Keywords: Newborn, hearing loss, risk factors, hearing screening tests

P-0405

Case Report: Postnatally acquired neonatal varicella despite maternal immunity

Grace Lum

Division of Family Medicine, Department of Medicine, National University Health System, Singapore

Background and aim: Neonatal varicella is usually transmitted in utero, and can be severe and fatal. Less commonly, it is acquired postnatally. It is widely understood that transplacental transfer of maternal immunoglobulins protects neonates from the varicella zoster virus (VZV), while their innate immunity is immature. We report a case of neonatal varicella occurring in a full-term infant, born to a mother who attained immunity to VZV in her childhood, and review existing literature of similar cases.

METHOD: Case Summary. A 20 day old neonate, born full term with good birth weight, developed a varicella rash, with no known history of exposure. Diagnosis was confirmed with detection of VZV DNA in infant serum. Antenatal and perinatal history was unremarkable, and household contacts were unaffected. His mother had varicella as a child, and immunity was confirmed through laboratory testing of antibody levels. The neonate was treated with intravenous acyclovir for 10 days, and recovered uneventfully.

Results: In healthy term infants, placentally transferred immunoglobulins equal or even surpass maternal levels. There are 4 previous case reports of neonates developing varicella following exposure to siblings with varicella, despite maternal immunity. Another 5 cases of infants 1-2 months old who acquired varicella during an outbreak were reported, who had pre-existing detected VZV antibodies but with low titres. In all cases, disease course was mild. Infection occurred likely in presence of low maternal titres. Varicella zoster immune globulin (VariZIG) can be considered following exposure in some cases. Acyclovir is used for severe varicella and is generally not required after 2 weeks of age.

Conclusion: Maternal varicella antibodies do not necessarily prevent infection in neonates, but reduce severity of illness. Despite known maternal immunity, physicians should remain open to diagnosis of neonatal varicella, and also educate parents on exposure prevention, such as isolating infected siblings.

Keywords: neonatal varicella, maternal antibodies, passive immunity

Image 1



Generalised vesicular varicella rash developed on this previously-well 20 day old neonate, though his mum was immune and would have presumably given him protective antibodies.

P-0406

Henoch Schönlein Purpura Accompanied By Cerebral Involvement: A Case Report

Pınar Fakirullahoğlu, Özlem Özer, Halime Pınar Demiröz, Kenan Taştan
Atatürk University, Medical Faculty, the Department of Family Medicine and Research and Application Center for Methods of Acupuncture and Complementary Medicine, Erzurum

INTRODUCTION: Henoch Schönlein Purpura (HSP) is a small-vessel vasculitis most common during childhood. Its etiology is unknown. It is accompanied by arthralgia and purpura, and frequently has gastrointestinal and renal involvement, and 1 % cerebral involvement. It is usually self-limiting and benign. We are going to present the case of a 14 year-old boy complicated with convulsion as a result of cerebrovascular involvement.

The CASE: A 14 year-old male patient consulted upon having complaints of abdominal pain, vomiting and rash starting at the feet and spreading upwards that began two days ago. He was observed to have rashes starting at the medial malleolus of the two feet and spreading upwards, not fading when pressed, not itchy, macular vasculitis. The abdominal examination indicated common sensitivity and other systems were found to be normal. In the first examinations of the patient GGK (+), there was trace protein in urogram. The patient had numerous abdominal pain attacks and had sensitivity in abdominal examination; however the feature was not observed in the standing abdominal x-ray and abdominal USG. No findings were observed in favor of invagination, either. The biochemical parameters, taken when he was observed to have generalized tonic-clonic style convulsion lasting 3-4 minutes, were normal. The cranial CT and neurological examinations were normal, he was not observed to have meningeal irritation signs, and a treatment of 1 mg/kg/day dose prednol was started.

Results and DISCUSSION: HSP is a benign vasculitis causing serious musculoskeletal system, gastrointestinal system, kidney and, though rarely, central nervous system involvement. The cerebral involvement rarely seen in our patient showed itself with generalized tonic-clonic convulsion. In conclusion, as seen in our case, it should not be forgotten that patients followed with pre-diagnosis of HSP may have headaches, mental state changes or cerebral involvement coming with convulsion.

Keywords: purpura, cerebral, convulsion

P-0407

What Mothers Think About Breast Milk Banks in Turkey?

Zeynep Sayın Dincer¹, Aybüke Demir Alsancak¹, Zeynep Keskin¹, Duygu Ayhan Başer¹, Gökhan Dincer², Yakup Alsancak³, Ufuk Beyazova⁴

¹Department of Family Medicine, Ankara Numune Training and Research Hospital, Ankara, Turkey

²Department of Family Medicine, Ankara Training and Research Hospital, Ankara, Turkey

³Department of Cardiology, Ankara Atatürk Training and Research Hospital, Ankara, Turkey

⁴Department of Social Pediatri, Gazi Üniversitesi, School of Medicine, Ankara, Turkey

Background and AIM: If new born baby's don't reach own mother's milk for any reason, human milk bank provide this baby's nutritional needs from donor mother. These institutions collect, screen, processes and dispepses milk and all these procedure are made according to international standardization methods. Breast milk banking studies in Turkey being continued but quite different opinions has been raised about issues medical and socio-cultural dimensions. The aim of the study was to determine knowledge and views of women living in Ankara towards breast milk banks.

METHOD: The descriptive research was conducted between August - July 2014. The study population comprised women who gave at least one birth and who presented to Gazi University Medical Faculty Hospital Social Pediatri polyclinic. The data were collected by a questionnaire form developed by researchers. The questionnaire form included open-ended and closed questions regarding the descriptive characteristics and about knowledge and views of mothers on milk banking. Data were analyzed with SPSS 16.

RESULTS: We interviewed 440 mothers but showing here the preliminary results from the first 100 participant. Of the women surveyed, 58% indicated they had not previously heard anything about breast milk banking. 65.0% said that they could donate their milk. 48,5% Of mothers who do not want to donate their milk stated that they

would not have enough milk and 40% of them said it constituted a problem from a religious aspect. 51% would not accept donated breast milk for their baby. There were three main reasons of not to accept bank's milk. Respectively: fear of transfer of diseases (41.1%), religious beliefs (39,2%), and grudge (9%).

CONCLUSIONS: Although a lot of discussion, poor knowledge on the matter was observed. As long as detailed records are kept and sufficient knowledge is given to the mothers, milk banking seems appropriate for women.

Keywords: Breast Milk bank, Mother, Views,

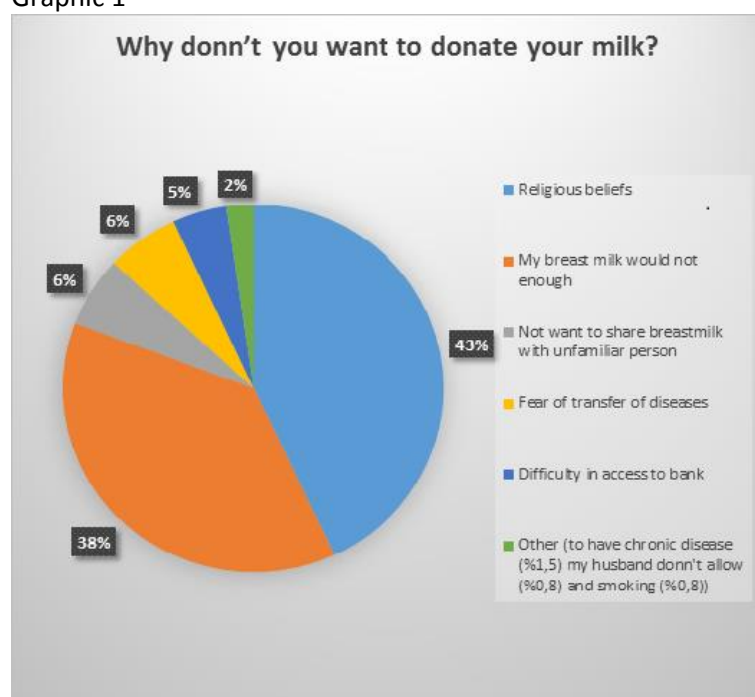
TABLE 1

Demographic data and factors influencing women's views on milk donation in milk banks				
	TOTAL N(%)	If necessary would you donate your milk?		<i>P</i> <i>Value</i>
		YES	NO	
AGE				
18-35 Years	276 (62,9)	185 (60,1)	90 (68,7)	,028
36-45 years	127 (28,9)	91 (29,5)	37 (28,2)	
>45 years	36 (8,2)	32 (10,4)	4 (3,1)	
EDUCATION				
Under of High School	176 (40,1)	138 (78,4)	38 (21,6)	,002
High school and Higher	263 (59,9)	170 (64,6)	93 (35,4)	
FAMILY TYPE				
Nuclear family	392 (89,3)	271 (69,1)	121 (30,9)	,234
Extended family	47 (10,7)	37 (78,7)	10 (21,3)	
OCCUPATION				
Home duties	291 (66,3)	213 (69,2)	78 (26,8)	,051
Officer	148 (33,7)	95 (64,2)	53 (35,8)	
NUMBER OF CHILD				
1 and 2	332 (75,6)	231 (69,6)	101 (30,4)	,639
? 3	107 (24,4)	77 (72,0)	30 (28,0)	
Do you have 0-2 years old child?				
Yes	203 (46,2)	136 (67,0)	67 (33,0)	,179
No	236 (53,8)	172 (72,9)	64 (27,1)	
Breast-feeding status of children				
Yes	160 (78,8)	103 (64,4)	57 (35,6)	,117
No	43 (21,2)	33 (76,7)	10 (23,3)	
Average breastfeeding per child				
? 6 Month	118 (26,9)	92 (78,0)	26 (22,0)	,030
>6 Month	321 (73,1)	216 (67,3)	105 (32,7)	
Do you know about mother's milk banking?				
Yes	250 (56,9)	185 (74,0)	65 (26,0)	,043
No	189 (43,1)	123 (65,1)	66 (34,9)	
Have you worked as wet-nurse before?				
Yes	64 (14,6)	58 (90,6)	6 (9,4)	,000
No	375 (85,4)	250 (66,7)	125 (33,3)	
Have you had wet-nurse breastfeed your children?				
Yes	46 (10,5)	37 (80,4)	9 (19,6)	,150
No	393 (89,5)	271 (69,0)	122 (31,0)	

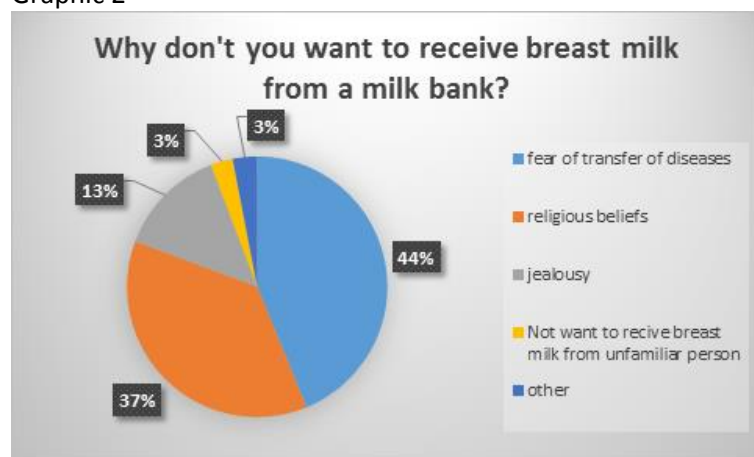
TABLE 2

Demographic data and factors influencing women's views on milk donation in milk banks				
	TOTAL N(%)	If necessary would you donate your milk?		P Value
		YES	NO	
AGE				
18-35 Years	276 (62,9)	185 (60,1)	90 (68,7)	,028
36-45 years	127 (28,9)	91 (29,5)	37 (28,2)	
>45 years	36 (8,2)	32 (10,4)	4 (3,1)	
EDUCATION				
Under of High School	176 (40,1)	138 (78,4)	38 (21,6)	,002
High school and Higher	263 (59,9)	170 (64,6)	93 (35,4)	
FAMILY TYPE				
Nuclear family	392 (89,3)	271 (69,1)	121 (30,9)	,234
Extended family	47 (10,7)	37 (78,7)	10 (21,3)	
OCCUPATION				
Home duties	291 (66,3)	213 (69,2)	78 (26,8)	,051
Officer	148 (33,7)	95 (64,2)	53 (35,8)	
NUMBER OF CHILD				
1 and 2	332 (75,6)	231 (69,6)	101 (30,4)	,639
? 3	107 (24,4)	77 (72,0)	30 (28,0)	
Do you have 0-2 years old child?				
Yes	203 (46,2)	136 (67,0)	67 (33,0)	,179
No	236 (53,8)	172 (72,9)	64 (27,1)	
Breast-feeding status of children				
Yes	160 (78,8)	103 (64,4)	57 (35,6)	,117
No	43 (21,2)	33 (76,7)	10 (23,3)	
Average breastfeeding per child				
? 6 Month	118 (26,9)	92 (78,0)	26 (22,0)	,030
>6 Month	321 (73,1)	216 (67,3)	105 (32,7)	
Do you know about mother's milk banking?				
Yes	250 (56,9)	185 (74,0)	65 (26,0)	,043
No	189 (43,1)	123 (65,1)	66 (34,9)	
Have you worked as wet-nurse before?				
Yes	64 (14,6)	58 (90,6)	6 (9,4)	,000
No	375 (85,4)	250 (66,7)	125 (33,3)	
Have you had wet-nurse breastfeed your children?				
Yes	46 (10,5)	37 (80,4)	9 (19,6)	,150
No	393 (89,5)	271 (69,0)	122 (31,0)	

Graphic 1



Graphic 2



P-0408

Prevalence of Bullying and victimization rate among School children at Riyadh City, KSA

Mohammed Abdullah Alrowaily, Mostafa Abolfotouh, Hind Alshatri, Abdulrahman Kariri, Omar Mudifer
King Saud bin Abduaziz University for Health Sciences

Aim. Bullying among school-aged adolescence has been recognized as problematic behavior among adolescents, affecting school achievement, pro-social skills, and psychological well-being for both victims and perpetrators. This study aims to determine the prevalence of Bullying and its types amongst school adolescents.

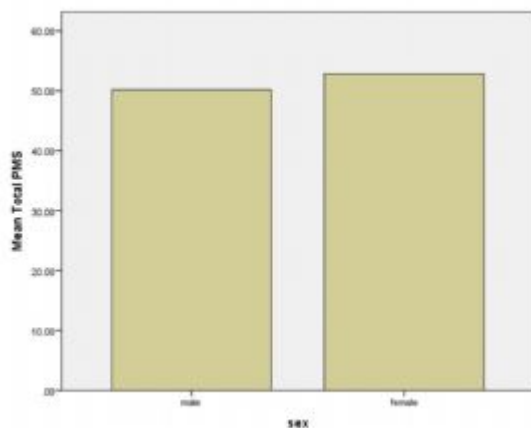
Methods. In a cross sectional study, 2588 school adolescents at governmental schools (n=2093) and Selective Private schools from Riyadh city(n=495), ages 12-15 years, were subjected to the Peer Relation Questionnaire (PRQ) for Bullying. This questionnaire contains 3 sub-scales (Bully scale, Victim scale, and Pro-social scale). Data on personal characteristics of the adolescent (age, sex, school grade, adolescence stage), family related data (marital status of parents, family coherence, consanguinity, number of children in the family, social class, education and occupation of both parents), history of chronic and or psychiatric diseases (conditions) in the family, were collected. Descriptive and analytic statistics were applied and significance was considered at $p \leq 0.05$.

Results. Significantly higher percentage mean scores of bullying on PRQ were shown in early adolescent ($f=11.03$, $p < 0.001$) female students ($t=7.13$, $p < 0.001$), in private schools ($t=5.24$, $p < 0.001$). Female students showed significantly higher score for bully scale (45.0% versus 36.8%, $t=16.08$, $p < 0.001$), pro-social scale (76.3% versus 71.7%, $t=7.19$, $p < 0.001$) and significantly lower score for victim scale (37.2% versus 42.0%, $t=8.70$, $p < 0.001$) than male students. After adjustment for potential confounders, female gender ($t=4.78$, $p < 0.001$), earlier adolescence stage ($t=3.35$, $p=0.001$) and private schooling ($t=5.24$, $p < 0.001$) were significant predictors of bullying among adolescents.

Conclusion. Bullying and victimization are common among Saudi early adolescents in private schools, with more bully among females and more victimization among males. Timely bullying prevention and interventions are necessary, with a special focus on students in private schools.

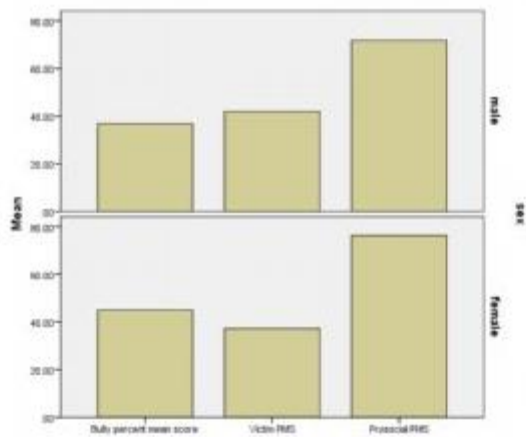
Keywords: Bullying, Victimization and school children

Fig.1 sex differences



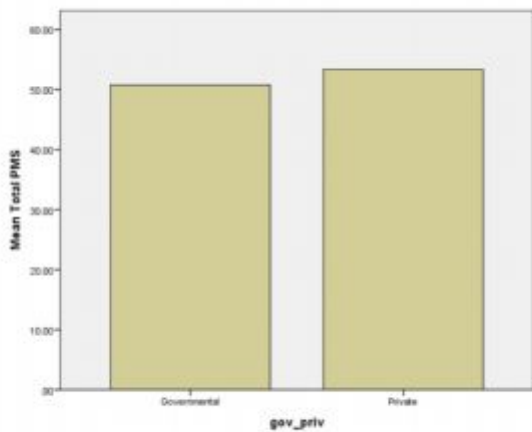
Male to female ratue

fig.2 Mean Bullying & Victimization scale



Percentage of bullying Vs. Victimization

Fig.3 Gov Vs. Private School



Bullying among Private schools compared to Gov. schools

LACK Of Vitamin B12 LEVELS In CHILDHOOD ANEMIA OXIDATIVE STRESS DETERMINATIONTünay Kontaş Aşkar¹, Zeynep Hünkerler², Bilge Sönmez³¹Department of Biochemistry, Faculty of Science Çankırı Karatekin University, Çankırı, Turkey.²Government Hospital of Çankırı, Çankırı, Turkey.³Çerkeş State Hospital, Çankırı, Turkey

One of the most frequent nutritional deficiency in children is vitamin B12 deficiency which plays a crucial role in oxidative metabolism and cellular immune response. Megablastic anemia can develop in growing children due to the insufficient intake of animal protein resulting in vitamin B12 deficiency. The aim of this study was to determine malondialdehyde (MDA), nitric oxide (NO), miyeloperoxidase (MPO), paraoxonase (PON), glutathione (GSH), and vitamin E levels in childhood vitamin B12 deficiency anemia.

The study has performed on 18 children with vitamin B12 deficiency anemia and 18 healthy children between the ages 4-9 (6,1±1,4). Vitamin B12 deficiency in children has been determined with Hb level <11,5 gr/dL, and vitamin B12 levels of <200 pg / dL. The study has been performed with the permission of Bülent Ecevit University Ethical Commission.

In the study, MDA, MPO, and NO levels were significantly higher in the vitamin B12 deficiency group and PON, GSH and vitamin E were significantly lower when compared to the control group.

In this study, the fact that oxidative stress occurs in children with vitamin B12 deficiency anemia has been identified high MDA, NO, MPO and low GSH and vitamin E levels.

Keywords: Children, vitamin B12 deficiency anemia, oxidative stress

Table 1. Iron and vitamin B12 status parameters in anemia and control groups

Parameters	Control Group	Vitamin B12 deficiency anemia
Fe (µg/dL)	55,1±20,5	60,8±23,9
Hb (gr/dL)	13,8±3,4	10,1±2,7¶
Ferritin (ng/mL)	34,7±12,3	35,9±15,4
Vitamin B12 (pg/dL)	281±101	148,1±87*

*, ¶ signs indicate statistical differences among the groups (p<0.05).

Table 2: Oxidative stress status in anemia and control groups

Parameters	Control Group	Vitamin B12 deficiency anemia
MDA (µmol/L)	18,5±6,2	23,1±8,2*
NO (µmol/L)	16,6±4,7	28,1±5,8*
GSH(mg/dL)	2,25±0,4	1,43±0,1
PON (U/L)	44,8±15	23,1±12*
MPO (U/L)	10,8±3,6	22,1±7,4*
E vitamin (mg/dL)	1,18±0,3	0,85±0,2*

*, ¶ signs indicate statistical differences among the groups (p<0.05).

P-0410

"{Vocal cord dysfunction: A case report}"

Vishal Mallusingsh Baghele¹, Dhiren Gupta²

¹Department of family medicine, Sir Ganga Ram Hospital, New Delhi

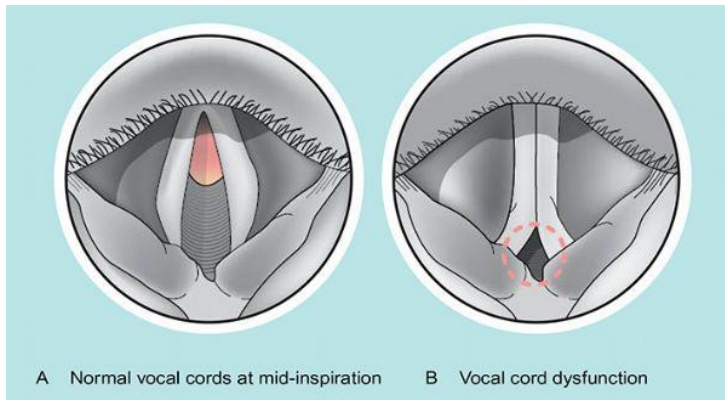
²Department of paediatrics, Sir Ganga Ram Hospital, New Delhi

Vocal cord dysfunction (VCD) is a condition characterized by paradoxical closure of vocal cord. This condition results in symptoms like wheezing, stridor, shortness of breath, anxiety, hyperventilation, suprasternal and neck muscle retraction. VCD is a condition that closely resembles asthma, making the two entities difficult to differentiate symptomatically. Family physician may misdiagnose vocal cord dysfunction as exercise induced asthma or asthma which is refractory to treatment. Misdiagnosis of this condition leads to inappropriate treatment and often patients have been treated unsuccessfully with high dose corticosteroids and bronchodilators that have led to iatrogenic side effects.

The present case report describes a 7-year-old male child presented to OPD with signs and symptoms resembling bronchial asthma since 8 months. Child was unresponsive to the treatment of bronchial asthma. This forced us to think about different diagnosis. With the help of paediatric pulmonologist, bronchoscopy was done which revealed abnormal adduction of vocal cord during respiration. This confirmed us to the diagnosis of VCD. We managed child with speech therapy, psychotherapy, panting exercise and ipratropium bromide inhaler. Child improved symptomatically on this line. Child is now asymptomatic on successive follow up in OPD. So this concludes that family physician should think in a different direction when bronchial asthma patient does not respond to the treatment.

Keywords: Vocal cord dysfunction, asthma, airflow limitation, family physician.

VOCAL CORD DYSFUNCTION



TREATMENT OPTIONS FOR VOCAL CORD DYSFUNCTION

Speech therapy

Psychotherapy

Panting Exercise

This maneuver causes the adducted vocal cords to relax, which increases the glottic aperture.

Anticholinergic agent inhalation

Topical lidocaine

Helium-oxygen therapy

TREATMENT FOR VCD IS VERY SIMPLE.

P-0411

Factors Related To Prognosis in Children On Antiepileptics

Didem Kafadar

Bağcılar Training and Research Hospital, İstanbul, Turkey

AIM: Epilepsy is an important chronic disease in pediatric population. We aimed to assess the factors related to the prognosis of children diagnosed with epilepsy and receiving antiepileptic medication.

MATERIAL-METHOD: Records of patients referred to pediatric outpatient clinic diagnosed as epilepsy and followed for 6 to 24 months were analyzed. Sociodemographic factors, epilepsy history laboratory and radiologic data were evaluated. Patients who were regularly followed-up for 2 years were described as the coherent group. Descriptive statistics and Chi -Square, Kruskal Wallis and Mann Whitney-U tests were used.

RESULTS: There were 87 patients consisting of 36 girls(41.4%) and 51 boys(58.6%), mean age was 67.7±38.6 months. Distribution of epileptic syndromes was not different between sexes. 74 patients did not have a family history, EEG was pathologic in 68 patients. After 6 months regular follow-up, 44 patients had normal EEG. 59.7% had generalized seizures. First seizure was mostly between 0-2 years of age (44.7%). 43.8% of patients referred to the outpatients clinic in the first 24 hours after the first seizure. In the coherent group(n=45,52%), 38 patients did not have any seizures. The mean time patients were on medication was 19.8±8.0 months. There was a significant difference between the frequency of seizures in 24 months between coherent and noncoherent group. As the age of the occurrence of first seizure increased, period between seizure and admittance to outpatient clinic decreased.

CONCLUSION: Family history, type of both epileptic syndrome and antiepileptic did not affect the prognosis. Regular follow-up decreased relapses and increased remissions. Because of late referrals due to inadequate awareness of families, the patient cannot be evaluated when the seizures begin. Family medicine(FM) is very important in follow-up of chronic diseases. Routine pediatric follow-ups including laboratory assessments and asking about different symptoms are important in FM practice. Chronic conditions of pediatric patients should alert the FM doctors for regular referrals to secondary outpatient clinics for better prognoses.

Keywords: seizures, epilepsy, pediatric, antiepileptic, prognose

P-0412

Chickenpox in Small Infant

Ricardo Oliveira¹, Pedro Ribeiro Oliveira², Rita Almeida¹, Rute Carvalho³

¹USF Escariz, ACeS Feira/ Arouca, Escariz, Portugal

²USF Fiães, ACeS Feira/ARouca, Fiães, Portugal

³USF Ermesinde, ACeS Maia/Valongo, Ermesinde, Portugal

INTRODUCTION: Chickenpox is a common childhood rash disease. Although usually benign, when it occurs at 2 months old and due to immunological immaturity, may raise fears and doubts regarding the evolution and the approach.

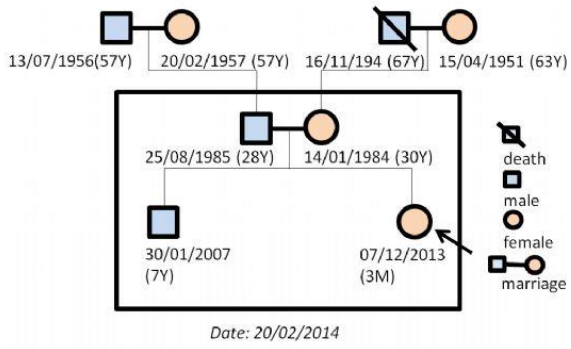
Case Description: We report the clinical case of a 2 months old small infant, without pathological antecedents appealing to primary care for discrete vesicular rash without systemic signs in the context of varicella occurred in her brother 2 weeks before. Sent to the Referral Hospital which confirmed diagnosis, having been admitted under intravenous acyclovir therapy, with favorable clinical outcome.

DISCUSSION: Chickenpox in young infants is infrequent at Primary Health Care. However, with a vesicular rash and no history of contact with an affected individual, doctors have to consider this diagnosis regardless age and presentation form. There's still some controversy in what concerns to treatment and conservative measures may be considered when at the presence of mild illness.

Keywords: Chickenpox, Acyclovir, Newborn, Lactation

Family Genogram

H. Family Genogram



Family Genogram

Photo 1



Photo 2



Photo 3



Photo 4



P-0413

CASE REPORT: CRICOPHARYNGEAL BAR

Çiğdem Hardal, Zuhal Aydan Sağlam

Istanbul Medeniyet University, Department of Family Medicine, Istanbul

CASE: CRICOPHARYNGEAL BAR

7.5 month old baby boy was admitted to our clinic with nasal regurgitation of food, wheezing and failure to thrive. He was born 3410 gr (50th perc) with c-section at the 39th week of gestation. Due to transient tachypnea of the newborn, he was followed up for 3 days in neonatal intensive-care unit. At the first month visit, he was at 25th percentile of weight (3850g) so formula milk was added to breastfeeding. The baby had acute otitis media and pneumonia at 1.5 months of age. Nasal regurgitation accompanied to clinical findings of infection. Although the infection was treated, his complaints hadn't resolved. The complaints might have been due to gastro esophageal reflux, so anti-reflux treatment was started. Sweat test, allergy testing, immunological tests all gave negative results. Despite a slight recovery with anti-reflux therapy, weight gain problem continued. At the sixth month, weight percentile was below 1 percentile (5430grams), so nasogastric feeding was started. He gained weight in two weeks. But he was still 6000gr at 7.5 months when re-consulted to pediatrics department. The presence of nasal regurgitation and wheezing required further investigations so videoflouroscopic swallowing study was planned. This investigation revealed cricopharyngeal bar (picture). The patient was then referred to pediatric surgery. After endoscopic balloon dilatation wheezing and nasal regurgitation completely resolved. The patient gained weight with oral feeding and benefited from the treatment. At 10th month, the patient was 9050grams (25.p) and being monitored for weight gain.

DISCUSSION AND CONCLUSION

31 cases over 65 years old were reported in literature. As far as we are concerned, ours is the first case reported with cricopharyngeal bar at this age, so we find it important to be reported. Although it is very rare, it will be smart to keep cricopharyngeal bar in mind at children with nasal regurgitation, growth retardation and wheezing.

Keywords: cricopharyngeal bar, nasal regurgitation

cricopharyngeal bar



P-0414**systemic juvenil idiopathic arthritis as a cause of fever of unknown origin**

Çiğdem Hardal¹, Muferet Erguven², Zuhal Aydan Sağlam¹, Gizem Huyuk², Hasan Hüseyin Mutlu¹

¹family medicine

²pediatrics and child health

INTRODUCTION: Systemic Juvenile Idiopathic Arthritis (JIA) fever, is a rare inflammatory disease of an unknown origin which may have symptoms unrelated with joints. Diagnosis is made by eliminating infection, malignancy and rheumatological diseases. Here we present a case who had been admitted with eruption on body and on swollen, painful ankles and diagnosed as systemic JIA.

CASE PRESENTATION: Five years old female patient was admitted with rashes and itchiness on her body and additional swelling and pain at her ankles. Eruption and itching on her knees and elbows occurred three weeks prior to admission and she had been prescribed antiallergics before. During three weeks, she had fever on and off reaching to 40°C. She was hospitalized to investigate the etiology of fever of unknown origin (FUO). At admission; body temperature was 36.5°C, heart rate:80/min, respiratory rate:17/ min., BP:90/60mmHg. She had swelling in ankles, and maculopapular rashes all around body especially at extremities (Picture 1).

FUOs may be caused by infectious diseases, malignancies, collagen vascular diseases, or a variety of miscellaneous disorders. The diagnostic approach depends on a careful analysis of the history, physical findings, and laboratory tests and biochemical evaluation. Here, mycoplasma, chlamydia, toxoplasma, rubella serology and testing for anti dsDNA, ASMA, AMA, anti SSA, ANCA, anti SM, anti SSB were negative. Rheumatoid factor was 9.94 IU/ml (<19). Histopathology of bone marrow eliminated malignancy. The patient was diagnosed with systemic JIA based on anamnesis, physical examination and exclusion of infectious and neoplastic disorders by laboratory results. Pulse steroid therapy of 30mg/kg/day for three days and subsequently additional methotrexate therapy for 10mg/m²/wk along with 2mg/kg/day steroid was started. On the sixth day of therapy the symptoms were under control. She was discharged on the third week and is still on 8mg prednisolone and 10mg/m²/week methotrexate.

CONCLUSION: Systemic JIA has to be kept in mind especially in patients with multi system involvement.

Keywords: systemic JIA, fever of unknown origin (FUO)

Picture: Maculopapular rashes at the extremities



Table: Biochemical examination of the patient.

Leukocyte	10.8x10.3/uL	Sedimentation	103 mm/hour
Hgb	9,8 gr/dl	CRP	7.82 mg/dl(<0,5),
Thrombocyte	521x10.3 /uL	ferritin	382ng/ml
AST	21U/L	Fibrinogen	644,92 mg/dl (200-400
ALT	8U/L	D-Dimer	1,88 mg/ml (0-0,5)

P-0415

When to use statins in adolescents

Mara Matos Dias

Unidade de Saúde Familiar de Fiães, ACES Feira - Arouca, Aveiro, Portugal

Background & AIM:

When cardiovascular (CV) risk factors are present from an early stage to adulthood, a risk of future cardiovascular disease is associated. Therefore, the identification of this population creates the opportunity to prevent the development of risk factors and CV events. In this sense, it's created the recommendation for screening, treatment and monitoring dyslipidemia in adolescence at risk for developing cardiovascular disease.

METHOD:

Literature search of systematic reviews and scientific articles from the Pubmed database, and Medline. Restricted to articles published between the period 2009 to 2015, in English.

Results

After the adolescent screening for cardiovascular risk factors and dyslipidemia, the orientation of the primary care physician develops towards taking preventive practice. Beginning with six months of healthy lifestyle measures which, if don't result in a lipid profile improvement, the statin should start to be use.

In general, statin therapy isn't recommended before the age of 10 years, unless there is a significant family history of CV conditions or premature events. Treatment should start with the lowest available dose. All statins, except pitavastatin, have been approved by Food and Drug Administration (FDA), for use in children.

The goal of treatment is to achieve low density lipoprotein - cholesterol (LDL-C) <130 mg / dL. If the desired value isn't reached, then, the dose of statin should be increased and liver function tests, such as aspartate aminotransferase and alanine aminotransferase, should be repeated in 4 weeks.

The safe use of statin at a long term in children is still controversial. However, a periodic follow-up liver enzymes and creatine kinase should be performed.

Conclusions

New recommendations should be created in order to support the safety profile of statins in adolescents. However, it's important to include the preferences of the adolescent and family in treatment decisions, encouraging to share questions and concerns.

Keywords: Pediatric Dyslipidemia; Screening and treatment of dyslipidemia; clinical management of dyslipidemia

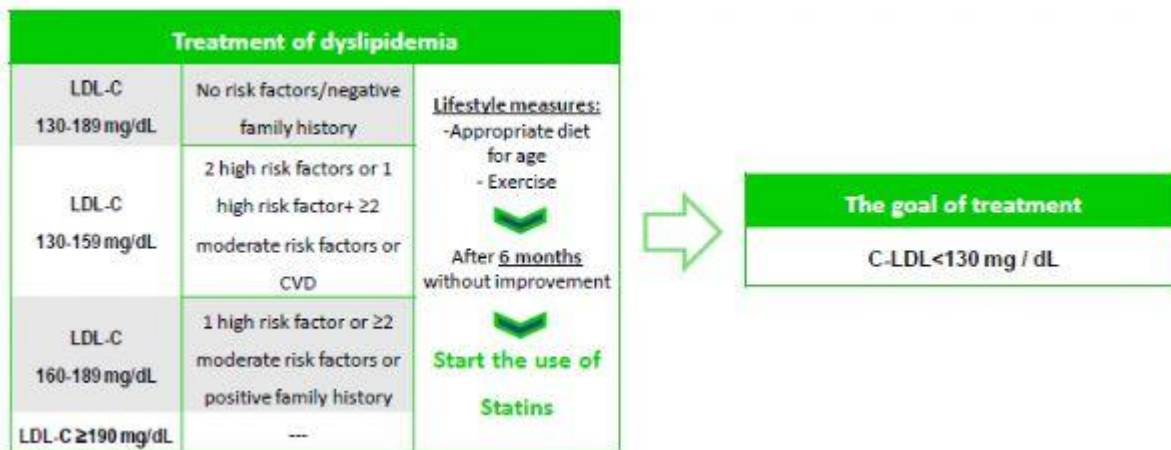
Screening for dyslipidemia in adolescence



Cardiovascular risk factors

Cardiovascular risk factors		
Criteria	Moderate risk	High risk
BMI	≥95-96th percentile	≥97th percentile
Hypertension	HBP without treatment	HBP with treatment
Cigarette smoking	-	-
HLD-C	<40 mg/dL	-
Predisposing medical conditions	Kawasaki disease with regressed coronary aneurysms	Kawasaki disease with current coronary aneurysms
	Chronic inflammatory diseases	Types 1 and 2 diabetes mellitus
	HIV infection	Postorthotopic heart transplant
	Nephrotic syndrome	Chronic renal discharge/end-stage renal disease

Treatment of dyslipidemia in adolescence



Monitoring statins

Statins		
Drug	Initial daily dose	Max daily dose
Atorvastatin	5-10mg	20mg
Fluvastatin	20mg	80mg
Lovastatin	10mg	40mg
Pravastatin	10mg	8-13 y - 20mg 14-18y - 40mg
Rosuvastatin	5mg	20mg
Simvastatin	<10y:5mg	40mg
Pitavastatin	Not approved	Not approved

Monitoring				
Laboratory monitoring	1st year			2nd year
	1 month	2 months	Every 3-4 months	Every 6 months
Lipid profile	X	X	X	
AST	X	X	X	
ALT	X	X	X	
CK	X	X		
Physical examination				
Height	X	X	X	X
Weight	X	X	X	X
BMI	X	X	X	X

P-0416

Establishing The Knowledge, Attitudes And Behaviors Of High School Students Regarding Energy Drinks

Hamit Sırrı Keten¹, Oğuz Işık², Hakan Öney³, Fatış Yıldırım², Numan Güvenç², Özgür Ersoy⁴, Mustafa Çelik²

¹Department of Family Medicine, Kurtul Family Health Center, Kahramanmaraş, Turkey

²Department of Family Medicine, Medical Faculty, Kahramanmaraş Sutcu Imam University, Kahramanmaraş, Turkey

³Faculty of Arts and Humanities, Arts, Sciences & Technology University in Lebanon, Beirut, Lebanon

⁴Department of Public Health, Medical Faculty, Cukurova University, Adana, Turkey

BACKGROUND: The present study aims to determine the knowledge, attitudes and behaviors of high school students regarding energy drinks.

METHOD: The present study included students from eighteen high schools located in the city center of Kahramanmaraş in the Mediterranean Region of Turkey between 01.04.2015 and 30.04.2015. Students were informed prior to the study and 2168 students giving written consent were included in the study. The participants were administered a questionnaire that was prepared by the investigators.

RESULTS: 1,291 (62.0%) students were female, 877 (38.0%) students were male; and the mean age was 15.81 ± 1.01 (min=13, max=20) years. 1,072 (49.4%) students stated that they drank energy drink before and 1,096 (50.6%) students stated that they did not. 582 (66.4%) male students and 295 (38.0%) female students stated that they drank energy drink before. The energy drink experience was significantly higher in male students than female students (p=0000). 442 (20.4%) students stated that they used energy drink before doing exercise. 492 (22.7%) students stated that they had their first energy drink for trying purposes (curiosity). It was found that the students obtained information on energy drinks mostly from the reminders written on the energy drinks (n=425, 19.6%). 315 (14.5%) students stated that energy drinks increased mental performance and 974 (44.9%) students stated that energy drinks increased exercise performance. 937 (43.2%) students stated that energy drinks were harmful to human health.

CONCLUSION: The present study revealed serious mistakes in the knowledge, attitudes and behaviors of students regarding energy drinks. Almost half of the students were found to have an energy drink experience. Specifically, male students were found to consume more energy drinks compared to female students.

Keywords: Energy Drinks, High School Students, Knowledge

P-0417

An Anomaly Encountered In The Follow Up The Healty Child: Preaxial Polydactyly

Aynur Yalçıntaş¹, Püren Cura Ecevit², Özlem Öztaş³, Burcu Kayhan Tetik⁴

¹Konya Karatay No:9 Family Health Center, Konya, Turkey

²Konya Meram No:25 Family Health Center, Konya, Turkey

³Ankara EÜAŞ Health Department, Ministry of Energy, Ankara, Turkey

⁴Inonu University Medical Faculty, Department of Family Medicine, Malatya, Turkey

INTRODUCTION:

Polydactyly is defined as having more than five fingers or toes, and is the most common congenital anomaly of the upper extremity after syndactyly. It can be seen either an isolated malformation or as a part of the syndrome. Divided into three groups as radial (preaxial), central, and ulnar (postaxial). Preaxial (radial) polydactyly is the most common subtype, it was reported to be seen in one in 3000 live births. Two surgical approaches have been accepted as basis for treatment of Radial polydactyly. The ideal time for surgery is between 6 months and 2 years old.

CASE:

In systemic examination of a six month old girl during routine follow up, a preaxial (radial) anomaly was detected in the right thumb. Other systemic examinations were normal. Detailed anamnesis revealed that the baby was born after in vitro fertilization (IVF) therapy. We learned that the mother didn't use any medication or exposed to radiation during pregnancy. The parents were informed that this may be a condition that can occur only in the

fingers or may be associated with other organ disorders, and can be resolved by surgical procedures. The baby was referred to the department of plastic surgery and reconstruction.

CONCLUSION:

The goal of surgery in congenital anomalies is to preserve and increase the hand functions or at least to provide an acceptable appearance of the extremities. The follow-up of infants and children on a regular basis in family medicine centers is crucial for the protection of children's health, and regarding their development. The purpose of the follow-up of healthy children is to prevent certain childhood diseases and injuries, reduce preventable deaths, promote development, and ensure them healthy lives as adults. We think the timely follow-up and paying attention to the quality will contribute to the development of children's health.

Keywords: Preaxial Polydactyly, Holistic, Family Practice

Preaxial Polydactyly



P-0418

Excessive weight in a Greek pediatric population living in Northern Greece in relation to sociodemographic and dietary risk factors

Dimitris Cassimos¹, Eleni Leontidou², Apostolos Manolis², Haralampos Sidiropoulos³, Eleni Kordi⁴, Kyriakoula Tsolaki⁵, Nectaria Chinopoulou², Grigorios Trypsianis⁴, Spiros Batzios⁶, Athanasios Christoforidis⁶

¹Department of Paediatric, Medical School, Democritus University of Thrace, Alexandroupolis, Greece

²Health Center of Iasmos, Komotini, Greece

³Health Centre of Eleftheroupolis, Kavala, Greece

⁴Laboratory of Medical Statistics, Medical School, Democritus University of Thrace, Alexandroupolis, Greece

⁵Health Center of Sapes, Komotini, Greece

⁶First Paediatric Department, Medical School, Aristotle University, Thessaloniki, Greece

Childhood obesity, which in Greece holds one of the highest rates worldwide, is predictive for adult morbidity and mortality. The aim of this study was to investigate the strength of potential risk factors (demography, socioeconomic, and nutrition) for childhood overweight or obesity in a pediatric population from Kavala, Northern Greece.

335 children participated (181 boys and 154 girls), with a mean age of 11.02 ± 0.60 years. A structured questionnaire concerning the socioeconomic status of the family, anthropometric values and educational status of parents, diet history, dietary habits, the availability and dietary intake of various food products and beverages at home, physical activity, time sleeping, and time watching television was completed by one of the parents of each child at home.

The prevalence of overweight and obesity was 33.7% and 15.8%, respectively. The frequency of both fathers and mothers with obesity was higher among obese (13.5%) and overweight (6.3%) children compared with normal-weight children (2.4%). Obese children used to have 3 meals or fewer per day significantly more frequent (32.6%) compared to normal-weight (19.5%) or overweight children (23.9%), whereas their meal duration was significantly reduced compared with both normal and overweight children (16.63 minutes vs 20.08 minutes and 19.64 minutes, $P=0.007$ and $P=0.021$). Finally, 22.6% of obese children spent more than 3 hours per day in front of a screen compared with only 8.9% and 8.9% of normal-weight and overweight children.

Our study confirms the increased rates of overweight and obesity among Greek children and identifies paternal obesity, decreased number of meals per day and increased time in front of a screen as risk factors, whereas maternal tertiary education was found to be a protective factor. Preventive interventions should focus on these risk factors for childhood obesity and developing strategies to reduce them.

Keywords: Childhood obesity, risk factors

Independent risk factors for the prediction of overweight or obesity among children (Results of multivariate logistic regression analysis)

Parameters	Multivariate		
	OR	95% CI	P
Obese father	2.120	1.258-3.571	.005
≤ 3 meals per day	1.742	1.034-2.936	.037
Never juice in house	2.261	1.168-4.375	.015

P-0419

A Case Report: Sexual Abuse

Püren Cura Ecevit¹, Aynur Yalçıntaş², Burcu Kayhan Tetik³

¹Konya Meram No:25 Family Health Center, Konya, Turkey

²Konya Karatay No:9 Family Health Center, Konya, Turkey

³Inonu University Medical Faculty, Department of Family Medicine, Malatya, Turkey

BACKGROUND

Sexual abuse is using a child which has not completed his/her psycho-social development by an adult for his/her sexual satisfaction. Prevalence of sexual abuse is thought to be %5-8 for men and %12-17 for women. When children which were exposed to sexual abuse send back their homes. It was observed that %5-10 of them were killed and %35-50 of them were seriously damaged in the following process. Sleep disturbances, nightmares, phobias, physical complaints and anxiety disorders were seen in sexually abused children.

CASE

15-year-old girl was admitted to our clinic with sleep disturbances and self-harming behaviors. It was identified that she was raped by someone who she doesn't recognize from their village and in the following period she was taken to an emergency service because of nausea and it was understood that she was pregnant in the lights of several tests. Taking her to the children protection center and sending to an obstetric center for termination of pregnancy were decided by prosecution, then curettage was performed. In her physical examination findings were normal. In her psychological examination; avoiding from contact; self-harming and psychomotor agitation were observed. She was referred to adolescent psychiatry clinic. The girl was diagnosed with post-traumatic stress disorder and it was relieved 3 months after anti-depressant drug initiation. Decreased ongoing Depressive affect and avoidance behavior were completely passed after six months therapy.

CONCLUSION

Role of family physicians in abuse cases are defining the damage in children, keeping in touch with other specialist, managing the treatment and following-up patients in long-term. Story of child abuses in a family is usually in a relationship with abuse of mother that's why investigating the domestic violence is really important. To be careful and sensitive in this regard especially for family physicians will prevent possible abuse cases in the future.

Keywords: Family Medicine, Sexual Abuse, Child

P-0420

case report: rickets

Ege Özince, Mehmet Ziya Gencer, Seçil Arıca

department of family medicine, okmeydanı eğitim ve araştırma hastanesi, istanbul, turkey

16 months old girl;

Patient was brought to family doctor with complaint of curvature development in the legs after start walking.

Patient's medical history:

During mother's pregnancy; there was no illness and drug using history.

Normal spontaneous vaginal delivery, from healthy mother, weigh 2900 g. in birth

Full-term birth, born smoothly, no difficult birth story.

The mother had come to doctor control during pregnancy

Patient received breast milk for the first 6 months.

After 6th month; breast milk has been completely cutten and food supplement has been started.

The vaccines are being made regularly since the birth.

The patient, who was holding her head 2 months old, sitting unsupported 8 months old, has started walking 1 year old.

Vitamin-D and iron prophylaxis haven't been begun to the patient.

Patient's family history:

No relationship between parents,

3rd child of family,
no illness in the family,
the patient's other siblings are right, healthy.

Physical examination:

Weight:8800 g (25.-50. pers) Height:74 cm (50. Pers)

Head circumference:45 cm (25.-50. pers)

The paleness, closed fontanelle, caput quadratum head deformity and rarity of hair were present.

There were no feature of the patient's cardiovascular and abdominal examinations.

Metaphyseal swelling in the patient's wrist and ankles and O-bien deformity in the patient's legs were detected.

In the chest examination; in deep inspiration, respiratory Harrison Groove was observed.

Breath sounds in both lungs by listening were natural and equal.

Imaging:

In the X-ray taken of the patient's lower extremities; metaphyseal significantly cupping up and irregularities and also in the bone widespread lack of osteoid matrix were detected.

Treatment:

After evaluating the patient history, physical examination and laboratory findings, the patient was diagnosed with "Nutritional Rickets" and 2000 U/day vitamin-D and 50 mg/kg/day Ca (p.o) have been begun to patient, also called to regular control.

Keywords: rickets, vitamin D prophylaxis, treatment

P-0421

An audit of the measurement of weight and height in children with asthma between the ages of 5-12 years in a rural practice

Deborah Ryan, Heather Mccullagh, Sheila Casey, John Macmahon
Kingscourt Surgery, Kingscourt, Co Cavan

Objective

1. To identify all children with active asthma within the practice to ensure they are correctly coded
2. To check if children with asthma have had their height and weight recorded in the last 12 months.

Methods

A search was performed using Socrates software to identify children between 5-12 years old coded with asthma diagnosis.

All files examined, to see if

1. these patients had active asthma
2. they had been reviewed in last 12 months
3. height and weight had been recorded.

Searched for all children in target age prescribed ICS (beclometasone and fluticasone) or montelukast in last 12 months to identify uncoded asthma cases.

Practice meeting held to discuss coding and plans made to measure weight and height of asthmatic children.

A review was conducted 4 months after the initial intervention.

Results

55 patients identified within the age range who were coded with a diagnosis of asthma. 5 were excluded from the analysis as they were not active patients in the practice.

Our post audit results showed a 350% increase in the number of children with height recorded and 260% increase in those with weight recorded. When we looked only at patients symptomatic in the last 12 months, 14 (58%) had height and weight recorded.

We identified 18 children using ICS or Montelukast who were not coded as asthmatic. Of these 18 patients, one(5.5%) child had height and weight recorded pre audit which increased to 8(44.4%) post intervention.

Following review of these 18 charts 14 children were coded as asthmatic.

Discussion

Using only a brief simple intervention we increased practice awareness of best practice in asthma management for children and clearly identified all asthmatic children within the practice.

Keywords: Asthma, inhaled corticosteroids, children

Figure 1

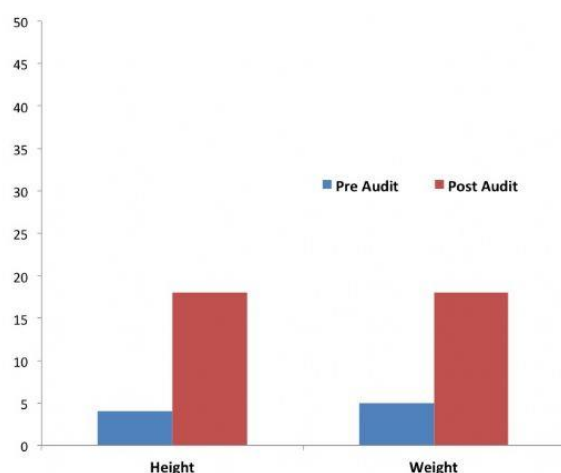


Fig 1 Chart showing the increase in number of patients with height (350%) and weight(250%)recorded post audit

P-0422

Hypertension in a private school versus a state school

Mehtap Gömleksiz, Hakan Demirci, Hayri Bozkurt, Esra Beşir Mahsun

Department of Family Medicine, Sevket Yılmaz Training and Research Hospital, Bursa, Turkey

AIM:

Hypertension in children is more prevalent than it is in the past. There are so many articles related to high blood pressure seen in school age children. In the present study we aimed to compare hypertension frequency between a private school and a state school.

METHODS:

There were 466 students in the state school and 166 students in the private school we visited.

Blood pressure measurements were performed in two separate visits and average results were calculated. The average blood pressure results were evaluated according to the fourth report criteria.

RESULTS:

The mean age of children was 7.5 ± 1.2 in private school and 7.7 ± 1.2 in state school (range was 6-11 years). Ten children (6%) out of 166 were determined to be hypertensive in the private school whereas there were 35 children (7.5%) out of 466 were diagnosed as hypertensive in state school. There was no statistically significant difference between these two schools in terms of hypertension ($p=0.52$). Hypertension was more prevalent in boys compared to girls ($p=0.005$).

CONCLUSIONS:

The frequency of hypertension is similar between state schools and private schools. Boys have a greater risk of having hypertension. To prevent hypertension in public we should focus on children because they will carry all the risks to their future life.

Keywords: hypertension (high blood pressure), paediatrics, primary care, public health

P-0423**Retrospective Analysis of Childhood Poisoning in Ümraniye**Caner Araz¹, Tuğba Okur², Şirin Güven², Mustafa Özgür Toklucu²¹Clinic of Family Medicine, Ümraniye EAH, Istanbul, Turkey²Clinic of Pediatrics, Ümraniye EAH, Istanbul, Turkey**Background & AIM:**

Poisoning cases who had applied to Ümraniye Research and Training Hospital Pediatric Emergency Unit, below the age of 17, between January 2010- December 2012 were evaluated retrospectively.

METHOD: For statistical analysis; NCSS (Number Cruncher Statistical System) 2007&PASS (Power Analysis and Sample Size) 2008 Statistical Software (Utah, USA) is used. The results that $p < 0.05$, are considered remarkable.

RESULTS:

Poisonings accounted for 0,3% of total pediatric emergency visits. Patients (n: 1129) aged between 1 months-16 years ($5,37 \pm 5,02$ years); 590 were female whereas 539 were male (1,09/1). Poisonings were more frequent under 5 years; 13 months- 4 years group consisted 39,4% and 0-12 months 21,7% of all cases. Accidental poisonings (82,5%) were more frequent than suicides (17,5%).

Accidentals poisonings were common in boys under 5 years though suicidal poisonings were common in 12-16 year old girls. Evaluation of the poisoning agents according to the age groups; drug ingestion became the most common poisoning reason except for 8-11 years group CO/NFIA exposures were more common. Poisonings occurred more frequently in March and in spring. Drugs (%62) were the most common poisoning agents. Analgesics- antipyretic (21,17 %) and central nervous system medication (13,64%) poisonings were leading other drugs. CO/NFIA (16,8%) and caustic-corrosive substances (9,4%) were the most common non-pharmacological agents.

Nausea- vomiting and tachycardia were the most frequent symptoms-signs; although the majority were asymptomatic.

CONCLUSIONS:

Our study reflects the demographic properties of poisonings in our region and will contribute to undertake preventive measures for childhood poisoning in Turkey.

Keywords: Poisoning, childhood, etiology, Ümraniye

Poisoning agents according to the age groups;

POISONING AGENTS	0-12 Months		13 months-4 years		5-7 years		8-11 years		12-16 years		total	
	n	%*	n	%*	n	%*	n	%*	n	%*	n	%*
Medicines	129	52,7	284	63,8	48	44,9	33	35,9	206	85,8	7000	62,0
Insecticides- Peptacid	7	2,9	10	2,2	3	2,8	2	2,2	0	0,0	22	1,9
Rodenticides	9	3,7	9	2,0	1	0,9	0	0,0	2	0,8	21	1,9
*CO/NFIA	27	11,0	46	10,3	40	37,4	47	51,1	30	12,5	190	16,8
Caustic- corrosive substances	42	17,1	47	10,6	9	8,4	7	7,6	1	0,4	106	9,4
Hydrocarbon	8	3,3	24	5,4	0	0,0	1	1,1	0	0,0	33	2,9
Alcohol	4	1,6	7	1,6	0	0,0	0	0,0	1	0,4	12	1,1
Other NFA	19	7,8	18	4,0	6	5,6	2	2,2	0	0,0	45	4,0
Total	245	100	445	100	107	100	92	100	240	100	1129	100

*CO: Carbon monoxide; NFIA: Non-Pharmacological Inhaler Agents; NFA: Non-Pharmacological Agents *Percent of the total events that in the same column

Symptoms and signs in poisoning events

Symptoms and signs	n	%
Nausea-vomiting	140	12,40
Tachycardia	95	8,41
Hyperemia on oral mucosa	37	3,28
Dizziness	35	3,10
Headache	33	2,92
Fever	17	1,51
Hypertension	16	1,42
Syncope	9	0,80
Asymptomatic events	741	0,27

P-0424

Evaluation of Home Care Services Provided for Children Patients

Dursun Çadircı¹, Enver Kepenek¹, Mehmet Örenler², Elif Burcu Yavuz¹, Ahmet Güzelçiçek²

¹University, Faculty of Medicine, Department of Family Medicine, Sanliurfa, Turkey

²Sanliurfa Children's Hospital Home Care Unit, Sanliurfa, Turkey

Background & AIM: Home care service refers to services of examination, workup, test, treatment, medical care, follow-up and rehabilitation including social and physiological services at home or in a family environment for individuals who need home care service delivery(1). Homecare services have gained importance in our country in recent years and this study attempts to evaluate children patients followed-up by home care unit and service provided.

METHOD: Sociodemographic characteristics and diseases of patients followed-up by HomeCareUnit at SanliurfaChildren'sHospital together with service they receive were evaluated retrospectively. Data was collected through records information of patients who got services between February-April,2015 at HomeCareUnit.

RESULTS: A total of 167 patients were registered at HomeCareUnit. Total of 152 patients whose data was obtained were included in study. 57% of the patients(n=87) were males and 42% of them(n=62) were females.

Mean age of the patients was 11±4.2. Disease distribution provided in Table1.

2% of patients(n=1.3) were feeding with percutaneous endoscopic gastrostomy, 3.9% of patients (n=6) were with NG, and 94.7%(n=144) were feeding orally.

32.2% of patients(n=49) were those who were given wheelchair, nebulizer, airbed, suction apparatus and ventilator by officials and aid organizations in accordance with their needs. Distribution of devices provided is available in Table2.

Most frequent complaint in doctor visits was coughing with percentage of 28.3(n=43). Second most frequent was fever with 17.8%, constipation was %10.5(n=16), vomiting %4.6(n=7), pressure sore %3.3(n=5). 50.7% of patients did not have any complaint during visits.

Primary care was given by mother in 92.8% of patients in our study. None of patients had a paid nurse.

CONCLUSIONS: Home Care Service is one of newly developing health services in our country and we are of the opinion that studies with wider scopes are needed.

References:

1-Directive on Methods and Principles of HomeCareServices provided by Ministry of Health. Date accessed29.01.2015.

Keywords: Home Care, Services, Children

Table 1

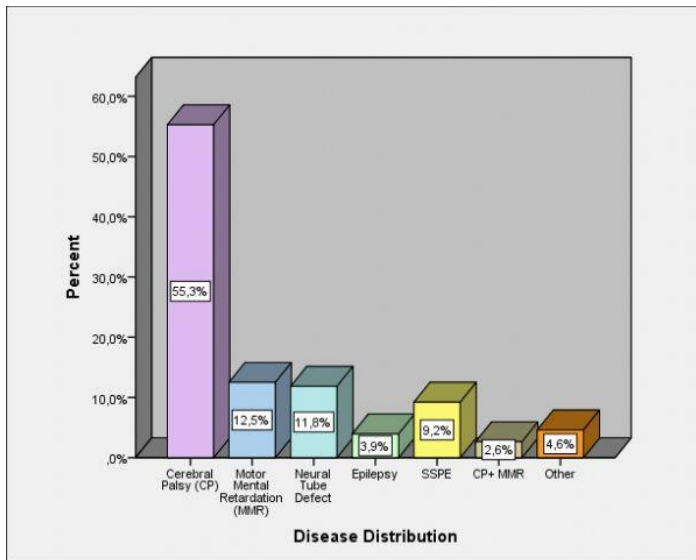
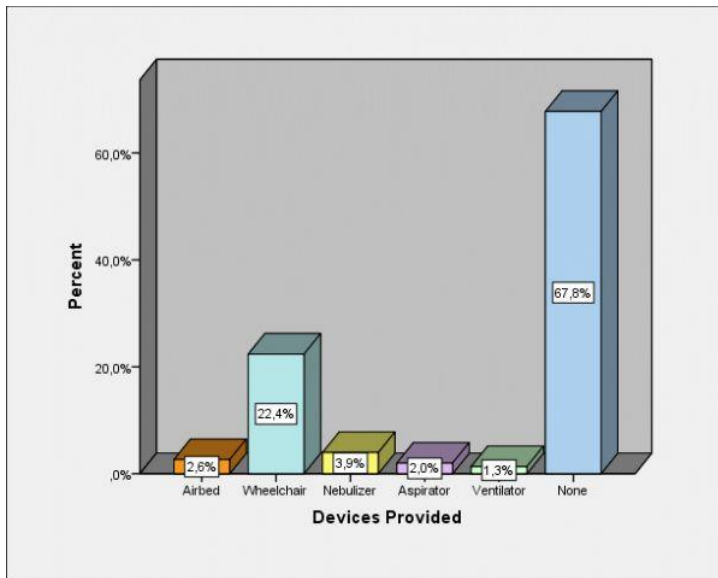


Table 2



P-0425

Staphylococcal scalded disease

Tuğçe Refika Turan, Fisun Sözen, Ali Ümit Geçkil

Department of Family Medicine, Baskent University, Ankara, Turkey

INTRODUCTION: Staphylococcal scalded disease is an issue characterized with bulla and exfoliation caused by exfoliative toxin also called with epidermolytic toxin, epidermolysin, exfoliatine. It is mostly seen under 5 years old children especially in autumn and winter seasons. It usually starts after upper respiratory tract infection, otitis media, conjunctivitis caused by staphylococcus. It is characterized with fever, irritation, skin sensitivity, erythema. Lesions become widespread across the face, axilla, inguinal area respectively. Nicolsky sign is positive. There is no mucosal involvement. Typical 'scalded' skin symptoms reveal about 24-48 hours after disease starts.

CASE: 3 days before the admission to the pediatric emergency room she had nasal flow, weakness, fever. Second day there was rash surrounding her mouth and she became irritable. Fever was decreasingly continuously. At third day rash became widespread throughout her body, and then peeled. When she applied to emergency room there was bullous, locally degloved erythematous lesions on her mouth, neck and abdomen. Nicolsky sign was positive. Body temperature was 37 C. Her past medical and family history, laboratory tests were found to be normal. She received vancomycin, clindamycin antibiotherapy for 7 days. In the hospitalization period, culture tests were all negative. After dermatology consultation, hamamelis virginiana distillate and zinc oxide pomade were offered. The case was discharged with complete recovery after 7 days.

CONCLUSION:. Staphylococcal scalded skin syndrome generally diagnosed with its characteristic clinical symptoms and our case also diagnosed with the same group of clinical symptoms. Its therapy is always inpatient treatment with the use of parenteral antibiotics. Since antibody against staphylococcal toxin are immature and renal system can't excrete exfoliative toxin the incidence in children is higher. should take anamnesis and do physical examinations carefully to refer in order to make the patients treated appropriately.

Keywords: staphylococcal scalded skin syndrome, primary care, family medicine

Child with Scalded Skin Syndrome



P-0426

Thyroglossal Ductus Cyst Presenting With A Neck Lump: A Case Report

Süheyla Atalay¹, Müferet Ergüven², Zuhale Aydan Sağlam¹

¹Department of Family Medicine, Istanbul Medeniyet University Goztepe Training and Research Hospital, Istanbul, Turkey

²Department of Pediatrics, Istanbul Medeniyet University Goztepe Training and Research Hospital, Istanbul, Turkey

INTRODUCTION: Thyroglossal cysts (TGCs) arising from a persistent epithelial tract, represent the most common congenital anomaly of the neck. Symptoms can arise from the swelling itself or from complications, the most significant of which is infection. The diagnosis can usually be made from the history and a careful servical and physical examination. **AIM:** To point out to the possibility of thyroglossal cyst which is one of the most common congenital anomalies of the neck among servical masses in children. **CASE:** An eight year old boy presented with a 2-3 cm hyperemic, mobile and tender lump on the location of hyoid bone for a week. His systemic physical examinations were normal. His laboratory results were as follows; haemoglobin:11,8 g/dL, Hct: %35, Plt: 444.000 mm³, WBC:15900 mm³, CRP:5,2 mg/dL, TSH 0.6437 uIU/mL, fT₃ 3.4 pg/mL, fT₄ 1.25 ng/dL. Ultrasonography imaging showed that the thyroid gland had normal size and ecogenity but there was a heterogen 17x24x10 mm sized solid lesion at the neighbourhood to the sternothyroid and sternohyoid muscles, located in the middle line of the neck, at the same location with the hiperemic lump, containing cystic material at the anterior part. Multiple ovoid lymph nodes were also observed in usg imaging at the superior posterior servical chain. The patient was diagnosed as infected thyroglossal ductus cyst and intravenous antibiotics were prescribed. At the fifth day of the treatment the palpable lump has shrunk and tenderness decreased. Blood test results returned to normal levels. The patient was consulted with the department of otorhinolaryngology and invited for regular appointments by that department. **RESULTS:** TGCs may be asymptomatic but malign degeneration can be observed at 1 % and infection may occur at 50% of cases. Possibility of this genetic abnormality should be in mind in cases presenting with tender and mobile lump in front of throat.

Keywords: Infected Thyroglossal Ductus Cyst

Image 1



Hyperemic and tender lump on the location of hyoid

P-0427

child development vocation high school students education levels and opinions about child negligence and abuse

Nagihan Yıldız Çeltek¹, Gülseren Oktay¹, Şükriye Sakar³, Ufuk Ünlü¹, Osman Demir²

¹Department of Family Medicine, Gaziosmanpaşa University Medical School, Tokat, Turkey

²Department of Biostatistics, Gaziosmanpaşa University Medical School, Tokat, Turkey

³Department of Child Care and Youth Services, Gaziosmanpaşa university social sciences vocational schools, Tokat, Turkey

AIM: In this study, to detect that education levels and opinions of child development vocation high school students who have significant role on 0-6 age group child care, and to raise awareness about this topic are aimed.

METHODS: For the sampling of the descriptive study, 197 students were chosen attending to Gazi Osman Paşa University Child Development Department. To obtain data, a questionnaire was administered to students. Chi-square test, standart deviation, average methods are used for analysing data.

FINDINGS: Regarding 190 chosen students, 188 were female, 2 were male, 18(9,5%) expressed that they had been subjected to violence, 26 that they had been exposed negligence. 20 student received official education about negligence and abuse. Regarding reason of abuse and negligence reporting obligation, 175 (93,1%) students think that they have to report because of laws, 164(88,6%) students think that they have to report because of National Education Ministry policy, 181(95,8%) students think that they have to report because of moral reasons. When they identified abuse and negligence, 88 (47,3%) students think to report to social services, 73(39,2%) students think to report to police department. The rate of student who think that able to identify physical abuse is 29,1%(55). 176 (94,1%) students express that they require more education about this topic.

RESULTS: In this study, we detected that child development vocation high school students have not enough education about child negligence and abuse. For to raise awareness and education level of child development staff, education program changes and to take more time for negligence and abuse topics in curriculum programs.

Keywords: child negligence and abuse, student, knowledge

CHILD NEGLIGENCE AND ABUSE



P-0428**Is there a connection between obesity and hypertension**

Esra Baykan, Hakan Demirci, Beyza Demirbaş, Ali Candar, Esra Beşir Mahsun

Department of Family Medicine, Sevket Yilmaz Training and Research Hospital, Bursa, Turkey

AIM: Increase in childhood hypertension is tried to be explained with an increase in obesity prevalence. In this study we aimed to identify if there was a correlation between obesity and hypertension in children.

METHODS: There were 637 children aged 6-10 years. We measured heights and weights of the children. Blood pressure measurements were performed twice and their means were calculated. Evaluation of hypertension was performed as it was described in the fourth report.

RESULTS: There were 45 children with hypertension and 74 obese children. In addition to this there were 73 children diagnosed as overweight. Obesity and hypertension were combined in 23 cases. This relation was statistically significant ($p=0.000$).

CONCLUSION: Obesity and hypertension are tightly comorbid diseases in children. They have common risks and prevention from one of them would probably prevent occurrence of the other.

Keywords: obesity, hypertension, comorbidity, children

P-0429**Childhood hypertension changes by altitude and gender**

Hakan Demirci, Hayri Bozkurt, Ali Candar, Esra Baykam, Esra Beşir Mahsun, Erkut Afyoncu, Fatih Çiftçi, Beyza Demirbaş, Mehtap Gömleksiz, Nevruz Yıldırım, Yakup Akpınar

Department of Family Medicine, Sevket Yilmaz Training and Research Hospital, Bursa, Turkey

AIM: It is well known that high altitude negatively affects blood pressure in general. In the present study we aimed to compare blood pressures in children who live different altitudes.

METHODS: Six hundred and fifteen children living at sea level (group1) and 228 students living at high altitude (850 meters) (group2) were participated in the study. Their blood pressure measurements made. Evaluations of blood pressures were done according to the fourth report criteria.

RESULTS: There were 37 students with hypertension in group1 (6.2%) whereas there were 16 students with hypertension in group2 (7%). There was an interesting gender distribution of hypertension in these two different altitudes. In group1 there were 27 males and 12 females diagnosed as hypertensive whereas in group2 there were 13 female students and only three boys diagnosed as hypertensive. The mean age of group1 was 7.91 ± 1.27 and it was 7.77 ± 1.22 in group2.

CONCLUSIONS: The frequency of hypertension in children is similar at sea level and at a relatively high altitude. There is a paradox in gender distribution of hypertension by altitude changes. Differences in physical activity and diet should be studied in these two locations.

Keywords: blood pressure, hypertension, high altitude, school age children

P-0430

Which one is more effective estrogen or testosterone on childhood hypertension?

Hakan Demirci, Yakup Akpınar, Ali Candar, Fatih Çiftçi, Yasin Güçlü, Salih Metin

Department of Family Medicine, Sevket Yılmaz Training and Research Hospital, Bursa, Turkey

AIM: Childhood hypertension is a new dilemma. Previous studies have shown that obesity and hypertension spreaded as an epidemic. They have a peak incidence at a time around puberty. In the present study we aimed to investigate relationship between high blood pressure and puberty.

METHOD: There were 343 students participated in the study. Their blood pressure measurements were performed by family medicine trainees. High blood pressure decision was made according to Fourth Report Criteria. Puberty decision was made as it was described in Tanner Staging.

RESULTS: Seventy two girls and 54 boys were diagnosed as in puberty. There were 37 students with hypertension. Hypertension in girls was not associated with puberty, while there was a statistically significant relationship between puberty and hypertension in boys ($p=0.01$).

DISCUSSION: Estrogen has been known to be protective against cardiovascular events. In the present study we have shown that puberty was not associated with hypertension in girls. However, we found that puberty affected blood pressure in boys. We ask 'Is it estrogen protection or testosterone that affects our life?'

Keywords: asymptomatic hypertension, puberty, female, male, children

P-0431

Carriage of Group A Beta-Haemolytic Streptococci Among Preschool Children

Ayşen Bayram¹, Ayşe Nur Sarı¹, Ahmet Muhammed Harmankaya², Yüksel Furkan Kömürçüoğlu², Nil Çelikkalkan², Burak Özğan², Ramazan Sevim², Yusuf Ökkeş Bağrıyanık², Ece Mahsereci², Eyüb Dündar², Halil Baysöz², Çağlar Mehmet Başaran², Seval Kul³

¹Department of Medical Microbiology, School of Medicine, Sanko University, Gaziantep, Turkey

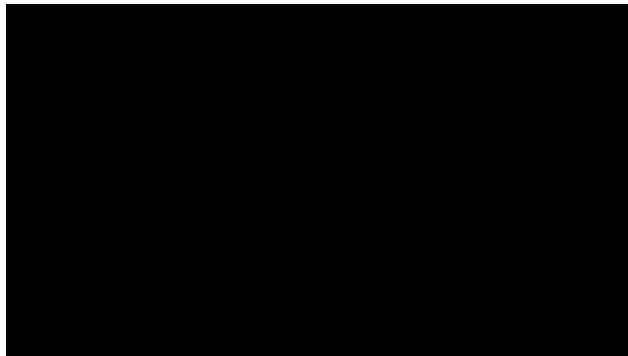
²School of Medicine, Sanko University, Gaziantep, Turkey

³Department of Biostatistics, School of Medicine, Gaziantep University, Gaziantep, Turkey

This study aims to investigate the rate of carriage and possible risk factors for Group A Beta-hemolytic streptococci (GABHS) in throats of preschool children. Children aged 0-6 years who admitted to three different Family Health Centers in the province of Gaziantep, Turkey were included in the study. Patient information sheet issued in order to compile demographic information and determine the risk factors for GABHS carriage were filled for all participants. The throat swab samples taken from volunteers were brought to the laboratory in transport media and were cultured on 5% sheep blood agar plates. Following an overnight incubation, advanced biochemical identification tests were performed to beta-hemolytic colonies on culture for the differential diagnosis of GABHS. The prevalence of GABHS carriage in the study and 95% confidence intervals were calculated using the rate for single-sample Z test. In our study, the prevalence of GABHS carriage in children aged between 0-6 years was identified as 5.8%. Growth of GABHS was observed in three out of 52 children from whom throat swabs were taken. Normal throat flora was detected in 49 (94.2%) volunteers participated in the study. In two of three patients with GABHS carriage, both mother's and father's educational level was primary education. Throat pain was present in two of these children in the last three months. Two GABHS carriers who suffered from bronchitis reported respiratory disease 1-4 times in a year. The rate of GABHS carriage we found in Gaziantep is not high according to results obtained from various studies conducted in our country, however GABHS carriage and infection in children should be monitored carefully because they cause significant morbidity among this age group.

Keywords: Group A Beta-hemolytic streptococci (GABHS), throat culture, preschool children

Table 1



P-0432

Sociodemographic characteristics and risk factors of children 5-15 years of age with asthma

Nurgül Önder¹, Sami Hatipoğlu², Betül Battaloğlu Inanç³, Derya Sıkar⁴

¹Gaziosmanpaşa ASM, İstanbul.

²Dr. Sadi Konuk Training and Research Hospital, DDepartment of Pediatrics, İstanbul,

³Muğla Sıtkı Koçman University, Faculty of Medicine, Family Medicine Department

⁴6. Nolu ASM, Düzce.

OBJECTIVE: The aim of the study is to determine socio-demographic characteristics and risk factors of children admitted to an outpatient asthma clinic of a research and training hospital.

METHODS: In this descriptive study, records of 450 children 5-15 years of age with diagnosis of asthma admitted to Asthma and Allergy Outpatient Clinic of Bakırköy Dr. Sadi Konuk Research and Training Hospital between January and December 2005 were evaluated retrospectively. Data regarding socio-demographic characteristics, age at onset of the disease and risk factors were analyzed with Student's t test, Mann Whitney U test and chi-square test. The study was approved by the ethics committee (03.04.2007/57) of Bakırköy Dr. Sadi Konuk Training and Research Hospital.

RESULTS: Among the participants 60.9% were male, mean age was 8.4±2.7 and mean age at onset of the symptoms was 3.6±2.7. 95.6% of the participants were coming from low-income families. 46.4% were using coal stove for heating and 67.1% were living in a humid house. Among the children, 66.7% were admitted to an emergency clinic during last year and 10.9% were hospitalized.

CONCLUSION: Socio-demographic characteristics and risk factors of children evaluated in our study were consistent with the literature.

Keywords: Asthma, smoking, breast feeding.

P-0433

Prevalence of iron, folic acid, vitamin b12 and vitamin d deficiency in patients with thalassemia

Vasfiye Güven¹, Mustafa Kürşat Şahin², Canan Albayrak³, Davut Albayrak³, Mustafa Fevzi Dikici¹

¹Department of Family Medicine, Medical Faculty, Ondokuz Mayıs University, Samsun, Turkey

²Canik Community Health Center, Samsun, Turkey

³Department Of Pediatric Hematology, Medical Faculty, Ondokuz Mayıs University, Samsun, Turkey

Background &AIM: Thalassemia related anemia is a common hematologic problem in Mediterranean region. This type of anemia may be frequently confused with iron deficiency anemia. Anemia becomes more severe in case of coexistence of both anemia types and literature knowledge is sparse on that issue. This study was carried out with the aim of investigation of iron, folic acid, vitamin B12, vitamin D levels in patients who were diagnosed with beta thalassemia.

METHOD: The study represents a retrospective, cross sectional, single-center cohort study. Data were collected from a previously authorized and validated Hospital Information Management System (NUCLEUS). Data were analyzed using SPSS 22.0 package program. In the analysis, frequency and percentage from descriptive criteria were used.

RESULTS: A total of 66 patients (36 male, 30 female) who were diagnosed with beta thalassemia were enrolled in the study. Iron deficiency was detected in 28 (42.4%) patients. Decreased vitamin D, vitamin B12 and folic acid values were detected as 18 (27.2%), 15 (22.7%) and 5 (7.5%) patients, respectively.

CONCLUSIONS: It was concluded that serum iron, folic acid, vitamin B12 and vitamin D levels should also be measured in assessment of beta thalassemia patients due to its high prevalence in study region.

Keywords: Beta thalassemia, iron deficiency anemia, vitamin B12, vitamin D, folic acid

P-0434

A Case of Varicella Complicated With Preorbital Cellulites

Hatice Dülek¹, Şule Nurşah Ayata¹, Narin Akici², Çiğdem Sağ², Zehra Esra Önal², Çağatay Nuhoglu²

¹FAMILY MEDICINE DEPARTMENT OF HAYDARPAŞA NUMUNE TRAINING AND RESEARCH HOSPITAL, ISTANBUL

²PEDIATRICS CLINIC OF HAYDARPAŞA NUMUNE TRAINING AND RESEARCH HOSPITAL, ISTANBUL

INTRODUCTION: VARICELLA/CHICKEN POX IS A MILD AND CONTAGIOUS CHILDHOOD ILLNESS CAUSED BY THE VARICELLA ZOSTER VIRUS AND CHARACTERISED BY ITCY RASH. VARICELLA PROVIDES A BASIS FOR SECONDARY BACTERIAL INFECTIONS. IMPETIGO AND CELLULITIS ARE THE MOST COMMON SUPERFICIAL SKIN INFECTIONS. CASE: A 6 YEAR OLD MALE PATIENT WITH PAPULOVESICULAR RASH ON BODY AND SWELLING ON THE LEFT EYE 3 DAYS LATER AND ONSET OF PAIN PRESENTED TO OUR HOSPITAL. DURING THE EXAMINATION THE PATIENT WAS CONSCIOUS AND EXTENSIVE PREORBITAL CELLULITIS ON THE LEFT EYE AND VARICELLA RASH ON THE WHOLE BODY WAS PRESENT. THE PATIENT HAD NOT HAD CHICKENPOX VACCINE AND HAD NO IMMUNE SYSTEM DISEASE OR CHRONIC DISEASE HISTORY. DURING LABORATORY TESTS THE FOLLOWING RESULTS WERE FOUND: ANTIVIZVIGM+, CRP; 2.9MG/DL, WBC:16.9K/UL.BIOCHEMICAL TESTS WERE NORMAL. OPTIC DISC WAS FOUND TO BE NORMAL, EYE MOVEMENTS WERE UNRESTRICTED AND LIGHT REFLEX WAS FOUND TO BE NORMAL AT THE EYE EXAMINATION AND THE PATIENT WAS DIAGNOSED WITH ORBITAL CELLULITIS. SURFACE TISSUE USG WAS ORDERED FOR THE SWELLING ON THE CHEEK. THE RESULT INDICATED ABSCESS.

DISCUSSION: VARICELLA WHICH IS ONE OF THE MOST COMMON INFECTIONS OF CHILDHOOD HEALS ON ITS OWN WITHIN 7-10 DAYS. CELLULITIS AND IMPETIGO ARE THE MOST COMMON SUPERFICIAL TISSUE INFECTIONS. THESE INFECTIONS CAUSE SCARS DESPITE PROPER TREATMENT (1-3)SINCE IN SOME COUNTRIES SUCH AS OURS HYGIENE AND HAND WASHING IS NOT WIDELY PRACTICED, REDUCING THE FREQUENCY OF SKIN AND SOFT TISSUE SECONDARY BACTERIAL INFECTIONS ASSOCIATED WITH VARICELLA IS BELIEVED TO BE DIFFICULT. EXTENSIVE ORBITAL CELLULITIS SECONDARY TO VARICELLA IN OUR PATIENT WAS TREATED WITH AN INTENSIVE ANTIBIOTICS TREATMENT WITHOUT LEAVING ANY SCAR.SINGLE DOSE VARICELLA VACCINE WAS ADDED TO THE NATIONAL VACCINATION SCHEDULE IN OUR COUNTRY IN 2013. VARICELLA CAN CAUSE SERIOUS COMPLICATIONS AS SEEN IN OUR PATIENT WHO HAD NOT BEEN VACCINATED AND WE WANTED TO STRESS THE IMPORTANCE OF VARICELLA VACCINE.

Keywords: COMPLICATION, PREORBITAL CELLULITIS, VARICELLA

PREORBITAL CELLULIT



P-0435

Henoch-Schönlein Purpura with Scrotal Involvement

Ahmet Ünal¹, Dilek Yılmaz², Ferah Sönmez²

¹Department of Family Medicine, Adnan Menderes University, Aydın, Turkey

²Department of Pediatric Nephrology, Adnan Menderes University, Aydın, Turkey

INTRODUCTION

Henoch-Schönlein purpura (HSP) is the most common in childhood, the monitoring of IgA deposition in the vessel wall is a small vessel vasculitis that is at the forefront of skin lesions. The most common clinical presentation at HSP; non-thrombocytopenic purpura, abdominal pain, arthralgia or arthritis and renal involvement. Very different clinical manifestations can be traced to the vessels held by HSP. Acute appendicitis, intussusception, the superior mesenteric artery syndrome, acute pancreatitis, esophagitis, duodenitis, acute scrotum, hemorrhagic urethritis, urethral stenosis, muscle involvement are one of the rare clinical presentation. An annual incidence of 14-18/100000 was reported. Although the etiology is not clear, but infections, autoimmune mechanisms, drugs, vaccines, antigen-antibody complexes are accused.

CASE REPORT

Eight-year-old male patient is admitted to our hospital were followed by on the lack of HSP a rash of complaints typical rash in the gluteal and lower extremities. Feature was not in the patient's personal and family history. In physical examination of the lower limbs and gluteal rash typically palpable purpura was present. The patient's scrotum, scrotal edema and was red appearance inspection. Examination was unremarkable in other systems. The patient was hospitalized under observation in the pediatric nephrology service. Complete blood count, blood chemistry, coagulation parameters and urinalysis examinations were normal. Sedimentation 92 mm/hr respectively. Pathologic features not found in C3, C4, PT, PTT, IgA and viral hepatitis markers. Negative occult blood in the stool and abdominal ultrasonographic examination was normal. Scrotal ultrasonography was reported as the fluid accumulation, that done for scrotal edema. 24-hour urine protein levels were within normal limits. All purpuric and scrotal edema disappeared on 5 days of follow-up. He was released from the hospital and was decided to followed as outpatients.

CONCLUSION

HSP should be considered in the differential diagnosis of rash illness should be monitored closely for complications that may occur and system inquiries should be made in detail. We can prevent the morbidity and mortality of patients with complete physical examination. Patients should be referred to the appropriate center if necessary without delay.

Keywords: Primary Care, Purpura, Rash, Henoch-Schönlein purpura

P-0436

4 months old patient with tuberculosis

Ezgi Kaçar, Reyhan Üstündağ, Mehmet Ziya Gencer, Seçil Arıcı
Istanbul Okmeydanı Training and Research HOSPITAL

INTRODUCTION: 4-months-old patient who was diagnosed tuberculosis after contact with tuberculosis patient. Complaints / story: Patient whose complaints began with fever 9 days before and antipyretic treatment, the antibiotics were given to considering upper respiratory tract infections, was consulted to the children emergency service. Patient who had a history of contact with tuberculosis patient was hospitalized in children's services with the preliminary diagnosis of tuberculosis upon non-decreased fever during observation.

Physical examination: Patient with no feature in his prenatal story, had 38 degree fever during consultation.

Breath sounds were bilateral, equal and natural. No feature was observed during all system examinations.

Clinical course: i.v. ceftriaxone was began to apply to the patient after hemoculture. Upon learning that patient had a contact with tuberculosis 2 months ago, patient were consulted with Pediatric Infection Diseases. Patient's 48th hour PPD value has been read 11mm, 72nd hour PPD value has been read 13 mm. On contrast-enhanced chest CT, density increases in mediastinum upper left perihilar area of approximately 17 * 13mm and in posterior mediastinum the largest of about 12 * 7mm size were assessed in favor of lymphadenopathy, density increase in

the anterior apex of the left lung at about 4 * 5 mm in size and density increases in both lung fields especially in the right upper lobe and the central part of right lung, were observed as assessed in favor of frosted glass appearance. Considering the patient's age, history, PPD value and CT, three anti-tuberculosis treatment was started (isoniazid 10 mg / kg / day single dose, rifampicin 15 mg / kg / day single dose, pyrazinamide 30 mg / kg / day single dose). During follow-up, the patient who had no additional complaints and no fever after 3rd day of admission, was transferred to the Infection Clinic.

Keywords: tüberculosis,fever, contact with tubercülosis, pediatrics

P-0437

"{" Level of Knowledge of Child Development Students on Children's Health "}"

Gülseren Oktay¹, Nagihan Yıldız Çeltek¹, Yunus Emre Kuyucu³, Canan Kuzdan², Ramazan Tetikçok¹

¹Department of Family Medicine, Gaziosmanpaşa University Faculty of Medicine, Tokat, Turkey

²Department of Pediatric Infectious Diseases, İstanbul Mehmet Akif Ersoy Thoracic and Cardiovascular Surgery Training and Research Hospital, İstanbul, Turkey

³Department of Biostatistics, Gaziosmanpaşa University Faculty of Medicine, Tokat, Turkey.

"" AIM: Preschool educators who interesting children in the jobs, have knowledge about health information is very important. Because of the requirements in the field of health, especially when it isn't possible to predict the urgent issues arise. The purpose of study was to determine the knowledge of child development students about children's health and emergency response requires

METHODS: the study carried out on the first and last students who in the Gaziosmanpaşa University Child Development Program that recorded demographic information, which previously received first aid training, any course that participate in health or education, whether having child and asked 20 questions about knowledge of child health

RESULTS: 33.7% of first, 51.6% of last class students find themselves enough about child health. The majority of students were found to give the correct answer subject to fire intervention methods, the risks of obesity, personal hygiene, head injury, foreign body lodged intervention. In addition, only half of the students; smudge with airway tuberculosis (1. class:42,1, % last class:50,5%) and " What should be done first loss as a result of the burns on the hot water? "The correct answer to the question which" must be kept for at least 5-10 minutes under flowing tap water " has been found (1.class:43,2%, last class:52,7%) to give correct answer

CONCLUSIONS: Although the average total score of last students (15.27 ± 2.30) is higher than the first students (13.00 ± 2.93) (p <0.001); haven't enough knowledge which is the seen often in the professional life examples, intervention of the patient who corrosive agent ingestion, post -burn and children with fracture risk. Level of knowledge is increasing if the content of the student's education curriculum created problems which is seen often in professional life. In addition, continuity of knowledge should be provided with in-service training after graduation"".

Keywords: Child development, child health, education

P-0438

A Case With Spinal Muscular Atrophy Presenting With Reduced Neck Movements

Mehmet Altuğ¹, Melahat Akdeniz²

¹Beyşehir 3rd Görgün Yavuz Family Health Center, Konya

²Akdeniz University, Department of Family Medicine, Antalya

Introduction

Spinal muscular atrophy (SMA) is a neurological disease characterized with degeneration in spinal cord anterior horn cells. SMA type I (Werdnig Hoffman Syndrome) manifests itself during the first 6 week of life. It is the most severe type of the disease. Affected cases have hypotonia, they cannot hold their head or sit, and may lie "frog-legged". Due to the severe weakness of intercostal muscles, the abdomen is displaced upwards resulting in paradoxical breathing. Patients cannot sustain life because of the severe respiratory difficulty unless there is mechanical respiratory support.

THE CASE:

One month old male patient was brought to our family health center with complaints of reduced movements of his neck and high-pitched crying. His overall condition was good, there was fasciculation in his tongue. His deep tendon reflexes were hypoactive. Tonic neck reflex was absent. Muscle was normal, but he had reduced muscle strength. Extremities were hypotonic. He was born from the first pregnancy of his mother. The mother had been regularly checked by her physician with USG examinations during her pregnancy; no abnormality was detected. There was no consanguinity between the mother and the father.

The patient was consulted with pediatric neurology clinic, and he was diagnosed with SMA type I. There is currently no effective treatment of SMA. Symptoms are tried to be minimized with physical therapy, orthopedic interventions and respiratory support. The role of family physician in these kinds of disease with no effective treatment is to educate the family, to provide support for care and to aid in obtaining appropriate rehabilitation services.

CONCLUSION: As well as the commonly occurring diseases, rare diseases, also called the "zebra"-type diseases are also encountered in primary healthcare. Recognition and appropriate management of these rare diseases by family physicians can prevent the family from unnecessary diagnostic and treatment interventions.

Keywords: Family medicine, reduced neck movement, spinal muscular atrophy

SMA type 1 infant



P-0439

Septic Arthritis An Important Causing in Pediatric Population: Brucellosis

Ahmet Ünal¹, Yasin Bulut²

¹Department of Family Medicine, Adnan Menderes University, Aydın, Turkey

²Department of Pediatrics, Adnan Menderes University, Aydın, Turkey

INTRODUCTION

Brucellosis is an multisystemic infectious disease that can be seen all over the world. They are easy to reproduce in wet and humid conditions, can survive so long raw milk and dairy products. Fever, loss of appetite, fatigue, muscle and the nonspecific symptoms such as joint pain, until the symptoms of the affected specific organ present with different ranging clinical manifestations. Brucella can affect many systems, especially musculoskeletal system, cardiovascular system and central nervous system, can cause serious complications. Bone-joint involvement is one of the common complications of brucellosis. Brucellosis is one of the major causes of septic arthritis. In this article, due to Brucella infection and was presented with a child developing knee arthritis in patients who have no symptoms of systemic infection outside the joint complaints.

CASE REPORT

17-year-old male patient was admitted to our clinic with weakness, pain in the left knee, swelling, redness and limitation of movement. On clinical examination; revealed left knee swelling, increased temperature, palpation tenderness and limitation of movement. Measured temperature of the patients was 37.4°C. Laboratory values examined, found that WBC:3980/mm³, hemoglobin 11.4 g/dL, Plt:169000/mm³, CRP:21 mg/dL, erythrocyte sedimentation rate 33mm/h, AST 32 U/L, ALT:30 U/L. Viral hepatitis markers were negative. Patient joint puncture was performed. Fluid was consistent with septic arthritis, was pus appearance. Empirical antibiotic therapy was initiated in patients diagnosed with septic arthritis. Rose Bengal slide agglutination test (+), antibody titers of 1/640 at Wright tube agglutination test (+) found. Patients were considered to be brucellosis septic arthritis. Treatment of patients with TMP/SMX+rifampicin has been changed and were given for six weeks. His complaints to be completely past, revealed that full range of motion on 6 weeks to next check.

CONCLUSION

The most common microorganisms in childhood septic arthritis is Staphylococcus aureus. Brucellosis is an important factor in septic arthritis in the endemic area. Brucellosis comes out with many different signs and symptoms. In particular, joint pain and/or swelling in joints should be considered in children with diagnosis and proper evaluation should be ordered.

Keywords: Childhood, Brucellosis, Septic Arthritis

P-0440

Early maternal separation may induce smoking

Yusuf Karayürek, Hakan Demirci, Yakup Akpınar, Fatih Çiftçi, Ali Candar, Yasin Güçlü

Family Medicine, Sevket Yılmaz Training Hospital, Bursa, Turkey

AIM: There is a novel idea that breastfeeding duration of a person is associated with addiction such as smoking. And, it is also known that separation of a child from his/her parents' may result in unwanted psychological outcomes. In the present study we aimed to find out if there was a relation between maternal separation in childhood period and smoking.

METHODS: The study group was composed of all of the students (n=296) in the school. We asked who smokes in the study group to the class advisor teachers and then confirmed the results by the children. Separated children were determined by face to face interviews.

RESULTS: There were 43 high school students with parental separation. Eight of the students were separated from their mothers. Among them two mothers were dead and six were divorced. Sixty one children were smokers in the study group and twelve of them had parental separation and five of them have been separated from their mothers (p=0.12).

CONCLUSIONS: Smoking rate was quite high in a secondary school (20.7%). And, children separated from their mothers have a greater risk of become a smoker.

Keywords: smoking, children, maternal, separation

P-0441

Infantile Hypertrophic Pyloric Stenosis Case Report

Reyhan Üstündağ, Mehmet Ziya Gencer, Ezgi Kacar, Kamil Demir, Gözde Nizamoglu, Seçil Arica
Department of family medicine, Okmeydanı Education and Researching Hospital, İstanbul, Turkey

INTRODUCTION:

Hypertrophic pyloric stenosis is one of the most common diseases that require emergency surgery in the neonatal period(1) While 2-4 weeks old, non-bilious vomiting is shown after nutrition in this disease and gradually increases; if it is not recognized on time it can cause serious problems. Palpation of hypertrophic pylorus during physical examination (olive sign) and seeing the pyloric muscle thickness 3-4mm, the length 14-16 mm in ultrasonography shows definite diagnosis(1-2). In this case an infantile hypertrophic pyloric stenosis patient was discussed.

Case presentation:

Two months old male patient; was admitted to the pediatric emergency with the complaints of non-bilious vomiting after every nutrition and weight loss. There was no property in the patient's prenatal history. He was 3500 gram of normal spontaneous birth. The patient had dryness of mucous membranes, highly decreased skin turgor. He was 4050 gr. In physical examination there was palpation of hypertrophic pylorus. In complete blood count wbc:18.62 103/UL, hgb:13.2 G/DL, plt:691 103/UL; in biochemistry glucose:74 mg/DL, urea: 24mg/DL, creatinine: 0.28 mg/DL, Na:136 mEq/L, potassium:3.96 mmol/L; in arterial blood gas ph:7.57, PCO2:31.2, BE:5.7 mmol/L, HCO3:27.8 mmol/L. In his abdominal ultrasound pyloric muscle thickness was 4 mm, length was 20 mm. We had diagnosed him as infantile hypertrophic pyloric stenosis. The patient's oral intake had been stopped and we started decompression with nasogastric catheter. We started fluid replacement to the patient according to the sodium-potassium deficit. The patient was transferred to the pediatric surgery department.

CONCLUSION:

Vomiting and weight loss are among the reasons that families resorting Ph.D. most especially in the neonatal period. We can distinguish this type of patients from gastroesophageal reflux, nutritional excess by anamnesis and examination of olive sign in primary health care and we must transfer them to a better equipped hospital urgently.

Keywords: PYLORIC STENOSIS, VOMITING, WEIGHT LOSS, FAMILY MEDICINE

P-0442

Peripartum cardiomyopathy can only be diagnosed by primary care physicians

Burkay Yakar¹, Yusuf Haydar Ertekin², Hülya Ertekin³, Aysegül Uludağ², Yasemin Korkut Türkmen⁴

¹Gulabibey Family Physician Center, Corum, Turkey

²Department of Family Medicine, Canakkale Onsekiz Mart University, Canakkale, Turkey

³Department of Psychiatry, Canakkale Onsekiz Mart University, Canakkale, Turkey

⁴Department of Family Medicine, Dumlupınar Üniversitesi, Kutahya, Turkey

Introduction

Peripartum cardiomyopathy (PKM) is a form of congestive heart failure that results from an enlarging of the heart and a weakening of the heart muscle in the last month of pregnancy and in the first five months of the postnatal period.^{1,2} Major risk factors include pregnancy at >30 years of age, multiparity, chronic hypertension and eclampsia.^{4,8} Patients suffering from PKM generally present with symptoms akin to heart failure, and the condition can be considered normal during the late period of pregnancy. A diagnosis of PKM can be made from anamnesis, a physical examination and echocardiography.

Case report

A 34-year old female patient, visiting the family medicine polyclinic for vaccinations of her 1-month-old infant, was noted to be suffering from shortness of breath, palpitations and coughing. There was no medical history of any disease or medication before or during the pregnancy. The patient's blood pressure was 120/70mmHg and her pulse was rhythmic at 122/min. There was no cardiac murmur, rales were present in both pulmonary bases and the results of an abdominal examination were normal. Pitting edemas were observed in both lower extremities, and a further anamnesis revealed that the patient's palpitations had begun two weeks prior to the

birth, and had increased in the first postpartum week. The patient was transferred to a cardiologist due to concerns of heart failure and a pulmonary embolism, and was then admitted to the intensive care unit for treatment with a diagnosis of acute decompensated heart failure.

Discussion

Given the higher incidence of disease in mothers >30 years, and the advanced average age of maternity in the present day, the odds of encountering PKM in the primary care is increasing. Family physicians can overcome this low-prevalence of the disease by investigating risk factors, following-up symptoms and consulting experts.

Keywords: Family Physicians, Postpartum Period, Pregnancy, Peripartum Period, Cardiomyopathies,

P-0443

Knowledge And Attitude of Newly Delivered Mothers About Smoking During Pregnancy and Breastfeeding

Emel Lüleci¹, Neşe Keskin¹, Seyhan Hıdıroğlu¹, Tuba Ekinci², Seyhan Birinci², Esin Yüksek², Burak Tahmazoğlu², Mustafa Şahin²

¹Department of Public Health, Medical School of Marmara University, İstanbul, Türkiye

²Medical School of Marmara University, İstanbul, Türkiye

Background & Aim: WHO deems smoking as the most important modifiable risk factor for non-communicable diseases. Although the number of smokers in developed countries decreases, smoking in Turkey has gone up. The increasing number of women smokers creates risks not only for them, but also for pregnancy and fetus. This study aims to describe smoking behavior of women who have given birth in Marmara University Hospital and to measure their knowledge about effects of smoking during gestation and breastfeeding.

Method: Between 31st March and 13th April 2014, 204 women who have come into the obstetrics and gynecology ward or to the pediatrics clinic of Marmara University Hospital have been included in this descriptive study. After securing permissions from respective departments and consents of the participants, researchers administered a questionnaire by the method of face to face. The data were analyzed using chi-square test in SPSS 22.0.

Results: Mean age of the participants was 28 (SD: ±5.85). 24 (%11.8) participants had smoked at some point in their lives, while 12 (%5.9) of them continue to smoke. 7 (%29.2) women who ceased to smoke did so during their first pregnancy. 16 (%7.8) women stated they smoked during pregnancy, and 8 (%3.9) of them stated they smoked during breastfeeding. 33 (%26.6) of the participants with smokers in the household avoided second hand smoking, while the number of women without smokers in the household was 91 (%73.4) (p<0.05). 4 (%6.7) women with low education level and 20 (%62,5) women who had a higher level of education gave history of smoking (p<0.05).

Conclusions: Smoking women during pregnancy determined to have had inadequate help from health professionals to stop smoking and has a low smoking cessation rate. Primary health care services should actively take part in decreasing the number of smoking pregnant and breastfeeding women.

Keywords: smoking, pregnancy, knowledge and attitude

Figure 1: Smoking history of women during lifetime and pregnancy (Istanbul,2014)

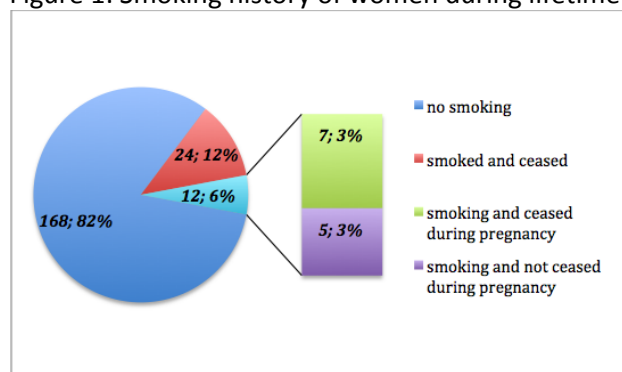


Table 1: Avoidance from second hand smoking during pregnancy according to presence of smokers in the household (Istanbul, 2014)

Presence of smokers in the household	Avoidance from second hand smoking during pregnancy				Total		p value
	Yes		No		n	%	
	n	%	n	%			
Yes	33	34,0	64	66,0	97	100	<0,001
No	91	85,0	16	15,0	107	100	

P-0444

High parity as an independent risk factor for pregnancy anemia

Gintarė Smalinskaitė, Kazys Simanauskas

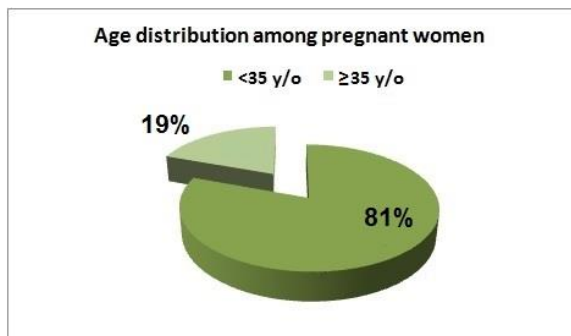
Faculty of Medicine: Clinic of Internal Diseases And Family Medicine, Vilnius University, Vilnius, Lithuania
 Background and AIM: Anemia is affecting 1.62 billion people globally. Anemia occurs at all stages of life but its risk is higher in state of pregnancy due to an increased iron requirement, physiological demand and loss of blood. The aim of the study was to assess high parity (≥5 pregnancies) as an independent risk factor to developing anemia during pregnancy in patients of Family medicine centre of Vilnius university Santariškių clinic, Vilnius, Lithuania.
 METHODS: A total of 360 medical records of pregnant women were included as a study subject from 2010 to 2014. The main hematological indicators (Hgb, Hct, MCV, MCH, MCHC), parity and prevalence of anemia during all trimesters were assessed. The data were processed and analyzed using Microsoft Excel for Windows 2007 and Statistical Package for Social Science (SPSS) version 17.0.

RESULTS: In our study, 2.2 per cent of pregnancies were characterised as high parity. Women with high parity pregnancy had significantly (p<0.05) lower Hgb and Hct levels in first trimester of pregnancy. There was no significant difference in other hematological indicators regarding parity status.

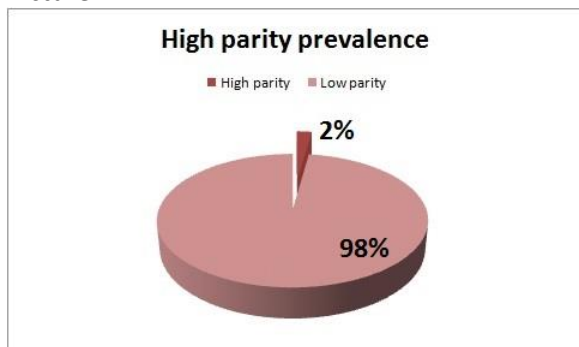
CONCLUSIONS: In this study lower Hgb and Hct levels in first trimester of pregnancy were more frequent in women with high parity suggesting that increasing parity appears to increase the risk of occurrence of pregnancy anemia.

Keywords: Anemia, parity, pregnancy

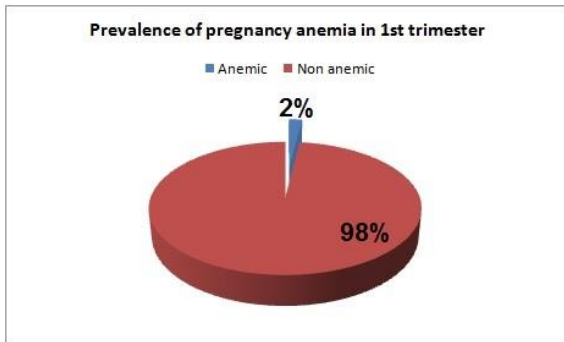
Picture 1



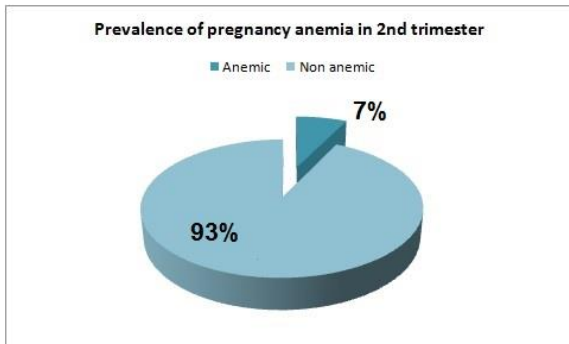
Picture 2



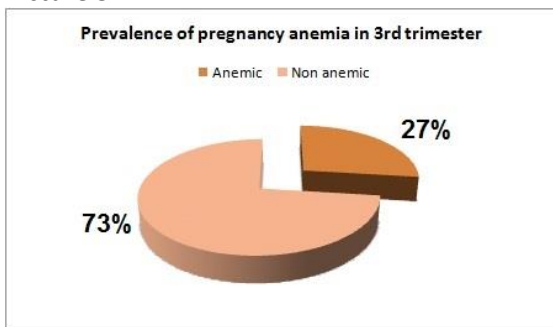
Picture 3



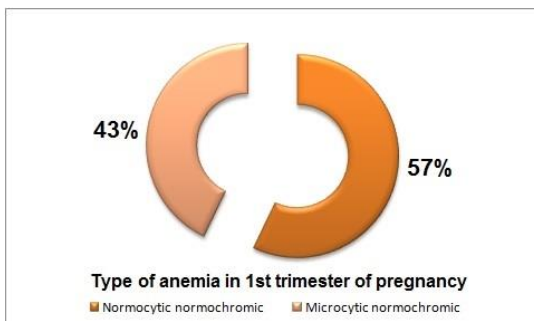
Picture 4



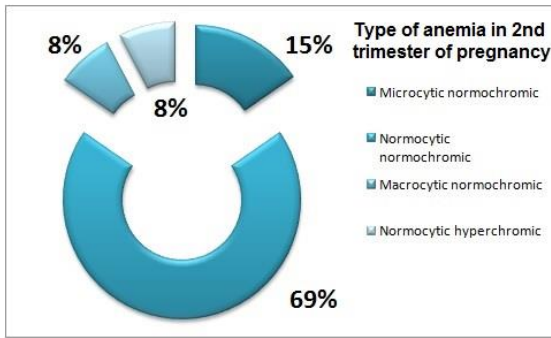
Picture 5



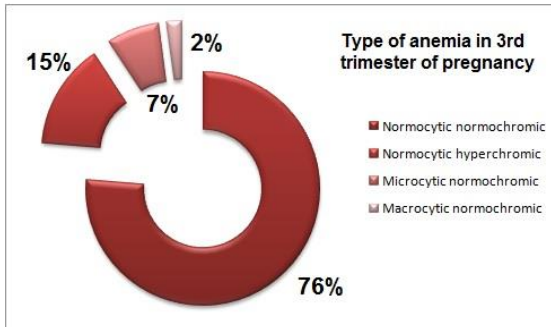
Picture 6



Picture 7



Picture 8



P-0445

Planned pregnancy rates and research status about pregnancy before planning

Ceyhun Yurtsever, Elif Altunbaş Ateş, Turan Set

Department of Family Medicine, Karadeniz Technical University, Trabzon, Turkey

Background & AIM: In this study, determination of the research before pregnancy and planned pregnancy rates and affecting factors are intended.

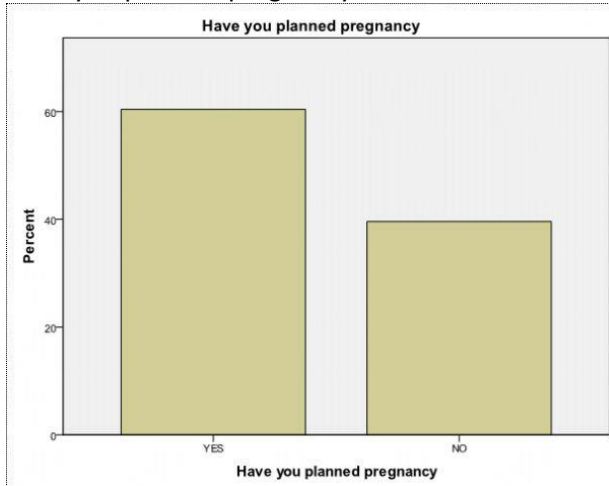
METHODS: This study was performed on the pregnancy clinic, Karadeniz Technical University, Faculty of Medicine in January 2015 as a cross-sectional study. A questionnaire asking patients' demographic characteristics, pregnancy is planned or not and research status about pregnancy before getting pregnant was developed by researchers. This survey was performed in 102 pregnant volunteers.

RESULTS: The mean age of participants was 30.6±6.1 years. Pregnants who had planned currently pregnancy rate was 60.4%. The percentage of those that are doing research for information and consultation before pregnancy was 24.5%. Information resources were family physicians (31.8%), obstetrician (31.8%) and other ways such as internet and books (34.4%). The higher education of the participants state was found to increase the rate of pregnancy is planned (p=0,032). Between participants who research before pregnancy, the answer to question of "to whom did you consult" was changed as "family physician" when the education level decreased (p=0,011).

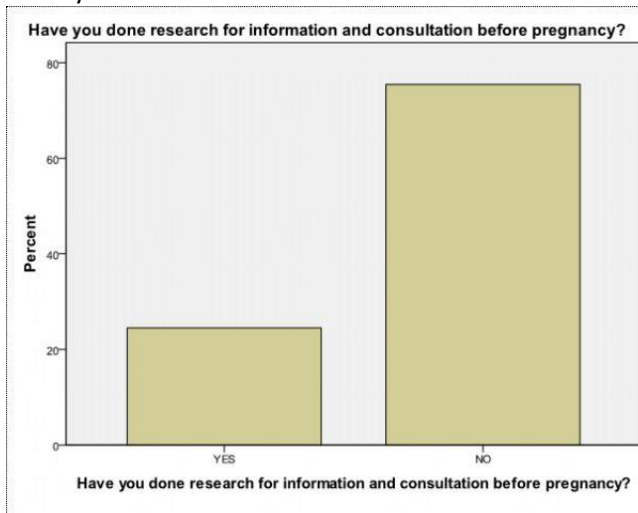
CONCLUSION: In our study, knowledge about pregnancy planning and pre-pregnancy care has been shown to be minimal, especially for poor socioeconomic status and low educational level. Uncontrolled, successive births and abortions threaten the mother-child health. In our study, the rate of consulting to the family physician was found that increased when patient's education is decreased. This shows the effectiveness and accessibility of family medicine in low socio-economic level. In accordance with knowing that only a quarter of women do research before pregnancy, it suggests that our society is not sufficient consciousness. It must be given attention to family planning and pre-pregnancy counseling services that be given to all women of reproductive age. In this point, family physicians providing health care services to all segments of society have an important role.

Keywords: Family physician, Family planning, Care before pregnancy

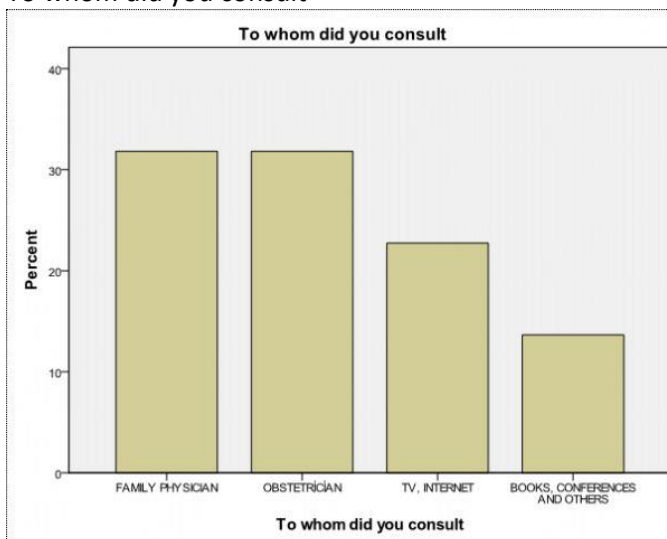
Have you planned pregnancy



Have you done research for information and consultation before pregnancy



To whom did you consult



P-0446

Early pregnancy – a family tendency

Adriana Relvas, Maria Miguel Sá, Suzie S. Leandro

USF Famílias, ACeS Entre Douro e Vouga, Santa Maria da Feira, Portugal

Background & AIM: Through a proper family evaluation the family physician should be able to identify risk behaviours with a potential intergenerational pattern. Then, once identified, it is possible to act upon those risk factors.

METHOD: Interview/Family evaluation with patient

RESULTS: MLFS, 46 years old, female, married at 21years of age, pregnant three times, three daughters (first pregnancy wasn't planned and the patient was unemployed at the time). The patient is part of a nuclear family in stage IV of Duvall life cycle. Major consumer of medical appointments. Her first daughter is 25 years old, single and has 2 children (3 and 5 years old), the second oldest daughter is 19 years old and had her only child at 17 (at the time she also was unemployed and the pregnancy wasn't planned). The youngest daughter is 11 years old, hasn't started her sexual activity but in various medical appointments she has stated that her wish is to be a mother, just like her siblings.

When the family evaluation was performed, it was clear that there existed frequent conflicts between the couple and between mother and daughters.

CONCLUSION: Family evaluation instruments are an important tool in Family Medicine. Having in consideration the changes in the family dynamics or through the repetition of risk patterns, in this case a history of non-planned adolescent pregnancies, it is necessary that all the family members readjust their role in the family to support the new members. The youngest daughter should be a major focus point during the preparation of this family with the main objective of stopping this pattern.

Keywords: Family evaluation, pregnancy, intergenerational pattern

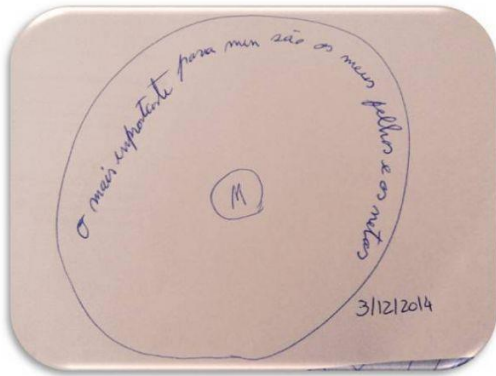
figure 1



Instruments

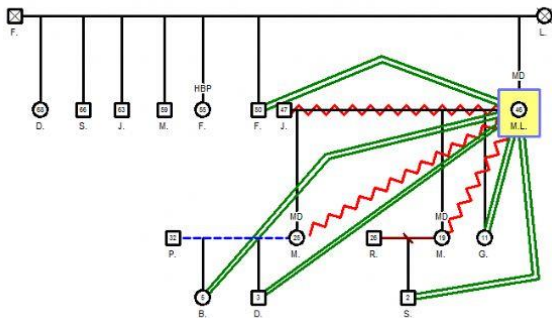
Instrument	Result
Graffar Scale	20 p (Meddium-low)
Smilkstein Family Apgar	9 p (Highly functional)
Segovia-Dryer	2 p (Low-risk)

Thrower family circle

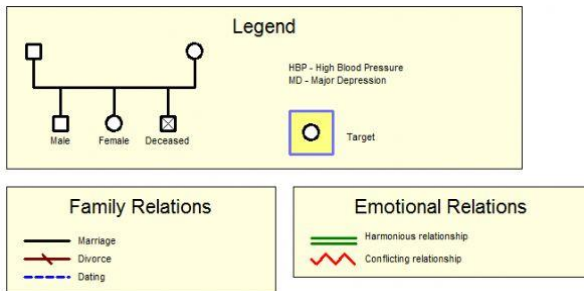


Translation: "The most important to me are my daughters and my grandchildren"

Genogram



Genogram Legend



P-0447

Case Report: Approach To Hypothyroidism In Preconceptional Phase

Mehmet Ziya Gençer, Reyhan Üstündağ, Ezgi Kaçar, Gözde Nizamoğlu, Seçil Arica
Department of Family Medicine, Okmeydani Training And Research Hospital, Istanbul, Turkey

INTRODUCTION: Hypothyroidism is the disease which occurs due to the lack or insufficiency of the thyroid hormone at tissue level. While clinical hypothyroidism can be spotted by laboratory data of high TSH and low T4, in subclinical hypothyroidism ST4 levels can be within normal levels. Hypothyroidism is mostly observed at %1-2 during pregnancy and is one of the major reasons for infertility.

CASE: A 30 year old patient with gravide1, parity1, living-child1, planning for pregnancy applied to our family medicine clinic with the complaints of inability to lose weight, continued fatigue, drowsiness, listlessness, intolerance to cold and hair fall. Nothing unusual observed in the patient's physical examination. In laboratory experiments, TSH:11.8mIU/L, T4:0.630, Hb:10.1g/dL, vitamin B12:143.6 pg/mL, iron binding capacity:367.7 µg/dL, serum iron:18µg/dL ve serum ferritin:19.7ng/mL, vitamin B12:143.6 pg/mL was found out. Upon detecting hypothyroidism, the patient's thyroid autoantibodies were checked by her thyroid usg. While her anti-TPO ve anti-Tg levels were seen positive, results of usg was consistent with Hashimoto's disease. The patient was provided 1.6µg/kg of levothyroxin replacement treatment, iron, folic acid and B12. The patient was called for control after 4 weeks and Hb:11.7g/dL, TSH:7.1mIU/L, T4:0.855mIU/L vitamin B12:388.7pg/mL was observed. Levothyroxin treatment continued with an increased dose of 1.9 µg/kg. After 7 weeks, seeing that TSH:2.05mIU/L, T4:1.42 mIU/L, Hb:13.2 g/dL, Vitamin B12:473 pg/mL, the patient was told that she can plan pregnancy after the consultative service of 1 month prior to the pregnancy.

DISCUSSION and OUTCOME: The major reason for hypothyroidism during pregnancy is the lack of iodine. For pregnant women with the sufficient level of iodine intake, autoimmune thyroiditis arises as the most common reason for hypothyroidism. Therefore, family medicine experts should not skip the diagnosis of hypothyroidism prior to and during pregnancy, they rather should initiate the treatment needed and refer the more complex cases to an endocrinologist

Keywords: Hypothyroidism, Preconception, Anemia, Pregnancy

P-0448

Smoking and pregnancy: What to do? – An evidence-based revision

Helena Marques¹, Juliana Pais², Maria Miguel Sá³

¹USF S. Félix da Marinha, ACeS Espinho/Gaia, S. Félix da Marinha, Portugal

²USF Cuidar, ACeS Entre Douro e Vouga, Santa Maria da Feira, Portugal

³USF Famílias, ACeS Entre Douro e Vouga, Santa Maria da Feira, Portugal

Background & Aim

Smoking is the most important preventable cause of adverse outcomes in pregnancy. Helping pregnant women who smoke to quit, involves communicating in a sensitive, patient-centred manner. Cognitive behavioural therapy should be the first treatment option for smoking cessation during this period. The use of pharmacotherapy like Nicotine replacement therapy (NRT) can enhance quit rates in nonpregnant individuals and it is effective and safety.

To determine the efficacy of NRT to support smoking cessation in pregnancy compared with placebo

Method

Comprehensive searches had been conducted in February 2015 on several evidence-based medical database, between January 2005 and February 2015, using MeSH Terms. For the evidence classification was used the Strength of Recommendation Taxonomy (SORT) by American Family Physician

Results

Were identified 32 articles and selected 7. Four guidelines, one systematic review (SR) and two placebo randomized controlled trials (RCT). The main outcome was self-reported smoking cessation at delivery, validated when possible by biochemical measures.

Conclusions

There is currently insufficient evidence to determine whether or not NRT is effective when used in pregnancy for smoking cessation. In all almost studies was observed poor adherence and failure in the use of long courses of NRT. Despite a lack of conclusive evidence, such treatment is recommended by United Kingdom, Australian and Canadian health authorities but not by United States guidelines. Further research is required.

Keywords: Nicotine Replacement Therapy, pregnancy, efficacy

Results: Meta-analysis "Tim Coleman et al" 2010

STUDY	TYPE OF STUDY	POPULATION	INTERVENTION	RESULTS	DISCUSSION
"Tim Coleman et al" 2010	MA • 5 CT - 3 RCT - 2 RT	• 695 Pregnant smokers • > 16 Y	3 RCT: NRT vs Placebo - Patches during 12 weeks - Gum 2mg	1.17[0.83, 1.65] P=0.44 CI 95% Insufficient evidence	• Low compliance NRT: 11 - 23.5% Placebo: 0 - 7% Level evidence: 2

Randomized controlled trials: SNAP trial and SNIPP trial

STUDY	TYPE OF STUDY	SAMPLE	INTERVENTION	RESULTS	DISCUSSION
SNAP "Tim Coleman et al" 2014	RCT Double-blind	• 1050 pregnant • 12-24 w Gestation • > 5cig/d	NRT vs Placebo 15mg/16h 4 + 4 weeks	• Abstinence until delivery validated by CO exhaled • 9.4% NRT vs 7.6% placebo • OR 1.26 [0.82, 1.96] CI 95%	• Compliance 7.2% NRT vs 2.8% placebo • No statistically significant difference • Level evidence: 2
SNIPP "Ivan Berlin et al" 2014	RCT Double-blind	• 476 pregnant • 12-20 w Gestation • > 18 Y • > 5cig/d	NRT vs Placebo	5.5 % NRT vs 5.1 % placebo • RR 1.1 [0.7, 1.8] CI 95%	• Compliance NRT: 85 % Placebo: 83 % • Nicotine patches do not increase abstinence rate • Level evidence: 1

Results: Guidelines for smoking cessation in pregnant

Guideline	RESULTS	SR
U.S Preventive Services Task Force 2009	The USPSTF concludes that the current evidence is insufficient to assess the balance of benefits and harms of pharmacotherapy interventions for tobacco cessation in pregnant women.	I (Weak)
NICE "Quitting smoking in pregnancy and following childbirth" - 2010	• Use only if smoking cessation without NRT fails. Discuss the risks and benefits of NRT • Advise pregnant woman to remove them before going to bed	++ (Strong)
Society of obstetrician and gynaecologists of Canada 2011	• NRT and/or pharmacotherapy can be considered if counselling is not successful	1-A (Strong)
Supporting smoking cessation (The Royal Australian College of General Practitioners) 2014	• There is currently a lack of evidence on the safety of pharmacotherapy in pregnancy, but international guidelines recommend use of NRT in certain circumstances – level V • Use of NRT should be considered when a pregnant woman is otherwise unable to quit. Intermittent NRT is preferred to patches (lower total daily nicotine dose).	C (Weak)

P-0449

Atypical Preeclampsia

Ayşe Pervanlar¹, Saadet Berrin Yalcin¹, Necdet Suer², Zuhale Aydan Sağlam¹

¹Department of Family Medicine, Istanbul Medeniyet University Goztepe Training and Research Hospital, Istanbul, Turkey

²Department of Obstetrics and Gynaecology, Istanbul Medeniyet University Goztepe Training and Research Hospital, Istanbul, Turkey

AIM

Preeclampsia is a multisystemic illness which presents with hypertension, proteinuria, and edema some time after 20 weeks. Recent data suggest that in some women, preeclampsia and eclampsia may develop in the absence of hypertension or proteinuria. The purpose of this study is to increase the awareness of atypical preeclampsia (Table 1).

CASE REPORT

A 30 year old multipara was admitted to our clinic with regular contractions at 33 weeks' gestation. All her prenatal visits had been normal. Cervix was 2 cm dilated and 40% effaced. Physical examination revealed normal. Laboratory findings and blood pressure (BP) were also normal but she had a dipstick proteinuria of 3+. The intrapartum fetal heart rate recording revealed poor variability and late decelerations. An emergency Cesarean delivery was performed for fetal distress. A male baby weighing 1900 g was delivered with APGAR scores of 4 and 6 at 1 and 5 min. The baby was admitted to the intensive care unit for respiratory distress syndrome. 2 h postoperatively, the mother had a severe headache and visual blurring with a BP of 160/100 mm Hg. MgSO₄ infusion was started with a loading dose 4.5 g over 20 minutes, followed by a maintenance dose of 2g/h as an intravenous infusion for 24 h. Three days later, her complaints resolved and she became normotensive. She was discharged on the 4th postoperative day.

DISCUSSION

However its classic triad is known as hypertension, proteinuria, and edema, recent data suggest that, preeclampsia may develop in the absence of hypertension or proteinuria. In conclusion, the absence of hypertension or proteinuria should not preclude preeclampsia. Fetal distress may be the first presenting scenario in atypical cases. Women who have irregular antenatal visits are at risk for preeclampsia 7 times more when compared to the women who have regular visits. We can prevent bad scenarios by planning regular visits and keeping atypical preeclampsia in mind.

Keywords: Preeclampsia, eclampsia, atypical.

Atypical preeclampsia

Gestational hypertension plus

Mild symptoms of preeclampsia

Thrombocytopenia

Elevated liver enzymes

Proteinuria plus

Hemolysis

Thrombocytopenia

Elevated liver enzymes

Early preeclampsia at <20 weeks

Late postpartum preeclampsia/eclampsia

HELLP, ELLP, and EL syndromes

P-0450

Context of postpartum care: a cross-sectional study

Binali Çatak¹, Can Öner², Sevinç Sütü³, Selçuk Kılıç³

¹Kafkas University School of Medicine

²Istanbul Bilim University School of Medicine

³Burdur Public Health Directorate

An adequate care to be carried out following the birth reduces infant and mother mortality. The main objective of this study is to evaluate the postnatal care services in terms of quantity and context.

The research population consists of 816 women who gave birth. The data collected by a form prepared by researchers basing on Postpartum Care-Management Guide (DSB-YR). Postpartum care was evaluated in terms of quantity, context as well as the factors affecting such context in the study. Data were analyzed with the SPSS 20.0 software package.

All of the women received postpartum care from family physicians and/or family health midwives within 45 days subsequent to being discharged from the hospital. 3.1% of women had one, 57,8% had twice and 39,1% of them had three or more postpartum care. The average number of postpartum care per woman is 2.5 (\pm 0.8). The parameter average per puerpera was 8.5 (\pm 4.1) while its median was 8 (0-16). In conclusion, all women within the study received at least one postpartum care.

Approximately six out of every ten women received care less than three times; and the context of postpartum care is inadequate in terms of the determined parameters.

Keywords: pcare, quality, primary care, mother health

Table 1: Procedure application states in history, physical examination and information sections

count *	Belonging group of parameters		
	History	Physical examination	Information
	n (%)	n (%)	n (%)
0	231 (30,3)	139 (18,2)	31 (4,1)
1	152 (19,9)	109 (14,3)	69 (9,0)
2	109 (14,3)	149 (19,5)	96 (12,6)
3	83 (10,9)	234 (30,7)	124 (16,3)
4	53 (6,9)	107 (14,0)	192 (25,2)
5	135 (17,7)	23 (3,3)	251 (32,9)
Mean (SD)	2,0 (\pm 1,8)	2,2 (\pm 1,4)	3,5 (\pm 1,5)
Total	763 (100,0)	763 (100,0)	763 (100,0)

Table 2: Inclusion of specified parameters within postpartum care context

Table 2: Inclusion of specified parameters within postpartum care context

Parameters	Delivered	Non-delivered	Total
	n (%)	n (%)	n (%) ^a
History Section			
Bleeding	499 (65,4)	264 (34,6)	763 (100,0)
Urinary problems	291 (38,1)	472 (61,9)	763 (100,0)
Pain	272 (35,6)	491 (64,4)	763 (100,0)
Intestinal activity	230(30,1)	533 (69,9)	763 (100,0)
Palpitations/ Dyspnea	214 (28,0)	549 (72,0)	763 (100,0)
Physical examination Section			
Blood pressure measurement	612 (80,2)	151 (19,8)	763 (100,0)
Pulse count	452 (59,2)	311 (40,8)	763 (100,0)
Temperature measurement	378 (49,5)	385 (50,5)	763 (100,0)
Abdominal examination	184 (24,1)	579 (75,9)	763 (100,0)
Perineal examination	36 (4,7)	727 (95,3)	763 (100,0)
Information Section			
Breast feeding	684 (89,6)	79 (10,4)	763 (100,0)
Family Planning	576 (75,5)	189 (24,5)	763 (100,0)
Maternal nutrition	581 (76,1)	182 (23,9)	763 (100,0)
Breast care	450 (59,0)	313 (41,0)	763 (100,0)
Emergency situation in postpartum period	365 (47,8)	398 (52,2)	763 (100,0)
Ferrum preparations	624 (81,8)	139 (18,2)	763 (100,0)

^aRow percentage

Table 3: Sociodemographic features and postpartum care context points relations

Sociodemographic features	Postpartum care context points			Total	χ ²	P
	≤5	6-10	≥11			
	n (%) ^a	n (%) ^a	n (%) ^a	n (%) ^a		
Settlement						
Village	57 (28,6)	91 (41,1)	83 (30,3)	231 (40,3)	0,429	0,807
City	140(34,0)	213 (38,0)	179 (28,0)	532 (69,7)		
Age						
≤19 years	8 (14,0)	27 (47,4)	22 (38,6)	57 (7,5)	8,657	0,070
20-34	159 (25,8)	250 (40,6)	207 (33,6)	616 (80,7)		
≥35 years	30 (33,3)	27 (30,0)	33 (36,7)	90 (11,8)		
Education						
≤8 year	115 (26,1)	109 (38,4)	156 (35,5)	480 (57,7)	0,954	0,621
≥9 year	82 (25,4)	135 (41,8)	106 (32,8)	323 (42,3)		
Husband education^{***}						
≤8 year	90 (24,5)	141 (38,3)	137 (37,2)	370 (48,5)	2,638	0,267
≥9 year	105 (26,8)	163 (41,6)	124 (31,6)	398 (51,5)		
Working status						
Working	24 (25,8)	42 (43,2)	27 (29,0)	93 (12,2)	1,620	0,445
Non-working	175 (25,8)	262 (39,1)	235 (35,1)	670 (87,8)		
Husband's working status^{***}						
Non-working	19 (25,0)	27 (35,5)	30 (39,5)	77(10,1)	4,895	0,298
Own job	52 (22,9)	103 (45,4)	72 (31,7)	228 (29,9)		

Private or public sector	126 (27,6)	173 (37,9)	158 (34,6)	458 (60,2)		
Health insurance						
Non	4 (15,4)	11 (42,3)	11 (42,3)	26 (35,4)	1,074	0,435
Yes	193 (26,2)	293 (39,8)	251 (34,1)	737 (96,6)		
Total income &						
Adequate	74 (24,5)	125 (41,4)	103 (34,1)	302 (39,6)	0,636	0,728
Non-adequate	123 (26,7)	179 (38,9)	158 (34,5)	461 (43,3)		
Family type						
Extended family	31 (25,8)	40 (33,3)	49 (40,8)	120 (15,7)	3,264	0,196
Nuclear family	166 (25,8)	269 (41,1)	233 (33,1)	643 (84,3)		
Consanguinity with husband						
Yes	20 (27,0)	24 (32,4)	30 (40,5)	74 (9,7)	2,094	0,351
No	177 (25,7)	280 (40,6)	232 (33,7)	689 (90,3)		
Person count in home^z						
≤4	134 (25,4)	219 (41,6)	174 (33,0)	528 (69,2)	2,001	0,368
≥5	62 (26,5)	85 (36,3)	87 (37,2)	235 (30,8)		
Total^a	197 (25,8)	304 (39,8)	262 (34,5)	763 (100,0)		

^arow percentage, ^zcolumn percentage, ^{***}3 data missing, ^z2 data missing, & 1 data missing

Table 4: Biodemographic features and health service use and postpartum care context points relations

Biodemographic	Postpartum care context points				χ ²	P
	<5	6-10	≥10	Total		
Maternal and health service use	n(%) ^a	n(%) ^a	n(%) ^a	n(%) ^a		
Birth place^b						
Public Hospital	128 (24,4)	189 (36,3)	193 (37,3)	510 (28,0)	5,256	0,012
Private Hospital	68 (13,3)	184 (35,3)	89 (16,6)	341 (18,9)		
Birth type						
Normal	86 (25,6)	118 (35,3)	127 (38,3)	331 (40,2)	0,994	0,363
Cesarean	11 (25,6)	185 (42,3)	135 (31,3)	411 (36,2)		
In previous day in hospital^c						
Below one day	4 (22,2)	8 (33,3)	8 (44,4)	18 (24,4)	2,035	0,356
1-2 days	137 (26,6)	201 (39,6)	166 (35,6)	504 (28,0)		
Above 3 days	25 (25,6)	88 (41,3)	68 (31,3)	217 (28,0)		
Pregnancy event						
1	83 (18,3)	117 (33,3)	99 (36,3)	299 (28,0)		
2	75 (29,3)	97 (39,3)	77 (31,4)	249 (35,3)		
3	71 (28,3)	82 (36,6)	86 (35,3)	239 (31,6)	0,079	0,870
Total ^d	337 (25,6)	384 (38,3)	362 (34,3)	1083 (100,0)		

Includes only women who had at least one birth except last one.

Spontaneous abortion						
Yes	18 (21,3)	57 (40,5)	47 (32,3)	142 (28,3)	0,733	0,692
No	186 (25,6)	189 (35,3)	188 (33,3)	563 (51,7)		
Contraception						
Yes	10 (13,3)	8 (28,3)	12 (40,0)	30 (6,0)	1,723	0,423
No	134 (18,3)	179 (36,6)	151 (25,3)	464 (45,7)		
Still birth						
Yes	2 (3,4)	8 (9,6)	7 (5,8)	17 (2,6)	2,866	0,236
No	142 (28,3)	183 (38,3)	156 (42,4)	481 (49,4)		
Child death below 5 years						
Yes	2 (25,6)	8 (37,5)	8 (37,5)	18 (32,0)		
No	146 (28,3)	181 (37,6)	157 (32,6)	484 (46,8)	0,289	0,599
Total ^e	148 (33,6)	187 (36,8)	165 (29,6)	499 (48,6)		

^aRow percentage, ^bColumn percentage, ^c2 home births were not included.

P-0451

Infant health and vaccination parameters in unplanned home birth delivery

Binali Çatak¹, Can Öner²

¹Kafkas University School of Medicine

²Istanbul Bilim University School of Medicine

It has been reported that infants delivered at home carry higher risks of morbidity and mortality. Not only that but also their use of health services are quite low. The aim of this study was to determine the vaccination parameters of home birth infants.

The data of this study was derived from part of prenatal and postpartum care of an other study namely "Unplanned home birth and affecting factors in Istanbul". This study was designed as case control study. The "case" group consisted of 168 women who had "unplanned home deliveries" and "control" group (n=367) of women giving birth in hospitals. The data of the study were collected by the researchers using the data collection form. Vaccination determined according to "vaccination schedule of ministry of health". Neonatal screening program attendance was evaluated. Data were analyzed by SPSS 20.0 package program.

9 (5,4%) babies in case group and 2 (0,5%) babies in control group was not vaccinated. Vaccine coverage rate was 94,6% in case group and 99,5% in control group (p=0,000). Male/Female ratio in unvaccinated babies was 4/5 in case and 1/1 in control. In case group only one baby's (0,8%) blood samples for neonatal screening (hypothyroidism, biotinidase deficiency and phenylketonuria) was not taken and this was 3 (0,6%) in control group. For hearing test 36,9% (n=62) of case group and 9,3% (n=34) of control group was not screen for hearing (p=0,001). Although there were a significant difference in coverage rate of vaccination, in both groups the rates were high. For screening only hearing test was significantly low in home birth group.

Keywords: vaccination, infant health, unplanned home birth

Figure 1

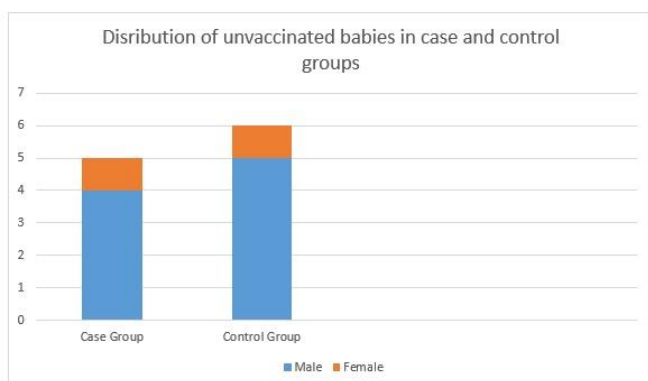
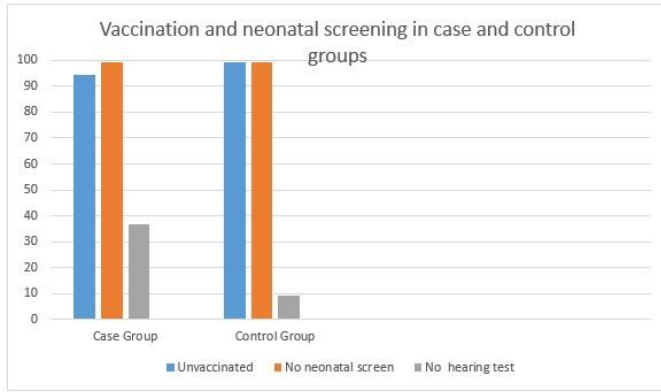


Figure 2



P-0452

Vitamin D Levels in Pregnant Women and Umbilical Cord Blood, and Their Relation With Birth Measurements

Ayşe Özlem Kılıçaslan¹, Ruhusen Kutlu², Derya Işıklar Özberk²

¹Karatay Fetih Family Health Center, Konya, TURKEY

²Department of Family Physician, Meram Medical Faculty, Konya Necmettin Erbakan University, TURKEY

Background & AIM: Vitamin D deficiency may result in some significant health problems in pregnancy and fetus. We aimed to measure the levels of Vitamin 25(OH) D, in pregnant women and their neonates, and assess the relation between Vitamin D supplementation and the growth parameters at the neonates.

METHOD: This cross-sectional analytical study was performed with 100 pregnant women at term, and neonates. The blood samples were obtained from the mothers before labor and from the umbilical cord during the labor. The growth parameters of the neonates were measured.

RESULTS: The mean Vitamin D levels of the pregnant were 11.39 ± 6.24 ng/ml, and neonates were 8.00 ± 4.95 ng/ml. Fifty-three percent of the mothers had Vitamin D deficiency (<10 ng/ml) and 47% of them had Vitamin D insufficiency (10-30 ng/ml). Maternal Vitamin D deficiency was detected in 62.3% of the women who did not use a Vitamin D supplement, whereas this rate was 37.7% among the women who used a supplement ($p < 0.001$). The height ($p = 0.004$), head ($p = 0.003$) and chest ($p = 0.005$) circumference of the neonates of the mothers who received Vitamin D supplements were also significantly different. Birth height, head and chest circumference of the neonates of the pregnant women who had Vitamin D deficiency were significantly lower than the measurements taken from the neonates of the mothers with Vitamin D insufficiency ($p < 0.001$).

CONCLUSIONS: According to the results of the present study, the Vitamin D levels of the mothers and the levels measured at the umbilical cord blood were still very insufficient, despite the ongoing Vitamin D supplementation program set for the pregnant women in Turkey. The measures taken to prevent maternal Vitamin D deficiency should be intensified.

Keywords: Vitamin 25(OH)D, pregnancy, cord blood

P-0453**Study Protocol: An Exploration of Health Professional Support for Breastfeeding- a primary care study**

Puteri Shanaz Jahn Kassim¹, Dayangku Hayaty Awg Dzulkarnain¹, Nurjasmine Aida Jamani², Aneesa Abdul Rashid¹, Nurainul Hana Shamsuddin¹, Maliza Mawardi¹

¹Department of Family Medicine, Faculty of Medicine and Health Sciences, Universiti Putra Malaysia

²Department of Family Medicine, Kulliyah of Medicine, International Islamic University of Malaysia

INTRODUCTION: Eventhough there has been substantial evidence on the benefits of breastfeeding, Malaysia has one of the lowest rates of breastfeeding in Asia. The Malaysia Third National and Health Morbidity Survey (NHMS III) 2006 showed that less than 15% of infants below six months were breastfed exclusively in 2006; and the prevalence of continued breastfeeding up to two years old in Malaysia was 37.4% which is among the lowest compared to the prevalence in other countries in South East Asia. The role of health professionals in promoting and supporting breastfeeding has been increasingly emphasized. However, data on health professionals' perspectives on breastfeeding in Malaysia has been lacking. The aim of this study is to understand health professionals' perspectives on breastfeeding, their knowledge and attitudes towards breastfeeding and their self-efficacy in dealing with breastfeeding issues, as well as perceived barriers to providing support and issues around breastfeeding education.

METHOD: This research is a quantitative cross-sectional survey which investigates different aspects of community health professionals' (n=459) knowledge and attitudes towards breastfeeding, their self efficacy in dealing with breastfeeding issues and issues around breastfeeding education. Data collection will be carried out using a self-administered questionnaire which will be distributed to family physicians, medical officers, practice and public health nurses in selected public and maternal and child health clinics in Selangor. Analysis will be conducted with SPSS 22.0.

As no studies have previously been done in Malaysia evaluating breastfeeding knowledge and attitudes among health professionals, the result of this study could be used to establish a baseline for use in future assessments and will help measure the effectiveness of the activities of health education. It is hoped that this study will provide a greater understanding of professional support for breastfeeding, as such information would help identify areas for improvement around professional support for breastfeeding.

Keywords: breastfeeding, knowledge, attitudes, self-efficacy, barriers, education

P-0454**Delayed childbearing for students: a hidden issue, dilemma, or real emotional problem?**

Pascal Collard¹, Claudia M. Van Der Heijde², Peter Vonk³, Frans J. Meijman⁴

¹Policy Analysis and Entrepreneurship in the Health and Life Sciences, VU University, Amsterdam, The Netherlands

²Student Health Services, Department of Research, Development and Prevention, University of Amsterdam, Amsterdam, the Netherlands

³Huisartsen Oude Turfmarkt and Student Health Services, General Practice, University of Amsterdam, Amsterdam, the Netherlands

⁴Department of general practice & elderly care medicine, VUmc School of Medical Sciences, VU University, Amsterdam, the Netherlands

Background and aim

From a survey in 1983 it appeared that ambivalence towards having children can lead to uncertainty, confusion and emotional distress among female university students. The aim of this study in 2013 was to measure if this ambivalence towards having children is changed in the time of thirty years, to find possible time trends and to determine indicators for general practitioners to detect internal conflicts (dilemmas or real emotional problems) regarding the desire to have children among female university students in order to provide effective care.

Method

We used a mixed methods design. Interviews with seven general practitioners, a literature search and the questionnaire used in 1983 were used to develop a new questionnaire. The newly developed questionnaire was distributed amongst female students through the Internet and a students' health service during spring 2013 (n =

398). We performed descriptive analyses and a logistic regression.

Results

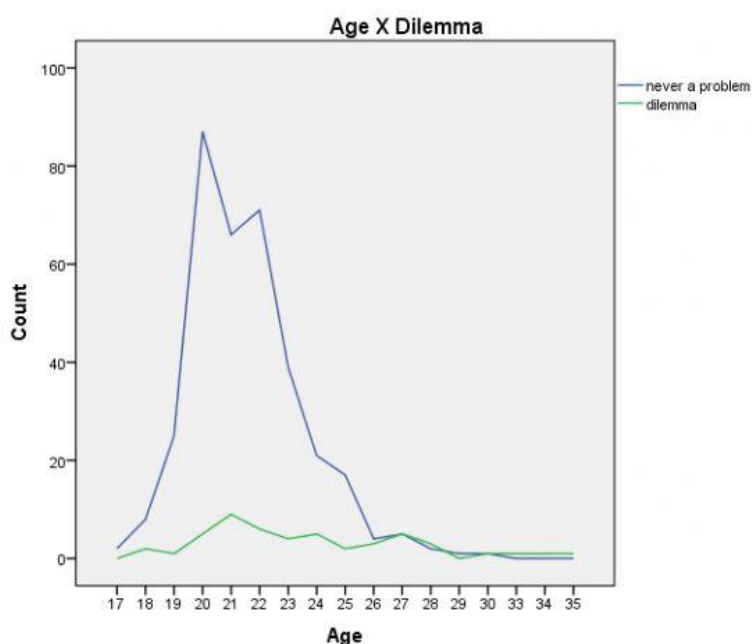
13% of the female students experienced being childless as problematic (2% often and 11% sometimes). From logistic regression analysis five factors showed significant associations with the internal conflicts concerning delayed childbearing: being older ($p=.057$), living together with a partner ($p=.080$), worrying (or worried) about fertility ($p=.003$), refusing abortion if pregnant ($p=.021$) and dissatisfaction with current contraceptive use ($p=.073$). GPs can use these factors as indicators in student patient consultations to detect dilemmas or real emotional problems.

Conclusions

Female students may experience being childless as a dilemma or even as a real problem in 2013. There was similarity in outcomes with the 1983 study. The factors correlating with the presence of a real problem or dilemma can be used by general practitioners as indicators that may prove useful to identify students with ambivalence towards delayed childbearing, in order to provide effective care.

Keywords: delayed childbearing, students, emotional well-being

Graph



Table

Characteristic	Wald CI	p	OR	95% CI
Age	3.61	.057	1.21	0.99 - 1.46
Living together with partner	3.07	.080	.43	0.17 - 1.11
Worries about fertility	9.07	.003	.27	0.11 - 0.63
Refusing abortion if pregnant	5.35	.021	3.14	1.19 - 8.26
Morning after pill(s)	.82	.366	1.27	0.75 - 2.15
Pregnancy test(s)	.96	.327	1.29	0.77 - 2.15
Dissatisfaction with current contraceptives	3.22	.073	2.42	0.92 - 6.36

P-0455

Mothers knowledge and attitude towards routine childhood vaccination and additional vaccines

Nagehan Taştekin¹, Okcan Basat¹, Seda Geylani Güleç²

¹Department of Family Medicine, Gaziosmanpaşa Taksim Training and Research Hospital, Istanbul, Turkey

²Department of Pediatrics, Gaziosmanpaşa Taksim Training and Research Hospital, Istanbul, Turkey

Background and Aim

The aim of the study was to determine mothers' level of knowledge and attitude towards both groups of vaccines included in national immunization schedule and additional vaccines which are optional and are not a part of national schedule (Influenza, rotavirus and meningococcal vaccines).

Method

Our study was carried out between August-October 2014 on 181 mother who had 0-6 year old children admitted to Pediatric Outpatient Clinics of Taksim Gaziosmanpaşa Training and Research Hospital by interviewing with a questionnaire to evaluate their knowledge and behavior about childhood vaccination and their socio-demographic characteristics.

Results

71.8% of mothers were primary school graduate and above, 86.3% were low-middle income level. 96.7 percent of mothers considered that vaccination according to the ministry's national immunization schedule was necessary for their children.

80.7% of mothers were informed about vaccination by their family physician or nurse, other options were through media or a friend. 8.8% had not any information from any source. Scheduled timing of the first vaccination to newborn was answered correctly by 40.3% of mothers. When asked about side effects most of mothers mentioned about fever and local reaction at the injection area. 2.8% had no idea and 6% had fear about serious side effects such as anaphylaxis, neurologic impairment or death. 66.3 % had knowledge about additional vaccines. 28.7 percent of children received at least one additional vaccine. Rest of them had not received for these reasons: 14.4% financial problems, 28.7% lack of information, 28.7% believed that it was not necessary.

Conclusions

Even if many mothers were willing for vaccination they did not have adequate information about the vaccines not routinely administrated. Health care professionals have a very important role in education of mothers about immunization and disease prevention.

Keywords: childhood vaccination, parental knowledge, disease prevention

P-0456

Birth outside the system: an exploratory study (study protocol)

Julia Suhaimi¹, Nur Amani Natasha Ahmad Tajuddin¹, Siti Nurkamilla Ramdzan¹, Ahmad Ihsan Abu Bakar¹, Khasnur Abdul Malek², Ilham Ameera Ismail², Punithavathy Shanmuganathan², Nurainulhana Shamsuddin³

¹Department of Primary Care Medicine, University of Malaya, Kuala Lumpur, Malaysia

²Discipline of Primary Care Medicine, Universiti Teknologi MARA (UiTM), Malaysia

³Department of Family Medicine, Universiti Putra Malaysia, Selangor, Malaysia

BACKGROUND:

Maternal mortality and morbidity is a critical and sensitive indicator for the state of any health system. The report on the confidential enquiries into maternal deaths in Malaysia in 2006-2008 has acknowledged that the need for the issue of home delivery being conducted by untrained / unqualified birth attendants to be seriously addressed. From 2006 – 2008 there were 23 maternal deaths associated with unassisted home deliveries. The recommendation in the reports includes the need to emphasis on proper risk assessment during the antenatal care and appropriate planning of high risk cases.

AIM:

This study is to explore the factors influencing mothers and their experience of 'birth outside the system', which is defined as giving birth outside the mainstream maternity care.

METHOD:

This is a qualitative study among pregnant women in Kuala Lumpur, Malaysia who are planning to give birth

outside the system and women who had experience giving birth outside the system. It will be done through in-depth interviews based on decision making framework developed by Murray-Davis (2012).

Expected RESULTS:

We expect to understand the ideas, concerns and expectations of women who chose to give birth outside the mainstream maternity care system. From the results of this study we hope to develop strategies to improve the healthcare delivery system and to reduce maternal and perinatal mortality caused by birth outside the system.

Keywords: unassisted home birth, free birth, doula

P-0457

Family Physicians' Knowledge On Prenatal Care:Izmir/An Aspect From Turkey

Zeynep Ay¹, Huseyin Can¹, Melih Kaan Sozmen², Seckin Tosun Erdem³, Selami Dogan³, Handan Atsiz Sezik⁴

¹Family Medicine Clinic, Izmir Katip Celebi University Atatürk Training and Research Hospital, Izmir,Turkey

²Department of Public Health, Izmir Katip Celebi University, Izmir,Turkey

³Familiy Medicine Center, Izmir,Turkey

⁴Narlidere Public Health Center, Izmir,Turkey

Background and aim

About 800 women die from pregnancy or childbirth-related complications around the world every day. Almost all of these deaths could have been prevented by providing skilled care to pregnant women before, during and after childbirth. (1) In our study, we aimed to determine knowledge of family physicians (FP) on essentials of prenatal care.

Method

Our research included FPs who practice in İzmir between August-November 2104. Information obtained via questionnaire prepared by researchers based on current guidelines. Descriptive statistics are given as mean±standart deviation and percentage. Student t-tests, Mann Whitney-U tests and Chi-square tests were used to compare groups. P value <0.05 was taken as significant.

Results

Mean age of the respondents (n:225) ranged from 32-65 years old and mean age was 47.76±5.96. 34.2% (n:77) of FPs were women and 19.1% (n:43) were family medicine specialists. The mean duration of practice as a FP was 6.60±1.48 years and the average number of the pregnant women receiving prenatal care (PNC) was 21.18±11.03. All respondents stated that at least 4 PNC is necessary. Almost all FPs (97.8%) told that the first PNC visit should be before 14th gestational week. The majority of respondents knew main contents of physical examination (e.g. measuring weight and blood pressure, checking signs of anemia). Most FPs agreed to perform urine tests, haemoglobin, blood group typing and HbsAg. 92.9% of respondents knew when to start folate supplementation and 75.1% respondents knew when to start iron supplementation. Almost all respondents knew risk factors and danger sings.

Conclusions

All respondents know number and timing of PNC visits adequately. FPs have sufficient knowledge on examination and tests that can be done in primary care and danger signs. Continuing medical education and training programmes is essential to overcome lack of knowledge of FPs on tests unavailable in primary care.

Keywords: Family Physician, Prenatal Care, Primary Care

P-0458

Observation of Social Adaptation and Status in Adolescents According to the Age Groups

Gökçe Işcan¹, Ismail Arslan², Aslihan Fidancı³, Emine Yıldırım⁴, İzzet Fidancı², Duygu Yengil⁵, Enes Gümüş⁶, Oğuz Tekin²

¹Ankara Gölbaşı Toplum Sağlığı Merkezi

²Ankara Eğitim ve Araştırma Hastanesi

³Mersin Akdeniz Toplum Sağlığı Merkezi

⁴Çankırı Kızılırmak Entegre Devlet Hastanesi

⁵Şanlıurfa Ceylanpınar 1 Nolu Aile Sağlığı Merkezi

⁶Ankara Sincan Ceza İnfaz Kurumları Kampüsü Devlet Hastanesi

OBJECTIVE: To determine the social trends in different age groups of adolescents between the ages of 11 to 20 by using "Fatih Social Trends Scale for 11-20 Age Version".

MATERIAL-METHODS: The "Fatih Social Trends Scale" questionnaire was applied to volunteer 585 adolescents. "Fatih Social Trends Scale" consists of 26 questions and 6 factors about social trends of adolescents. These participants average scores and general mean of total scores based on "Fatih Social Trends Scale" are calculated. Types of descriptive features such as the distribution of age groups in the study group analysis (number, percentage, mean and standard deviation) was revealed.

RESULTS: When the study group factor score averages were compared, it was seen that all factors are affected by "reading book regularly" like "social adaptation and status", "lack of drug abuse", "avoidance of violence", "school status", "family status", "targets and ideals". Also our findings indicate that "social adaptation and status" correlated to gender; "avoidance of violence" and "school status" correlated to age range and "family status" correlated with group of "exercising regularly".

CONCLUSION: "Fatih Social Trends Scale" scores of various factors shows that there are statistical differences between the "age groups". The findings by using previously developed psychosocial scale in this study can be used for developing beneficial applications for adolescents. Significant differences in the approaches puberty study results will be taken into account in this regard, which is thought to affect guidance services.

Keywords: Adolescence, Social Trends, Fatih Social Trends Scale

P-0459

Is folic acid 100% safe during pregnancy? New perspectives!

Susana Grilo Lourenço¹, David Rodrigues¹, Marta Lopes¹, Nídia Nunes¹, Teresa Pereira Leite²

¹USF Planície, ARS Alentejo, Évora, Portugal

²USF Alcoides, ARS Alentejo, Montemor-O-Novo, Portugal

Pregnancy is a period during which both baby's and mother's safety and well care are determinant. The pregnant woman's needs of energy and nutrients, such as: folic acid, iron, essential fatty acids and fiber, are higher than ever so it is recommended, apart from a rich diet, the intake of vitamin supplements. Folic acid reduces the risk of neural tube defects. The World Health Organization defends that a daily nutrition of 0,4 mg of folic acid during pregnancy should be initiated as early as possible.

Biographical research of clinical guidelines, systematic reviews and meta-analysis in English and Portuguese, published in the last 8 years, in Medline database employing the MeSH terms: "folic acid", "pregnancy" and "supplementation".

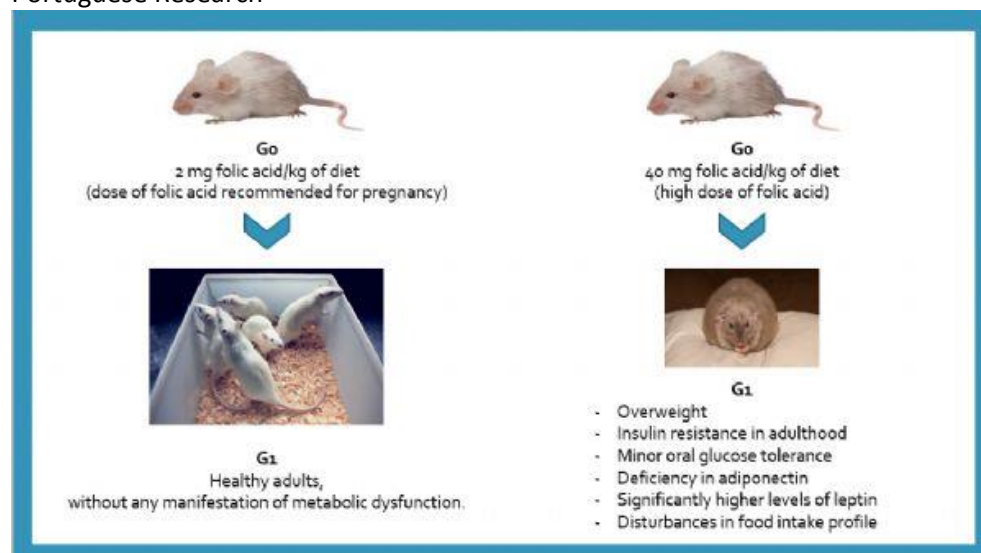
Few studies have looked at the safe upper limit of folic acid intake, even though pregnant women around the world are consuming increasingly high amounts of folic acid thanks to food fortification policies and widely available supplements and multivitamins. According to a portuguese research team from the Faculty of Medicine of the University of Oporto and the Catholic University of Portugal, the administration of 20 times of the recommended daily amount of folic acid in female rats throughout mating, the pregnancy period and lactation, results on baby rats who grew up to be overweight and insulin resistant in adulthood. The offspring also revealed to be deficient in adiponectin and they expressed food disorders. On the other hand, the female rats who's

consumed the recommended daily amount of folic acid had newborns who became healthy adults. In 2012 was published a revision in the British Journal of Nutrition "higher maternal folate status during pregnancy was associated positively with insulin resistance in 6 year old."

It is necessary to further investigate the mechanisms by which folic acid affects metabolism, finding the maximum recommended dose.

Keywords: FOLIC ACID, PREGNANCY, SUPPLEMENTATION

Portuguese Research



P-0460

Carbonmonoxide exposure in pregnancy: a case report

Emel Kelestemur¹, Samet Uludag², Merve Canbaz², Irep Karatas Eray¹

¹Department of Family Medicine, Ataturk Training and Research Hospital, Bilkent, Ankara, Turkey

²Department of Family Medicine, Yildirim Beyazit University, Bilkent, Ankara, Turkey

Background and AIM: The most common Carbonmonoxide (CO) poisoning cases in developing countries are caused stove and water heater poisoning. The presence and detection of over 15% Carboxyhemoglobin (COHb) in the blood of pregnant woman results in feto-maternal morbidity and mortality. In our study, we discussed a case of CO poisoning in the week of 17 of the pregnancy and aim to emphasize the approach to CO poisoning in the pregnancy. **CASE:** A 21-year-old female (primigravid) at 17 weeks of gestation, applied our emergency service with complain of CO exposure from the water heater. When she arrived our emergency service, she did not lose consciousness and her vital signs were stable. In the obstetric ultrasound, a fetus is observed to have positive fetal heart rate, which is well matched with 17 weeks fetus. Maternal COHb was measured at 14.2% and oxygen therapy with a flow rate of 10lt/min was applied. Although hospitalization was suggested for the following up the complications, the patient left the hospital. **DISCUSSION:** CO gas causes toxicity with two-basic mechanisms. First, the competition between CO and oxygen for hemoglobin results in tissue-hypoxia. Second mechanism is the direct damage given by CO gas. The common clinical findings are headache, nausea, vomiting, blurred-eyesight, tachycardia, tachypnea, coma and death depending on the level of CO exposure. While maternal blood COHb level is lower than the toxicity levels, fetus can be damaged. Reference ranges for COHb should be lower than 5% for pregnant. For the COHb levels in the range of 5-15%, 100% oxygen therapy should be applied. For the COHb levels of 15% and above, hyperbaric oxygen therapy should be applied. **CONCLUSION:** In the case of CO poisoning suspect in pregnant, early diagnosis and appropriate treatment prevent the formation of maternal and fetal risks that can result in death.

Keywords: Carbonmonoxide, pregnancy, poisoning

P-0461**Knowledge, Attitudes and Practices of Mothers about Home Accidents**

Gizem Erdem¹, Emre Kocazeybek¹, Fatma Zehra Avşar¹, İsmail Dikmen¹, Oğuz Kaan Şimşek¹, Yasemin Çomak¹, Hayriye Kulbay Yüksel², Nurdan Yiğit¹, Tevfik Bayram¹, Dilsad Save¹

¹Marmara University, School of Medicine, Department of Public Health

²Turkish Ministry of Health, Family Health Center

Background&AIM:

The accident is defined suddenly and unplanned event which causes physical and psychological damage by World Health Organization. Particular group of children from 0-5 years of age constitute the most important group interms of home accidents. The aim of the study was to evaluate knowledge, attitude and practice of mothers who had 0-5 age years old children.

METHOD:

This survey as a descriptive study and carried out in Kartal Pendik Kaynarca Family Health Center Zümrütevler Family Health Center. The study population was consisted of the mothers who admitted to these centers. The sample of the study were randomly selected (n=122). Questionnaires were administered by face to face interviews. The results were obtained by applying the chi-square test with the mean percentage values. $p < 0.05$ was considered significant.

RESULTS:

Type of home accidents were identified as fall, shock, burns, drowning, poisoning. The most common type of accidents was falling by 68.9%. Mothers usually found not to take enough precautions against home accidents.

CONCLUSION:

Awareness of home accidents and knowledge about the preventive measures needs to be improved in the community.

Keywords: home accidents, knowledge attitude and practice, fall, health education, preventive medicine

P-0462**The knowledge and awareness of family physicians about the red reflex test during neonatal period**

Seda Coşkun, Selda Tekiner, Filiz Ak, Gülsen Ceyhun Peker

Department of Family Medicine, Ankara University School of Medicine, Ankara, Turkey

AIM: Eye problems during childhood can lead to irreversible vision issues when the diagnosis and treatment delays. During the neonatal period of well-child visit, the red reflex test is one of the priorities which should be included in family medicine training. The aim of this study is to determine the knowledge and the awareness of the family physicians about the red reflex test within the period of newborn in well-child follow up and the affecting factors.

METHOD: Between 1st February and 13th March 2015, a questionnaire consisting of 31 items was applied to the family medicine residents and specialists who were working both in training and research hospitals and university hospitals in Ankara. One hundred and fifty four family physicians participated in the study. The analysis was performed using SPSS version 11.5 and the data were evaluated by descriptive, univariate statistical analysis.

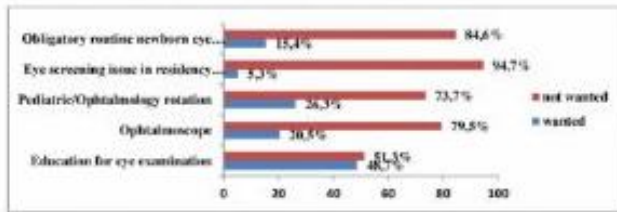
RESULTS: Mean age of the respondents was 30 years, 61% were female, 92.2% were residents, 7.8% were specialists. Of the family physicians 77.9% were working in training and research hospitals, 22.1% were in university hospitals. While 54 family physicians (35.1%) declared that they do routine eye screening examination during the neonatal period, 71% declared they don't. Of the doctors 26% told that they don't have any knowledge about eye screening examination, 19% told that she/he doesn't have an ophthalmoscope. Of the family physicians 85.7% had never heard the red reflex test. The family physicians who know the right timing of the first routine eye screening was 74%. Among the family physicians doing routine eye screening during newborn period, only 14.9% stated that they examined the red reflex test.

CONCLUSION: The knowledge and the awareness of red reflex test among family physicians is low. This issue must be given weight during residency and post graduate trainings.

Keywords: red reflex test, knowledge, awareness, family physicians

Distribution of family physicians responses to requirement for newborn eye screening (N:39)

Figure 1. Distribution of family physicians' requirement for newborn eye screening (N:39)



Note: Responses of family physicians' to the question "What do you need to do the routine eye examination during newborn period after that study?"

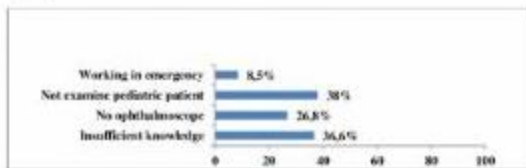
Distribution of family physicians doing routine newborn eye examination (N:154)

Figure 2. Distribution of family physicians' doing routine newborn eye examination (N:154)



Distribution of family physicians response to why not doing newborn eye examination (N:71)

Figure 3. Distribution of family physicians' response to why not doing newborn eye examination (N:71)



P-0463

An Appropriate Scale for Primary Health Care: Reliability and Validity of the Turkish Version of the Iowa Infant Feeding Attitude Scale

Nazmiye Kaçmaz Ersü¹, Abdurrahman Ersü¹, Pınar Köksal¹, Berna Erdoğan Mergen², Haluk Mergen¹, Kurtuluş Öngel³

¹Department of Family Medicine, İzmir Tepecik Training and Research Hospital, İzmir, Turkey

²İzmir Karabağlar Community Health Center, İzmir, Turkey

³Faculty of Medicine Head Department of Family Medicine, İzmir Katip Çelebi University, İzmir, Turkey

" AIM: The aim of this study is to describe reliability and validity of the Turkish version of the Iowa Infant Feeding Attitude Scale which was developed by De La Mora and colleagues.

MATERIAL-METHODS: This study was conducted with 209 mothers who have child under five years and who applied to İzmir Tepecik Education and Research Hospital. The translated IIFAS was administered to participants. Correlation analysis of total items have been done. Reliability of the scale is evaluated with Cronbach alpha coefficient. Statistical analysis is conducted using SPSS 16 and AMOS20.

RESULTS: Mean age of mothers was 30.2±5.48. 42.1% (n= 88) of mothers of children who were applied to outpatient clinics of pediatrics had primary school graduation, 24.9% (n=52) secondary school graduation and 8.6% (n=18) university or high school degree. 85.2% (n=178) of mothers didn't have any jobs.

Varimax rotation method was used for examination of factor structure of IIFAS. Result of Kaiser- Meyer- Olkin Measure of Sampling Adequacy test was found as 0.646. Result of Bartlett's Test of Sphericity was statistically significant (511, $p < 0.001$). Item-total correlation coefficient (rit) was 0.251.

Cronbach alpha coefficient calculated to detect internal reliability of the scale. Cronbach alpha internal reliability coefficient value was ($\alpha = 0.506$) before exclusion of items 8th and 17th. After exclude these items Cronbach alpha coefficient value was ($\alpha = 0.61$). χ^2/df value was 2.1 (< 5). This value was adequate for validity criterion.

CONCLUSION: Different scores of Cronbach alpha for IIFAS range with 0.46 and 0.86 for different countries. This result suggest that IIFAS gives different results for different cultures. Turkish version of IIFAS had intermediate reliability and accepted validity. Mothers attitudes for infant feeding is very important for primary health care. IIFAS is practical scale to evaluate mothers attitude for infant feeding in primary health care. "

Keywords: breastfeeding, formula, scale.reliability, validity

Iowa Infant Feeding Attitude Scale

Statement	SD	D	N	A	SA
*The benefits of breastfeeding last only as long as the baby is breastfed	1	2	3	4	5
*Formula feeding is more convenient than breastfeeding	1	2	3	4	5
Breastfeeding increases mother-infant bonding	1	2	3	4	5
*Breast milk is lacking in iron	1	2	3	4	5
Formula fed babies are more likely to be overfed than breastfed babies	1	2	3	4	5
*Formula feeding is the better choice if the mother plans to go back to work	1	2	3	4	5
Mothers who formula feed miss one of the great joys of motherhood	1	2	3	4	5
*Women should not breastfeed in public places such as restaurants	1	2	3	4	5
Breastfed babies are healthier than formula fed babies	1	2	3	4	5
*Breastfed babies are more likely to be overfed than formula fed babies	1	2	3	4	5
*Fathers feel left out if a mother breast feeds	1	2	3	4	5
Breast milk is the ideal food for babies	1	2	3	4	5
Breast milk is more easily digested than formula	1	2	3	4	5
*Formula is as healthy for an infant as breast milk	1	2	3	4	5
Breastfeeding is more convenient than formula	1	2	3	4	5
Breast milk is cheaper than formula	1	2	3	4	5
*A mother who occasionally drinks alcohol should not breastfeed her baby	1	2	3	4	5

SSD=Strongly disagree, D=Disagree, N=Neutral, A=Agree, SA=Strongly agree, Items marked with asterisks (*) are favorable to formula feeding and are reverse scored (i.e., 1=5, 2=4, 4=2, and 5=1); Higher scores indicate more positive attitudes toward breastfeeding. A strongly breastfeeding attitude has a score of 5 for each question

English version of IIFAS

P-0464

Knowledge, attitude and behavior of the breastfeeding mothers about smoking

Burcu Aslan, Seval Yaprak, Cigdem Alkan, Rana Gundogan, Nilgun Ozcakar
Department of Family Medicine, Dokuz Eylul University, Izmir, Turkey

Background & AIM:

Using tobacco during the period of breastfeeding adversely affects the health of mother and child. American Academy of Pediatrics Committee on Drugs has stated that nicotine is contraindicated in nursing mothers. Using tobacco leads to decrease in mothers' milk production and children's weight gain. In present study, we aimed to determine the knowledge and attitude of mothers having babies between 6-24 months old about smoking, and their smoking behavior during breastfeeding.

Method

In our descriptive cross-sectional study, mothers admitted to Dokuz Eylul University Medical Faculty, Children's Polyclinic, were fulfilled a questionnaire developed by the researcher including questions about sociodemographic characteristics, knowledge, attitude and behaviors about smoking.

Results

Total 236 mothers with mean age of 29.73 ± 5.40 (Min=18, Max=46) were included in the study. Mothers had high educational level (41.1%). Most pregnancies were planned and desired (72.0%). Mean age of babies was 11.64 ± 5.12 months and 133 (56.4%) of them were female. Among mothers, 26 (11.0%) have never breastfeed, 105 (44.5%) were still doing and the other 105 (44.5%) were not currently doing. Smoking rates in pregnancy and lactation were 18.2% and 18.1, respectively. Smoking rate at the time of this study was 25.4%. Non-smoker fathers were 25.8%. Parents indicated that they are smoking near baby (3.8%). Among mothers, 99.6%, 97.0% and 69.1% were indicated that smoking near baby and during pregnancy is harmful and will cause gas pains, respectively. Most of mothers, who indicated smoking during the breastfeeding period is harmful, were not smoking in breastfeeding period ($p < 0.05$).

Conclusions

It was seen that most of mothers have knowledge about hazards of cigarette and pay attention to this during pregnancy and breastfeeding. However, percentage of mothers who smoke in this period is not low. Our study shows smoking behavior in pregnancy and breastfeeding period and in this context, we believe it will guide for further studies on this subject.

Keywords: Breastfeeding, smoking, behavior

Sociodemographic characteristics of mothers'

Maternal Characteristics		n	%
Age (year)	25 and less	47	19.9
	26-30	102	43.2
	21-35	45	19.1
	36 and over	42	17.8
Education level	Illiterate	10	4.2
	Primary school	34	14.4
	Secondary school	33	14.0
	High school	62	26.3
	University	97	41.1
Family type	Nuclear	201	85.2
	Extended	35	14.8
	Working	114	48.3
Working status	Does not work	122	51.7
Level of income	1000 and less	42	17.8
	1001-2500	92	39.0
	2501-5000	65	27.5
	5000 and over	37	15.7
Child number	1	110	46.6
	2	75	31.8
	Over than 3	51	21.6

Demographic characteristics of babies

Infant Characteristics		n	%
Gender	Female	133	56.4
	Male	103	43.6
Type of delivery	Vaginal birth	72	30.5
	Caesarean section	164	69.5
Gestational week	Less than 37	159	67.4
	37 and over	77	32.6
Birth weight	Less than 2500	16	6.8
	2500-4000	207	88.1
	4000 and over	12	5.1
Breastfeeding status	Non-breastfed	26	11
	Continue to breastfeed	105	44.5
	Breastfed	105	44.5

Relationship between respiratory tract infection and smoking status during pregnancy

Group of smoking before	Respiratory tract infection p<0,018			
	Never had		Had	
During Pregnancy	n	%	n	%
Smoking	26	61.9	16	38.1
Non-smoking	34	85.0	6	15.0

Relationship between respiratory tract infection and smoking status during breastfeeding

During Breastfeeding	Respiratory tract infection p<0,337			
	Never had		Had	
	n	%	n	%
Smoking	23	60.5	15	39.5
Non-smoking	118	68.6	54	31.4

P-0465

U-SHAPE – Ugandan Sexual Health and Pastoral Education

Emily Clark

Royal College of General Practitioners, UK

Background and Aim

Since 2013, we have been developing training in family planning for healthworkers, and in sex education for teachers, in Uganda. The project U-SHAPE (Ugandan Sexual Health and Pastoral Education) aims to disseminate positive messages about modern contraception in an attempt to dispel fears and misconceptions and address the high rate of unmet need for family planning.

Method: Our own published qualitative research and a local confidential enquiry of deaths, show that lack of access to and confidence in modern contraception is an important driver of the high rates of maternal and infant mortality. We have been awarded a THET partnership grant between RCGP and Bwindi Community Hospital, and are featured as a 'Success Story' on the WHO Family Planning training website.

Results: To date, we have trained more than a hundred health workers to a basic level, and 39 to a level equivalent to DFSRH. Our 'whole institution' approach to training has led to service developments including the screening for unmet need for contraception, with the target to reduce this from 40% to 20%. In addition, 50 primary school teachers meet quarterly for training to help reduce teenage pregnancies. We have looked carefully at the barriers to access, myths and cultural/ religious influences on family planning, and have used this to shape our training programs.

Conclusions: Our cascade model of training, involves training Ugandan USHAPE trainers with the aim of future scale up and long-term development. We have begun to role out the U-Shape training to similar hospitals across Uganda, such as Kisiizi Hospital.

Keywords: Family planning, health education, unmet need

Current methods to reduce teenage pregnancy at Kisiizi



Family planning and the Millennium development goals



Level 2 candidates



Level 2 practical skills training



U-SHAPE



**Uganda Sexual Health
& Pastoral Education**



Royal College of
General Practitioners

P-0466

Influenza vaccination uptake among Pregnant women during Flu season in a Rural Practice. Audit

Kandan Loganathan, Paddy Halligan, Gavin Maguire
Cottage Surgery, Bailieborough, Co.Cavan, Ireland

Influenza is responsible for significant morbidity and mortality in pregnant women. According to Health Service Executive(HSE) guidelines, all pregnant women should get influenza vaccine. We generated a list of all pregnant women during the 2013/2014 influenza season using Helix Practice Manager. We studied the consultation record, immunization record and maternity protocol for each patient, looking for documentation of discussion regarding influenza vaccination. Following the review, we had a practice discussion regarding changes that could be implemented to improve vaccination uptake. This included placing patient posters in the waiting room and at reception area, having the HSE vaccination leaflet displayed and placing reminder posters in all staff rooms. The practice nurses then initiated a system of messaging all eligible pregnant women to alert them that the influenza vaccine was available in the practice. The vaccination period started from October to end of April. All the data were recorded in an Excel spread sheet. There were 44 pregnant women eligible in the 2013/2014 group and 40 pregnant women in the 2014/2015 group. There was an almost equal mix between GMS and private patients. In 2013/2014, only 8 out of 44 pregnant women had influenza vaccine. Since the intervention was put in place, the uptake of influenza vaccine increased by 32 % in the 2014/2015. With regards to documentation rate, there was a 100% documentation rate in the 2014/2015 as compared to 9% in the 2013/2014 season which was a very significant improvement. There was a 32 % increase in influenza vaccination uptake since the introduction of posters, reminders and online messaging system. This uptake is inline with the international standards. There were also better documentation record between doctor and patient. The audit showed that even relatively simple, low cost interventions can produce an increase in vaccination uptake among this patient cohort.

Keywords: vaccination, influenza, maternity

Sample Flyer for Pregnant women-Appendix 1



Sample Flyers that was in the waiting room and given to patient during consultation

Total number of Private and GMS Patients

	2013/2014	2014/2015
Private Patients	20(45%)	21(53%)
GMS(medical Card) Patients	24(55%)	19(47%)
Total Patients	44	40

The table gives the breakdown of private and GMS patients for pre and post intervention period.

Poster- Appendix 2

<p style="text-align: center;">Attention</p> <p>ALL PREGNANT WOMEN SHOULD EHAVE FLU VACCINE PLEASE BOOK IN AT RECEPTION FOR YOUR VACCINE IF YOU HAVE ANY QUESTIONS, PLEASE ASK YOUR GP DURING YOUR ANTENATAL CHECK</p> <p style="text-align: center;">THANK YOU COTTAGE SURGERY</p>
--

Sample Poster that was in the waiting area, doctor's and nurse's rooms

Peason for not participating

	2013/2014	2014/2015
--	-----------	-----------

Followed up else where	1	0
------------------------	---	---

Early Miscarriage	4	10
-------------------	---	----

List of reason patients were excluded from the audit

Total number of pregnant women that received the vaccine

	2013/2014	2014/2015
--	-----------	-----------

Yes	8(18%)	20(50%)
-----	--------	---------

No	36(82%)	20(50%)
----	---------	---------

The Table shows difference in vaccination uptake since the intervention was introduced

Total Number of Documentation

	2013/2014	2014/2015
--	-----------	-----------

Yes	4(9%)	40(100%)
-----	-------	----------

No	40(91%)	0
----	---------	---

This table shows the documentation rate of discussion between the clinician and patients, pre and post intervention

P-0467

Effects of Different Anesthesia Protocols on Lactation in the Postpartum Period

Leyla Kutlucan¹, Ilknur Suidiye Seker², Yavuz Demiraran², Ozlem Ersoy², Ibrahim Karagoz², Gulbin Sezen², Seyit Ali Kose³

¹Konya Training and Research Hospital, Department of Anesthesiology, Konya, Turkey

²Department of Anesthesiology, Düzce University Faculty of Medicine, Düzce, Turkey

³Department of Obstetrics and Gynecology, Düzce University Faculty of Medicine, Düzce, Turkey

Background & AIM: Breast milk has many features reinforcing newborn development, and as a nutrient, it is superior to all artificial nutrients. Breastfeeding is given great value in the healthy development of a newborn. In our study, we aimed to compare the lactation process by mothers who underwent elective cesarean section under general anesthesia, spinal anesthesia, epidural anesthesia, and normal vaginal birth.

METHOD: We compared the lactation process by mothers who underwent elective cesarean section under general anesthesia, spinal anesthesia, epidural anesthesia, and normal birth; 84 patients between 18-40 years of age with a risk of ASA I-II were included. Randomly patients were divided into four groups: group G (general anesthesia, n:21), group S (spinal anesthesia, n:21), group E (epidural an-esthesia, n:21), and group V (vaginal birth, without anesthesia, n:21). Oxytocin and prolactin values of all patients before and after operation or birth were recorded. In addition the initiation time of lactation after delivery or cesarean section were recorded.

RESULTS: In all groups, there were no significant differences among hormone levels in the prepartum period ($p=0.350$). Prolactin levels in group G ($p=0.011$) and oxytocin levels in group V ($p=0.012$) in the postpartum period were significantly higher than in the other groups. The start of lactation was significantly delayed in group G ($p=0.003$).

CONCLUSION: We consider that the onset time of lactation is delayed in patients undergoing cesarean section with general anesthesia when compared with patients who undergo cesarean section with spinal and epidural anesthesia and with patients who undergo normal vaginal birth. Because of the delay of awakening and recovery of cognitive functions in general anesthesia, communication between the mother and the newborn is delayed and so is the lactation.

Keywords: Breast milk, lactation, anesthesia

P-0468

Parents' Knowledge, Attitudes and Beliefs of Childhood Fever Management

Cenk Aypak¹, Esra Durmuş¹, Adnan Yüce², Hülya Yıkılkan¹, Derya İren Akbıyık¹, Süleyman Görpelioğlu¹

¹Department of Family Medicine, Dışkapı Yıldırım Beyazıt Training and Research Hospital

²Department of Pediatrics, Dışkapı Yıldırım Beyazıt Training and Research Hospital

Background & AIM: Fever is the most common cause for a child to be taken to the doctor. Studies report that parents have false beliefs and limited knowledge regarding fever, its management, and its role in illness. The aims of this study were to investigate parents' attitudes towards fever in their children and the common fears related to it

METHOD: We interviewed 206 parents, whose children attended the pediatric outpatient clinics of Dışkapı Yıldırım Beyazıt Training and Research Hospital, using an structured questionnaire, in April and May 2015.

RESULTS: Parents of lower educational level are more likely to take their febrile children to the hospital as soon as fever is detected and also tend to administer antipyretics at a lower temperature and take more often inappropriate measures apart from antipyretics (eg sponge the child with vinegar). Approximately half the parents believed that combining two medications is more beneficial. The most frequent harmful effect of fever reported by parents is brain damage, followed by seizures. About half of parents based decides on medication or dose on prior advice from the clinician, which might not be safe given the fever causes and fluctuations in weight over time.

CONCLUSIONS: Our results indicate that parents often misuse the antipyretics medications, incorrectly manage their child's fever, follow inappropriate practices to reduce fever, and generally have poor knowledge of basic information regarding fever. Findings from this study underscore the need to develop and evaluate programs that

educate parents and provide them with the knowledge base required to better manage their children's fevers.
 Keywords: Children, Fever management, Belief, Temperature

P-0469

Comparison of Diagnostic Strategies in Gestational Diabetes Mellitus

Serhat Purcu¹, Meral Mert², Sami Hatipoglu³, Murat Ekin⁴, Yildiz Okuturlar⁵

¹Department of Family Medicine, Bakirkoy Dr. Sadi Konuk Research and Training Hospital, Istanbul, Turkey

²Department of Endocrinology and Metabolism, Bakirkoy Dr. Sadi Konuk Research and Training Hospital, Istanbul, Turkey

³Department of Pediatrics, Bakirkoy Dr. Sadi Konuk Research and Training Hospital, Istanbul, Turkey

⁴Department of Obstetrics and Gynecology, Bakirkoy Dr. Sadi Konuk Research and Training Hospital, Istanbul, Turkey

⁵Department of Internal Medicine, Bakirkoy Dr. Sadi Konuk Research and Training Hospital, Istanbul, Turkey

BACKGROUND: Gestational Diabetes Mellitus (GDM) incidence is between %1-14 in different societies. GDM carries risks for the mother and neonate. In diagnosis, one of two different strategies is being applied to the women at 24–28 weeks of gestation. Of these two strategies, the first one is the two step 50 gram Screening Test in which following it, 100 gram glucose tolerance test (GTT) is applied to the women whose blood glucose is 140mg/dl or over; the other one is the strategy in which 75 gram GTT is applied without first applying scanning test first. We aim to compare these two strategy.

METHOD: The scanning results of the all pregnant women with an alive pregnancy during 24-28 weeks were evaluated retrospectively, having applied for routine pregnancy tracking between January 2012 and January 2013, whose Gestational Diabetic screening have been done. 936 pregnant women screened. Two step test strategy was applied to 576 of them and one step was applied to the rest 337.

RESULTS: In the two step strategy, of all the 576 pregnant women, %63.4 were negative and %36.6 were positive. The ones with a positive result were called for 100 gram GTT application. In the outcome of 50 gram, 211 women were positive but 50 of these didn't show up. In the outcome of 100 gram fasting, 116 people (%72) were negative and 45 people (%28) were positive. The rate of people with a diagnosis of GDM via two step method was detected as %17.2; the rate was %54 via one step strategy, 75 gram GTT.

CONCLUSIONS: We detected that 75 gram GTT one step strategy diagnosed GDM in a much greater rate. It can be mentioned that one step test strategy is much more sensitive to the two step strategy but increases the costs of treatment.

Keywords: gestational diabetes mellitus, screening, strategy

Figure 1: Total pregnant Women, Test Methods and Results.

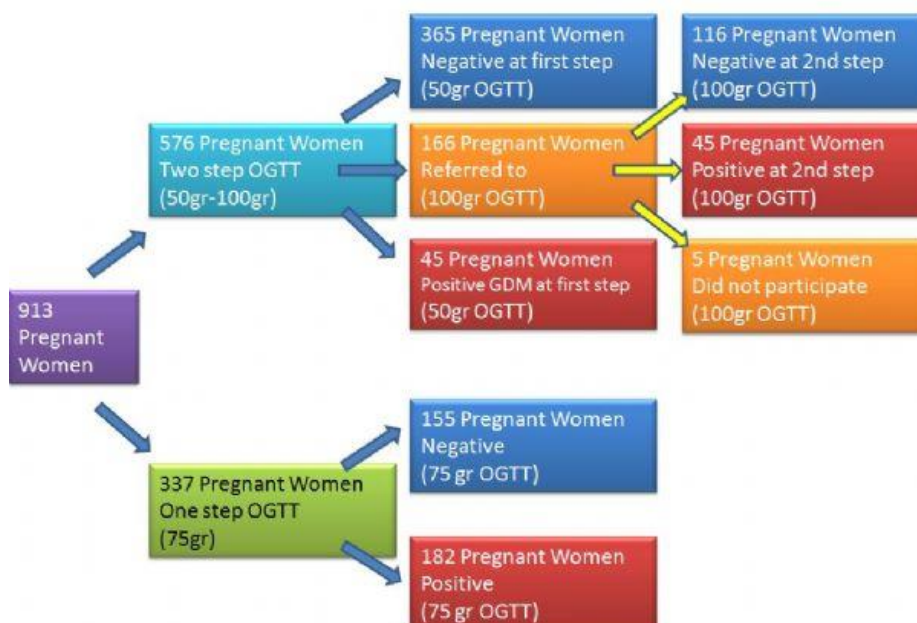


Table 1: Comparison of positivity rates

	Two Step Test (50gr-100gr OGTT)	One Step Test (75 gr OGTT)
Total Pregnant Women	576	337
GDM Positive-(%)	100 (%17.4)	182 (%54)

Figure 2: The ratios of 75gr OGTT one step test results.

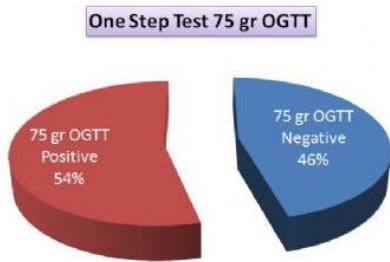
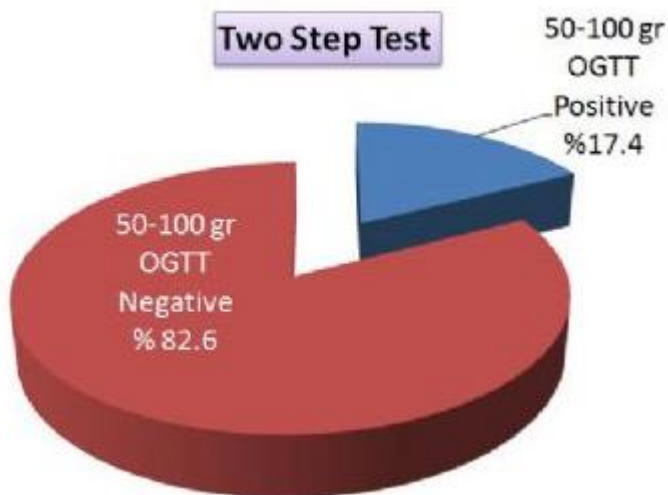


Figure 3: The ratios of 50gr-100gr OGTT two step test results.



P-0470**Evaluating The Service Provided To Pregnant Women At Family Health Centers During Pregnancy**

Celal Kuş¹, Hamit Sırrı Keten², Nagihan Sarı², Hüseyin Üçer², Önder Ercan³

¹Department of Family Medicine, Medical Faculty, Kahramanmaraş Sutcu Imam University, Kahramanmaraş, Turkey

²Department of Family Medicine, Kurtul Family Health Center, Kahramanmaraş, Turkey

³Department of Gynecology and Obstetrics, Medical Faculty, Kahramanmaraş Sutcu Imam University, Kahramanmaraş, Turkey

BACKGROUND: The present study aims to evaluate the service provided to pregnant women at family health centers during pregnancy.

METHOD: The present study included pregnant women presenting at Kahramanmaraş Sutcu Imam University Medical Faculty Hospital Gynecology Polyclinics between 09.04.2015 and 19.05.2015. Pregnant women were informed prior to the study and 150 pregnant women giving consent were included in the study.

RESULTS: The mean age of the pregnant women included in the study was 28.50 ± 6.19 (min=18, max=42) years. The mean gestational week was 32.47 ± 8.88 (min=4, max=41) weeks. The educational status was secondary school and below in 94 (62.7%) participants, and high school and above in 56 (37.3%) participants. 58 (38.7%) women stated that they had pregnancy diagnosis at a family health center. 126 (84.0%) women stated that they knew the family physician and 116 (77.3%) women stated that they knew the family health personnel (nurse or delivery nurse). 26 (17.3%) participants stated that they had consultancy service before pregnancy compared to 124 (82.7%) participants stating that they did not. 109 (72.7%) pregnant women stated that they regularly went to the family physician during pregnancy, whereas 41 (27.3%) pregnant women stated that they did not. There were 95 (63.3%) participants agreeing and 23 (15.3%) participants disagreeing with the proposition of 'I think the family physician has sufficient knowledge about diagnosis and treatment', and 32 (21.3%) participants with no idea. Additionally, 115 (76.7%) participants stated that they had trust in family physician regarding pregnancy follow-up compared to 35 (23.3%) participants stating no trust.

CONCLUSION: The present study found that a small portion of pregnant women received consultancy service before pregnancy. It was also found that pregnancy women did not benefit from family health centers sufficiently during their pregnancy.

Keywords: Family Health Centers, pregnancy, women

P-0471**The comparison of the vitamin d levels between the pregnant women with gestational diabetes mellitus and the pregnant women with normal glucose tolerance test results**

Selma Pekgör¹, Mustafa Başaran², Fatma Gökşin Cihan³, Orkide Kutlu⁴

¹Konya Training and Research Hospital, Family Medicine, Konya, Turkey

²Konya Training and Research Hospital, Gynecology and obstetrics, Turkey

³Necmettin Erbakan University, Meram Medical Faculty, Family Medicine, Konya, Turkey

⁴Konya Training and Research Hospital, Internal Medicine, Konya, Turkey

AIM: Gestational diabetes mellitus (GDM) is defined as β cell dysfunction and insulin resistance developed during pregnancy or first time diagnosed in pregnancy. There are conflicting results in the literature about the role of vitamin D in the development of the gestational diabetes mellitus and insulin resistance. This study aims to determine the vitamin D status of pregnant women with GDM and evaluate the relationship between 25(OH)D3 and GDM.

MATERIALS-METHODS: The pregnant women screened for GDM between 24.-28. gestational weeks at Konya Education and Research Hospital Gynecology and Obstetrics Clinics were included in that prospective cross-sectional study. The age, weight, and height, BMI, the history of disease and surgery, vitamin D level, multivitamin, and a history of drug use, use of scarf, exercise status, and family history of diabetes were recorded. As study parameters, 50 g glucose screening and 100 g OGTT were performed to the pregnant women between 24.-28. gestational weeks. Serum 25(OH)D3 levels of ≤ 10 ng/ml, 10-29 ng/ml and ≥ 30 ng/ml are

considered, vitamin D insufficiency and adequate vitamin D, respectively.

FINDINGS: Vitamin D deficiency and vitamin D insufficiency rates were found as 70% and 30% respectively. The 25(OH)D3 levels of pregnant women with GDM and NGT were similar (9.40 ± 3.53 ng/ml versus 8.00 ± 3.11 ng/ml). In terms of vitamin D deficiency, there was no statistically significant difference between the GDM and control group.

CONCLUSION: Recautions for the prevention of vitamin D deficiency in pregnant women should be increased and vitamin D supplements should be used in an effective way. Rates of vitamin D deficiency in women with GDM were similar to control group. We believe that, to demonstrate the role of vitamin D deficiency in the development of GDM; more extensive, prospective, and randomized controlled trials are needed.

Keywords: Gestational diabetes mellitus, vitamin D level, pregnancy, vitamin D supplementation

P-0472

Frequency and concerning factors on term infants with anemia whom registered on our family health center

Neslihan Erkuran¹, Sebahat Gucuk², Selami Kara³

¹Golyuzu 1st care center, Bolu,Turkey

²Department of Family Medicine, Abant Izzet Baysal University, Bolu, Turkey

³Bahcelievler 1st care center, Bolu,Turkey

BACKGROUND & AIM: In our study, Determination of the factors affecting anemia status of the infants followed by our family health center were intended.

METHOD: Reports of the infant subjects whom registered to our office between dates of January-May 2015 were investigated retrospectively Subjects with neonatally intervened medical history, empirical tracking file and information since the pregnancy of related mother were excluded from the research. 162 infants were selected according to our sampling criteria. Information about duration and last control on 9th month of pregnancy was recorded. The HB level of the mother were derived from the last HB level determined on the control attained in the last trimester of the pregnancy. Infants with Hb levels < 11.0 g/dl were accepted as anemic.

RESULT: The ages of 83 male (%51,2), 79 female (%48,8) of total 162 infant were differed between 9-24 month according to their birth certificates. %62,3 (n:101) of the infants were fed with only human breast milk till the transition period through supplementary food. The level of Hb on the sampling group whom fed with only human breast milk was significantly higher (p:0.013). the Hb value of the %37,7 (n:61) of the infants were detected under11 gr/dl. The Hb value tested on last examination were found to be statistically significant between mother and infant (p:0.01). Ratio of Hb value over 11 gr/dl was significantly high in infants taking iron supplement almost each day.

CONCLUSIONS: In our study, we have determined that Hb values of the mother measured during the pregnancy controls affect Hb values of the infant and that Hb values of the infant get better upon the regular intake of breast milk and iron supplement recommended by the ministry of health and this is important as it indicates the significance of regular pregnant-infant controls and iron prophylaxis.

Keywords: Anemia,infant day control, pregnant control

Table 1: The relationship between EB levels with some parameters

		Hemoglobin				total		p
		Hb<11gr/dl		Hb>11gr/dl		n	%	
Birth order	1st child	14	43	45	77	70	100	0.01
	2nd child	13	21.7	47	78.3	40	100	
	3rd child	6	46.2	7	53.8	13	100	
	4th child	8	30	5	20	10	100	
Applied diet until additional food supplied	Only breast milk	47	44.6	56	73.4	101	100	0.013
	Breast milk and formula together	3	15.2	27	84.4	32	100	
	Formula weight and breast milk	11	37.2	18	62.8	26	100	
Chest milk received status until the 9th month	No	41	31	108	69	145	100	0.00
	Every day	3	33.3	1	16.7	4	100	
	Irregular	11	100	0	0	11	100	
Duration of iron supplement intake after the 9th month	No	18	69.2	8	30.8	26	100	0.01
	Every day	27	28.4	43	71.6	80	100	
	Irregular	18	37.9	8	30.8	26	100	

P-0473

Mothers' Information and Applications About High Fever

Yasemin Korkut, Muhammed Sefa Acar

Department of Family Medicine, Dumlupınar University, Kütahya, Turkey

AIM: This study has been conducted in order to determine the idea, knowledge and application of mothers having children about high fever.

METHOD: The study was carried out with 112 mothers who had a child and who were admitted to the family medicine policlinic of Dumlupınar University Hospital, in a two month period. Data was collected using a questionnaire form that included multiple choiced questions; (the results were) evaluated using the number, percentage and chi-square tests.

RESULTS:

28 of the mothers (25% of the participants) expressed that they did not know the limits of high fever. 65 of them (72,8%) regarded 38C and more body temperature as high fever.

14 mothers (15,6%) said that it was not necessary to lower the rising fever. 74 mothers said that high fever harmful for their children. 83 mothers were afraid of and anxious about their children when they had high fever. When the level of education increases, the fear of fever decreases.

As a first aid, 35 mothers (39,2%) took off children's clothes and made them have a shower with warm water. 7 mothers used antipyretics without consulting doctor.

Although 73 participants (81,8%) had a thermometer, 53 mothers checked fever by touching and 13 mothers (14%) checked by looking at overall situation of their children, only 33 mothers was using a thermometer. 25 mothers mentioned that they didn't know how to use thermometers. 17% of the mothers knowing how to use mentioned the amount of the time less than they had to keep the thermometer. 29% of the mothers mentioned more time than required time. While checking temperature, 81,2% preferred armpit. It was observed that 89,1% had antipyretics at their home and 56% preferred paracetamols.

CONCLUSIONS:

As a result of statistical analysis, a meaningful relation has been found out between the age and education levels of mothers consider high fever as dangerous.

However, their information and applications about high fever are inadequate and wrong.

Keywords: Fever, Child with high fever, Mothers' information and applications.

P-0474

Pregnants' Nutritional Knowledge Levels and Folic Acid Use Attitude in Ondokuz Mayıs University Department of Gynecology and Obstetrics

Aysenur Alper Gurz¹, Fusun Artiran Igde¹, Emel Kurtoglu², Mustafa Fevzi Dikici¹, Fusun Yaris¹

¹Department of Family Medicine, Ondokuz Mayıs University, Samsun, Turkey

²Department of Gynecology and Obstetrics, Ondokuz Mayıs University, Samsun, Turkey

AIM: Pregnancy is one of the most important period in life increasing micronutrients, and macronutrients needs of the body; both for the health and well-being of the mother, growing fetus and the newborn. Folic acid supply in the preconceptional period and the first trimester can reduce the incidence of neural tube defects (NTDs). It has been shown that prenatal multivitamin supplementation is associated with a decrease in several congenital anomalies and a decreased risk for pediatric brain tumors. This study aimed to evaluate the relationship between nutritional knowledge and the use of folic acid during pregnancy.

METHODS: A questionnaire was administered to 102 pregnant women attending to Ondokuz Mayıs University Department of Obstetrics and Gynecology between February and May 2014. The inquiry form included the demographic properties such as the women's age, number of parity, educational degree and socioeconomic status. We also asked whether their pregnancy was planned or not, where do they get information about the use of folic acid.

RESULTS: The mean age was 29,7±5,5. 41.4% of pregnant women were primigravida and 58.6% of them were multiparous

women. According to the statement of pregnant women 19.6% of them were intermediate, 56.9% bad and 23.5% were good socioeconomic status. Seventy-six women (74.5%) planned their pregnancy. 41.3% of the women had started folic acid in the preconceptional period and continued it during their first trimester. 84,3% of pregnancies using folic acid was most initiated by doctors.

CONCLUSIONS: It is regarded that the frequency use of folic acid is positively correlated with socioeconomic status and education of the pregnant women. Because of the low socioeconomic status and lack of education generally, women who are in the fertile period should be informed about the role of nutrition and especially folic acid use for preventing NTD's.

Keywords: folic acid, knowledge, pregnant women

P-0475

A Retrospective Analysis of Demographic Characteristics for Adolescent Pregnancies

Hande Ileri¹, Alper Ileri², Mehmet Özeren³, Kurtuluş Öngel⁴

¹Clinic of Family Medicine, Tepecik Training and Research Hospital, Izmir, Turkey

²Clinic of Gynecology and Obstetrics, Buca Gynecology and Obstetrics and Pediatric Hospital, Izmir, Turkey

³Clinic of Obstetric and Gynecology, Tepecik Training and Research Hospital, Izmir, Turkey

⁴Department of Family Medicine, Izmir Katip Çelebi University, Izmir, Turkey

BACKGROUND & AIM: Adolescent pregnancy is one of the major health problems worldwide. Adolescent pregnancies are high-risk pregnancies in terms of maternal and fetal. In the study; it was aimed to assess maternal demographic characteristics in adolescent pregnancy.

METHODS: Pregnancy and birth records of both under 18 year old and over 18 year old pregnant, who gave single and alive birth over 20 months at the same period and were referred to Izmir Tepecik Training and Research Hospital between 01.06.2009-01.06.2014, were retrospectively examined. Demographic characteristics of groups; age, gravida, parity, having a civil marriage with the partner, kinship with the partner, antenatal care, use of substances are compared. For the statistical significance of results, p value was <0.05.

RESULTS: There were 282 participants in the adolescent group, 340 participants in the non-adolescent group. The average rate of age was 16.4 for adolescent group, 26.1 for non-adolescent group(p<0.05). When the counts of gravidity and parity average rates; in adolescent group, the gravidity average rate was 1.2 and parity was 0.1; in non-adolescent group, the gravidity average rate was 2.3 and parity was 0.9(p<0.05). There was civil marriage between partners for 9.6% of women in adolescent group and % 99.1 of women in non-adolescent group(p<0.05). 7.8% of women in adolescent group and 4% of women in non-adolescent group are relatives with their partners(p<0.05). 29.8% of the adolescent and %85.6 of the non-adolescent cases had antenatal care(p<0.05). In the adolescent group; rate of substance use was 2.5%, while in the control group it was %3.4(p>0.05).

CONCLUSIONS: Pregnant adolescents have higher risk for negative maternal and fetal outcomes. Furthermore study results reported that inadequate use of antenatal care services is more common in adolescent pregnant. Health care providers have to be alert about prevention, ensuring antenatal care in case of detecting adolescent pregnancies.

Keywords: Adolescent, pregnancy, antenatal care

P-0476

Birth Defects in A Safety Net Hospital 2005-2013: Incidence, Determinants and Plausible Environmental Factors

Josephine Rebecca Fowler

Office of Academic Affairs & Department of Family Medicine, JPS Health Network, Fort Worth, TX USA

Birth Defects in a Safety Net Hospital 2005-2013: Incidence, Types, Determinants and Plausible Environmental Factors

Introduction

Birth defects are the number one cause of infant deaths annually. Approximately 1 in 33 infants are diagnosed with a birth defect in the United States. Birth defects occur in 4 percent of births in high income countries and 8 percent of low income countries. Financial costs as a result of the birth defect are estimated to be \$2.6 billion annually. Approximately 50% of the causes of birth defects are unknown. Chromosomal abnormalities are found in more than half of embryos miscarried in the first trimester. A pregnancy with a genetic problem has a 95% probability of ending in miscarriage. Environmental factors commonly named as teratogens may impact birth defects spontaneously or require genetic and environmental interactions. This study looks at potential correlations based on maternal history.

Methods

Retrospective exposure cohort, Observational study. A cohort of births from 2005 through 2013 were selected for evaluation of correlates to birth defects based on information in maternal records. Variables collected included zip codes of residence. Secondary geographic mapping and data was used to assess plausible risk associated with environmental factors.

Results

Incidence data is presented and compared to state and national incidence of birth defects. The county incidence is twice that of the state and nation. Cardiac anomalies accounted for the highest incidence of the congenital anomalies in this cohort.

Conclusions

There are variations in incidence of birth defects in geographic regions. Causation is multifactorial making it difficult to link causation to any specific agent. Reviewing both known and plausible risk factors and secondary data proves to be a potential method to further understand preventable risk.

Keywords: Birth Defects, Incidence, Environment

P-0477

Why They Give Up Breastfeeding So Early? A qualitative study from Turkey

Naciye Irmak, Burcu Başaran, Esmâ Özçelik, Arzu Uzuner

Marmara university family medicine department, Istanbul, Turkey

BACKGROUND:

According to the World Health Organization mothers are advised to breastfeed their babies for a total of six months without giving any other food even water which means "Exclusive Breastfeeding" (EB). Despite the "Baby Friendly Initiative" of Turkish Ministry of Health, mothers give up breastfeeding before six months.

AIM: The purpose of this study was to determine the reasons for giving up breastfeeding and early weaning.

Materials METHODS:

This is a qualitative study. Recently delivered mothers who participated in an on going randomized controlled intervention study on breastfeeding and who gave up breastfeeding were invited by phone call for a semi-structured interview in the Family Medicine Department of Marmara University Medical School. Mothers have been asked in dept about the reasons for early weaning. All the interviews were recorded and tape transcripts were analyzed thematically by four researchers.

RESULTS: A total of 57 women were called by phone; 27 mothers who accepted the interview were recruited in the study. The mean age of group 29.3 ± 5.6 years, 88.9% of mothers were housewife, two mothers were illiterate, 10 mothers were elementary school graduated, 9 mothers were high school or university graduated. Main question was about "one's reasons for early weaning". Three themes were found out: 1-The reasons for giving up

breastfeeding; 2-Mothers perceptions; 3- External effects. The main codes for early weaning were: medication use of mother and the baby; hospitalization; stress; baby's health problems; mother's prior breast feeding experiences; baby bottle use and the baby's deny for breast milk. Mothers' perceptions were mostly about the baby satiety. The external effects were that of the health personel and of the family.
CONCLUSION: The time spent in the hospital following delivery and the mothers' perceptions about the satiety of the baby and baby's health problems are the most prominent reasons for early weaning.

Keywords: give up breastfeeding, barriers to breastfeeding, mother's perceptions during breastfeeding

Table 1. Demographic profiles of mothers

Table 2. Demographic profiles of mothers		
Age	Number	Percent(%)
20-25	9	33,3
26-31	9	33,4
32-37	9	33,3
Total	27	100,0
Maternal education(years)	Number	Percent(%)
0-8	18	69,2
9-12	4	15,4
>12	4	15,4
Total	26	100,0
Maternal work	Number	Percent(%)
Housewife	24	88,9
Working mother	3	11,1
Total	27	100,0

Table 2. Themes

Theme 1: Mothers perceptions	
Code 1	Negative perception about baby's satiety and/or being hungry. "...my baby is always crying, so that I think she is hungry..."
Code 2	Negative perception about baby's grow up "...I always think my baby is smaller than the other babies..."
Code 3	Neonatal jaundice occurrence due to the insufficiency of breast milk "... because of my baby didn't suck enough he became neonatal jaundice; so I started baby food..."
Code 4	Belief about insufficiency of her breast milk depending on the past experiences "...this is my fourth delivery, my breastfeeding was enough only for 10 days to my babies..."
Theme 2: External factors that influence breastfeeding	
Code 1	Family's effect (husband, mother-in-law) "...I had problems with my husband, we had divorced so my breast milk went dry..." "...my mother in law persisted me to breastfeeding my baby, so I got angry with her and gave up breastfeeding..."
Code 2	Health worker's (doctor, nurse) decision "...the doctor said this baby was hungry, so that I started baby formula..."
Code 3	Using baby bottle "...my breast milk was absent at night, I was giving formula using baby bottle then she get on with this and she didn't want breastfeeding..."
Theme 3: Health status	
Code 1	Hospitalization of the mother and the baby "...my baby stayed at incubator, so I couldn't breastfeed her..."
Code 2	Medication of the mother and the baby "...because of my rheumatism I had to use drug so I couldn't breastfeed..."
Code 3	Mother's health
3a	Cesarean section "...I had cesarean section so that my breast milk was insufficient..."
Code 4	Baby's health
4a	Infantile colic "...because of infantile colic my baby became restless, when I gave formula he slept well..."
4b	Restlessness of the baby "...my baby always had restlessness, he cried all the time so I gave formula then he calmed down..."

P-0478

Using OCS and Unobserved 37 Weeks of Pregnancy: A Case Report

Merve Taştan¹, Gökçe Nur Gök¹, Derya Önal¹, Gamze Ersen¹, İrfan Şencan¹, İsmail Kasım¹, Rabia Kahveci¹, Cemal Reşat Atalay², Adem Özkara³

¹Ankara Numune Training and Research Hospital Department of Family Medicine

²Ankara Numune Training and Research Hospital Department Gynecology and Obstetric

³Hitit University Department of Family Medicine

INTRODUCTION:

Today one of the contraceptive methods is using OCS(oral contraceptive). OCS is used by world 8,9% and in Turkey 4,6% (1,2). Unwanted pregnancies could be prevented 99.7% with OCS. The protection is reduced to 92% with irregular use(3). However, despite the regular use of OCS pregnancy can happen so we present the case to draw attention to this topic.

CASE:

Thirty-five-year-old female patient was admitted to the clinic with complaints of abdominal distention. In her medical history the patient has 15 days as of this complaint without diarrhea, constipation and abdominal pain. The patient did not have any chronic diseases. In the last 6 months patient has recurrent vaginitis, urinary tract infection and many times received antibiotic treatment. It was learned that in 2.5 years OCS use as a contraceptive method.

At her gynecological examination collum is multiparous and has lovere. We detected intrauterine pregnancy at 37 weeks with USG. Non-stress test was reactive. The patient can't feel fetal movement.

The blood tests results are iron deficiency anemia and vitamin B12 deficiency. Urinalysis RESULTS: WBC: 22 (0-5 at each site). No growth in urine culture. Candida albicans growth in the vagina culture.

The patient uses OCS and prenatal testings weren't closely monitored gave birth with C/S at 39 weeks. Baby has 8-9 APGAR.

CONCLUSION:

In this case we wish to draw attention to woman in reproductive period who use OCS regularly and menstruate regularly become pregnant with % 0,3 risk and like our case may be can't notice pregnancy even has pregnancy experience. In this context, We must inform sexually active patients who use of contraceptive methods right about they can pregnant.

Resources:

1- World Contraceptive Patern, 2013

2- Turkey Demographic and Health Survey, 2013

3- Family Planning Counseling Participant Book, 2009, Ankara: Ministry of Health of Mother and Child Health and Family Planning General Directorate

Keywords: oral contraceptive, pregnancy, abdominal distention

P-0479

Urinary Incontinence Among Pregnant in Zonguldak Region of Turkey

Nejat Demircan¹, Ülkü Özmen², Hamdi Küçük³, Firuzan Köktürk⁴

¹Department of Family Medicine, Bülent Ecevit University, Zonguldak, Turkey

²Department of Obstetrics and Gynecology

³Department of Family Medicine

⁴Department of Biostatistics

AIM: Urinary incontinence (UI) is a worldwide health trouble and common in pregnancy. It could effect the quality of life. The present study was conducted to determine its prevalence, effect on quality of life and its etiologic features among 132 pregnant women.

METHOD: ICIQ-SF and Wagner's quality of life scale were used in collecting data and SPSS in statistical analysis.

RESULTS: 56 out of 132 (42.42%) declared presence of urinary incontinence. There was statistical difference between effect of frequency of urinary leakage and QOL scores ($p=0.022$; < 0.05) and also between the amount of leakage and QOL scores ($p=0.01 < 0.05$).

The frequency, amount of UI can be seen in table 3. In summary, 19 pregnant women (33.93%) admitted to having urinary leakage once a week or less, while 8 women did twice or three times a week (14.28%), 5 women did once a day, 14 women did few times a day and 8 declared always ($p=0.022$; < 0.05). The amount of leakage was generally "small" ($n: 35$; 62.5%) whereas 9 (16.07%) women admitted "moderate" amount. On the other, hand there was no participant admitted "large" amount of leakage ($p=0.01 < 0.05$).

CONCLUSION: It is required to give more attention on understanding the impact of UI on the quality of life in the pregnant and intimate relationship of health care givers on the issue.

Keywords: Urinary incontinence, pregnant, ICIQ-SF, Quality of Life

The effect of frequency vs QOL and amount of leakage vs QOL

	Mean	N	SD	p
Frequency	0.93	14	0.616	
Never			0.575	
Once a week or less	0.74	18		
Twice or three times a week	1.13	8	0.835	0.022
Once a day	2.00	5	1.000	
Few times a day	1.00	4	0.816	
Always	1.71	7	1.254	
Total	1.09	56	0.859	
Amount	0.48	88	0.525	0.001
Nothing	1.03	35	0.822	

Small	1.78	9	0.972
Moderate	0	0	-
Large	0.71	132	0.868
Total			

Multiple Pregnancy, Interval between Pregnancies, Abortions (miscarriage) and Preterm labor vs UI

	UI -	UI +	Total	p
Multiple pregnancy	n (%)	n (%)	n (%)	> 0.05
Absent	74 (97.4)	55 (98.2%)	129 (97.7%)	
Present	2 (2.6%)	1 (1.8%)	3 (2.3%)	
Interval Between pregnancies				
<2 yrs	18 (43.9%)	17 (58.6 %)	35 (50%)	
2-5 yrs	11 (26.8%)	9 (31.0%)	20 (28.6%)	=0.159
>5 yrs	12 (29.3%)	3 (10.3 %)	15 (21.4 %)	
other	25	27	52	
Abortion (miscarriage)				
Absent	75 (98.7%)	55 (98.2 %)	130 (98.5%)	= 0.041
Present	1 (1.3%)	1 (1.8 %)	2 (1.5 %)	
Preterm labor				
Absent	75 (98.7%)	55 (98.2 %)	130 (98.5%)	
Present	1 (1.3 %)	1 (1.8%)	2 (1.5 %)	= 0.137
Total	76 (100 %)	56 (100 %)	132 (100 %)	

QOL scores, Impact of Quality of Life

Impact on QOL	n:132	QOL Score, Mean	QOL Score, Sd
(0) Not at all	55	0	0
(1-28) mild	66	8.17	6.909
(29-56) moderate	5	39.20	5.718
(57-84) severe	6	67.67	6.683
Total	132	8.64	15.908

P-0480

Grandparents as Babysitters; the Depression and Quality of Life among Them

Bektaş Murat Yalçın¹, Hasan Pirdal², Esat Veli Karakoç⁴, Murat Tekin³, Erkan Melih Şahin³, Onur Öztürk⁵

¹ONDOKUZ MAYIS UNIVERSITY MEDICAL FACULTY DEPARTMENT OF FAMILY MEDICINE

²GOYNICEK STATE HOSPITAL AMASYA

³ÇANAKKALE 18 MART UNIVERSITY MEDICAL FACULTY DEPARTMENT OF FAMILY MEDICINE

⁴MEDICAL PARK DEPARTMENT OF FAMILY MEDICINE, IZMIR

⁵ATAKUM PUBLIC HEALTH CENTER, SAMSUN

Background and AIM: As the frequency of working mothers are increasing several families demand help of their grandparents as a babysitter. The families give this decision because of financial, social or safety problems which they are facing. The aim of this study is to investigate depression and quality of life among grandparent who are looking after their grandchildren.

MATERIAL-METHOD: The study is conducted by 64 volunteered family physicians in four different cities of Turkey (Izmir, Samsun, Amasya, Çanakkale). These physicians asked their enlisted population over the age of 65 to answer Beck Depression Inventory, EQ5 and General Health Score. The participants who look after their grandchildren as babysitter are accepted as study group and they filled a survey questioning the conditions how they look after their grandchild, what are their responsibilities, how much time daily they spent as a babysitter etc.

RESULTS: A total of 3101 participants included into the study (Study group n= 1190, 38.3%). The participants in the study group were younger (65.39±0.1 years) than the control group (72.03±0.1 years). The grand parents were mostly look after their grand children in daytime (74.9%), they spent 81.39±60.1 hour per week for babysitting. The participants in the study group had lower EQ5 scores (7.29±2.2) compared to control group (9.08±0.4) (t=20.128, p<0.001). The control group had lower general health scores (49.79±20.1) and higher BECK depression scores (22.25±13.7) compared with the study group (66.56±18.4) and (12.96±11.84) respectively (t=20.956, p<0.001 and t=19.305, p<0.001). There was correlation between age of the participants in study group with EQ5 (r=0.279), general health score (r=-0.432), and BECK (r=0,395) (p<0.001 respectively).

CONCLUSION: The grandparents had better scores for depression and general health scores although their quality of life is lower compared to the control group. More information is needed to explain this situation.

Keywords: Grandparents, babysitter, depression, quality of life, primary care

P-0481

Gestational Thyrotoxicosis

Selçuk Yıldız¹, Yusuf Üstü², Ebru Yılmaz¹, Sevim Öğülmüş¹, Basri Furkan Dağcıoğlu², Mehmet Uğurlu²

¹Family Medicine, Ankara Atatürk Training and Research Hospital, Ankara, Turkey

²Family Medicine, Yıldırım Beyazıt University, Ankara, Turkey

BACKGROUND:

Aside from diabetes mellitus, hyperthyroidism is the most common endocrinopathy in pregnancy. Its prevalence is about 0.05 to 0.2%. In this case, we aim to evaluate obstetric outcomes of the women with thyroid dysfunction.

CASE:

A 31-year-old woman with 14 week twin pregnancy was admitted to obstetrics clinic because of the shortness of breath. Her physical examination was normal. Obstetric ultrasonography was consistent with her gestational week and there were no abnormalities on fetuses. The laboratory findings were revealed hyperthyroidism (TSH: 0,005 µIU/mL, T4: 2,4 ng/dL, T3: 9 pg/mL, Anti Thyroglobulin antibody: 31,24 IU/mL, Anti TPO antibody: 5,14 IU/mL) and elevated liver enzymes (AST: 71 U/L, ALT: 186 U/L). Close follow-up was recommended without medication because of possible complications.

At 18. week visit, laboratory analysis revealed normal liver function test but her thyroid function tests were still abnormal. At her 20. week visit she was diagnosed as intrauterine exitus and two dead fetuses with 500 gr and

560 gr in weight, delivered vaginally. In follow up, it was observed that her thyroid function tests were at normal levels. She was considered as gestational thyrotoxicosis and discharged.

DISCUSSION

Thyroid dysfunction in pregnant women may cause serious maternal and fetal complications. The cause of the symptoms associated with hyperthyroidism in pregnancy is the thyrotrophic effects of high levels of β -HCG. The upper normal range for TSH is recently considered to be 2.5 mUI/mL in the first trimester and 3.0 mUI/mL for the remainder of pregnancy.

The term gestational thyrotoxicosis refers to patients with clinical and biochemical hyperthyroidism in early pregnancy. Screening for TSH, which is a sensitive marker for thyroid dysfunction, should be supported despite lack of consensus among authors.

Keywords: pregnancy, Gestational Thyrotoxicosis, hyperthyroidism

P-0482

Comparison of Edinburgh Postnatal Depression Scale and Patient Health Questionnaire to Screen Postpartum Depressive Symptoms among Mothers of 0-12-Month-Old Babies

Tuğba Yurdakul, Ayşe Gülsen Ceyhun Peker, Zehra Dağlı, Ayşe Selda Tekiner, Mehmet Urgan

Department of Family Medicine, School of Medicine, Ankara University, Ankara, Turkey

OBJECTIVE: The study was carried out to compare the Edinburgh Postnatal Depression Scale (EPDS) and the 9-Item Patient Health Questionnaire (PHQ-9) as a screening tool for postpartum depressive symptoms, to investigate the prevalence of depressive symptoms and to evaluate the risk factors of depressive symptoms among mothers of 0-1-year-old babies who applied to the well-child clinic.

METHODS: The cross-sectional study included 425 women who registered their 0- to 12-month-old infants at the well-child out-patient clinic of the Division of Social Paediatrics of a university hospital in Ankara between September and November, 2014. The participants completed a questionnaire designed by the researchers, containing demographic characteristics, EPDS, and PHQ-9. The data was analyzed by Student's t, Pearson's Chi-Square, Fisher's exact, and Mann Whitney U tests and logistic regression. Two scales were compared using intra-class correlation coefficient, Spearman's correlation, and inter-rater agreement.

RESULTS: The prevalence of postpartum depressive symptoms was 21.9% with EPDS. The proportion of women with increased risk for depression with PHQ-9 was 23.6%. History of depression, history of anxiety disorder, poor relationship between the participant and her partner, between the participant and her mother, between the participant and her partner's parents, an unplanned pregnancy, child care-related problems, and health problem of the child were the risk factors significantly associated with postpartum depressive symptoms. The predictors of postpartum depressive symptoms were poor relationship between the participant and her partner, between the participant and her mother, between the participant and her partner's parents. The agreement between EPDS and PHQ-9 was generally moderate with Inter-rater agreement ($\kappa=0.541$, $p<0.001$). There was a positive correlation between two scales. Both scales were similar for detecting high postpartum depression risk. Intra-class correlation coefficient between EPDS and PHQ-9 scores was excellent ($ICC=0.793$; $p<0.001$).

CONCLUSION: As EPDS, PHQ-9 can be used to screen postpartum depression in primary care.

Keywords: Postpartum depression, depression screening, Edinburgh Postnatal Depression Scale (EPDS), 9-Item Patient Health Questionnaire (PHQ-9)

Table:1

		Min – Max	Mean±S.D.
Age (years)		18-45	29.79±5.11
		Number (n)	Percentage (%)
Education	Elementary school and lower	69	16.3
	Middle school	171	40.4
	College	158	37.4
	Higher	25	5.9
Occupation	No	226	53.3
	Yes	198	46.7
Employment Status	Employed	47	10.9
	Temporarily laid off	129	30.5
	Unemployed	247	58.4
Health Insurance	Yes	395	94.3
	No	24	5.7
Household Income Per Month (TL)	0-899	41	10.0
	900-1799	131	31.8
	1800-2699	105	25.5
	2700 and higher	135	32.8
Number of Children	1	214	52.6
	2	150	36.9
	3 or more	43	10.5
Chronic Disease	Yes	59	13.9
	No	365	86.1
Medication	Yes	39	9.2
	No	384	90.8
Smoker	Yes	70	16.5
	No	354	83.5
Alcohol Use	Yes	8	1.9
	No	416	98.1
Family History of Psychiatric Illness	Yes	30	7.1
	No	393	92.9
History of Depression	No	330	77.8
	Yes	94	19.2
History of Anxiety Disorder	No	352	83.6
	Yes	69	16.4
Poor Relationship With Partner	No	297	70.5
	Yes	124	29.5
Poor Relationship With Mother	No	373	89.7
	Yes	43	10.3
Poor Relationship With Partner's Parents	No	322	76.5
	Yes	99	23.5
Child Care-Related Problems	No	362	86.0
	Yes	59	14.0
Unplanned Pregnancy	No	358	85.5
	Yes	61	14.5

The sociodemographic characteristics, medical and relational history of the participants

P-0483

Case report: Ovarian Hyperstimulation Syndrome (OHSS)

Mustafa Kürşat Şahin¹, Gülay Şahin²

¹Canik Community Health Center, Samsun, Turkey

²Department of Family Medicine, Medical Faculty, Ondokuz Mayıs University, Samsun, Turkey

Background & AIM: Ovarian hyperstimulation syndrome (OHSS) is a rare, iatrogenic complication for ovarian stimulation by assisted reproduction technology and other infertility treatments. Following gonadotropin therapy, OHSS usually develops several days after oocyte retrieval or assisted ovulation. This syndrome is characterized by ovarian enlargement due to multiple ovarian cysts and an acute fluid shift into the extravascular space. Young age, low body mass index, polycystic ovarian syndrome, previous OHSS, high follicle count, and elevated serum estradiol (E2) are the certain factors that predispose women to OHSS.

CASE: A 28-year-old nulliparous woman presented to family medicine clinic with complaints of severe abdominal pain and shortness of breath. The clinical picture showed abdominal pain, ascites, nausea, dyspnea and amenorrhea. After imaging examinations and laboratory tests, the diagnosis was established. Then patient referred to obstetrician. Twin pregnancy was in 12 weeks. Obstetrician performed USG. The ultrasonographic examination revealed bilaterally enlarged multicystic ovaries and a large amount of ascites. Immediately after admission, infusion therapy was started, consisting of normal saline-infusion 0.9% 1000 ml, glucose 5% 1000 ml. Body weight, abdominal circumference, intake and outputs, ultrasonography, and laboratory studies were monitored strictly daily. Then 1 week later, shortness of breath and abdominal pain decreased. Patient was discharged from hospital. After delivery all symptoms relief.

CONCLUSIONS: Diagnosis and management of ovarian hyperstimulation syndrome requires high index of suspicion, prompt investigation and early initiation of effective therapy. With correct diagnosis and early treatment, most patients recover.

Keywords: ovarian hyperstimulation syndrome, pregnancy, IVF

P-0484

Case report: Pruritic urticarial papules and plaques of pregnancy (PUPPP)

Mustafa Kürşat Şahin¹, Gülay Şahin²

¹Canik Community Health Center, Samsun, Turkey

²Department of Family Medicine, Medical Faculty, Ondokuz Mayıs University, Samsun, Turkey

Background & AIM: The eruption of changes occurs initially on the abdomen and extends over the thighs, legs, back, buttocks, arms, and breasts. Skin changes typical for PUPPP are erythematous, urticarial plaques, and papules. Rash regression is usually observed with in 6 weeks postpartum. PUPPP is a rare dermatosis of unknown etiology that is most frequently seen in primiparas and twin/multiple pregnancies. The prognosis is favorable. We report a case of PUPPP in a primipara and review the clinical signs, differential diagnosis, possible etiologic factors, diagnosis, and therapy.

CASE: A 29-year-old woman complained of an intensely pruritic rash for 2 days. The rash began 28-weeks during pregnancy. It began on her abdomen and spread to her buttocks, legs and upper arms. On examination, erythematous papules and urticarial plaques were present in the striae of the abdomen and buttocks and involved the legs, arms and back. No excoriations, vesicles or pustules were present, and there was sparing of the face, palms and soles. The patient was treated with desloratadine, hydroxyzine and cool compresses. Follow-up 4 days later revealed a worsening rash and persistence of severe pruritus. At that time the patient was placed on metilprednisolon and beklometasone dipropionate, which led to relief of her symptoms and clearing of the rash. After delivery all symptoms relief.

CONCLUSION: PUPPP's prognosis extremely good, but mother's severe itching is unbearable. Primary care physicians should be kept in mind.

Keywords: Pruritic urticarial papules and plaques of pregnancy, pregnancy, histamine antagonists, topical steroid

P-0485

Knowledge Level About Folic Acid and Its Usage Rate Among Pregnants

Ceyhun Yurtsever, Elif Altunbaş Ateş, Turan Set

Department of Family Medicine, Karadeniz Technical University, Trabzon, Turkey

AIM: This study aimed to determine knowledge level about folic acid (FA), its usage rate and factors affecting them in pregnant.

METHODS: This study was performed on the pregnancy clinic, Karadeniz Technical University, Faculty of Medicine in January 2015 as a cross-sectional study. A questionnaire asking patients' demographic characteristics, knowledge level about folic acid and its usage was developed by researchers. This survey was performed in 102 pregnant volunteers.

RESULTS: The mean age of participants was 30.6±6.1 years. The rate of pregnant who know preventive effect of FA on congenital abnormalities was 42.2% (n=43). Approximately half of these women (48.8%) had learned it from a gynecologist. When FA regular usage rate among participants was 63.7%, almost all of them (95.5%) had started to use it after learning her pregnancy. Usage rate of FA with advice from gynecologist and family physicians was respectively 87.1 % and 11.4%. Knowledge level about FA had increased with education level ($p<0.001$) and usage rate had increased with knowledge level about it ($p<0.001$). Age, total number of pregnancies, number of living children or abortion and abnormally birth history didn't affect the FA's usage ($p>0.05$).

DISCUSSION: In our study, knowledge level about FA and its usage rate was seen as low. The biggest part of pregnant started to use FA when they learn their pregnancy. This situation can attribute to inadequacy of pregnancy planning and prepregnancy care. Appropriate use of folic acid decreases the NTD about %75. In one study, the rate of using FA in pregnant who consult to primary care in order to prepregnancy care was determined 5 times more in comparison to all population.

CONCLUSION: FA usage of women who planned pregnancy is highly important within the context of preventive health service. Increasing of knowledge level about FA contribute to increase its usage rate.

Keywords: Family physician, folic acid, prepregnancy care

P-0486

Postpartum Period Shingles

Kamuran Bahar Sandıkcı¹, Funda Gökgöz Durmaz²

¹Çubuk 5th Family Health Center, Family Medicine, Ankara, Turkey

²Bağlar 13th Family Health Center, Family Medicine, Diyarbakır, Turkey

BACKGROUND: Postpartum woman (puerperium) refers to the women within about six weeks period after birth. During this period when hormonal, inflammatory and immune system changes reversed in women, care should be taken against infectious diseases.

METHODS: In this study, we present the diagnosis and treatment of a patient presenting with postpartum developed shingles.

RESULTS: A 31-year-old g1p1 postpartum woman on 26th day admitted to family medicine center with vesicular infection spreading along left C4 dermatome but not exceeding midline of the body (figure). She told that her complaints started 5 days ago with itching, first she had thought that it was acne and tried to drain it, and then she thought it was caused by her necklace and applied cologne. The lesions were observed as few groups had begun to dry. She stated that she have been going on lactating. General state of the baby was active, lively and no debris was observed. The patient was informed about her condition and recommended to continue lactation. She was warned to be careful about chickenpox which may be develop in the baby.

CONCLUSION: Problems experienced by mothers should be continuously assessed by health care personnel during 6 weeks, in order to ensure the quality of post partum follow-up and care

Keywords: maternity, shingles, family medicine

figure



P-0487

Social inequalities in oral health among older people in Lebanon

Nada El Osta¹, Robert Saad¹, Martine Hennequin², Stephanie Tubert-Jeannin², Nada Bou Abboud Naaman³, Negib Geahchan⁴, [Lana El Osta](#)⁴

¹Department of Prosthetic Dentistry, School of Dentistry, Saint-Joseph University, Beirut, Lebanon

²Clermont University, University of Auvergne, CROC-EA4847, Centre de Recherche en Odontologie Clinique, Clermont-Ferrand, France

³Department of Periodontology, School of Dentistry, Saint-Joseph University, Beirut, Lebanon

⁴Department of Public Health, School of Medicine, Saint-Joseph University, Beirut, Lebanon

BACKGROUND AND AIM: The percentage of Lebanese elderly has increased considerably. Since they are marginalized in the health policy-making process, we suggest a strong social inequity of oral health that has not been studied so far.

The aim of our study was to compare the oral health in a Lebanese elderly group according to their socioeconomic status (SES).

METHODS: This was a cross-sectional designed study. Participants were recruited from three different primary health care clinics in Beirut: two private clinics where patients pay for medical fees or are covered by a health insurance, and a central dispensary for elderly where persons with no health insurance can have free medical consultations. During a six-month period, all patients aged 65 years or more and living independently were invited to participate in the study. Data were collected from questionnaires including sociodemographic variables, perception of oral and general health, and number of chronic diseases, medications and dental visits. Oral examinations included the number of absent and decayed teeth, the prosthetic status and the number of functional dental units (FUs).

RESULTS: Two hundred sixty-four participants aged 71.4±6.27 years (64.7% female) were included in the study. The mean number of absent and decayed teeth were considerably lower in high SES, and important in low SES (-p-value<0.05). The FUs and oral health perception were considerably better in high SES and worse in low SES (-p-value<0.05). A higher percentage of elderly from low SES presented a poor oral health perception due to functional problem, oral symptoms and psychosocial trouble.

CONCLUSIONS: Our results showed that the dental care system in Lebanon is not accessible for elderly with low

SES. The future appliance of the WHO Global Strategy for prevention and control of diseases might decrease the inequality in oral health for Lebanese elderly and avoid the serious health expenses.

Keywords: Elderly, Lebanon, Oral Health, Socioeconomic Status

Health perception and oral health characteristics of participants according to the socioeconomic status

	Socioeconomic status			Sig.
	High (n=61)	Middle (n=96)	Low (n=107)	
1. Perception of general health N(%)				
- Poor	4(6.6%)	8(8.3%)	45(42.1%)	<0.001
- Moderate	19(31.1%)	41(42.7%)	44(41.1%)	
- Good	38(62.3%)	47(49.0%)	18(16.8%)	
2. Number of health problems m ± SD	2.77 ± 1.61	3.45 ± 1.94	3.89 ± 2.12	0.002
3. Number of medications m ± SD	4.59 ± 2.81	5.40 ± 2.51	4.19 ± 2.88	0.008
4. Dental visits				
- Regularly	28(45.9%)	12(12.5%)	1(0.9%)	<0.001
- In case of pain	33(54.1%)	84(87.5%)	106(99.1%)	
5. Dental status				
- Dentate	52(85.2%)	72(75.0%)	51(47.7%)	<0.001
- Edentate	9(14.8%)	24(25.0%)	56(52.3%)	
6. Presence of partial or complete denture				
- Yes	26(42.6%)	44(45.8%)	60(56.1%)	0.285
- No	35(57.4%)	52(54.2%)	47(43.9%)	
7. Presence of implants supported prosthesis				
- Yes	14(23.0%)	0(0.0%)	0(0.0%)	<0.001
- No	47(77.0%)	96(100.0%)	107(100.0%)	
8. Number of functional units				
- ≤4	13(21.3%)	27(28.1%)	63(60.0%)	<0.001
- >4	48(78.7%)	69(71.9%)	42(40.0%)	
9. ADD-GOHAI				
- Good oral health perception 57-60	21(34.4%)	28(29.2%)	8(7.5%)	<0.001
- Moderate oral health perception 51-56	23(37.7%)	33(34.4%)	19(17.8%)	
- Poor oral health perception 12-50	17(27.9%)	35(36.5%)	80(74.8%)	

P-0488

Insomnia in elderly: correlations with somatic and psychiatric pathology

Gabrielė Kulikauskaitė¹, Rūta Jacevičiūtė¹, Aušra Deksnytė²

¹Vilnius university, Faculty of medicine, Vilnius, Lithuania

²Vilnius university hospital, clinics of Santariškės, Vilnius, Lithuania

Background and aim. Sleep onset and maintenance problems are a very common complaint among elderly individuals. The data on the etiology of sleep disruptions remains contradictory: in our survey we evaluated the connection between sleep disturbances and various medical and psychiatric conditions amid senior primary care patients.

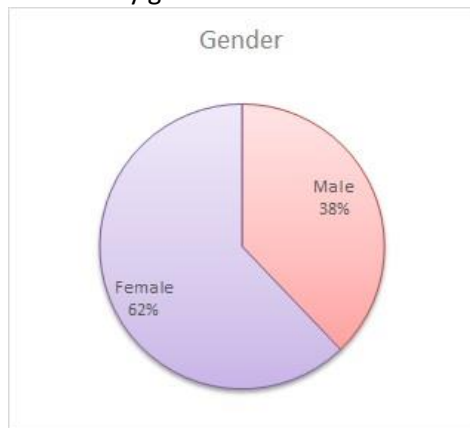
Materials and methods. A cross-sectional study included 140 patients. The Pittsburgh Sleep Quality Index and Hospital Anxiety and Depression Scale were used to evaluate patients psychiatric symptoms and Charlson Comorbidity Index (CCI) was calculated for estimating the burden of somatic pathologies. Statistical Packet for Social Sciences 20.0 and Microsoft Office Excel 2007 were used for statistic analysis with the significance level of 0.05 assumed.

Results. Of 140 participants 53 (37.86%) were man, 87 (62.14%) women. Mean age was 66.08+/-4.677 years. 42.14% from the patient sample were suffering from sleeping disorders, 57.86% were not. Clinically significant depression symptoms occurred in 10.8% (27 patients) and 88.9% of them suffered from sleep disturbances. Among 113 patients who didn't have clinically significant depression symptoms only 30.7% had sleeping disorders. The correlation between sleep disorders and depression was statistically significant, $P < 0.05$. Symptoms of anxiety occurred in 30 patients and 93.33% of these patients also had sleeping disturbances. Only 28.8% of the patients who did not have clinically significant anxiety symptoms suffered from sleeping disorders. The correlation between sleeping disorders and anxiety was statistically significant, $P < 0.05$. Mean CCI of the sample was 0.935+/- 1.13. In those patients who did not have sleeping disorders the mean CCI was 0.6+/-0.91, in those who had it was 1.39+/-1.25. This difference was statistically significant, $P < 0.05$.

Conclusions. Sleep disorders have strong correlation with depression, anxiety and somatic comorbidity, but to find out the causality of sleeping disorders and comorbid conditions prospective research with a bigger sample is needed.

Keywords: Elderly, Insomnia, Comorbidity

Patients by gender



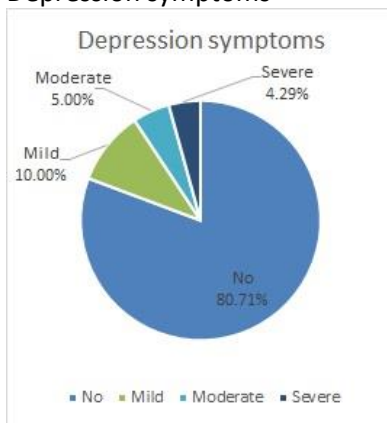
Patients by gender

Sleep quality



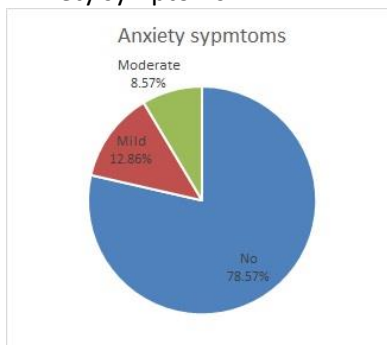
Sleep quality

Depression symptoms



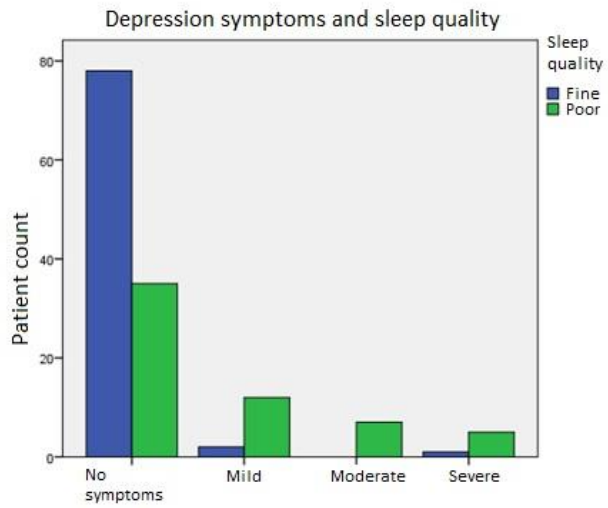
Depression symptoms

Anxiety symptoms



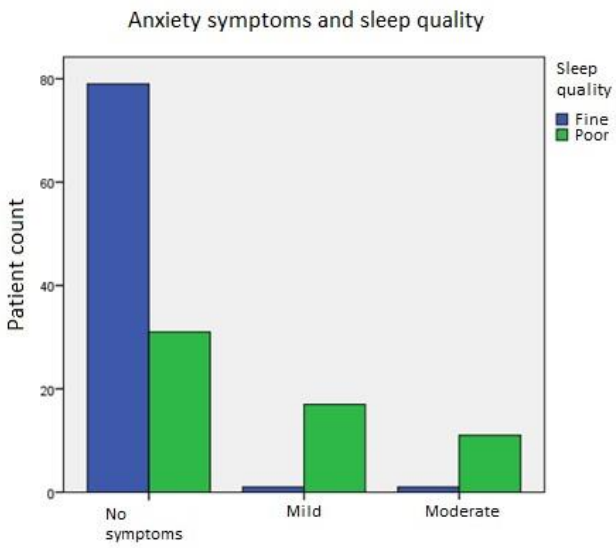
Anxiety symptoms

Depression symptoms and sleep quality



Depression symptoms and sleep quality

Anxiety symptoms and sleep quality



Anxiety symptoms and sleep quality

P-0489**Observational study on the appropriateness of prescribing drugs in pain management osteoarthritic with comorbidities (diabetes, Hypertension)**

Giovanni Colucci¹, Floriana Dimambro¹, Enza Colucci¹, Fabrizio Pastore¹, Silvana Francesca Parrella¹, Pasquale Iacovazzo¹, Martino Solito¹, Fabio Robusto², Vitantonio Colucci³

¹General Practitioners Asl Ta 5 Martina Franca, Taranto, Italy.

²Mario Negri Sud-Santa Maria Imbaro's institute, Chieti, Italy.

³Engineer Martina Franca, Taranto, Italy.

Osteoarthritis (OA) is cause of disability in elderly. Total costs (Italy) are estimated pro-capite 455 € (therapy, diagnostics, care gastropathy). OBJECTIVES: FANS's prescription is correlated to underlying disease and comorbidities; general practitioners (GPs) considers risk factors (age, sex, comorbidities); the most prescribed drug respects guidelines; are prescribed multiple classes of pain medications; critical/ managerial shortcomings. 8 GPs worked with a total of 12,000 patients (pz); extrapolated from data base 185 pz (M: 79, F: 115) with OA/comorbidities. Pain therapy: paracetamol / codeina (PC); FANS; opioids(O). Inclusion criteria: age ≥45; sex (M, F); diagnosis (ICD-9-CM); OA; hypertension (IA); diabetes (DM); drugs (ATC). Multivariate analyzes are adjusted for demographic and clinical factors. 185 pz: 37.8% male, 62.2% female; average age: 71; range: 45-93 years (aa). DM 22.7%, 87.6% IA. Therapy: P + C 21.6%, FANS: COX1 94.6%, COX2 27%, or 23.2%. Age groups divided in: <65 years, 65-74, 75-84 and ≥85. Years 65-75 was the most represented with: 9 DM, 46 IA and 11 DM + IA. For age range we evaluated: FANS, FANS + P / C, O. Between 65-75: FANS 45.4%, FANS + P / O 47%, OR 7.6%. We evaluated prescription drug in presence of comorbidities. DM: 47.8% FANS, FANS + P/O 47.8%, OR 4:35. IA: FANS 58%, FANS + P/O 35.7% or 6.3%. DM + IA: FANS 47.4%, FANS + P/O 52.6, OR 0%. With multivariate logistic regression (endpoints: use alternative of FANS) age > 65 (OR: 2.411, CI: 1189-4892, p: 0.01), sex is M (OR: 0.501, CI: 0266-0941, p: 0:03) are factors that induce GPs to prescribe alternative therapies. In literature there are few clinical trials for careful treatment in OA with comorbidities. Recommend greater training of GPs in management of chronic pain with attention to FANS (adverse effects) and O and cardiovascular risk factors.

Keywords: Osteoarthritis, comorbidities, drugs, adverse effects, cardiovascular risk.

P-0490**Frequency of polypharmacy among elderly home care patients**

Münevver Tulunay, Nisa Solmaz, Feyza Çelik, Doğukan Doğruel, Mustafa Arslan Bircan, Cenk Aypak, Hülya Yıkılkan, Derya İren Akbıyık, Süleyman Görpelioğlu

Department of Family Medicine, Diskapi Yildirim Beyazit Training and Resaerch Hospital

AIM: Polypharmacy is widely seen with its negative clinical consequences(1),such as drug-drug interactions,adverse effects,patient nonadherence,increasing of comorbidities,hospitalization and mortality(2).This is a particular concern in elderly patients who have cognitive and functional deficiency.The most common definition of polypharmacy is using multiple medications (5 drugs or more)(3,4).The aim of the study is to determine the frequency of polypharmacy in elderly home care patients and find the relationships between demographic characteristics, comorbidities and functional status regarding dependency.

METHODS: Patients older than 65 years and followed by Diskapi Yildirim Beyazit Training and Research Hospital Homecare Unit, were included in this study.The data about demographic characteristics,comorbidities,medications and functional status were extracted from medical files.RESULTS: One hundred and forty two patients (71.1% female and 28.9% male) were included in this study.The mean age of the patients was 79.9±6.6 years.There were 75 fully-dependent patients(52.8%) and 67 half-dependent patients (47.2%). Average number of drugs which were utilized by the patients was 5.9 per day.Of total 95 patients (66.9%) had polypharmacy. The most frequent five drug groups were anticoagulants (54.9%), angiotensin converting enzyme inhibitors/angiotensin receptor blockers (50.7%), beta blockers (39.4%), antiaggregants (32.4%), diuretics (28.2%). There was no relationship between polypharmacy and sociodemographic characteristics, comorbidities or functional status. CONCLUSION: The frequency of polypharmacy is found to be high in elderly home care patients. Physicians should focus on polypharmacy management and try to prevent inappropriate prescriptions.

1. Maher RL, Hanlon J, Hajjar ER (2014) Clinical consequences of polypharmacy in elderly. *Expert Opin Drug Saf* 13: 57–65.
2. Martínez-Arroyo JL, Gómez-García A, Saucedo-Martínez D. *Gac Med Mex*. 2014 Dec;150 Suppl 1:29-38. [Polypharmacy prevalence and potentially inappropriate drug prescription in the elderly hospitalized for cardiovascular disease].
3. Reid J, Crome P. Polypharmacy: causes and effects in older people; . www.prescriber.com, October 19, 2005.
4. Williams C.M. Using medications appropriately in older drugs. *Am Fam Physicians* 2002; 66: 1917-1924

Keywords: home care, elderly, polypharmacy

P-0491

Quo Vadis Clostridium Difficile Enterocolitis? Trends over last seven years

Lucia Kukuckova¹, Katarina Dostalova³, Veronika Sucha², Stefania Moricova³, Jan Luha⁴

¹Slovak Society of General Practice, Department of Long Term Ill, Derer's Hospital, University Hospital, Bratislava, Slovakia

²Department of Long Term ill, Derer's Hospital, University Hospital, Bratislava, Slovakia, Jurgos s.r.o., Outpatient Department of Gastroenterology, Bratislava, Slovakia

³Faculty of Public Health, Slovak Medical University, Bratislava, Slovakia

⁴Department of Medical Biology, Genetics and Clinical Genetics, Faculty of Medicine, Comenius University, Bratislava, Slovakia

In recent years, diarrhea caused by *Clostridium difficile* (CD) has become a frequently discussed topic. Guidelines for diagnosis, treatment, and prevention of *Clostridium difficile* infections were published in several countries, among them Slovakia. But did it lead to any change in the everyday medical practice?

We compared the incidence of *Clostridium enterocolitis* (CE) at the Department of long term ill in the years 2008 and 2014. We tested the stool specimens for CD antigen and toxin in every patient with diarrhea.

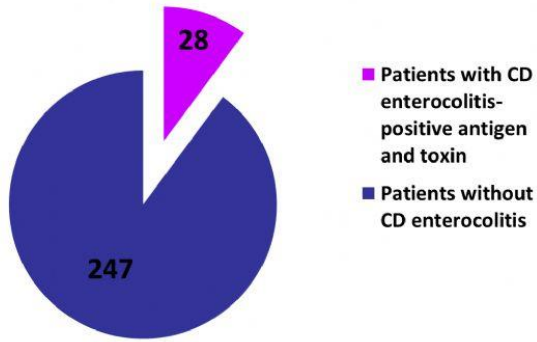
From 275 hospitalised patients in 2008 in 28 (10,2%) the toxin of CD was positive and the diagnosis CE was confirmed. Bronchopneumonia and urinary tract infections were the most frequent reasons for antibiotic therapy. Ciprofloxacin was the most used first line antibiotic in patients with afterwards determined CE. In this group combined antibiotic therapy was a risk factor for resistance to metronidazol. From 258 patients hospitalized in year 2014, 58 had diarrhea. In 22 patients (8.5%) were antigen (GDH) and toxin positive, in 24 patients (9.3%) was antigen positive and toxin negative. Ciprofloxacin was still the most used antibiotic in departments of previous hospitalisation and our department too. Only 48% patients with diarrhea used probiotics during hospitalization on previous departments, but up to 95% on our department. We analysed several other factors like presence of bowel disease, count of previous episodes of CE, use of PPI, ATLAS and CSI score.

The most used antibiotics didn't change over the years. The occurrence of CE with positivity of toxin seems to decrease from 10.2% to 8.5% (not statistically significant Fisher's exact test with $p= 0.554$), this slight decrease encourages us to stay vigilant.. Further changes in rational antibiotic prescription, use of probiotics and strict hygienic measures have to be done consistently.

Keywords: *Clostridium difficile*, enterocolitis, antibiotics

Structure of patients 2008

Structure of patients



Thorough hand washing is very important- in patients with Clostridium difficile infection use soap, not alcohol disinfectants

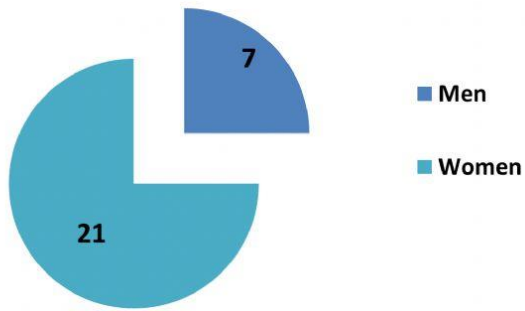


Isolation box for patients with multi-resistant bacterial strains



Men to women with clostridium enterocolitis ratio 2008

Men to women with clostridium enterocolitis ratio

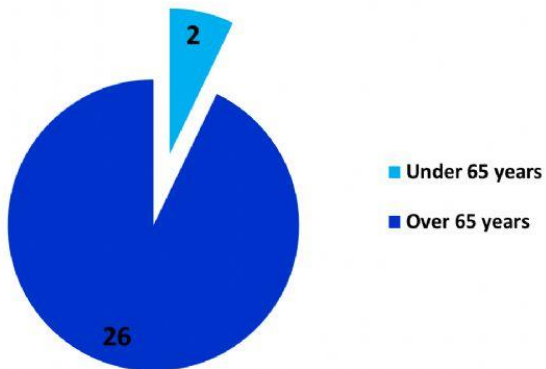


Nursing care for patients in an isolation box



Patients with clostridium enterocolitis stratified by age 2008

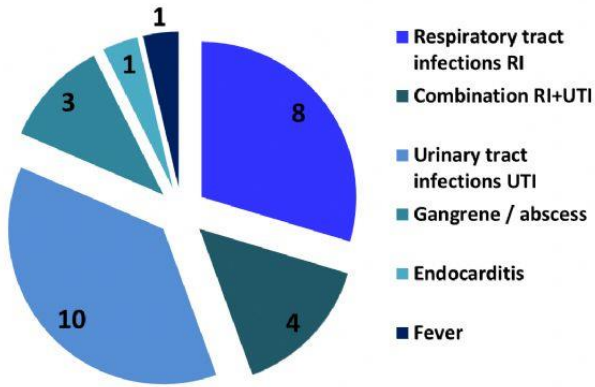
Patients with clostridium enterocolitis stratified by age



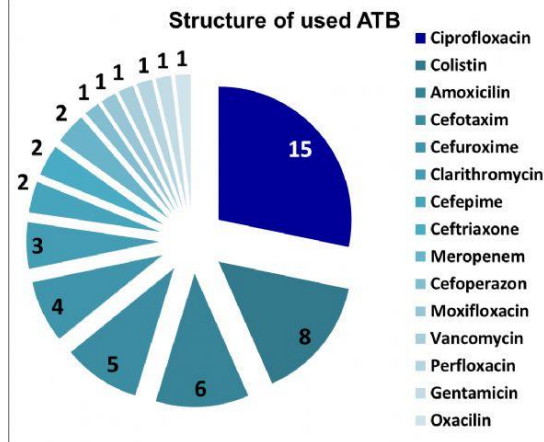
26 patients of 28 (92,86%) were in geriatric age- over 65 years

Reasons for indicating antibiotic therapy 2008

Reasons for indicating antibiotic therapy



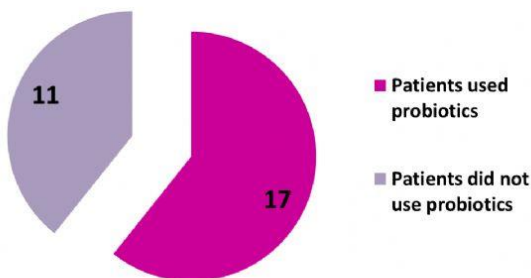
Structure of used ATB 2008



ATB therapy in 2008- 15 patients (53,57%) received ciprofloxacin (13x as first choice) In 3 patients- ciprofloxacin in monotherapy- with good response to treatment with metronidazole 15 patients with CE used combined therapy and in 11 of them failed the therapy with metronidazole Thereof 7 patients had in combination ciprofloxacin (combined ATB therapy means higher risk of CE)

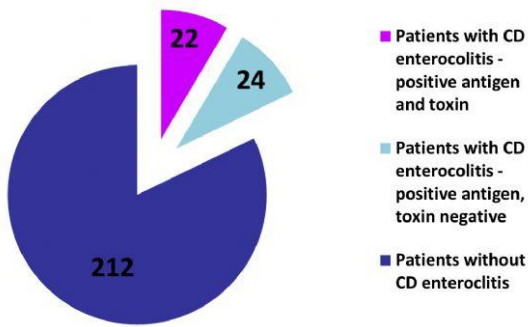
Use of probiotics 2008

Use of probiotics



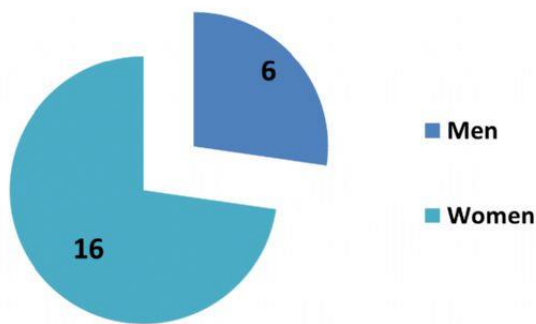
Structure of patients 2014

Structure of patients



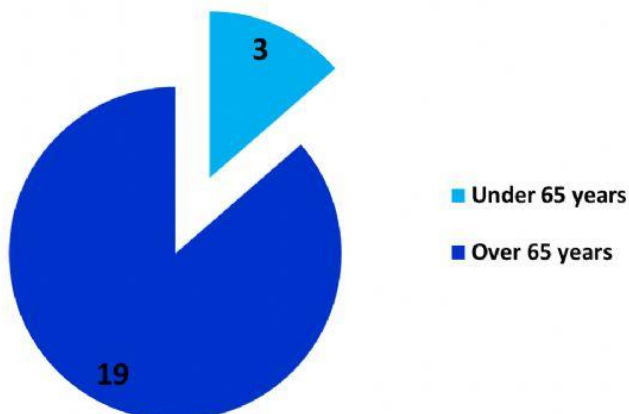
Men to women with clostridium enterocolitis ratio 2014

Men to women with clostridium enterocolitis ratio



Patients with clostridium enterocolitis stratified by age 2014

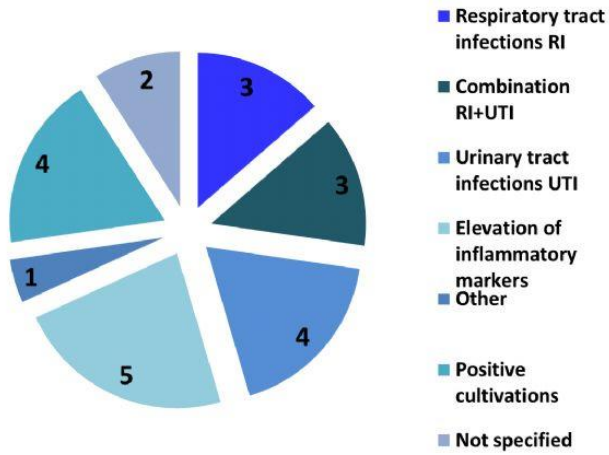
Patients with clostridium enterocolitis stratified by age



19 patients of 22 (86,36%) were in geriatric age- over 65 years

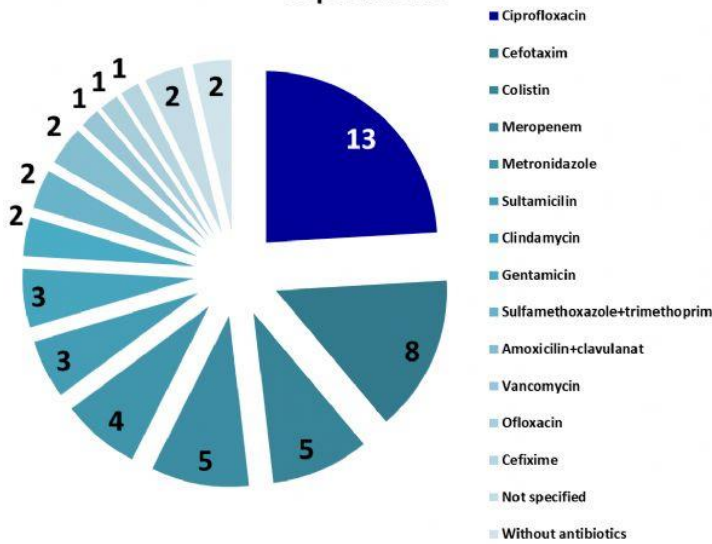
Reasons for indicating antibiotic therapy on previous departments 2014

Reasons for indicating antibiotic therapy on previous departments



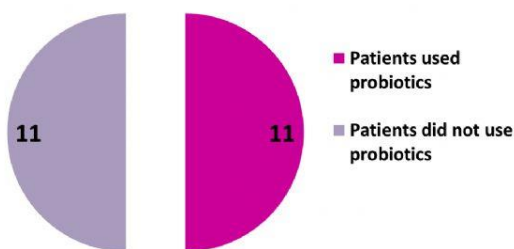
Structure of used ATB on previous departments 2014

Structure of used ATB on previous departments



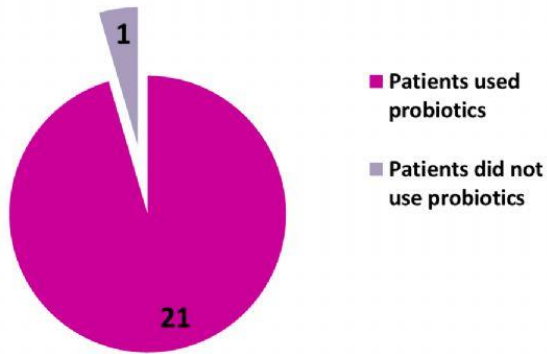
Use of probiotics on previous departments 2014

Use of probiotics on previous departments



Use of probiotics on our department 2014

Use of probiotics on our department



P-0492

Determination of the Level of Knowledge of Stroke among Patients Aged 60 Years and Older

Hüseyin Üçer¹, Hamit Sırrı Keten², Celal Kuş¹, Muzaffer Yiğit Kuran⁴, Soner Ölmez³, Mustafa Çelik¹

¹Department of Family Medicine, Medical Faculty, Kahramanmaraş Sutcu Imam University, Kahramanmaraş, Turkey

²Department of Family Medicine, Kurtul Family Health Center, Kahramanmaraş, Turkey

³Department of Family Medicine, Samsat Family Health Center, Adıyaman, Turkey

⁴Intern Doctor, Medical Faculty, Kahramanmaraş Sutcu Imam University, Kahramanmaraş, Turkey

BACKGROUND: The aim of the present study is to determine the level of knowledge of stroke among subjects aged 60 years and older.

METHOD: The present study included 172 subjects aged 60 years or older, who were admitted to the outpatient clinics at Kahramanmaraş Sütçü İmam University Faculty of Medicine for any reason between March 1, 2015 and June 13, 2015. A questionnaire including questions about sociodemographic features and assessing the level of knowledge of stroke was administered using the face-to-face interview technique. The questionnaire included 11 questions assessing the level of knowledge about the risk factors for stroke and ten questions that assessed the level of knowledge on the symptoms of stroke.

RESULTS: The mean age of the participants was 68.05 ± 7.04 years (min=60, max=88). Of the participants, 97 were females (56.4%) and 75 were males (43.6%). Of the participants, 83 (48.3%) reported that they previously heard of the terms "stroke" and 89 (51.7%) reported that they had not previously heard of this term. The mean stroke risk factors knowledge score of the participants was 7.18 ± 3.21 and the mean stroke symptoms knowledge score was 7.12 ± 2.81 . The mean stroke risk factors knowledge score was 7.09 ± 3.18 in females and 7.26 ± 3.26 in males. The mean stroke symptoms knowledge score was 7.42 ± 2.76 in females and 6.88 ± 2.84 in males. Males and females had similar achievements in stroke risk factor knowledge ($p=0.737$) and stroke symptoms ($p=0.213$) domains.

CONCLUSION: The present study showed a considerable lack of knowledge among individuals aged 60 years and older. The provision of education about stroke is very important from the perspective of health policies in this particular population, already at an advanced age, as an important risk factor for stroke.

Keywords: Stroke, elderly, knowledge level

P-0493

Vitamin B12 of the elderly, a hardly visible deficit

Juliana Pais¹, Maria Miguel Sá²

¹USF Cuidar, ACeS Entre Douro e Vouga, Santa Maria da Feira, Portugal

²USF Famílias, ACeS Entre Douro e Vouga, Santa Maria da Feira, Portugal

Background & aim

The phenomenon of the increasing ageing has imposed the necessity to better understand the physiology of a body in progressive modification. In addition to the normal physiological modifications, emerge pathologies which require a specific treatment, whose interactions might condition the absorption of certain nutrients. Pharmaco-nutrient interactions can origin vitamin deficits, like of vitamin B12, after the extended taking of proton pump inhibitors (PPIs).²

The objective was to raise the awareness to the importance of the early recognition of this problem at the PHC and ease its approach and orientation.

METHOD

Article research on the evidence-based medicine databases without date limitations using the MeSH terms.

RESULTS

The vitamin B12 deficit prevails at the elderly, vegetarians and individuals with protein deficit or gastrointestinal absorption problems. Various studies report the existence of this deficit on people subject to an extended treatment with PPIs. This consequence might be more evident on older people due the existence of diverse comorbidities and the possibility of an increased pharmaco-nutrient interaction. Most of the analyzed studies affirm that there is a relation between the use of PPIs and the vitamin B12 deficit, being this process related to the treatment's duration.

CONCLUSION

Although, numerous studies try to determine the vitamin necessities at the elderly, that correlation is difficult to establish due to the many variables and different methodologies, which condition the generalization of the results.

In terms of the pharmacodynamics this relation can be foreseen, however more studies must be performed to clarify the exact mechanism of this issue.

Keywords: Aged, Vitamin B 12 Deficiency, proton pump inhibitor

Vitamine B12



P-0494

A Comparison of the Knowledge and Awareness of Alzheimer's Dementia in the Arabic Population

Zabeena Merchant, Autumn Savage, Lesca Hadley, Richard Young

Department of Family Medicine, John Peter Smith Health Network, Fort Worth, USA

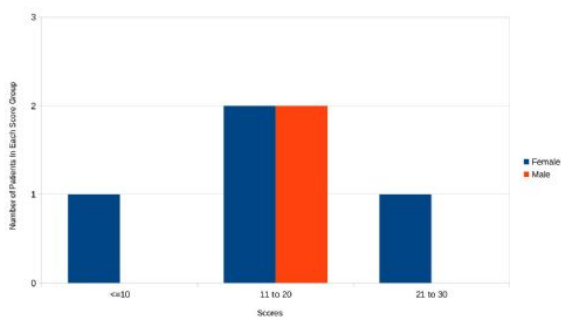
Background & AIM: People from non-Western cultures have a variety of attitudes, beliefs, and experiences with Alzheimer's dementia. The aim of this study is to determine the level of understanding of Alzheimer's dementia in Arabic-speaking patients at the international health clinic at John Peter Smith Health Network in Fort Worth TX.

METHOD: The Alzheimer's Disease Knowledge Scale will be administered by live or phone interpreters at clinic visits or over the phone. Inclusion criteria: Adult Arabic-speaking patients who have moved to the United States within the past five years. Exclusion criteria: patients ages less than eighteen and those who do not speak Arabic. Subjects will be asked about their understanding of the pathophysiology, natural history, and treatment efficacy for Alzheimer's. They will be asked about their personal experiences caring for Alzheimer's patients and their exposure to these patients in their home countries. Sub-analyses will include comparisons of subjects' responses by age, gender, and region of origin.

Results and CONCLUSIONS: Will be ready in time for the conference.

Keywords: Alzheimer's dementia, Arabic, knowledge, international

Scores Based On Gender



Scores Based On All Data

Age	Gender	Origin	Score
29	F	Iraq	13
31	M	Syria	14
38	F	Iraq	16
41	F	Iraq	10
53	F	Sudan	22
65	M	Sudan	15

P-0495

Comparison of the Quality of Life of the Elderly Living in Nursing Homes and Their Own Home and Evaluation of Relationship of This Situation With the Socio-demographic Factors

Beray Gelmez Tas¹, Dilek Toprak²

¹Beray GELMEZ TAS

²Dilek TOPRAK

AIM: In this study, it was aimed to detect the factors affecting the quality of life of elderly people living in their own homes and in nursing homes; to analyse the relationship with sociodemographic features.

MATERIAL-METHOD: 65 years and over 198 people who applied to Sisli Hamidiye Etfal Hospital Family Medicine outpatient clinics with any complaint between February-October 2014 and 202 people who live in nursing home were included the study. A questionnaire including the sociodemographic features and the Turkish short-form of the quality of life questionnaire version(WHOQOL-BREF TR) developed by WHO was performed.

RESULTS: Our study was carried out for a total of 400 patients of which 188(47%) were male and 212(53%) were female. 198 of them were living in a nursing home (first group), 202 people were living in their own home(second group). The average age of second group were 73,3±6,7 years old, while the average age of first group were 73,2±7,3. While 111 of second group(55%), were married, only 12 people(6.1%) were married in first group; 20(9,9%) of second group and 82(41,4%) of first group were uneducated. Most of the second group (n=174;86,2%) and only 4(2%) of first group got 1500 TL and over income. Mental, social, physical and environmental area scores were significantly higher in second group, than first group(p=0.000). Physical(p=0.000) and psychological area(p=0.000) scores were significantly lower in patients with chronic diseases than those without chronic diseases, in first group.

CONCLUSION: Older age, marital status, level of education, higher income and having children in individuals living in their own homes were found to affect the quality of life; sex and chronic disease affect the quality of life in elderly living in nursing homes. By informing the individuals, families and staff working in elderly care centers, the physical, social and psychological health of the elderly people may improve.

Keywords: Elderly, quality of life, nursing home, WHOQOL-BREF TR

P-0496

Primary and Secondary Prevention of Venous thromboembolism in seniors – Matter of Polymorbidity

Katarina Dostalova¹, Lucia Kukuckova², Stefania Moricova¹, Jan Luha³

¹Faculty of Public Health, Slovak Medical University, Bratislava, Slovakia

²Slovak Society of General Practice, Department of Long Term Ill, University Hospital, Bratislava, Slovakia

³Department of Medical Biology, Genetics and Clinical Genetics, Faculty of Medicine, Comenius University, Bratislava, Slovakia

Background.

Venous thromboembolism (VTE) is a disease of aging, with a low rate of about 1 per 10,000 annually before the fourth decade and 5–6 per 1000 annually by age of 80.

Methods.

219 patients with VTE were followed in last 6 years by the Outpatient Department of Angiology. VTE was diagnosed by colour duplex ultrasound and CT pulmoangiography.

Results.

100 (45.7%) of them were men and 119 women (54.3%), from 21 to 90 years. 20,55% of patients were 21-45 years old. 40,18% of patients were 66-90 years old. 21.6% of seniors and 13.3% of young adults suffered from PE, difference is not statistically significant (Fisher's exact test with p=0.476). We identified recurrence of VTE in 52.3% of seniors and 28.9% of young adults (p=0.018). 42.2% of young adults and 28.4% of seniors had more important thrombophilia mutations (p=0.336). 11.4% of seniors and 22.2% of young adults reported VTE in relatives (p=0.113). 34.1% seniors had malignant disease but only 4.4% of young adults (p<0.000). 17.0% of

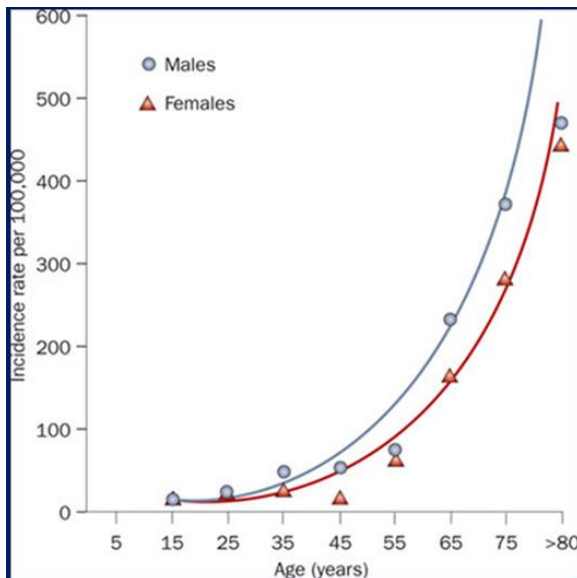
seniors and 24.4% of young adults suffered from VTE in the context with trauma ($p=0.589$). 11.4% of seniors and 8.9% of young adults developed a perioperative VTE ($p=0.575$). 31.1% of young adults and 4.5% of seniors underwent VTE regarding to use of hormones ($p<0.000$). 4.4% of young adults and 4.5% of seniors developed VTE regarding to travelling ($p=0.426$).

Conclusions.

We have confirmed that the presence of secondary risk factors in the elderly is more pronounced than in young adults. Lower education, lower availability of modern communication technologies seem to be a disadvantage for seniors, therefore they appear to be the target group for personalized forms of education in the community.

Keywords: venous thromboembolism, seniors, primary and secondary prevention

Annual incidence of venous thromboembolism by age and sex

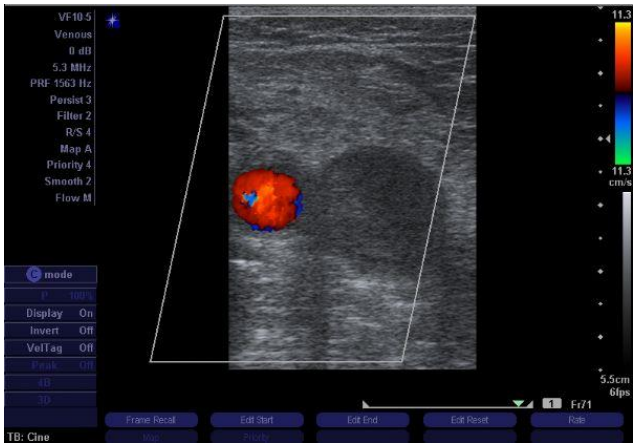


Annual incidence of venous thromboembolism (pulmonary embolism and DVT combined) among residents of Worcester, MA, USA in 1986 by age and sex. Renee A. Douma, Pieter W. Kamphuisen & Harry R. Buller: Acute pulmonary embolism. Part 1: epidemiology and diagnosis, Nature Reviews Cardiology 7, 585-596 (October 2010)

Color duplex ultrasoun - examination



Color duplex ultrasound



v. femoralis is extended, fullfilled by thrombus, non-compressible

Educational activity in senior club



Educational activity in club of patients with malignant diseases



92-year old patient after hip fracture



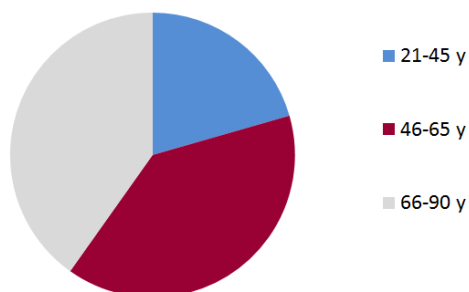
Early surgery of fracture is expected to be low incidence of complications. Equally timely mobilization and rehabilitation.

Study group - characteristics

pulmonary embolism	20,1 %
recurrency of VTE	41,1%
positive family history	17,2%
genetic predisposition	36,5%
malignancy	20,5%
VTE in context of travel	19,6%
VTE in context of injury	12,3%
VTE in context of surgery	6,4%

Study group by age

Venous Thromboembolism study group



Analysis of risk factors

Risk factor	Young adults	Seniors	Statistical significance difference (Fisher's exact test)
important thrombophilia mutations	42.2%	28.4%	P=0.336
VTE in relatives	22.2%	11.4%	P=0.113
malignant disease	4.4%	34.1%	P<0.000
VTE in the context with trauma	24.4%	17.0%	P=0.589
perioperative VTE	8.9%	11.4%	P=0.575
VTE regarding to use of hormones	31.1%	4.5%	P<0.000
VTE regarding to travelling	4.4%	4.5%	P=0.426

P-0497

The Phenomenon of polypharmacy among people of third and fourth age in a rural area of Crete

Theodoros Vasilopoulos¹, Georgia Arseni², Ioannis Patramanis², Vasileios Petsas², Athina Kouraki², Evangelia Souliotaki²

¹Health center of Ag.Barbara, Herakleio,Crete, Greece

²Venizeleio Gen. Hospital, Herakleio,Crete,Greece

BACKGROUND-AIM: The recording and qualitative/quantitative assessment of chronic medication among people of 3rd and 4th age in a rural setting.

METHOD: The population of the study consisted of 86 subjects ≥65 years, who attended a designated general medical office, over a period of six months, for regular prescription and who were hospitalized in a pathology clinic at least once during the year 2014.

RESULTS: 32 were men. The ages were 65-93 years old (40 persons of 3rd and 46 of 4th age). Only two subjects (2.2%) were not receiving any medication. The number of medicines per patient was up to 12, with a mean of 4.6 (4.2 and 4.8 for the third and fourth age respectively). The number of daily doses amounted to 16 (mean 5.4, 5.2 and 5.8 for the third and fourth age respectively). Individuals with higher education received lower average number of medicines (3,4 vs 4,8) and a smaller number of daily doses (3,6 vs 5,5). In all cases, the medications were prescribed by a doctor. 22 (25,5%) patients, receiving the maximum number of medicines, were not attending a personal family physician, minimizing hence the possibility their doctor to reduce their number of tablets.

The most common drugs were cardiological/antihypertensives (79.1% of patients), anticoagulants / antiplatelets (49.6%), antiulceratives 41.9%- although in most cases had no indication, and psycholeptic ie. antipsychotics / anxiolytics / hypnotics / sedatives / antidepressants / nootropic / dementia (41.7% of patients, with 1-3 compositions per patient). Among medication of the latter category, 7% granted for radiculopathies.

CONCLUSIONS: Despite the changes in the health system, the polypharmacy currently seems to be a constant phenomenon in the third and fourth age.

These results highlight the need for radical changes in the national health system and the importance of each patient to have easy access to his personal general/family physician.

Keywords: polypharmacy, general practice physician, health services accessibility

P-0498**Comprehensive Geriatric Assessment of Elderly Adults in Eastern Anatolia Region of Turkey**

Hülya Çakmur

Department of Family Medicine, Kafkas University, Kars, Turkey

Background and Aim The average age of residents in rural areas of Turkey is gradually increasing. The purpose of this study is to summarise the comprehensive geriatric assessment of elderly adults living in a rural area of Turkey characterised by a relatively low level of socioeconomic development.

Method This study was designed as a prospective, cross-sectional study, conducted in a rural area of Kars Province. A total of 168 elderly adults (≥ 65 years old) were included in the study. The comprehensive geriatric assessment comprise the evaluation of general health status, cognitive function, emotional status, social support, and the caregiver burden. Cognitive function was assessed using the Standardised Mini Mental Scale. The emotional status of the participants was assessed only for depression using the Geriatric Depression Scale-Short Form.

Results The study group ranged in age from 65-96 years (mean 72.70 ± 7.73 years), and 53.6% were female, 84.3% had not completed elementary school, and 43.29% had a monthly income of ≤ 500 Turkish Liras. Eighty-one per cent of the participants were physically healthy, as they showed no co-morbidities or polypharmacy. The most frequently observed chronic disease was hypertension (45.2%). The rate of heart disease was 17.3%; diabetes mellitus (type II), 13.1%; chronic obstructive pulmonary disease, 11.6%; gastric diseases, 16.3%; benign prostatic hypertrophy, 16.7%; arthritis, 48.3%; generalised pain, 58.3%; thyroid function disorder, 4.2%; and urinary incontinence, 51.2%. Dental-oral problems were found in 57.1% of participants. The audio impairment rate was 10.7%; the visual impairment rate was 8.3%; and the smoking rate was 11.9%. The percentage of caregiver burden was 7.3%. The impaired cognitive status rate was 6.8%, depression rate was 10.9%. The rate of perceived social support and social well-being was 95.2%.

Conclusions It is believed that this study will contribute considerably to understanding the health status and needs of elderly adults living in this region.

Keywords: Geriatric assessment, elderly, health status indicators.

P-0499**Robots and aging – the road ahead?**

Ana Nunes Barata

USF Amora Saudavel, Seixal, Portugal

Background

World's population is growing older and, consequently, the need for long term care is rising as many elderly lose the ability to live independently and look after themselves. In the last years, technology has been evolving fast, reaching new grounds day by day, focusing on products that want to answer to the needs of the elderly population.

The development of robotics, namely of the social robots, follows up on this technological boom. They provide solutions to improve patient's quality of life and the caretaker's task when caring for a patient with long term supportive care needs.

The presentation will consist in a brief presentation of social robots that are being developed, followed by the presentation of some observed results, namely focusing on the social robot for elderly with dementia, PARO®.

Methods

Review of the literature published in PubMed, from 2010 to 2015 on the keywords "Robot assisted therapy", "Human-Robot interactions" and "PARO robot".

Results

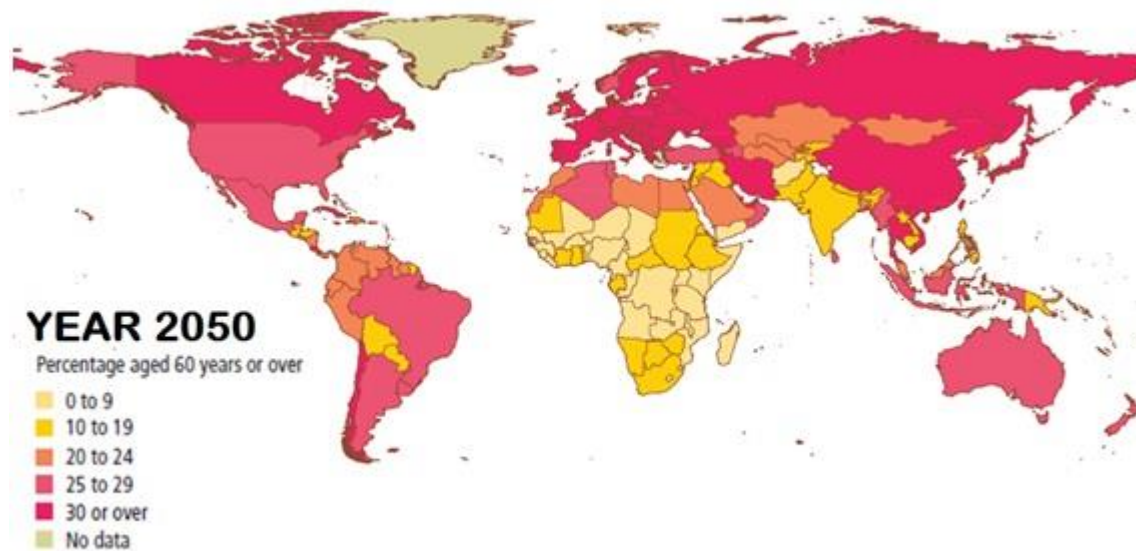
Social robots have shown to have improvements in the quality of life of elderly patients. The social robot PARO®, as it is inspired in animal assisted therapy, has shown results in reducing the level of aggressiveness and agitation, also promoting more social behavior in elderly people suffering from dementia.

Conclusions

Robot assisted therapy may be a possibility to improve elderly people's quality of life and also reduce the need for psychotropic drugs in this population. By introducing and making participants aware to the topic of “social robotics”, participants are invited to reflect on the possibilities on how to apply robots both in healthcare settings and as social interaction facilitators.

Keywords: Social robots, geriatric care, dementia, PARO

World Map



World population distribution by 20150

Paro®



PARO® robot

P-0500

The model of care oasis: A new approach for GPs to improve care for Persons with advanced dementia

Jean Claude Leners

LTCF ALA Oasis, Erpeldange, Luxembourg

Background and AIM: Since some 6 years now we have organized two care oasis for People with advanced dementia. In order to implement definitively this model of care, an external evaluation was realized. The aim of the care oasis is to improve communication, diminish anxiety, guarantee comfort. Both care oasis are imbedded in two larger nursing homes and five GP are working in these institutions and are also part of the communication facilitators during their presences once or twice a week.

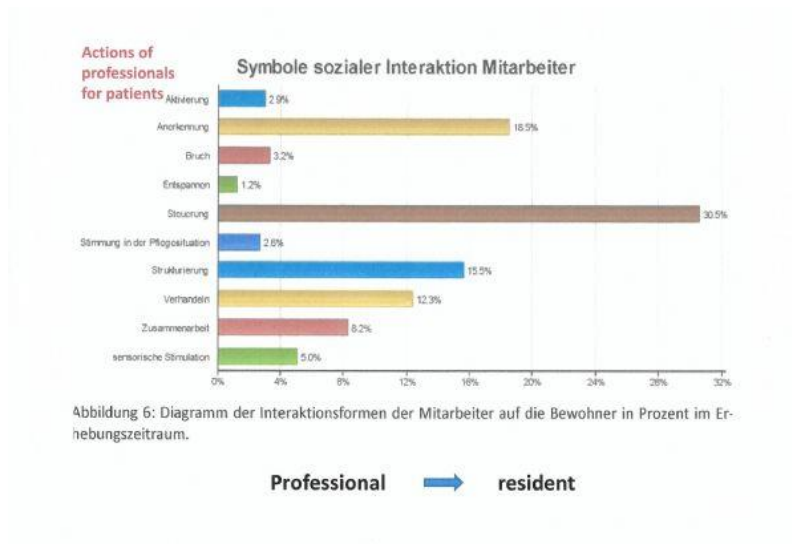
METHOD: The care approach in the oasis is well related to T Kitwood’s work on patient-centered care (in details during presentation) and the model chosen to evaluate the positive interactions between carers and patients is based on Wessel’s model on human ontogenetic.(details during presentation) The interaction between the Person with dementia and the caregiver, including the physicians, was evaluated during 14 days and communication abilities were split into several aspects.

RESULTS: The main outcome from the Patient’s point of view was: giving (to act at same eye level for both) = 71%; apathy = 5,1% and submission = 17,1%. The interaction giving was subdivided further in openness to act = 36,7% and showing personal concern in 23,7%. From the caregiver’s side, including GPs, the three major interactions were: guidance (30%), recognition or valuating the Patient (18) and negotiation (15). (All results will be displayed). Furthermore the activities in direct contact with the Patient were in the care oasis 68% of total activity, compared to 55% in a regular ward. Finally the burn-out evaluation for the caregivers showed lower values in the care oasis team (2,5) compared to regular ward team (2,9) for the emotional exhaustion scale.

CONCLUSION: The model of care oasis is an alternative for good medical practice in nursing homes for people with advanced dementia.

Keywords: Advanced dementia, medical interaction, care oasis

13



14

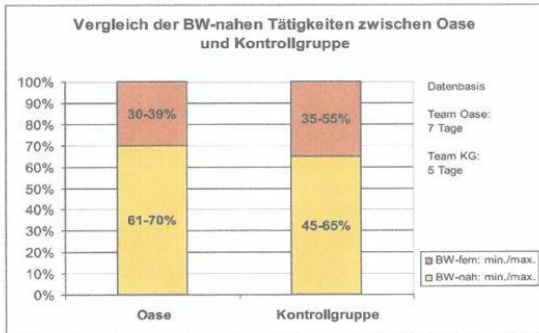


Abbildung 18: Verteilung bw-nahe und bw-ferne Zeit Pflegeoase

Time for nurse in contact with the resident compared to a control group outside the oasis

background a aims

Oasis of care for patients with advanced dementia

Diminish anxieties
 Increase security, recomfort,
 Have a climate of protection, confidence,
 Give attention, guide, structure

Dr JC Leners GD Luxembourg lenersj@pt.lu

2

I. Concept:

Increase quality of life for people with advanced dementia,
 The team follows the rhythm of patients in the oasis,
 Keep as long as possible autonomy and mobility, in a secure environment

3



Individualized spaces

4

II. Architecture

180 m² for maximum 8 residents

Open air space of 32 m²

Bath-room : 15 m²

5



6

III. Interactions and ways of communication

nurse with resident **P**

resident with nurse **R**

7

Recognition

- Visual Contact
- Verbal Contact
- Affection
- Greeting
- Felicitation
- Listening

Negotiation

- Take into account patients' wishes
- Take into account their preferences
- At the end of communication: a good-by
- To check for insecurities

Collaboration

- Leave time for initiative by the resident
- Sustain patient's actions
- Give the patient a choice to do
- Get him/her involved

Sensitive Stimulation

- Try to increase souvenirs
- Give the patient options to savour
- Stimulate to eat/ to drink

P

8

Good Atmosphere in care situations

- Consider uncertainties
- Humour
- Sadness
- Anger
- Attention fixed

Relaxation

- Hold the patient (attachment)
- Stay to his/her rythm
- Select influences
- Keep a comfortable position

Activation

- Be attentive
- Give rythm

Conduct

- Invitation
- Detachment
- Guide kindly

P

9

Structure

- Orientation in time
- Orientation in space
- Environment
- Structure the day as wished by the patient

Separation

- To come without announcement
- To go without a good-by
- To pass just the patient ignoring him

« To give »

- Patient's Initiative
- Consent
- His/her concern
- Availability
- Gratitude/Recognition
- Greetings

P

R

10

Demands

- > Express wishes
- > Express actions

Subordination

- > Follow injunctions
- > Accept
- >

Resistance

- > Hesitation
- > Refuse
- > Reject

Apathy

- Without reaction
- Without participation

Control

- Injunction
- Detachment
- Guidance



11

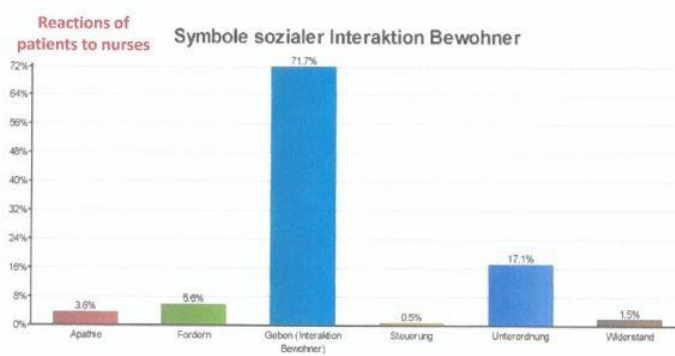


Abbildung 4: Diagramm der Interaktionsformen der Bewohner auf Mitarbeiteraktivitäten in Prozent im Erhebungszeitraum.

Resident → professional

12

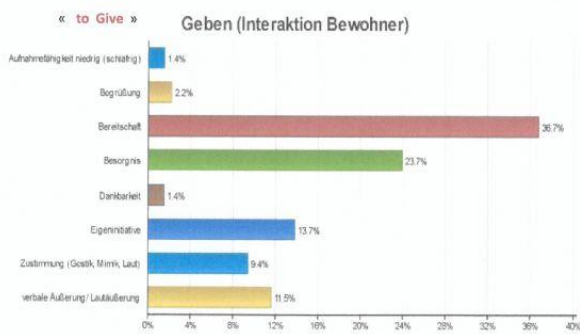


Abbildung 5: Diagramm der Unterkategorie Geben in Prozent im Erhebungszeitraum.

P-0501

The Use of Proton-Pump Inhibitors Among Geriatric Patients Who Are Receiving Anti-platelet Therapy: Is it enough?

Feyza Çelik, Nisa Solmaz, Münevver Tulunay, Mustafa Arslan Bircan, Dođukan Dođruel, Cenk Aypak, Hülya Yıkılkan, Derya İren Akbıyık, Süleyman Görpeliođlu

Department of Family Medicine, Dıřkapi Yıldırım Beyazıt Training and Research Hospital, Ankara, Turkey

BACKGROUND&AIM: Although anti-platelet therapy (APT) extremely useful for the acute and chronic management of patients with cardiovascular diseases, the cardioprotective property of prolonged aspirin and clopidogrel therapy is associated with gastrointestinal complications including ulceration and bleeding.¹ Risk of these complications increases with advanced age, having peptic ulcer, use of dual anti-platelet therapy, and concomitant use of Non-Steroidal Anti-inflammatory Drugs (NSAIDs).² Proton-pump inhibitors (PPIs) are recommended to decrease the risk of gastrointestinal complications.³ The aim of this study is to determine the frequency of using PPIs among geriatric patients who receive APT.

MATERIAL&METHOD: We reviewed the medical records of 79 patients who were older than 65 years and receiving APT and followed by Diskapi Yildirim Beyazit Training and Research Hospital Homecare Unit. Patients who were receiving PPIs therapy for gastrointestinal diseases such as gastroesophageal reflux disease and gastritis were excluded.

RESULTS: Of the patients, 56 (70.9%) were women and 23 (29,1%) were men with the mean age 80.47±6.17 years. Patients were using anti-platelet agents for cerebro-vascular disease (32.9%), cardio-vascular disease (27.8%), both of them (11.4%) and other diseases (such as hypertension, diabetes mellitus) (27.8%). The ratio of patients using only aspirin was 74.7% (n=59), only clopidogrel was 15.2% (n=12) and dual APT was 10,1% (n=8). Nineteen of the patients were receiving warfarin and/or NSAIDs in addition to APT. Among the all patients receiving APT (n=79), only 26.6% (n=21) were using PPI for secondary prevention. The two most common used PPIs were lansoprazole (52.4%) and pantoprazole (23.8%).

CONCLUSION: Majority of the geriatric patients with an increased gastrointestinal risk are not treated with a proton-pump inhibitor. Identification of high-risk patients and, in such patients, incorporation of strategies to reduce their gastrointestinal risk would be clinically prudent.

Keywords: Anti-platelet therapy, Proton-pump inhibitors, Geriatric patients

P-0502

Edema like a hallmark of a severe Dermatomyositis

María Fernanda Sánchez Burgos¹, Xael Pena Pérez², Enma Marianela Morales Espinoza², Carmen Barrio Ruiz¹, David Herrero Barrera²

¹Primary Care Center Camps Blancs. San Boi de Llobregat. Barcelona, Spain.

²Emergency Department and Internal Medicine. General Hospital. Parc Sanitari Sant Joan de Deu. San Boi de Llobregat, Barcelona Spain

Summary:

Dermatomyositis is a type of inflammatory myopathy that affects skeletal muscle and skin which include a generalized erythema, heliotrope rash, and/or Gottron's papules. Generalized or limb edema is an uncommon manifestation of dermatomyositis. We report one case who presented upper extremity edema.

Case description:

A 83-year-old woman, who presented left upper extremity edema, pruritus of face and hands, accompanied by hoarseness and dysphagia mixed 15 days ago. Analytical, X-ray, thorax Computerized Axial Tomography (CAT), cervical CAT, and electrocardiogram results were normal. Endoscopy of stomach suggested neoplasm gastric; biopsy was taken. Abdominal CAT showed increased uptake mural thickening and gastric lesser curvature, solid liver lesion in segment VII suggestive of M1. A week later, the patient presented weakness neck muscles. For suspected inflammatory myopathy in context of gastric neoplasm, creatine phosphokinase (CPK), immunological study, and electromyography were requested. CPK was 1008, and left deltoid muscle biopsy was required. Afterwards heliotrope rash and Gottron's papules were evident. Gastric biopsy showed mixed type invasive carcinoma. The muscle biopsy revealed an inflammatory myositis; and the electromyography showed a myogenic involvement in all of 4 limbs and bulbar muscles, consistent with inflammatory myopathy. We started corticosteroid treatment. This case was presented to the oncology committee, and due to the presence of metastases, oncospecific treatment was dismissed. The final diagnosis was Dermatomyositis with secondary gastric neoplasm. Immunosuppressive was introduced. She presented initial clinical improvement, but finally she showed progressive decline until her death.

CONCLUSIONS:

In a case of unilateral edema we have to make a differential diagnosis between vascular, systemic and infectious diseases. In our case, muscle weakness was the reason for suspecting of dermatomyositis. A literature review shows that edema is a hallmark of a severe dermatomyositis that requires aggressive treatment.

Keywords: Dermatomyositis, edema, muscle weakness.

Gottron's papules.



P-0503

Complications of urinary catheters in elderly

Theocharis Georgios Lепенos, Maria Dimitrios Liarou, Dimitrios Lampros Mpellos, Panagiota Vasileios Prasinou Tzormpatzaki, Roza Ioannis Koliogeorgi, Vasileios Ioannis Spatharas, Spyridon Panagiotis Skoufias, Eirini Matthaïos Sveroni

Health Center Amfikleia-Lamia Hospital-Greece

Background

Elderly people are more likely to require urinary catheterization for longer periods of time due to a variety of medical problems. Our purpose is to turn General Practitioners' attention to the commonest complications of long-term catheterisation in the elderly.

Methods

The usual practice for indwelling catheters is to change them every 4-5 weeks. Between May 2013 and April 2014 we studied 52 patients (45 men and 7 women) older than 65 years of age who attended the Health Center, seeking medical attention before the planned date for the catheter change. They all had had complications related with their catheters.

On assessment, patients reported a constellation of symptoms including tiredness and lethargy, confusion, fever and rigors, being generally unwell, changes in urine ("milky", "cloudy" or bleeding), abdominal pain, dysuria and large amounts of urine leaking around the catheter.

Results

The complications related with indwelling catheters in the study population were: 34,6%(18) urinary tract infections; 42% (22) catheter blockage or obstruction, 9.6% (5) bladder spasms, 13.4% (7) urethral Injury. In patients with urinary tract infection, the catheter should be changed and a urine sample from the newly inserted catheter should be sent for MC+S.

Patients with mechanical complications (leakage, blockage (encrustations)) might do better if their catheters were changed more often.

The most commonly prescribed drugs to relax the bladder and prevent spasms were anticholinergics.

Urethral injury is a common, especially if the catheter is inserted forcefully.

Conclusions

Catheter complications usually require replacement of the catheter. Long-term catheter users need to be well trained in the management of their catheters, as their quality of life may be seriously affected by the above mentioned complications. The use of urinary catheters should be avoided whenever possible.

Keywords: elderly, complications, urinary catheters

microbe



P-0504

Assessment of nutritional status in the elderly and its relationship to social and health factors

Ruth Muñoz Maya¹, Carmen María Jiménez Herrera², Diana Dominguez Jiménez³

¹CS Don Paulino García Donas, Alcalá de Guadaíra. AGS Sevilla-Sur, Andalussia, Spain

²CS Nuestra Señora de la Oliva, Alcalá de Guadaíra. AGS Sevilla-Sur, Andalussia, Spain

³CS Estepa, Estepa. AGS Osuna, Andalussia, Spain

Background: Aging is accompanied by changes in body composition, physiological functions and activity patterns, which can modify the nutritional needs and intakes and can lead to protein-energy malnutrition. As factors involved in the nutritional status of the elderly are: physiological, socio-economic, medical, habits (alcohol, smoking), lack of health care in the issue (lack of diagnosis or iatrogenic)

Aim: To analyze the prevalence and degree of malnutrition in the elderly patients in our clinic.

Method: observational, descriptive, cross-community study.

>Population: random sample of 200 over-65-year-old patients who attend our primary care centre, placed in Seville (Spain)

>Independent variables:

- Age
- Gender
- Nutritional status, assessed by Mini Nutritional Assessment Test, physical examination and analytic parameters.

>Dependent variables (under study): socio-health factors.

- Acute Diseases
- Chronic diseases
- Drugs intake
- Recent hospital admissions
- Surgeries
- Toxic Habits
- Office Admissions

Conclusions: Nutritional assessment in the elderly can be carried out reliably from primary care services. The results of this study shall show not only a theoretical nutrition level of the elderly population, but an approach to the various risk factors that we can influence as primary care physicians, both at an individual as a community level

Results: Our research is at data collection phase, the results will be shown at the Conference. Literature tells us that nutritional status of the elderly population is a key indicator of health. In Spain 5% of apparently healthy elderly in the community may have malnutrition. Disease related malnutrition reach between 10-55% of people in areas without food shortage. Most of the studies about nutrition in older patients are sampled institutionalized elderly population and home hospitalization units. However, few studies are launched in the elderly in the community.

Keywords: nutritional status, elderly, frail elderly, nutrition assessment

P-0505

immunization status in the elderly:what are the attitudes of health care workers and improving precautions?

Orhan Yildiz, Saliha Serap Çiftçili

Marmara Medical School, İstanbul, Turkey

INTRODUCTION: The aims of this research are to explore attitudes of health care workers in primary health care workers towards elderly immunization and to define the barriers against it.

METHOD: There were two phases in the study. In the first phase; Health Care workers (physicians and nurses) who work in Family Health Centers and people over 65 years of age who admitted to these centers between 15.08-15.12.2014 were evaluated. Datas were collected from 583 participants by the help of three different questionnaires. In the second phase of the study, qualitative data were collected from the 26 volunteers who accepted to be in the focus group interviews. Six focus group and three in-depth interviews were conducted by two educated researchers. The interviews were audiotaped and transcribed verbatim.

In the statistical analysis of quantitative data, descriptive statistics, chi—square test and Student’s t test were used. Thematic analysis was used to encode the qualitative data.

RESULTS: Of the elderly participants; 65,3 % (n=235) thinks that vaccination is unnecessary in their age group; 57,5 % (n=207) said that they has been vaccinated at least once last year. Of the family physicians participated in the study, 66,4% (n=75) told that they knew the vaccines necessary for this age group. Of the family health care center nurses, 50,9% (n=56) says that they know the vaccines for this age group. The participants pointed out lack of integration in between different levels of health care system, lack of follow-up and records of adult immunization, problems with availability of certain vaccines in the market and workload excess as barriers against adult vaccination.

CONCLUSIONS: In conclusion, most of the elderly participants were not aware of the subject. Need for post-graduate and public education came up and public education material such as brochures or TV spots was offered as a solution.

Keywords: Vaccination in elderly, Adult Immunization, Aging, Preventive Immunization, Vaccine.

Figure 1: Belief in necessity of elderly immunization

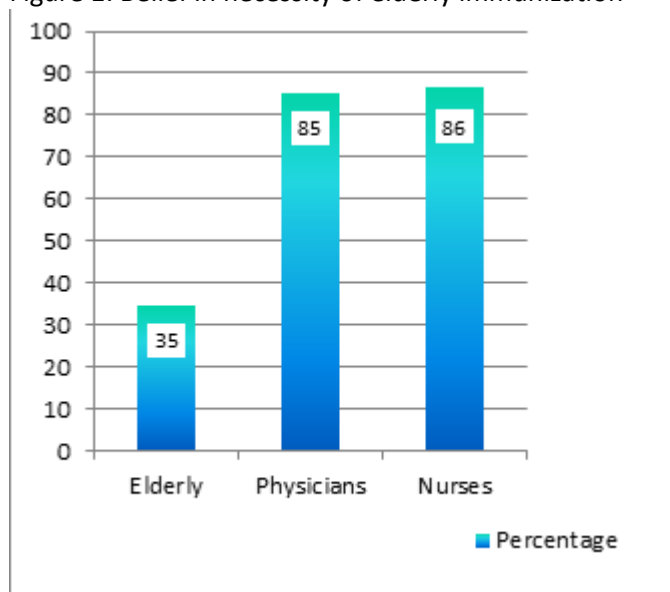


Table 1: Socio-demographic characteristics of the physicians and nurses.

Socio-demographic characteristics.	Physicians (n=113)	Nurses (n=110)
Average age	38,8 (SD:6,7)	35,5 (SD:6,7)

Sex (Female)	50,4 %	100 %
Attended post-graduate education about immunization	31 %	22,7 %
Influenza vaccination annually (self)	34,5 %	41,8 %

Table 2 Relationship between elderly participants' socio-demographic characteristics and having had at least one vaccine shot last year. (Istanbul, 2014)

Socio-demographic characteristics	Did you have a vaccine shot last year? (at least one)			p χ^2	
	Yes n %	No n %	Total n %		
Sex	Male	84 (69,4)	37 (30,6)	121 (100)	0,001
	Female	123 (51,5)	116 (48,5)	239 (100)	10,60
Marital status	Married	133 (62,7)	79 (37,3)	212 (100)	0,016
	Single	71 (50)	71 (50)	148 (100)	5,78
Education	Literate	172 (60,1)	114 (39,9)	286 (100)	0,046
	Illiterate	35 (47,3)	39 (52,7)	74 (100)	3,96
Monthly income	0 – 900 TL*	98 (54,1)	83 (45,9)	181 (100)	0,195
	901-2700 TL**	109 (60,9)	70 (39,1)	179 (100)	1,67

*below hunger level and **below poverty level according to the Turkish Labor Union Union's 2014 numbers

P-0506

Evaluation of patients for mild cognitive impairment/dementia and/or geriatric depression who are 60 years or older, admitting to Numune Research and Training Hospital Family Medicine Polyclinics with any kind of complaint and symptoms

Çiğdem Ünsal, Irfan Şencan, Adem Özkara

Department of Family Medicine, Ankara Numune Research and Training Hospital, Family Medicine Department

BACKGROUND: MCI (mild cognitive impairment), dementia and depression are important medical problems in elder patients. These diseases are often underdiagnosed in family health units due to several reasons caused by doctors, patients and relatives of patients. Patients who have these diseases often admit to family health units but only half of the patients can be diagnosed correctly.

AIM: In this study we aim to investigate the number of patients to be diagnosed for MCI/dementia and/or geriatric depression who are 60 years or older, admitting to Numune Research and Training Hospital Family Medicine Polyclinics with any kind of complaint and symptoms.

METHOD: For the diagnosis of MCI/dementia MoCA, for the diagnosis of depression Geriatric Depression Scale is administered. The relation of these diagnosis with sociodemographic data (age, marital status, education level, number of offspring, job/retirement status, residence, nursing status, health insurance, level of income, social activities/hobbies, praying habit) medical conditions (usage of assistive device, existence and number of chronic disease(s), smoking-drinking alcohol, sleep and pain problem, perception of age/health of himself/herself) and laboratory parameters (B12, folic acid, TSH, Hemoglobin, LDL, HDL, triglyceride) are evaluated.

CONCLUSION: The study is in process. Results will be discussed at the congress.

Keywords: dementia, geriatric depression, mild cognitive impairment, primary care, family medicine

P-0507

Primary health care for elderly people in General Practice

Sevdalina Alekova Todorova

Department Family medicine and Ophthalmology, Faculty of Medicine, Trakia University, Stara Zagora, Bulgaria

INTRODUCTION:

In European countries human population is aging rapidly and the providing of quality care in the front-line health care to elderly people is a major challenge for health care systems. The health care of elderly people is also a large part of a general practitioner's work. Co-morbidity, difficulties in communicating, the problems of poly-pharmacy and the need for additional support for the increasingly dependent patients in general practice are important issues in the care of older people.

Goals:

The aim of this study is to determine the role of family doctors in solving a number of medical and social problems in the elderly and in providing quality health care.

MATERIAL-METHODS:

The main methods, which we used in pursuance of the objective are monitoring by the family doctors of the elderly and subsequent interviews with general practitioners regarding the problems in the medical and social nature of these elderly and geriatric patients.

DISCUSSION and RESULTS:

Family doctors are key player in the process of caring for elderly and geriatric patients. On the basis of their professional competence, they participate not only in medical care for the elderly people, but also mental and social assistance of the elderly.

CONCLUSION:

With reference to the study of the basic medical and social problems in the elderly is necessary to develop a complex prevention-oriented program for medical and psychosocial geriatric care in Bulgaria with several priorities:

- Preservation of good mental and physical health of older people through prevention.
- Early detection and intervention of mental degradation, dementia
- Minimize a disability and preserving the autonomy of the elderly by supporting a network of services based on the individual needs of the patient.

Keywords: General practice, the elderly people, Health care

P-0508

Aging and Depression: Present and Future

Romina Martínez Liñares, Sandra M^a Ayude Diaz, Noa Otero Leiro
Complejo Hospitalario de Pontevedra, Galicia, Spain.

BACKGROUND AND OBJECTIVE

82-year-old woman, independent to the basic activities of daily living, partner with married son and 2 grandchildren.

Personal history: atrial fibrillation, hypertension and Dyslipidemia. Osteoporosis. Ulcers in chronic venous insufficiency. Surgery of cholecystectomy and right wrist fracture.

Treatment: Sintrom, Ibandronic acid, Bonesil-D, Simvastatin, Enalapril, Pantoprazole, Ibuprofen, Pregabalin, Duloxetine.

METHOD

Patient with the described background, featuring multiple attendances in the last 2-3 years to hospital emergency room, emergency health center and consultations in primary care by different clinical pictures such as: morning sickness, malaise, headache, sweating, palpitations, Dyspnea morning, generalized pains. Referred for study in rheumatology, cardiology and gastroenterology services, ruling out organic pathology. Tracking by primary, according to diachronic evolution of symptoms, the patient referred sadness that's corroborated by the son, associated with progressive loss of physical faculties associated with aging and without a trigger clear.

Before a so Motley picture with non-specific clinical and affectation of mood, as you suspect disorders on the emotional scale is set: Adaptive mood disorder depressive vs depression with somatic symptoms, subsyndromic, vascular...

It's derived the unit of psychogeriatrics, where treatment is adjusted (Duloxetine, alprazolam and Trazodone) and begins psychotherapy.

Complementary tests: ECG, blood-count, coagulation, Biochemistry and brain-CT all normal.

RESULTS

Narrow tracks from primary and Psychogeriatrics, trying to make comprehensive care, both the patient and their environment and a management multidisciplinary face to the future, achieving thus a favorable evolution of the patient.

CONCLUSIONS

The relevance of this case is the importance of the psychogeriatrics. In Spain 17% of the population is older than 65 years, and 25% of these, is older than 80. The progressive aging of the population and characteristics of mental disorders in old age, justify the need for specific training on this topic, as well as research in Gerontology and Geriatrics and the development specialized programs in all the levels of care mental health.

Keywords: Aging, Depression, psychogeriatrics

Healthy Aging



Physical activities and social relations are the best way to achieve healthy aging.

Sharing laughs.



P-0509

Do we know the balance and fear of falling of the elderly?

José Luis Sánchez Albarrán¹, Pilar Montero Alía¹, Georgina Martínez De La Iglesia¹, Rosa Alcaraz¹, Domenec Serra Serra¹, Carla Benedicto Pañell¹, Mercè Jiménez González¹, M Carmen Rodríguez Pérez¹, Sheila Mendes¹, Sonia Dolader Olive¹, Josep Prat Rovira³, Cristina Teixidó¹, Laura Muñoz Ortiz², Pere Toran Monserrat²

¹Primary Healthcare Centre, Catalan Health Institute, Mataró, Spain

²Primary Healthcare Research Support Unit Metropolitana Nord. Institute of Primary Care Research (IDIAP) Jordi Gol. Barcelona, Spain

³Residence for the Elderly Catalan Institute of Assistance and Social Services

Background and AIM: 75% of all falls come to happen in elderly people over 65 years. Having suffered a fall is itself a risk for a new one. The aim of the present study is to determine the balance and fear of falling of people >70 years-old in order to plan further community interventions.

METHOD: Cross-sectional study. 951 patients older than 70 years-old from 5 different Surgeries and able to walk (with or without any device) have been included. Exclusion criteria: Pfeiffer \geq 5, patients unable to get out of the house, palliative patients and those receiving walking rehabilitation in the last year.

The recruitment has been made by mean the Surgery phone list of people selected according to age.

RESULTS: 59.4% women, mean age 76 years, mean BMI 28.3, crutches for walking 12.6%, mean functional capacity (Lawton and Brody's test) 4.7 in men and 7.6 in women, mean fear to fall (shortened FES-I) 9,2 (score from 7 to 28 points where low scores mean lower fear to fall), balance assessed by mean Wii from Nintendo 61.5% (score from 0 to 100 points where higher scores mean better balance), balance and gait assessment by mean Tinetti's test (balance 14.6 out of 16, gait 11.2 out of 12, total 25.8 out of 28), balance assessment by mean unipodal test (patient is capable 70.5%). Fall rate during a 12-months period prior to inclusion: 32.8%.

CONCLUSIONS: Although an acceptable balance and gait score, our cohort show up an important fall rate 12 months prior to inclusion. Taking into account that almost the entire elderly population is visited in a Primary Care Surgery we suggest that preventive strategies in order to lower the number of falls and their physical, psychological and economic consequences should be encouraged.

Keywords: balance, elderly, fear of falling

P-0510

Special Features on the Global Assessment of Elderly Patient

André Pereira Lourenço¹, Inês Espiga Macedo¹, Pedro Moreira Castro¹, João Azevedo²

¹USF Modivas, AcES Grande Porto IV, Porto, Portugal

²USF Ao Encontro da Saúde, AcES Grande Porto I, Porto, Portugal

Background & Aim

According to WHO in 2010, an estimated 524 million people were aged 65 or older (8% of world's population). By 2050, it is expected that this number will ascend to about three times more (about 1.5 billion), representing 16% of the world's population. The traditional medical evaluation is known to be reasonably effective in most individuals. However, in elderly patients some prevalent problems tend to go unnoticed. This paper aims to signal the specificity of geriatric clinical assessment, crucial for a better therapeutic management of various problems, as well as prevention of disease and disability in this age group.

Method

Classical literature review in: textbooks/guidance manuals, medical society guidelines, systematic reviews and articles published in scientific databases. The authors conducted a search with the MeSH term "geriatric assessment" in UpToDate databases, NHS evidence, Cochrane and PubMed. The articles were selected for their adequacy and scientific relevance.

Results

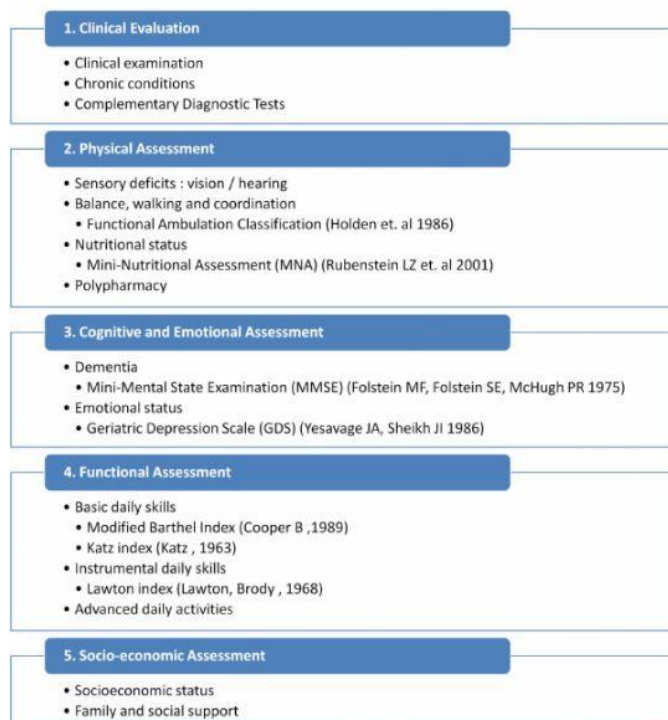
The geriatric patient presents biological and psychosocial specificities that should be considered. A tendency for omission of some symptoms and limitations; the complex pattern and the atypical presentation of the disease spectrum (less consistency between disease and clinical manifestations); the highest morbidity and mortality and more rapid progression of some diseases are some of the most important characteristics to attend.

Conclusions

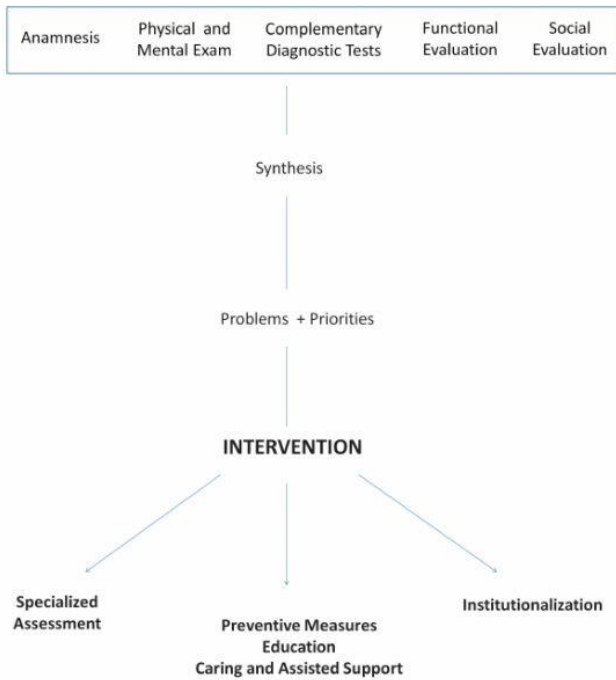
The geriatric assessment differs from a standard medical evaluation in many aspects: the frequent need of more time for the interview and clinical examination; the presence of complex problems and multiple co-morbidities in most individuals; the particular emphasis given to symptomatic relief, functional status and quality of life. This assessment should be made, whenever possible, by a multidisciplinary team, allowing a higher quality and comprehensiveness in patient care.

Keywords: "geriatric assessment", "primary care"

Steps of Global Geriatric Assessment



Types of intervention in geriatric assessment



P-0511

Vaccination of all adults of 60 or more years against Herpes Zoster. What is the evidence?

Álvaro Pereira¹, Maria Inês Capitão¹, Sandra Pereira¹, Sofia Pinheiro Torres²

¹usf bom porto, aces porto ocidental, porto, portugal

²usf aquae flaviae, aces alto tamega e barroso, chaves, portugal

BACKGROUND & AIM: Shingles is a painful skin rash caused by herpes zoster virus, the same virus that causes smallpox. Despite the host can recover from smallpox, the virus is never eradicated. He stays numbed in nervous cells and can return as shingles. Approximately 1 in 3 people will have herpes zoster infection through lifetime. After 50 years old, risk and severity increases because of lower immunity caused by age. In Portugal there is a vaccine approved since 2006 against herpes zoster for adults with 60 or more years. This vaccine is approved by the FDA for adults over 50 years old. The aim of this work is to review the available evidence of the benefits in vaccine routinely all 60 or more years old adults.

METHOD: Search of articles in databases of National Guideline Clearinghouse, NHS Evidence, Canadian Medical Association Practice Guidelines, The Cochrane Library, DARE, Bandolier, Pubmed e TRIP Database, in portuguese, spanish and english, published between January 2010 and December 2014. Use of mesh words Herpes Zoster and Herpes Zoster Vaccine. Quality of evidence and strength of recommendation was determined based on Strength of Recommendation Taxonomy (SORT) of American Family Physician.

RESULTS: We collect 262 articles. 249 were excluded because they didn't meet the inclusion criteria. We admitted 11 articles: 10 guidelines and 1 sistematic review.

CONCLUSION: Despite being approved by FDA for adults over 50 years old, all guidelines recommend one single dose of vaccine in adults over 60 years old (SORT A). Patients with chronic medical conditions should be vaccinated, unless it is counter indicated. Vaccine showed efficacy in reducing cases of shingles, as well as lowering severity of postherpetic neuralgia(SORT A).

Keywords: Herpes Zoster and Herpes Zoster Vaccine

Results

Guideline	Year	Conclusions	Evidence Level
National Guideline Clearinghouse	2013	One dose. Adults > 60 years old, whether or not they report a prior episode of herpes zoster.	1
National Guideline Clearinghouse	2013	Adults > 60 years old, whether or not they report a prior episode of herpes zoster.	2
National Guideline Clearinghouse	2013	One dose. Adults > 60 years old, whether or not they report a prior episode of herpes zoster.	1
National Guideline Clearinghouse	2012	A single dose of zoster vaccine is recommended for adults aged 60 years and over.	2,B
National Guideline Clearinghouse	2012	Adults > 60 years old, whether or not they report a prior episode of herpes zoster. The vaccine is not recommended for persons of any age who have received varicella vaccine.	1
National Guideline Clearinghouse	2014	A single dose is recommended for Adults > 60 years old, whether or not they report a prior episode of herpes zoster.	1
National Guideline Clearinghouse	2011	Zoster vaccination is recommended for all persons aged ≥60 years who have no contraindications, including persons who report a previous episode of zoster or who have chronic medical conditions.	1
Canadian Medical Association Practice Guidelines	2014	CIC recommends routine offering of zoster vaccine to immunocompetent adults without contraindications aged 60 or 65 years and older. A single dose of zoster vaccine is recommended at this time; the need for booster doses in the future is unknown.	1
The American Journal of Medicine	2011	Adults > 60 years old, whether or not they report a prior episode of herpes zoster.	1
Canadian Family Physician	2011	The live virus HZ vaccine reduces the incidence of HZ by about 50% and the occurrence of PHN by two-thirds, with vaccinated individuals experiencing attenuated or shortened symptoms. The vaccine appears to be cost-effective when administered to adults aged 60 years and older.	2

Results

Author, year	Population/Intervention	Results	Conclusions	Evidence Level
Gagliardi et al, 2012	8 ECA N=52269	RR 0.49, 95%IC 0,43-0.56, RD=0.02 NNTB=50	Herpes zoster vaccine is effective in preventing herpes zoster disease. Although vaccine benefits are larger in the younger age group (60 to 69 years), this is also the age group with more adverse events.	1

P-0512

How Much Are Geriatric Patients Dependent? Evaluation and Comparing With Serum B12 Vitamin Levels

Elif Serap Esen¹, Dilek Toprak¹, Berrin Karadağ², Halenur Yiğitbaşı¹

¹Department of Family Medicine, Şişli Hamidiye Etfal Training and Research Hospital, İstanbul,Turkey

²Department of Internal Medicine, Acıbadem University, İstanbul,Turkey

AIM: The aim of this study was to investigate dependence of people over 60 years old in daily lives and to evaluate the relationship with serum vitamin B12 levels.

METHODS: Retrospectively 423 geriatric patients between 2008-2012 in Şişli Hamidiye Etfal Training and Research Hospital Geriatrics Clinics scanned and 129 were included. Lawton Instrumental Activities of Daily Living Scale (LIADLS) was used to evaluate the dependency level of the subjects in their daily lives. Serum B12 levels recorded and B12 <250pg/ml was accepted as B12 deficiency. Body mass index (BMI) 30kg/m² were considered as obese. Descriptive and frequency analysis, Chi-square and t-tests were used by using SPSS 20.0; p<0,05 was considered statistically significant.

RESULTS: Totally 129 patients were collected. 102 were female (%79.1), 27 were male (%20.9). The mean age of the patients was 73.24±7.27 (min=60, max=89). Most of them were living with their spouse (%34.9; n=45) and relatives (%34.9; n=45), and %63.6's patients were not married (%63.6; n=82). Mean BMI was 29.92±5.17 (min=17.80, max=54.1). Most of them were obese (%45.7; n=59). There were no significant relationship between LIADLS and gender, BMI and marital status (p>0.05). Older people who had low B12 levels; needed more help for daily activities (p=0.003). LIADLS results showed that as they are older they were more dependent to other people (p=0.000). Geriatrics patients living with spouse or alone were more independent in daily activities rather than patients living with relatives (p=0.031).

CONCLUSION: There is a relationship between B12 levels, age, living style and daily living activities. Geriatric patients should be supported to live independent and their B12 levels should be regulated. This would increase the quality of their lives.

Keywords: geriatrics,B12,daily lives,

Graphic 1:Gender distrubition(%)

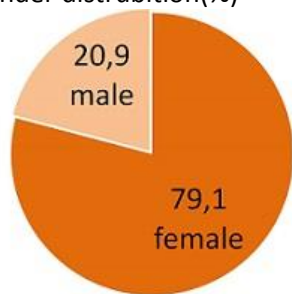


Table 1:Distribution of LB scores regarding serum B12 levels

B 12 LEVELS	LAWTON-BRODY			TOTAL	P
	Dependent	Semi-dependent	Independent		
Low	10 %32.3	6 %19.4	15 %48.4	31	0.003
Normal	8 %8.2	25 %25.5	65 %66.3	98	
Total	18	31	80	129	

Table 2:Distribution of LB scores regarding lifestyle

LIFE STYLE	LAWTON-BRODY			TOTAL	P
	Dependent	Semi-dependent	Independent		
With spouse	4 %8.9	10 %22.2	31 %68.9	45	0.031
With relatives	11 %24.4	14 %31.1	20 %44.4	45	
Alone	3 %7.7	7 %17.9	29 %74.4	39	

P-0513

Spontaneous Fracture in Nursing Home Patient: Case-Report

Oğuz Yılmaz¹, Abdurrahman Çınar¹, Nil Tekin²

¹Department of Family Medicine, Faculty of Medicine, Dokuz Eylül University, Izmir, Turkey

²Narlıdere Geriatric Care Center and Residential Home, Narlıdere, Izmir, Turkey

INTRODUCTION:

The spontaneous fractures occurred in elder patients who were more likely to be bedridden. But there are not many reports of spontaneous fractures in nursing home residents. In this study, we aimed to evaluate spontaneous fracture in long-term bedridden nursing home patient.

CASE:

Osteoporosis was diagnosed in a 77-year-old patient in nursing home for eight years. Intolerable to biphosphonate treatment, she started Strontium ranelate 2gr 1x1 and 600mg ionized ca+400 iu Vit-D3 1x1 and stopped these. She was bedridden for two years and using wheelchair. Having HT, Hyperlipidemia, Epilepsy, Right-Sided Hemiplegia, Dementia, she used valproic acid and PPI for a long time and had a sedentary, unexercising life. Family physician examined the patient without any reported falling/trauma for right leg shortness. She had thigh-shortness and pain and crepitation during movement. Not having tibia, vertebra sensitivity, fracture and open fracture, open wound, edema, hematoma and ecchymosis in other parts, but only hemiplegia in extremity, she was referred to orthopedics for femur midline fracture after splinting right-lower extremity and had operation. In DEXA, L1-L4 T-score was -3.6 and proximal femur T-score was -3.0. Not having secondary osteoporosis, she was diagnosed with senil osteoporosis. Feeding solution and D-vit drop 1x8 drop were continued.

Ageing causes rather complex, important changes in bone-tissue and metabolism. Mechanisms causing senil osteoporosis are combination of responses to the changes in bone-cellular structure and hormonal and nutritional factors. Senil osteoporosis causes trabecular and cortical-bone losses. Patient's age, femality, sedentary life, unexercising, cerebrovascular problem, insufficient sunlight, long valproic acid and PPI usage are the most important risk factors.

In osteoporotic bedridden patients, spontaneous fractures may have occurred as a result of undocumented falls. Prevention and management of spontaneous and traumatic fractures are the same. Family physicians can give a education for caregivers about spontaneous fractures in nursing homes.

Keywords: Osteoporosis, spontaneous fracture, nursing home

P-0514

Polypharmacy in the elderly patients of the health center (USF Servir Saúde)

Patrícia Amaral, Ana Guiomar, Patrícia Silva, Sérgio Marques, Vanda Estríbio

USF Servir Saúde, Corroios, Portugal

Background and AIMS:

Ageing is associated with an increased prevalence of chronic conditions which lead to polypharmacy. Biological processes of senescence originate increased susceptibility to iatrogenia. The use of anxiolytics / sedatives / hypnotics in Portugal has increased and falls in the elderly are often related to their use. The aims of this work were: to find how many patients ≥ 75 years old have ≥ 5 drugs in the chronic prescription list; to know how many of them have anxiolytics / sedatives / hypnotics and/or trimetazidine on that list.

METHOD:

This was an observational study done in 2014. The data was collected from the patient's clinical processes. The processing was made in Excel program.

RESULTS:

We included 1177 elderly patients. From these, 60.7% had ≥ 5 drugs in their chronic prescription list. On average, each of them was using 6 drugs. The anxiolytics / sedatives / hypnotics were chronically prescribed to 20.7% of the elderly. Trimetazidine was only present in 1.7% of the lists.

CONCLUSIONS:

Most seniors of our health center are polymedicated, which may indicate a need for therapeutic review. The

prescription of anxiolytic / sedative / hypnotic may lead to negative consequences. Prescription simplification is now a clear priority. We propose implementing strategies such as the more frequent review of the medication, education of the patient and caregiver and the application of the Beers' criteria and STOPP / START. This will help to differentiate drugs with low efficiency and high risk from those essential and safe for our elderly patients.

Keywords: Polypharmacy, Elderly, Anxiolytic/Sedative/Hypnotic drugs

polypharmacy



USF Servir Saúde



P-0515

Statins in primary prevention: what data and issues for patients aged 75 and older?

Jean Philippe Joseph¹, Mélanie Afonso¹, Fabrice Bonnet², Bernard Gay¹

¹General Practice Department, Bordeaux University, Bordeaux, France

²Saint André Hospital, Bordeaux, France

Background and AIM: High cholesterol is a risk factor for cardiovascular diseases. Statin prescription in primary prevention reduces these events from 20 to 30% and mortality from 10% in large randomized trials. The question was to know if these results persisted for the patients taking statin after 75 years old.

METHOD: Methodic review of large randomized trials and meta-analyses which included patients of age 75 and older treated with statin in primary prevention. Data base: Medline.

RESULTS: A score of randomized controlled trials studying statins versus placebo in primary prevention were published and analysed in meta-analyses. Despite the power of these studies, some limits may be raised. The inclusion criteria were usually restrictive and age 70 and older is often an exclusion criterion. Furthermore, the impact on mortality has not been demonstrated in elderly. Recent meta-analysis of observational studies including subjects between 70 and 89 years old treated with statins found that low total cholesterol was associated with a moderate decrease in cardiovascular mortality but no reduction in all-cause mortality. The cardiovascular mortality in the elderly involves multiple causes of death and the role of statins is much less clear than in the under aged. In addition, in a common context of polypharmacy, statins may be responsible for numerous side effects, drug interactions and impaired quality of life.

CONCLUSIONS: Given the lack of formal evidence of effectiveness, the benefit / risk balance of primary prevention with statins is not established in the elderly. The SITE study (Statins In The Elderly), which recently started with public french funding, will attempt to answer this question by a multicentre randomized trial. Its endpoint will be to assess the impact in real life, of the statin cessation in patients after 75 years old treated in primary prevention.

Keywords: statin, primary prevention, elderly

Table 1: Clinical randomized controlled trials comparing statins versus placebo on patients 75 and older.

Clinical Trials	Number of participants	Type of Intervention	Target Population (Average)	Follow-up Time (Average)	Relative Risk of CVE (CI 95%)	Absolute Risk Reduction of CVE	Relative Risk of all causes deaths (CI 95%)
PROSPER (2002)	5804	Pravastatine 40 vs placebo	70 à 82 y/o (75,3)	3,2 years	0,85 (0,74-0,97)	2,10%	0,97 (0,83-1,14)
CARDS (2004)	1129	Atorvastatine 10 vs placebo	65 à 75 y/o (69)	3,9 years	0,62 (0,42-0,92)	3,90%	0,78 (0,51-1,18)
JUPITER (2008)	17802	Rosuvastatine 20 vs placebo	50 à 97 y/o (66)	1,9 year (max. 5years)	0,56 (0,46-0,69)	1,25%	0,80 (0,67-0,97))
JUPITER Subgroup Analysis (2010)	5695	Rosuvastatine 20 vs placebo	70 à 97 y/o (74)	1,9 year (max. 5years)	0,61 (0,46-0,82)	0,77%	0,80 (0,62-1,04)
ASCOT-LLA Subgroup Analysis (2011)	4445	Atorvastatine 10 vs placebo	>65 y/o (71,1)	3,3 years	0,63 (0,44-0,89)	1,40%	0,98 (0,77-1,23)

CVE: Cardiovascular Events

P-0516

Orthostatic Hypotension in Older Adults in nursing home: prevalence and impact of a routine assessment

Gerard Nguyen¹, Domiique Le Moul¹, Yusuf Kocan², Nicodeme Ntambwe², Sok Naye Neam², Helene Quesnot², Zurbach Jacques²

¹Primary Care, Cabinet Marcel Monny Lobe, Soisy sous Montmorency, France

²Les Jardins d'Iroise, Epinay sur Seine, France

Orthostatic hypotension is a frequent cause of generalized cerebral hypoperfusion leading to dizziness, syncope and falls in older subjects at home and in institution like nursing home. Many recommendations of good practice have included the detection of orthostatic hypotension as a routine procedure. There is a gap between recommendations and routine practice and less data existed to show the prevalence in nursing home. We performed a routine determination of orthostatic in nursing home under the supervision of family physicians. Blood pressure measurements were obtained by nurses with the 76 subjects under supine position and after they had been standing for 3 minutes. The prevalence of asymptomatic orthostatic hypertension defined as 20 mmHg or greater decrease in systolic or 10 mmHg or greater decrease in diastolic blood pressure was 11.8% (9/76). Two patients had both systolic and diastolic BP decrease, 4 had only systolic BP decrease and 3 had only diastolic BP decrease. Five had a treatment by antidepressive drugs, 3 had only antihypertensive drugs and one had both treatments. Multivariate analysis was done to show some interrelation between orthostatic hypotension, decrease of daily activity, comorbidity, age and weight. Our routine assessment of orthostatic hypotension succeeded to raise an awareness on drug use: high dose of antihypertensive drugs, association of antidepressive drugs and overall association with hypnotic drugs in all patients, increasing the risk of falls. Our prevalence is in accordance with others published elsewhere in older populations and in other settings. Figures in nursing homes are lacking. Performing routinely on a basis of a monthly assessment is a best practice in nursing home to detect orthostatic hypotension allowing a re-evaluation of drug prescriptions, a fall prevention follow up and a caregivers continuous training, care follow up awareness procedure and team work.

Keywords: orthostatic hypotension, older persons, blood pressure measurements

P-0517

Detection of Apathy in Older Persons in Nursing Home: Routine use of NPI (Neuro Psychiatric Inventory) Questionnaire and impact in care framework

Gerard Nguyen¹, Charlotte Haignere², Stephanie Blanc², Catherine Maffon², Laetitia Sarteur²

¹Primary care, Cabinet Marcel Monny Lobe, Soisy sous Montmorency, France

²Residence ARPAGE Jacques Offenbach, ARPAD Epinay sur Seine, France

Apathy is increasingly recognised as a frequent behavioural problem in Older Persons with Dementia. It should be detected systematically. Overlap with depression has been widely described and might explain the large variation of prevalence related. Validated tool as NPI (Neuro Psychiatric Inventory) scale could be used routinely. We performed NPI in all of our 53 patients (mean age of 87 yo, 50 women) in nursing home. Forty one (77,35%) have Dementia. We used the recommended tool NPI assed by carers (NPI-ES), added with the Apathy Inventory scale. Apathy represented 30.19% (16/53) of all patients and 24.40% (10/41) of Dementia. Among those with Dementia and Apathy, 43.75 % (7/16) have associated depression. Only 3/7 were under antidepressant drugs and 25.00% (4/16) had anticholinesterase agents. One patient had associated Parkinson symptoms and treatment. Associated factors have been determined with multivariate analysis. Overlap between apathy and depression has been discussed with physicians.

The most important findings were that the use of scale routinely was feasible and accurate. An audit confirmed the results.

The routine use of appropriate, validated, recommended and easy to use psychometric scales as NPI in Older Persons and has allowed a change of practice by programming more non pharmacologic (cognitive stimulation approaches, balneotherapy, stimulation games), by increasing an awareness among carers to detect alert symptoms, by making some differences with depression, by re-discussing the indication of pharmacologic agents

and by proposing an re-organisation of care in Nursing Home. The non pharmacologic methods (multiple stimulation methods) have to be preferred. From the results we would recommend the use of NPI in ambulatory practice and in nursing home in a routine geriatric assessment and also in a risk management plan to decrease iatrogeny.

Keywords: Apathy, NPI, Geriatric care, Older Persons, Dementia

P-0518

Pruritus in the elderly: A transversal epidemiological study

Susana Sanchez Ramon¹, Rosa María Giménez García², Juan Carlos Martín Escudero³, Raquel Gómez Bravo⁷, Marta Moya De La Calle¹, Rosa María Ibán Ochoa¹, Pedro Luis Hernansanz Caviedes¹, Carmen Fernández Alonso⁴, Yolanda Valpuesta Martín⁵, Mar De La Torre Carpena⁸, Susana Manso García⁹, Sonia Herrero Velázquez⁶

¹Emergency Department; Río Hortega University Hospital. Valladolid. Spain

²Dermatology Department; Río Hortega University Hospital. Valladolid. Spain

³Internal Medicine Department; Río Hortega University Hospital. Valladolid. Spain

⁴Servicios Centrales. Gerencia Regional de Salud, Junta de Castilla y León. Spain.

⁵Peñafile Health Center; Río Hortega University Hospital. Valladolid. Spain

⁶Neurology Department; Río Hortega University Hospital. Valladolid. Spain

⁷SEMFYC. Spain

⁸Cardiology Department; Río Hortega University Hospital. Valladolid. Spain

⁹Radiology Department; Río Hortega University Hospital. Valladolid. Spain

INTRODUCTION:

Pruritus can be defined as an unpleasant cutaneous sensation that leads to a desire to scratch. The subjective component is essential in its assessment. In some cases, a primary dermatosis is involved, or there is an underlying systemic disorder, but often no cause can be found. At least 29 % of the elderly have this symptom. Objective: To determine the incidence of pruritus in a sample of elderly dermatology outpatients consultation.

Material y METHODS:

Subjects Patients over 60 years that came into the dermatology consultation for the first time.

Type of study: transversal descriptive study

Measurements and interventions: Personal history, concomitant diseases, hygiene habits, sun exposure, use of sunscreens, presence of pruritus, dermatological diagnosis, medications were collected.

RESULTS:

306 patients: 169 women and 137 men. Average age: 72 + 7.3 (60-92 years). 54% (n = 165) of the patients recognized that have been suffering pruritus, in 29% of the patient, the itching increased at night and in 48% the itching increased with the heat. There were no significant differences related to gender and age. 75.8% did not hydrate the skin regularly. 87.3% did not perform photoprotection. 30.9% had a daily shower and 29.7% had it 2-3 days a week. The 35.56% have pruritus widely. 20% of cases are associated eczematous dermatoses found in a seborrheic dermatitis 6%, in 7% of the cases associated to urticaria and in 25% with xerosis.

CONCLUSIONS:

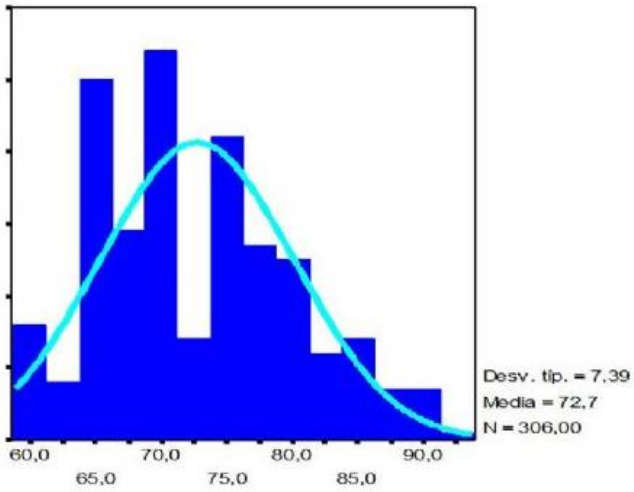
Pruritus is a frequent complaint in the population over 60 years so it is necessary to rule out a possible association with dermatological or allergic disease

Pruritus sine materia or associated with xerosis and / or dermatitis could be related to hygiene or inadequate hydration

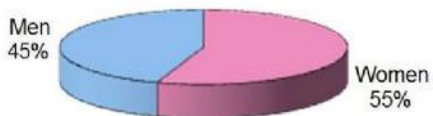
The correct and early management of these symptoms can help to prevent the development of future complications like eczema, allergic or infectious type.

Keywords: pruritus, elderly, cutaneous diseases

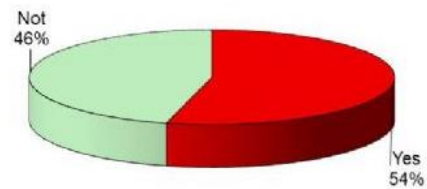
Age



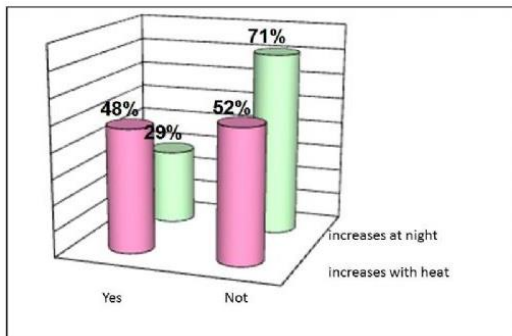
Distribution by sex



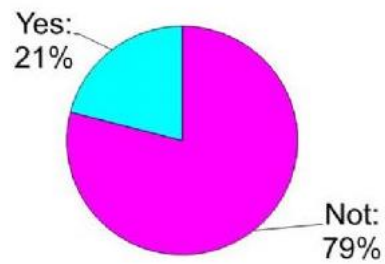
Patients suffering from pruritus



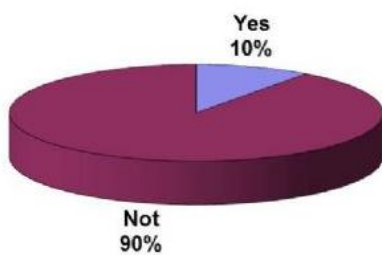
Causes increased pruritus



Skin hydration



Photoprotection of the skin



P-0519

Effect of Obesity on Cognitive Functions of Individuals Aged 65 And Above

Kübra Uyar¹, Mehtap Kartal¹, Nil Tekin²

¹Dokuz Eylul University Faculty of Medicine, Family Medicine Department, Izmir, Turkey

²Narlıdere Geriatric Care Center and Residential Home, Izmir, Turkey

AIM: Cognitive functions are one of the most important factors effecting quality of life of elderly. Pharmaceuticals stop only progression of dementia so primary prevention issues become more important. Nowadays, some studies indicate that obesity can affect cognitive functions. It is aimed to study the relationship between obesity and cognitive functions among elderly aged 65 and above.

METHODS: This case-control study included 390 elderly (128 cases having mild cognitive impairment-MCI and 262 controls without cognitive impairment) living in Narlıdere Geriatric Care Center and Residential Home, Izmir, between April 2014-January 2015. Elderly weight, height and waist circumference was measured and recorded, and a questionnaire prepared by the researcher in addition to Mini Mental State Examination, Stroop Test, WMS-5 digitspan test, three words-three shapes test, geriatric depression scale, activities of daily living test and instrumental activities of daily living test were applied face to face.

RESULTS: When compared cases were found older (79.49 ± 7.06) than controls (76.25 ± 7.38) ($p < 0.001$). Cases had more impairment in simple attention ($p < 0.001$), longer total time and color word interference on stroop test ($p < 0.001$), less identification information previously learned (recall) ($p < 0.001$) than cases. Obesity history in the past was significantly higher in cases compared to controls ($p < 0.001$). Multiple logistic regression analysis was done to adjust for age, gender, time period in institution, current body mass index and waist circumference, obesity history and showed that age 85 and above had about 3.9 (95%CI: 1,5-10,3) fold ($p = 0.005$) and positive obesity history had about 9,1 (95%CI: 5.2-15.9) fold ($p < 0.001$) higher probability of MCI.

CONCLUSION: Today, as the prevalence of dementia is increasing it is important to show facilitating factors that reveals MCI and dementia for both elderly and their caregivers. Primary care physicians evaluating obese patients should take precautions not only for its cardiovascular complications but also for maintenance of cognitive functions.

Keywords: obesity, cognitive functions, age 65

Table 1: Comparison of cases and controls according to body mass index and waist circumference

	Case		Control		p value	
	N	%	n	%		
Body Mass Index	18,5-24,9	13	12,1	22	10,6	0,876
	25-29,9	61	57	124	59,6	
	30 and above	62	30,8	33	29,8	
Waist Circumference	Normal	39	36,4	90	43,3	0,244
	Central Obesity	68	63,6	118	56,7	
Obesity history	yes	71	66,4	37	17,8	<0,001
	no	36	33,6	171	82,2	

Table 2: Comparison of case and control groups according to history of obesity

			95% Confidence Interval		p values
Age groups (years)	65-69	reference			
	70-74	1.171	0.444	3.090	0.749
	75-79	1.974	0.727	5.362	0.182
	80-84	2.101	0.840	5.255	0.112
	85 and above	3.953	1.522	10.269	0.005
Obesity history	No	reference			
	Yes	9.150	5.255	15.931	<0.001

P-0520

Vitamin D and cognitive function in elderly – what’s the atual evidence?

Sara Magalhães¹, Ana Filipa Couto², Frederico Abreu³, Helena Ribeiro⁴, Maria João Abreu⁵, Nuno Namora⁵, Teresa Martins⁴

¹Department of USF Ponte, Guimarães, Portugal

²USF S. Miguel-o-Anjo, Famalicão, Portugal

³USF Alpendorada, Marco de Canaveses, Portugal

⁴USF Novos Rumos, Vizela, Portugal

⁵USF DuoVida, Guimarães, Portugal

BACKGROUND & AIM: Worldwide, the prevalence of vitamin D deficiency is estimated to be high in some populations of risk such as the elderly. In Portugal, the limited studies published about the vitamin D deficiency, estimates a 93% prevalence.

Despite the recommendations of American Guidelines, in Portugal there isn’t a screening program for vitamin D deficiency on risk populations.

The possible consequences of vitamin D are well established such as disturbances of calcium metabolism, autoimmune diseases, and neoplastic, infectious and cardiovascular diseases. Lately there have been some studies relating vitamin levels with cognitive activity, whose deficits could have important consequences on the quality of life of vulnerable groups.

This study aim was to review the current evidence on the relationship between levels of 25-hydroxyvitamin D and cognitive function.

METHODS: It was performed a literature search on MEDLINE databases of articles published in the last five years, using the MESH terms: "cognition", "aged" and "vitamin D", at January 2015.

RESULTS: The search resulted on 35 articles of which nine were studied further (one randomized controlled trial, five cohort studies, two cross-sectional studies and one review).

DISCUSSION /CONCLUSION: Despite the heterogeneity of the studies, the majority is on agreement that deficit levels of vitamin D are associated with cognitive impairment with a level evidence of 2 (SORT B). However, we need more randomized controlled trials verifying a causal relationship between vitamin D deficits and cognitive disability. The recommendations for screening and benefits of supplementation are not still established.

Keywords: Mesh words: cognition, aged and vitamin D.

Results

Reference	Sample size	Results	Conclusions	Evidence level
Wilson et al, 2014 ⁸	2777	<ul style="list-style-type: none"> • 68 % 25 (OH) D < 30.0 ng / mL • Low levels of 25 (OH) D associated with lower scores on MMSE (P = 0.02) and DSST (p = 0.01) at baseline • Low levels of 25 (OH) D associated with cognitive decline at age 4 in MMSE (p = 0.05) • No significant differences (p = 0.22) between the levels of 25 (OH) D and cognitive decline after 4 years of follow-up in the DSST 	<ul style="list-style-type: none"> • The possibility of confounding variables were not taken into account 	2
Lepid et al. 2012 ⁹	141	<ul style="list-style-type: none"> • No association between MMSE results and Vitamin D levels • No association between levels of vitamin D and psychiatric diagnoses 	<ul style="list-style-type: none"> • retrospective Study • Geographical Limitation • Diversification racial / ethnic • small sample 	2
Peterson et al, 2012 ⁹	159	<ul style="list-style-type: none"> • Patients with falls had Vitamin D values significantly lower • Lack of association between levels of vitamin D and motor functions • A significant correlation between levels of vitamin D and MMSE results 	<ul style="list-style-type: none"> • Cross-sectional study : the cause-effect mechanism cannot be determined 	2
Silvio et al, 2012 ¹¹	6257	<ul style="list-style-type: none"> • Older women with very low levels of 25 (OH) D had an increased risk of cognitive impairment OR = 1.60 (1.05 to 2.42) . • Compared with ≥30 ng / ml levels , lower levels of 25 (OH) D were related to an increased risk of global decline of cognitive function : OR = 1.58 (1.12 to 2.22) to 25 (OH) D <10 ng / ml; OR = 1.31 (1.04-1.64) to 25 (OH) D 10-19.90 ng / ml; OR = 1.13 (0.91-1.41) to 25 (OH) D 20-29.90 ng / ml . • No association between the levels of 25 (OH) D and executive function 	<ul style="list-style-type: none"> • Population: composed only of women • Measurement of isolated levels of 25 (OH)D • It is not possible to establish a causal relationship 	2
Llewellyn et al, 2010 ¹³	858	<ul style="list-style-type: none"> • Low levels of 25 (OH) D in the elderly are associated with an increased risk of cognitive decline. • This association remained statistically significant after adjusting for potential confounding variables 	<ul style="list-style-type: none"> • Study confined to a geographical area • A study carried out only European population 	2
Skalska et al, 2012 ¹²	140	<ul style="list-style-type: none"> • Only 18.8 % (n = 26) of the elderly population had levels of 25 (OH) D great (> 75 nmol / l) • The performance of muscle strength, functional performance and cognitive function linearly increases to levels of 25 (OH) D > 47.75 nmol / l • Levels of 25 (OH) D influenced not only the activity as well as cognitive performance in other functional areas. 	<ul style="list-style-type: none"> • Reduced sample size • Predominance of women (66.7%) • Presence of multiple comorbidities 	2
Mccost et al 2012 ¹³	463	<ul style="list-style-type: none"> • Serum 25 (OH) D nmol / mL are associated with worse executive function and visuospatial ability. • These results highlight the relationship between disability 25 (OH) D and impaired physiological and neuropsychological function in older people. 	<ul style="list-style-type: none"> • Healthy Participants • Participants with regular physical activity and sun exposure • Cross-sectional study 	2

[25(OH)D - 25-hydroxyvitamin-D;DSST - Digit Symbol Substitution Test; **MMSE** - modified Mini-Mental State Examination;

P-0521

Epidemiology of Hip Fracture in the Elderly in Castile and Leon (Spain)

Rosario Martinez Fuerte¹, Leticia Sierra Martínez¹, Iker Sierra Martínez², Natalia Sanz González³

¹Valladolid Este Primary Assistance Gerency, Sacyl Castile and Leon, Valladolid, Spain

²Traumatology Department, Hospital of Medina del Campo (Valladolid), Spain

³Parquesol Senior Center, JCyL Social Serices Gerency, Valladolid, Spain

AIMS:

Using the records of the Medical Record Informatics (MRI) to determine the prevalence of Fracture of the Hip fracture (HF) in patients with osteoporosis (OP) to promote preventive activities from Primary Care physician and. Specialist in Orthopaedic Surgery and Traumatology

DESIGN:.

Most HF occur in elderly patients with OP, consuming significant resources, health, social and economic in the process of diagnosis and treatment. The authors conducted a descriptive cross-sectional study of patients with HF in patients with OP record in the MRI of the urban health center in Castile and Leon (Spain).

METHOD: From the list of selected patients with MRI 753 with a diagnosis of OP, we studied the OP prevalence and Epidemiology HF. We analyzed the causes of the fracture. The data is collected on an Excel spreadsheet and analyzed using SPSS 9.0 for Windows.

RESULTS:

-Patients with OP in our health center corresponds to 20% of the population over 50 years.

-Of the 753 patients with OP: 687 women and 66 men. Ratio of woman OP/men OP:10/1.

-Of the 687 women with MRI in the diagnosis of OP:35 cases of HF. Women OP-HF:Prevalence:5,09%

-Of the 66 men with MRI in the diagnosis of OP: 2 case of HF. Men OP- HF prevalence: 3 %

-Falls at home was the cause in 84% of cases. For defects of vision, collision with obstacles and falls from ladders.

CONCLUSIONS:

20% of the population over 50 years of our health center, has recorded in his MRI OP the clinical process, with Ratio of womanOP /menOP:10/1

and OP-FIR Prevalence of woman / men 2 /1, which justifying the implementation of a Health Improvement Plan, including Education Program for Health aimed at groups and the development of preventive activities in Primary Care consultation and Specialist in Orthopaedic Surgery and Traumatology

Keywords: Elderly; osteoporosis; Hip fracture.

P-0522

The Importance of Cognitive Impairment Screening for elderly People in Community

Nita Arisanti, Elsa Pudji Setiawati

Department of Public Health, Faculty of Medicine, Universitas Padjadjaran

Background

During recent decades, the world population entered a process of aging. With the elderly population in lower and middle-income countries predicted to increase from 60% in 2001 to 71% by 2040, many problems rise in the elderly population. One of the health problems is cognitive impairment. Primary care clinicians may fail to recognize cognitive impairment during clinic visits using routine history and physical examination. About 29 to 76 percent of patients with cognitive impairment are not diagnosed by primary care physicians. The objective of this study was to identify the number of cognitive impairment in elderly people.

Method

This was cross sectional study involving 272 elderly people in Cianjur Indonesia. The Short Portable Mental Status Questionnaire (SPMQ) was used to collect data and analyzed using Contingency Coefficient.

Results

From a sample of 272 respondents 57% were female with the average age was

67.72 years (SD=9.76). Most of respondent (44.7 %) was categorized as moderate cognitive impairment, 43.6% as mild cognitive impairment and 10% as severe cognitive impairment. There were relationship between age and cognitive impairment ($p<0.05$). The study showed that cognitive impairment was associated with increasing age. As the number of elderly in community is increasing, there should be a program to earlier detect the incidence of cognitive impairment in primary health care and community.

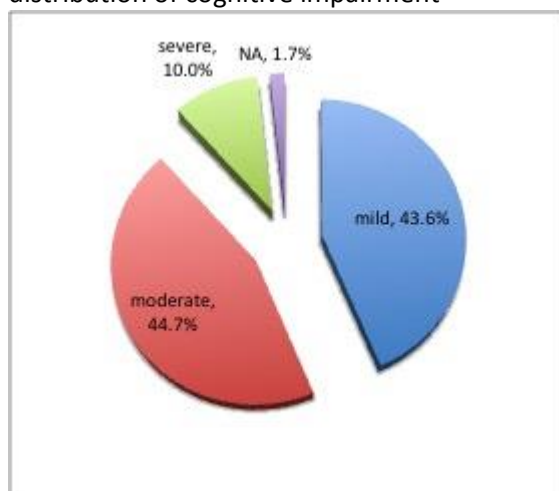
Conclusion

The study shown there was relationship between age and cognitive impairment.

Therefore, screening tests for elderly people may help identify patients with cognitive impairment who are otherwise missed.

Keywords: Cognitive Impairment, Community, Elderly, Screening

distribution of cognitive impairment



One of community health service for elderly in Indonesia



P-0523

Care of the Dying Patient

Çiğdem Gereklioğlu¹, Süheyl Asma¹, Kenan Topal², Aslı Korur¹

¹Baskent University Medical Faculty, Department of Family Medicine, Ankara/Turkey

²Adana Numune Training and Research Hospital, Department of Family Medicine, Adana/Turkey

BACKGROUND: Some diseases continue to be fatal despite the advancements in medicine. Fatal diseases are challenging for the patient, family and health staff. The aim of the end of life care is to improve quality of life, relieve pain, enable the patient be independent as possible, die with dignity and support family members.

MATERIAL-METHOD: Hospice action provides routine home care of the patients, routine home visits, nursing services and hospitalization when required. In recent years, home care services has developed in our country although hospice care is not a routine part of terminal care. Family physicians are an important part of home care. Maintenance of care through home visits should be essential in primary care of which biopsychosocial approach is

the main principle.

RESULTS: Today, the patient is examined as a whole in patient-centered clinical method which is developed by adaptation of biopsychosocial method to clinical practice, the patient is addressed with his/her living conditions, problems, family, physical environment and psychological problems and the problems are perceived with the patient's point of view. Priorities and the roles are determined together with the patient, the conception of making the best decision leaves its place to making a decision together with the patient.

CONCLUSION: Nausea, vomiting, pain, fatigue, emotional disorders, febrile neutropenia, nutritional problems are the main problems in terminal period. The patient and the family should be involved in important decisions. Spiritual needs of the patient and the family should also be met. We want to emphasize the key role of the family physicians in terminal care.

Keywords: Terminal Care, Patient-Centered Care, Family Practice

P-0524

Evaluation and management of vertebral compression fractures in Castile and Leon (Spain)

Iker Sierra Martinez¹, Leticia Sierra Martinez², Rosario Martinez Fuerte², Natalia Sanz Gonzalez³

¹Traumatology Department, Hospital of Medina de Campo (Valladolid), Spain

²Valladolid Este Primary Assistance Gerency, Valladolid

³Parquesol Senior Center, JCyL Social Serices Gerency, Valladolid, Spain

AIMS:

Using the records of the Medical Record Informatics (MRI) to determine the prevalence of Vertebral Compression Fractures (VCFs) in patients with osteoporosis (OP) to promote preventive activities from Primary Care physician and. Specialist in Orthopaedic Surgery and Traumatology

DESIGN:

Most VCFs occur in elderly patients with OP, consuming significant resources, health, social and economic in the process of diagnosis and treatment. The authors conducted a descriptive cross-sectional study of patients with HF in patients with OP record in the MRI of the urban health center in Castile and Leon (Spain).

METHOD: From the list of selected patients with MRI 152 with a diagnosis of OP, we studied the VCFs prevalence. We analyzed the Association of OP and VCFs by age. The data is collected on an Excel spreadsheet and analyzed using SPSS 9.0 for Windows.

RESULTS:

-Of the 152 patients with OP:136 women and 16 men.Ratio of womenOP/menOP:8,5/1 1.

-Of the 136 women with MRI in the diagnosis of OP:9 cases VCFs:

Women OP-VCFs-Prevalence:6,6%

-Of the 16 men with MRI in the diagnosis of OP:1case VCFs.

Men OP-VCFs-Prevalence:6,2%.

-Association of OP and VCFs by age:

.In women:

- 90-100:3OP(2.2%),1VCFs(0.7%).

-80-90:47OP(34.5%),2VCFs(1.7%).

-70-80:39OP(28.7%),2VCFs(1.7%).

-60-70:36 OP(26.5%),4VCFs(3.4%).

-50-60:11OP(8 %),2VCFs(1.7%).

-In men:

- 90-100:2OP(12.5%) y 1VCFs(6.25%).

-80-90:6OP(37.5%) y 0VCFs(0%).

-70-80:6OP(37.5%) y 0VCFs(0%).

-60-70:1OP(6.25%) y 0VCFs(0%).

-50-60:1OP (6.25 %) y 0VCFs(0%).

CONCLUSIONS:

Although the ratio of prevalence of OP woman / man is 8.5 / 1, the incidence of VCFs is very similar in men and

women around 6%. The age group with the highest prevalence of osteoporosis is found between 70 and 90 years. Which justifying the implementation of a Health Improvement Plan, including Education Program for Health aimed at groups and the development of preventive activities in Primary Care consultation and Specialist in Orthopaedic Surgery and Traumatology

Keywords: Osteoporosis; Vertebral Compression Fractures; Preventive activities.

P-0525

Evaluation of burden and related factors in care givers of home care patients

Tanyel Sema Dağdeviren, Nevgül Demir, Didem Sunay

Department of Family Medicine, Kecioren Training and Research Hospital, Ankara, Turkey

BACKGROUND: In our country care of people in need of nursing is generally given by a member of the family. In this study we aimed to assess the burden and related factors in care givers of patients registered by home care service.

METHODS: The care givers of patients registered by home care service of a training and research hospital were included in this cross-sectional study. A questionnaire was used to assess socio-demographic and clinical characteristics of patients and care givers and Zarit care giver burden inventory to assess burden.

RESULTS: A total of 80 care givers were included, 85% were women, 63.7% were between 35-64 years of age, 73.8 were married, 67.5% were housewife, monthly income was less than expense in 60%, 76.3% were living with their family, 7.5% with the patient, 63.7% were the only one who gives care, 36.3% were the daughters of the patients. Mean age of the patients was 77 years, 63.7% of the patients were women, 53.8 % were bedridden, 67.5% of them had dementia. Most difficult issue in care giving was the bath of patient. 51.2% of care givers were noted that they gave care because of family responsibilities. While 86.3% of care givers were satisfied with the care they give, 56.3% need training and consultancy about care giving. Care givers' burden (CB) according to Zarit inventory was high in 43.8%, very high in 2.5% of the participants. Of those who had high CB 74.3% were noted that they gave care because there was no one to take the care of the patient. All of the care givers who had high CB were using anti depressants and felt burnout.

CONCLUSION: CB is a complex issue that is associated with several patients' and caregivers' factors. Supportive care needs to be sought to alleviate CB.

Keywords: care giver, burden, home care service

Face to face interview with care givers



Significantly associated factors with care giver burden

		Care Giver Burden Scores										p
		Absent to mild		moderate		High		Excessive		Total		
		n	%	n	%	n	%	n	%	n	%	
Using antidepressant pills	No	7	87,5	29	82,9	18	51,4	0	0	54	67,5	0,019
	Yes	1	12,5	4	11,4	15	42,9	2	100	22	27,5	
	Used before	0	0	2	5,7	2	5,7	0	0	4	5,0	
	Total	8	100	35	100	35	100	2	100	80	100	
Quality of sleeping	Well	3	37,5	12	34,3	2	5,7	0	0	17	21,3	0,011
	Moderate	4	50,0	16	45,7	20	57,1	0	0	40	50,0	
	Bad	1	12,5	7	20,0	13	37,1	2	100,0	23	28,7	
	Total	8	100	35	100	35	100	2	100	80	100	
Using sleeping pills	Yes	0	0	1	2,9	10	28,6	1	50	12	15,0	0,05
	No	8	100	34	97,1	24	68,6	1	50	67	83,8	
	Used before	0	0	0	0	1	2,9	1	50	1	1,3	
	Total	8	100	35	100	35	100	2	100	80	100	
Burnout	No	4	50	10	28,6	0	0	0	0	14	17,5	0,001
	Yes	0	0	7	20	24	68,6	2	100	33	41,3	
	Sometimes	4	50	18	51,4	11	31,4	0	0	33	41,3	
	Total	8	100	35	100	35	100	2	100	80	100	
Feeling desperate	No	5	62,5	10	28,6	1	2,9	0	0	16	20	0,001
	Yes	0	0	9	25,7	24	68,6	2	100	35	43,8	
	Sometimes	3	37,5	16	45,7	10	28,6	0	0	29	36,3	
	Total	8	100	35	100	35	100	2	100	80	100	
Communication problem with patient	No	8	100	13	37,1	7	20	0	0	28	35	0,001
	Yes	0	0	16	45,7	16	45,7	2	100	34	42,5	
	Sometimes	0	0	6	17,1	12	34,3	0	0	18	22,5	
	Total	8	100	35	100	35	100	2	100	80	100	
Only one who gives care	No	4	50	17	48,6	7	20	1	50	29	36,3	0,054
	Yes	4	50	18	51,4	28	80	1	50	51	63,7	
	Total	8	100	35	100	35	100	2	100	80	100	

P-0526

Depression in Parkinson Disease – a review

Renata Almeida¹, Joana Silva², Ana Rita Ferreira³, Joana L. Gonçalves¹

¹USF São Julião, Portugal, Figueira da Foz, Portugal

²Hospital de Magalhães Lemos, Oporto, Portugal

³USF Santiago, Leiria, Portugal

INTRODUCTION: Parkinson Disease (PD) is the second most frequent neurodegenerative disease worldwide. Non-motor symptoms in DP are getting more recognised, like depression, since they have a significant impact in patients' quality of life.

OBJECTIVES: The authors aim to review and summarize the latest literature about depression symptoms in PD.

METHODS: Literature review up to 2015, using Pubmed and the keywords depression and Parkinson Disease.

RESULTS: Studies propose that depression occurs in approximately 35% of the patients diagnosed with PD. There are some criteria and scales that may help professionals in the diagnosis and follow-up of this disease, such as Hamilton Depression Rating Scale.

Antidepressive therapy in PD has some particulars, and there are a variety of medications that can be used like tricyclics antidepressants, serotonin reuptake inhibitors, serotonin and norepinephrine reuptake inhibitors and also dopamine agonists like rasagiline. Electroconvulsive therapy and transcranial magnetic stimulation are also options.

DISCUSSION: Depression in PD is becoming a more and more recognised entity, however there are still some questions because of the overlapped existing between this two syndromes. There are some latest developments showing that rasagiline in association with a SSRI, may bring benefit for patients, despite of this, further studies are needed in order to give this patients a better quality of life.

Keywords: Depression, Parkinson Disease

Depression in Parkinson Disease



P-0527

Three factors are predictive of unrecognized atrial fibrillation. Study in primary care on a cohort of 4592 patients

Marie Catherine Reboul¹, Jean Marc Davy², Philippe Lambert¹

¹Department of General Medicine, University of Medicine, Montpellier, France

²Department of Cardiology, University Hospital, Montpellier, France

AIM:

To isolate predictive factors of atrial fibrillation (AF) in patients over 65 years old consulting in general medicine.

METHOD:

The study called PROFIL-FA was quantitative, multi-center study conducted in 2013 in general medicine practices in France in 16 territories and 13 regions, including 603 general practitioners and 4592 patients.

The patients included were 65 years old or over, with or without a known AF, whatever the reason of consulting. Taking the radial pulse was systematic.

1) The presence of one or more symptoms from a list of four AF-like symptoms (Palpitations, Episodes of faintness-weakness, Unexplained chest pain, Shortness of breath on exertion or at rest) led to the questionnaire CHA2DS2-VASc.

2) If the presence of an irregular heartbeat or positivity at the CHA2DS2-VASc questionnaire, the patient was sent to a cardiologist.

The results were analyzed using a logistic regression model with predictive evaluation by ROC curve.

RESULTS:

Of the 4592 patients enrolled, 585 were referred to a cardiologist where 129 (3.4%) unknown AF were newly diagnosed.

The main predictive factor of AF was unknown irregular heartbeat (sensitivity 74.2%, specificity 81.9%, OR = 12.0, $p < 0.0001$). Its positive predictive value remained however low (55.6%).

The presence of palpitations ($p = 0.0023$) or episodes of faintness-weakness ($p = 0.0129$) were the two other predictive factors.

CONCLUSION:

The study isolated three predictive factors of unknown AF in over 65 year old patients in general medicine practice. The systematic search of an irregular pulse is a major predictive factor but is not sufficient. It has to be associated with the search for episodes of palpitations or fainting, especially in patients with a cardiovascular medical history. This systematization would, in a quick and simple way, improve detection of unknown AF in general medicine practice.

Keywords: atrial fibrillation, risk factors, family practice, geriatrics, cardiology, diagnosis

Diagnosis of unknown AF and sending to a cardiologist

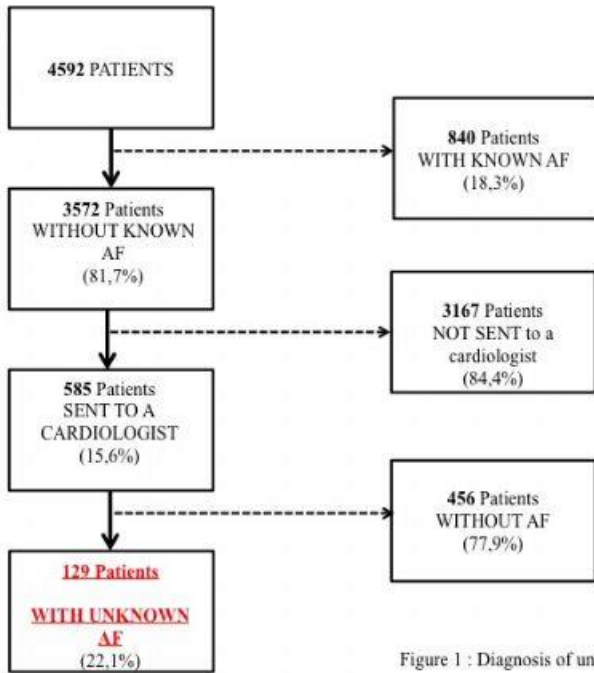


Figure 1 : Diagnosis of unknown AF and sending to a cardiologist

129 patients with unknown AF was diagnosed

P-0528

The Knowledge, Attitude, And Behaviors Regarding Organ Donation Among Individuals Aged Over 60

Hamit Sırrı Keten¹, Hüseyin Üçer², Derya Keten³, Oğuz Işık², Fatış Yıldırım²

¹Department of Family Medicine, Kurtul Family Health Center, Kahramanmaraş, Turkey

²Department of Family Medicine, Medical Faculty, Kahramanmaraş Sutcu Imam University, Kahramanmaraş, Turkey

³Department of Clinical Microbiology and Infectious Diseases, Necip Fazil City Hospital Kahramanmaraş, Turkey

BACKGROUND: In this study, we aimed to determine the knowledge, attitude, and behaviors of individuals aged over 60 about organ donation.

METHOD: This study was conducted in Kahramanmaraş, a province in the southern Turkey. A total of 124 individuals aged over 60, applying to polyclinics of Kahramanmaraş Sütçü Imam Üniversitesi Faculty of Medicine between 01.10.2014-31.12.2014, were enrolled in the study. A survey on sociodemographic characteristics, and the knowledge, attitude and behaviors about organ donation was performed to all participants.

RESULTS: Ninety three (75%) of the participants were male, while 31 (25%) were female. The mean age was 69.42±6.11 (min=60, max=87). Thirty patients (24.2 %) stated that they were sufficiently knowledgeable about organ donation and transplantation. Fourteen patients (11.3%) noted they knew where to apply for organ donation while 110 patients (88.7%) noted they did not. Only 1 (0.8%) patient had applied for organ donation and had an organ donor card while 123 patients (99.2%) did not. Thirty seven (29.8%) participants remarked that they desired to donate their organs. Sixty one (49.2%) patients indicated that positive fatwa of the reverend would be effective to increase organ donation, while 53 patients (42.7%) told that activities of health professionals would be helpful, and 22 patients (17.7%) stated media support would be beneficial.

CONCLUSIONS: We revealed that individuals over age of 60 lacked information

regarding organ donation. Furthermore, it was observed that the willing to donate organs or to apply for this purpose was low among participants.

Keywords: Organ donation, knowledge, elderly

P-0529

Evaluation of knowledge and attitudes about the elderly in aged care staff caring for older people, in Antalya Metropolitan Municipality

Ethem Kavukcu¹, Betül Moral², [Melahat Akdeniz](#)³

¹Department of Sports Medicine, Akdeniz University, Antalya, Turkey

²Metropolitan Municipality, Antalya, Turkey

³Department of Family Medicine, Akdeniz University, Antalya, Turkey

Gradually aging of the world population created the problems. One of these problems is the question about who is going to deal with the care of handicapped or old people. Today the local authorities and public health departments are trying to solve this problem by setting up home-care units. Local authorities are running disqualified workers under the supervision of a professional medical staff. The staff who cares for elderly patients, may not have enough experience and information about aging and being aged.

Materials and Methods; In this study, the profiles of the people receiving care services from Antalya Metropolitan Municipality are extracted. These people and the ability and needs of care takers of elderly nursing staff who agreed to participate in the study was assessed with a short questionnaire about their knowledge and attitudes.

Findings; 15 of the caretakers (%53) see the elderly patients as unprotected and a burden for both their families and the community. 9 of them (%32) stated that they do not agree with the previous statement. However % 28 think that the problem in communication between the caretaker and the elderly patient is caused of the elderly patient's inability,%32 stated that they disagree with that. %68 of the caretaker (19 person) think that the elderly people have more than one health problem. The rate of the ones who think its hard to satisfy elderly people is %60. The number of people who doubts if the investment on the elderly people's condition is an investment for the future is 21 (%75).

Conclusion; People who are working as caretaker for elderly patients in Antalya, are not trained in their field and they don't have enough information and qualification in their profession. Family physicians as the elderly patient's defences should be aware that caregivers do not have sufficient knowledge

Keywords: aging, caregiver, knowledge and attitudes

P-0530

Subclinical hypothyroidism - approach in Geriatrics

Mara Matos Dias

Unidade Saúde Familiar Fiães, ACES ENTRE DOURO E VOUGA I - Feira/Arouca, Aveiro, Portugal

Background & AIM:

The study of thyroid function have gained importance in providing health care for the elderly, due to its correlation with physical disability, cognitive function, cardiovascular risk and longevity. Subclinical hypothyroidism is more prevalent in female population, caucasians, iodine-deficient regions, and geriatric population. However, the diagnosis in the elderly is hampered by the absence of specific symptoms, mingling with own manifestations of a physiological aging. The acquisition of skills for right diagnosis of subclinical hypothyroidism, in the geriatric population, is required for the proper treatment plan.

METHOD:

Literature search of systematic reviews and scientific articles from the Pubmed database, Medline, using the MeSH terms: "subclinical hypothyroidism" "subclinical hypothyroidism elderly." The search was restricted to articles published between the period 2004 to 2014, in English.

Results

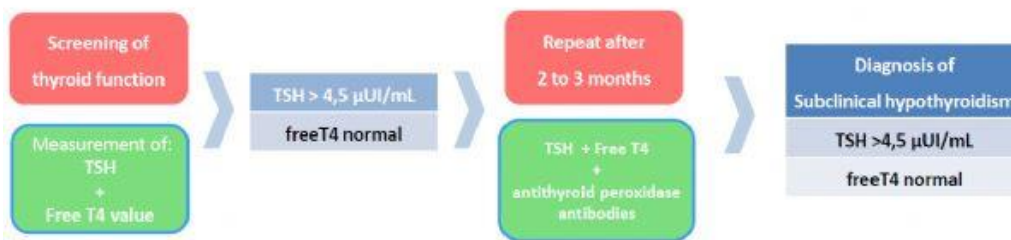
An initial higher TSH value with free T4 values within the reference range needs to be investigated, by repeating the measurements, after 2 to 3 months, together with anti-thyroid peroxidase antibodies. If the elevation of TSH continues with a value of less than 10 $\mu\text{U} / \text{L}$, it should maintain vigilance, repeating the analysis after 6 months. If the TSH assay is greater than or equal to 10 mU / L , treatment with levothyroxine should be considered, only if the patient presents clear signs of hypothyroidism or high cardiovascular risk. TSH values should be reassessed 2 months after initiation of therapy and the drug dosage adjusted according to the results. The target value of TSH should be in the lower half of the reference range (0.4 - 2,5 mU / L). After stabilization of TSH values, monitoring of thyroid function should occur annually.

Conclusions

The treatment of subclinical hypothyroidism remains questionable, therefore a close monitoring of thyroid function could be the best option for patients at high risk of progression to overt disease.

Keywords: hypothyroidism; hypothyroidism in elderly; subclinical hypothyroidism

Screening of thyroid function



Subclinical hypothyroidism in geriatrics

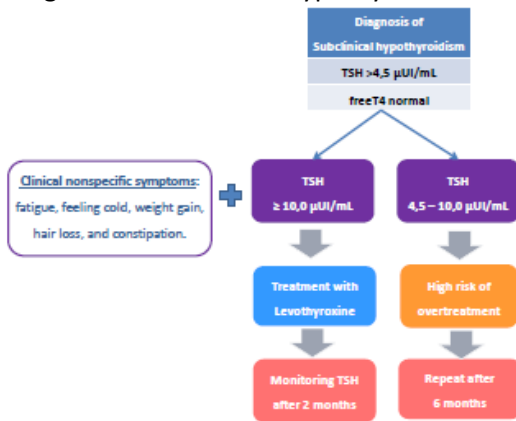


Variability of TSH

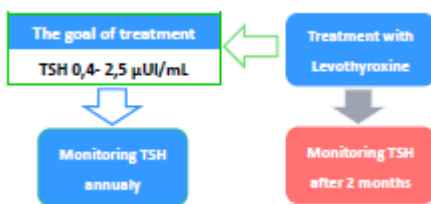
Variability of TSH

- ✓ Between the different sub-populations as defined by race / ethnicity, gender and age;
- ✓ Consumption of drugs or substances, such as iodine, dopamine, or glucocorticoids;
- ✓ Adrenal insufficiency, pregnancy, anorexia nervosa, autoimmune diseases, and can also interfere with pituitary adenomas;

Diagnosis of subclinical hypothyroidism



The goal treatment in subclinical hypothyroidism



P-0531

Management of Pressure Wound: Two Doctors-Two Smart Phones

Özden Gökdemir¹, Nazmi Yoğurtçu², Ülkü Bulut³, Mehtap Kartal¹

¹Dokuz Eylül University, Medical Faculty, Family Medicine Department, İzmir, Turkey

²Dokuz Eylül University, Medical Faculty, Department of Plastic and Reconstructive Surgery, İzmir, Turkey

³Public Health Center / Balçova / İzmir, Turkey

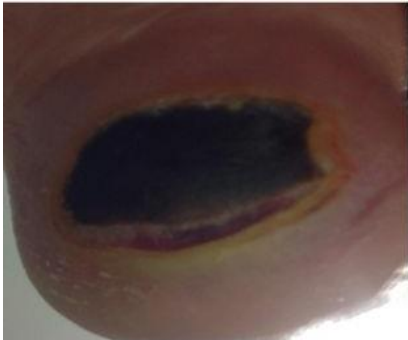
Aim-INTRODUCTION: Bone fractures in elderly can commonly cause not only treatment complications but also movement limitations. One of complications is the pressure wounds caused by plasters used. Its treatment takes a long time, comorbidity and the aggravation of current conditions in addition to limited activity leads difficult in follow-up and consultations.

CASE: An 85 year old woman had fall on her left knee and brought to the emergency room of a medical school. It is learnt that two years ago she had a total hip replacement for her right femur fracture, additionally also had neuropathy. She was in good condition and her vital signs were stable. She had limited movement on left knee in physical examination. X-rays showed patella fracture and diagnosis during orthopaedic consultation was "slightly dislocated fracture". Long leg plaster was preferred instead of surgery as treatment. She was informed about compartment syndrome. When the plaster was removed a 3x2.5cm black, painful lesion was observed in the left heel of the patient; she was then referred to the plastic surgery and reconstruction department (PSRD). Upon the suggestions of PSRD; water extract of triticum vulgare, cream containing ethylene glycol and monophenyl ether and rifamycin were prescribed for daily dressing. She was followed up by a family physician (FP). Due to her limited mobility PREC consultations during dressing were usually achieved by technology use. Pictures of pressure wounds taken every 10 days were shared with the PSRD physician via electronic media. Debridement and follow-up period lasted about 5 months. The patient regained her health without any surgical intervention by the multidisciplinary approach of FP and PSRD physician.

Discussion-CONCLUSION: especially limitation of elderly movements due to their comorbidity can restrict effective follow-up. Similar patient-centred approaches via current technologies can be developed for consultation process between FPs and specialists.

Keywords: pressure wound, elderly, telemedicine, consultation

PressureWound-1



water extract of triticum vulgare, cream containing ethylene glycol and monophenyl ether

PressureWound-2



Debridement-cream containing ethylene glycol and monophenyl ether and rifamycin

PressureWound-3



Debridement and follow-up period lasted about 5 months. The patient regained her health without any surgical intervention by the multidisciplinary approach of FP and PSRD physician.

P-0532

Evaluation of the health status and driver characteristics of elderly individuals

Hasan Kurşun, Mehmet Özen

Department of Family Medicine, Antalya Training and Research Hospital, Antalya, Turkey

Background & AIM: Elderly population in the world is increasing. The traffic problem is also increasing and affecting everyone's daily life. The driving abilities of the elderly are weakened and they encounter more problems. The aim of the study is to examine the driving characteristics of the elderly and effects of chronic diseases on it.

METHOD: 301 volunteers over the age of 50 who were referred to the family medicine outpatient clinic of a training and research hospital and agreed to participate in the study were included to the study. Participants were administered the 40-item questionnaire. SPSS 18.0 software package was used for data analysis.

RESULTS: 55.1% of respondents were male and 44.9% were women. Average age was found to be 62.1 ± 7.5 ; and 35.5% were over 65 years old. 81.1% of the participants had the diagnosis of at least one chronic disease; 39.9% had hypertension, 27.6% diabetes mellitus, 19.3% goiter, 8.6% hyperlipidemia, 4% coronary artery disease and 13.3% had other chronic diseases. 33.9% had never driven vehicle, 35.2% are active drivers and 30.9% had left to drive for various reasons. To stop driving due to attention deficit disorder were more common in over 65 years old group. Difficulty in driving due to reduction of visual function and joint pain had been identified. Only 12 participants had traffic accidents in the last five years.

CONCLUSIONS: Family physician should keep on mind that every elderly patient may be an active driver, and evaluate driving abilities. Periodic inspections of elderly drivers who have chronic diseases should be more frequent and the necessary controls must be done. Safe driving recommendations and when necessary, the decision of leaving the driving for elderly drivers may be life-saving.

Keywords: Elderly people, health status, driver characteristics

Table 1. Driving status and reasons to leave driving of respondents

Data about vehicle driving		n	%
Driving status	Never drove	102	33.9
	Current driving	106	35.2
	Leaved driving	93	30.9
Reasons for leaving drive	I don't need yet	36	38.7
	I am not careful as much as previous	22	23.7
	I am afraid	17	18.3
	My vision is not good	11	11.8
	I can't drive because of pains	5	5.4
	Other (I don't have car, etc.)	2	2.2

P-0533

Social Isolation Among Patients Taking Home Care Services And Their Caregivers

Güzel Dişçigil, Mehmet Aydın

Adnan Menderes University Medical Faculty Department of Family Medicine, Aydın, Turkey

Introduction and AIM:

Home care services (HCS) are needed to meet the health and care requirements of the increasing elderly and disabled population. In this study, we aimed to reveal the overall profile, and social problems face at during the presentation of services, the level of dependence in daily life and the problems encountered by caregivers of the patients taking home health and care service in Aydın province.

MATERIAL-METHOD:

Study was designed as cross sectional and descriptive. Face to face surveys and daily life activity scales were applied between June-December 2013. The demographic data, social problems that they had encountered were asked to patients and caregivers.

RESULTS:

Of the 451 patients, 303 (%67,2) were women, mean age was 70,5 years. The number of the bedridden was 192 (%42,6), and t rate was higher among women. Level of dependency; severe and moderate functional deficiency were 267 (%59,2) and 131 (%29,0), respectively, while there were 219 (48.6%) semi-dependent and 177 (%39,2) dependent patients. The dependency levels increased by the advancing age. Approximately, two thirds of the patients mentioned that they feel themselves isolated from life. The most frequent mentioned perspective for themselves were home ridden (n=103, 22.7%), immobile (n=57, 12.6%), life is boring (n=49, 10.9%), frustrated (n=46, 10.2%) respectively.

The 402 (%89,1) of home caregivers were women and the mean age was found to be 52,6 years. An important part of them (n:93; %20,7) had got a diagnosis related to anxiety while other common social problems were mentioned as inability of time allocation to nobody (n:40; %8,8) and to themselves (n:24; %5,3).

CONCLUSION:

The scope of the services should be built up by other social components (social activities, social support programmes and etc.). Besides health support, a comprehensive home care service model covering social and public supports should be developed.

Keywords: Home care, social, Katz, Lawton, daily living activities

P-0534

Bullous Pemphigoid Caused By Malnutrition: A Case Report

Hilal Ozkaya¹, Ali Ramazan Benli², Reyhan Bilginer³, Habibe Inci⁴, Selman Erturhan⁵, Mustafa Koroglu⁶

¹Department of Family Medicine, IBB Darulaceze Nursing Home, Kayisdagi, Atasehir, Istanbul

²Department of Family Medicine, Medical Faculty, Karabuk University, Karabuk, Turkey

³Department of Dermatology, IBB Darulaceze Nursing Home, Kayisdagi, Atasehir, Istanbul

⁴Department of Family Medicine, KBU Karabuk Educational and Research Hospital, Karabuk, Turkey

⁵Altinyayla ASM, Altinyayla, Sivas, Turkey

⁶Department of Haematology, KBU Karabuk Educational and Research Hospital, Karabuk, Turkey

INTRODUCTION: Malnutrition is common problem in geriatric patients living alone. Bullous pemphigoid is a chronic, inflammatory, subepidermal, blistering disease. Geriatric patients with bullous pemphigoid togetherness malnutrition is a factor of morbidity and mortality.

CASE: Seventy nine years old woman. Right tibia fracture has occurred after an house accident. Crural plaster was applied due to fixing the proximal articulations. Supracondylar of distal femur was cut in order to circulation problems developed in the inferior extremities. Diffuse bullous pemphigoid was developed owing to inadequate homecare and starvation. When the patient came to our institution right leg amputated and was cachectic. Body parameters of the patient is as follows; body mass index 12.1 kg/m², long mini nutritional assessment 18.5 and Katz activities of daily living scale is 14 (figure 1 and 2). Parenteral hydration and protein density nutrition protocol was given. Wound care supported by moisturizer and containing arginine-hydroxy methylbutyrate-glutamine amino acid and locally corticosteroid. Psychotherapy and sertraline 50 mg. per day was applied simultaneously. After treatment bullous lesions decreased and parameters were changed as follows; body mass index 16.6 kg/m², long mini nutritional assessment 20 and Katz activities of daily living scale is 16 (figure 3 and 4).

CONCLUSION: Insufficient postoperative home care can cause many complications in geriatric population. In spite of difficulties of co-morbid states in these group, adequate care can reverse the severe problems and can cure shown as like impossible.

Keywords: Malnutrititon, Bullous Pemphygoid, Geriatri

Figure 1



Figure 2



Figure 3



Figure 4



P-0535

RS3PE case report: the family doctor's role

Ana Catarina Carvalho

Unidade de Saúde Familiar Flor de Sal, ACeS Baixo Vouga (Aveiro, Portugal)

Background & AIM: Remitting seronegative symmetrical synovitis with pitting edema syndrome (RS3PE) is a mostly geriatric disorder. It consists of an acute symmetric polyarthritis and edema of the dorsum of the hands, and can be the inaugural presentation of various rheumatic and neoplastic conditions. The diagnosis is not obvious, as it is rare and its cause may be very distant to its manifestation. It usually responds to corticosteroids, which can be a problem in older, polymedicated patients. This case report intends to evoke this clinical entity and point out the family physician's role in its approach.

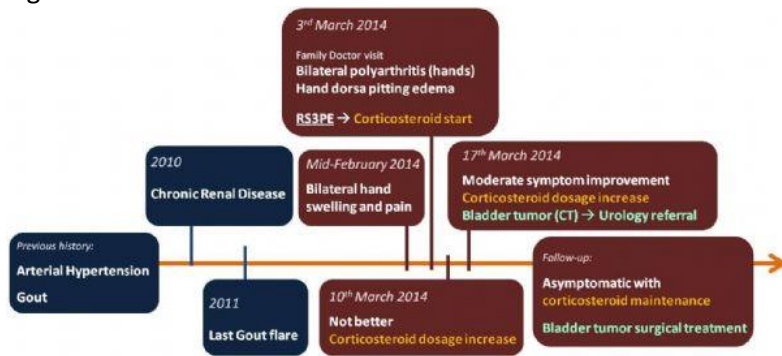
METHOD: Case report based on the family doctor's consultation notes taken during the year 2014 in the patient's clinical file.

RESULTS: A 73-year old male with history of gout, arterial hypertension and chronic renal failure, visited his family doctor complaining of bilateral hand swelling and pain that had suddenly started 2 weeks before, without any other symptoms. The examination showed a symmetric polyarthritis of both hands, with pitting edema of the dorsum. The blood tests showed a negative rheumatoid factor, low uric acid and raised C reactive protein levels. After a progressively higher dose corticosteroid therapy was initiated until obtaining a favourable clinical response, further investigation was started. Thoracoabdominal computed tomography revealed a bladder tumor which motivated referral to Urology department in an Oncology Hospital. Corticosteroids had to be continued, as lowering attempts led to reactivation.

CONCLUSIONS: The family doctor should be the patient's first point of access to the healthcare system. The knowledge of the patient's personal and family history, the possibility of close follow-up and the extremely diversified continuous education provides him the tools to successfully approach this problem. Due to its potential paraneoplastic nature, clinicians should be aware of this condition in ageing population, to promptly proceed to the necessary investigations.

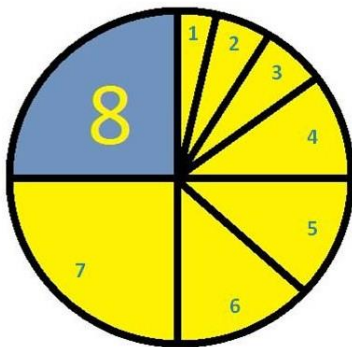
Keywords: RS3PE, geriatric, paraneoplastic, family doctor

Figure 1



Patient timeline: medical history, RS3PE presentation and clinical management.

Figure 2



Patient's family stage in Duvall's family life cycle (Stage 8 = Aging)

Figure 3



RS3PE syndrome clinical features: bilateral acute symmetric polyarthritis and hand dorsa pitting edema.

REFERENCES

- 1 Li H, Altman RD, Yao Q. RS3PE: Clinical and Research Development. *Curr Rheumatol Rep* 2015; 17:49
- 2 Izu CB, Puertas JR, Cabrerizo-García JL. RS3PE syndrome as a first manifestation of bladder carcinoma. *Letters to the Editor/Reumatol Clin* 2013; 9:72–74
- 3 Paksoy F, Ulas T, Mazl EE, Damar AB, Borlu F. Syndrome of Remitting Seronegative Symmetrical Synovitis with Pitting Edema (RS3PE). *Turk J Rheumatol* 2010; 25:88-90
- 4 Salam A, Henry R, Sheeran T. Acute onset polyarthritis in older people: is it RS3PE syndrome? *Cases Journal* 2008; 1:132
- 5 Dogan SK, Tur BS, Tuncer S, Seçkin B. Remitting Seronegative Symmetrical Synovitis with Pitting Edema (RS3PE): A Case Report. *Rheumatism* 2007; 22:72-5

P-0536

“analyzing of home care services in Tokat”

Mehtap Taşova¹, Nagihan Yıldız Çeltek¹, Ufuk Ünlü¹, Osman Demir², Gülseren Oktay¹, Ramazan Tetikçok¹, Mesut Şengül¹, Tuğçe Çamoğlu¹

¹Department of Family Medicine, Gaziosmanpaşa University, Tokat, Turkey

²Department of Biostatistics, Gaziosmanpaşa University, Tokat, Turkey

INTRODUCTION: Home care service is structuring and developing health service in our contry and many countries. The growing need for home care services is due to rising age of the population, disability, chronic illnesses and accordingly rising health costs. In this study, it is aimed to evaluate on giving home care service in Tokat and to detect that which needs are satisfied by this services

MATERIALS-METHODS: In our study, 422 registration and follow up forms of patients who following by Tokat State Hospital and Tokat Public Health Instution Homecare Department, are analyzed, retrospectively. Data are analyzed via SPSS program. Numeric data are analyzed via single direction variance analysis, crosstab and chi-square test.

RESULTS: Regarding patients, it is detected that 252(59,7%) were female, 170(40,3) were male and average of age was 69,4. 78,6% of patients have social security. 237 patients were bedridden, 163 patients were semi-bedridden. Routine control visiting rate was 54%, visiting rate for prescription was 32,5%, visiting rate for medical workup was 23,5%. Average of visit number was 5,14. 295 patients (78,7%) have chronic illnesses. Most frequent illnesses among these chronic illnesses are norologic diseases(72%), hypertension(49,7), diabetes (25,1).

CONCLUSIONS: The growing need for support therapy fort o raise the life quality is due to increasing elderly population. All in all patients getting home care services, it is seen that most part of these patients are home bound. For this reason, home care services must be continuous updated and edited in the direction of patients' needs.

Keywords: home care, Tokat, geriatrics

HOME CARE



**ONLAR HEP YANINIZDA
EVDE DE YALNIZ DEĞİLSİNİZ!**

11. Sadece sağlık çalışanları için, saat 09:00-18:00 arası
Her hafta Pazartesi günleri saat 09:00-18:00 arası



P-0537

Social networks and digital technologies as new tools in the management of Alzheimer's disease

Manuel Linares, Hector Puente, Eva Baonza, Tomás García, Jaime Domingo
People Who Global

BACKGROUND-AIM: Social networks, digital patient forums and all digital technologies for patients are becoming essential elements in medicine today. However there are still few studies that reflect how patients behave in the media, how they use new technologies and especially how these forums can help to improve health. In addition, the medical professional still perceive with some skepticism the usefulness of these resources for clinical practice.

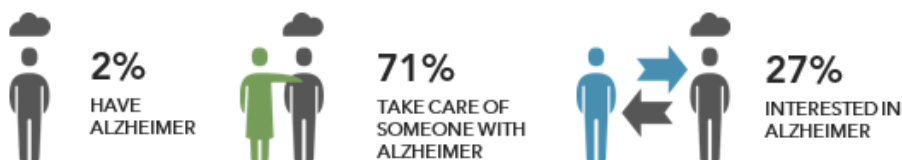
The aim of this study is to present the usefulness of a digital health platform dedicated to Alzheimer's disease
METHODS: Through the use of People Who website, an online platform present in several European countries aimed at patients and their closest environment, for all the people who live with Alzheimer's disease, who are interested or who care for these patients. From a considerable sample with more than 2282 users we combine quantitative and qualitative analysis (triangulation of methods and research techniques) aiming to outline the complex structure of relations on health platforms. We aspire to achieve structural representativeness by using a sample of users which accurately reflect the whole spectrum of profiles available in digital communities (structural universe)

RESULTS: We have made a complete description of the Alzheimer community and socio-emerging trends (age, sex, geographic distribution of the different profiles of caregivers) We also have identified what are the most viewed and rated by users or contents which are the socio-emerging trends, the main types of care for those wondering. The qualitative analysis of user feedback indicates that the platform has helped to prevent the caregiver burnout

CONCLUSIONS: A digital place to talk, share experiences, keep control over the illness and stay informed is a useful tool for people suffering from Alzheimer's disease and their caregivers. Provide a data center with useful resources can be an effective action in this context for patient empowerment

Keywords: Social networks, Alzheimer 's disease, big data, caregiver burnout

Relation with Chronic Alzheimer

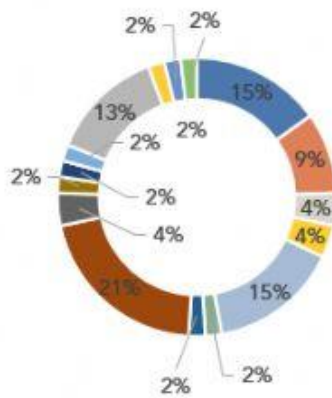


USER PROFILE



Questions by categories

CATEGORY	PERCENTAGE
Symptoms	15%
Diagnosis	9%
Medication	4%
Scientific research	4%
Non-pharmacological treatments	15%
Diet	2%
Exercise	2%
Psychological aspects	21%
Social Life	4%
Relationships	2%
Children	2%
Profession	2%
Health professionals	13%
Statistical data	2%
Patient Organisations or Foundations	2%
Public Healthcare	2%
TOTAL	100%



- Symptoms
- Diagnosis
- Medication
- Scientific research
- Non-pharmacological treatments
- Diet
- Exercise
- Psychological aspects
- Social Life
- Relationships
- Children
- Profession
- Health professionals
- Statistical data
- Patient Organisations or Foundations
- Public Healthcare

P-0538

Relationship Between Nutritional Status and Functional Impairment in 65 Years and Older Home Care Patients

Emine Neşe Yeniçeri¹, Betül Battaloğlu², Mustafa Nuri Ceyhan³, Deniz Aslan⁴, Cem Şahin⁵, Birdal Yıldırım⁶, Özgür Nadiye Karaman⁷, Dilek Güllüdal

¹Department of Family Medicine, Muğla Sıtkı Koçman University Medical Faculty, Muğla Turkey

²Muğla Direction of Public Health, Muğla Turkey

³Home Care Unit Muğla Sıtkı Koçman University Training and Research Hospital, Muğla Turkey

⁴Department of Internal Medicine, Muğla Sıtkı Koçman University Medical Faculty, Muğla Turkey

⁵Department of Emergency Medicine, Muğla Sıtkı Koçman University Medical Faculty, Muğla Turkey

⁶Physiotherapy Unit Muğla Sıtkı Koçman University Training and Research Hospital, Muğla Turkey

⁷Department of Family Medicine, Dokuz Eylül University Medical Faculty, İzmir Turkey

Background and AIM: The prevalence of malnutrition in elderly people is generally high. A relation has previously been demonstrated between functional and nutritional status. Determining nutritional and functional status of home care patients is essential for establishing programmes to prevent mortality and morbidity. The aim of this study was to assess the relationship between nutritional and functional status of home care patients registered to Muğla Sıtkı Koçman University Training and Research Hospital Home Care Unit in Muğla province (Turkey).

METHOD: This cross-sectional study was conducted with 143 home care patients registered to home care unit and a part of comprehensive geriatric assessment project conducted in this unit. The nutritional status of participants was assessed through the Mini Nutritional Assessment (MNA) full form test. MNA provides a classification according to individual's nutritional status. Functional status is determined with Barthel Index (BI). The BI is used to make a classification according to individual's performance and functional dependence in basic activities of daily living such as faecal or urinary incontinence, the help needed with grooming, toilet use, feeding, and bathing. Sociodemographic factors and disease related data were also obtained from the participants. Groups of malnutrition were compared by using mean MNA scores.

RESULTS: 143 elderly participated to the study. Average age was 82.1 ± 7.4 (Min:65, max:103). The prevalence of malnutrition was 26.6% and risk of malnutrition was 57.3%. 31 (21.7%) of the participants were smoking. The BI classification was as follows: 33.6% (n = 48) totally dependent, 42.0% (n = 60) severely dependent, 24.5% (n = 35) moderately dependent. No participants were found as slightly dependent or independent. MNA and BI were significantly associated.

CONCLUSIONS: Our data showed high prevalence of malnutrition and risk of malnutrition among elderly home care patients and positive relation between MNA and BI.

Keywords: elderly, nutrition, functional, impairment

Table 1: Nutritional and Functional Status of the Patients

Table 1: Nutritional and Functional Status of the Patients

Nutritional Status of the Patients			
	Frequency	Percent	
Normal Nutritional Status	23	16,1	$p=0.000,$ $\chi^2 = -0.462$
Risk of Malnutrition	82	57,3	
Malnutrition	38	26,6	
Total	143	100,0	
Functional Status of the Patients			
Totally Dependent	48	33,6	
Severely Dependent	60	42,0	
Moderately Dependent	35	24,5	
Total	143	100,0	

Table 2: Distribution of MNA scores

Table 2: Distribution of MNA scores				
Sex	Male	n=46	Mean = SE: 18.67±0.63	0.431
	Female	n=97	Mean = SE: 19.28±0.45	
Age	65-74	n=21	Median: 18 (min 7- max 26)	0.629
	75-84	n=62	Median: 20 (min 8- max 29)	
	≥85	n=60	Median: 19 (min 6- max 26)	
Education	Illiterate	n=76	Median: 19.50 (min 6- max 27)	0.801
	Literate	n=67	Median: 20 (min 7- max 29)	
Income	Income is the same as expense	n=77	Median: 20 (min 7- max 26)	0.394
	Income is lower than expense	n=66	Median: 19 (min 6- max 29)	
Spending Income	I decide myself about spending my income	n=123	Median: 22 (min 11- max 29)	0.002
	I do not decide myself about spending my income	n=20	Median: 19 (min 6- max 27)	
Smoking	Smoking	n=31	Median: 21 (min 11- max 29)	0.320
	Not smoking	n=112	Median: 19.5 (min 6- max 27)	
Source of income	Retirement salary	n=123	Median: 20 (min 6- max 29)	0.988
	No retirement salary	n=20	Median: 19 (min 7- max 27)	
Place where children live	Living together	n=16	Mean = SE: 18.06±1.04	0.293
	Living very close	n=74	Mean = SE: 19.62±0.46	
	Living far	n=53	Mean = SE: 18.66±0.68	
Person who takes care in case of illness	Partner	n=48	Median: 20 (min 7- max 24)	0.761
	Children or relative	n=74	Median: 19 (min 6- max 29)	
	Caregiver with salary	n=21	Median: 20 (min 11- max 26)	

Table 3: Distribution of Barthel scores

Sex	Male	n= 46	Median: 30 (min 0- max 85)	0.031
	Female	n= 97	Median: 40 (min 0- max 90)	
Age	65-74	n= 21	Median: 30 (min 0- max 85)	0.629
	75-84	n= 62	Median: 37.5 (min 0- max 90)	
	≥85	n= 60	Median: 37.5 (min 0- max 85)	
Education	Illiterate	n= 76	Median: 37.5 (min 0- max 90)	0.316
	Literate	n= 67	Median: 37.5 (min 0- max 85)	
Income	Income is the same as expense	n= 77	Median: 35 (min 0- max 85)	0.284
	Income is lower than expense	n= 66	Median: 40 (min 0- max 90)	
Spending Income	I decide myself about spending my income	n= 123	Median: 62.50 (min 0- max 90)	0.001
	I do not decide myself about spending my income	n= 20	Median: 35 (min 0- max 90)	
Smoking	Smoking	n= 31	Median: 35 (min 0- max 85)	0.676
	Not smoking	n= 112	Median: 40 (min 0- max 90)	
Source of income	Retirement salary	n= 123	Median: 35 (min 0- max 90)	0.149
	No retirement salary	n= 20	Median: 47.5 (min 0- max 75)	
Place where children live	Living together	n= 16	Mean ± SE: 33.44±6.83	0.653
	Living very close	n= 74	Mean ± SE: 38.51±2.96	
	Living far	n= 53	Mean ± SE: 40.56±4.02	
Person who takes care in case of illness	Partner	n= 48	Median: 35 (min 0- max 90)	0.761
	Children or relative	n= 74	Median: 35 (min 0- max 90)	
	Caregiver with salary	n= 21	Median: 50 (min 0- max 90)	

P-0539

Assessment of a brief community intervention for patients with insomnia: A "before and after" study

Rogelio Argueta Armenta¹, Ovidiu Nicsa¹, Cristina Moliner Molins¹, Imma Campamà Tutusaus¹, Carmen Delgado Diestre¹, Silvia Soriano Diestre², José Antonio García Ramos², Miriam Rey Seoane¹, Yolanda Alonso¹, Neus Parellada¹

¹EAP El Castell 1, C Marconi S/N Castelldefels 08860 Barcelona España

²H. Ayuntamiento de Castelldefels

OBJECTIVE:

- Analyze reduction of sedative-hypnotics after community intervention.
- Identify characteristics of patients attending the conference, patients diagnosed with insomnia and those with treatment for sleep disorders.

Methodology

Design: Cross-sectional descriptive study: Initial assessment and assessment after 6 months.

Study subjects:

Participants in the workshop: "Insomni: dormim bé", in the "XXXII Jornades Gent Gran" of the City Council of Castelldefels (> 65 years of age).

Workshop: 1.30 h. Theoretical explanation, variables, pharmacological treatment, relaxation exercises using audiovisual support.

Variables:

Medical history reviews, diagnosis code for insomnia, start of pharmacological treatment, subsequent check-up, visits to physician and nursing visits, interruption of treatment, Pittsburg sleep quality index, level of satisfaction.

RESULTS:

Out of 110 attendees, 40 responded to telephone questionnaire and consented to clinical overview.

95% (38) women and 5%(2) men. Average age: 72 years. 27.5% diagnosis code for insomnia and 55% treated with sedative-hypnotics.

After the conference/workshop 10.5% (4 attendees) consulted a physician again.

31.8% (7) stopped treatment, 2 of them had a diagnosis code.

47% were treated with sedative-hypnotics in May, 35% collected treatment from pharmacy. After 6 months,

47.5% of patients had treatment prescribed, 35% collected it.

Average score regarding Pittsburg Test: 8 in women and 3.5 in men. A score lower than 10: good quality of sleep, and higher than 11: poor quality of sleep.

27.5% obtained a higher or equal score to 11 points and 72.5% - 10 or lower.

Out of 22 patients being treated, 9 with a diagnosis code for insomnia, 13 without, statistically significant "P"-0.038.

CONCLUSIONS:

Reduction of sedative-hypnotics and consultation after conference/workshop.

Only 27.5% of participants with a diagnosis code, 55% had sedative-hypnotic treatment.

Average percentage from Pittsburgh Test: poor quality sleep that correlates with the same percentage with a diagnosis code of insomnia.

Full satisfaction about the conference/workshop.

Keywords: Insomnia, sedative-hypnotics, Pittsburg sleep quality index

P-0540

Tackling polypharmacy in older adults: A compilation of systematic reviews for the development of an electronic decision support tool

Roman Schlager¹, Anna Renom Guiteras¹, Yolanda Martinez², Ilkka Kunnamo³, Andreas Sönnichsen¹, PRIMA-eDS Review Group⁴

¹Institute of General Practice and Family Medicine, University of Witten/Herdecke, Witten, Germany

²Primary Care Research Group, University of Manchester, Manchester, UK

³Duodecim Medical Publication Ltd., Helsinki, Finland

⁴Finland, Germany, Italy, UK

BACKGROUND AND AIMS: There is a need to carefully weigh the risks and benefits of medication in older adults with multimorbidity and polypharmacy. Aims are: 1) to identify the evidence on risks and benefits of drugs commonly used in older adults; 2) to provide recommendations on their use, which can be incorporated into an electronic decision support tool (eDS-tool) aimed at supporting general practitioners to reduce inappropriate prescriptions.

METHODS: The PICOS-framework was used for the development of the search terms. Searches 1 and 2 identified systematic reviews (SR) and meta-analyses in the Cochrane Database of Systematic Reviews and DARE, and in MEDLINE, EMBASE, HTA and IPA, respectively. Search 3 identified clinical trials and observational studies from SRs not included in searches 1 and 2 but containing eligible studies and from the databases considered in search 2. Selection of studies, data extraction and quality appraisal were performed by two reviewers independently. Based on the evidence found the recommendations were developed using the GRADE methodology.

RESULTS: n = 21 SRs have been performed. In general, the amount of studies included and the quality of the evidence are low. So far, n = 46 recommendations for the following drugs have been developed: metformin, sulfonylureas, gliptins, glitazones, non-steroidal anti-inflammatory drugs, statins, beta-blocking agents, Vitamin K antagonists, new oral anticoagulants, nitrates, calcium channel blockers, thiazides, platelet inhibitors, high ceiling diuretics, insulin, digoxin, opioids and proton pump inhibitors.

CONCLUSIONS: Our work reflects a general lack of high quality evidence regarding drug treatment of older adults with multiple conditions. Recommendations have been checked by external review and have been integrated in the eDS-tool. The eDS-tool is currently tested in a randomized controlled trial with clinically relevant endpoints. This study is part of the 7th Framework European Project PRIMA-eDS* (Grant No. 305388-2).

*For more information please visit www.prima-eds.eu

Keywords: polypharmacy, electronic decision support, older adults

P-0541

analysis of geriatric patients admitted to the emergency clinic and accepted

Mehmet Halis Tanrıverdi, Hamza Aslanhan, Necmi Arslan, Ahmet Yılmaz, Erkan Kıbrıslı
Department of Family Medicine, Medicine Faculty, Dicle University, Diyarbakir, Turkey

AIM: Geriatric patients are the entrances to the hospital emergency department of geriatric patients could deteriorate quickly because they can be heard and intensive care needs. In this study, the incidence of hospitalizations in patients 65 years and older admitted to the emergency department and aimed to determine the clinical cases were hospitalized.

METHOD: 39 737 geriatric patients were admitted to Dicle University Faculty of Medicine emergency department the between 2010-2014. Services provided 13,681 patient admissions files were analyzed retrospectively.

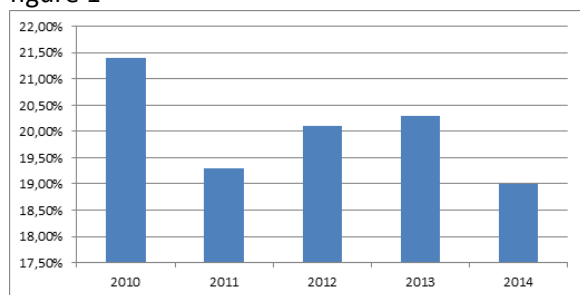
RESULT: 13681 from 39 737 geriatric patients admitted to the emergency department (34.4%) were hospitalized. 6612's of 13681 patients (48.3%) were female, 7069 to (51.7%) were male. Women's average age 77.46 ± 8.2 , mean age of the men was found to be 75.94 ± 7.4 . Patients most often in 2010 were found to be hospitalized (Figure 1).

When patients were examined we have identified the most frequent admission services Cardiology service and intensive care (Figure 2).

CONCLUSION: One out of every three geriatric patients admitted to the emergency clinic were hospitalized. This large proportion of patients in has created divisions such as cardiology, internal medicine, breast and general surgery. In geriatric patients, problems that require surgery and intensive care needs are seen as favorites. The show approaches specially trained staff and experts of the urgent problems of the elderly population will lead to faster and higher quality health service.

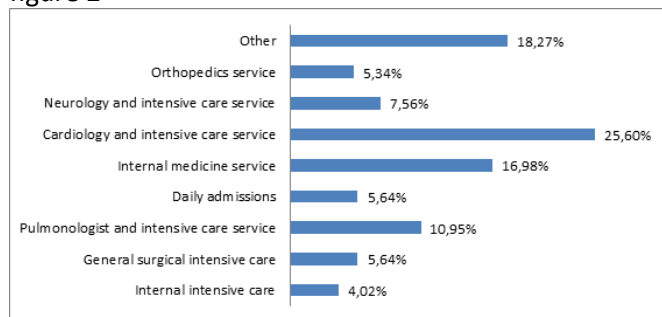
Keywords: geriatric patient, emergency service, hospitalization

figure 1



Odds section hospitalized by year

figure 2



The distribution of the hospitalized patients.

P-0542

Assessment of nutritional status and biochemical parameters of home care elderly patients with and without pressure ulcers

Oğuzhan Tezcan, Hülya Yıkılkan, Cenk Aypak, Derya Iren Akbıyık, Süleyman Görpelioğlu
Department Of Family Medicine, Dışkapı Yıldırım Beyazıt Training and Research Hospital, Ankara, Turkey

Background & AIM: Pressure ulcer (PU) is a frequently seen morbidity in home care elderly population. This study aimed to evaluate the nutritional status and biochemical parameters of home care elderly patients with PUs and without PUs.

METHODS: This descriptive study was carried out at Dışkapı Yıldırım Beyazıt Training and Research Hospital Home Health Care Center in 2015. In our study all patients (308) were home care elderly patients. 61 of them were in group PU (with PU), 247 of them were in group non-PU (without PU). All data were gathered from patient files. Blood samples were collected at home visits. Nutritional status was assessed by Mini Nutritional Assessment Short Form (MNA-SF) and Full Mini Nutritional Assessment (Full MNA).

RESULTS: The mean age was 79.0±8.5(min:65,max:99) years. In group PU and group non-PU 68.9%(42) and 63.6%(157) were females, respectively. Mean BMI of group PU(22.1±3.8 kg/m²) was lower than group non-PU(24.6±5.0 kg/m²)(p<0.05). There was a statistically significant difference in terms of mean MNA-SF score and Full MNA score between groups(p<0.001)(Mean MNA-SF score in group PU:6.0±3.0, in group non-PU: 9.3±3.3; mean Full MNA score in group PU:11.9±4.7, in group non-PU: 18.9±5.7). When the patients were evaluated with Full MNA in group PU, malnourishment was found in 49 patients(80.4%), risk of malnutrition in 11 patients(18.0%) and 1 patient(1.6%) had normal nutritional status. There was a statistically significant difference in terms of mean serum total protein and serum albumin levels between groups(p<0.001) (Mean serum total protein in group PU:6.2±0.6 g/dl, in group non-PU: 6.7±0.6 g/dl; mean serum albumin in group PU:3.1±0.5 g/dl, in group non-PU: 3.6±0.5 g/dl). Also mean hemoglobin levels in group PU(11.9±1.7 g/dl) were statistically lower than group non-PU(12.5±1.6 g/dl)(p<0.05).

CONCLUSION: The high prevalence of malnutrition among patients with PUs in our study points out a need for raising awareness for nutritional screening.

Keywords: Mini Nutritional Assessment, Pressure ulcer, Home care, Elderly, Malnutrition, Nutritional Status

Table 1.

Table 1. Evaluation of nutritional status in group PU and group non-PU with MNA-SF

	Group PU (n:61)	Group non-PU (n:247)
Normal nutritional status	2 (3.3%)	92 (37.2%)
Risk of malnutrition	18 (29.5%)	103 (41.7%)
Malnourishment	41 (67.2%)	52 (21.1%)

Group PU: Patients with pressure ulcers, Group non-PU: Patients without pressure ulcers, MNA-SF: Mini nutritional assessment-short form.

Table 2.

Table 2. Evaluation of nutritional status in group PU and group non-PU with Full MNA

	Group PU (n:61)	Group non-PU (n:247)
Normal nutritional status	1 (1.6%)	70 (28.3%)
Risk of malnutrition	11 (18.0%)	114 (46.2%)
Malnourishment	49 (80.4%)	63 (25.5%)

Group PU: Patients with pressure ulcers, Group non-PU: Patients without pressure ulcers, Full MNA: Full mini nutritional assessment.

Table 3.

Table 3. BMI, hematologic parameters, MNA-SF and Full MNA scores of group PU and group non-PU (mean \pm SD)

Parameter	Group PU (n:61)	Group non-PU (n:247)	p value
BMI (kg/m ²)	22.1 \pm 3.8	24.6 \pm 5.0	0.000
Serum total protein (g/dl)	6.2 \pm 0.6	6.7 \pm 0.6	0.000
Serum albumin (g/dl)	3.1 \pm 0.5	3.6 \pm 0.5	0.000
Hemoglobin (g/dl)	11.9 \pm 1.7	12.5 \pm 1.6	0.011
MNA-SF score	6.0 \pm 3.0	9.3 \pm 3.3	0.000
Full MNA score	11.9 \pm 4.7	18.9 \pm 5.7	0.000

p < 0.05 is statistically significant

Group PU: Patients with pressure ulcers, Group non-PU: Patients without pressure ulcers, BMI: Body mass index, MNA-SF: Mini nutritional assessment-short form, Full MNA: Full mini nutritional assessment.

P-0543

Correlation Between Medications and Falls in the Elderly People

Ayse Semra Demir Akca¹, Nejat Demircan¹, Fatih Akca², Funda Beyazçicek¹, Raşan Bulut¹, Tugba Beyazçicek¹

¹Department of Family Medicine, Bülent Ecevit University Faculty of Medicine, Zonguldak, Turkey

²Uzun Mehmet Chest and Occupation Hospital Zonguldak, Turkey

Background: Falls are an important public health problem for older adults, resulting in significant morbidity and mortality. Falls are prevalent among older adults and can lead to serious injury, loss of independence, hospitalization, nursing-home admission, and increased healthcare costs. Environmental hazards, medications, vision problems, and impairments in strength, gait, or balance can increase fall risk

AIM: One of the most serious consequences of polypharmacy is falling down of the elderly. In this study the correlation between polypharmacy and falls in the elderly people frequently encountered in the hospital.

Patients and METHODS: Falling down stories and polypharmacy regimes of elderly people have been examined and the relationship between these two data have been established with the SPSS program. The patients were divided into two groups: Both groups were compared in terms of demographic data, diagnosed chronic diseases, medication and habits.

RESULTS: The study is in process. Results will be discussed at the congress.

Keywords: Aged, polypharmacy, falls.

P-0544

• Development of Dementia Care in Community

Tatjana Cvetko

Department of Family Medicine Medical Faculty Ljubljana, Slovenia

BACKGROUND: Dementia is still poorly recognised in the community. After diagnosis people are looking for help in organizing the care of patients with dementia in various health and social services. Alzheimer organization encourage caregivers attending the self-help groups and can become an important source of organized assistance in the community, where people can get help and information about assistance in the community.

AIM: to show the development of organization of selfhelp groups, meetings and other interventions to offer psychosocial, informational and professional support in society in the light of needs of aging population and people with dementia.

METHOD: Review the development of organized care and learning about dementia in the community from self-help groups to one-day school on dementia.

RESULTS: Presentations of activities which have the association spread over the years throughout the region from the urban to the rural environment to help people with dementia.

- Selfhelp groups. 14 years, last years in 4 location, 10 meetings/year – per group,
- Annual meetings with lectures on dementia for lay public and professionals (14 years)
- One-day school about dementia – parallel program for caregivers and patients with dementia. Caregivers learn about dementia, get some practical skills and information, patients attend the program different activities in daily care (4 years)
- . Lectures for professionals about recognition and treatment of dementia, with particular attention on supporting families caring for patients with dementia at home
- . Alzheimer cafe - meetings in public area with talks about dementia for lay public
- . Information about dementia with leaflets, announcements in local media and public events

CONCLUSIONS: Selfhelp groups are not only a constant and important source of information and assistance in caring for patients with dementia, but also play in important role in learning an teaching process about dementia in community.

Keywords: dementia caregiving, selfhelp groups, community learning on dementia

P-0545

Dementia Diagnosis Of Primary Care Physicians In Istanbul

Kübranur Demir¹, Pemra C. Unalan¹, Fatma Dindar¹, Yeliz Özendi¹, Ferdinando Petrazzuoli²

¹Marmara University School of Medicine, Department of Family Medicine, Istanbul, Turkey

²Department of Clinical Sciences in Malmö, Centre for Primary Health Care Research, Lund University, Malmö, Sweden

INTRODUCTION: Dementia is one of the most disabling and a disease characterized by impairment of cognitive functions, changes in personality and diminished activities of daily living. Most never receive a diagnosis, even in high-income countries, only 20–50 % of dementia cases are recognized in primary care. There are many barriers to prompt and accurate diagnosis of dementia in primary care. The aim of this study was to investigate the readiness of the primary care physicians (PCP) with suspected or diagnosed dementia.

MATERIAL-METHOD: A total of 30 primary care physicians who were both GP and Family Physician, were applied a survey electronically form with 7 close-ended questions and asked for a dementia case history from the participants own practice. Case histories were used to raise an outline of the management of “the dementia suspected patient”.

RESULTS: A total of 22 (N=30) replied, 12 were females, 15 were GPs, 12 believe in that the secondary care physicians were officially responsible for the diagnosis of dementia, but 10 believe in both of the primary and secondary care physicians. Only 2 of the PCP expressed that they can try to establish a diagnosis of dementia on their own and 16/22 expressed, rarely. Nineteen of the participants told that should refer the patient to the secondary care specialist. Easy and short dementia tools and longer consultation time were required most by the GPs to detect dementia better. Only 4/22 physicians wrote the story of a dementia case from their practice. One physician mentioned no previously diagnosed dementia patient.

CONCLUSION: In Turkey among primary care physicians, limited knowledge, a gap of shared care protocols and practical guides, difficulties with the referral pathways, their pessimism about the effect of the treatment and diagnostic uncertainty can lead to timely delays in diagnosis and management of people suffering dementia.

Keywords: dementia, diagnosis, primary care

demantia 1



demantia 2



Chacteristics of participants:

Age:	Mean:36,47 SD:8,1 (min:28 max:51)
Gender:	Male:11 Female:11
Vocational training in primary care/family medicine	Yes:13 No:9
Dementia case experience:	Yes:6 No:16

P-0546

Family physician approach to peripheral artery disease: An old patient

Ülkü Yıldız¹, Nil Tekin², Mehtap Kartal³

¹Department of Family Medicine, Çukurca State Hospital, Hakkari, Turkey

²Department of Family Medicine, Narlidere Residential and Nursing Home, İzmir, Turkey

³Department of Family Medicine, Dokuz Eylül University, Balçova, İzmir

INTRODUCTION:

Peripheral artery disease (PAD) is an atherosclerotic disease being a significant reason of cardiovascular morbidity and mortality frequency of which increases especially at later ages. In this study, revealing the family physician approach to PAD in an old patient staying at the residential home was aimed.

CASE:

77-years old male patient staying at the residential home applied to the family physician with the complaints of swelling of right foot, loss of sense, loss of strength continuing for 2 months. In the medical history of the patient, HT, angiography-stent, KOAH, DM, bladder cancer are reported. The patient smoked 60 packages/year and alcohol consuming is at the level of social drinker.

In the physical examination of the patient, edema is observed in right foot, pulses of right lower extremity are weak. As the pre-diagnosis, right dural nerve root pressure and following Ankle Brachial Index (ABI) measurement, PAD was considered and cardiovascular surgery consultation was asked. Femoral pulses were seen in the consultation but distal pulses were not present and loss of dorsiflexion was found and in the result of CT angiography, right superficial femoral artery (SFA) was reported as totally occluded, left main femoral artery had 70% stenosis, left SFA was reported as totally occluded. Due to the diagnosis of KOAH, the operation (femoropopliteal bypass) could not be performed and medical therapy and varsity socks were recommended. PAD should be considered for HT patients and screening with ABI measurement should be carried out for the early diagnosis and improvement of prognosis should be aimed. Non-presence of symptoms in the patient and progressing with atypical symptoms results in ignoring diagnosis of PAD. Family physicians should be aware of the fact that PAD is a problem of community health and patients in the risk group should be evaluated accordingly.

Keywords: periferic arterial disease, elderly, family medicine

P-0547

Is it merely a sciatica pain?

İşık Gönenç¹, Emine Zeynep Tuzcular Vural¹, Şirin Yaşar²

¹Haydarpaş Numune Research and Training Hospital, Family Medicine

²Haydarpaşa Numune Training and Research Hospital, Dermatology Department

Varicella Zoster Virus (VZV) is the etiologic cause primarily of varicella (chicken pox infection) and its reactivations presenting as herpes zoster (shingles).

Older age, altered cell-mediated immunity, malignancies, chronic diseases are common risk factors for reactivations.

A 76-year-old immune competent woman presenting with burning lower back pain, right sciatica pain, allodynia in the right gluteal area, malaisedifficulty in walking and giving way in the right knee and developing painful, itchy and tingling grouped erythematous plaques with vesicles on the right gluteal and antero lateral aspect of her right thigh and leg after two days is described. The giving way of the knee and difficulty in walking suggests motor nerve involvement L4-5 innervated muscles.

The distribution was consistent with the L4-5 dermatomes, and a diagnosis of herpes zoster was made. The patient was prescribed valacyclovir hydrochloride, 500 mg three times daily for five days, analgesics and dressing as well as plenty of bed rest. The woman had a history of bilateral cataract operations one week apart 20 days ago, and described a right lateral malleolus fracture as a result of an ankle sprain a week ago.

CONCLUSION:

Clinicians should consider the possibility of herpes zoster especially in the elderly suffering from intractable pain projected in dermatome zones after recent trauma and stress in order to start treatment as soon as possible. The vaccine against herpes zoster should be offered to all elderly people without any contraindications at the patient's first clinical encounter.

Keywords: herpes zoster, sciatica, motor involvement

herpes zoster lesions



sağ gluteal bölgeden başlayıp sağ uyluk ve bacak anterolateral bölgeye uzanan herpes zoster lezyonları
herpes zoster lesions starting from the right gluteal region extending to the right anterolateral thigh and leg

Fig-1



Sağ tibia anterior yüzünde herpes zoster lezyonları
Herpes zoster lesions on the anterior aspect of the right tibia

P-0548

Smartphone Usage, Obesity, and Lifestyle Habits of Children and Adolescents in Korea

Seongho Han¹, Yj Park¹, Js Park¹, Js Choi²

¹Department of Family Medicine, Dong-A University, Busan, Korea

²Department of Family Medicine, Kosin University, Busan, Korea

BACKGROUND: Due to its highly addictive characteristic, smartphone use can reduce physical activities and cause unhealthy lifestyle habits, which leads to obesity. This study aimed to investigate the correlation between smartphone usage and obesity related factors.

METHODS: We visited four primary schools in Busan City in Korea for the completion of questionnaires for 11~12 years-old students. Out of 667 students, 240 underweight students were excluded, while 427 students were classified into average-weight group and overweight/obese group. The hours of smartphone use, relationship between Smartphone Addiction Scale and obesity, and correlation with obesity related factors were analyzed.

RESULTS: T-test was conducted based on the hours of smartphone use. The result showed that the students who used smartphones for 2 or more hours had significantly higher BMI than the students who did not. ($p < 0.05$) The result of the logistic regression analysis showed more students who used smartphones for 2 or more hours daily, watched TV for 120 minutes or more, have taken their last meal later than 7 pm, watched TV while eating, and ate fatty foods. Moreover, the students in the potential risk group among the students who used smartphones tend to have their last meal later than 7 pm, eat excessively, and watch TV while they consume fatty foods, snacks, or drinks.

CONCLUSION: The smartphone usage time and smartphone addiction are significantly related to the obesity factors in children and adolescents.

Keywords: Childhood obesity, Smartphone, Obesity related lifestyles

P-0549

Globalizaion and the Surge of Dengue

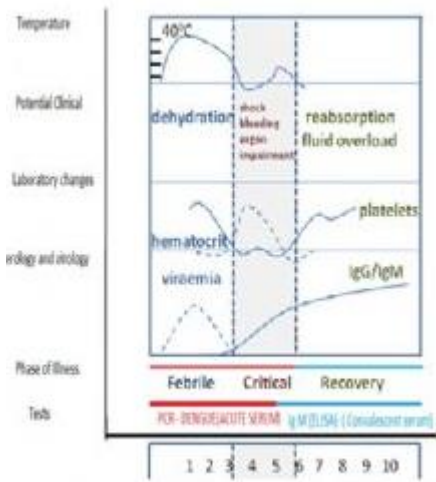
Ani Bodoutchian, Stacy Emile, Heera Motwani, Andrea Caracioli, Vinod Kumar
North Shore Long Island Jewish

Globalization and travel has made our world a much smaller place. Diseases that were once endemic to only a specific region of the world are now in our hometown. Today about 2.5 billion people, or 40% of the world's population, live in areas where there is a risk of dengue transmission. Dengue is endemic in at least 100 countries in Asia, the Pacific, the Americas, Africa, and the Caribbean. Information was gathered from existing recommendations from the CDC (Centers of Disease Control and Prevention) as well as other research sites were explored for their guidelines.

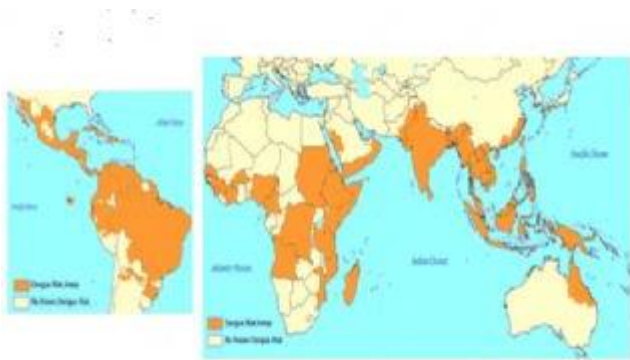
Effective disease prevention must have several integrated components, including active laboratory-based surveillance, emergency response, and education of the medical community to ensure effective case management, community-based integrated mosquito control, and effective use of vaccines when they become available.

Keywords: Global Medicine Preventative Medicine Travel Medicine Dengue Mosquitos Fever

Clinical Coarse of Dengue



Global Dengue



Clinical Course of Dengue and Global Dengue

P-0550**Comparison of obesity in children attending to a governmental primary school versus a private college**

Hakan Demirci, Beyza Demirbaş, Ali Candar, Fatih Çiftçi, Esra Beşir Mahsun, Yasin Güçlü, Nevruz Yıldırım, Salih Metin, Hayri Bozkurt

Department of Family Medicine, Sevket Yilmaz Training and Research Hospital, Bursa, Turkey

AIM: The frequency of private colleges is about 2-5% in Turkey. Families preferring private schools certainly belong to higher socio-economic power. Although private schools continues education full time period, governmental schools serve in part time period. Children attending private schools have their lunch at school on the other hand the others go home for lunch. In the present study we aimed to compare obesity in children in these two different categories of schools.

METHODS: There were 590 students in the governmental school and there were 171 students in the private school we visited. Height and weight measurements were made by assistant family physicians. Heights were measured in standing position and weights were measured while wearing light clothing. Ages and genders were noted. Educational status of the parents was also asked.

RESULTS: Age and gender distribution were similar. Educational status of parents who had a child in private college was statistically significantly higher compared to the other group. There were 79 obese students (13.3%) in governmental school while there were 30 obese students (17.5%) in private colleges ($p=0.000$).

CONCLUSIONS: Obesity was more prevalent among private college students. Meals served at private colleges may be a factor that raises risk of obesity. Intensified educational material, more frequent exams performed and higher expectations of families from students attending colleges may aggravate stress and hence obesity.

Keywords: private college, governmental school, obesity, stress, child

P-0551**Global Trends in the Incidence of Malaria**

Ani Bodoutchian, Donald Leveille, Tamas Ungar, Keasha Guerrier, Ebikaboere Youkedebah, Maureen Grissom
Department of Family Medicine, North Shore - LIJ School of Medicine Southside Hospital, New York, USA

One of the very well-known preventable as well as treatable diseases of the developing world is Malaria. It is a location-specific infectious disease transmitted by mosquitoes to humans and is influenced by environmental, vector, parasite, and host factors. By far, the illnesses that pose the most frequently encountered risks to western travelers to the tropics are vector-borne illnesses such as Malaria.

Due to many factors including increase access to travel in developing countries, as well as globalization, there appears to be an increasing number of cases of malaria encountered in areas of the world that have been understood to be malaria-free. We therefore set out to analyze available data concerning global trends in the incidence of Malaria over the years.

Keywords: Malaria Globalization Fever Mosquito Infectious Disease

Global Trends of Malaria

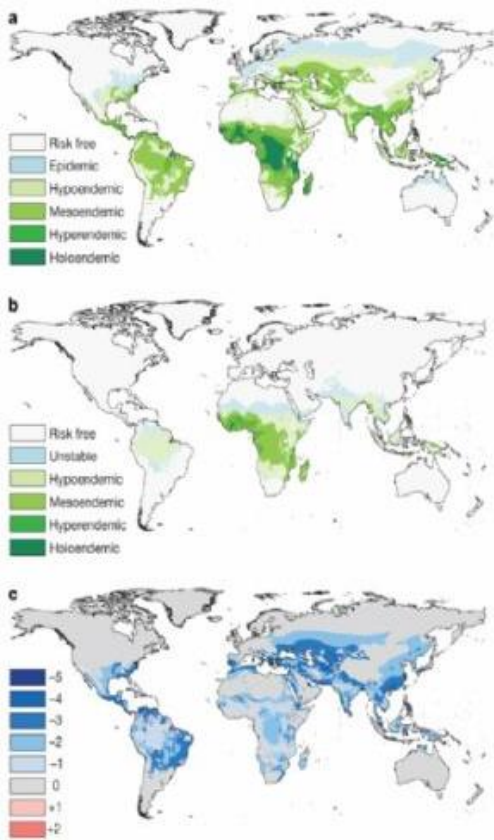
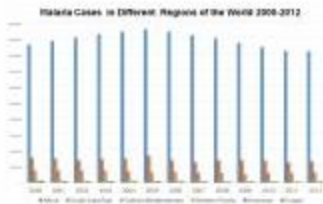
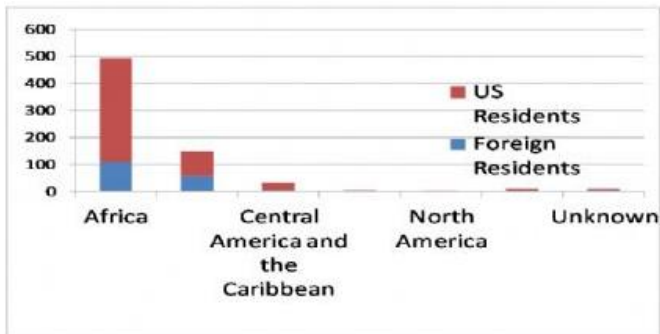


photo a: pre-intervention 1900's photo b: endemic areas for 2007 photo c: change in endemic areas 1900 and 2007 negative values denote a reduction in endemia areas positive values denote an increase of endemic areas

Malaria Cases in Different Regions of the World Between 2000-2012



Malaria Cases in the United States and Region of Acquisition



Africa conferred the most risk of acquisition among all the countinents. Foreign residents from Africian countries imported more reported cases of Malaria than all other sources combined.

P-0552

Assessment of Fluids Intake Among Health professionals

Yasser Yaghi¹, Ahmad Hesso², Nancy Maan², Maher Hamzeh³, Wajih Zaiour³, Shadene Yaghi⁴

¹Beirut Arab University, Beirut, Lebanon

²Hammoud Hospital -UMC, Saida, Lebanon

³Health Medical Center, Saida, Lebanon

⁴American University of Beirut

INTRODUCTION:

Water constitutes more than 65% of the body weight in a healthy adult male and 55% of the body weight in a healthy adult female. It is essential for human life and a co-factor in all chemical reactions that occur in the body.

AIMS:

To assess fluids intake among hospital staff in order to maintain a healthy level of hydration.

Subjects and METHODS:

168 members of the staff of a 350-beds general hospital and university medical center were interviewed by 2 senior residents and the hydration calculator index was used to calculate the amount of fluids taken per day. Staff members were subdivided into 4 groups: specialists, residents, nurses and clerks. Height, weight, gender, age, activity level and daily calorie intake from fluids was calculated for each staff member.

Analysis of data collected was performed using SPSS-17 soft ware program

RESULTS:

Nurses comprise the widest profession reviewed (80/168). Female to male ratio was 8/6. Activity level was almost rare 47% among all groups. Clerks and nurses tend to drink fewer fluids than physicians. 63% of the residents drink enough fluids daily. Males tend to drink more fluids (64%) than females (41%). The daily calorie intake from fluids was the highest among residents (104.97 Kcal).

CONCLUSION:

Increasing the number of water coolers and dispensers (mains-fed and bottle fed) in health facilities might encourage and improve hydration among health care professionals and that makes good economic sense and brings well being and better quality of work and life.

Keywords: HCI: Hydration Calculator Index

Chart 1

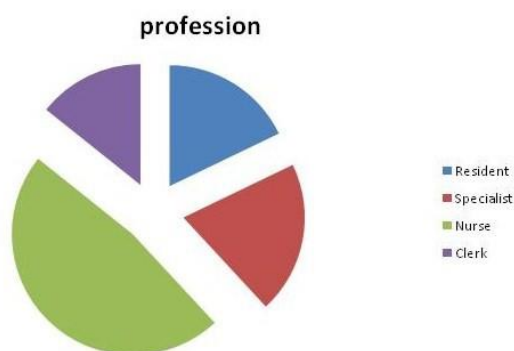


Chart 2

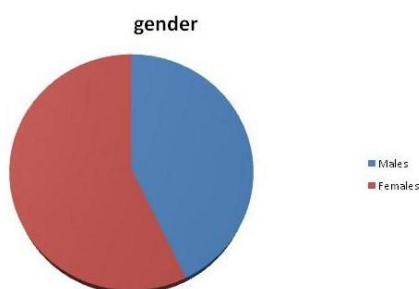
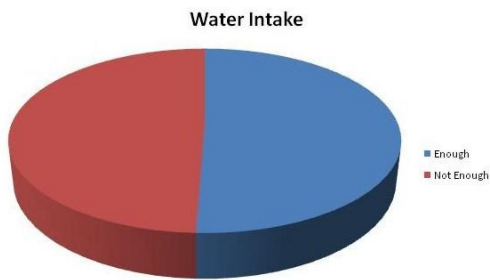


Chart 3



P-0553

Knowledge and attitude of Primary Care Health Professional in connection with The European Code Against Cancer

Esperanza Maria Romero Rodriguez¹, Luis Ángel Pérula De Torres², Fernando Leiva Cepas¹

¹Family and Community Medicine Teaching Unit

²Maimonides Institute of Medical Research IMIBIC/ Reina Sofia Hospital, Córdoba.

OBJECTIVE: To evaluate knowledge, attitudes and socio-demographic aspects of the primary care professionals regarding on the European Code against Cancer (ECAC) recommendations.

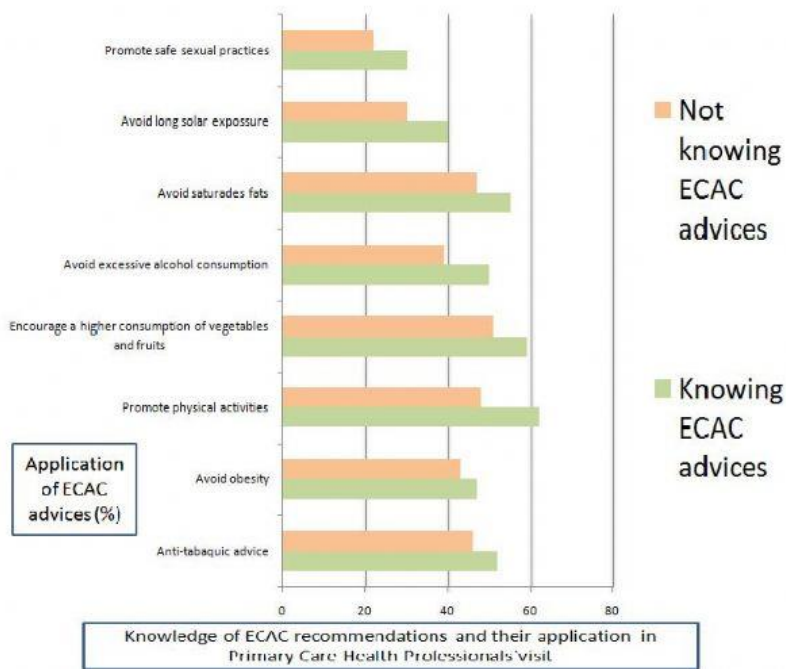
METHODS: A cross-sectional, descriptive, multicenter study was designed. Colleagues from Spanish Society for Family and Community Medicine (semFYC), health care professionals who were selected by snowball sampling and primary care providers who took part in ECAC-PC study, were enrolled. They completed an online questionnaire that collected socio demographic aspects and queries about their transmission of the recommendations of the ECAC to their patients during their clinical practice. A statistical analysis was performed, considering $p < 0.05$ statistically significant.

RESULTS: 1666 health practitioners were recruited. Their mean age was 46.5 years (SD 9.3). 74% of them were women. 83% were doctors and 11.2% nurses. 48% of them did not know the ECAC recommendations (IC95%: 45.59-50.45) and 77% were not attached to the Program of Preventive Activities and Health Promotion (PAPPS). Significant differences by age, gender, type of professional and knowledge of the ECAC were found. There was no relation to be affiliated to PAPPS or to be Resident director. Recommendations transmitted more frequently were anti-smoking counseling (36%), dietary advice (54.1%) and avoid obesity (22%).

CONCLUSIONS: The degree of transmission of the ECAC recommendations was a great deal higher in those professional who knew the ECAC, being the nursing staff the group which promoted more such activities. However, most health care professionals indicated that the percentage of their patients who adopted healthier lifestyles promoted in the ECAC was low.

Keywords: Cancer; Prevention; European Code against Cancer; Primary Care.

Knowledge of ECAC recommendations and their application in Primary Care Health Professionals` visit



Degree of transmission of Primary Care Health Professionals' advices

	Nursing n=186 (%)	Doctors n=1383 (%)	Nursing and Medical Residents n=97 (%)	P value
Physical activity	98 (53,2)	244 (17,7)	18 (19,6)	<0,001
Consumption of vegetables and fruit.	92 (49,5)	214 (15,5)	14 (14,4)	<0,001
excessive consumption of alcoholic drinks	51 (27,4)	196 (14,2)	9 (9,3)	<0,001
Consumption of saturated fats	68 (36,6)	173 (12,5)	9 (9,3)	<0,001
Excessive solar exposure.	32 (17,2)	135 (9,8)	6 (6,2)	0,019
Safe sex practices advice	20 (10,8)	108 (7,8)	7 (7,2)	0,145

P-0554

Public Knowledge about Crimean Congo Hemorrhagic Fever in Albania

Marsida Krasniqi¹, Genta Nallbani², Sokol Plaku¹, Besmira Rroku³

¹Department of Healthcare Elbasan, Albania

²Department of Sport Medicine Tirana, Albania

³Health Department Caritas Tirana, Albania

OBJECTIVE: The aim of this study is to assess the level of knowledge about the Crimean Congo hemorrhagic fever in Albania.

METHODS: This questionnaire based on a cross-sectional survey was conducted in the period June-September 2014 in Tirana, Albania. Selection of individuals was random. A total of 1220 persons agreed to complete the questionnaire. The questionnaire was constructed from 10 questions; the first four questions were for demographic data; the rest were for knowledge toward Crimean Congo hemorrhagic fever. The data collected were recorded and analyzed. The continuous variables were presented as mean and standard deviation; categorized variables were presented as percentage.

RESULTS: This study included 42.3% males (n=516) and 57.7% females (n=704) with average age 28.3 ± 10.66 years (range 19-56). 85.9% of participants interrupted the questionnaire because they responded that they didn't have knowledge about Crimean Congo Hemorrhagic Fever. The rest 14.1% (n=170) who had heard about Crimean Congo Hemorrhagic fever, reported in 85.6% that the source of information was media and 8.8% that the source of information was the school. Regarding the cause of the disease 57.3% declared as cause the virus and 11.4% reported they did not know the cause of the disease. 43.6% of participants who had knowledge of the Crimean Congo Hemorrhagic Fever reported the disease as contagious and lethal. 63.3% answered that the way of transmitted disease was by ticks and 70.8% answered that the way of transmitted disease was by affected persons. 21.3% reported as high risk for getting the disease the farmers. While 89.3% answered that they did not know the current situation in Albania about the disease.

CONCLUSION: In conclusion, it must be said that our findings showed that the level of knowledge in the population for this fatal disease is insufficient. The information obtained by the media is not complete and accurate. We believe that an education program will help raise the level of knowledge regarding Crimean Congo Hemorrhagic Fever in Albania.

Keywords: Public knowledge Crimean Congo Hemorrhagic Fever Albania

P-0555

How do we control hypertension in family medicine practice?

Olivera Batic Mujanovic¹, Edina Jaganjac², Larisa Gavran³, Esad Alibašić², Munevera Becarevic⁴

¹ Family Medicine Teaching Centre of Health Centre Tuzla; Department of Family Medicine, Tuzla University, Tuzla, Bosnia and Herzegovina

²Health Centre Kalesija, Kalesija, Bosnia and Herzegovina

³Family Medicine Teaching Centre of Health Centre Zenica; Department of Health Care, Zenica University, Zenica, Bosnia and Herzegovina

⁴Health Centre Banovici, Banovici, Bosnia and Herzegovina

Background&AIM: Prevention and management of chronic noncommunicable diseases are the main goals in family medicine practice. Aim of this study was to assess the quality of hypertension care provided by family medicine team through a medical audit.

METHOD: This retrospective analysis included 70/349 randomly selected medical charts of patients with hypertension (every fifth chart from register for hypertension) at the Family Medicine Teaching Centre Tuzla. Audit record form contained questions on sex, age, blood pressure, lipid status, body mass index (BMI), creatinine and urinalysis, smoking habits, physical activity and prescribed antihypertensive drugs.

RESULTS: Prevalence of hypertension was 24.2% (349/1445). Significantly more women had hypertension than

men (75% vs. 25%; $p < 0.0001$). Majority of patients (40%) belonged to the age group 60-69 years. Mean age of patients was 66.23 ± 10.96 years. Mean duration of hypertension was 9.82 ± 7.31 years. Family medicine team showed poor compliance with established criteria for hypertension control. Blood pressure was recorded in 92.5% of charts. Controlled blood pressure had 59.5% patients. Lipid status was recorded in 80% charts. Total cholesterol was controlled in only 9.4% patients, as well as triglyceride in 20.4% patients. BMI was recorded in 92.5% patients and only 6.3% had BMI $< 25 \text{ kg/m}^2$. Smoking status was recorded in 95% patients. There were 26% smokers, 18% ex smokers and 55% never smokers. Urinalysis was recorded in 87.5% charts and creatinine in 72.5% charts. Annual ocular examination had only 37.5% patients. Physical activity was recorded in all charts (100%). Majority of patients (51%) took two antihypertensive drugs, while 6% patients used three and more drugs to control high blood pressure.

CONCLUSIONS: Results of this study showed a high prevalence of deficiencies in the quality of care for hypertension in family medicine. It indicates more effective intervention in primary health care in order to reduce cardiovascular morbidity and mortality.

Keywords: hypertension, control, family medicine

P-0556

"Health and new technologies: the Smartphone applications"

Paula P Rodriguez Casal¹, Ana Isabel Beiró¹, Ana Belén Piñón Gamallo¹, Miguel Alonso Montoto², Carmen Arca¹, Santiago Perez Cachafeiro¹

¹Integrated Management Area Pontevedra-Salnes. Pontevedra. Spain.

²Secondary Education Institute Frei Martin Sarmiento. Pontevedra. Spain

Objective

The aim of this study was to evaluate the use of existing applications in health and welfare of current smartphones and its contribution to the motivation of increasing physical activity (PA) by their users.

Methods

A descriptive study was conducted. An online survey was open from October to November 2013. Adults aged from 18 to 65 years who resided in Pontevedra were invited to participate.

Results

172 people were participating in the survey (mean age: 34.58 years (± 9.6)). The prevalence of smartphone users was 64.5% and 27.9% of them had installed at least one application of health and wellness. The 45.9% of respondents considered useful these applications.

Conclusion

Users of these applications did more exercise since they had these applications and they believe that apps are useful in helping them with practical exercise. This certifies the potential of the applications to support the behavior change in the PA and other lifestyle habits, resulting in a significant public health impact.

Keywords: Smartphone, smartphone applications, mobile phone, physical activity, exercise, health behaviour.

Figure 1

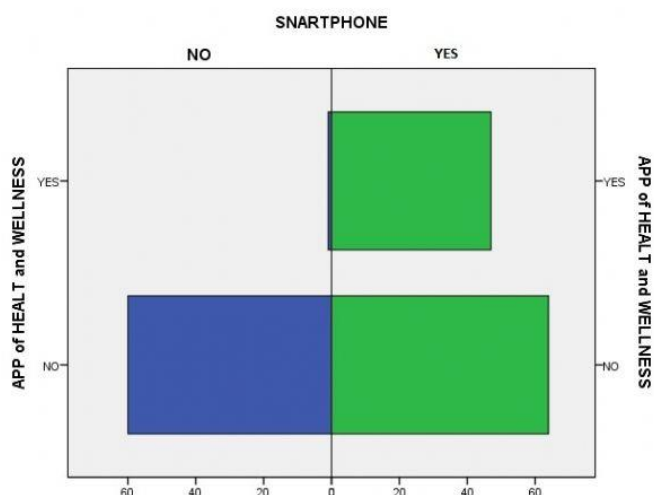
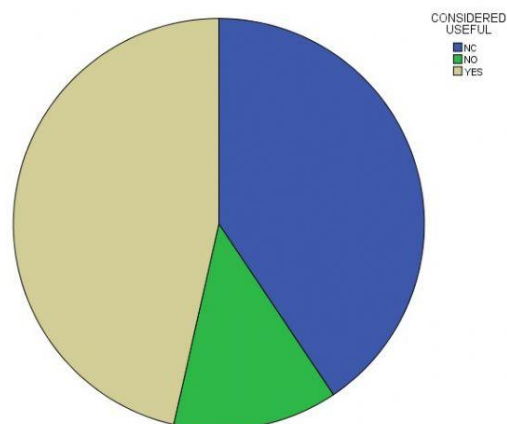


Figure 2



P-0557

Can we improve management of diabetes mellitus in family medicine practice?

Olivera Batic Mujanovic¹, Lejla Piric², Larisa Gavran³, Esad Alibasic², Munevera Becarevic⁴, Sanda Kreitmayer Pestic⁵

¹Family Medicine Teaching Center of Health Centre Tuzla; Department of Family Medicine, Medical Faculty of Tuzla University, Tuzla, Bosnia and Herzegovina

²Health Center Kalesija, Kalesija, Bosnia and Herzegovina

³Family Medicine Teaching Center of Health Centre Zenica, Zenica, Bosnia and Herzegovina

⁴Health Center Banovici, Banovici, Bosnia and Herzegovina

⁵Health Center Tuzla, Tuzla, Bosnia and Herzegovina

Background & AIM: Diabetes mellitus is associated with a significantly increased risk for morbidity and mortality. The aim of this study was to assess the quality of diabetes mellitus care provided by family medicine team at the Family Medicine Teaching Centre (FMTC) Tuzla through a medical audit.

METHODS: This retrospective study included 62/1452 medical records of patients with diabetes mellitus treated by family medicine team at FMTC Tuzla. We analyzed control of metabolic parameters for diabetes (level of blood pressure, blood glucose, HbA1C, total cholesterol, and body mass index) according to the ESC Guidelines on Diabetes, Pre-diabetes and Cardiovascular Diseases 2013, lifestyle, and prescribed antidiabetic therapy in patients with diabetes mellitus.

RESULTS: Prevalence of diabetes mellitus was 4.27%. Significantly more patients had type 2 diabetes (96.77% vs. 3.17%; $p < 0.0001$). Mean age of participants was 66.68 ± 12.4 years. Mean duration of diabetes was 9.97 ± 7.24 years. Significantly more women had diabetes than men (59.68 vs. 40.32%; $p = 0.03$). Only 11.29% patients had controlled glycaemia, while 58.06% patients had HbA1c $< 7.0\%$. All patients had normal urine analysis. Hypertension was present in 80.95% patients. Controlled blood pressure $< 140/85$ mmHg had 90.19% patients, and 75.81% patients had goal total cholesterol level. Only 17.46% patients had body mass index < 25 kg/m², while 42.80% patients were overweight, and 39.68% patients were obese. Majority of patients (72%) were physically inactive. More than half of patients were never smokers (53.22%), 22.58% were ex smokers, while 24.19% patients smoked. Oral antidiabetic therapy used 70.96% patient, 29.14% patients used only insulin, while 9.67% patients used combined antidiabetic therapy.

CONCLUSION: Result of this study showed that deficiencies in the quality of diabetes care in family medicine still exist. It indicates more effective intervention in primary health care in order to reduce morbidity and mortality in patients with diabetes.

Keywords: diabetes, management, family medicine

Figure 1. Distribution of patients with diabetes related to gender

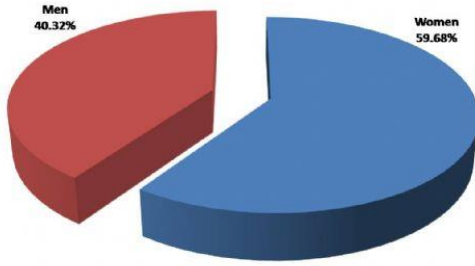


Table 1. Proportions of patients with controlled metabolic parameters for diabetes

Controlled metabolic parameters	Percentage of patients
Glicemia	11.29%
HbA1c	58.06%
Blood pressure	90.19%
Total cholesterol	75.81%
Normal BMI	17.46%

P-0558

Health Promotion Behaviours of the Future Health Care Professionals

Sevgi Özcan¹, Ali Bozhüyük², Nafiz Bozdemir¹

¹Department of Family Medicine, Çukurova University, Adana, Turkey

²Çiftlik State Hospital, Niğde, Turkey

BACKGROUND and AIM: Health science students are health care professionals and role models of the future. The aim of this study is to evaluate of health science students' health promotion behaviours.

METHOD: The sample population was composed of 801 students that attending to the health science schools (medicine (grade 1, 4, and 6), dentistry (grade 1, 4, and 5), midwifery, and nursery (grade 1 and 4)) of Cukurova University. The data was collected by an anonymous questionnaire and Health Promotion Lifestyle Profile-II scale. The 52-item scale is composed of a total and six subscales to measure behaviours in the theorized dimensions of health-promoting lifestyle: spiritual growth, interpersonal relations, nutrition, physical activity, health responsibility, and stress management.

RESULTS: Of the 60 % students were female. The mean age was 21.5 ± 2.21 (17-34) years. The mean score of Health Promotion Lifestyle Profile-II scale was at middle level (124.30 ± 17.92), the highest score was taken from spiritual growth subscale and the lowest one was taken from physical activity subscale. No significant relation was found between the age groups and the mean scores. Males got the higher score from the physical activity subscale, and females got the higher scores from all other subscales ($p < 0.05$). The health responsibility and the stress management mean scores of the students whose fathers were graduated from university were lower ($p < 0.05$). The all scores of the students attending to the medicine school were lower compared to the schools of dentistry, midwifery and nursery ($p < 0.05$).

CONCLUSIONS: Health promoting behaviours continue to take shape during their university training. Our study may be a guide for programs to improve the health promotion behaviours of health science students who are health professionals and role models of the future. Because of their curriculum includes "health promotion counseling" family medicine residents may take place in these programs.

Keywords: health promotion, health sciences, HPLP-II, university students

Table 1. HPLP-II total and subscale points according to the schools

School	Mean \pm SD						
	Health responsibility	Physical activity	Nutrition	Spiritual growth	Inter personal relations	Stress management	Total
Medicine	18,92 \pm 3,95	15,84 \pm 4,51	18,97 \pm 3,95	25,17 \pm 4,42	24,36 \pm 4,03	18,13 \pm 3,48	120,84 \pm 18,62
Dentistry	20,51 \pm 3,96	17,00 \pm 5,10	20,17 \pm 3,75	26,31 \pm 3,81	25,16 \pm 3,40	19,52 \pm 3,17	126,93 \pm 15,79
Nursing	21,29 \pm 4,17	16,25 \pm 4,15	20,11 \pm 3,19	26,29 \pm 4,09	25,95 \pm 4,05	19,15 \pm 3,36	129,31 \pm 17,58
Midwifery	21,03 \pm 4,29	15,21 \pm 3,57	19,56 \pm 3,64	26,04 \pm 3,84	25,43 \pm 3,64	18,73 \pm 3,42	124,99 \pm 16,62
Total	19,98 \pm 4,19	15,94 \pm 4,38	19,45 \pm 3,76	25,70 \pm 4,20	24,96 \pm 3,93	18,61 \pm 3,44	124,30 \pm 17,92
p*	<0,001	0,014	0,002	0,009	0,001	<0,001	<0,001
Source of difference	Medicine- All others	Dentistry- Midwifery	Medicine- Dentistry & Medicine- Nursing	Medicine- Nursing	Medicine- Nursing	Medicine- Dentistry & Medicine- Nursing	Medicine- Dentistry & Medicine- Nursing

*Anova

P-0559

Prevalence of Metabolic Syndrome in Patients with Psoriasis

Marco Arturo Quispe Suárez¹, Cristina Molinos Carrasco¹, Idaira Damas Pérez¹, Núria Montellà Jordana², Amparo Sancho Perpiñan¹, Ma Del Mar Ansaldo Pérez¹, Celia Tajada Vitales³

¹Primary Care Centre, Dr. Vilaseca - Can Mariner. Sta. Coloma de Gramenet, Barcelona, Spain

²Primary Care Service Metropolitana Nord i Maresme, Barcelona, Spain

³Primary Care Centre, Barri Llatí and Fondo. Sta. Coloma de Gramenet, Barcelona, Spain

BACKGROUND: Medical research shows that exist more prevalence of metabolic syndrome (MS) among patients with psoriasis.

This study aims to determine the association between psoriasis and MS, and to compare the prevalence of MS in patients with psoriasis according to severity and sex.

METHOD: A cross-sectional descriptive research was performed in a Centre for Urban Primary Care. Population: All patients with psoriasis, and patients without psoriasis matched for age and sex. Variables: social-demographic and presence of MS; in patients with psoriasis: years of evolution, severity scale as Psoriasis Area and Severity Index (PASI), monitoring and treatment. **METHOD:** interview and review of medical records. Analysis: Descriptive and calculation of OR.

RESULTS: n = 114 in both groups. The overall prevalence of MS was similar in both populations: 45.6% (95% CI 36, 46 to 54, 74) in psoriasis, 47.7% (95% CI 38, 23 to 56, 57) in patients without psoriasis. Patients with psoriasis: the majority (66%) received exclusive track by family doctors. Severity: according PASI only 2 patients (1.8%) were moderate and the rest were mild, of which 18 (15.7%) were receiving immunosuppressive or biological treatment; taking the treatment into account we could consider moderate 20 (17.5%) and mild 94 (82.5%). MS was detected in the 2 patients with moderate PASI and in 50 (44.6%) of milds. However, depending on the severity of the treatment, similar prevalence (40% in moderate and 46.8% in mild) was detected. No differences in the prevalence of MS according to sex (49% in men compared to 42% in women) were detected.

CONCLUSIONS: Although the literature demonstrates association between psoriasis and MS, in our centre statistically significant difference was not detected. The small sample size is one of the most significant limitations, so our results could be useful as a pilot study to propose a multicenter study.

Keywords: Psoriasis, metabolic syndrome, prevalence

Figure 1

PASI

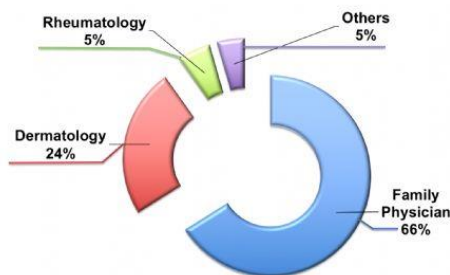
(Psoriasis Area and Severity Index)

SEVERITY	SCORE
Mild	0 – 5
	6 – 10
	11 – 15
	16 – 20
Moderate	21 – 30
	31 – 40
	41 – 50
Severe	51 – 60
	61 – 72

Severty according to Score

Figure 2

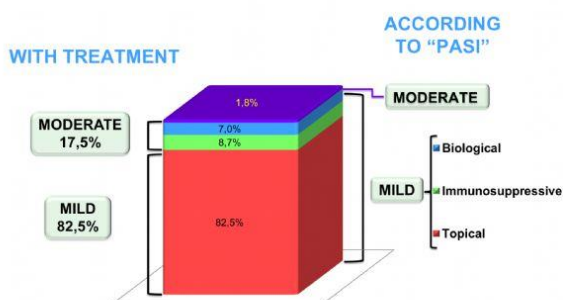
PSORIASIS FOLLOW UP by speciality



Patients with psoriasis: the majority (66%) received exclusive follow up by family doctors.

Figure 3

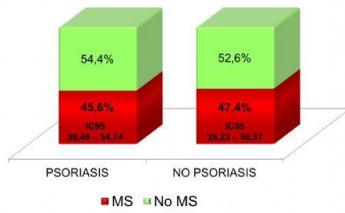
PSORIASIS SEVERITY



Severity: according PASI only 2 patients (1.8%) were moderate and the rest were mild, of which 18 (15.7%) were receiving immunosuppressive or biological treatment. Taking the treatment into account we could consider moderate 20 (17.5%) and mild 94 (82.5%).

Figure 4

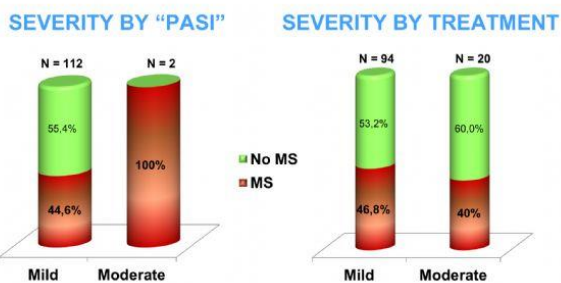
PREVALENCE OF METABOLIC SYNDROME



The overall prevalence of MS was similar in both populations: 45,6% (95% CI 36,46 to 54,74) in psoriasis, 47,7% (95% CI 38,23 to 56,57) in patients without psoriasis.

Figure 5

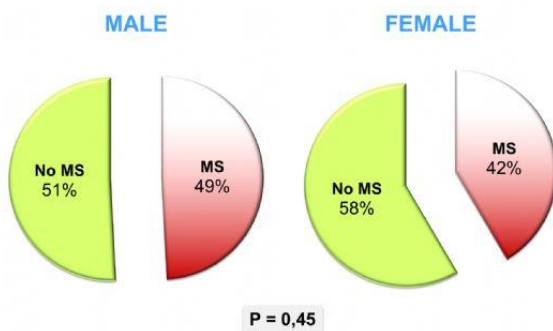
MS BY PSORIASIS SEVERITY



MS was detected in the 2 patients with moderate PASI and in 50 patients (44.6%) of milds. However, depending on the severity of the treatment, similar prevalence (40% in moderate and 46.8% in mild) was detected.

Figure 6

PSORIASIS: MS SEX SPLIT



No differences in the prevalence of MS according to sex (49% male compared to 42% female) were detected.

P-0560

Efficacy of two different behavioural intervention techniques on smoking cessation rates of patients who have been prescribed Varenicline; a randomized study

Sirin Parkan, Pinar Topsever, Efe Onganer

Acibadem University School of Medicine, Department of Family Medicine, Istanbul, Turkey

AIM: Identifying the most effective intervention for behaviour change in smoking cessation is still a matter of interest in scientific research. The research question is: Does informing patients about the mechanisms of developing nicotine addiction and the mode of action of the drug they are prescribed to quit smoking (varenicline) change the outcome of smoking cessation rates compared to patients who were prescribed varenicline and were subject to brief intervention about smoking cessation?

METHOD: Patients who presented to two periodic health examination outpatient clinics run by family physicians at a private hospital are eligible for this study. Inclusion criteria is smoking more than 10 cigarettes a day for the last consecutive year and giving informed consent. Exclusion criteria were diagnosis of mental disorders (e.g. depression, bipolar disorder). At outpatient clinic A the patients will be given brief intervention about smoking cessation and prescribed varenicline (control group). At outpatient clinic B patients will be prescribed varenicline and given additional information about the way nicotine dependence is developed and the mode of action of the drug they are prescribed to assist them quit smoking (varenicline) (intervention group). Patients will be assigned to intervention and control systematically by the receptionists of the hospital who give the appointments for the outpatient clinic visits. Primary outcome parameter will be smoking cessation rates of patients in both groups after six months. Sample size will be calculated to compute an estimated difference of smoking rates between two groups ($\alpha < 0,05$, $1-\beta$ 0,8, 95% CI). The estimated value will be extracted from the review of the recent relevant literature.

RESULTS: There are no results, yet. They will be ready at the conference' time.

Keywords: smoking cessation, preventional medicine, behavioral treatments

Figure 1: Outcome by Intervention and Drug Therapy

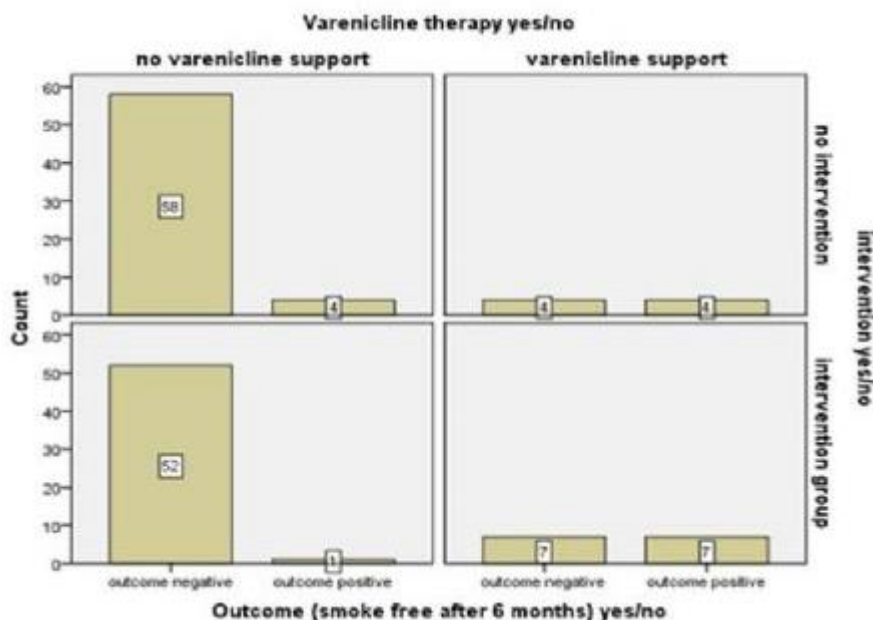


Table 1: General Characteristics of the Study Population

Sex: male (n, %)	82 59,9%
Age (years, mean±SD)	45,6±10
Marital status: married (n, %)	105 76,6%
Education: high education (n, %)	86 62,8%
Occupation: white collar-academics (n,%)	91 66,4%
Comorbidity (n, %)	24 17,5%
Symptomatic (n, %)	44 32,5%
Exposure to smoking in pack years (mean+-SD)	21,4+-14,2

P-0561

The Pattern of Physical Activity among Nurses in Labuan, Malaysia

Abdul Hafiz Mohamad Gani, Tijah Isa

Department of Health, Federal Territory of Labuan, Labuan, Malaysia

BACKGROUND: Nurses are healthcare individuals that often deal with patient's management including health education. Poor physical activity among the nurses may affect health status as well as willingness to promote healthy lifestyle.

AIM: The objective of this study is to assess the pattern of physical activity among the nurses and its associated factors.

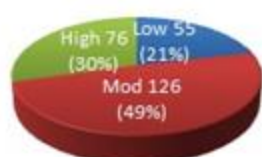
METHODS: This was a cross sectional study conducted in Department of Health in Labuan, Malaysia. All registered nurses working with Ministry of Health (MOH) were given a set of self-administered questionnaires including their social demography, physical measurements and validated Malay version of the International Physical Activity Questionnaires (IPAQ). Pregnant nurses and male nurses were excluded from the study.

RESULTS: A total of 257 nurses answered the questionnaires out of 325 registered nurses in the MOH in Labuan giving a respond rate of 79%. In this study, 78.6% (n= 220) of the nurses in Labuan were physically active (Moderately Physical Activity 49% (n= 126) and High Physical Activity 29.6% (n=76). Factors that were associated with being physically active are normal Body Mass Index (BMI) and Waist Circumference (WC). There were no association between being physically active with participation in any exercise program and giving advice on exercise to patients.

CONCLUSION: About 78.6% of nurses in Labuan were physically active. It is recommended that health promotion should be targeted to those with high BMI and WC to improve their physical activity. However, all nurses are encouraged to participate in physical activity and give advice to patientson exercise regardless of their physical activity status.

Keywords: Physical Activity, IPAQ, Nurse, Malaysia

Percentage of Physical Activity among Nurses in Labuan, Malaysia



P-0562

Statins for primary prevention in people with a 10% 10 year cardiovascular risk: too much medicine?

Dharani Yerrakalva
University of Cambridge

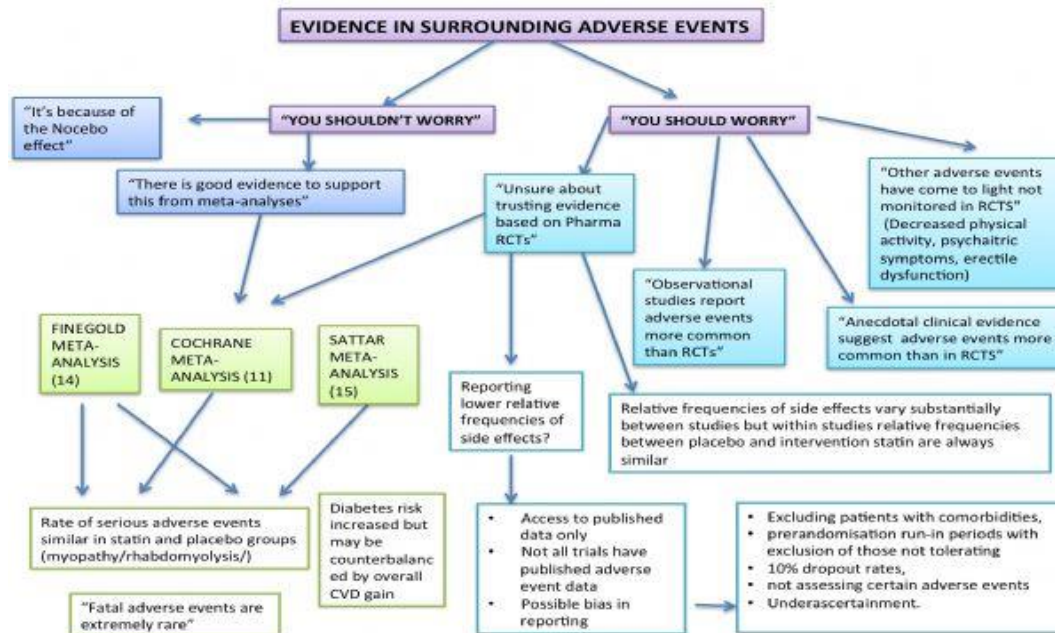
The recommendation from 2014 NICE guidelines on lipid modification to offer statins to people with over 10% risk of having a cardiovascular event within 10 years, a change from 20%, has deeply divided medical opinion. ‘Statin wars’, a public battle polarizing experts, has featured highly in media and journal coverage and is reflected in the widespread discontent of UK GPs. We analysed the factors which led to the health policy on statins in primary prevention, including two major meta-analyses which have been subject to the most criticism in this debate. We also layout the fall-out from the policy and what should be done going forward.

These two meta-analyses from the Cochrane and CTT groups found therapeutic benefit of a statin for primary prevention and suggest this outweighs the risks. However, we found there are serious and legitimate concerns over the available evidence raised by numerous professionals across disciplines. Though on balance, policy makers decided these concerns weren't enough to prevent the recommendatuon, without the backing of the medical community this recommendation has been rendered almost impotent. This may have damaged the future cause of statins, and it remains unclear how easy it will be to repair this.

Moving forward, there is a clear need for independent researchers to be allowed to analyse individual patient data and for release of adverse event data from the pharmaceutical RCTs. Only then might we be able to move towards a constructive resolution to what is set to be a drawn-out battle.

Keywords: Statins; primary prevention

Adverse Effects of Statins



P-0563

Primary health care professionals views on the inclusion of the vaccine against human papillomavirus in the vaccine schedules. Across-sectional study

José Damián Garcés¹, Maria Reyes Oliver², Maria Victoria Bravo², Carmen Alvarez², Estela Lorenzo², Jesús Salvador Jiménez², Isabel Blasco¹, Leticia Muñoz², Laura Marqueta², Jose Miguel Seoane², Carmen Guillen², Concepcion Perez²

¹Centro de Salud "General Ricardos". Madrid. Spain

²Hospital Universitario 12 de Octubre. Madrid. Spain

Although the inclusion of the HPV vaccine has been registered in Spain since 2007, vaccination rates are lower than expected. The patients wish to be vaccinated is heavily influenced by information they have received from many source. The Knowledge of primary health care professionals affects the information provided to patients and is fundamental in the decision making. The aim of this study is to assess the opinions of primary health care professionals on the vaccine against HPV and their knowledge about HPV infection and its links to with cancer. A 19-item survey was drawn up. It included questions on basic aspects of HPV infection and marketed vaccines, personal opinion about the inclusion in the immunization schedules and their level of prescription and recommendation to their patients. From October 2013 to December 2013, 607 surveys were distributed among 20 primary health centers affiliated to the University Hospital 12 de Octubre. The results were analyzed using SPSS statistical package.

164 successfully completed surveys were obtained for analysis. 89% knew about the relationship between HPV infection and cervical cancer, 57.3% did not know any of the serotypes against which vaccines are targeted; 40.4% believed that there is insufficient data to support the commercialization of the vaccines. Of these, 65.7% argue that there is no data of its long-term effectiveness, 13.4% that there is no data as to its side effects, 13.4% believed that the cost effectiveness is not worthwhile.

There is a strong controversy among health professionals regarding the marketing and inclusion of HPV vaccine in immunization schedules. However, the knowledge of the primary care health professionals on key aspects of infection and vaccine protection are insufficient. The training of professionals in vaccination, cervical pathology and HPV infection should be improved to provide objective information on the use as this vaccine for patients.

Keywords: Human papilloma virus, HPV vaccines, cervical cancer, primary care

P-0564

Immunisation against flu at Health Centre Bijeljina

Srdjan Mijatovic, Zlatko Maksimovic, Aleksandra Mijatovic, Ruzica Jelusic, Dijana Dukic
Health Centre Bijeljina

Flu is an active, infectious, and very contagious disease caused by influenza virus.

The aim of the work is to show the significance of the vaccination against the seasonal flu for the time period from 2005 until 2014 in the territory of Bijeljina City.

A retrospective protocol analysis has been performed at Health Centre Bijeljina Hygiene-Epidemiology Unit. During the time period between 2005 and 2014, the seasonal flu vaccination was being continuously performed at Hygiene-Epidemiology Unit.

The greatest number of persons vaccinated is for 2008/2009 - 3,519 and 3,582 for 2009/10.

A gender based analysis has shown a higher percentage of male immunized persons. The greatest number of flu reported cases is for 2009/10 – 250 of them and 162 cases in the year of 2008/09. Data on the infected based on their gender has shown that flu often occurs in female persons, which can be linked with higher immunization percentage of men. The greatest number of the reported flu cases is for the age group from 10 to 19 years – 21.28 %, and the greatest number of flu reports is in February – 34.43%. During the past 10 years there was no flu epidemic in the territory of Bijeljina City. During the year of 2010 there were also 10 reported cases of H1N1 flu at Health Centre Bijeljina.

On the basis of the obtained results, 24,809 persons were immunized at Health Centre Bijeljina, which made an average of 2,408.9. The statistic data have shown that the youngest population categories are the most

affectable. 53% of the immunized were men and 47% were women. The results obtained have shown the significance of the flu immunization, because of a greater number of vaccinated male persons, and the smaller percentage of their presence among the reported cases.

Keywords: Immunisation, flu, Health Centre Bijeljina

Poster

DOM ЗДРАВЉА
BIJE LJINA

**IMMUNISATION AGAINST FLU
AT BIJE LJINA PUBLIC HEALTH CARE
CENTRE**

Srdjan Mijatović, Zlatko Maksimović,
Aleksandra Mijatović, Rožica Jelisić, Dijana Dukić

AIM

The aim of the work is to show the significance of the vaccination against the seasonal flu for the time period from 2005 until 2014 in the territory of Bijeljina City.

METHODS

A retrospective protocol analysis has been performed at Bijeljina PHCC Hygiene-Epidemiology Unit.

During the time period between 2005 and 2014, the seasonal flu vaccination was being continuously performed at Bijeljina PHCC Hygiene-Epidemiology Unit.

The greatest number of persons vaccinated is for 2008/2009 - 3,519 and 3,582 for 2009/10.

RESULTS

A gender based analysis has shown a higher percentage of male immunized persons. The greatest number of flu reported cases is for 2009/10 - 250 of them and 162 cases in the year of 2008/09. Data on the infected based on their gender has shown that flu often occurs in female persons, which can be linked with higher immunization percentage of men. The greatest number of the reported flu cases is for the age group from 10 to 19 years - 220 (21.28 %), and the greatest number of flu reports is in February - 356 (34.43%). During the past 10 years there was no flu epidemic in the territory of Bijeljina City. During the year of 2010 there were also 10 reported cases of H1N1 flu at Bijeljina PHCC.

CONCLUSION

On the basis of the obtained results, 24,809 persons were immunized at Bijeljina PHCC, which made an average of 2,408.9. The statistic data have shown that the youngest population categories are the most affectable. 53% of the immunized were men and 47% were women. Analysis of the infected persons (i.e. number of the reported cases in the territory of Bijeljina City) has shown the figure of 1,034, out of which 550 women and 484 men. The results obtained have shown the significance of the flu immunization, because of a greater number of vaccinated male persons, and the smaller percentage of their presence among the reported cases.

Immunisation against flu at Health Centre Bijeljina

P-0565

Resveratrol - is it the perfect healthy life supplement?

Ines Abreu Mendes¹, Pedro Alves¹, Mileta Gomes², Ieda Paula³

¹USF D.SANCHO I, Aves Leiria, Portugal

²UCSP Almeirim, Aves Leiria, Portugal

³USF Cynthia, Aves Sintra, Portugal

Resveratrol (3, 5, 4'-trihydroxy-trans-stilbene) is a kind of polyphenol produced by the grapes and a few other plant species. Grape skins have 50-100 µg of resveratrol per gram. Rich natural sources of resveratrol include *Polygonum cuspidatum* (Japanese knotweed, 0,524 mg/g), red wines (0,1 – 14,3 mg/l), red grapes skins, berries such as blueberries, as well as chocolate, tea, peanuts and other nuts.

Resveratrol was attracting increased attention due to its diverse health benefits especially in case of cardiovascular diseases, cancer, diabetes, neurodegeneration and other age-related ailments.

Resveratrol was discovered to be a small molecule activator of sirtuin 1, an important molecular target regulating cellular energy metabolism and mitochondrial homeostasis. By the similar effects of resveratrol to the effects of exercise training, resveratrol was considered as an exercise mimetic.

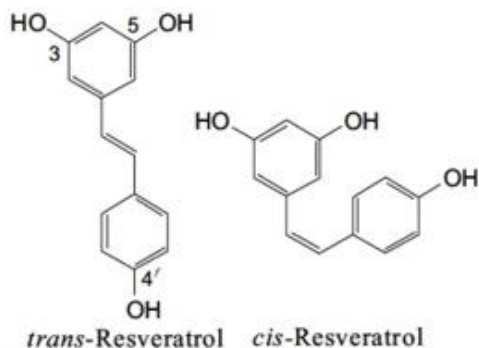
In this poster review we present the latest advances regarding the availability, dosage, formulation, toxicity and the many effects of resveratrol in human and animal studies since 2000.

Due to resveratrol's many potential health applications, researchers tried to determine the optimal dose needed to capture its benefits. Studies showed that the optimal doses vary from 20 to 500mg a day. More clinical research on resveratrol were needed to determine the minimal effective dose, mode of delivery, frequency and safety/efficacy of doses for particular target populations.

Toxic data confirm that resveratrol was well tolerated and the adverse effects were moderate and reversible; nevertheless the efficacy and safety of resveratrol need to be further investigated.

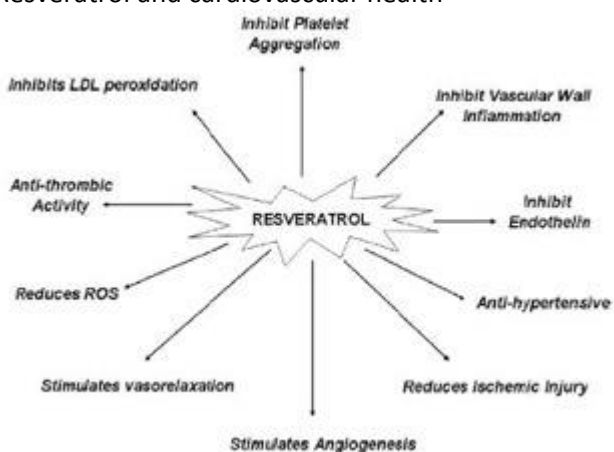
Keywords: resveratrol, clinical trials, metabolism, longevity

Isomers of resveratrol: chemical structures of trans and cis-resveratrol



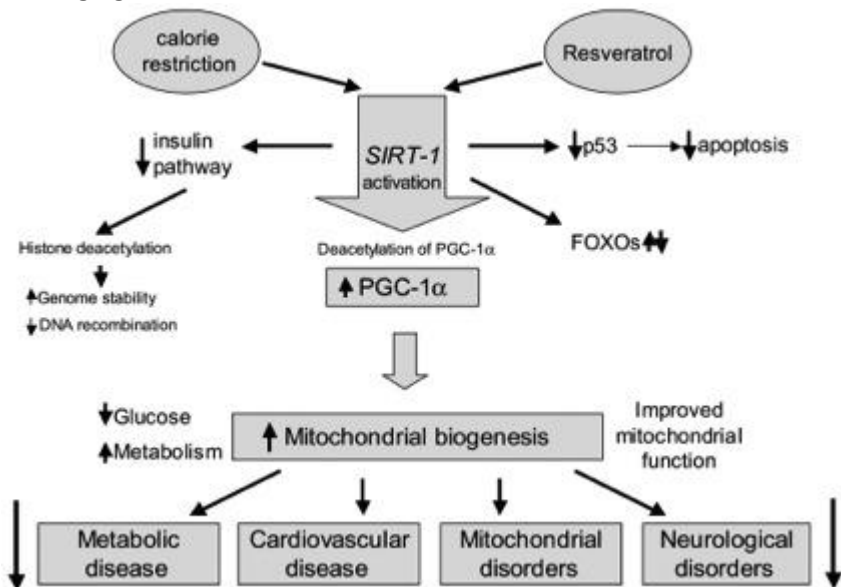
Molecule Resveratrol exists in two isoforms, trans-resveratrol and cis-resveratrol, the trans form, which is the preferred steric form in Nature, is relatively stable.

Resveratrol and cardiovascular health



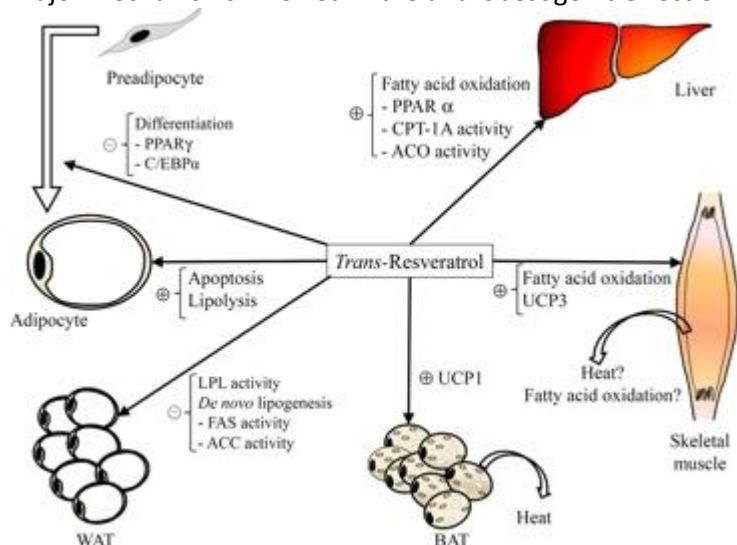
Coronary heart disease (CHD), a primary cause of morbidity and death in developed countries, is regarded to be preventable through changes in lifestyle and diet. Epidemiological studies of a phenomenon commonly referred to as the French paradox show an inverse relationship between low-to-moderate consumption of red wine and the risk for CHD. One of the most well-known benefits of resveratrol is for cardiovascular health protecting against different cardiovascular diseases.

Anti-Aging Mechanisms of Caloric Restriction and Resveratrol



In numerous studies, restricting calorie intake in laboratory animals has been shown to prolong their life span by as much as 60%. In humans, consuming a low-calorie diet is associated with several possible markers of greater longevity, such as lower insulin levels and reduced body temperatures, along with less of the chromosomal damage that typically accompanies aging. People who consume a low-calorie diet may be less prone to diseases associated with being overweight or obese, such as metabolic syndrome, diabetes, atherosclerosis disease and cancer. Protein levels of SIRT-1 and PGC-1- α , both involved in calorie-restriction adaptation, were also increased, probably by activating AMP-activated protein Kinase in obese.

Major mechanisms involved in the anti-obesogenic effect of resveratrol



Several studies in the literature have addressed the potential anti-adipogenic effect of resveratrol under in vitro conditions. Many studies demonstrate that resveratrol shows anti-adipogenic effects at concentrations in the range of 20–100 μ M. This effect is observed in murine, porcine and human pre-adipocytes. There are marked differences among the reported studies in the treatment period length (24 h to 8 days), but in all cases resveratrol is able to inhibit adipogenesis. There is a good consensus concerning the mechanism of action underlying this effect. Thus, resveratrol inhibits C/EBP β , the early regulatory factor of adipogenesis. These changes can be

mediated by SIRT-1. ACC: Acetyl-CoA carboxylase; ACO: Acyl-CoA oxidase; BAT: Brown adipose tissue; C/EBP: CCAAT/enhancer-binding protein; CPT: Carnitine palmitoyltransferase; FASN: Fatty acid synthase; LPL: Lipoprotein lipase; PPAR: Peroxisome proliferator-activated receptor; UCP: Uncoupling protein; WAT: White adipose tissue.

P-0566

Effectiveness of phone recruitment on pneumococcal vaccination

Francisca Rivera Casares, Rahalf Martin Pineda Coronel, Sebastián García De León Chocano, Silvia Pérez López, Silvana Serrano Montagud, Pilar Lorente Lorente
Centro de Salud Fuensanta (Valencia)

Background

The indication for pneumococcal vaccine (PNV) is complex due to:

- Collective to be vaccinated with very different characteristics
- Complex vaccination guidelines
- Irregular involvement of specialized level.

Aim

To assess the effectiveness of phone recruitment as a method to improve the coverage of PNV in immunocompromised patients in a Health Center

Method

- Identification of immunocompromised patients with PNV indication (hematological cancer, advanced nephropathy, or moderate nephropathy with diabetes or nephrotic syndrome, transplant, HIV disease, prolonged immunosuppressive therapy, and other) from electronic records
- Review of previous doses of PNV
- Phone recruitment of the patient by nursing
- Review immunization records of these patients one year after

Results

458 cases were included, 55% women, mean age 68.3 years. Prevalence was 4.5/100. 7.4% were hematologic cancers, chronic renal 60.3%, 4.1% transplant, HIV disease 19.9%, 14.2% had immunosuppressive drugs and 0.2% other causes.

One year after the intervention, the proportion of patients with 2 or more doses of PNV 23-valent increased from 4.5% to 5.5%, with one dose from 17.7% to 42.8%, and non-vaccinated declined from 77.7% to 51.7%. Patients vaccinated with PNV 13-valent were 52.6% (previously none). Additionally, the annual average of dose of influenza vaccine increased from 0.52 to 0.60 ($p < 0.0001$).

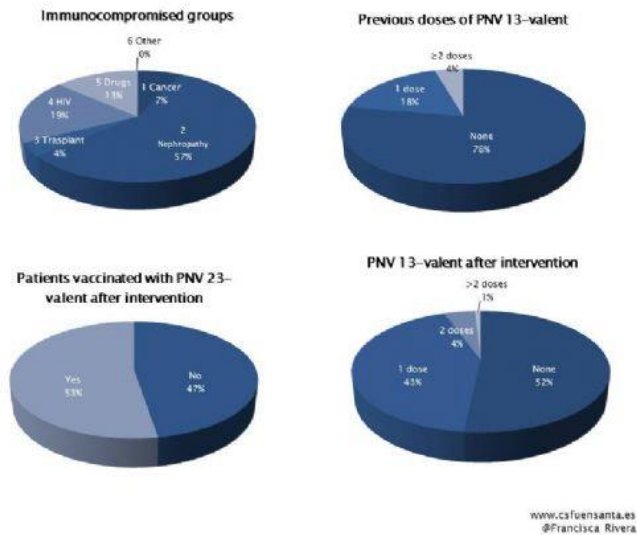
Conclusions

Phone recruitment for pneumococcal vaccination in adults is an acceptable and effective method.

Keywords: Pneumococcal vaccine, Phone recruitment, Health Center, Immunocompromised patients



Global results



P-0567

The significance of early detection, diagnosis and treatment of asymptomatic primary hyperparathyroidism in primary health care

Aleksandra Petar Jesic, Aleksandra Kosojevic, Ljiljana Jandric

Department of Family Medicine, Primary Health Care Centre Novi Beograd, Serbia

Primary hyperparathyroidism occurs as a result of increased and uncontrolled secretion of parathyroid hormone due to hyper function of one or more parathyroid glands, becoming the third most common endocrine disease with the highest incidence among women in the postmenopausal period with a prevalence of 21 / 1000 women aged between 55 and 75.

The patient (1953) comes to family doctor complaining of leg muscle and LS spine pain, constant fatigue, sleepiness, and occasional bloating and nausea.

Data from health records show that patient has been treated and undergone checkups for primary hypertension and acute gastritis.

Laboratory analysis:

Alkaline phosphates 51 U/L (100-290 U /L)

Potassium 3.9 mmol/l (4.0-5.2)

Other in reference limits

ECG: sinus rhythm, Fr 57/min, longer qt interval, shallow t waves

Ta 145/95 mm hg

Echo abdomen with no signs of renal calculi and gallbladder

Rtg l-s spine: signs of diffuse osteoporosis without cyst formation

Physiatrist:

Finding dEXA; t score l-s spine -2.6(Osteoporosis)

Ca in urine /24 h 10.22mmol/24 h (2.50-8.00)

P/S Calcium total 2.29 mmol/l (2.2-2.7)

P/S inorganic phosphate 0.83 mmol/ l (0.80-1.45)

Phosphate in urine /24 h 21.11 mmol/24 h (13-42)

PTH 118 pg/l (16-87)

Vitamin d 25 OH 133.1 (75-250)

Echo thyroid: Struma myxonodosa gl. Thyroidae.Eythyreosis

Therapy: Bisphosphonates + vitamin d3 + caco3

Endocrinologist: parathyroid gland scintigraphy: no signs of hyperplasia, adenoma or cancer

After two years of monitoring and 6 month checkups patient feels better without LS spine and muscle pain.

Control DEXA LS spine: -1.9 t score (Osteopenia)

PTH: 70.9(12-72)

Php is a rare disease that should always be monitored for postmenopausal women or dominant hypercalcaemia or hypercalciuria. Detailed history records, clinical examination of the patient along with timely diagnostic evaluation will lead to final diagnosis.

Keywords: hyperparathyroidism, parathyroid hormone, hypercalcaemia, diagnostic evaluation

P-0568

The Effect of Education on Anxiety Levels of Parents of Children with Serebral Palsi: A Randomized Controlled Study

Emine Hilal Seydel, Hülya Yıkılkan, Derya İren Akbıyık, Cenk Aypak, Süleyman Görpelioğlu

Department of Family Medicine, Dışkapı Yıldırım Beyazıt Training and Research Hospital, Ankara, Turkey

Most of the disabled and their relatives aren't able to take advantage of offered services and the rights given to the disabled. Stress and the anxiety levels were found high among the relatives of disabled. In our research, we aimed to investigate the families of the children with cerebral palsy (CP) living in Ankara, for the knowledge and satisfaction level about their legal and social rights and also the effect of education programme on their anxiety level.

Eighty eight parents of children from two different special training and rehabilitation centers having CP were included into our research. Their anxiety level was evaluated by State-Trait Anxiety Inventory (STAI). Randomly selected intervention group was given the education programme which included the disabled rights. After six weeks, both groups were re-taken the STAI. The change on anxiety levels of both groups were evaluated. At the end of the study, control group also took the same education.

Randomly selected 50 parents were the intervention group and 38 the control group. In terms of the services given to the disabled, 79.5% of the parents were not satisfied. When the knowledge, satisfaction level and the recommendations about education, health, rehabilitation, vocational education, employment and social aid were asked, it was clear that the services and the regulations were insufficient. Anxiety levels of both groups were high. There was a meaningful decrease in their anxiety level in the intervention group after six weeks. There was no change in the anxiety level of the control group.

The disabled rights and services given to the disabled are insufficient. They should be regulated according to the needs of the disabled and their relatives. Education programme was shown to decrease the anxiety level in our study. Education programmes in different fields aiming the needs of the relatives of disabled are recommended.

Keywords: Serebral Palsi, Parents, Education, Anxiety Levels

Table1. Anxiety levels of intervention and control groups before interference

		Intervention group (n=50) N (%)	Control group (n=38) N (%)	P value
SAI*	No anxiety	8 (%16)	7 (%18.5)	0.32
	Mild anxiety	12 (%24)	12 (%31.5)	
	High anxiety	30 (%60)	19 (%50)	
CAI**	No anxiety	5 (%10)	3 (%7.8)	0.53
	Mild anxiety	11 (%22)	6 (%15.7)	
	High anxiety	34 (%68)	29 (%76.3)	

*SAI: Situational Anxiety Inventory **CAI: Continuous Anxiety Inventory

Table 2. Comparison of first and last anxiety inventory results for intervention and control groups

		Intervention group	P value	Control group	P value
SAI*	First test	43.9±10.1	0.01	42.0±7.5	0.24
	Last test	38.2±9.7		41.1±9.8	
CAI**	First test	46.2±8.8	0.04	47.3±7.2	0.09
	Last test	43.1±8.8		46.6±8.2	

*SAI: Situational Anxiety Inventroy **CAI: Continuous Anxiety Inventory

P-0569

Evaluation of Colorectal Cancer Related Knowledge, Attitudes and Behaviours and Compliance to Occult Blood Test Among Individuals Over 50 Years Old

Sinem Aslan Karaoglu, Dilek Evcik Toprak

Şişli Hamidiye Etfal Eğitim Araştırma Hastanesi Aile Hekimliği Kliniği

The aim of the present study was to evaluate of the level of knowledge about colorectal cancer (CRC), factors those can be related with CRC and the compliance to the fecal occult blood test (FOBT) which is used for screening purposes in our country in individuals aged over 50 years old. A total of 283 patients between the ages of 50-75 years who applied to Sisli Hamidiye Etfal Hospital Family Medicine outpatient clinic with any reason between February 2014-October 2014 were included the study. Sociodemographic informations, knowledge, attitudes and behaviors related CRC and its screening were questioned. After mentioning the standard training brochures about CRC, we answered their questions related with this subject. The importance of FOBT was emphasized. The compliance of patients were evaluated by following whether they gave the FOBT. The average level of total knowledge score about CRC was 6.9 ± 2.6 . Although our advise screening with FOBT 60.4% (n=171) of participants did not had FOBT. Nearly %69,6 (n=39) of the participants who had family history of CRC, did not accept to have FOBT even though our recommends and specifying that they are risky. 11 (3.8%) of the participants made FOBT for three-tier as described. There were 10 people (3.5%) who were positive. One person who was positive and underwent a colonoscopy was diagnosed as CRC. There were 5 (1.8%) people who got bowel cancer-related information from their family physicians, and there were 6 people (2.1%) who got bowel cancer screening recommendations from their family physicians. Thus, the participants do not have enough knowledge about symptoms, risk factors, screening of CRC and CRC screening were recommended and performed with very low rate in primary care. Raising the awareness of people about CRC and its screening, especially with television and internet which are most followed media; better integration of family physicians in currently existing scan program of CRC and disseminating of the scanning program will increase the chance of prevention, early diagnosis and treatment.

Keywords: Colorectal cancer, cancer screening, fecal occult blood test

Evolution of flu vaccine coverage in pregnant women (2010-2014) in Valencian Community Spain

Jose Antonio Lluch Rodrigo¹, Ana María Alguacil Ramos², Rosa Martín Ivorra¹, Antonio Portero Alonso¹, Eliseo Pastor Villalba¹

¹Servicio de Salud Infantil y de la Mujer. Dirección General de Salud Pública. Valencia Spain

²Universidad Católica de Valencia San Vicente Mártir, Valencia Spain

Background and aim

Vaccination of pregnant women against influenza has been recommended since the 90s justified by increased hospitalizations when influenza affect pregnant women and also the possibility to protect the newborn against influenza by transfer of antibodies.

Following the 2009 influenza pandemic pregnancy was considered one of the groups at risk of complications from infection with influenza virus and vaccination is recommended in any trimester of pregnancy, given the absence of risks vaccination

In the Valencian Community health authorities offer free vaccination to all pregnant during the annual vaccination campaign against influenza in primary care centers

The aim of this study is to review the evolution of flu vaccine coverage in pregnant women in the last five seasons.

Method

The number of pregnant women vaccinated against influenza has been obtained from the data recorded in the system of vaccine information CV

The denominators were estimated from the data of births registered in the National Statistics Institute of Spain It has been estimated coverage (%) and confidence intervals at 95% for each of the study season.

Results

During the study period there have been a total of 236,197 births, and is estimating that 177,149 pregnancies have coincided with the vaccination period (October to December each year).

A total of 20163 pregnant women (11.38% coverage –CI95% ± 0.15-) were vaccinated. Seasonal coverage (CI95%) were 8.63 (± 0.28); 7.66 (± 0.27); 9.23 (± 0.30); 14.71 (± 0.38) and 17.88 (± 0.42) for each of the seasons from 2010-11 through 2014-15.

Conclusions.

Vaccination coverage against influenza in pregnancy remains very low despite the progressive increase that has been occurring since 2010

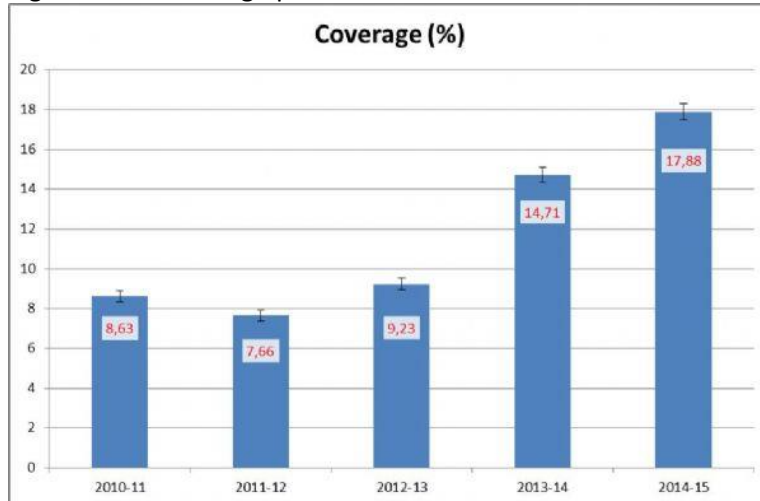
Specific strategies are needed to improve this coverage.

Keywords: Influenza, Pregnant women, vaccine

Figure 1. Awareness campaign



Figure 2. Flu coverage per season



Flu coverage (%) & CI 95%

P-0571

Pertussis vaccination pregnant women strategy in Valencian Community. Spain

Ana Maria Alguacil Ramos¹, Antonio Portero Alonso², Rosa Martín Ivorra², Eliseo Pastor Villalba², [José Antonio Lluçh Rodrigo](#)²

¹Universidad Católica de Valencia San Vicente Mártir. Valencia. Spain

²Servicio de Salud Infantil y de la Mujer. Dirección General de Salud Pública. Valencia. Spain

Background & Aim

The incidence of pertussis in Valencian Community (VC) has increased during last years. During the first 44 weeks of 2014 there were 500 cases; 60 of them were children aged less than 3 months (523 cases per 105; 81,7 % hospitalized; 3 died).

Since 1st January 2015 free dTpa vaccination is offered to pregnant women in their 27th through 36th week of pregnancy. It is recommended one dose of dTpa vaccine during each of the pregnancies. All immunizations may be registered in the Vaccination Information System (SIV)

VC Health Authorities hope to vaccinate around 27.000 women during the first year (60 % coverage).

It has been done pertussis vaccination scientific information by consensus with scientific and professional associations. It has also been make meetings with health professional and diffusion activities (including fact sheet).

The aim of this study is to present the preliminary results (coverage) of the programme.

Method

A descriptive retrospective study of pregnant women vaccinated against pertussis has been done. The coverage has been estimated using as denominator the new-borns during February and March 2015. We analyse the week of pregnancy in which they were vaccinated.

Information sources: SIV and the new-born screening registry.

Results

6,406 women were vaccinated during January and February 2015, while the estimated pregnancies were 7,117. The coverage value was 90.01 % (95%CI: 89.31-90.71). 90 % (95%CI: 89.45-90.91) of women have received the vaccine in the recommended gestational period, 1.64 % (95%CI:1.32-1.95) were vaccinated early and 8.18 % (95%CI: 7.51-8.85)after 36th week.

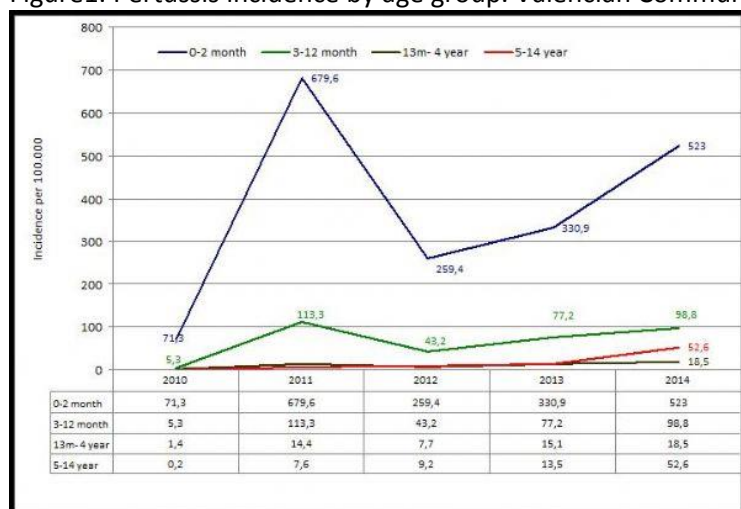
During the study period the Epidemiological Surveillance System has not detected any case of pertussis in young children.

Conclusions

Coverage results show excellent acceptance of vaccination, related both the importance of the problem as the developed actions. It seems that the effectiveness of the strategy will be very high.

Keywords: pertussis, vaccine, pregnancy

Figure 1. Pertussis incidence by age group. Valencian Community, 2010-2014



Incidence per 100.000

Table 1. Pertussis vaccination in pregnant women by gestational week

Gestational week	N	%
< 27 weeks	105	1,64
27-32 weeks	3148	49,14
33-36 weeks	2629	41,04
>36 weeks	524	8,18
Total	6406	100

Figure 2. Pertussis vaccination campaign. Valencian Community



Pertussis vaccination campaign target to pregnant women

Table 2. Pertussis vaccination in pregnant women by age group

Age group	N	%
15 - 24 years	533	8,32
25 - 34 years	3662	57,17
35 - 44 years	2186	34,12
45 - 49 years	25	0,39
Total	6406	100

P-0572

Patients with type 2 diabetes (MD) care in general practitioner practice

Mindaugas Paulius¹, Indrė Baužienė¹, Indrė Ličytė¹, Kazys Simanauskas¹, Eglė Simanauskienė²

¹Faculty of Medicine, Vilnius University, Lithuania

²Children’s Hospital, Affiliate of Vilnius University Hospital Santariskiu Klinikos

Objective. Increasing life expectancy, changing dietary habits and physical activity decreases the family doctor is a very urgent problem of type 2 diabetes care. The aim - to evaluate patients with type 2 diabetes, a family physician supervision practice.

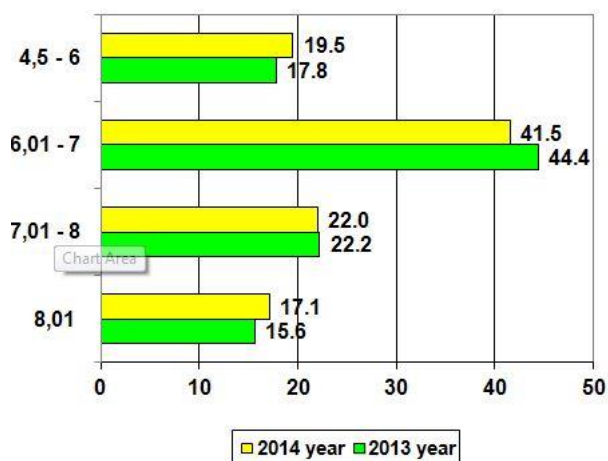
Materials and Methods. Onetime retrospective study was carried out, which was assessed in patients with type 2 diabetes care in 2013-2014 year (how much was carried out laboratory tests and how they were treated). A statistical analysis was done and the significance assessed by a X-square test. The statistical difference was considered spreads across if the p value was below 0.05.

Results. HbA1c has never been studied in 13% of all patients, 15% of all carried out every 3 months, and the majority of studied this indicator has been studied less frequently. HbA1c ≤7 percent were for the majority of all patients. Creatinine concentration has not been studied more than once a year up to 50%. Urea rated even lower proportion of patients. Half of the patients have not been studied lipids, only for three patients these parameters were in line with the objectives of the control of diabetes. According to treatment - oral (tablets) drugs accounted for 36 cases, insulin – 4, combination therapy (insulin and tablets) – for 6 patients.

Conclusions. Type 2 diabetes control in treatment should be carried out more actively in Vilnius University Hospital Santariškių Clinic’s Family Medicine Center. Glycosylated hemoglobin, lipids and renal function control is inadequate.

Keywords: Type 2 MD, MD control, MD treatment

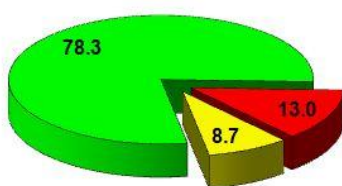
1 picture. HbA1c distribution between research (%)



1 table. Frequency of HbA1C detection

Frequency per year	2013 year		2014 year		Generally
	n	%	n	%	%
0	1	2,2	5	10,9	13.1
1	11	23,9	9	19,6	43.5
2	14	30,4	18	39,1	69.5
3	18	39,1	9	19,6	58.7
4	2	4,4	5	10,9	15.3

2 picture. Treatment methods (%)



■ Tablets	■ Tablets with insulin	■ Insulin
-----------	------------------------	-----------

2 table. Frequency of laboratory test measurement

Frequency per year	Creatinine	Cholesterol	Triacylglycerol	HDL	LDL
	%	%	%	%	%
0	41,3	54,3	63,0	65,2	67,4
1	47,8	26,1	19,6	21,7	19,6
2	6,5	13,0	13,0	8,7	8,7
3	4,3	4,3	4,3	4,3	4,3

P-0573

The relationship between lifestyle and depression of couples in primary care

Hyun Jung Bahk¹, Hye Ri Roh¹, Jung Ah Lee¹, Young Sik Kim¹, Jin Hee Kim², Hee Chul Kang³, Jong Myoung Kim⁴, Jae Kyoung Choi⁵, Yun Jun Yang⁶

¹Department of Family Medicine, University of Ulsan College of Medicine, Asan Medical Center, Seoul, Korea

²Department of Family Medicine, Good Samaritan Hospital, Pohang, Korea

³Department of Family medicine, Severance Hospital, Yonsei University College of Medicine, Seoul, Korea

⁴Department of Family medicine, Pocheon Hospital, Pocheon, Korea

⁵Department of Family medicine, Konkuk University Medical Center, Konkuk University College of Medicine, Seoul, Korea

⁶Department of Family medicine, Ilsan Paik Hospital,, Inje University College of Medicine, Ilsan, Korea

BACKGROUND: This study proposes to investigate the relationship between depression and lifestyle associated with health.

METHODS: Cross-sectional data from a total of 509 couples from primary care participants over forty years old in 2009-2011 were analyzed for this study. Depressive symptoms were defined as ≥ 25 points on the Center for Epidemiological Studies – Depression (CES-D) scale. A data of smoking, drinking, exercise, regular diet and breakfast intake was collected with self-administered questionnaire.

RESULTS: Participants have a depressive symptoms was 92(9.6%) persons in the 1018 samples. In the multivariate analysis, low income(OR 3.74, 95%CI 1.84-7.60), risky drinking(OR 2.23, 95%CI 1.12-4.41), few breakfast intake(OR 1.83, 95%CI 1.07-3.11) were associated with depression($p < 0.05$). But obesity was associated with 48.3% reduction in depression(OR 0.51, 95%CI 0.29-0.91, $P = 0.022$). Irregular diet, smoking, exercise were not associated with depression.

CONCLUSIONS: Risky drinking and few breakfast intake were significantly increased in participants with depression in primary care.

Keywords: Risky drinking, Breakfast intake, Depression, CES-D, Primary care

Table 1. Basic characteristics of study subjects

Characteristics		Male (n=509)	Female (n=509)
Age (years)	< 50	100(19.6)	129(25.3)
	50 - 59	140(27.5)	191(37.5)
	60 - 69	204(40.1)	173(34.0)
	≥ 70	65(12.8)	16(3.1)
Education (years)	> 12	301(59.4)	186(36.7)
	12	133(26.2)	187(36.9)
	< 12	73(14.4)	134(26.4)
BMI(kg/m ²)	< 18.5	15(3.2)	20(4.2)
	18.5 - 22.9	124(26.1)	165(35.0)
	23.0 - 24.9	134(28.2)	134(28.4)
	≥ 25.0	203(42.6)	153(32.4)
Smoking	never-smoker	123(24.2)	493(96.9)
	Ex-smoker	280(55.0)	8(1.6)
	current smoker	106(20.8)	8(1.6)
Alcohol	Non	121(24.4)	241(52.6)
	Moderate	230(46.4)	189(41.3)
	Risky	145(29.2)	28(6.1)
Exercise	Vigorous	189(37.1)	130(25.5)
	Moderate	110(21.6)	125(24.6)
	Non	210(41.3)	254(49.9)
Depression	No	457(89.8)	416(81.7)
	Yes	52(10.2)	93(18.3)
Hypertension	No	274(53.8)	334(65.6)
	Yes	235(46.2)	175(34.4)
Diabetes Mellitus	No	373(73.3)	443(87.2)
	Yes	136(26.7)	65(12.8)

Table 2. Comparison of Social factors according to depressed mood

Characteristics		Subjects with depression (n= 145)	Subjects without depression (n= 873)	Unadjusted OR (95% CI)	Adjusted OR† (95% CI)
Sex	male	52(35.9)	457(52.3)	1	1
	female	93(64.1)	416(47.7)	1.965(1.365-2.829)*	1.742(1.164-2.606)*
Age(years)	< 50	28(19.3)	201(23.0)	1	1
	50 - 59	55(37.9)	276(31.6)	1.431(0.876-2.335)	1.281(0.754-2.178)
	60 - 69	49(33.8)	328(37.6)	1.072(0.653-1.762)	0.756(0.434-1.318)
	≥ 70	13(9.0)	68(7.8)	1.372(0.673-2.800)	1.022(0.460-2.269)
Education	> 12	54(37.2)	433(49.8)	1	1
	12	46(31.7)	274(31.6)	1.346(0.883-2.052)	0.998(0.625-1.594)
	< 12	45(31.0)	162(18.6)	2.227(1.442-3.441)*	1.246(0.731-2.126)
Income	≥ 600	23(17.2)	255(29.9)	1	1
	400 - 599	27(20.1)	195(22.8)	1.535(0.854-2.760)	1.570(0.867-2.841)
	200 - 399	38(28.4)	256(30.0)	1.646(0.953-2.841)	1.700(0.968-2.986)
	< 200	46(34.3)	148(17.3)	3.446(2.008-5.913)*	3.472(1.901-6.340)*
Hypertension	No	63(64.3)	545(59.2)	1	1
	Yes	35(35.7)	375(40.8)	0.804(0.558-1.159)	0.777(0.511-1.179)
Diabetes Mellitus	No	116(80.6)	700(80.2)	1	1
	Yes	28(19.4)	173(19.8)	0.977(0.626-1.524)	1.135(0.699-1.844)

* P < 0.05 † Adjusted for sex, age, education and income.

Table 3. Comparison of lifestyle factors and health characteristics according to depressed mood

Characteristics	Subjects with depression (n= 145)	Subjects without depression (n= 873)	Unadjusted OR (95% CI)	Adjusted OR† (95% CI)	P value
BMI					
< 18.5	4(2.9)	31(3.8)	0.588 (0.199-1.738)	0.652 (0.215-1.980)	0.451
18.5-22.9	52(38.2)	237(29.2)	1	1	

23.0-24.9	43(31.6)	225(27.7)	0.871 (0.559-1.357)	1.056 (0.653-1.708)	0.825
≥ 25.0	37(27.2)	319(39.3)	0.529 (0.336-0.832)*	0.678 (0.416-1.106)	0.120
Smoking					
Non-smoker	127(87.6)	777(89.0)	1	1	
Current smoker	18(12.4)	96(11.0)	1.147 (0.670-1.963)	1.602 (0.865-2.970)	0.134
Alcohol					
Non	66(48.5)	296(36.2)	1.900 (1.260-2.866)*	1.450 (0.928-2.265)	0.103
Moderate	44(32.4)	375(45.8)	1	1	
Risky	26(19.1)	147(18.0)	1.507 (0.895-2.538)	2.123 (1.210-3.724)*	0.009
Exercise					
Vigorous	31(21.4)	288(33.0)	1	1	
Moderate	32(22.1)	203(23.3)	1.464 (0.866-2.477)	1.427 (0.831-2.452)	0.198
Non	82(56.6)	382(43.8)	1.994 (1.284-3.098)*	1.687 (1.060-2.685)*	0.027
Regular diet					
Daily/frequent	113(77.9)	783(89.7)	1	1	
Few	32(22.1)	90(10.3)	2.464 (1.572-3.860)*	2.157 (1.326-3.507)*	0.002
Breakfast intake					
Daily/frequent	110(75.9)	744(85.2)	1	1	
Few	35(24.1)	129(14.8)	1.835 (1.201-2.804)*	1.910 (1.199-3.040)*	0.006

* P < 0.05 † Adjusted for sex, age and income.

Women's Weight Loss Strategies In The Demographic, Social And Psycho-Emotional ContextVioleta Ozeraitiene¹, Daiva Makaraviciene², Sonata Varvuolyte³¹Department of Nursing and Fundamentals of Internal Medicine, Vilnius University, Lithuania²Department of Antakalnis Outpatient, GP Center, Vilnius, Lithuania³Baltupiai Family Medical Center, Vilnius, Lithuania

BACKGROUND: About 25-30% of normal weight women are reported to have tried to lose weight. We speculate that social pressure to be thin and women's psycho-emotional stress status could influence the weight loss strategies.

AIM: To assess the relationship between women's weight loss strategies and their psycho-emotional state, social and demographic factors.

Materials and methods. 120 females (average age 28.7±9.9) were interviewed in Vilnius Outpatient Center using a structured questionnaire and Reeder stress inventory scale (Chapman, & Coulson, 1968). Anthropometric parameters were evaluated too.

Results. Women were divided into: 1st group (≤30 years old; n=84; 70%) and 2nd group (>30 years old; n=36; 30%). 33 (27.5%) females had central obesity. 95 (79.2%) subjects were physically active on a daily basis, two-thirds of their sports activities lasted from 30 to 60 minutes. Only 29 (24.2%) of them did not experience stress. There was no significant difference ($p>0.05$) between the age and stress state. Young women constantly tended to be more physically active, chose different types of activities (aerobic, muscle stretch exercises, etc.) more than older ones. Older women were less physically active, their dieting lasted longer, with more trust in doctors and dietitians, however, they were also more prone to weight loss experiments. We found a statistically significant relationship between experienced stress level and weight/hip circumference, and body mass index (BMI).

Nutrition had a significant impact on the effectiveness of weight loss ($p < 0.05$).

Conclusions. Greater psycho-emotional stress is experienced by women with increased circumference of hips, BMI and weight. There is no significant difference between education level and weight loss strategies, between the age and stress state. Young women are more physical active, while older women are more prone to various experiments with weight loss and dieting. Nutrition had a significant impact on the effectiveness of weight loss too.

Keywords: weight loss, women, strategies, social-demographic, psycho-emotional

Table 1. Distribution of psychosocial stress ratings in both groups

Psychosocial stress rating	1st group n=84	2nd group n=36	χ^2
Stressful condition	26 (31%)	13 (36.1%)	$p>0.05$
Intermediate status	38 (45.5%)	14 (38.9%)	$p>0.05$
It is not stress	20 (23.5%)	9 (25%)	$p>0.05$

Table 2. The relationship between psychosocial stress and the patients parameters

Parameters	Correlation coefficient (r)	p
Age (y)	-0.030	>0.05
Height (m)	0.136	>0.05
Weight (kg)	-0.192	<0.05
Waist (cm)	-0.178	>0.05
Hip (cm)	-0.249	<0.01
BMI (kg/m ²)	-0.380	<0.01

P-0575

Tele-Care System of Body Temperature Monitor for Prevention of Dengue Fever in a Kindergarten

Chen Cheng Yang¹, Chen Cheng Yang², Chen Cheng Yang³, Chen Cheng Yang⁴, Chao Hung Kuo³, Chao Hung Kuo⁵

¹Community Health Promotion Center, Kaohsiung Municipal Cijin Hospital

²Department of Family Medicine, Kaohsiung Municipal Cijin Hospital

³Department of Internal Medicine, Kaohsiung Municipal Cijin Hospital

⁴Department of Family Medicine, Kaohsiung Medical University Hospital

⁵Department of Internal Medicine, Kaohsiung Medical University Hospital

Background and Aim

Dengue fever is an important issue in tropical medicine, which was broadly influenced in Cijin, Kaohsiung City, southern Taiwan. In 2014 summer, a huge outbreak of dengue fever was happened, which had affected more than 15000 cases according to Center for Disease Control, Taiwan. Children are easily influenced group, especially during school years. In school, a screening tool to checking the body temperature, a sign of dengue fever, become a convenient methods for care givers to notice the sick subjects. Our purpose is to investigate whether a tele-care system of body temperature measurement is effective to preventing dengue fever in kindergarten.

Methods

Twenty six children were recruited to our study after collection of informed consents of their parents. Body temperature was measured during weekdays by the tele-care system. The system consists of a clinical thermometer and a box for dealing with data. The data were sent to call center, where nurse can make real-time reaction to their teacher.

Results

During the intervention, no fever subjects were found, neither dengue fever was diagnosed. The average measurement number was 17.77 times in the 26 children. The average body temperature was 36.25°C, the maximum was 37.0°C while the minimum was 34.6°C. The missing data was because the participants were off during the weekdays. However, we phone children with missing data to make sure no one was influenced by dengue fever.

Conclusion

Cijin district is a sandbank belonged to Kaohsiung city, the initiation place where western medicine in Taiwan, advocated by Doctor Yage Ma in 1865. Nowadays, we started a new tele-care system for disease prevention in children. In conclusion, the system is successful in dengue fever prevention. We will continue promote the new technology for community health in the future.

Keywords: Tele-care, Dengue fever, Pediatric

School teacher monitor body temperature of child



The teacher in the kindergarten monitor child body temperature in early morning of school day

The tele-care box



This equipment is the tele-care box which can translate the body temperature to call center in Kaohsiung Medical University Hospital, where the nurse can monitor the vital signs of these participants.

P-0576

Physical activity and smoking behaviors among medical students of a Middle Eastern country

Lana El Osta¹, Nada El Osta¹, Badi El Osta²

¹Department of Public Health, School of Medicine, Saint-Joseph University, Beirut, Lebanon

²Georgia Regents University Cancer Center, Augusta, GA, USA

BACKGROUND AND AIM: Moderate physical exercises and non-smoking behaviors are relevant approaches to reduce the risk of cardiovascular diseases and malignancies, which are currently the major human health problems. And physicians are well positioned to provide physical activity and tobacco cessation counseling to patients. There is convincing evidence that clinical providers who themselves act on the advice they give provide better counseling and motivation of their patients to adopt such health advice.

The aim of this study was to determine the level of physical activity, tobacco smoking and alcohol consumption among Lebanese medical students, future health promoters.

METHODS: An observational cross-sectional survey using an anonymous structured self-administered questionnaire was conducted among 579 medical students (year I to internship program) at a major Lebanese school of medicine. Tobacco/alcohol consumers were defined as students who reported a daily use of tobacco and/or alcohol within the past year.

RESULTS: A total of 505 participants responded to the survey (response rate: 87.2%). The prevalence of tobacco use was 11.9%, and regular alcohol consumption was 5.3%. It was significantly higher among men and older students ($-p\text{-value}<0.0001$). More than half (58.7%) of the participants exercised once per week and more: male significantly more than women, younger students more than others ($-p\text{-value}<0.0001$). However, 15.9% of all participants rated themselves as physically inactive, mainly because of lack of time and energy. The majority (81%) of the students were aware of the importance that non-smoking status and adequate levels of physical activity confer on health.

CONCLUSION: Fortunately, our study revealed that our medical students, future health promoters, act on the advice they must provide. These results may have important implications for future studies evaluating the rate and quality of physical activity and smoking cessation counseling delivered by physicians.

Keywords: Physical Activity, Smoking Behavior, Health Promotion, Prevention

P-0577

Smoking as a risk factor for COPD

Amra Lasic, Neda Ferizovic, Elma Merdzanovic, Rasema Sehovic, Zlata Frasto, Dzenisa Ibisevic
Public Health Centre of Sarajevo Canton, Bosnia and Herzegovina

INTRODUCTION: The WHO estimates that 1.1 billion people worldwide smoke and that will increase to 1.6 billion by 2025. In underdeveloped and developing countries, COPD rates are growing alarmingly.

AIM: To investigate the effect of smoking on lung function of middle aged and younger patients without prior history of lung disease.

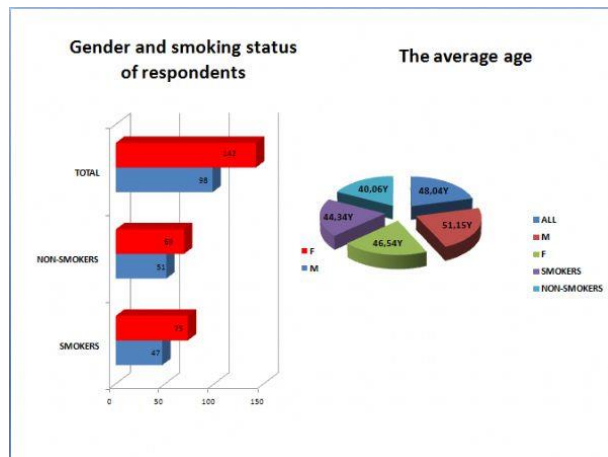
METHOD: Epidemiological research, done in 3 municipalities of Canton Sarajevo (September – December,2014) on 240 test subjects (120 smokers,120 non-smokers), age range 35 – 65. Smokers were divided into 3 subgroups based on the length of time they are smoke and the number of cigarettes smoked per day (up to 15Y, 16 – 35Y,over 35Y,up to 20 c/d, 21 – 40 c/d, over 40 c/d). Researching parameters: age, sex, smoking history, pulmonary function and the age of lungs measured with mini-spirometer (copd-6).

RESULTS: Of 240 patients, the average age of 48.04, SD 17.67., 142 women (73 -51.4% smokers) 98 men(47 - 47.9% smokers). All smokers smoke cigarettes on average 23.5 years 24.5 cigarettes/day. 40% of them smoke >15 years,> 21 cigarettes/day. 7.5% smoke >35 years, >30 cigarettes/day. 46.6% of smokers and 10.8% of non-smokers have index 1 obstruction (50% <FEV₁ <80%). According to the GOLD guidelines (FEV₁ / FEV₆ <0.73 and 50% <FEV₁ <80%) GOLD stage 2 COPD have 16 or 13.3% (10M6F) smokers (all smoking >15 years >21 cigarettes / day) and 1 (M) non-smoker. The average age of the lungs of smokers is 25 years higher than their average age while with non-smokers 9 years.

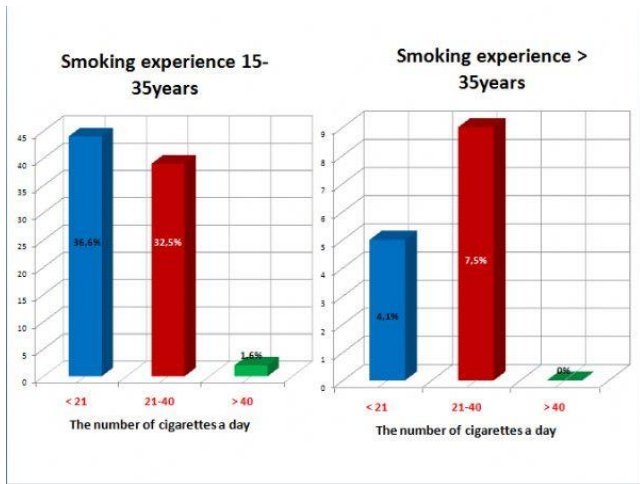
CONCLUSION: A significant difference in the measured Index 1 obstruction - 46% of smokers, while 10% of non-smokers, revealed 13,3% of COPD in smokers while 0.83% in non-smokers, as well as the higher age of the lungs of smokers, confirms the direct effect of smoking on lung function.

Keywords: COPD, smoking, risk factor, middle aged

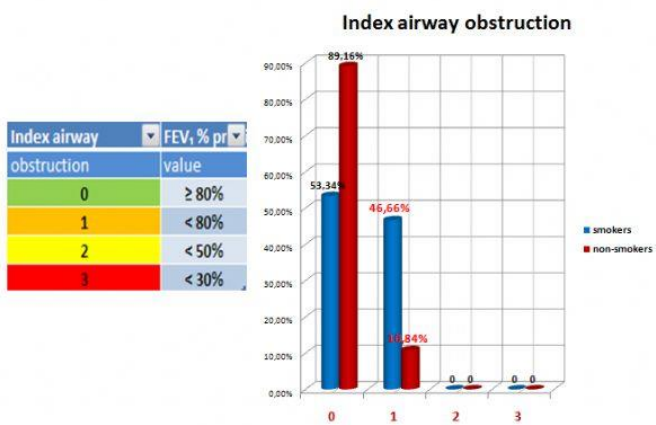
Tabele 1.



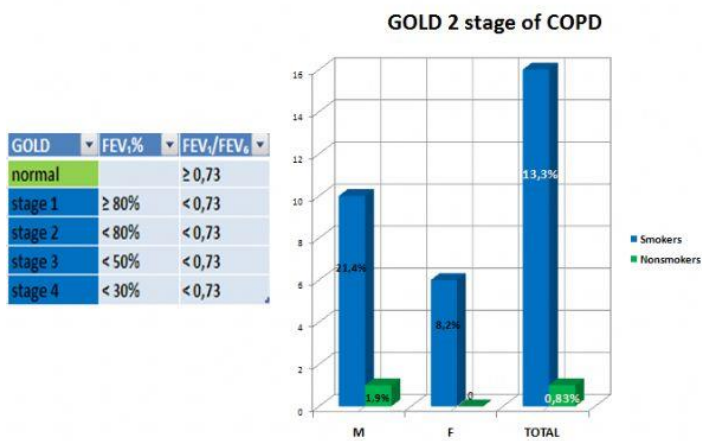
Tabele 2.



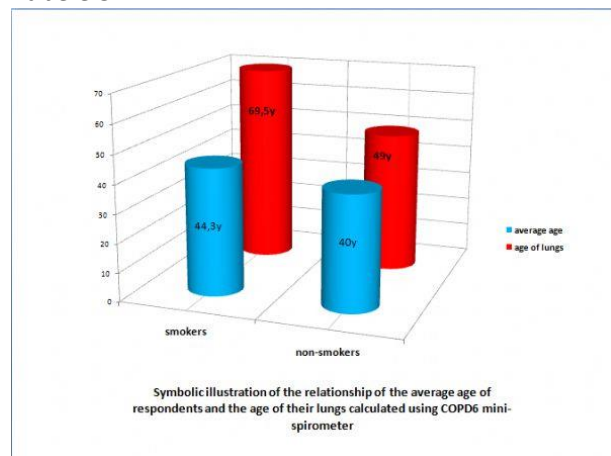
Tabele 3.



Tabele 4.



Tabele 5.



P-0578

Hepatocellular Cancer Case: Newly Diagnosed in a University Hospital Check-up Polyclinic

Fisun Sözen, Sinem Aydemir, Yasemin Çetinel, M. Gökhan Eminsoy
Department of Family Medicine, Baskent University, Ankara, Turkey

INTRODUCTION: Everyday many people go health checks even if they are healthy. Some thoughts, it may cause unnecessary diagnoses and tests which enhances the health anxiety. But most views agree that routine health checks lead to early diagnosis of the diseases and cost effective treatments. Hepatocellular carcinoma (HCC) is the fifth most common cancer in men and eighth most common cancer in women worldwide, resulting in at least 500.000 deaths per year. So, early diagnosis and treatment of HCC is important. We report a HCC case who admitted to the check-up polyclinic for his annual health check and having no symptoms.

CASE: A 75 year old man admitted to a check-up polyclinic for his annual health check-up. He had no complaints related to his health and declared that his last annual health check-up results were in normal limits. His past medical history revealed no chronic illness, no surgery, no allergies and no medications. He smoked 37.5 packages/year and drank 3-4 glass of raki/day. Family history; skin cancer, lung cancer. In his physical examination there were no significant abnormal findings. We performed blood tests, chest x-ray, echocardiography and all abdominal ultrasound. His laboratory tests revealed no any abnormal results except CRP, GGT, alkaline phosphatase high levels. In his chest x-ray there were multiple nodules, the echocardiography was normal, in the all abdominal ultrasound report; liver was in normal sizes, parenchymal echogenicity was normal; there was a hemangioma which required further evaluation. After clinical, laboratory and radiodiagnostic evaluation we thought that there could be a malignancy in his body. Then we oriented him to the other departments of our hospital. He got the HCC diagnosed and started to the treatment.

CONCLUSION: Worldwide the spread of the cancer cases are increased and it is important to diagnose the disease and started the treatment in asymptomatic period by the interpretation of detailed history, physical examination, blood and screening tests. With this case we emphasize that check-ups have an important role in early diagnose and treatment of the diseases.

Keywords: check-up, health check, hepatocellular carcinoma

Figure 1: Postero-anterior chest x-ray.

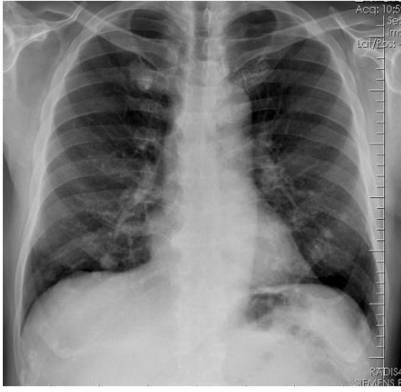
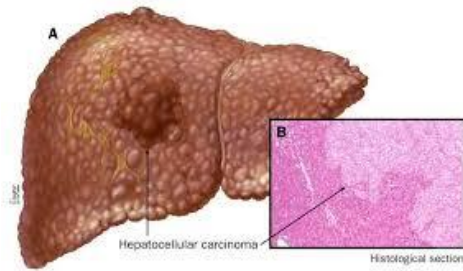


Figure 2: Representative image of Hepatocellular Cancer.



P-0579

The Diabetes Care Pathway in the General Practice in a Primary Care-Trust (Pct) In Rome

Anna Chiara Bianco¹, Eleonora Leoni², Gabriele Baccifava³

¹A.C. Bianco, Junior Doctor Trainee 2011-2014, ASLRME 5° Area, Lazio, Italy

²E. Leoni, Junior Doctor Trainee 2012-2015, ASLRME 5°Area, Lazio, Italy

³G. Baccifava, General Practitioner, ASLRME, Lazio, Italy

The diabetes care pathway (PDTA) consists in a cost effective care planning and management, used to improve medical assistance and to prevent short and long-term complications for patients.

Data were obtained from a General Practitioner (GP) database in the primary care trust (PCT- ASLRME) in Rome and recorded in a specific excel file. Diabetic patients were selected. The registered variables were: age, diabetes' management (start date of PDTA, successive specialist visit, duration of the disease), review of metabolic control (HbA1C, and blood glucose monitoring, therapy assessment), review of complications (diabetic retinopathy, microvascular complications, diabetic renal disease, diabetic neuropathy, cardiovascular risk factors, hyperlipidaemia, hypertension, feet problems, erectile dysfunction), the need of care manager support, and the patients' compliance values.

The patients involved were 74: the 96% of them were adherent to suggested diagnostic and therapeutic pathway. The non-adherent 4% was identified by GP through the "case finding" and quickly visited in the diabetic centre. Using standardized database of "PDTA", the GP can easily identified the non-target patients and improve the management of their disease. The PDTA makes connections between GP and specialist practitioners using diagnostic, therapeutic and educational established standard.

In conclusion our study suggests PDTA plays an important role in the management of chronic disease, leading to an improvement of quality of life, reduction of hospitalization and patients' satisfaction and compliance.

Keywords: Diabetes,PDTA,Care Management,General Practitioner

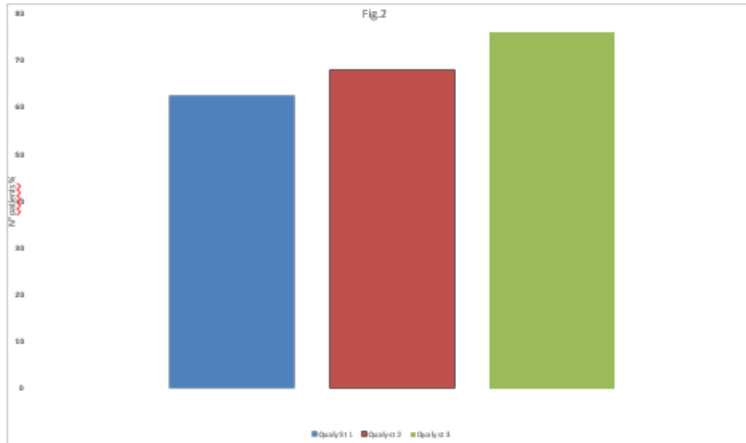
QUALITATIVE STANDARDS

FIG.1 QUALITATIVE STANDARDS (QUALY ST):

1. Number of patients aged 35-55 with Diabetes Mellitus type 2 with HbA1C<7%
2. Number of patients aged 55-70 with Diabetes Mellitus type 2 with HbA1C<7,5%
3. Number of patients aged 70-80 with Diabetes Mellitus type 2 with HbA1C<8%

qualitative standards of disease's management predefined by PTC-ASLRME

QUALY ST RESULTS



PERCENTAGE OF PATIENTS WHO REACH THE GOLD STANDARD VALUE OF QUALY ST

P-0580

Food and “Meds” – what a confusion

Maria Miguel Sá¹, Ana Margarida Pinho¹, Juliana Pais²

¹USF Famílias, ACeS Entre Douro e Vouga, Santa Maria da Feira, Portugal

²USF Cuidar, ACeS Entre Douro e Vouga, Santa Maria da Feira, Portugal

Background & Aim

Food is considered to be an important part of any and every culture around the world. What we eat, the quantity of food and the number of meals may bring several consequences to the health of each individual.

The existence of food-drug interaction is well known about, but many times forgotten both by physicians and patients. This interaction deserves especial attention especially if the results the certain treatments are called into question.

The purpose is to raise awareness for the importance of the drug-food interaction being that it represents a point of treatment failure, especially in Primary Care.

Method

Article search in several evidence-based medical databases using MeSH terms.

Results

Food-drug interactions can alter the purpose or the toxicity of one or both substances. These interactions can occur at several levels such as: absorption, pharmacodynamics, metabolism or renal elimination.

The absorption is the fase where most of this interaction occurs.

The pharmacodynamics demonstrate the relationship made between two compounds and it’s effect can be augmented (synergism), antagonized or can suffer enzymatic effects.

Alterations in the metabolism are another important point of this analysis because most drugs are metabolized in the liver, influenced by cytochromes which can also be affected by several foods.

The last point where this interaction can occur is at the renal elimination. These compounds can acidify the urine (which promotes a faster elimination of some drugs) or it can raise the pH level of urine facilitating the elimination of drugs with acidic proprieties (such as penicillin or warfarin).

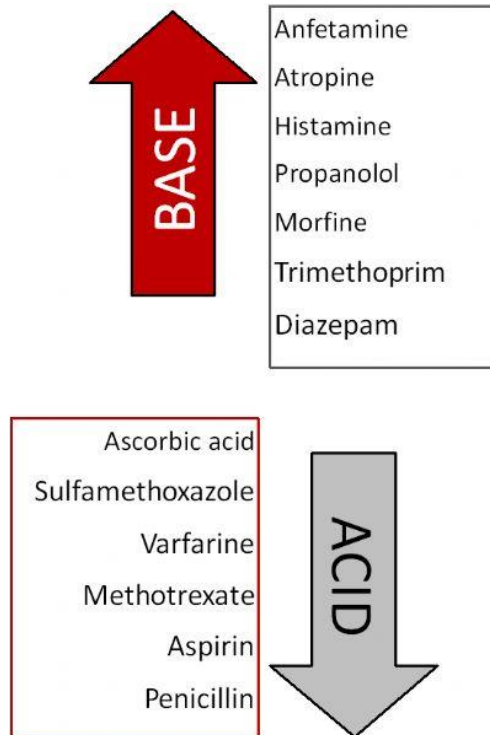
Conclusions

A healthy and proper doctor-patient relationship makes it easier to approach these issues and to answer the questions made by the patients.

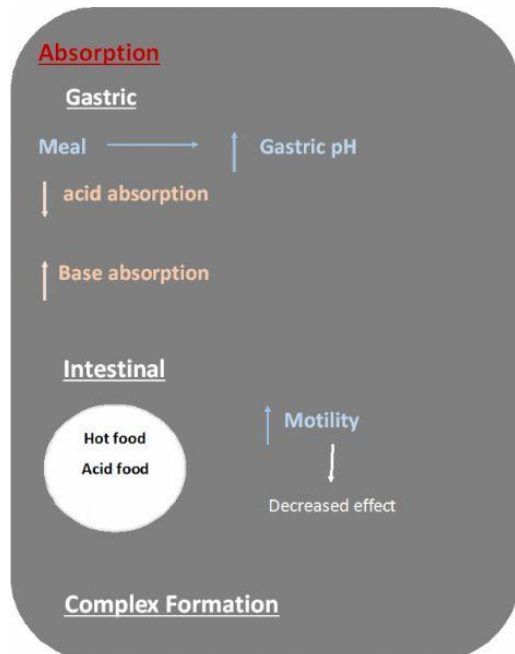
The family physician is a fundamental pillar when approaching this topic because of their especial relationship with their patients.

Keywords: Food-Drug Interaction, prevention, family physician

acid-base



Absortion



Pharmacodynamics

PHARMOCODYNAMICS

Synergistic

Antagonistic

Enzymatic Effect

Metabolism

Metabolism

Liver induction → Risk of therapeutic failure

Liver inhibition → Risk of intoxication

Renal Elimination

Renal elimination

Acidification of urine

- Slows the elimination of acids
- Speeds the elimination of bases

Alkalinization of urine

- Slows the elimination of bases
- Speeds the elimination of acids

P-0581

Structure of Public Health Nursing Work in Croatia: a Longitudinal Study 1996-2012

Dobrislav Šimić¹, Zvonimir Bendeković²

¹Family Practice »Dr. Dobrislav Šimić«, Bednja, Croatia

²Health Centre of the Varaždin County, Family Practice Lepoglava, Lepoglava, Croatia

Background & Aims

In Croatia, public health nurses (PHNs) have been members of family doctor (FD) teams for decades, performing a multifunctional and polyvalent scope of activities for the inhabitants of a catchment area. The number of visits to post-partum women, new-born babies, babies and small children are very well defined by the protocol, while the visits to other groups are not defined. The main aim of the study was to investigate the trends in the number and structure of PHN visits in the period from 1996 to 2012.

Methods

The data were obtained from Croatian Health Service Yearbooks. Data on the total number of visits and visits to the target population groups were collected for each year. The number of performed visits (visits “paid”) was compared to the number of visits prescribed by the protocol („estimated number of visits”).

Results

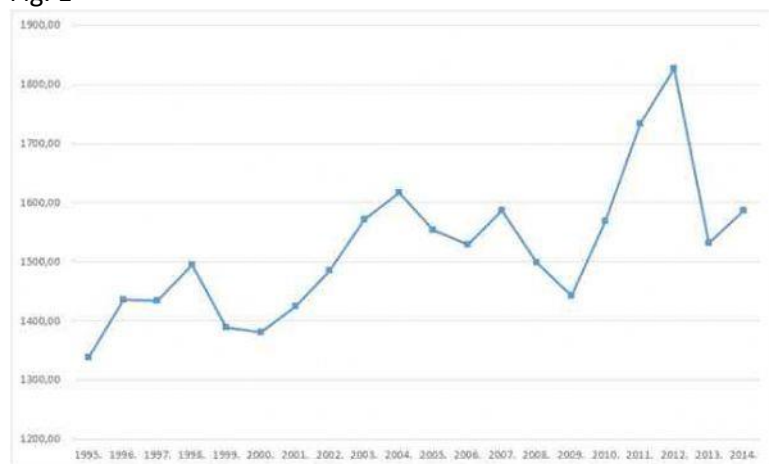
The obtained results indicate that the average number of visits per one PHN is relatively high, annually ranging between 1380.3 and 1826.5 visits, or between 5.5 and 7.3 visits daily. The structure of visits indicates that the visits fall out of the scope of PHN work, considering that prevention should be the main goal of public health nursing. More than 50% of visits involve visits to chronic patients. Drawing a comparison between the number of performed and estimated visits to women and children, it was found that visits to post-partum women and newborn babies were overrepresented, while visits to pregnant women and small children underrepresented.

Conclusions

The results strongly indicate that PHNs are overloaded by the number of visits, especially to chronic patients and mothers and new-born children. Bearing in mind different working conditions and differences in population needs, it will be worthwhile to reconsider the standards of PHN service.

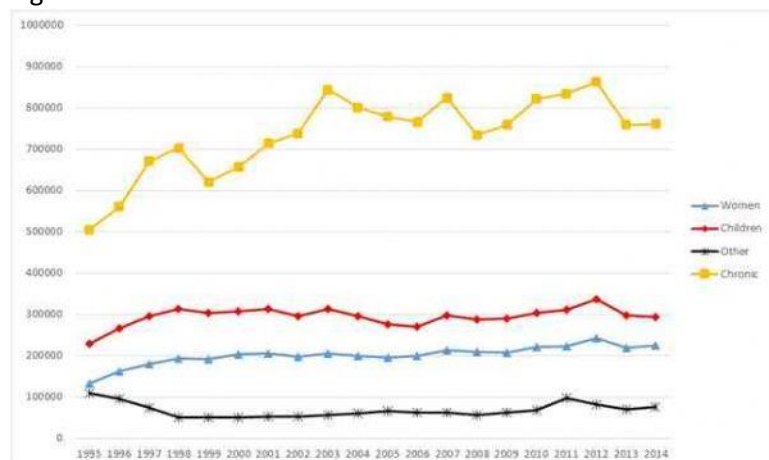
Keywords: public health nurse service, primary health care, public health, Croatia

Fig. 1



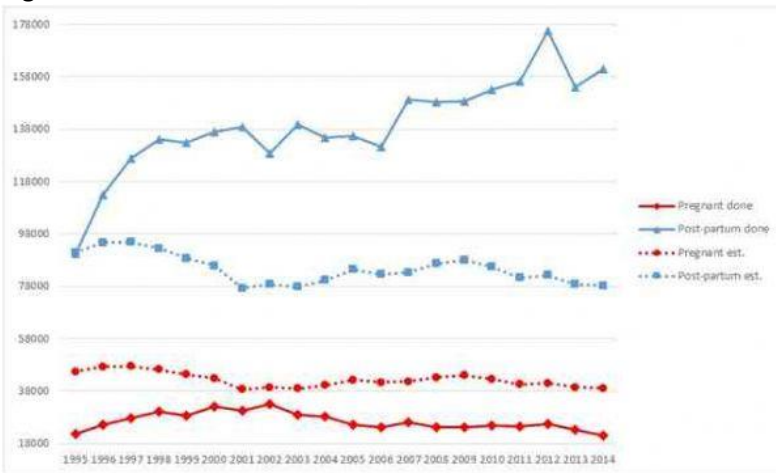
Number of annual visits per one public health nurse in Croatia, 1995-2014

Fig. 2



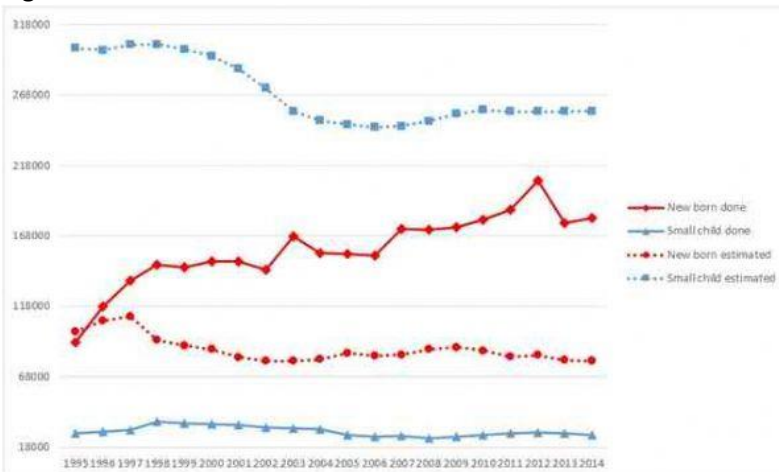
Trends in health public nurse visits in relations to the populations' groups in Croatia, 1995-2014

Fig. 3



A comparison of "done" and "estimated" number of public health nurse visits to pregnant women and post-partum women in Croatia, 1995-2014

Fig. 4



A comparison of "done" and "estimated" number of public health nurse visits to newborn babies and small children in Croatia, 1995-2014

P-0582

Evaluation of The Relationship Between Sociodemographic Characteristics and Night Shifts with Smoking Habit Among Sisli Hamidiye Etfal Training and Research Hospital Nurses Who Smoke

Serap Nizam, Dilek Toprak, Merve Müge Üçüncü

Department of Family Medicine, Sisli Hamidiye Etfal Training and Research Hospital, Istanbul, Turkey

AIM: Health staff is a profession group those should be role model for healthy life style to the community. In this study, we aimed to identify the relationship between sociodemographic characteristics and night shifts with smoking habit in Sisli Hamidiye Etfal Training and Research Hospital (SHETRH) nurses who smoke.

MATERIAL-METHODS: This study is a descriptive-analytic research. Data were collected in SHETRH staff nurses who smoke. A questionnaire included sociodemographic characteristics, working and night shift conditions, smoking habit features and Fagerstrom Nicotine Dependens Test (FNDT) were performed to the subjects. In SPSS17.0 program frequency, t test, and Chi-square were used for data analyzis.

RESULTS: 78% of subjects who participated in our study were women, 22% were male and the average age was $29,47 \pm 6.44$. While 18% were working in intensive care unit, 25% were staff in emergency service. 44% were married, and 74% had no child. Regarding the FNDT 70% of them identified as "medium/low level dependency",

30% as “high/very high dependency”. There was no significant relationship between the nicotine dependence and age, gender, marital status, number of children, income level, the presence of chronic disease, working duration and mother/father's cigarette use ($p > 0,05$). It was observed that as the education level increased, the age to start smoking were also increased ($p = 0.027$). The average age to start smoking was 18.52 ± 4.99 and 57% had started smoking before 18 years. Also nicotine dependency scores were significantly higher in this group than those who started smoking after the age of 18 ($p = 0.000$).

Weekend or weekday shifts were not related with the nicotine dependency scores and amount of daily smoking ($p > 0.05$).

Despite higher dependency scores, working in intensive units wasn't a significant factor ($p = 0.076$).

CONCLUSION: No relationship was observed between smoking habit and night shift number. Smoking health workers have to receive information and extra support for smoking cessation; by this way, they would be role model to the community.

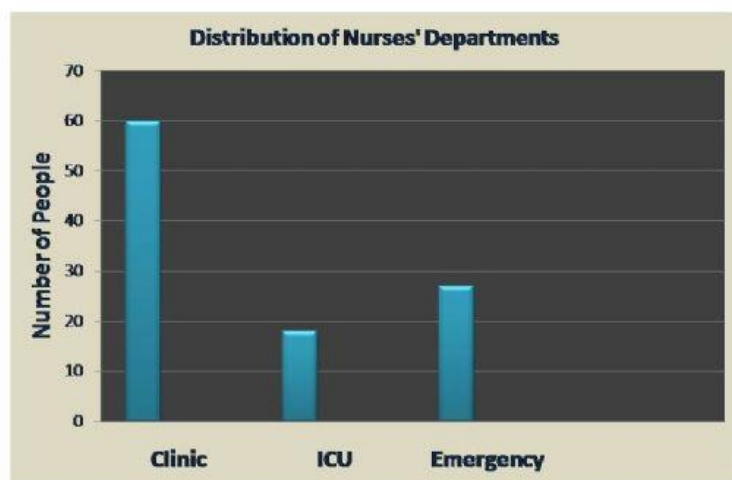
Keywords: smoking, nurse, night shift, nicotine dependency

Distribution of Night Shifts of Nurses

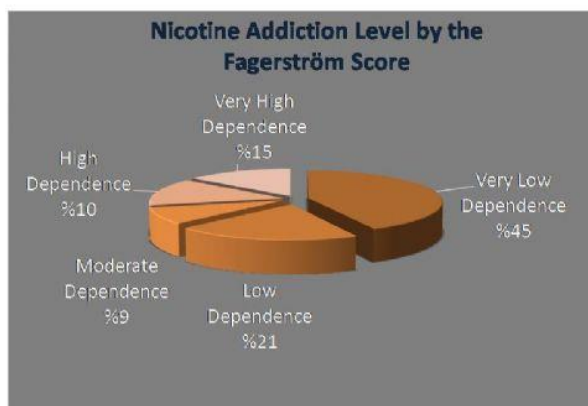


Figure 1. Distribution of Night Shifts of Nurses

Distribution of Nurses' Departments



Nicotine Addiction Level by the Fagerstr m Score



Relationship between nurses' Age of Onset of Smoking and Fagerstr m Nicotine Dependent Test Results

Table 1: Relationship between nurses' Age of Onset of Smoking and Fagerstr m Nicotine Dependent Test Results

	Age <18		Age >18		Total	
	n	%	n	%	n	%
Minimally to Moderate Dependent	27	%38	44	%62	71	%71
Highly Dependent	23	%79,3	6	%20,7	29	%29
P:0,000						

Relationship between nurses' department and Fagerstr m Nicotine Dependent Test Results

Table 2: Relationship between nurses' department and Fagerstr m Nicotine Dependent Test Results

		Minimally to Moderate Dependent (0-6 Points)		Highly Dependent (7-10Points)		Total	
		n	%	n	%	n	%
Department	Clinic	46	%80,7	11	%19,3	57	%57
	ICU	10	%55,6	8	%44,4	18	%18
	Emergency	15	%60	10	%40	25	%25
	Total	71	%71	18	%18	100	%100
P:0,046							

ICU: Intensive Care Unit

P-0583

Doctor, what about my thyroid?

Juliana Pais¹, Maria Miguel Sá², Ana Margarida Pinho²

¹USF Cuidar, ACeS Entre Douro e Vouga, Santa Maria da Feira, Portugal

²USF Famílias, ACeS Entre Douro e Vouga, Santa Maria da Feira, Portugal

BACKGROUND & AIM:

The thyroid pathology is one of the most common pathologies in the spectrum of the endocrine diseases. The disseminated use of ultrasonographic techniques serves as a first-line diagnosis of the thyroid nodular pathology. As general practitioners (GP) we are on a daily basis confronted with the patients' pressure to perform complementary exams, due to the fear of neoplasia.

The objective is to alert to the importance of this matter at the Primary Health Care (PHC). Review this subject after the emergence of a portuguese guideline from 2014, once this is frequently motive of consultation at the PHC.

METHOD:

Article research on the evidence-based medicine databases without date limitations using the MeSH terms.

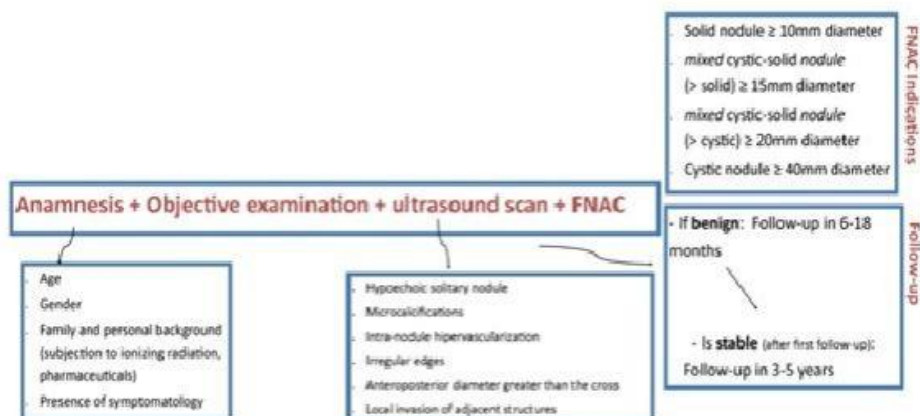
RESULTS:

The first approach to the thyroid pathology must consider its influencing factors, like age, gender, family and personal background, subjection to ionizing radiation, pharmaceuticals which interfere in the thyroid function and presence of symptomatology. The next step must be the objective examination, particularly the palpation of the thyroid and the cervical ganglion chains and then an analytical assessment of the thyroid function. The ultrasound scan serves, specially, to characterize the nodular pathology, as well as to assess the need of a fine-needle aspiration cytology (FNCA), while this last technique permits the diagnosis of malignancy.

CONCLUSIONS:

The monitoring of and decision to perform a FNAC must be done considering the patient's particular risk factors, as well as the presence of the symptomatology, changes revealed on the objective examination and the nodule's characteristics on the ultrasound scan assessment. As GP we must create a relationship with the patient that permits us to communicate and explain the relative neoplasia risk associated to the thyroid nodule, avoiding unnecessary exams and procedures and the anxiety related to the fear of cancer.

Keywords: Thyroid Nodule, Biopsy Fine-Needle, Thyroid Ultrasound



P-0584

Quality of Life of Patients After Acute Coronary Syndrome

Didem Kafadar¹, Fatma Gonul Dogan¹, Nüket Bayram Kayar¹, Muhammet Çömçe¹, Hasan Ayberk Çakırlar¹, Abdurrahman Polat¹, Burak Ayça², Mustafa Hakan Dinçkal²

¹Department of Family Medicine, Bagcilar Training and Research Hospital, Istanbul, Turkey

²Department of Cardiology, Bagcilar Training and Research Hospital, Istanbul, Turkey

Background & AIM: As treatments for chronic diseases have evolved, quality of life of patients has drawn attention. Cardiovascular diseases(CVD) have become a public health problem as they affect the quality of life(QoL) of patients. QoL is subjective and there are different aspects that define it. Short Form-36 Health Survey(SF-36), developed by Ware et al, represents eight health concepts. It has been widely used for both general population and different patient groups.

METHODS: The study was conducted with the patients admitted to cardiology and family medicine outpatient clinics who have had a history of hospitalization for ACS. Patient inclusion criteria were a history of angiography proved ACS. Sociodemographic features and laboratory values of the patients at the time of the survey procedure were recorded. To assess the health related quality of life of the patients SF-36 was used.

RESULTS: A total of 100 patients, 77(77%) men and 23 (23%)women completed the study. The mean age of the group was 60.38. 50% of patients were 60 or older. Different domains of the survey were compared. There were significant differences between physical functioning(PF), role limitation due to physical problems, bodily pain, mental health and general perception of health mean scores of men and women($p=0.001$, $p=0.036$, $p=0.001$, $p=0.048$, $p=0.019$ respectively). PF scores of patients under 60 years were significantly more than patients over 60($p<0.001$). Scores of social function(SF) were the highest among all domains in both men and women patients. **CONCLUSION:** SF domain being the highest score may be explained as Turkish family structure and strong relationships among patients' relatives. Men had higher scores for all domains revealing that QoL of women have been affected more. Chronic diseases have larger effect on QoL of women patients than men. SF-36 may be utilized by family physicians for biopsychosocial approaches towards patients with a ACS history.

Keywords: Quality of life, Acute coronary syndrome, Coronary angiography.

P-0585

The importance of stretching: Prevention of muscular injury in medical office

Carolina Martins Moreira¹, Pedro Pinho Caetano², Carlos Matos¹, Raquel Correia¹, Luis Afonso Vouga¹, Pedro Cantista¹

¹Serviço de Medicina Física e de Reabilitação - CHP

²USF Nova Via - CHVNG/E

Background & AIM:

Muscular injury is one of the major problems facing today's working population and doctors aren't an exception. In predominant desk based professions, people spend many hours per day in a sitting position. Family doctors are a clear example of this situation. After some hours of consultation, muscle soreness complaints are very frequent, and with the repetitive damage, muscle skeletal injuries are the immediate consequences.

It's known that increasing the flexibility of a muscle-tendon unit promotes better performances and decreases the number of injuries. As a result, it's imperative to use the most effective means to aid in deterring these injuries.

METHODS: Bibliography research and collected data in medical databases.

RESULTS: Literature shows that people who spend many hours in a sitting position, the majority of time in inadequate positions are at higher risk of developing muscle skeletal injuries.

Some randomized controlled interventions have been published showing that great part of this lesions are preventable with posture modifications and periodic intervals doing some simple but effective stretching exercises, necessary to maintain mobility, joint health and sustain a good posture that will reduce the formation of muscle contractors, the most frequent cause of muscle soreness.

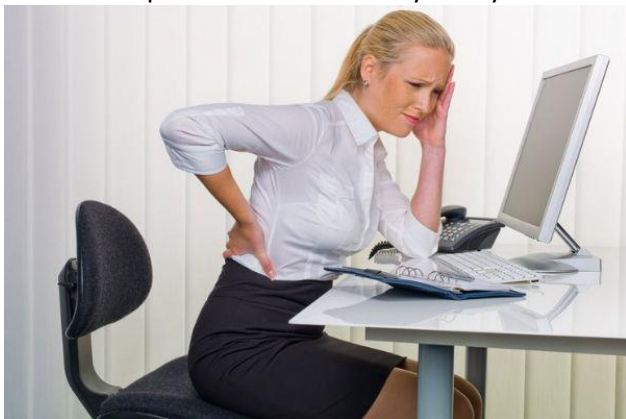
Although there's still some discrepancy in the optimal intensity, frequency and duration of the stretching protocols already published, some of these exercises were selected in an attempt to implement a simple stretching protocol to distribute among family doctors so they can do it in a short period of time in an interval between consultation.

CONCLUSIONS: Sedentary lifestyle can be considered as a silent epidemic in nowadays world population. Family doctors are increasingly included in this part of the population.

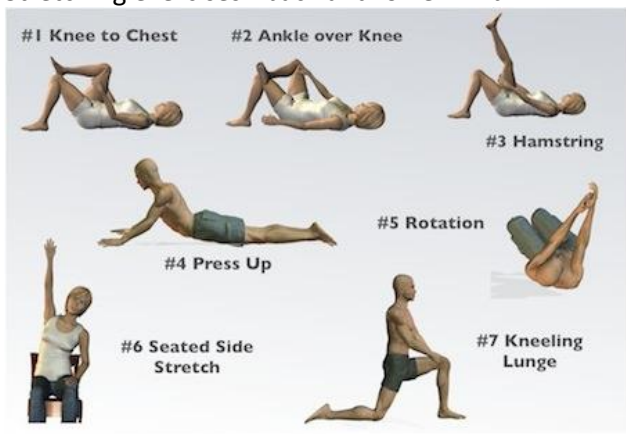
It is imperative to modify lifestyles, create new routines and promote the need of making frequent stretching exercises during a work day.

Keywords: stretching, musculoskeletal injury, sedentarism

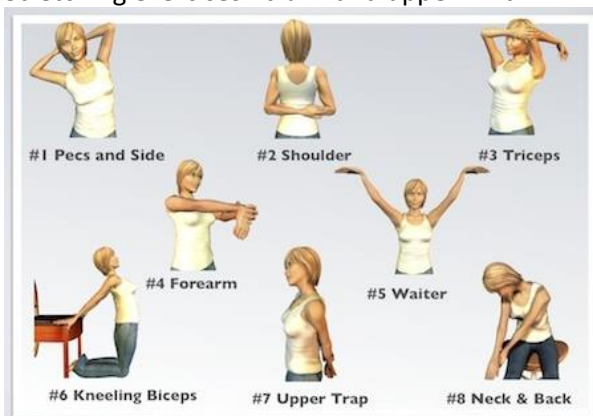
Desk based professions - sedentary lifestyle



Stretching exercises - back and lower limb



Stretching exercises - trunk and upper limb



P-0586

From space to medical office: Preventive measures in Osteoporosis

Carolina Martins Moreira¹, Pedro Pinho Caetano², Pedro Cantista¹

¹Serviço de Medicina Física e de Reabilitação - CHP

²USF Nova Via - CHVNG/E

Background & AIM:

Osteoporosis, a chronic and progressive disease of multifactorial etiology, is one of the most common metabolic bone diseases and can result in devastating physical, psychosocial, and economic consequences. Its hallmark is a reduction in skeletal mass caused by an imbalance between bone resorption and bone formation. A similar process occurs in microgravity and was (still is) one of the most difficult to mimic in an experimental setting. However, the research led to the design of the bed rest study as an analog for space flight that mimic microgravity and allows to study, in an controlled environment, new approaches in osteoporosis prevention and treatment.

METHOD: Systematic review in medical databases and lived experience from the author's internship in NASA-UTMB.

RESULTS: Currently, no treatment can completely reverse established osteoporosis. Early intervention with preventive measures can prevent osteoporosis in most people.

Many research have been done in this field, with a huge contribution from astronauts and from bed-rest study data, that shows the importance of exercise in osteoporosis prevention when compared to pharmacologic therapy isolated and also points the best exercise prescription for each situation.

It's important to connect all the information, in order to instruct the patient in a home-exercise program that incorporates the necessary elements for improving posture and overall physical fitness, such aerobic low-impact exercises or impact exercises, weight-bearing exercises or non-weight-bearing, high force exercise and balance training, in an individual program.

CONCLUSIONS: Osteoporosis is often undertreated, in large part because it can be clinically silent before manifesting as fracture. Thus, failure to identify at-risk patients may lead to tragic consequences.

Our gold standard for osteoporosis must focus on preventive measures, namely physical activity, education and rehabilitation that will affect patient outcome and quality of live.

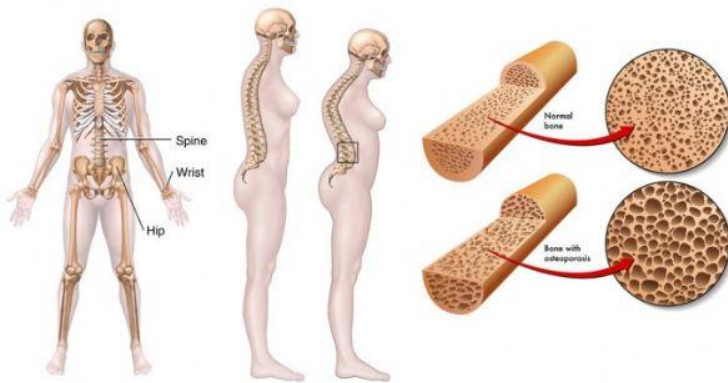
Keywords: Osteoporosis, bed rest study, physical activity

Bed rest study



Osteoporosis patophysiology

Osteoporosis



preventive measures - exercise



P-0587

Health Checks for Adults with Intellectual and Developmental Disabilities: Knowledge to Action

Ian Casson¹, Janet Durbin², Meg Gemmill¹, Laurie Greene³, Elizabeth Grier¹, Andrea Perry², Avra Selick², Yona Lunsky²

¹Department of Family Medicine, Queen's University, Kingston, Canada

²Centre for Addiction and Mental Health, Toronto, Canada

³Department of Family Medicine, University of Toronto, Toronto, Canada

Background & Aim

In 2011, Consensus Guidelines on the Primary Care of Adults with Developmental Disabilities¹ were published and distributed to all family physicians in Canada along with a book of clinical tools² to assist with guideline implementation. A key recommendation was to offer an annual comprehensive preventive care assessment, including physical exam - "Health Checks".

This recommendation was informed by international evidence regarding the benefits of Health Checks, along with recent Ontario, Canada data about primary health care in this population³. While adults with intellectual and developmental disabilities (IDD) have the same access to family physicians as adults without IDD, they have lower rates of preventive maneuvers and higher rates of emergency department visits and preventable hospital admissions.

Population health information and clinical practice guidelines provide knowledge for action. But moving guidelines into practice is complex. Implementation projects in three Family Health Teams in Ontario, Canada are evaluating how to put Health Checks into action.

This presentation will describe lessons learned, which may be helpful to other family physicians in enhancing care of adults with IDD in their practices.

Method

Data reflecting the implementation experience were collected through staff surveys, individual and group

interviews and patient medical record audits. Qualitative and quantitative analyses were done.

Results

Barriers and enablers to implementing Health Checks for adults with IDD were identified.

Conclusions

A local champion and a link to a current project in the family practice (e.g., quality improvement programming, outreach to other groups with problems in access to health care services) are helpful. Systematic efforts are required to identify adults with IDD within family practices and to facilitate appointments, especially for those patients without advocates. The content of Health Checks may take several patient encounters to accomplish, but that is consistent with the comprehensive, continuing care model of family practice.

Keywords: intellectual developmental disabilities, health checks, adults

Table 1 - Core components of Health Check

Core component of Health Check:	Process developed to deliver that component:
Identification of patients with IDD	Electronic medical record (EMR) search required verification by staff familiar with practices Diagnostic coding in EMR improved identification of patients in practice
Proactive invitation	Tasking a single clerical person to phone patients for Health Check appointments allowed that person to develop skills to adapt the invitation to needs of patient
Staff resources	Physicians benefitted from orientation and just-in-time resources in the EMR
Delivery of Health Check according to Guidelines	More time needed than usual appointment – shift to a chronic disease management model (e.g., follow-up appointments and an interprofessional team, if available)

The Health Check is a process, not a one-time appointment between a doctor and patient. Core components became evident as implementation progressed

Table 2: Self-described activities of family doctors who did Health Checks

Activity/behaviours:	Percent of respondents:
Modified approach to improve patient communication and comfort	75
Considered developmental functioning of patient	86
Reviewed preventive measures	73
Reviewed medical conditions for which persons with IDD are at risk	68
Involved other team members in care	54
Communication:	
Spoke directly to patient rather than primarily to caregiver	99
Chose appropriate language	98
Considered body language	89
Asked patient/caregiver for helpful strategies	88
Used visual aids or written instructions	54

Health checks were implemented - family doctors and nurses adapted to the special needs and carried out Health Checks according to Guidelines

Table 3 - Acceptability/Feasibility of Health Checks, according to family doctors who did Health Checks (survey respondents = 95)

	Percent of respondents
Health Checks fit with practice's mandate	94

Health Checks benefit persons with IDD 86
 Health Checks would be improved with a more explicit inter-professional approach 84
 Health Checks are feasible to provide given the required time, resources and training 68
 Clinicians and staff felt the Health Check could benefit patients and fit with practices' mandate, but some not were confident about the feasibility of providing Health Checks.

Table 4 – Effect of training on clinicians' and staff's self-assessment

	Percent response before training (N=117)	Percent response after training (N=148)
Felt prepared with skills and training to care for a person with DD	16	34
Familiar with Guidelines	41	71
Familiar with Guidelines Using Guidelines (among those familiar with them)	43	75

Family doctors felt positively about providing care to persons with IDD. But they did not feel knowledgeable about whom they should target, how to modify practice and how to access support or referral services. Training was helpful

P-0588

Analysis of Applications Made For Sports-Pool Medical Report to Family Medicine Clinic

Gulper Ozay, Fusun Artiran Igde, Mustafa F. Dikici, Fusun Yaris

Department of Family Medicine, Ondokuz Mayis University, Samsun, Turkey

BACKGROUND AND AIM: The event of death caused by undue strain during sport activities and occurring 30 seconds to 6 hours according to World Health Organization is called exercise-induced sudden death. This study's aim is to analyze the examinations and results of patients applying for having a medical report for sports-pool to the Ondokuz Mayis University Family Medicine Clinic.

METHOD: This is an incidence study belonging to the data of 195 people applied to the Family Medicine Clinic between November 02, 2011 and December 12, 2012 in order to have a medical report for pool and/or to do sports. In the course of data evaluation, SPSS packet program was used.

RESULTS: The 195 participants of the study included 103 (%53,8) women and 92 (%47,2) men. The average age was 22± 6,6 (10–51). While 158 (%81) people applied for the pool and sports report, 37 (%19) people applied only for sports report. When the blood pressure was measured, the results of 145 (%76,3) people out of 190 were normal. 9 (%4,6) people detected pathology out of 195 patients taken Electrocardiogram (ECG) were consulted to cardiology and were determined that there was not any health problems preventing him/her from doing sports. All 195 people who applied were given medical report stating that there was not any health problems preventing him/her from doing sports and/or swimming in the pool.

CONCLUSION: It is assumed that incidence of sudden cardiac death of young athletes is 0,5–1/100000 in a year. In order to prevent sudden death during and after exercise, it is required to have the history of the athlete and the 1st degree relatives, pay attention to physical examination, take electrocardiogram and, if necessary, determine the cardiovascular diseases by some exercise tests.

Keywords: sports, family practice, death, sudden cardiac

P-0589

Evaluation of The Disease Perception of Patients Who Consulted to Family Medicine Clinic

Gulper Ozay, Fusun Artiran Igde

Department of Family Medicine, Ondokuz Mayıs University, Samsun, Turkey

BACKGROUND AND AIM: Determining the views and perceptions of patients concerning the disease by using Disease Perception questionnaire and evaluating the relation between them and the decision given after consulting to the Family Medicine Clinic.

METHOD: In this cross-sectional study is a questionnaire applied on 57 patients who consulted to our Family Medicine Clinic between May 03-June 26, 2013 with the sociodemographic data. SPSS 21 package program used for the evaluation.

FINDINGS: The 57 participants of the study included 34(59,6) women and 23(40,4) men. The average age was $23,4 \pm 5,1$ (17-40). All 25 persons having signs of burning in the throat since the start of the disease out of 31 patients diagnosed with upper respiratory tract infections (URTI) considered that this symptom was related to the disease. 22 people out of 29 patients having headache considered that this symptom was related to the disease. When the reasons of the disease of the patients with URTI complaints were questioned, it was stated that the disease of 18 people's were cleaved into a microorganism, 11 people's were cleaved into decrease in body resistance. According to short disease perception measure; 4 (7) out of the 57 patients who consulted to our clinic stated that the disease had a serious affect on his/her life, 10 (17,5) of them stated that they had no control over the disease, 23 (40,4) of them stated that the treatment may be quite helpful for the disease.

CONCLUSION: Our study gives rise to thought that while determining a special treatment for the patient, taking into account the disease perception data will increase the participation of the patient in the treatment process and the success of the treatment.

Keywords: Disease, Perception, Patients, Primary Healthcare

P-0590

Evaluation of The Knowledge Level of The Faculty of Medicine Students at Ondokuz Mayıs University Concerning Sexually Transmitted Diseases

Gulper Ozay, Fusun Artiran Igde

Department of Family Medicine, Ondokuz Mayıs University, Samsun, Turkey

BACKGROUND AND AIM: We aimed to evaluate the knowledge level of students of the faculty of medicine at Ondokuz Mayıs University concerning sexually transmitted infections (STI) and on their differences in terms of sociodemographic variables.

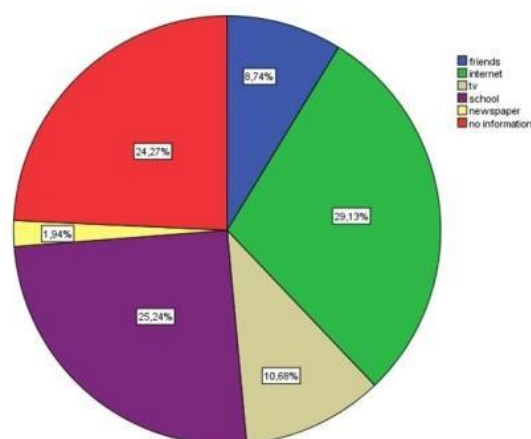
METHOD: In this cross-sectional study, sociodemographic datas which consisted of 26 questions and STI Information Test adapted from 40-question STI/Human Immunodeficiency Virus(HIV) Pretest that was used to determine sexual health education knowledge levels of students in Canada, was applied to 1st and 6th year undergraduate medical students at Ondokuz Mayıs University, between January 23, 2015 and February 24, 2015. The data was evaluated by using SPSS 20 program.

RESULTS: Among 103 participants, 81 (78,6) of them were in their 1st year and 22 (21,4) of them were in their 6th year. When the source of information was asked, 27 (33,3) of 1st year undergraduate students stated that they learn about STI on internet, 19 (86,3) of 6th year undergraduate students stated that they learned about STI at university. 64 (61,5) undergraduate students stated that information about STI should have been provided during high school education. The highest score one could get in the information test on STI was 36, the average correct answer of the participants which was converted into the score was $12,6(0-28) \pm 4,3$, average wrong answers was $13,6(0-21) \pm 4,9$, average no idea answers was $9,7(0-36) \pm 7$.

CONCLUSION: In this research we have found out that the knowledge level of participants on STI is insufficient in general. It is advised that awareness level on STI should be increased and sexual health education should be widespread with regards to accession to reliable information sources.

Keywords: Sexually Transmitted Diseases, Medical Students, Knowledge, Attitudes, Practice

How did the students find information about sexually transmitted disease



P-0591

Women, Call your Men! - Preventive care in the Slovak Republic

Beata Blahova¹, Jana Bendova², Peter Gazdik³, Kamila Bolanovska⁴, Melania Rynikova⁴, Eva Tarbajovska⁴, Michaela Machacova⁵, Stefan Krnac⁶

¹General practitioner, Krompachy, Slovak republic

²General practitioner, Velky Biel, Slovak republic

³General practitioner, Kapusany, Slovak republic

⁴General practitioner, Presov, Slovak republic

⁵General practitioner, Topolcany, Slovak republic

⁶General practitioner, Hrinova, Slovak republic

BACKGROUND: The number of cardiovascular diseases and cancer are all increasing in the Slovak Republic with cardiovascular diseases the first and cancer the second leading cause of death. One method of reducing the mortality of this disease is through earlier diagnosis. That is why preventive care is so important. According to demographics there are more men than women aged under 50 and more women than men over 50. Many doctors have observed that fewer men visit doctors' offices than women.

AIM: The first aim of the study is to find out how many men and women undergo preventive examinations. The second is to try to raise this number through women, who we know to be more frequent visitors.

METHODS: 7 medical offices participated in our cross sectional study. 1757 patients underwent a routine biennial preventive examination. Screening of colorectal carcinoma was performed in 871 patients. The first phase was performed from January to June 30th 2014. The second phase will be performed from January to June 2015.

RESULTS: We found that of 1757 examined patients, 1078 (61.3%) women and 679 (38.64%) men. Of the 871 patients screened for colorectal carcinoma 547 (62.8%) were women and 324 (37.1%) men. The second stage of our research is now in process. We will publish our findings for the second stage in July 2015.

CONCLUSION: Knowing that women visit medical offices more often than men, we decided to act through them. We designed a poster which is on display in our offices and we also verbally invite men through women, who are encouraged to call their male relatives and friends. Although according to demographic trends there are more women than men over the age of 50, the difference in numbers is not as big as the difference between numbers of women and men being examined.

Keywords: preventive, women, men, colorectal carcinoma

Call your men



Knowing that women visit medical offices more often than men, we decided to act through them. We designed a poster which is on display in our offices and we also verbally invite men through women, who are encouraged to call their male relatives and friends.

P-0592

Epidemiological profile in HIV-infected patients who start antiretroviral therapy

María Fernández Zambrano¹, María Cristina Garrido Laguna¹, Javier Pérez Stachowski², Javier De La Torre Lima²

¹General Practitioner, Hospital Costal del Sol, Marbella, Andalucía, SPAIN

²Department of internal medicine, Hospital Costa del Sol, Marbella, Andalucía, SPAIN

OBJECTIVE: To analyze the epidemiological profile at present in HIV-infected patients who start antiretroviral therapy (ART).

METHODS: A retrospective observational study was performed on adult HIV-infected patients who began their first ART regimen from 1 January 2012 to 1 January 2014 in Costa del Sol (South of Spain). Descriptive statistics were obtained using frequency tables for the categorical variables and measures of central tendency and dispersion for the quantitative ones (median and interquartile range-IQR)

RESULTS:

664 patients were included, 572 males and 92 women. The average age for diagnosis was 37 years (+/- 10 SD). Regarding HIV risk factors, we found 6.8% of IDUs, 31.8% heterosexual and 57.21% homosexual.

At the beginning of the treatment we obtained an average of 326 CD4. 50% of the patients at diagnosis were less than 350 CD4. Regarding hepatotropic virus serology, 43 (6.5%) were HBsAg + and 50 (7.5%) HCV RNA +. The treatment of choice for first-line ART was efavirenz / emtricitabine / tenofovir on 36% of patients, followed by Efavirenz (12.3%) and Emtricitabine / Tenofovir disoproxil / Darunavir (12.3 %). The average lead time from the diagnosis to the start of the treatment was 4 months.

CONCLUSIONS:

Among the patients in our HIV-naive cohort, a majority of infected males were found, the higher percentage of them were homosexual, and we have also observed a decrease on infected addicted to intravenous drugs.

At the moment of diagnosis, the average age was 37 years old and the mean CD4 in half of the patients were less than 350 CD4, what may cause serious infections, so we consider it a late diagnosis.

Respecting the treatment, we can conclude that an early ART was initiated and the response to this was very positive.

Keywords: HIV, Antiretroviral therapy, epidemiological profile

Average age at the moment of diagnosis

The average age at the moment of diagnosis was 37 years old.

Frecuencias

Estadísticos

Edad (Inicio tt.)

N	Válidos	664
	Perdidos	0
Media		37,4127
Desv. típ.		10,05632
Mínimo		18,00
Máximo		74,00

Sex, hepatotropic virus serology, HIV risk factor, AIDS

Estadísticos

	HOSPITAL	SEXO	RNA VHC	HBsAg	FACTOR RIESGO VIH	DIAGNÓSTICO SIDA
N	Válidos	664	664	652	640	636
	Perdidos	0	0	12	24	28
						664

Tabla de frecuencia

SEXO

	Frecuencia	Porcentaje	Porcentaje válido	Porcentaje acumulado
Válidos				
	VARON	572	86,1	86,1
	MUJER	92	13,9	100,0
	Total	664	100,0	100,0

RNA VHC

	Frecuencia	Porcentaje	Porcentaje válido	Porcentaje acumulado
Válidos				
	SI	50	7,5	7,7
	NO	602	90,7	92,3
	Total		652	98,2
Perdidos	DESCONOCIDO Sistema	11	1,7	
		1	,2	
	Total		12	1,8
Total		664	100,0	

HBsAg

	Frecuencia	Porcentaje	Porcentaje válido	Porcentaje acumulado
Válidos				
	SI	43	6,5	6,7
	NO	597	89,9	93,3
	Total		640	96,4
Perdidos	DESCONOCIDO	24	3,6	
Total		664	100,0	

FACTOR RIESGO VIH

	Frecuencia	Porcentaje	Porcentaje válido	Porcentaje acumulado
Válidos				
	ADVP	45	6,8	7,1
	HTX	211	31,8	40,3
	HMX	390	57,2	59,7
	Total		636	95,8
Perdidos	DESCONOCIDO	28	4,2	
Total		664	100,0	

DIAGNÓSTICO SIDA

	Frecuencia	Porcentaje	Porcentaje válido	Porcentaje acumulado
Válidos				
	SI	109	16,4	16,4
	NO	555	83,6	100,0
	Total	664	100,0	100,0

Sex, hepatotropic virus serology, HIV risk factor, AIDS

P-0593

Workplace stressors and its effects to perception of depersonalization and job dissatisfaction in physicians

Nurka Pranjic¹, Sanda Kreitmayer Pestic², Ljiljana Maleš Bilić³, Anja Pranjic⁴

¹Department of Occupational Medicine, Tuzla University School of Medicine, Tuzla, Bosnia and Herzegovina

²Educational Centre of Family Medicine, Tuzla University School of Medicine, Tuzla, Bosnia and Herzegovina

³Department of Occupational Medicine, School of Medicine, Banja Luka University, School of Medicine, Banja Luka, Bosnia and Herzegovina

⁴Postgraduate study of Faculty of Economics of University of Tuzla, Tuzla, Bosnia and Herzegovina

Depersonalization is described as suffering from episodes of surreal experiences. Some of these experiences have been also reminiscent of panic attacks and paroxysmal anxiety.

AIM: To examine the prevalence of workplace stress, depersonalization and job dissatisfaction; to assess the association between differential levels of distress and job dissatisfaction on depersonalization among physicians in Bosnia and Herzegovina.

METHODS: A cross-sectional study was conducted in period January 2014- January 2015. Questionnaires were distributed to a convenience sample of 715 physicians employed in Hospital Clinical Centers and Health Centers in Tuzla Region. The response rate was 71% (n=511). Data were collected using the Occupational Stress Assessment Questionnaire (OSQ) and the Maslach- Burnout Inventory.

RESULTS: Twenty three percent of respondents (n=511) reported a high level of workplace stress, 13% perceived a high level of job dissatisfaction and 15% a high level of depersonalization. Feeling of moderate level of depersonalization was present in about 49% of respondents (about half of physicians). Perception of depersonalization predicted following stressors: need to using knowledge and skills during working tasks ($\beta=0.132$; 95% CI, -0.032-0.508) and work has phases that are too difficult ($\beta=0.136$; 95% CI, -0.001-0.574). Job dissatisfaction was predictor for perception of depersonalization ($\beta=0.238$; 95% CI, 0.236-0.816).

CONCLUSION: The study results underline the importance of continued education, work organization, improving job satisfaction on way to protect development of depersonalization in physicians.

Keywords: depersonalization, distress, job dissatisfaction, physicians

P-0594

Comparison of knowledge, attitude and practice of premarital thalassemia screening among thalassemia patients and public at Selangor: a protocol paper

Dayangku Hayaty Awg Dzulkarnain, Maliza Mawardi, Puteri Shanaz Jahn Kassim, Sazlina Shariff Ghazali

Department of Family Medicine, Universiti Putra Malaysia, Serdang, Selangor, Malaysia

INTRODUCTION: Thalassemia is a public health problem in Malaysia. Since the implementation of National Thalassemia Screening in Malaysia in 2004, the response towards thalassemia screening was poor and there were few studies done in Malaysia shows lack of public awareness against thalassemia screening. However there is no specific study focus at comparison of knowledge, attitude and practice towards premarital thalassemia screening especially at young adult population between those who are diagnosed with thalassemia and public who never been screened. The main objectives of this study is to determine the gap of knowledge, attitude and practice of premarital thalassemia screening among thalassemia patients and public for future justification and recommendation for mandatory premarital screening in Malaysia.

METHODS: This is a cross sectional study conducted on thalassemia patients who attended thalassemia day care clinic at Hospital Ampang and individual who attended government health clinic in district of Hulu Langat. This study will be conducted for 24 months and expected data collection is in July 2015 till January 2016. Estimated sample size is 800(400 from thalassemia patients who attended thalassemia day care clinic at Hospital Ampang and 400 individual who attended government health clinic in district of Hulu Langat). The questionnaires that will be used in this study are include the information of socio-demography, knowledge, attitude and practice towards pre-marital thalassemia screening. Data will be analysed using SPSS 21.

CONCLUSION: The outcome of this study will be a pillar for development of model of intervention of knowledge, attitude and practice towards premarital thalassemia screening in future.

Keywords: Thalassemia, knowledge, attitude, practice

P-0595

educational intervention improving the screening and classification of obesity and overweight in a primary health care centre

Anna Forcada Arcarons, Laura Almendros Plana, Silvia Altimiras Rovira, Josefa Soler Arau, Diana Sanchez Martinez, Engracia Costa Atienza, Alícia Díaz Pilco
institut català de la salut

BACKGROUND

An excess of body fat is a public health problem that affects 49.2% of the population (35.9% overweight and 13.9% obesity) according to the health survey of Catalonia and provides increased morbidity and mortality in persons who suffer. The body mass index (BMI) is widely used for the diagnosis of overweight and obesity.

AIM

Determine whether an educational intervention improves the registration of obesity, overweight and BMI. There is an under-diagnosis' record of these pathologies in our Primary Health Care Area. The prevalence in our area of body fat's excess in last April was of 12.41%.

METHODOLOGY

Study before and after an Educational Intervention made to the team and led to the health professionals. This Intervention consisted in remember the management of these pathologies and how to catalogue in our informatic program.

Determine the new prevalence of body fat's excess after Intervention and analyze if improves its record in the computer program: full intelligence active program eCap (registration BMI), and logging diagnostic codes (overweight and obesity).

RESULTS

There is an increase in the diagnosis of obesity and overweight after intervention. The baseline prevalence was 12,41% and 12,82% of the final.

Incident cases: there are 78 new cases, compared to the prevalent represent 3,7%.

CONCLUSIONS

The educational intervention can increase the record of these diseases although in our study is not statistically significant. We need other strategies to raise professionals, because it's a modifiable health problem that is related to many other important diseases (Diabetes, Hypertension...).

Between the intervention and analysis of the data was not long so perhaps was the cause of not statistically significant.

Keywords: Screening, obesity, primary health care.

P-0596

Measurement of neck perimeter as a predictor os cardiovascular risk

José Carlos Sánchez Perez, Nayade Jorge Matin, José Ángel Sanchez Ortiz, Maria Ángeles Castaño Fuentes, Maria Rosa Sánchez Perez, Rocio Gil Ruiz
Andalusian Health Service

OBJECTIVE:

Studying the capacity of the measurement of neck perimeter as predictor of cardiovascular risk in patients with obesity, arterial hypertension, dyslipidemia, type 2 diabetes and/or tobacco use.

MATERIALS-METHODS:

Random samples were obtained from patients at 10 health clinics, all of whom presented some cardiovascular risk factors: arterial hypertension, dyslipidemia, obesity, type 2 diabetes and tobacco use. The following parameters were measured: age, sex, weight, waist size and bodily mass index (BMI), abdominal perimeter, neck perimeter. The samples were divided according to obesity: obese patients (BMI > 30) and not obese patients (BMI < 30). The inferential statistics were recorded with R commader program,

RESULTS:

The samples were of 251 individuals, 117 men (46,61%) and 134 women (53,39%).They were separated into 2 groups according to BMI, 120 obese (47,81%) and 131 not obese (52,19%).No statistical differences was found between the 2 groups related to the following parameters: age, sex, waist size and tobacco use.

There was, however, a significant difference found between the average neck ann abdominal perimeters of the 2 groups.Analysis of correlation between 3 variables: BMI, neck perimeter and abdominal perimeter, was record (table 1).Linear regression between neck and abdominal perimeter was analyzed with de following equation:
Abdominal Perimeter: $45,67 + 150 \text{ neck perimeter}$.

CONCLUSIONS:

A correlation exists between BMI, abdominal perimeter and neck perimeter.It would be convenient to pursue an enhanced study with a greater sample size to obtain more significant statistical data, hereby enabling the establishment of a more precise correlation.
It would already have practical importance that neck perimeter is faster and easier to obtain in a clic that BMI or abdominal perimeter.

Keywords: Neck perimeter, Abdominal perimeter, Bodily Mass Index (BMI)

Figure 1

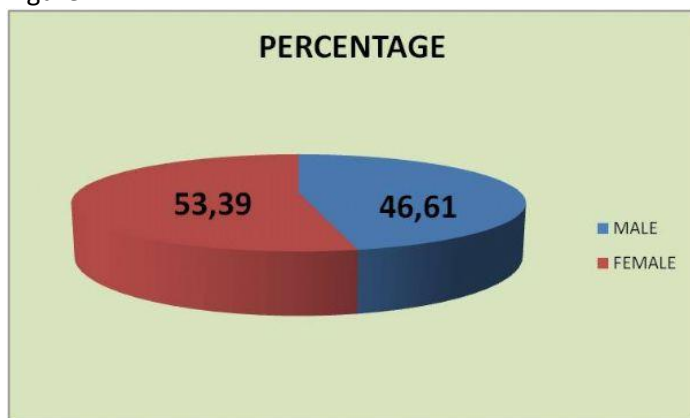


Figure 2

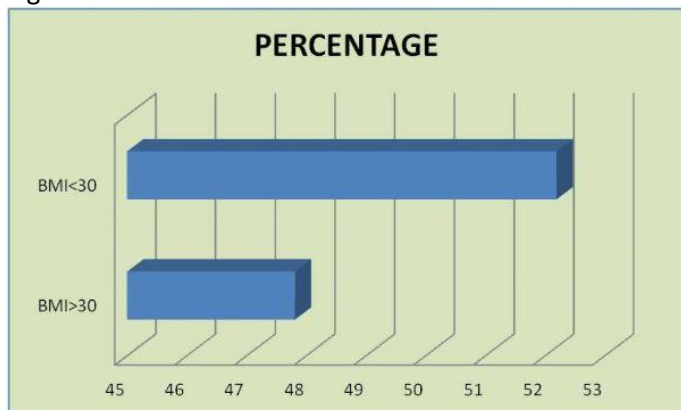


Figure 3

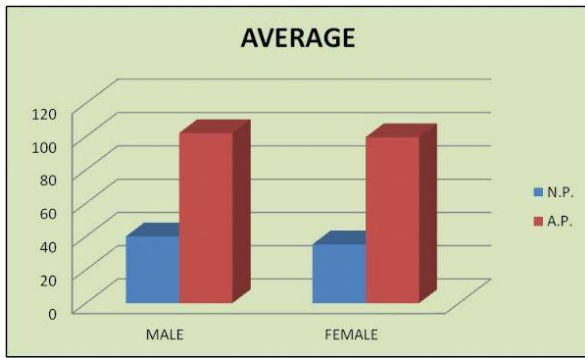
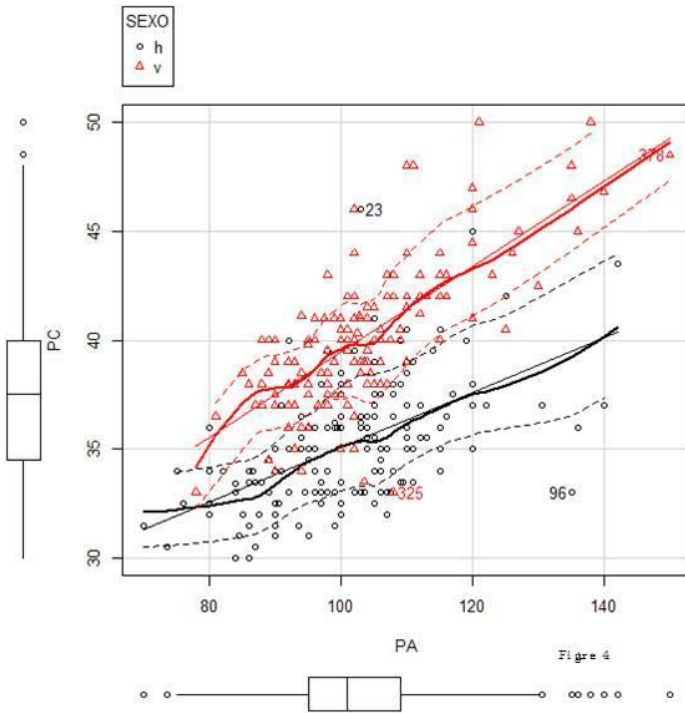


Figure 4



1

correlacion	BMI	AP	NP
BMI	1	0.79	0.41
AP	0.79	1	0.51
NP	0.41	0.51	1

BMI: bodily mass index, AP: abdominal perimeter, NP: neck perimeter

P-0597

Tobacco, an enhancer?

Nayade Jorge Martin, José Ángel Sánchez Ortiz, José Carlos Perez Sánchez, María Ángeles Castaño Fuentes, María Rosa Sánchez Perez, Juan Carlos De Sola Jurado
Andalusian Health Service

OBJECTIVE:

Determine whether or not being a smoker increases risk of cardiovascular disease an other related risk factors.

MATERIAL-METHODS:

Samples have been randomly from 16 patient facilities at a Health Clinic with at least one of the following illnesses: Arterial Hypertension, Diabetes, Obesity, Dyslipidemia, The samples were collected from both smokers and non-smokers. In both cases, circumstances such as age, weight size and bodily mass index were taken into account. For statistical analysis, R commander program was utilized with Student T, Fisher F and Chi- squared.

RESULTS:

The sample come from a total of 251 people; 76,1% were smokers, of which 45,4% were male and the other 54,5% were female. The other 23,9% of all subjects were non-smokers, 50% of whom were men and the other 50% women

We found a significant correlation between age and smoking tendencies. The smoking population generally consisted of younger people (X= 57,01 years) as opposed to the non smokers (X= 62,22 years) with an confidence interval of 95% of (1,74 - 8,66) for the difference. There is almost no significance of the relation between smoking and obesity (p = 0,059) and smoking and arterial hypertension (p = 0,075) nor was there any relevant or apparent correlation between smoking and the other previously mentioned illnesses, (see table 1). There was no relation between the smoking variable and the numerous cardiovascular risk factors present in each individual (p <0,05), (see table 2). After individually studying the smoking variable with respect to the other cardiovascular risk factors, no relation was found.

CONCLUSION:

Given the inverse relation between tobacco use and age it'd be advisable for carry out new studies aimed towards discovering wether or not said correlation is affected by sanitary educación, cardiovascular risk factors number...

Keywords: Tobacco Use, Cardiovascular Risk, Age

Figure 1

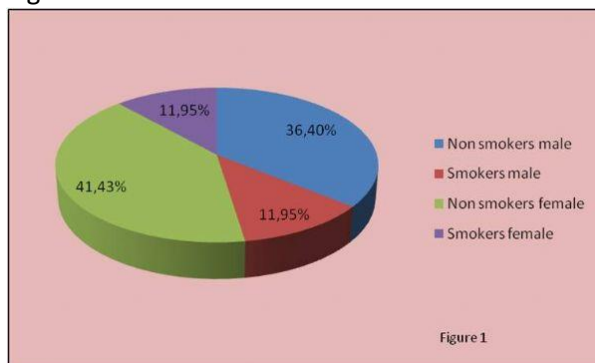


Figure 2

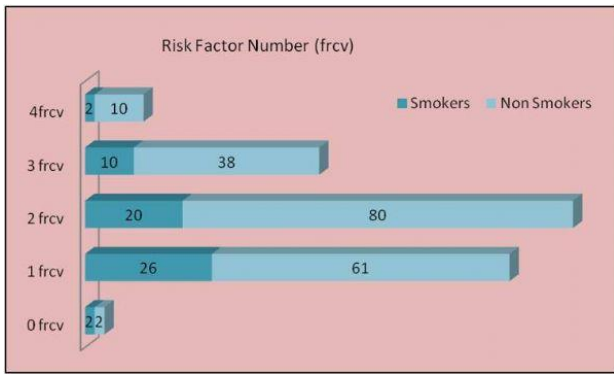


Figure 3

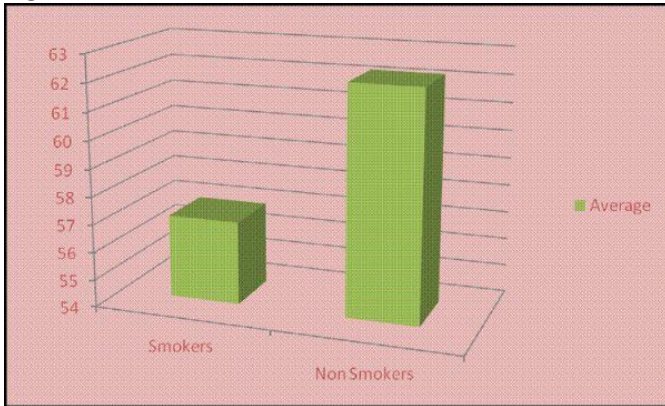


Table 1

	DL	NON DL	DM	NON DM	AH	NON AH	BMI>30	BMI<30
SMOKER	30	29	16	43	33	26	22	37
NON SMOKER	29	94	48	144	133	59	98	94

P-0598

Health promotion in a rural pre-settlement in the Federal District - Brazil

Ubirajara José Picanço De Miranda Junior¹, Isabelle Cristine De Jesus Macedo¹, Izza Dantas Cano¹, Carolina Martins Pereira¹, Larissa Dos Reis Rodrigues¹, Bruno Souza De Faria¹, Fernando Erick Damasceno Moreira²

¹School of Health Sciences of the Federal District - Brazil

²Health Secretariat of the Federal District - Brazil

Introduction - Students of medicine at the 1st series of the College of Health Sciences School (ESCS) participated in a social action to promote health in a rural pre-settlement, in which health care, sanitation and housing conditions are poor aimed to to describe this experience. **Method** - Realization of activity planned by a Family Health Team and the ESCS students with about one hundred families residing in the rural pre-settlement. Most homes have structure and poor hygiene, including the location of the action that took place in a wooden shed with uneven floor, making the setting of scales, chairs and tables. The team organized the location, strategically arranging the equipment to be used. There were two rooms, a waiting and screening (glycemic evaluation, blood pressure and nutritional status) and the other of vaccination, fluoride application and medical consultation. For better use and learning, there was rotation of students in the various functions. **Results** - The activity was important because it was seen the performance and operation of a foothold to a needy society. The theoretical knowledge was applied in the real scenario based on educational guidelines recommended by the ESCS. **Conclusion** - As a result, students have acquired the ability to observe the patient's perspective in relation to their difficulties, which allowed them to take a humanitarian behavior, expanding the focus to address not only the disease, but the subject and its social environment as well as the relevance of experiences of learning about the relationship of the health team with society.

Keywords: Medical education; Social action; Health promotion

Rural Pre-Settlement



Students Attending Patient



Students of Health Sciences Superior School (ESCS)



P-0599

Prospective cohort study of smoking cessation program in the "real world"

Ana Marqueño Ellacuría¹, Marc Tarín Martí¹, María Cordobés Millán¹, Sílvia Crespo Blas¹, Angela Inés Vieira Rodríguez¹, Rosario Hernández Ibáñez², José Miguel Baena Díez², Cristina Serrano Morales³, Natividad Martín Peña³

¹Resident de Medicina Familiar i Comunitària, CAP La Marina, Barcelona, Espanya

²Metge de Família, CAP La Marina, Barcelona, Espanya

³Infermera, CAP La Marina, Barcelona, Espanya

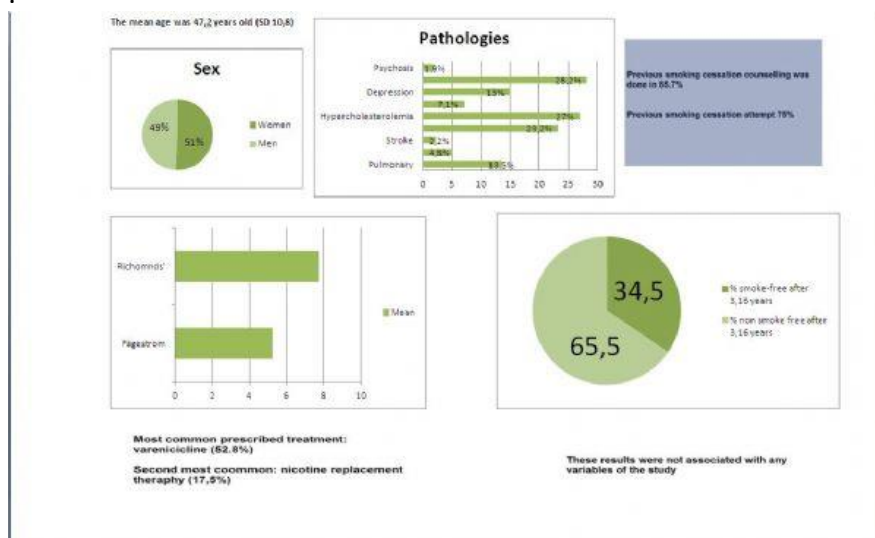
BACKGROUND AND AIM. Smoking is a major cause of morbidity in developed countries. The aim of study was to describe the characteristics of patients included in a smoking cessation program, and to estimate the "real-world" effectiveness in general population.

METHODS. We conducted a prospective cohort study in 264 adult smokers who participated in a smoking cessation program in a primary care centre. Patients were referred to the first visit with a trained nurse. The rest of the visits were performed by general practitioner or a nurse. The protocol included the following variables: age, gender, chronic pulmonary disease, cardiovascular disease, cardiovascular risk factors, psychiatric disorders, previous smoking cessation counseling, smoking cessation attempts, Fageström and Richmonds' scales, carbon monoxide (CO) in expired breath, and pharmacologic treatment.

RESULTS. The mean age was 47.2 years old (SD 10,8), and 50.9% were women. The prevalence of pathologies were: pulmonary disease 13.5%, ischemic cardiopathy 4.8%, stroke 2.2%, hypertension 23.2%, hypercholesterolemia 27.0%, diabetes mellitus 7.1%, depression 15.0%, anxiety 28.2% and psychosis 1.9%. Previous smoking cessation counseling was done in a 85.7% of the patients, and 75% had a previous attempt. The mean of the Fageström scale was 5.26 (SD 2.18), and the Richmonds' mean was 7.71(SD1.89). The mean of carbon monoxide (CO) in expired breath was 3.81 (SD 2.16). The most common prescribed treatment was varenicline (52,8%), and nicotine replacement therapy (17,5%). The 34,5% of the patients (95% confidence interval 28.6% to 40.9%) remained smoke-free after a 3.16 years of follow-up. These results were not associated with any variables of the study.

CONCLUSIONS. This study demonstrates the effectiveness of a smoking cessation program in a long term cohort in the "real world". Abstinence rates were similar to previous studies. Remark that psychiatric disorders' prevalence was high. Instead, cardiovascular diseases had a low prevalence.

Keywords: smoking cessation, primary care, effectiveness



P-0600

Migration between teaching scenarios and family risk in primary health care: An experience report

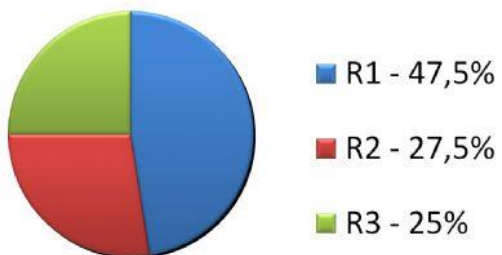
Ubirajara José Picanço De Miranda Junior, Ananda Dos Santos Conde, Thiago Cavalcante Magalhães, Victoria Veiga Ribeiro Gonçalves, Jessica Dos Santos Huang, Ana Luisa Ataíde Moraes
Superior School of Health Sciences of the Federal District - Brazil

Background and AIM: The School of Health Sciences - ESCS, located in the Federal District - Brazil, adopts active learning methodologies and offers an educational unit called "Interaction Teaching-Service-Community (IESC)", that promote actions of primary health care. In 2013 this educational unity changed its teaching scenario due to social instability, violence, and poor infrastructure, that made the home visits little profitable to students, making it difficult to bond with the families, but provided an opportunity to compare family risk in these two scenarios instead. **METHOD:** Quantitative, observational and cross-sectional study from secondary data of the Brazilian Informational System of the Primary Health Care in the two areas surveyed in 2013. It included 25% of records randomly selected from both scenarios, in a total of 104 records in the first place (Vila Dnocs) and 119 in the second (Vila Basevi). From that followed an evaluation according to a scale called the Family Risk Scale. An analysis of the records was made through discussions on the scores obtained from this scale of risk. **RESULTS:** According to the analysis, the maximum family risk in Vila Basevi was that of 25%, while in Vila Dnocs it was 12.54%. **CONCLUSION:** It was supposed that the families of the Vila Dnocs were at a higher family risk, due to the violence and, consequently, greater social vulnerability. The sanitation criterion directly shaped the results, since the Vila Basevi does not have such service and Vila DNOCS does. The Vila Basevi began the research with a score of three points ahead of the other community. Even though it had a greater family risk in the results, the problem is mainly focused on the inadequate sanitation, which is more feasible to solve, while Vila Dnocs shows a lack of social facilities, making the situation more difficult to resolve.

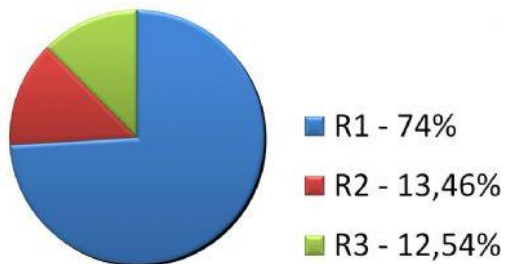
Keywords: Family Risk Scale; Primary Health Care; Family and Community Medicine

Familiar Risk

FAMILIAR RISK - BASEVI



FAMILIAR RISK - DNOCS



Vila DNOCS



P-0601

An Unusual Abdominal Pain

Maria Giovanna D'angelo, Paula Pilar Rodriguez Casal, Carmen Arca Pichel, Santiago Perez Cachafeiro
Department of Primary Care, Integrated Management Area Pontevedra-Salnes, Galicia, Spain.

INTRODUCTION: Colorectal cancer (CRC) is a common and lethal disease. It is the second most commonly diagnosed cancer in women and third most common in men. The risk of developing CRC is influenced by both environmental and genetic factors.

CASE DESCRIPTION: A 56-year-old woman with an irrelevant pathological family history. Personal history: dyslipidemia, psoriasis, tonsillectomy and uterine myoma. No drug allergies. No toxic habits. Medical treatment: Simvastatin.

She attends her general practitioner (GP) presenting two nocturnal episodes of fever in last weeks and pain in the right hypochondrium that bears relation to movement; physical examination revealed minimal hepatomegaly. Three months ago she had gone to her GP complaining of abdominal pain and constipation and her physical examination and clinical analysis were normal. We requested abdominal ultrasonography that revealed focal hepatic lesions suggestive of metastasis. We decided to contact the Emergency Department and Gastroenterology. Laboratory tests in ER showed, iron deficiency; hormonal and tumor markers were normal. The abdominal and pelvic CT scans with contrast administration confirms focal liver lesions, and also shows loco-regional lymphatic nodes, advising rule out rectal cancer. EUS confirmed CRC. Finally, genetic testing showed KRAS mutation.

CONCLUSIONS:

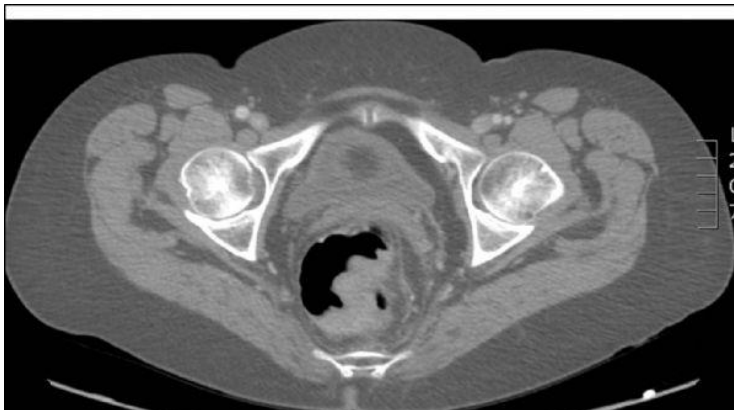
Early detection and secondary prevention is important in the CRC. The GP is the main link in the health action to combat cancer, although primary prevention is not always easy. Screening of asymptomatic individuals for CRC is advocated by major societies and preventive care organizations, including the Council of the European Union based on the European Code Against Cancer. The screening tests for CRC include the fecal occult blood test and look for criteria suspected of CCR. It is also important to screening in patients with a family history of CRC and ensuring the fulfillment tracking polyps.

Keywords: Cancer, Colorectal, Secondary Prevention, Early Detection of Cancer, General Practitioners

Eco



TC



P-0602

Evaluation of Patients Admitted to the Periodic Health Examination Clinic of Family Medicine on Ondokuz Mayıs University, Samsun, Turkey

Gulumser Kir Dogru, Fusun Artiran Igde, Mustafa Fevzi Dikici, Fusun Yaris
Department of Family Medicine, Ondokuz Mayıs University, Samsun, Turkey

Background & AIM: Periodic health examinations (PHE) aims applied to healthy individuals at regular intervals, by identifying personal spesific risks aims early diagnosis and detection of diseases that can be treated. The aim of our study of patients admitted to our recently PHE outpatient clinic is to determine the general characteristics. **METHOD:** 40 cases who admitted to the PHE Clinic of Family Medicine on Ondokuz Mayıs University between the date of December 2014- February 2015 were included in the study. Necessary data were collected from files of patients.

RESULTS: 47.5%(n=19) of the cases were female, 52.5%(n=21) were male. The mean age of participants was 40.7±15.1. The majority of patients who applied PHE outpatient clinic didn't have any active complaint however abdominal pain, widespread pain, fatigue, headache was the chief complaints. When evaluating behavioral lifestyle 22.5%(n=9) of patients were using cigarettes and the majority of users were found male. 6(15%) participants are using social drinking alcohol level. 9(22.5%) participants had a history of malignancy in the first and second degree relatives. 11(27.5%) participants had a family history of coronary artery disease. 6(31.6) of the female participants have a mammogram at least a time. 8(42.1) female participants was doing a self breast exam once a month. 5(26,3) of the participants had at least once a pap-smear care. Systolic blood pressure of the participants was 121,7±14.07 while diastolic blood pressure was 78,7±8,2. Systolic blood pressure was higher in males while diastolic blood pressure was higher in females. The average of body mass index (BMI) was 26.88 ±5.8; BMI was higher in females. The results of the examinations and investigations 10(25%) patients had recommended intermittent PHE. Colonoscopy was planned to six participants. Mammography and pap-smear was planned for 10 female participants.

CONCLUSION: PHE is an important step in preventive care.

Keywords: primary health care, health promotion, family practice

P-0603

The association between coronary calcification and adenomatous polyps of colon in Korean adults

Hongbae Kim¹, Yongjae Lee², Jaeyong Shim², Hyeree Lee²

¹Department of Family Medicine, Myongji Hospital, Goyang, Republic of Korea

²Department of Family Medicine, Yonsei University, Seoul, Republic of Korea

Background and Aim

Adenomatous polyps of colon is a precancerous lesion. Many studies have shown that the adenomatous polyps of colon and disease share several common risk factors. This cross-sectional study aimed to investigate whether coronary calcification is associated with the adenomatous polyps of colon.

Method

Among 1637 Korean adults, we examined the association between coronary calcium score (CCS) as a measurement of coronary calcification and the presence of adenomatous polyps of colon via multi-detected row computed tomography (MDCT) and colonoscopy, respectively. CCS values were categorized as follows: 0, 1—17, 18—105, or ≥106. The odds ratios (ORs) and 95% confidence intervals (CIs) for the presence of adenomatous polyps of colon were calculated across CCS groups.

Results

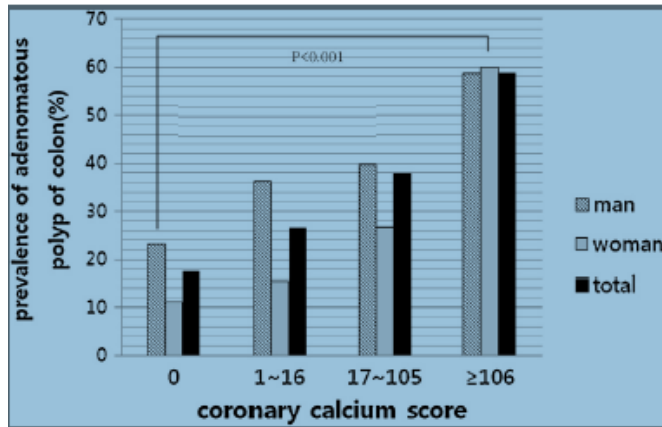
After adjusting for confounding variables, the adjusted ORs (95% CIs) for the presence of adenomatous polyps of colon in each of the four CCS groups were 1.00 (reference), 1.44 (0.91—2.33), 1.88 (1.15—3.01) and 3.61 (2.23—5.74). And higher CCS values were associated with multiple polyps ($p \leq 0.001$), villous histologic features or high-grade dysplasia ($p = 0.02$), and advanced adenomatous polyps ($p \leq 0.001$).

Conclusions

A higher level of CCS was found to be strongly and independently associated with the presence of adenomatous polyps of colon in Korean adults. This finding suggests that people at high risk for coronary atherosclerosis through MDCT should be considered for further evaluation of adenomatous polyps.

Keywords: coronary calcium score, adenomatous polyps of colon, cross-sectional study

Comparison of the prevalent adenomatous polyp of colon according to the coronary calcium score



The prevalence of adenomatous polyps of colon increased as CCS values increased as follows: 17.6% (224/1271), 31.7% (39/123), 37.7% (46/122), and 58.7% (71/121) for CCS groups 0, 1–17, 18–105, and ≥106, respectively ($p < 0.001$).

Characteristics according to coronary calcium score value

	CCS value				P-value
	0 (n=1271)	1-17 (n=123)	18-105 (n=122)	≥106 (n=121)	
Age (years)	50.3 ± 8.4	55.2 ± 8.9	57.2 ± 9.0	61.6 ± 8.8	<0.001
Male sex(%)	51.7	77.6	87.2	86.0	<0.001
Current smokers(%)	35.6	29.3	23.2	21.5	<0.001
Body mass index(kg/m ²)	23.1 ± 2.8	24.5 ± 2.8	24.0 ± 2.4	24.5 ± 2.4	<0.001
Systolic BP (mmHg)	119.5 ± 15.9	123.7 ± 16.8	125.0 ± 14.8	128.6 ± 13.1	<0.001
Diastolic BP (mm Hg)	74.5 ± 9.6	77.9 ± 8.3	78.8 ± 9.1	80.5 ± 7.8	<0.001
hsCRP(mg/L)	1.4 ± 2.4	1.7 ± 2.1	1.6 ± 2.3	1.9 ± 2.8	0.16
Fasting glucose (mg/dL)	92.0 ± 13.7	95.6 ± 12.6	99.2 ± 21.4	105.8 ± 29.8	<0.001
Total cholesterol (mg/dL)	201.4 ± 78.2	197.5 ± 69.8	210.4 ± 80.2	205.9 ± 67.3	0.46
Triglyceride (mg/dL)	113.1 ± 70.3	124.7 ± 68.5	134.8 ± 83.1	125.9 ± 56.4	0.002
HDL cholesterol (mg/dL)	47.8 ± 11.4	41.8 ± 9.9	54.3 ± 12.0	48.8 ± 17.2	0.42
LDL cholesterol (mg/dL)	122.4 ± 30.0	125.8 ± 30.5	124.7 ± 31.2	121.0 ± 31.4	0.53
ALT (IU/L)	23.9 ± 15.2	29.1 ± 18.3	24.6 ± 10.0	27.7 ± 14.7	<0.001

Table 1 shows the demographic and biochemical data for all subjects according to CCS group. The average age was 51.7 ± 9.5 years. The mean BMI (kg/m²) was 23.5, and the percentage of patients that were current smokers was 32.6%. The mean age, number of male subjects, BMI, SBP, DBP, FPG, and ALT level were higher in the CCS ≥106 group, whereas the percentage of current smokers was lower in that group. Triglyceride levels were highest in the CCS 18-105 group. Abbreviations: BP = blood pressure; hsCRP = high-sensitive C-reactive protein; HDL= high density lipoprotein; LDL = low density lipoprotein; ALT =alanine aminotransferase. Data are expressed as the mean ± standard deviation or percentage. P-value was calculated by ANOVA test for continuous variable or chi-squared test for categorical variable.

Odds ratio and 95% confidence intervals for adenomatous polyp of colon according to CCS value

	CCS value			
	0	1-17	18-105	≥106
Model 1	1.00	2.16 (1.41 – 3.34)	2.92 (1.90 – 4.38)	6.77 (4.54 – 10.08)
Model 2	1.00	1.64 (1.03 – 2.56)	2.28 (1.41– 3.54)	4.45 (2.82– 7.03)
Model 3	1.00	1.44 (0.91 – 2.33)	1.88 (1.15 – 3.01)	3.61 (2.23– 5.74)

Table 2 shows the risk of developing adenomatous polyps according to CCS values. After adjusting for all confounding factors (age, sex, smoking status, body mass index, blood pressure, fasting glucose level, total cholesterol, triglycerides, HDL cholesterol, LDL cholesterol, ALT and hs-CRP) the adjusted OR (95% CI) for having adenomatous polyps in the highest CCS group was 3.61 (2.23 – 5.74) compared to the lowest group. Model 1: unadjusted. Model 2: adjusted for age, sex, smoking status, body mass index, blood pressure, fasting glucose, total cholesterol, triglyceride, HDL- cholesterol and LDL-cholesterol Model 3: adjusted for age, sex, smoking status, body mass index, blood pressure, high sensitive C-reactive protein, fasting glucose, total cholesterol, triglyceride, HDL-cholesterol, LDL-cholesterol and alanine aminotransferase High sensitivity C-reactive protein and triglyceride were log transformed for analysis. Reference values of all variables are lowest quartile except HDL-cholesterol. Reference value of HDL-cholesterol is highest quartile.

Characteristics of adenomatous polyp of colon categorized by CCS

	CCS value				p-value
	0 (n=1271)	1-17 (n=123)	18-105 (n=122)	≥106(n=121)	
Colon polyp (%)	224(17.6)	39(31.7)	46(37.7)	71(58.7)	<0.001
Size(mm)					0.67
<10	202 (90.2%)	36 (92.3%)	44 (95.7%)	64 (90.1%)	
≥10	22 (9.8%)	3 (7.7%)	2 (4.3%)	7(9.9%)	
Number					<0.001
<3	198 (88.4%)	31 (79.5%)	34 (73.9%)	41 (57.7%)	
≥3	26 (11.6%)	8 (20.5%)	12 (26.1%)	30 (42.3%)	
Villous feature or high-grade dysplasia					0.02
Yes	0(0%)	0(0%)	1(2.2%)	4(5.6%)	
No	224 (100%)	39 (100%)	45 (97.8%)	67 (94.4%)	
Advanced lesion					<0.001
Yes	39 (17.4%)	9 (23.1%)	13 (28.3%)	32(45.1%)	
No	185 (82.6%)	30 (76.9%)	33 (71.7%)	39(54.9%)	

As shown in Table 3, compared to the group with a CCS of 0, higher CCS values were more frequently associated with multiple polyps (p<0.001), villous histologic features or high-grade dysplasia (p=0.02), and advanced adenomatous polyps (p<0.001). However, there was no correlation between CCS value and polyp size. And no association between CCS value and advanced adenomatous polyps was found.

P-0604**Doctor's role in colorectal cancer screening**

Gintare Jakstaite¹, Neringa Burokiene¹, Virmantas Kvedaras²

¹Clinics of Internal Diseases, Family Medicine and Oncology, Faculty of Medicine, Vilnius University, Vilnius, Lithuania

²Department of Econometric Analysis, Faculty of Mathematics and Informatics, Vilnius University, Vilnius, Lithuania

BACKGROUND: To evaluate impact of family doctor on rate of colorectal cancer screening.

METHODS: 530 health's histories were analyzed retrospectively in the Vilnius University Hospital Santariskiu Klinikos (VUL SK) Family Medicine Center. The participation in the colorectal cancer screening was assessed for two time periods: July 2009 – July 2011 and August 2011 – September 2013. Correlations between the number of visits to a family doctor and participation were analyzed. Colorectal cancer screening results of four (A, B, C, D) family doctors were compared.

RESULTS: 73.4 percent of the patients did iFOBT test during the first period and 64.5 percent during the second period in VUL SK Family Medicine Center. Patients, who did the test during the first period, were significantly less active during the second one. Family doctor A had significantly higher rate of patients who did iFOBT test than other family doctors. Correlation between visits to a family doctor and participation were found (probability of participation is increasing with number of visits).

CONCLUSION: Family doctors play a very important role in screening programs. Invitations to participate in screening sent to patients who rarely visit a family doctor should lead to better results of the colorectal cancer screening program.

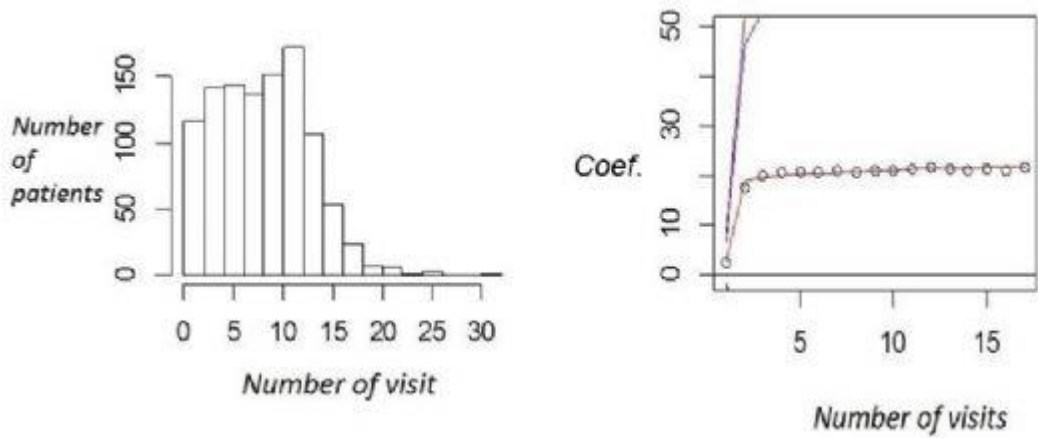
Keywords: colorectal cancer screening family doctor

Table 1. Results of the research.

Factors	Parameter estimation	Standard error	z criteria	Significance
<i>Constant</i>	8.35218	1.83313	4.556	<0,0005
<i>First vs. Second period</i>	0.38799	0.35292	1.099	0.271608
<i>Doctor B vs. Doctor A</i>	-1.86093	0.33298	-5.589	<0,0005
<i>Doctor C vs. Doctor A</i>	-4.67977	0.78811	-5.938	<0,0005
<i>Doctor D vs. Doctor A</i>	-2.23030	0.35327	-6.313	<0,0005
<i>1(number of visits >2)</i>	3.12394	0.54990	5.681	<0,0005
<i>log(number of visits+1)</i>	1.02246	0.26732	3.825	0.000131

Factors	Parameter estimation	Standard error	z criteria	Significance
<i>Constant</i>	8.35218	1.83313	4.556	<0,0005
<i>First vs. Second period</i>	0.38799	0.35292	1.099	0.271608
<i>Doctor B vs. Doctor A</i>	-1.86093	0.33298	-5.589	<0,0005
<i>Doctor C vs. Doctor A</i>	-4.67977	0.78811	-5.938	<0,0005
<i>Doctor D vs. Doctor A</i>	-2.23030	0.35327	-6.313	<0,0005
$\mathbb{1}(\text{number of visits} > 2)$	3.12394	0.54990	5.681	<0,0005
$\log(\text{number of visits} + 1)$	1.02246	0.26732	3.825	0.000131

Figure 1. Probability of participation and number of visits.



P-0605**Colorectal cancer screening in Lithuania**Gintare Jakstaite¹, Neringa Burokiene¹, Virmantas Kvedaras²¹Clinics of Internal Diseases, Family Medicine and Oncology, Faculty of Medicine, Vilnius University, Vilnius, Lithuania²Department of Econometric Analysis, Faculty of Mathematics and Informatics, Vilnius University, Vilnius, Lithuania

BACKGROUND: To evaluate the extent of colorectal cancer screening in Vilnius University Hospital Santariskiu Klinikos (VUL SK) Family Medicine Center and in Lithuania in general.

METHODS: 530 health histories were analyzed retrospectively. The results of colorectal cancer screening during the period from July 2009 to September 2013 were assessed in VUL SK Family medicine Center. Statistical data from the Ministry of Health of Republic of Lithuania was interpreted.

RESULTS: 88.3 percent of patients did iFOBT test by themselves at least once between July 2009 and September 2013 in VUL SK Family Medicine Center. 59 iFOBT tests were found positive, 49 colonoscopies were performed, 26 biopsies were taken. Premalignant changes were found for 23 patients. Carcinoma was diagnosed in 1 case. About 160 thousands patients made iFOBT test in Lithuania during the period between July 2009 and July 2011. The results were positive for 12118 patients. 7730 colonoscopies were performed and 2635 biopsies were taken. 186 colorectal carcinomas were diagnosed.

CONCLUSION: Rate of participation in colorectal cancer screening is high in comparison to literature's data, but only two thirds of iFOBT-positive patients perform colonoscopy.

Keywords: colorectal cancer screening iFOBT colonoscopy

Table 1. Results of colorectal cancer screening in different country.

	United Kingdom*	France*	Italy*	Lithuania**
Age	60-69y.	50-74y.	50-69y.	50-74y.
Participation's rate	537 770 (52% of invited)	524 389 (52,2% of invited)	36 693 (49,6% of invited)	160 008
FOBT positive	5 077 (1.8%)	9 427 (2.9%)	2 392 (6,5%)	12 118 (7,6%)
Colonoscopies	3 349 (67%)	7 947 (84.3%)	2 054 (85,5%)	7 730 (63,8%)
Polipe/adenoma	1 523 (44%)	2 623 (33.0%)	1 523 (44%)	2 189 (28,3%)
Colorectal cancer	382 (11%)	763 (9.6%), >80% T1 or T2.	382 (11%)	286 (3,7%)

*West NJ, Boustiere C, Rachbach W, Pirante F, Leicester RJ Colorectal cancer screening in Europe: differences in approach, similar barriers to overcome. *Int J Colorectal Dis* (2008) 24:733-740.

**Data from Lithuanian TLK.

P-0606

An epidemiological study in obese patients assisting to a dietetic therapeutic programme in Primary Care

Cristina Navarro Robles¹, María Cristina Garrido Laguna¹, María Fernández Zambrano¹, Agustín Benítez De La Poza¹, Maria Dolores Romo², Idoia Arrillaga Ocampo¹, Irene Padial Reyes¹

¹General Practitioner, Las Lagunas Health Center, Mijas Costa, Andalucía, SPAIN

²Psychologist, Las Lagunas Health Center, Mijas Costa, Andalucía, SPAIN

INTRODUCTION: Knowing the dietetic habits in obese patients is essential for the achievement of a variation in the daily life habits.

OBJECTIVE: to analyze the epidemiological profile in obese patients who start an interventional group.

METHODS: A retrospective observational study in obese patients was performed between 2013- 2014 in Mijas Costa Health Center (Málaga, Spain).

RESULTS: The programme was composed of 78 patients, 60 women and 18 men, including 86% of obese patients (IMC > 30).

In this study we observed that 38.5% eat only three meals a day. 83% reported eating at home and 64% accompanied. It is observed that 44% eat between meals despite having a fixed schedule for main meals (78%). Most of those attending the program are responsible for the family diet, 68% was in charge of cooking and 76% perform daily shopping. 53% recognize continuous sensation of appetite. 68% acknowledged binge eating. The way of cooking of the 30% was making stew dishes against an 11% who reported eating grilled food.

We have found that 72% of our patients tried previous unsuccessful diets.

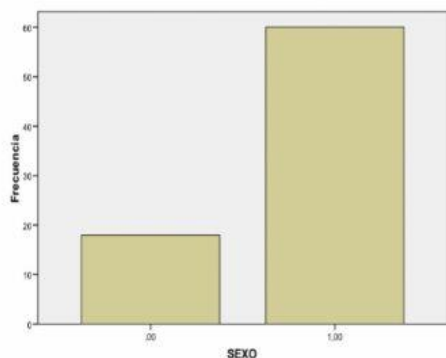
CONCLUSIONS: Among patients in our cohort, we found a minority of them with BMI 25-30 so we conclude that the programme would be more useful in early stages, preventing progression to morbid obesity, when it is more complicated that the programme could be successful.

Most of our patients are responsible of cooking and doing the shopping, as well as they eat at home with fixed schedules and accompanied, therefore bad habits extend to the household and the results of the intervention come indirectly to the patient family environment.

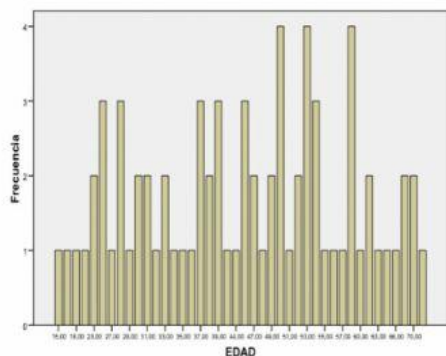
About the realization of previous diets, most admitted having done many previous diets without results. In addition we observed low adherence to the Mediterranean diet with an increase of unhealthy habits.

Keywords: Obese, habits, dietetic programme

Sex of the patients

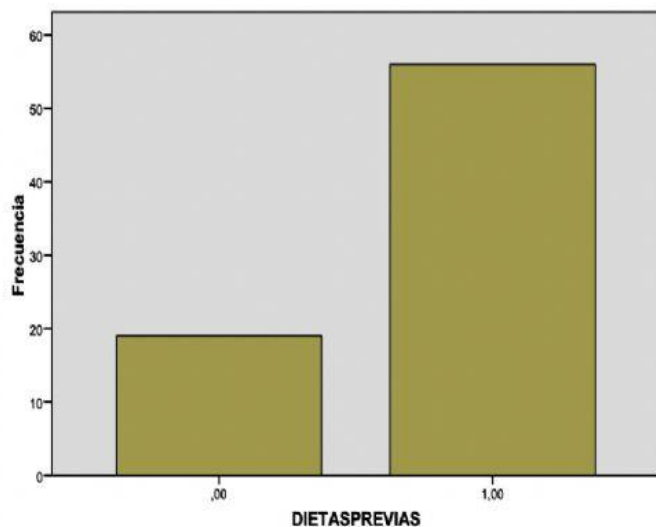


EDAD



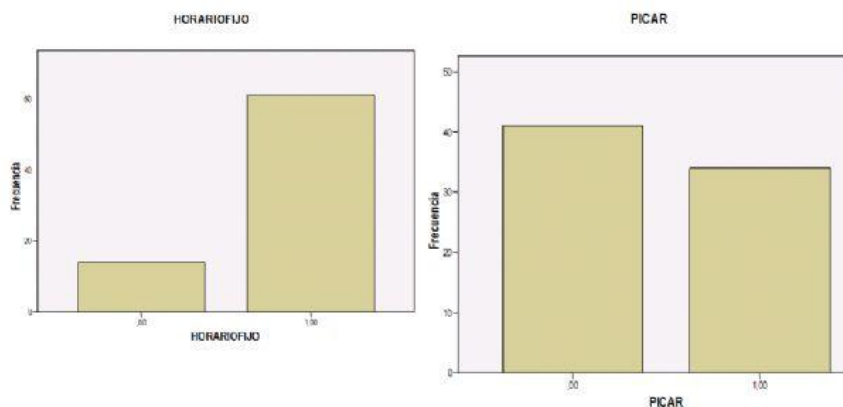
Most of the patients were women. 0 = men, 1 = women

Previous diets



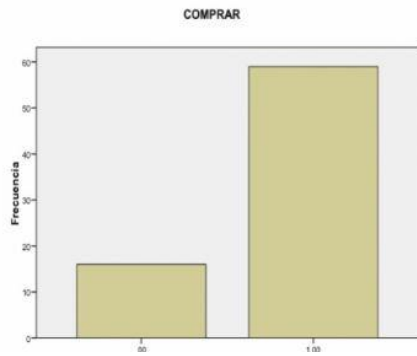
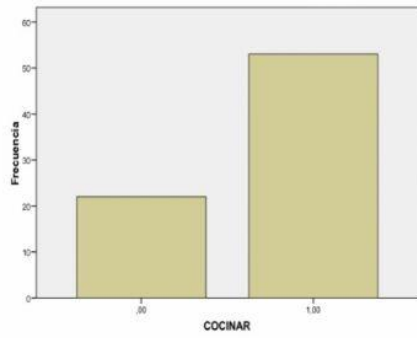
Most of the patients followed previous diets. 0 = not previous diets, 1 = previous diets

fixed hours and between hours



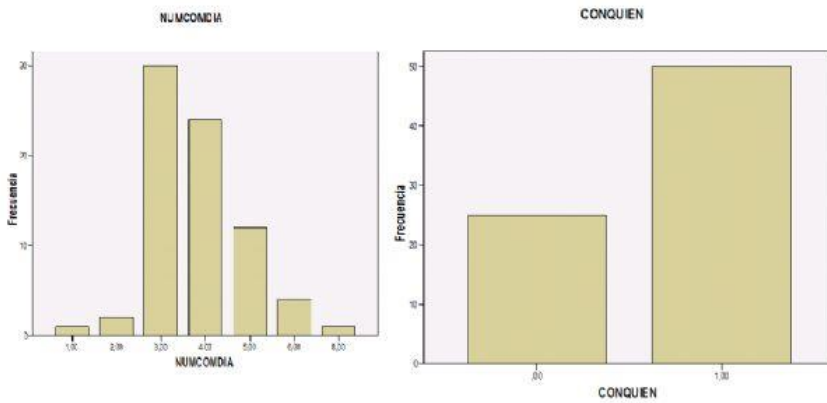
Most of the patients eat in fixed hours, but a lot of them eat between hours. 0= no fixed hours; 1= fixed hours. 0= no eating between hours; 1 = eating between hours

Responsibility



Most of the patients were responsible of shopping and cooking. 0 = not shop or cook, 1 = shop or cook

Numbers of meals and company



Most of the patients eat three meals per day and they eat accompanied. 0 = alone; 1= accompanied

Metka Žitnik Šircelj¹, Jožica Eder²

¹Community health centre Ljubljana, Ljubljana, Slovenia

²Community health centre dr. Adolfa Drolca Maribor, Maribor, Slovenia

Because of prolonging life span and the increasing number of people with various chronic diseases the health policy in Slovenia took a big step forward in 2011 regarding solving the current issues in this field by introducing a "model practice" (MP) together with the Ministry of Health, which emphasises the organisation and operation of primary health care activity, namely the field of family medicine. Model practice is a type of family practice, in which a doctor and nurse are joined by a nurse practitioner. The main purpose of model practices is to carry out thorough prevention of chronic non-communicable diseases and cardiovascular risk, detect risk factors, manage chronic patients, and provide medical advice and education. The results of such preventive screening (for 2014) are evident in the number of newly-diagnosed patients - during the 97 spirometries performed, 8 new COPD patients were diagnosed; the 195 conducted preventive screenings for chronic non-communicable diseases resulted in 14 newly-diagnosed type 2 diabetes patients and 13 patients with arterial hypertension. The presented data is the result of the work of a nurse practitioner who is currently working in two model practices, that is for two family physicians. Considering the fact that there were 436 model practices active in Slovenia in December 2014, one can imagine the approximate "profit" of such a work method, which proves the purpose and importance of working in such a broad team of model practices in Slovenia.

The purpose of this paper is to present the project of model practices, the role of a nurse practitioner in managing and treating patients in model practices and some of the results obtained so far by the new work method, which, generally speaking, confirm the positive effects of the complex treatment of patients provided by model practices.

Keywords: model practices, family medicine, satisfaction of patients, nurse practitioner

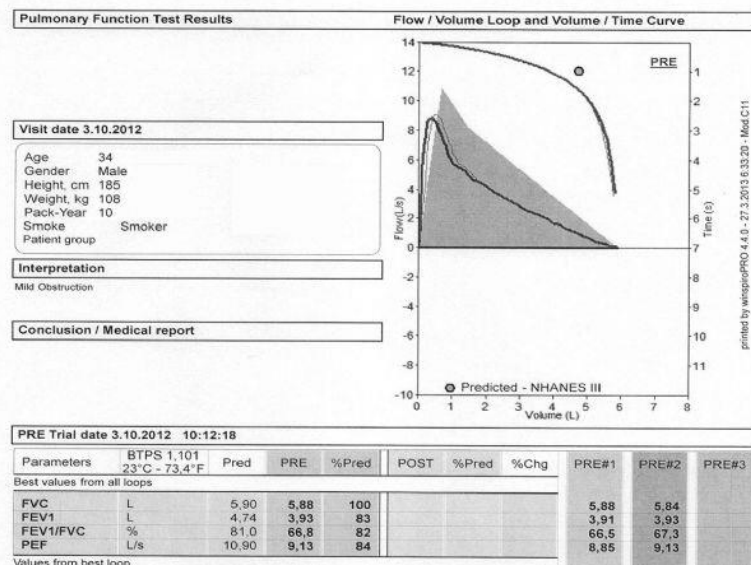
Prevention data for 2014

PREVENTION DATA FOR 2014 FOR ONE MODEL PRACTICE				
Preventive check-up by a nurse practitioner with screening and counselling	NUMBER OF CHRONIC PATIENTS DIAGNOSED DURING PREVENTIVE SCREENING BY A NURSE PRACTITIONER	NUMBER OF CHRONIC PATIENTS TREATED IN ACCORDANCE WITH PROTOCOL FOR CHRONIC DISEASES BY A NURSE PRACTITIONER	NUMBER OF PATIENTS WITH ESTABLISHED RISK FACTORS AFTER A CONDUCTED SCREENING	NUMBER OF PATIENTS WITHOUT RISK FACTORS (HEALTHY) AFTER A CONDUCTED SCREENING
<i>asthma</i>	1	25	143	28
<i>COPD</i>	4	12		
<i>diabetes</i>	6	50		
<i>hypertension</i>	6	161		
<i>depression</i>	2	12		

Results of first prevention check-up

FIRST SPIROMETRY TAKEN AT A RANDOM PREVENTIVE CHECK-UP				
PRE Trial date 9.9.2013 14:47:57				
Parameters	BTPS 1,097 24°C - 75,2°F	Pred	PRE	%Pred
Best values from all loops				
FVC	L	3,60	2,87	80
FEV1	L	2,68	1,29	48
FEV1/FVC	%	74,6	44,9	60
PEF	L/s	7,48	3,09	41
Values from best loop				
FEF2575	L/s	2,17	0,56	26
FEF25	L/s	6,36	1,34	21
FEF50	L/s	3,16	0,50	16

Prevention check-up; spirometrie test



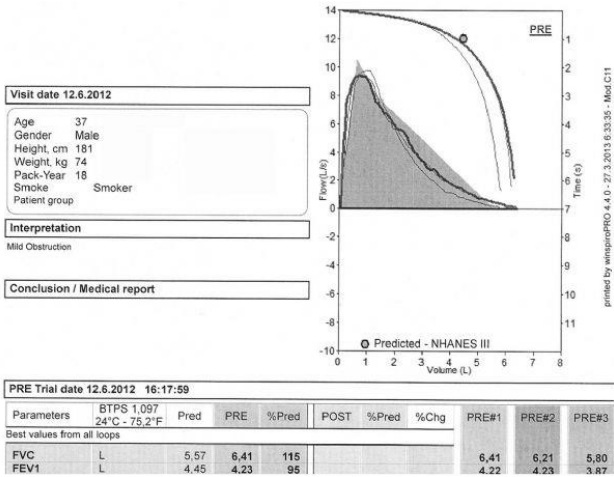
Results follow-up; after a year

SPIROMETRY OF A PATIENT WITH COPD AT A FOLLOW-UP 1 YEAR LATER				
PRE Trial date 25.8.2014 15:24:32				
Parameters	BTPS 1,097 24°C - 75,2°F	Pred	PRE	%Pred
Best values from all loops				
FVC	L	3,45	3,02	88
FEV1	L	2,55	1,46	57
FEV1/FVC	%	74,4	48,3	65
PEF	L/s	7,23	3,46	48
Values from best loop				
FEF2575	L/s	2,05	0,65	32
FEF25	L/s	6,15	1,55	25
FEF50	L/s	2,99	0,66	22
FEF75	L/s	0,96	0,28	29
FEV3	L	2,79	2,30	83

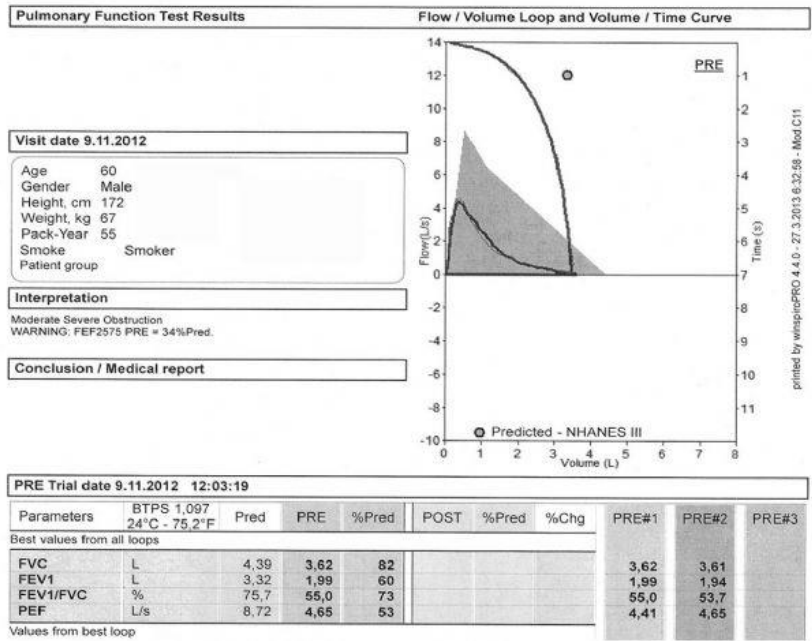
Prevention check-up and chronic noncommunicable disease management hand in hand

	FIRST PREVENTIVE CHECK UP	CHECK-UP IN FP AFTER 1 YEAR
WEIGHT	117 kg	93 kg
HEIGHT	171.5 cm	171.5 cm
BMI	40	32
BLOOD SUGAR	15.2	5.4
HbA1C	/	5.9
CHOLESTEROL	6.0	5.2
TG	2.07	1.01

Prevention ckeck-up; spirometrie test



Prevention ckeck-up; spirometrie test



P-0608**Evaluation of quality of life in people without chronic illness living in a district of Istanbul**

Sedat Ay¹, Asiye Sezer², Okcan Basat¹, Dilek Toprak²

¹Department of Family Medicine, Gaziosmanpaşa Taksim Training and Research Hospital, Istanbul, Turkey

²Department of Family Medicine, Şişli Hamidiye Etfal Training and Research Hospital, Istanbul, Turkey

BACKGROUND and AIM: In this study, we aimed to investigate the quality of life in people without known chronic illness living in a district of Istanbul.

METHOD: 336 subjects who are between 18 to 65 years and without chronic illness admitted to Gaziosmanpaşa Taksim Training and Research Hospital Family Medicine outpatient clinic between August to November 2014 were included in the study. A questionnaire form including the sociodemographic features and the Turkish validated short-form of the quality of life questionnaire version (WHOQOL-BREF TR) developed by WHO was performed. For statistical analysis frequency, chi-square and t-test were performed.

RESULTS: Our study was carried out on a total of 336 subjects, of which 136 were male and 200 were female. Mean scores of the physical, psychological, social and environment domains were 16.8, 15.8, 15.5 and 14.1 respectively. Males had higher Quality of Life scores than female participants, however this difference was statistically non-significant. Social domain scores were higher in males than females ($p < 0.05$), otherwise no significant difference was observed in other domain scores between male and female participants. Subsequent analyses showed that Quality of Life domain scores were not affected by age, literacy, marital status and alcohol & tobacco consumption.

CONCLUSIONS: Family physicians have the advantage in primary care patients with biopsychosocial approach with continuous care, therefore evaluating the quality of life must be one of family physicians' primary concerns.

Keywords: quality of life, no chronic illness, urban district

P-0609**Effect of Body Mass Index on the Quality of Life**

Asiye Sezer¹, Sedat Ay², Okcan Basat², Dilek Toprak¹

¹Department of Family Medicine, Şişli Hamidiye Etfal Training and Research Hospital, Istanbul, Turkey

²Department of Family Medicine, Gaziosmanpaşa Taksim Training and Research Hospital, Istanbul, Turkey

BACKGROUND AND AIM: Obesity prevalence is rapidly increasing all over the world as well as our country. Nowadays it is considered as a chronic disease resulting in many serious health problems and a reduced health-related quality of life. We aimed to investigate the relationship between body mass index and quality of life.

METHOD: 18-65 years and without chronic illness 336 people Taksim GOP Hospital Family Medicine outpatient clinic with any complaint between August 2014- November 2014 were included in the study. After body weight and height were measured, a questionnaire including the sociodemographic features and the Turkish short-form of the quality of life questionnaire version (WHOQOL-BREF TR) developed by WHO was performed. For statistical analysis frequency, Chi-square and t-test were used.

RESULTS: Our study was carried out on a total of 336 patients of which 136 were male and 200 were female. Body mass index distribution of participants in our study, 3.3% low weight (BMI <18), 44.0% normal (BMI: 18-24), 34.2% overweight (BMI: 25-29), 18.5% obese. In our study, by the BMI distribution there was no significant difference in mental, social, physical and environmental area scores. There were no significant differences in scores of mental, social, physical area at waist circumferences under and above 80 cm in women. Environmental area scores were significantly higher in above 80 cm than under 80 cm ($p < 0.05$). There were no significant differences in scores of mental, social, physical, environmental area at waist circumferences under and above 102 cm in men.

CONCLUSIONS: We detected that quality of life is affected by gender, alcohol use, waist circumference but not affected by age, BMI, education level, marital status, tobacco use. Family physicians, with biopsychosocial approach and continuous care, have a key role in prevention and treatment of obesity and subsequent effects on quality of life.

Keywords: body mass index, quality of life, healthcare

P-0610

Prevention of running-related injuries in primary care

Mariana Fonseca¹, Mafalda Gonçalves¹, Isabel Melo¹, Sara Miranda³, Andreia Pinto²

¹Unidade de Saúde Familiar de Anta, ACES Grande Porto VIII

²Unidade de Saúde Familiar de São Miguel, ACES Grande Porto VIII

³Unidade de Saúde Familiar de Espinho, ACES Grande Porto VIII

Background and AIM:

Running in the adult population is one of the most popular physical activities around the world and the number of runners and running events has increased steadily in the last few years.

Although running is an effective way to achieve many health benefits, it is associated with a high risk of injury, diminishing pleasure in exercise and leading to a temporary discontinuation of running, increased costs and absence from work.

The aim of this review was to present an overview of the most common running-related injuries, risk factors and prevention strategies.

METHOD:

A review was performed for papers published between January 2005 to March 2015, in Portuguese/English, in the medical databases Medline/Pubmed and Cochrane Library, using MeSh terms “running” “injuries” “prevention” and “risk factors”.

RESULTS:

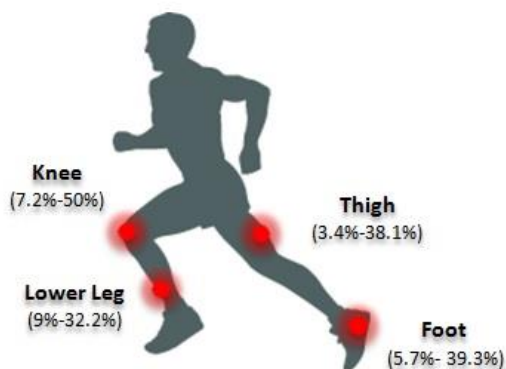
Acute running injuries are rare, consisting mainly of muscle injuries, sprain, or skin lesions. More than 80% of the complaints are due to overuse injuries, mainly affecting the leg, the ankle, the hip/pelvis/groin and the lower back. Risk factors for running injuries can be clustered into three areas: personal factors (age, sex, height, weight); running/training factors (running intensity, distance, running shoes, hip muscle weakness), and health/lifestyle related factors (smoking, comorbidity and previous injuries). There is evidence that insoles, the use of more than one pair of shoes, external supports and training programs with different components (mileage and rest, warm-up, footwear, nutrition and recovery, supplemental strength training) are effective to prevent running-related injuries.

CONCLUSIONS:

Frequency of running injuries tends to increase in a society awakening to the importance of engaging an active lifestyle. Family Physicians, as health managers, have the opportunity to first identify recreational runners and in an actively manner question, educate and guide healthy men and women that might not have any other contact with health professionals.

Keywords: Running, Injuries, Prevention, Risk factors

Incidence of Leg Running-Related Injuries



Main risk factors for RRI and respective preventive attitudes

Risk Factor	Evidence	Prevention
	Personal Factors	

Gender	No association found (1, 2)	
Age	Limited evidence (1, 2)	
Body Mass Index	No evidence (1) Evidence in the subpopulation of individuals with low weekly volume and with previous injury (3)	
Cavus Feet	Moderate evidence (4) Inconsistent results (2)	Orthotics use (4)
Leg Length Inequality	Weak evidence (4)	Heel lifts on the shorter leg (5)
	Running and Training Factors	
Duration	Weak evidence (6)	Run for 15-30 minutes a day (5)
Surface	Limited evidence (1, 2) Evidence of running on asphalt (hard) surfaces (5)	Variation in training surfaces (2,5) Optimal running surface should be smooth, resilient, flat and even and fairly soft (like grass or treadmill) (2,5)
Mileage	Limited evidence (1) Evidence of running greater than 40 miles (64 km) weekly in men (2, 4, 6) Unclear (3)	Limit total mileage to 65 km per week (2)
Orthotic/Insert	Moderate evidence (1)	Might lessen risk of stress fracture and symptoms of cavus feet (4)
Shoes	Limited evidence (1) Evidence when exceed 700 miles (5) Weak evidence (2)	Comfortable and well suited to the foot's shape (2) Good shock absorption (2) Replace shoe once it is worn out (2)
Stretching	Weak evidence (2, 4, 5)	After running, complementary to warm-up and strength training (2, 4, 5)
	Health and Life Factors	
Previous Injuries	Strong evidence (1, 2, 5, 6, 7)	Rehabilitation program (5) Gradual increase in training (5)

P-0611

Do I need malaria prophylaxis (last-minute travelers)

Paola Lievano, David Idoipe, Alvaro Irigoyen, Miguel Lopez Del Pueyo, Sara Lainez, Carlota Canet, Oscar Zepeda, Jesus Maria Tenias, Belen Gay, Cristina Marco, Laura Urieta, M^a Nieves Lozano, Raquel Martinez, Maria Barba, Amparo Cantin, Jose Antonio Ibañez, Miguel Rivas
Department of Community & Family Medicine. Sector III. Hospital Clínico Universitario Lozano Blesa, Zaragoza, Spain.

Background & AIM:

Most tourists who develop malaria do not adhere to an effective chemoprophylactic drug regimen not consulted before traveling (visiting friends and relative) and frequently fail to use personal protection actions for mosquito bite prevention.

It has been seen an increase number of consultations on the days before travelling and it is necessary our fast recommendation and accurate intervention.

METHOD:

Review available information of tropical medicine tools in primary care consultation.

RESULTS:

An interactive malaria map recommendations of chemoprophylaxis for specific destination according to the level of risk are available in the Spanish Ministry of Health website. Individual programs should be reviewed to determine the appropriate approach to chemoprophylaxis. More resources are available at the CDC website and the WHO provides useful online information including maps and malaria data.

Primary care intervention key objectives:

- Determine the risk of the area visited by the interactive malaria map website.
- Choose antimalarial drugs and prophylaxis protocols and considering an individual risk assessment, taking into account destination country, detailed itinerary, including specific cities, types of accommodation, season, and type of travel.
- Conditions such as pregnancy or the presence of antimalarial drug resistance at the destination may modify the risk assessment.

CONCLUSIONS:

Despite last minute consultations we can make an appropriate intervention. Travelers to malaria zones should understand that their planned itinerary puts them at risk for malaria, a serious infection that can be fatal. Prevention actions include avoiding mosquito bites and uses correctly an antimalarial chemoprophylaxis. Travelers should also know that no chemoprophylaxis regimen guarantees complete protection and that a fever during or after travel is a medical emergency requiring urgent medical attention.

Keywords: Malaria prophylaxis, last-minute travelers, antimalarial drug

P-0612

Assessment and management of the nutritional status of the adult population in the West of Ireland GP practice

Malgorzata Wawrzynek¹, Wojciech Wawrzynek²

¹Castle Street Surgery, Roscommon

²The Medical Centre, St.Coman's Park, Roscommon

Background

Obesity is a frequently unrecognised prevalent condition, leading to several chronic illnesses. Its management is often unsatisfactory, as its causes are multi-factorial and difficult to rectify.

Aim

To explore the prevalence of overweight/obese patients in the West of Ireland, its recognition by patients and doctors, as well as to explore the ways patients and doctors are managing excessive weight with identification of barriers to obesity management in the General Practice.

Method

Adult patients attending for their GP appointments in Roscommon were asked to fill in a questionnaire in relation to their weight, then their weight, height and BMI were checked by the GP during the consultation. All GPs working in the surgery were interviewed to explore the present obesity management and barriers to it.

Results

112 adult patients participated in the survey. 58% of them were either overweight or obese, although only 45% of patients suspected to be of excessive weight. Minority of patients (41%) were of a healthy BMI. Doctors were monitoring patients' weight less frequently than they believed (62%) and were often reluctant to discuss the weight although more than 90% of patients were happy for weight discussion even if not directly related to the purpose of the consultation. The main barriers to obesity management identified by doctors were: limited time, inadequate obesity counselling training, fear of harming doctor-patient relationship, lack of access to multidisciplinary support team, especially psychology.

Conclusions

Although 75% of patients actively manage their weight, only half of them combines increased physical activity with diet modifications. Patients in general are more open to discuss weight than doctors are. Routine, frequent weight checks will help to diagnose overweight/obese patients. Open discussion of the illness and structured follow up, based on an established, honest doctor-patient relationship and continuity of care facilitates change and successful weight management.

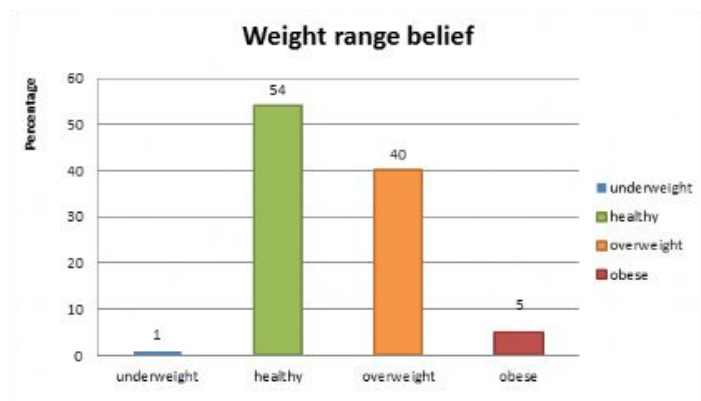
Keywords: obesity, prevalence, management, barriers

Results

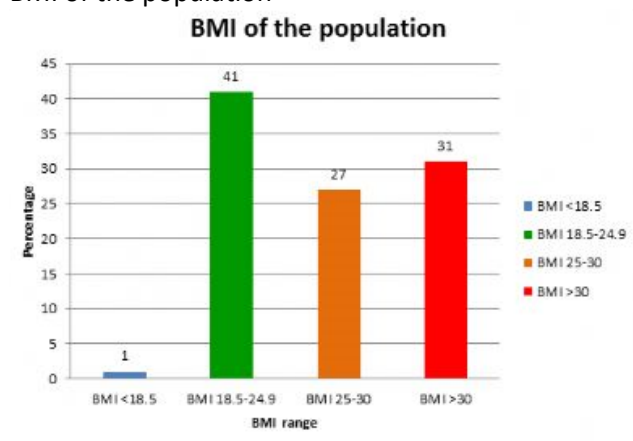
Population characteristics	Males	Women
Number	22	90
Percentage	20%	80%
Average age	52.4	48
Maximum age	81	87
Minimum age	18	18
SD	16.9	13.8
Average BMI	23	27.5
Maximum BMI	36.0	49.0
Minimum BMI	17.0	20.0
SD	5.56	5.2
Active weight management number	11	75
Active weight management %	50%	83%
Exercise use patient number	9	63
Exercise use %	41%	70%
Healthy BMI patient number	0	40
Healthy BMI %	0%	44%
Underweight patient number	1	0
Underweight %	5%	0%
Overweight patient number	8	24
Overweight %	37%	27%
Obese patient number	0	38
Obese %	0%	43%
Overweight/obese number	8	62
Overweight/obese %	37%	69%

Average population BMI	27.62
Maximum BMI	49.04
Minimum BMI	17.0
BMI standard deviation	5.272

weight range belief

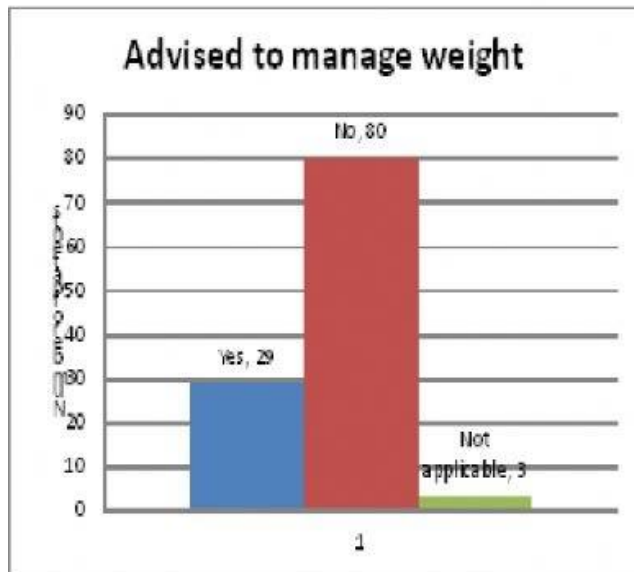


BMI of the population



GP management

Patients who had been advised to manage their weight in the past by a healthcare professional



P-0613

Evidence-based information on screening for people with a positive family history of colorectal cancer - quality vs. time constraints in a cross-sectional study

Jasper Plath¹, Insa Koné², Anne Dahlhaus¹, Maja Taubenroth², Sylvia Schulz Rothe², Sandra Rauck², Andrea Siebenhofer³

¹Institute of General Practice, Goethe University Frankfurt, Frankfurt am Main, Germany; German Cancer Research Center (DKFZ), Heidelberg, Germany; German Cancer Consortium (DKTK), Heidelberg, Germany

²Institute of General Practice, Goethe University Frankfurt, Frankfurt am Main

³Institute for General Practice and Health Services Research, Medical University of Graz, Graz, Austria; Institute of General Practice, Goethe University Frankfurt, Frankfurt am Main, Germany; German Cancer Research Center (DKFZ), Heidelberg, Germany; German Cancer Consortium (DKTK), Heidelberg, Germany

Background

The primary aim of the cross-sectional study "FRIDA.Frankfurt" is to detect individuals aged 40-54 years with a positive family history of colorectal cancer (CRC) in a general practice setting. Approximately 875 affected patients are expected to require advice from participating general practitioners (GP) on increased risk and prevention strategies. For this purpose we developed an evidence-based decision aid on screening for persons with affected 1st degree relatives.

Methods

Information for people with a positive family history of CRC taken from a systematic review published in 2013 (search date -2011; Oxman/Guyatt=7) was added to an existing decision aid for the general population. We further performed a systematic update search on the risk of developing CRC (search date 2011-2014, PubMed/CDSR/DARE/CENTRAL), and checked whether information on the usefulness of the described screening-methods from the existing decision aid was transferable to people with a positive family history of CRC. Finally, we piloted the new brochure in two focus-groups.

Results

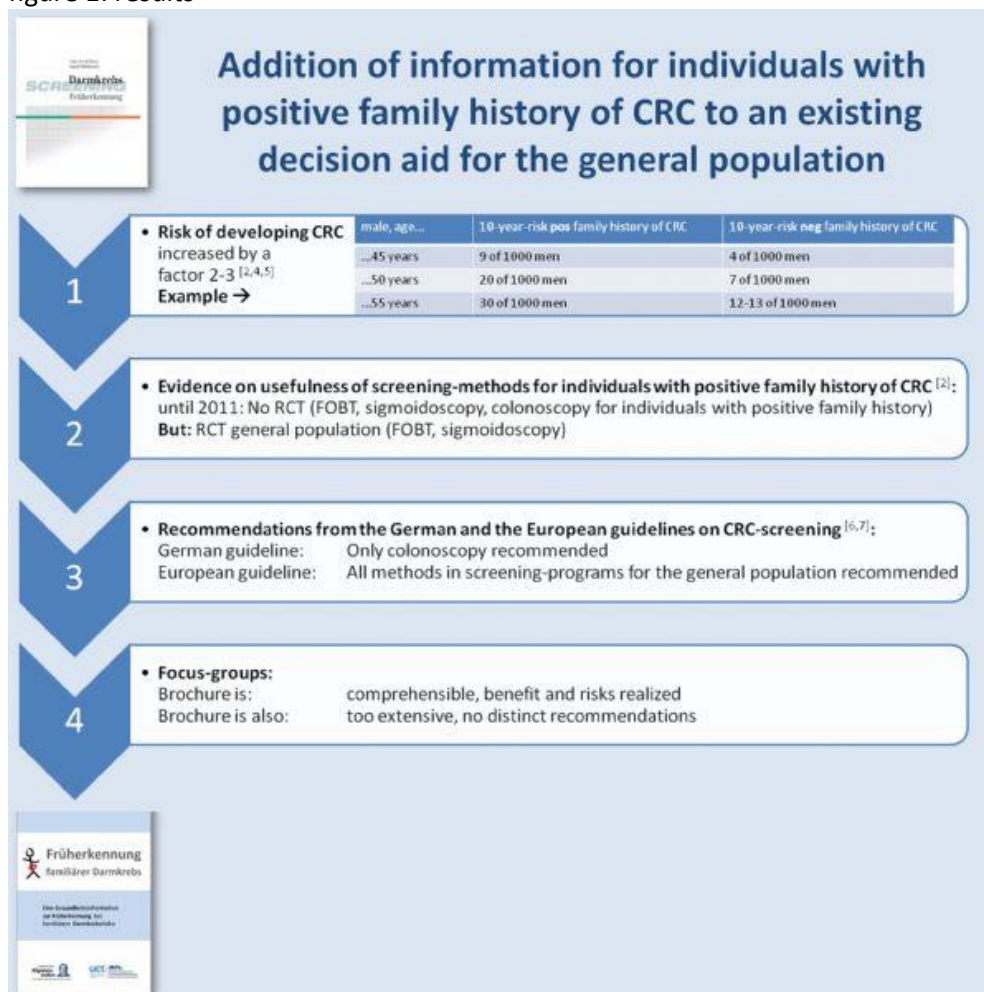
The brochure mainly contains information on the specific risk of developing CRC. Besides the systematic review, we included 1 relevant publication identified during the update search. The risk of developing CRC in the defined age group increases by a factor of 2.7 in case of a family predisposition. The results are shown as natural frequencies. Further contents of the brochure are information on the usefulness of screening-methods and recommendations from guidelines on CRC-screening. Results from the two focus-groups led to minor changes in the layout.

Discussion

On the basis of an existing decision aid, a systematic review and an update search, we developed a high quality brochure for our study within a limited time frame. Profiting from existing trusting relationships between GPs and patients, we expect the distribution of the brochure to result in an increase in the number of study-participants making informed decisions.

Keywords: General Practice, Decision Aid, Colorectal Neoplasms, Familial Risk

figure 1: results



P-0614

Tobacco Control: Building integrative approaches on tobacco use and smoke cessation in Primary Care – example of a Portuguese Healthcare Unit

Ana Sofia Pena, Ana Sofia Inácio, Jacinta Regente, Ana Paula Cardoso, Mariana Anete Mira, Susana Cordeiro Rita
USF Samora Correia, ACES Estuário do Tejo, ARSLVT, Portugal

BACKGROUND:

Tobacco use is the major cause of preventable disease and death and represents a huge burden. The health interventions for tobacco control are effective and efficient. In its latest National Health Plan, Portugal defined tobacco use as a priority health problem and established the main action axis for smoke control.

In our primary healthcare unit, tobacco use in our population was understudied when compared with the national prevalence of tobacco use.

METHODS:

In June 2013, our primary healthcare unit professionals designed an action plan to systematically map the reality of tobacco use in our patient population, so that tailored strategies could be designed and developed to control this health problem.

OUTCOMES:

In 6 months (till December 2013), the number of identified smokers raised about 9,7% compared to the initial value. The plan also allowed a demographic characterization of smokers, enabling us to design appropriate interventions in the future. The whole health team became more aware and motivated to manage this health problem in a daily basis and decided to enlarge the action plan for 2014.

In 2014 the team continued to systematically mapping tobacco use in the unit population and stepped forward with an intervention strategy, by proposing an intensive smoke cessation consultation following specific technical requirements (including skilled team members and specific measures to monitor practice) which was approved and has started in August 2014.

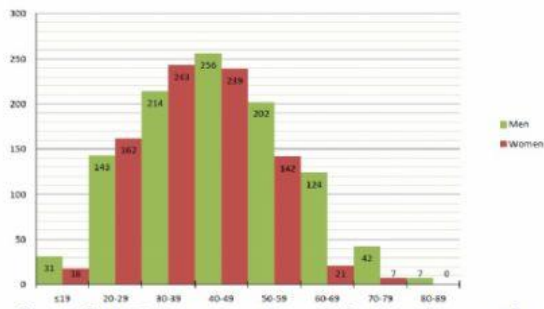
Till December 2014 the number of identified smokers raised about 21% and 56 smoke cessation consultations were performed, assisting 23 patients.

CONCLUSION:

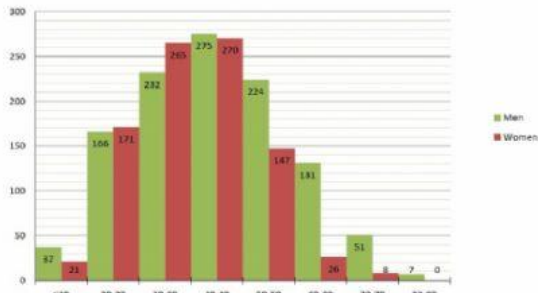
It was possible to improve knowledge about tobacco use in our population and to develop intervention strategies, such as community interventions and a smoke cessation consultation. Specific evaluation indexes were defined and will be available for disclosure by August 2015, when this consultation completes one year of existence.

Keywords: tobacco control, tobacco use, smokers, interventions, smoke cessation

Demographic Characterization of Smoker Patients of USF Samora Correia



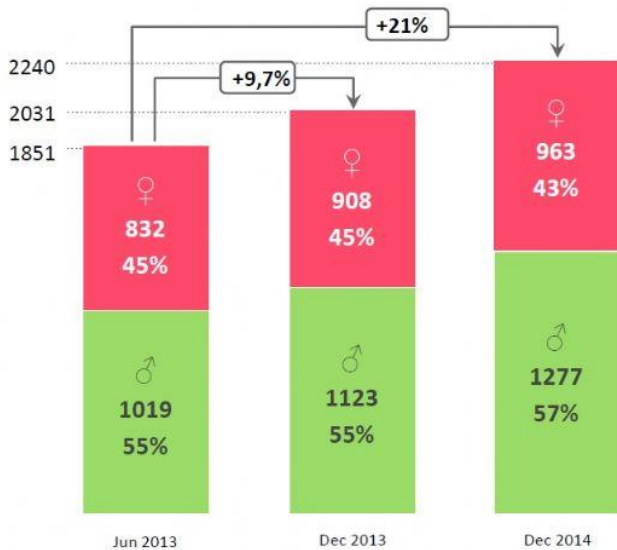
Distribution of USF Samora Correia's smoker patients by age and sex (June 2013)



Distribution of USF Samora Correia's smoker patients by age and sex (December 2013)

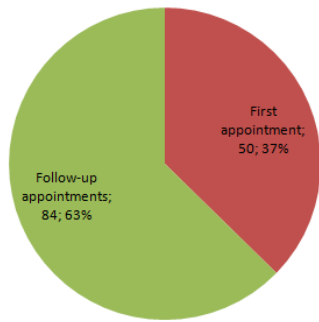
In the section "Results" between the sentence "The plan also allowed a demographic characterization of smokers, enabling us to design appropriate interventions in the future." and the sentence "Furthermore, the whole health team..."

Evolution of the Number of Identified Smoker Patients in USF Samora Correia



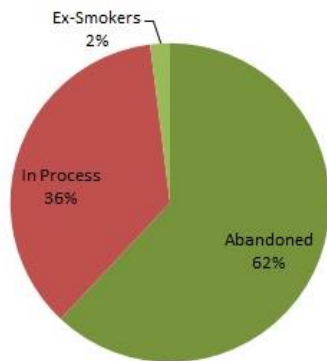
In the section "Results", next to the previous figure or between the 4th and 5th paragraph.

Smoke Cessation Consultations (August 2014 - August 2015)



At the end of the text of the section "results" before the "Adherence to Smoke Cessation Program" figure

Adherence to Smoke Cessation Program



At the end of the text of the section "results"

P-0615

Alcoholism orientation protocol in Primary Health Care

Teresa Pereira Martins¹, Helena Ferreira², Maria João Abreu³

¹USF Novos Rumos - ACES Alto Ave, Portugal

²USF Uarcos - ULS Alto Minho, Portugal

³USF Duovida - ACES Alto Ave, Portugal

BACKGROUND & AIM: All over the world, alcohol is a major public health problem, with a total of 5.9% of deaths caused by alcohol consumption. Recent data from the World Health Organization, revealed Portugal as one of the countries with the highest annual consumption of alcohol: 12.9 liters of pure alcohol per adult. With the alcoholism being a chronic and progressive disease, affecting physical and mental health, and with marked social impact, the aim of this protocol is to unify the approach and orientation of this psychiatric illness in Primary Care.

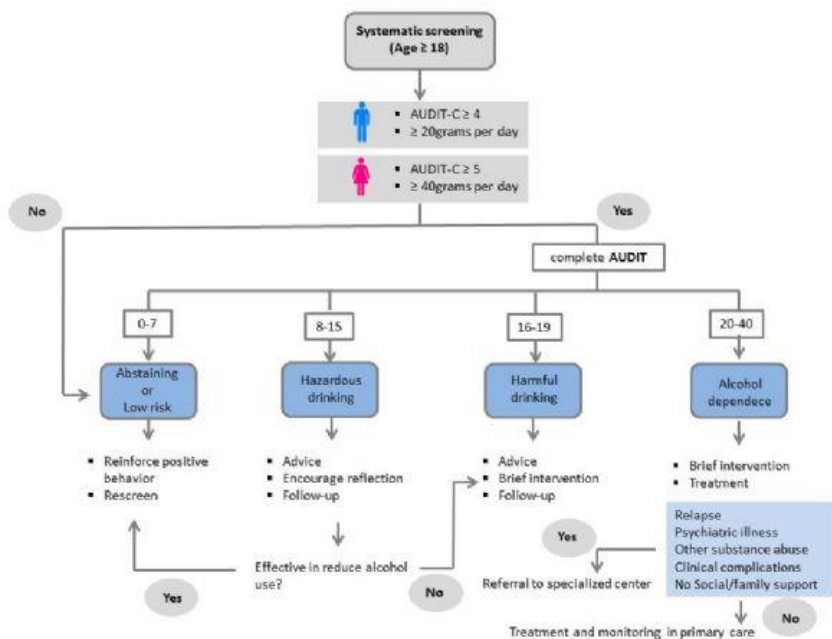
METHOD: Articles research in several databases using the MeSH terms alcoholism and Primary Health Care. The research was limited to the last five years and to articles written in English, Portuguese and Spanish.

RESULTS: Given the high prevalence of use and abuse of alcohol, the family physician, as a professional with continuous follow up of his patients, has diverse opportunities for screening unhealthy drinking. In the presence of alcohol consumption, the amount and dependence of the same should be established, followed by consumption stratification. Whenever pertinent, patient perspective of his consumption and motivation for change should be known. A careful clinical history, physical examination and additional diagnostic tests, allows the proper orientation of the patient in Primary or Secondary Care. Beyond screening and initial approach, the alcoholic dependence treatment includes detoxification and withdrawal phases, with a close follow up from health professionals.

CONCLUSIONS: Several studies have shown that screening and brief intervention in Primary Health Care leads to a reduction of harmful alcohol consumption. This performance may lead to a start point for treatment of alcoholic dependence and consequent or associated diseases.

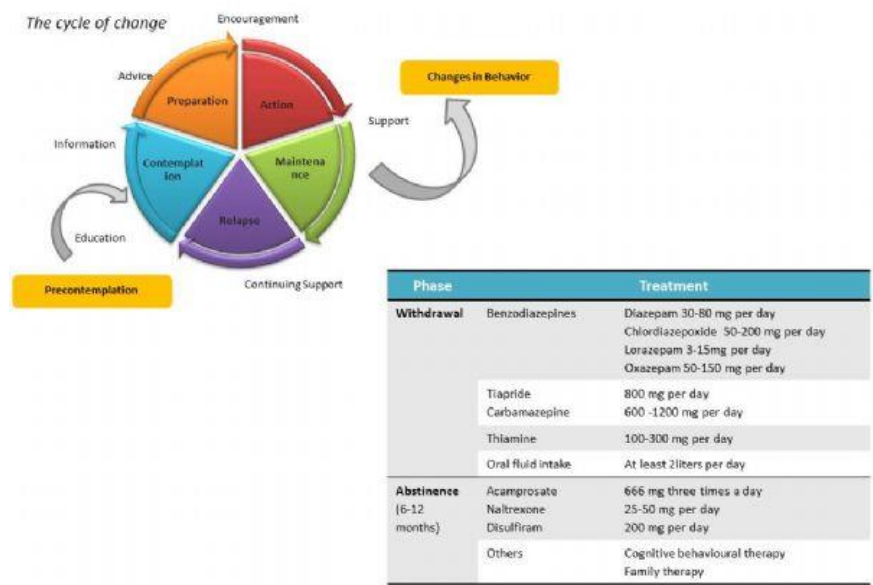
Keywords: alcoholism; Primary Health Care

Figure 1



Screening and orientation protocol of alcohol use disorders

Figure 2



The stages of change; Options of treatment on alcohol dependence in primary care

P-0616

"Phytotherapy and its Place in Alternative Medicine"

Özlem Özer, Halime Pınar Demiröz, Esin Oğuz, Yasemin Nur Makas, Zafer Erdin Demirbaş, Kenan Taştan
Atatürk University, Medical Faculty, the Department of Family Medicine, Atatürk University, Research and
Application Center for Methods of Acupuncture and Complementary Medicine, Erzurum

INTRODUCTION: Phytotherapy is an alternative treatment method that can be described as a treatment approach using plants. According to the World Health Organization, Alternative Medicine is a set of skills, knowledge and practices based on theory, belief and experience specific to different cultures employed to maintain good health as well as protection from physical and mental illnesses, and the diagnose and improvement or treatment of them.

BACKGROUND: The first written document on the therapeutic use of plants dates back to 3000 BC. Civilizations such as Sumer, Assyria, and Akkad in Mesopotamia region are known to have utilized herbal medicine. There are important works of Ibn Sina and Al Gafini on herbal medicine in Islamic Civilization. Ibn Sina wrote about medicinal plants and their use comprehensively in his book called "El KanunFi'tTıbb".

Medical Uses of Phytotherapy:

- Dermatological diseases (allergies, skin rashes, eczema, dermatitis)
- Vascular diseases
- Migraine and similar psychosomatic headaches
- Blood pressure problems (hypertension, hypotension)
- Liver and gall bladder diseases (hepatitis, gallstone)
- Diabetes mellitus
- Rheumatic diseases
- Respiratory diseases

The statement of WHO that 80 % of people believe this natural treatment is a good indicator of this popularity. 600 million people a year in the USA consult alternative medicine specialists to get therapy support and 60 % of the population over 18 years of age use a product of herbal medicine at least once a year. This rate reaches 70 % in Japan.

CONCLUSION: Phytotherapy is widely used all over the world and in our country. However, it can lead to many health problems if used incorrectly. Therefore, the use of phytotherapy by right health care practitioners and the administration of training in this field will be a significant gain in terms of both preventive and therapeutic medicine.

Keywords: Phytotherapy, Alternative Medicine, Medical treatment.

P-0617

World Diabetes Day and World Food Day – General practitioners providing health information and screening in a local science museum

Gonçalo Envia, Inês Lima, Rita Brochado, António Branco, Madalena Rapazote, Hugo Dias
USF Monte da Lua, Várzea de Sintra, Portugal

BACKGROUND AND AIM: Cardiovascular and metabolic conditions such as obesity, diabetes and hypertension are known to be important causes of morbidity and mortality, particularly in developed countries. It is well established that a healthy lifestyle, namely through a balanced diet and physical exercise, is not only the best preventive measure but also the first step in the treatment of such conditions. Family physicians have the responsibility to promote healthy behaviours, either with individual patients or through their unique connection to the community. For that purpose, we developed two activities in a science museum near our primary care centre, to provide information in a fun interactive way and screen the population for cardiovascular risk factors.

METHOD: The first activity (at the World Diabetes Day) aimed to clarify some aspects of the disease, its

prevention and treatment. At the end, attending people were offered the possibility of cardiovascular screening (measurement of blood pressure, blood glucose, body mass index and advice regarding diet, exercise and smoking cessation). The second activity (at the World Food Day) was intended for local students (6th graders) in order to stimulate better lifestyle choices regarding diet and exercise. This activity included a screening for obesity and malnutrition and personal advice.

RESULTS: Both activities were successful, with dozens of participants and a general sense of satisfaction. When cardiovascular risk factors or conditions were identified, people were advised to seek their doctors.

CONCLUSIONS: Family physicians have the unique opportunity to interact with the community. Activities such as these contribute to promote common wellbeing and health. It is desirable that this partnership of the primary care centre with the science museum continues, with new activities in the future.

Keywords: lifestyle, community action, health promotion

Centro Ciencia Viva de Sintra



Centro Ciencia Viva de Sintra Logo

Child Obesity and Malnourishment Screening, World Food Day



Child obesity and malnourishment screening

Presentation, World Diabetes Day



Presentation, World Diabetes Day

Games Healthy Diet 1, World Food Day



Presentation Group, World Diabetes Day



Presentation on the subject Diabetes to a group of high school students (integrated in a health professional course), along with CCVs activities

Cardiovascular Screening, World Diabetes Day



Cardiovascular screening (measurement of blood pressure, blood glucose, body mass index) and advice regarding diet, exercise and smoking cessation

Games Healthy Diet 2, World Food Day



Games regarding a balanced and healthy diet

Dietary Misconceptions 1, World Food Day



Sessions about common dietary misconceptions - Sodas and beverages sugar content

Dietary Misconceptions 2, World Food Day



Group sessions about common dietary misconceptions - Fast-food calories

Group Photo, World Food Day



Group Photo (students, teachers, CCVS staff and Health Professionals)

P-0618

Do our teenagers want to quit smoking?

Ruth Muñoz Maya¹, Álvaro Alonso Flores¹, Carmen María Jiménez Herrera²

¹CS Don Paulino García Donas, Alcalá de Guadaíra. AGS Sevilla-Sur, Andalusia, Spain

²CS Ntra. Sra. de la Oliva, Alcalá de Guadaíra. AGS Sevilla-Sur, Andalusia, Spain

Background: Smoking is nowadays the first preventable cause of death worldwide and contributes greatly to the increasing number of non-transmissible diseases. It's been estimated that nearly six million people die every year because of tobacco smoking related conditions. It also entails a major cost to the sanitary system.

Studies launched in 2012 in our area show that nearly 50% of smokers between 16 and 65 years wanted to quit smoking; 30% of individuals from 16 to 24 years smoked every day. Tobacco consumption is consolidated in secondary education students.

The age of starting smoking is not clearly established in our town, but alcohol drinking begins at about 13 years-old. We presume alcohol and tobacco consumption starting are alike in teenagers.

Andalusian Health Service offers a programme for helping to cease tobacco smoking. Since we've been performing this programme, no adolescent between 12 and 16 years has come to our office asking for help.

Aim: To bring out the reasons why teenagers between 12 and 16 years old in our town don't ask for help to quit smoking

Method: We provided a questionnaire to the pupils in the high school next to our center asking about smoking and information about the ceasing smoking programme we display. We can measure the incidence and prevalence of smoking habit among our young population and the reasons leading them not to ask for help

Conclusions: At this moment we are still collecting data that will be shown at the conference. We find this study interesting because knowing why and how often adolescents smoke and why they don't are motivated to come to our ceasing smoking programme will help us to improve both the service we are providing at our consultation and the health promotion campaigns we display at high schools.

Keywords: adolescent, smoking, smoking cessation, health education

P-0619

Active ageing is not a new concept

Ieda De Paula¹, Vanessa Carvalho¹, Leonor Troni², Inês Abreu Mendes³, Pedro Alves³, Mileta Gomes⁴

¹USF Cynthia, ACES Sintra, Portugal

²UCSP Torres Vedras- extensão Silveira, ACES Oeste, Portugal

³USF D.Sancho I, ACES Lezíria, Portugal

⁴UCSP Almeirim, ACES Lezíria, Portugal

The World Health Organization (WHO) defines active ageing as “the process of optimizing opportunities for health, participation, life-long learning and security in order to enhance quality of life as individuals age”.

Active ageing is a topic deserving an increasing attention in scientific and policy discussions on ageing.

This paper reflects the stance of the WHO on this subject and addresses the challenge of rapid ageing population, especially in developing countries.

Our research was done in databases of Evidence Based Medicine, using the following key words: active ageing, elderly and primary care. It was limited to articles in English, Portuguese and Spanish, published from 2010 until February 2015.

Active Aging promotes elderly living as fully as possible in all areas of life—physical, social, spiritual, emotional, intellectual, vocational and environmental.

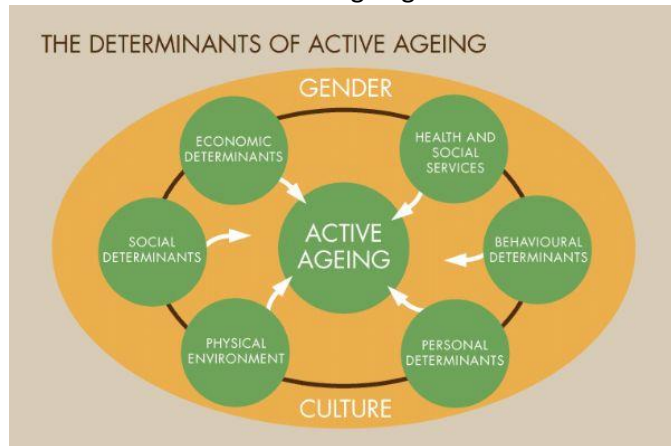
The concept of active ageing is based on three pillars mentioned in the definition: participation, health, and security. The proposed model encompasses six groups of determinants (each one including several aspects): social and health, behavioral, personal, physical, social and economic.

As people age, their quality of life is largely determined by their ability to maintain autonomy and independence and healthy life expectancy.

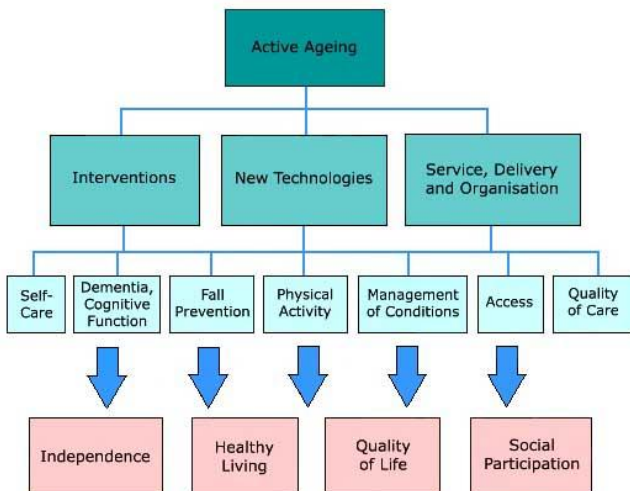
Healthy elder people are a resource to their communities and families. It is important to get involved in groups according individual preferences. They can put their experience, their abilities and their enthusiasm in the volunteering associations or cultural groups. Benefits are double for the society and for the elder people. Active ageing appears as an outcome of different determinants that should allow us to identify particular profiles that are more at risk or, on the other hand, more inclined to age actively.

Keywords: Active ageing; elderly; volunteering

The determinants of active ageing



Breakdown of research into key areas and themes



P-0620

Comprehensive treatment of patients with Diabetes mellitus type 2 in model practice

Katerina Bubnič Sotošek, Andriana Sotirov, Antonija Poplas Susič

Community Health Centre Ljubljana, Ljubljana, Slovenia

Background, AIM: Chronic hyperglycemia presents in patients with Diabetes mellitus type 2 (DM2) is cause for chronic complications. Proper and long term joint cooperation between the medical team and patient improves outcome of treatment. Efficient treatment requires defined quality criteria. The aim is to analyze and search for improvements in treatment of patients with DM2.

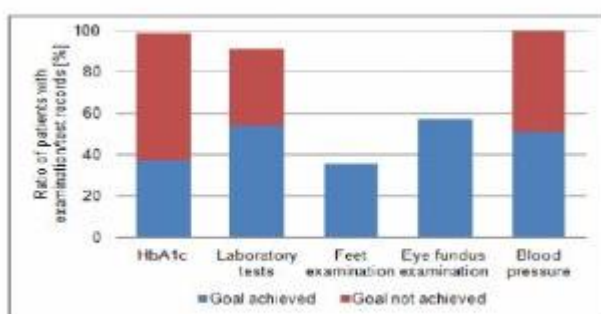
METHODS: The study consisted of 150 patients with DM2 from model practice, treated according to the guidelines and quality criteria: examination of feet and fundus, regularity of blood pressure and laboratory tests: glucose level, HbA1C, lipid profile, glomerular filtration rate and proteinuria/albuminuria.

RESULTS: The 98.56% of patients had annually measured glucose level and HbA1C. Goal values achieved 61.54% of them. For 90.77% of patients laboratory tests were performed, while 36.92% had goal value for LDL cholesterol. Unfortunately, only 35.38% of patients had feet examination. On the other hand, 56.92% of patients had fundus examination. All patients, however, had measured blood pressure, with 49.23% of them having goal values.

CONCLUSIONS: Results show that medical team cares for patients adequately in sense of performed measurements (>90%). The goal values were achieved in less than 50% of all cases. Feet examination had 35% of patients, where main responsibilities have graduate and patronage nurse. To achieve goal values easier patient cooperation is mandatory. For this purpose additional individual education and training would be reasonable. Improvements in treatment should also incorporate regular fundus examination, care for older less mobile patients having difficulties coming to model practice. During treatment in model practice patient should acknowledge essential facts about the disease, accept it as part of everyday life, gain skills and knowledge for its control. Ultimately, the goal is to ensure high quality of life of patients with DM2 regardless of age and controlling the disease and its chronic complications.

Keywords: diabetes mellitus, quality, model practice, home care

Katerina Bubnic Sotosek



P-0621

Assessment of a Sexually Transmitted Infections circuit in an urban primary health care centre

David García Hernández, Santiago Lancho Lancho, María Cecilia Casano Carnicer, Kristýna Klevarová, Agnès Salvador Mateo, Laura Eroles Mallolas, Judit Martínez Téllez, Aina Piera Salmerón, Natàlia Subirats Duran, Maria Inês Dos Reis M. Van Zelst, Ana Romagosa Pérez Portabella, Laura Romera Liébana
EAP Raval Nord Primary Health Care Centre, ICS, Barcelona, Spain

Background and AIMS: Sexually Transmitted Infections (STIs) represent a European public health problem, specially in the last 15 years. Hereby, a STIs circuit was accomplished in an urban primary health care centre (PHCC) in order to: 1) Improve patient accessibility; 2) Provide a global STI care (including diagnosis, notification, treatment, contacts tracing, STIs screening, follow up, prevention and counselling); 3) Increase Primary Care professionals' training and 4) Enhance collaboration between care levels. In addition, patient and doctor satisfaction with this circuit was analysed using questionnaires.

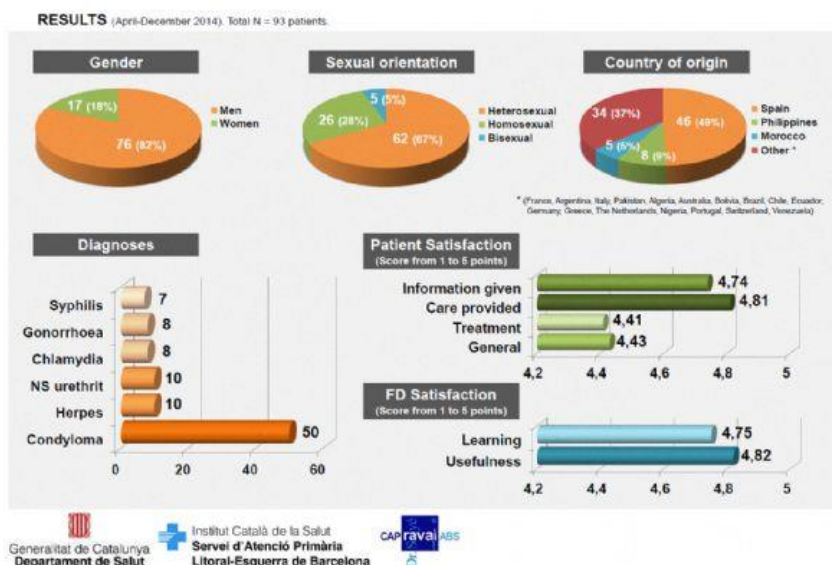
METHOD: The project was initiated in April 2014 by a Family Doctor (FD) with special interest in STIs (FDSISTI), who was previously trained for one year. The FDSISTI performs (with a FD trainee) a weekly STIs consultation in the PHCC. All patients and contacts receive treatment (if necessary), STIs screening, follow up and counselling; and they are referred to other specialists if needed. STIs briefings are held bimonthly for the PHCC professionals. The satisfaction survey consisted of 4 questions to the patients and 3 questions to the referring FDs, with possible score going from 1 (dissatisfied) to 5 (highly satisfied).

RESULTS: Until December 2014, 288 consultations of 93 different patients were performed (82% men, 51% foreigners, average age 34.78). The main diagnoses were: condyloma (50), nonspecific urethritis (10), herpes (10), chlamydia (8), gonorrhoea (8), syphilis (7). The main treatment was cryotherapy. Regarding patient satisfaction, the mean score of the answers was as follows: information given (4.74/5), care provided by the FDSISTI (4.81), treatment-result of the problem (4.41) and the circuit in general (4.43). In terms of FD satisfaction, the mean score of the responses was: learning about STI (4.75/5) and circuit usefulness (4.82).

CONCLUSIONS: Patient and care providers' satisfaction was very high. The circuit can improve accessibility, FDs knowledge and coordination between specialists.

Keywords: Sexually Transmitted Diseases, Primary Health Care, Public Health, Accessibility, Patient Satisfaction

RESULTS



P-0622

Behavior risk in a teenage population of a Lisbon Primary Care Unit

Diana Sofia Duarte¹, Andrea Pova Antunes¹, Catarina Ameixa Morgado¹, Inês Vinga Martins¹, Miguel Marques Ferreira¹, Avelina Pereira Moniz²

¹Family Physician resident, USF Tejo, Lisbon, Portugal

²Family Physician, USF Tejo, Lisbon, Portugal

Introduction

Adolescence, between 10 and 18 years-old (DGS), is characterised by physical, psychological and social changes. The search for a wider autonomy and socialisation may lead to risk behaviours.

The family doctor has a privileged role in the promotion of healthy life styles.

The scarce search for health care services motivated the USF Tejo medical team to implement a session.

Objectives

To know the risk behaviours (alcohol, cigarette smoking, illicit drugs), sexual activity and contraceptive methods used by the teenagers.

Methodology

Study - descriptive and transversal

Population – teenagers between 15 and 18 years-old

Inclusion criteria – teenagers between 15 and 18 years-old affiliated in the USF Tejo during last year

Variables – age, alcohol, cigarette and illicit drugs consumption, age of beginning of sexual activity and contraceptive method used

Methods – Elucidation sessions about risk behaviours

Data collection – fulfilment of an anonymous enquiry

Results

Teenager population: 431 individuals (212 female and 219 male).

The feminine sex was represented by 54 teenagers: age average 15,7 years-old.

11,1% smoke, 48,1% admitted to drink alcohol, 14,8% have experimented illicit drugs, 14,8% have already started sexual life and 75% used condom in the first relation.

The masculine sex had 28 participants with an average age of 16.5 years-old.

7% are smokers, 18% have experimented illicit drugs, 18,5% have already started sexual life, 87,5% mentioned the use of condom in the first relation.

Discussion and conclusions

Information and awareness are protection factors near the adolescent population. The family doctor has the opportunity to act precociously. Teenagers are difficult to convoke. This kind of actions allows the empowerment of this group and improves the visibility of the health services.

Understanding the life style of this sub-population is important for planning the services and to increase the access to health care.

Keywords: Teenagers; Behaviour risk; Family medicine

P-0623

Evaluating potential foods as a cause of foodborne disease

Nikolaos Prassas¹, Panagiota Tsiatsiou¹, Emmanouil Velonakis³, Kassiani Mellou⁴, Konstantina Kontopoulou⁵, Alkiviadis Vatopoulos²

¹AHEPA University Hospital, Thessaloniki, Greece

²Department of Microbiology, National School of Public Health, Athens, Greece

³Central Public Health Laboratory, HCDCP, Athens, Greece

⁴Office Foodborne Diseases, HCDCP, Athens, Greece

⁵General Hospital of Thessaloniki, G. Gennimatas, Thessaloniki, Greece

BACKGROUND-AIM: In the light of current market conditions, the consumers' habits and the mass food production are changing rapidly, therefore, a vast number of consumers run the risk of foodborne diseases. Thus, the purpose of this study is twofold. First, it is aimed at examining the effect of preceded disease from food illness or not on the respondents' perception of the contagiousness of a disease through foods and second to identify which food might be a potential vehicle of foodborne disease by comparing the results of two groups (preceded or no infection).

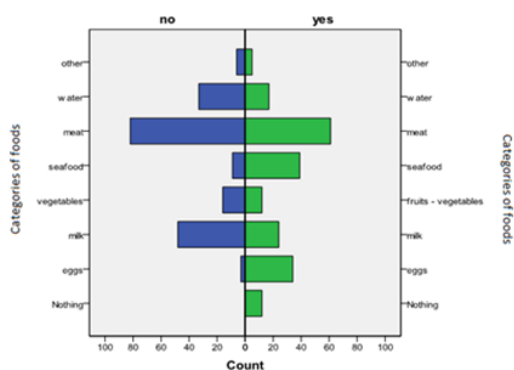
METHOD: In order to accomplish the objectives of this study, a structured questionnaire was used. The data was collected by intercepting patients, companions and employees from AHEPA hospital and Health Center of Sohoh, Thessaloniki, during the period of 01/09/2014 to 28/02/2015 and yielded a usable sample of 401 completed questionnaires. The sample was comprised of 197 respondents without any previous foodborne illness and 204 respondents who had already suffered from a foodborne disease.

RESULTS: The study was conducted by pearson chi-square analysis. The analysis results indicated that significant differences between the two groups were found in all categories of foods, such as eggs ($\chi^2=18.775, sig.0.000$), milk ($\chi^2=42.159, sig.0.000$), vegetables ($\chi^2=17.480, sig.0.000$), seafood ($\chi^2=10.239, sig.0.001$), meat ($\chi^2=30.862, sig.0.000$), water ($\chi^2=33.919, sig.0.000$). The analysis indicated meat, seafood and eggs as the most dangerous kinds of food for an infection by respondents who had already been infected. Unlike meat (lower from the other group), water and milk were blamed for foodborne disease by the previously non-infected respondents.

CONCLUSIONS: The study shows that various foods prompt respondents to be careful with their daily food consumption. However, the differences between groups show that they have not received all the appropriate information on how to protect themselves by everyday food threats and judge subjectively the food categories.

Keywords: foodborne disease, food consumer, perception of consumers

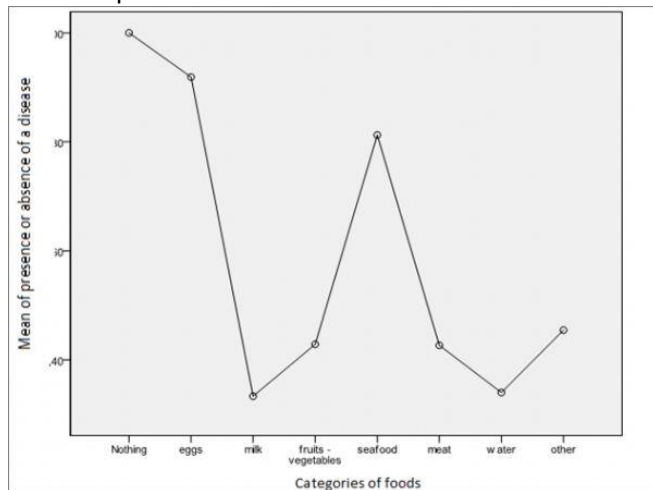
Disease



ANOVA

ANOVA					
Presence or absence of disease					
	Sum of Squares	df	Mean Square	F	Sig.
Between Groups	18,367	7	2,624	12,598	,000
Within Groups	81,853	393	,208		
Total	100,219	400			

Mean of presence or absence of a disease



P-0624

Study Of Relationship Between Female Literacy And Health Status Of Families And Community Among The Female Patients of CHC Muradnagar

Piyush Jain

Community health centre (chc), Department of health and family welfare, Uttar Pradesh, India.

BACKGROUND:

Low female literacy have been shown to result in less healthy choices, riskier behavior, poor health of families and community, less self-management and more hospitalization. They significantly drain human and financial resources in the health system.

This paper explores the impact of female literacy on the general health status of the families in the community, their awareness about the various health issues and utilization of the health facilities present at their nearest health centre.

Aim

To Assess the relationship between the female literacy and health status of families in the community and to raise awareness about health and female literacy among the patients attending OPD of the hospital.

MATERIALS-METHODS:

A cross-sectional, questionnaire-based study was carried out and information was obtained about the general awareness of female patients about health, daily habits, utilization of health facilities, preventive health habits, status of child immunization, number of children, socio-economic status, access to health services, presence of sanitation facilities, employment outside the home and child care management.

RESULTS:

The results shows that relationship between the female literacy and health status of families and community is directly proportional. More the literate female is – better is the health status of her family and community. Study shows that more awareness about the health related issues and health facilities is found among the most literate group of the females. They are more aware about the use of health facilities, size of family, vaccination and other.

Low literacy leads to poorer overall health, misuse of medication or misunderstanding of health information, preventable uses of health services, including emergency care, avoidance of initial symptoms to seek medical help.

CONCLUSION:

Low literacy rate among the females are associated with riskier behavior, poorer health, less self-management and more hospitalization and costs. Thus, it is required to concentrate more on female literacy with the whole-of-society approach by working together to improve the literacy status and health of females in the community.

Keywords: Female Literacy, Health Awareness, Health Status, Community Health.

P-0625

Escherichia coli lysates in recurrent urinary tract infection prevention – Evidence based review

José Silva Russo, Bruno António Covelo De Almeida, Ana Margarida Romão, Sara De Sousa Rocha
Unidade de Saúde Familiar Descobertas, Belém, Lisboa, Portugal

Background & AIM: Urinary tract infections (UTIs) are the second most common community acquired infection and E.coli is the agent responsible for 75% to 95% of cases. The most frequent UTI is acute cystitis, which affects mostly premenopausal women. About one quarter of patients with one UTI infection will be infected again. Recurrent UTI is defined by 2 episodes in 6 months or more than 3 episodes in 12 months. With the emergence of antimicrobial resistance to antibiotics and those being the first line treatment for UTIs it is necessary to find alternative solutions for recurrent UTIs. The use of prophylactic immunotherapy of Escherichia coli lysates can make an important contribution in reducing recurrences without interfering with resistance to antimicrobials. Our aim is to determine the scientific evidence about the effectiveness of therapy with bacterial lysates of E.coli in the prophylaxis of recurrent UTI in women.

METHODS: Literature research in the main databases using the following MeSH terms: UTI terms, Uro-vaxom and OM-89. We selected the articles that met the inclusion criteria. To assess the level of evidence and strength of recommendation, we used the Strength of Recommendation Taxonomy scale (SORT) of American Family Physician.

RESULTS: we obtained 33 articles from which we selected 5 that complied by the criteria set in METHODOLOGY: 2-meta-analyzes, 2-clinical trials and 1-standard clinical guidance. The clinical trials found a 34% reduction (level of evidence 1) in UTI recurrence in a 12 months follow-up. In the meta-analysis, there is a risk reduction of around 39%. The clinic orientation norm selected, by the European Association of Urology, recommends the use of bacterial lysates in recurrent UTI in women.

CONCLUSION: Treatment with lysates of E.coli is indicated in recurrent UTI prophylaxis in women (SORT B). The use of this therapy is safe with low incidence of clinically significant adverse reactions.

Keywords: urinary tract infection; Uro-vaxom; OM-89

Articles of Revision

Author	Study type	Population	n	Dosage	Duration	Results	NE
Bauer et al. 2002	Meta-analysis	F	601	90 days	90 days	Effective on prophylaxis with IC 0,64-0,72	1
Naber et al. 2009	Meta-analysis	F+M	975	90 days	6-12 M	39 % reduction of recurrency	1

Guideline

Author	Study Type	Results	NE
Grabe et al. 2011 EAUrology	Guideline	Recommended on recurrent UTI on women	1

Clinical Trials

Author	Study type	Population	n	Dosage	Duration	Results	NE
Bauer et al. 2005	Double-blind placebo-control trial	F	453	90 d + 3 M0 + 3M10d	12 M	34 % reduction on recurrency (p<0,003)	1
Kim et al. 2010	Clinical trial without placebo control	F	34	90 d	12 M	Recurrency reduction 0,35 Vs 4,26 (p<0,001) after treatment	2

P-0626

Health Diagnosis of Es Coll d'en Rabassa neighbourhood

Enrique Alvarez Porta¹, Catalina Isabel Bisbal Navarro¹, Pablo Alexander Rosario Dourthe¹, Atanasio Garcia Pineda¹, Sebastià March Llull², Rosa Duro Robles¹, Antonia Fe Pascual¹, Josep María Méndez Guillaumet¹

¹Es Coll d'en Rabassa / UBS Es Molinar Health Center. Palma de Mallorca. Spain.

²Research Technical Office of the Teaching Unit of Family and Community Medicine of Palma de Mallorca. Spain.

BACKGROUND: The Health District (ZBS) of Coll d'en Rabassa encompasses the neighbourhoods of Can Pere Antoni, El Molinar and Coll d'en Rabassa and is forming part of the district Playa de Palma (Palma de Mallorca).

OBJECTIVES:

- Principal: Analyze the health status of the population of the Coll d'en Rabassa ZBS.
- Secondary: 1) Gather social determinants and health information for this population. 2) Know the expectations in health of population and health professionals. 3) Identify actives in health in the ZBS.

METHODS:

- Design: quantitative and qualitative, cross-sectional, descriptive study.
- Population: Residents of Coll d'en Rabassa ZBS.
- Sampling: 6 representative informants of the population of the ZBS.
- Collection of information: quantitative information on health determinants and indicators are prompted to official institutions; semi-structured individual interviews were conducted in depth to reach saturation of information, selecting participants through subjective sampling by reasoned decision, with the help of key informants in the field. The interviews will be tape recorded and later transcribed. The content will be analyzed by everyone in the team.

RESULTS: Results of this study will be available in May 2015.

Conclusiones: Conclusions of this study will be available in May 2015.

Keywords: Diagnosis, Health Promotion, Community.

Es Coll d'En Rabassa Health Center



First Meeting with Community VIP



Healthy Walking Track Design



P-0627

Internet addiction- Only a theoretical problem?

Pedro Moreira Castro¹, Sofia Paulino², Ana Rocha³, André Lourenço³, Inês Macedo³

¹USF Modivas, ACeS Grande Porto IV, Vila do Conde, Portugal

²Serviço de Psiquiatria, Centro Hospitalar Lisboa Norte, Lisboa, Portugal

³USF Modivas, ACES Póvoa do Varzim, Vila do Conde - Portugal

BACKGROUND AND AIM: Given the widespread use of the Internet, researchers have begun to examine the personal and social consequences associated with excessive online involvement. We made a review of the published literature on Internet Addiction (IA) in young adults with the aim of defining the problem and the most effective therapeutic intervention.

METHOD: multiple database search (textbooks, guidance manuals, systematic reviews and articles published in scientific databases selected for their adequacy and scientific relevance).

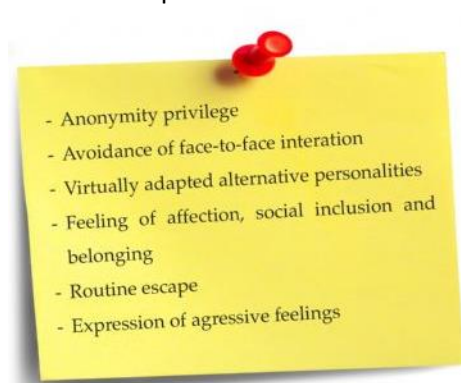
RESULTS: Internet Addiction can be conceptualized as an inability to control one's use of the Internet. Although pathological gambling is currently the only confirmed behavioral addiction, Internet Gaming Disorder emerges for the first time in the DSM-5 appendix as an entity under study.

IA is not only positively correlated with psychopathology and psychiatric disorders but also has severe consequences in several bio-psychological areas of life such as loss of occupational and social functioning, sedentary lifestyle, weight gain, insomnia, interrupted sleep and decreased total sleep time, changes in circadian rhythm, social isolation and disruption of interpersonal relationships.

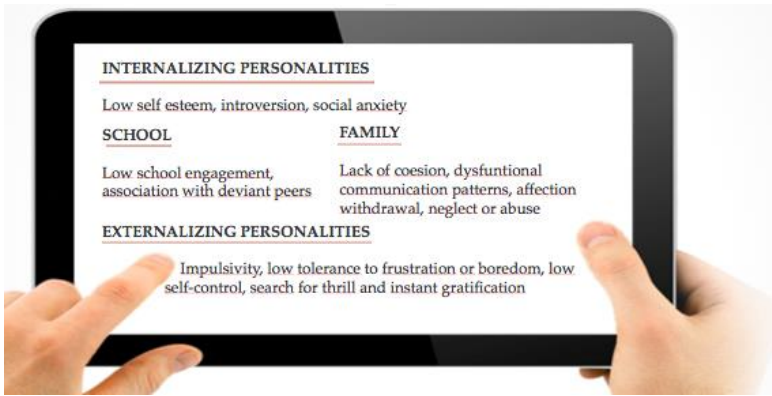
CONCLUSIONS: Health care services can and need to raise awareness of this entity and of the associated interventions. Family doctor is usually the first contact within the health care system so it's essential to know how to identify major risk factors and be able to recognize the issue earlier.

Keywords: "Internet addiction", "interventions" and "problematic Internet use".

Internet use potentials



Risk Factors



[www.fromtheorytopractice.!](http://www.fromtheorytopractice.)



P-0628

OM-89 for prevention of recurrent urinary tract infections: An evidence based review

Ana Margarida Pinho, Célia Gomes Silva, Ana Catarina Rodrigues

ACES Entre Douro e Vouga I Feira/Arouca, USF Famílias, Lourosa, Santa Maria da Feira, Portugal

Background & Aim

Recurrent urinary tract infections (UTIs) are very common in women and responsible for considerable morbidity and health care use.

Recurrent uncomplicated UTIs may be defined as 3 or more uncomplicated UTIs in 12 months.

In individuals with recurrent UTIs, low dose antibiotic prophylaxis for several months can be recommended.

Escherichia coli is the predominant uropathogen isolated in acute community-acquired uncomplicated UTIs. The increasing prevalence of this bacteria isolates that are resistance to antimicrobial agents has stimulated interest in nonantibiotic methods for the prevention of UTIs.

The aim is to review the available evidence on the efficacy of OM-89 in preventing recurrent uncomplicated UTIs.

Method

A search for clinical practice guidelines, meta-analysis, systematic reviews, evidence-based reviews and clinical trials published between January 2005 and March 2015, in English, Spanish and Portuguese was performed using

the MeSH terms: UTIs and OM-89. The Strength of Recommendation Taxonomy scale of the American Family Physician was used to assess the quality of the studies and the strength of the recommendation.

Results

Of the eleven articles found, only three fulfilled the inclusion criteria and were selected. These included one practice guideline, one meta-analysis, and one systematic review.

The practice guideline recommended OM-89 for immunoprophylaxis in female patients with recurrent uncomplicated UTIs. The meta-analysis and the systematic review are concordant and suggest that OM-89 seems to effectively decrease the recurrence of UTIs in adult women without associated comorbidities.

Conclusions

Evidence from available studies suggests that the oral immunostimulant OM-89 can be beneficial for preventing recurrent UTIs in women (Strength of Recommendation B).

However, this recommendation is limited by the heterogeneity of studies.

More studies are needed to establish safety and tolerability in other populations as well as the efficacy relative to antimicrobial prophylaxis and other nonantibiotic prophylaxis products.

Keywords: Urinary Tract Infection; OM-89; Vaccination.

Inclusion Criteria

P Population/patient	Adult female patients with recurrent uncomplicated UTIs
I Intervention/indicator	OM-89
C Comparator/control	Placebo or other prophylactic therapy
O Outcome	Prevention of recurrent uncomplicated UTIs

Meta-Analysis and Systematic Review

Type of Studies	References	Population/ Intervention	Results	Conclusions	Levels of Evidence
Meta-Analysis	Naber KG et al. 2009	5 trials n = 480 OM-89 vs Placebo Follow-up: 6- 12months	OM-89 vs Placebo RR=0.43 95% CI 0.34 - 0.55 p<<0.001	There were significantly more patients without any UTI among the OM-89-treated patients.	2
Systematic Review	Beerepoot MAJ et al. 2013	4 trials n = 891 OM-89 vs Placebo Follow-up: 6- 12months	OM-89 vs Placebo RR=0.61 95% CI 0.48 - 0.78 p=0.021	The oral immunostimulant OM-89 decreased the rate of urinary tract infection recurrence.	2

Practice Guideline

Practice Guideline	Year	Conclusions	Strength of recommendation
European Association of Urology	2015	OM-89 can be recommended for immunoprophylaxis in female patients with recurrent uncomplicated UTI.	B

P-0629

Pharmacological Treatment of Obesity and Excess Weight in Adult: A review

Sara Quelha, Bruno Morrão, João Dias, Rita Miranda
 USF Arca d'Água; ACeS Porto Oriental; Porto; Portugal

Background and AIM: Obesity and overweight are the most common nutritional disorder in Western society whose prevalence has increased globally. The General Practice (GP) deals daily with the consequences of this epidemic, the higher risk that this entails the development of major health complications. Thus, it is essential to act early and treat excessive weight gain. The aim of this study is to summarize the pharmacological therapy available for the treatment of obesity and overweight.

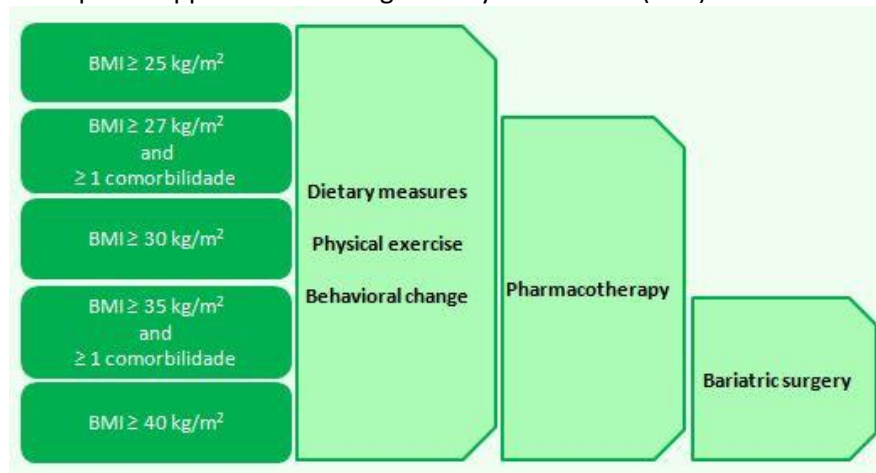
METHODS: Classic literature review, based on articles in the PubMed, referring to promoters of weight loss drugs.

RESULTS: The mainstay of treatment is lifestyle changes (diet and exercise) and behavior, which can be combined pharmacological and / or bariatric surgery. However, not always the diet and exercise are enough to reverse the underlying biological and psychological disruption. Currently there are eighteen drugs available to treat these diseases, all effective in weight loss, though minor is not associated with the above changes.

CONCLUSIONS: The anti-obesity drugs have been become an added therapeutic value, being only two approved and available in Portugal. Since this is a constantly evolving area, the launch of new drugs are perspective-in combating this disease.

Keywords: obesity, anti-obesity agents, drug therapy

Therapeutic approach according to Body Mass Index (BMI) and comorbidities



Drugs approved by the FDA for pharmacological treatment of overweight and obesity in adults.

Drug	Action	Weight loss	Via administration Dosage	Adverse Effects
Orlistat ¹	Digestive lipases inhibition	2.9-3.4 kg	Oral. 120 mg tid	Steatorrhea, decreased absorption vitamins ADKE, kidney stones, liver failure, pancreatitis
Liraglutide ¹	GLP1 Agonist	5.8 kg	Subcutaneous. 3 mg id	Nausea, vomiting, increase in heart rate, increased risk endocrine neoplasia (rodents)
Lorcaserin	Selective receptor agonist 5HT2c	3.6 kg	Oral. 10 mg bid	Headache, dizziness, hypoglycemia, nausea, nasopharyngitis, increased prolactin, serotonin syndrome
Phentermin + Topiramate	Sympathomimetic + GABA Agonist	6.6-8.6 kg	Oral. Titulation 3.75/23mg → 15/92 mg id	Insomnia, increased heart rate and blood pressure, paresthesia, dry mouth, teratogenicity
Naltrexon + Bupropion ¹	Opioid antagonist reuptake + inhibitor dopamine / norepinephrine	4.8%	Oral. 32/360 mg qid	Nausea, constipation, headache, vomiting, dizziness

¹ Drug approved or awaiting approval by the EMA.

P-0630

Pulmonary Lymphangitic Carcinomatosis due to Breast Cancer: A Case Report

Daniel Beirão Sousa, Sofia Marçalo, Maria Cândida Guedes

Unidade de Saúde Familiar S. Félix da Marinha, ARS Norte, Vila Nova de Gaia, Portugal / Family Medicine Center of S. Félix da Marinha

Background and AIM: Breast cancer remains the most lethal malignancy in women across the world. It is known to metastasize to the lung, liver, bone and brain. However, manifestation through lymphatic spread to the lungs is rare. In fact, Pulmonary Lymphangitic Carcinomatosis (PLC) accounts for only approximately 6 to 8% of all intra-thoracic metastatic disease. The occurrence of PLC is most common in lung cancer, followed by breast cancer and gastric cancer.

CASE: A 55-year-old women, with a breast carcinoma on 6th year remission, initially presented to our clinic with dry cough of one month duration, which became productive at the time of our examination. The patient reported no further relevant symptoms. A chest radiograph was requested and empiric and ambulatory antibiotic therapy was initiated to treat a suspected community acquired pneumonia. One month later, she appears with progressive dyspnea, weight loss and a single cervical adenopathy. Lymph node biopsy was inconclusive, but computerized tomography (CT) scan of thorax and abdomen revealed abnormalities in the right lung and PLC with pleural and pericardia effusion. The patient was immediately referred to an Oncological Hospital, where she went for further disease studies. About 3 weeks after our referral she was admitted for hospitalization due to a rapidly progressive dyspnea. She died of respiratory failure 7 days later.

CONCLUSION: PLC is a rare clinico-pathological entity, and its presentation can mimic several lung disorders. A high index of suspicion is required to diagnose this condition. To date, no effective strategies have been developed for PLC treatment and so, the prognosis remains extremely poor.

Keywords: pulmonary lymphangitic carcinomatosis, breast cancer, respiratory failure.

Thorax computerized tomography (CT) scan



Computerized tomography (CT) scan of thorax and abdomen at diagnosis of lymphangitic carcinomatosis: Arrows represent thickening and irregularity of interlobular septa and arrow head represents thickening of bronchovascular bundles.

P-0631

Evaluation of the alcoholic habits of a sample of the population of registered users in a primary health care unit

Catarina Bica, Lílíana Carvalho, Nuno Sena De Barros, Andreia Gonçalves, Ana Sofia Rua

USF Marquês de Marialva, Cantanhede, Portugal

BACKGROUND: Alcohol is the third leading cause of disease and premature death worldwide. In Europe, where alcohol consumption is highest, it's also the third leading risk factor for morbidity and mortality for various diseases, increase in crime rates, domestic violence and road accidents. A recently published study showed that

the prevalence of consumption at levels above the recommended can reach 34% and that 70% to 98% of cases are not identified.

AIM: To explore the drinking habits of a sample of the registered users in a primary care health unit, through the application of the AUDIT questionnaire.

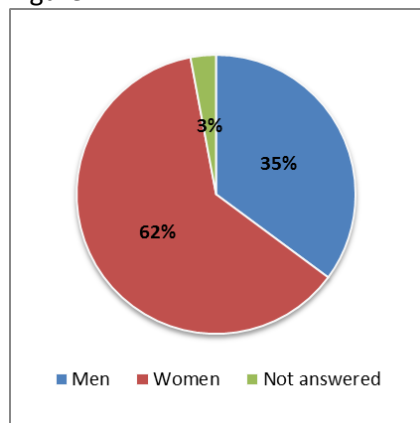
METHOD: Observational, cross-sectional study with analytical intention. Convenience sample of users asked to fill an anonymous questionnaire, from 21/10/2014 to 11/07/2014, with a section on cardiovascular disease history, smoking habits and another with the AUDIT. Inclusion criteria: users with consultation, above 18 years old, literate (or illiterate if aided by a third party). The selected variables: age, education, profession, disease, CVD history and results of the AUDIT. Statistical analysis with Microsoft Office Excel 2010®.

RESULTS: Of the 482 questionnaires returned, 441 were considered valid. Of these, 35.1% were men. The average age was 50 years. In AUDIT, 98% had a score between 0 and 7; 8 users reported a score between 8 and 15 (harmful use); 2 users scored between 16 and 19 (risk drinking) and only 1 user earned a score between 20 and 40 (alcohol dependence).

CONCLUSION: We can conclude that the vast majority of users who responded to the survey have acceptable alcohol consumption, requiring only preventive education in this area. However, these results were unexpected, since it is a population living in a wine region, leaving the authors to wonder about the veracity of the statements and the reality of alcohol consumption in the population studied.

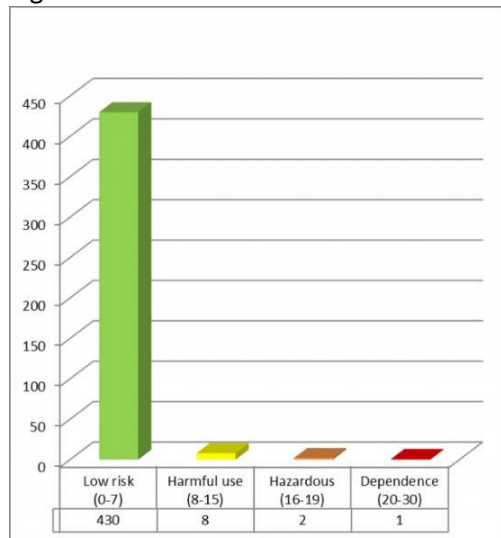
Keywords: alcoholic habits, AUDIT questionnaire, premature death

Figure 1



Gender distribution of the studied sample.

Figure 2



AUDIT score distribution of the studied sample.

P-0632

Initial compliance evaluation to Mediterranean diet of a population of a Primary Health Care Unit

Nuno Barros, Catarina Bica, Andreia Gonçalves, Sofia Rua, Luis Ribeiro

USF Marquês de Marialva, Cantanhede, Portugal

Background and Aim

The Mediterranean diet (MD), originated from countries in the Mediterranean basin, is characterized by a nutritional model that has been considered, by current evidence, as one of the healthiest, translating into a lower risk of mortality from cardiovascular disease (CVD), cancer and lower probability of dementia.

This study's main goal is to explore the dietary habits of a population of patients from a Primary Health Care Unit, regarding their level of adherence to this type of diet.

Method

Observational, cross-sectional study with analytical intention. Convenience sample of users asked to fill an anonymous questionnaire, The MEDAS (MD adherence screener) adapted, for a period of six days. Inclusion criteria: users with consultation, over 16 years old. We selected the variables Body Mass Index (BMI), waist circumference Height Ratio (WCHR), smoking habits and physical activity. Statistical analysis was made with Microsoft Office Excel 2010®.

Results

Out of the 80 questionnaires distributed, 43 were correctly filed. Of these, 39.5% were male. The mean age value was 48.84 years old (17-80). Regarding BMI and WCHR, the mean values were 29.15kg/m² (19.28-46.25) and 0.60 (0.39-0.83), respectively. Obesity was found in 39.54% of patients and 41.18% had BMI over 35; 11.63% smoke regularly, whereas 44.19% were former smokers. Only 24.1% claimed to practice exercise regularly.

The MEDAS Score had a high mean value of 9.07 (4-13), meaning a high adherence to the MD.

Conclusions

Despite the high level of adherence to the MD, the sample shows high prevalence of obesity and low levels of exercise. Because many previous studies support the role of the MD on lowering the risk of metabolic syndrome when associated with regular physical activity and no smoking habits, our study showed us that we need to focus on the encouragement of physical activity and smoking cessation programs.

Keywords: Mediterranean diet, cardiovascular disease, MEDAS questionnaire

MEDAS Questionnaire

PARTE I

1 - Idade: _____ 2 - Sexo: Masculino Feminino

3 - Nível de Escolaridade:

- | | |
|--|--|
| 1 Não sabe ler nem escrever <input type="checkbox"/> | 5 Ensino Básico (3.º Ciclo) <input type="checkbox"/> |
| 2 Não completou o ensino básico <input type="checkbox"/> | 6 Ensino secundário (10º e 11º ano) <input type="checkbox"/> |
| 3 Ensino Básico (1.º ciclo) <input type="checkbox"/> | 7 12.º ano <input type="checkbox"/> |
| 4 Ensino Básico (2.º Ciclo) <input type="checkbox"/> | 8 Bacharelato <input type="checkbox"/> |
| | 9 Licenciatura <input type="checkbox"/> |

10 Outro Especifique: _____

4 - Profissão: _____

5 - Localidade onde vive: _____

6 - Doenças que tenha:

- 1 Hipertensão arterial
- 2 Colesterol elevado
- 3 Diabetes
- 4 História de Enfarte
- 5 História de AVC
- 6 Outras doenças Especifique _____

7 - Tem história familiar de Doenças Cardiovasculares: Não Sim

Se respondeu sim especifique quais? _____

The MEDAS Questionnaire is divided in three parts: Items regarding age; education; current job; past, present and family history and habits (physical activity, smoking and drinking);

MEDAS Questionnaire

8 - É Fumador actualmente? Não Sim

Se respondeu sim em média quantos cigarros fuma por dia? _____

Se respondeu não já alguma vez fumou? Não Sim Quantos anos? _____

9 - Consome bebidas alcoólicas? Não Sim

10 - Qual a bebida alcoólica que consome mais regularmente?

1 Cerveja

2 Vinho

3 Whisky

4 Vodka

5 Outra Especifique: _____

11 - Quantos copos de álcool bebe, em média, por dia?

1 ou 2 5 ou 6 9 ou 10

3 ou 4 7 ou 8 Mais de 10

12 - Pratica exercício físico? Não Sim

Se respondeu sim quantas vezes por semana? _____

PARTE II

Questões sobre a adesão à Dieta Mediterrânica:

1 - Utiliza o azeite como principal gordura culinária? Não Sim

2 - Que quantidade de azeite consome num determinado dia (incluindo o azeite usado para fritos, saladas, refeições fora de casa, ...)? _____ (medida em colheres de sopa)

3 - Quantas porções de vegetais consome por dia? (1 porção: 200g ou salada crua) _____

4 - Quantas peças de fruta (incluindo sumos naturais) consome por dia? _____

Items regarding adherence do Mediterranean Diet;

MEDAS Questionnaire

5 - Quantas porções de carne vermelha, hambúrguer ou produtos de carne (presunto, salsicha, etc) consome por dia? (1 porção: 100-150g) _____

6 - Quantas porções de manteiga, margarina ou natas consome por dia? (1 porção cerca de uma colher de sopa) _____ (< 1)

7 - Quantas bebidas doces ou gaseificada bebe por dia? _____

8 - Quantos copos de vinho consome por semana? _____

9 - Quantas porções de legumes consome por semana? (1 porção: 150g) _____

10 - Quantas porções de peixe ou marisco consome por semana? (1 dose de 100-150g de peixe ou 4-5 peças ou 200g de marisco) _____

11 - Quantas vezes por semana consome doces comerciais ou pastéis (não caseiros), como bolos, biscoitos, bolachas ou creme? _____

12 - Quantas porções de nozes (incluindo o amendoim) consome por semana? (1 porção 30g ou uma mão cheia) _____

13 - Consome preferencialmente frango, peru ou carne de coelho, em vez de carne de vitela, carne de porco, hambúrguer ou salsicha? Não Sim

14 - Quantas vezes por semana consome legumes, massas, arroz ou outros pratos temperados com refogado (molho feito com tomate, cebola, alho ou alho-francês e com azeite)? _____

PARTE III (a preencher pela Enfermeira)

Peso: _____ (Kg) Altura: _____ (cm) Perímetro Abdominal: _____ (cm)

Tensão arterial: _____ (mmHg)

Muito obrigado pela sua Participação.

Biometry (weight, height, waist circumference, blood pressure).

P-0633

Immunization Status of Young People Attending a Youth Clinic in Geneva, Switzerland

Anne Meynard¹, Lydia Markham Genequand², Emilien Jeannot³, Claire Anne Wyler Lazarevic⁵, Bernard Cerutti⁴, Françoise Narring¹

¹Unité Santé Jeunes, Division of General Pediatrics, Department of Pediatrics, University Hospitals, Geneva, Switzerland

²Private Practice, Nyon, Switzerland

³Faculty of Medicine, Institute of Social and Preventive Medicine, University of Geneva, Geneva, Switzerland

⁴Faculty of Medicine, University of Geneva, Geneva, Switzerland

⁵Department of Public Instruction, Geneva School Health Service, Geneva, Switzerland

AIM:

To assess immunization status and analyze potential variations according to sociodemographic variables in a youth clinic in Geneva

BACKGROUND:

Worldwide, adolescents are under-vaccinated and have limited access to preventive health care. In Europe, vaccination of adolescents is brought to focus because of ongoing measles epidemics, increasing cases of whooping cough, Hepatitis B and Human papillomavirus (HPV) vaccination campaigns. Still, data about adolescent vaccination in Europe are scarce.

METHOD:

Immunization status was assessed retrospectively with Tetanus and measles as indicators of childhood immunization as well as Hepatitis B and HPV. Sociodemographic data was collected (age, sex, nationality, duration of stay in Switzerland for foreigners).

RESULTS:

All new patients (N=390) of Geneva University Hospital 's Youth clinic were included between January 2010 and June 2011. Vaccine coverage was low for all vaccines regardless of sex or country of origin. 89% of young people tested (mostly recent immigrants with no available immunization data) had tetanus antibodies indicating adequate childhood immunization. Hepatitis B and HPV coverage was low especially in recent immigrants.

CONCLUSION:

This is one of the few studies showing data on Tetanus antibodies in a clinical sample of adolescents and young adults. Systematic assessment of immunization status and individually adapted catch-up plan allows better adolescent vaccine coverage and improves safety by avoiding unnecessary dosis. It also allows addressing barriers to vaccination and individual counselling of various health and preventive issues with the adolescent.

Keywords: Tetanus Antibodies, Adolescent preventive health care, Hepatitis B, Human papillomavirus,

Immunization policy, Geneva 2010-2011

Receptionnists, ask Young people to bring immunization booklet at first visit

Assessment of immunization status at first visit (nurse or doctor)

Booklet, school health services, country specific information for foreign born youth¹

¹(<http://www.who.int/immunization/en/>)

Nurse visits

Counseling, lab tests as requested by clinical situation, reminder to get immunization data

Information on vaccines and catch up plan to YP and parents

Immunization booklet or reliable information

YES

Catch up missing ~~dosis~~ according to Swiss immunization plan (www.infovac.ch, www.mesvaccins.ch)

NO

1 dose age-appropriate Tetanus regiment (~~d(Ta-Pa-Co)~~)
1 dose MMR
At 1 month: Blood test + MMR dose 2
Tetanus AB titers, Hepatitis B and other if ~~needed~~ (HIV, iron, RBC, WBC)
Chickenpox, parasites, IGRA
Immunization according to results

P-0634

Non-alcoholic fatty liver disease, an actual problem!

Susana Grilo Lourenço¹, David Rodrigues¹, Marta Lopes¹, Nídia Nunes¹, Teresa Pereira Leite²

¹USF Planície, ARS Alentejo, Évora, Portugal

²USF Alcoides, ARS Alentejo, Montemor-O-Novo, Portugal

Non-alcoholic fatty liver disease is the accumulation of fat in the liver of people who drink little or no alcohol. Is more common than alcoholic liver disease owing to the rapid rise in the prevalence of obesity and it usually causes no signs, no symptoms and no complications. In some people can progress to liver failure. Biographical research of clinical guidelines, systematic reviews, and meta-analysis in English and Portuguese, published in the last 5 years, in Medline database employing the MeSH terms: "non-alcoholic fatty liver disease". Non-alcoholic fatty liver disease is now the commonest cause of abnormal liver function tests. The exact prevalence is not known, but affect up to a third of the population in many developed countries and up to 70% in patients with type 2 diabetes mellitus. Between 10% and 30% of patients can progress to cirrhosis. It usually causes no signs and symptoms. Many patients remain undiagnosed, and recognizing those at risk is the first step. Liver biopsy is the gold standard method for diagnosis and staging, but the majority of patients can be effectively diagnosed non-invasively with tests that are routinely available in the clinic nowadays. No standard treatment exists. Lifestyle interventions aimed at weight loss and increased activity are essential for all patients in its treatment. For patients who fail lifestyle intervention, liver-directed pharmacotherapy with pioglitazone or vitamin E can be considered. Features of the metabolic syndrome and cardiovascular risk factors are very common, so all patients should be screened for these and have they managed aggressively. For patients who develop advanced disease, they require surveillance for and management of the complications of cirrhosis. Non-alcoholic fatty liver disease affected approximately 30% of the population and can cause significant liver disease. Accurate diagnosis and staging are important in determining the appropriate long-term management for patients.

Keywords: NON-ALCOHOLIC FATTY LIVER DISEASE, LIVER DISEASE

Sattar Naveed et al: "Non-alcoholic fatty liver disease". BMJ. July 2014.

Dyson JK et al: "Non-alcoholic fatty liver disease: a practical approach to diagnosis and staging". Frontline Gastroenterology 2014.

Dyson JK et al: "Non-alcoholic fatty liver disease: a practical approach to treatment". Frontline Gastroenterology 2014.



Non-alcoholic fatty liver disease is now the commonest cause of abnormal liver function tests. The exact prevalence is not known, but affects up to a third of the population in many developed countries and up to 70% in patients with type 2 diabetes mellitus. Between 10% and 30% of patients can progress to cirrhosis.

Non-alcoholic fatty liver disease usually causes no signs and symptoms. When it does, they may include fatigue, pain in the upper right abdomen and weight loss.

Many patients remain undiagnosed, and recognizing those at risk is the first step. Liver biopsy is the gold standard method for diagnosis and staging, but the majority of patients can be effectively diagnosed non-invasively with tests that are routinely available in the clinic nowadays.

No standard treatment exists. Lifestyle interventions aimed at weight loss and increased activity are essential for all patients and if sustained are effective in its treatment. For patients who fail lifestyle intervention, liver-directed pharmacotherapy with pioglitazone or vitamin E can be considered.

Features of the metabolic syndrome and cardiovascular risk factors are very common, so all patients should be screened for these and have them managed aggressively. For patients who develop advanced disease, they require surveillance for and management of the complications of cirrhosis (hepatocellular carcinoma, varices, and osteoporosis).

P-0635

Is obesity more than just excess of fat? An analysis using impedanceometry on overweight patients and type I obesity (OI)

Clara Casas, Inmaculada Gil, Yuri Ochiai, Isabel Boba, Mariam De La Poza, Guadalupe Fernandez, Roxana Zevallos
Dr Carles Ribas Health Center. Barcelona city. Institut Català de la Salut.

Obesity is a major health issue worldwide, both for its economic impact as well as the various pathologies it implies. In our facilities we are using basic weight and height scales to calculate the body mass index (BMI) to classify overweight patients. The aim of this study is to test the use of impedanceometry in primary care to add further valuable information on the patient's body composition in order to better adjust its treatment.

Goals:

1. Assess the proportion of visceral fat (VF) in patients with OW and OI.
2. Describe the presence of decreased levels of lean mass (LM) in these patients, which might condition the appearance of sarcopenia.

METHOD: Descriptive observational study. Sample: Randomly selected the first 100 OW or OI patients who attended the primary care consults during two weeks time.

Variables: BMI, % fat mass (FM), % fat-free mass (LM) and VF measured with OMRON BF 511.

Analysis executed with SPSS 20 statistic, chi-square test.

RESULTS:

Sample description:

56% women, average age 63 years (25-89). OW: 49%; OI 51%

54% hipertension, 22% diabetes mellitus, 42,4% dislipaemia.

Global impedanceometry:

Low Normal High Very high

FM 0 4% 17% 79%

VF 0 20% 45% 35%

LM 77 22 1 0

LM and VF analyzed by sex:

Low Normal High

LM men 90,9% 9,1% 0%

LM women 66,1% 32,1% 1,8%

P<0,03

Normal High Very high

VF men 6,8 29,5 63,6

VF women 30,4 57,1 12,1

P <0,000

CONCLUSIONS:

1. We observed a high prevalence of high or very high visceral fat in overweight and type I obesity patients, more predominantly in men.
2. In these patients, a low percentage of lean mass is noted.
3. When prescribing a diet, to assess its progress we should be able to monitor the loss of visceral fat, aiming to lower the risk of cardiovascular events.
4. It is crucial to prescribe physical activity along with diet in these patients, to improve lean mass and thus lower the effects sarcopenia might have on their global health.

Keywords: obesity, sarcopenia, lean mass, impedanceometry

Impedanceometer



OMROM BF 511

Global impedanceometry results

	Low	Normal	High	Very High
Fat Mass	4%	17%	79%	
Lean Mass	77%	22%	1%	
Visceral Fat	20%	45%	35%	

Lean Mass analyzed by sex

LM	Low	Normal	High
Men	90.9%	66.1%	0%
Women	66.1%	32.1%	1.8%

p<0,03

Visceral fat analyzed by sex

VF	Normal	High	Very high
Men	6.8	29.5	63.6
Women	30.4	57.1	12.1

p<0,00

Evidence of prostate cancer in general practitioner clinic – evaluation of screening

Jana Luptakova¹, Lucia Kukuckova²

¹General practitioner clinic, Lucenec, Slovakia

²General Practitioner clinic, Dunajska Streda, Slovakia

Background & AIM: Prostate cancer is the most common cancer of the urogenital system. The incidence of prostate cancer is continuously increasing in Slovakia as well as worldwide.

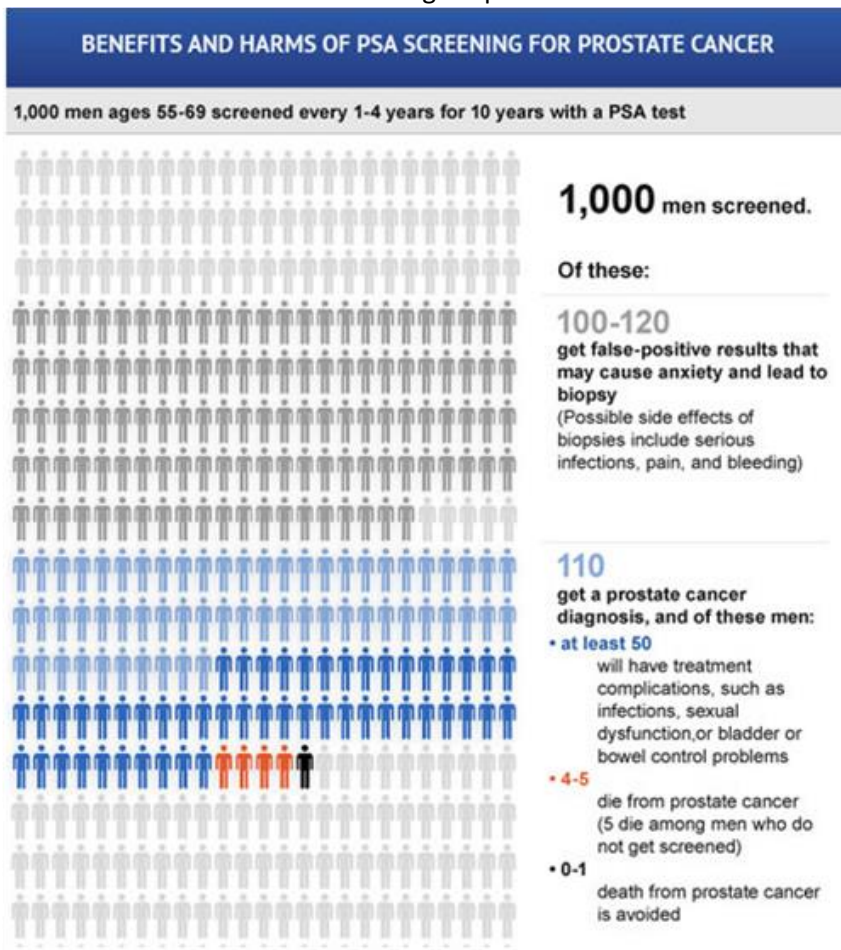
METHOD: The screening of male over the age of 50 years contributes to increasing incidence of prostate cancer. This article analyses the outcomes of preventive examinations of males over the age of 50 years over the period of 3 years in our general practitioner clinics.

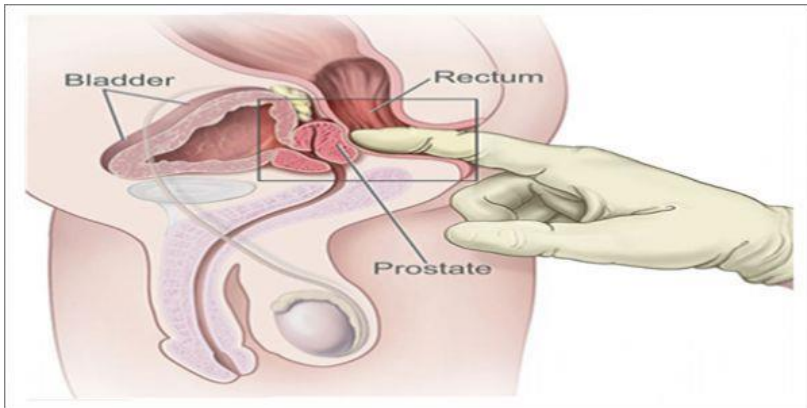
RESULTS: Prostate cancer is the third most common malignant tumor in males, following lung cancer and colorectal carcinoma, as it was seen in our results too.

CONCLUSIONS: Our conclusion was to emphasise the importance of periodic preventive examination at general practitioners with recommendation of necessity of preventive urological screening over the age of 50 years, and in the case of positive family case history of prostate cancer over the age of 40 years.

Keywords: prostate cancer, PSA – prostate specific antigen, prevention, screening

benefits and harms of PSA screening for prostate cancer





How can you test for Prostate cancer at GP?

How can you test for Prostate cancer at GP?

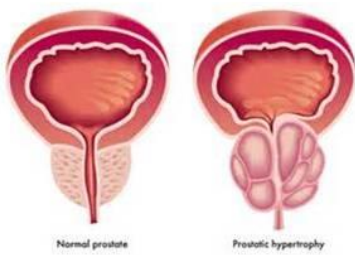
DRE - Digital Rectal Examination

The total PSA test and free PSA

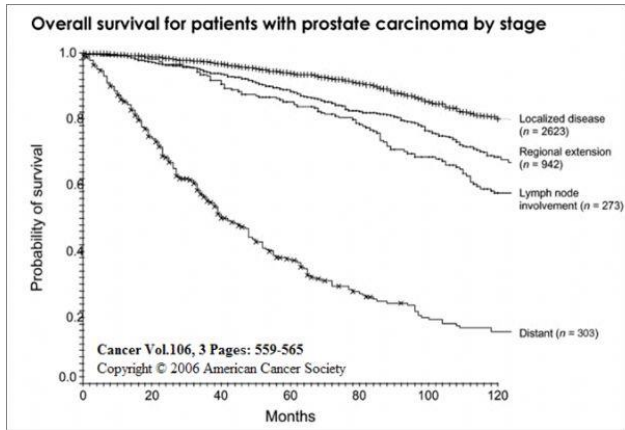
The PHI

TRUS – transrectal ultrasound Transrectal Needle Biopsy

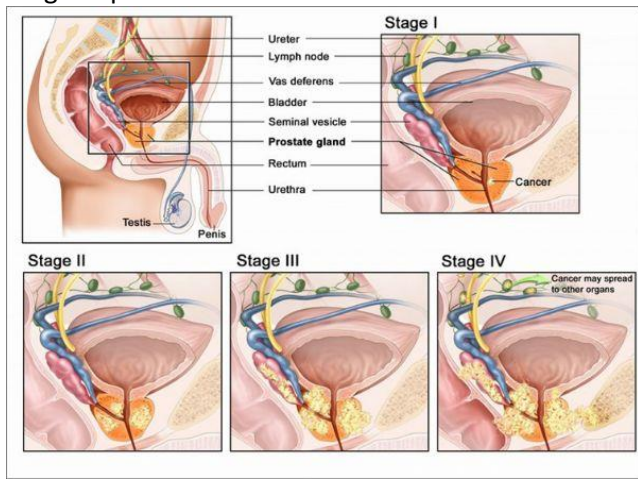
normal prostate



Overall survival for patients with prostate carcinoma by stage



Stage of prostate cancer



Results of preventive examination

	Total	Female	Male	Male over 50	PSA	PSA normal	PSA higher	Prostate cancer grade 1-2	Prostate cancer grade 4
Clinic 1	1071	699	372	210	76	70	6	4	0
Clinic 2	1256	647	582	237	-	-	-	1	2

Consultation in Family Medicine – the importance of systematization

Sara Martins, Catarina Fernandes, Helena Beça
Espinho Family Health Unit, Espinho, Portugal

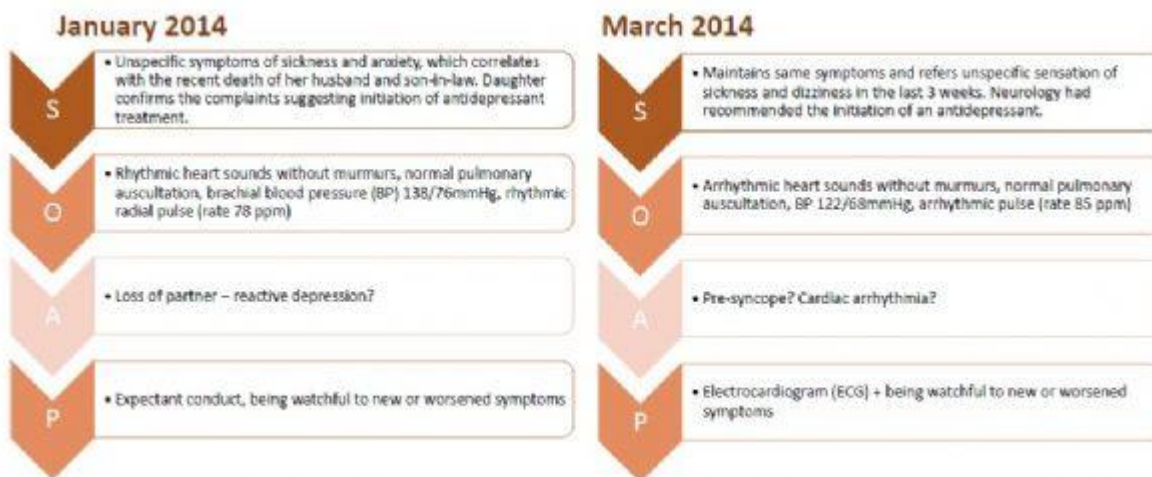
Context: For Family Medicine (FM) it is well recognized the importance of a person-centered care, where problems are approached in a holistic model, which makes FM unique. This discipline enhances a singular consultation process that improves the patient-doctor relationship, which will keep evolving. Compared to secondary care the decision process differs, since a reasoning based on probabilities is necessary. In spite of the well-known advantages, there is a possibility that they can lead to a predisposition of medical errors if pre-defined and systematized strategies are omitted from the clinical practice.

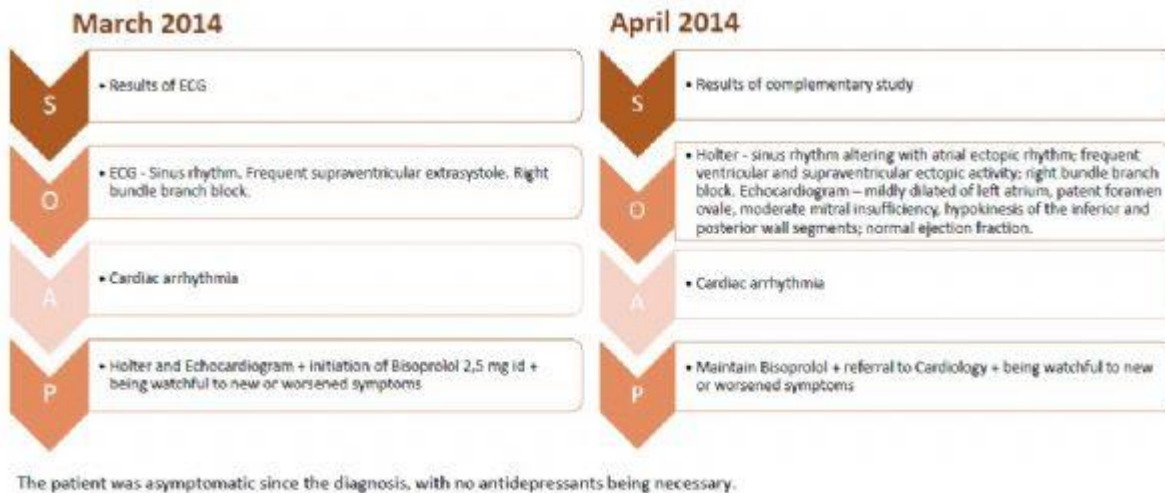
Case description: CF, 83 years, female, widowed, retired, with a personal history of ischemic stroke in 2011 (without sequelae). In January 2014 she visits her family physician (FP) expressing unspecific symptoms of sickness and anxiety, which correlates with the recent death of her husband and son-in-law. Her daughter confirmed the complaints suggesting initiation of antidepressant treatment. After complete physical examination, with no significant alterations, it is negotiated with the patient to maintain an expectant conduct, being watchful to new or worsened symptoms. In March 2014, the patient returns describing signs compatible with a pre-syncope. Meanwhile, during an appointment with her neurologist, an antidepressant is suggested. The patient decided to wait for her FP’s opinion who, at newer complete examination, detected an arrhythmic pulse and heart sounds. The complementary study revealed a cardiac arrhythmia. Clinical improvement was verified with no antidepressants being necessary.

DISCUSSION: The profound knowledge of the bio-psycho-social patient context is one of the most fundamental tools for decision making in primary health care. Paradoxically, it can also confuse it, in the absence of a solid systematized model for anamnesis and objective examination, applied to all consultation with no exceptions. But is this systematization need sustainable? What strategies should be adopted to avoid missing the fundamental steps?

Keywords: systematization; consultation; decision making; holistic model

Case Description





P-0638

Dealing with uncertainty in Family Medicine – Medically Unexplained Symptoms

Joana Pinto Carneiro¹, Sofia Correia Pinto², Inês Bento¹, Albina Oliveira³, João Julio Cerqueira⁴

¹usf garcia de Orta, porto, portugal

²usf s.João do Porto, porto, portugal

³usf oceanos, matosinhos, portugal

⁴usf horizonte, matosinhos, portugal

Background and AIM: In Primary Health Care, 15 to 50% of the symptoms are not explained by a specific underlying known condition. Recent studies admit the existence of a distinct health issue – Medically Unexplained Symptoms (MUS). MUS has earned increasing interest due to the significant morbidity, frequent absenteeism from work and economic burden associated to it. It is also associated to higher risk of iatrogenesis due to increased “doctor shopping”, investigation and hospitalization. Doctors and patients often experience frustration and helplessness in consultations around MUS.

We intend to raise awareness regarding this entity, it’s epidemiology, characteristics and adequate management to ultimately improve health outcomes.

METHOD: Bibliographic research using the MeSH terms “medically unexplained symptoms”, “management” and “primary health care”, including articles in english and portuguese.

RESULTS: The management of patients with MUS can be divided into 5 steps – prevention and self-management, identification of MUS, physical and psychological assessment, intervention (according to MUS intensity - low, moderate or high) and reassessment.

CONCLUSION: When managing MUS it is essential to assess the patient in a holistic manner approaching both physical and psychological needs whilst motivating the patient in taking part of the decisions. Family doctors have an important role in optimizing the management of MUS, improving patient-doctor relationship, improving life quality and consequently diminishing health costs.

Keywords: medically unexplained symptoms, primary health care, management.

2. MUS impact in healthcare



3. Doctor-patient meeting

		Objective findings	
		yes	no
subjective complaints	yes	illness	MUS Undiagnosed disease
	no	hidden disease denial stoicism	No illness

Adapted from : Nunes J. Sintomas Somatoformes em Medicina Geral e Familiar. Tese de Doutoramento. Julho 2012.

4. The profile of MUS patient

- Female sex
- Middle-age
- Frequent Attendance
- Treated with several drugs (anxiolytics, antidepressants, laxatives, analgesics, antihistamines)
- "Doctor shopping"

5. MUS symptoms and diagnosis

- Headache
- Shortness of breath, palpitations
- Fatigue, weakness, dizziness
- Back pain, myalgia, arthralgia, upper and inferior limb pain, thoracalgia, numbness
- Stomach problems, loose bowels, gas/bloating, constipation, abdominal pain
- Sleep disturbance, difficulty concentrating, restlessness, slow thoughts
- Loss of appetite, nausea, lump in throat
- Weight change

Chronic Pain
Fibromyalgia
Somatic Anxiety / Depression
Irritable Bowel Syndrome
Post-viral Fatigue Syndrome
Chronic Fatigue Syndrome
Myalgic Encephalomyelitis

6. Evaluation (3Ps)

Precipitating factors
Predisposing factors
Perpetuating factors
**The importance of
clinical interview**

7. Intervention

IT DOES HELP TO...	It DOESN'T help to...
<ul style="list-style-type: none">■ Clarify symptoms and revisit medical record■ Build therapeutic alliance■ Allow time and encourage the patient to make those connections■ Match your explanation using their own words■ Share your uncertainty; discuss the possible test result and its implications■ Maximize the use of non-pharmacologic intervention■ Empower patient to take an active role in his/her treatment■ Have a discussion about therapeutic trials and side effects	<ul style="list-style-type: none">❌ Dismiss the symptoms as normal (normalisation)❌ Focus exclusively on a diagnosis❌ Give the impression that you think something is wrong by investigating❌ Treat symptoms with drugs whatever❌ Ignore or miss psychological cues❌ Judge the patient❌ Let your anxiety or uncertainty take over

8. How to encode MUS by ICPC-2?

MILD /MODERATE MUS **A29**
PERSISTENT MUS **P75**
≥ 6 months

A classification of Medically Unexplained Symptoms in general practice (Fink et al)

P-0639

Obesity and overweight - primary care intervention

Inês Espiga Macedo¹, André Lourenço¹, Ana Rocha¹, Pedro Castro¹, Sofia Baptista²

¹USF Modivas, ACeS Póvoa Varzim/Vila do Conde, Vila do Conde Portugal

²USF Serpa Pinto, ACeS Porto Ocidental, Porto, Portugal

INTRODUCTION: Obesity and overweight are nowadays considered an epidemic and a public health problem. Unhealthy diet and physical inactivity are amongst the major risk factors for these health problems. Primary care physicians have a privileged place for intervening in this problem.

PURPOSE: The purpose of this study was to evaluate the results of an intervention in overweight and obesity in a primary care consultation.

METHODS: Retrospective analytical study based on data from the electronic file of patients with codification of obesity and overweight in the years of 2013 and 2014. The exclusion criteria were patients with less than 2 consultations from the date of the initial intervention (diet and physical activity recommendations and motivational interview).

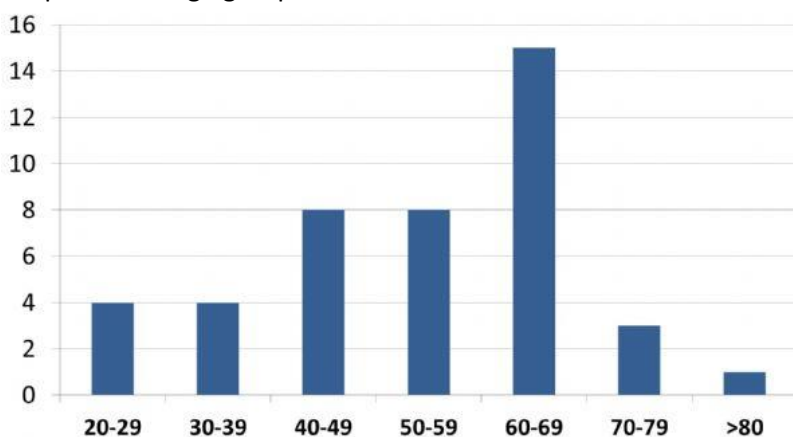
RESULTS: A total 43 patients were analyzed, with a mean age of 54 years (min: 26; max:80), 67% were women. BMI at the last evaluation had a mean value of 34,5. From the total, 53% achieved a mean loss weight of 3.3kgs.

DISCUSSION: Obesity has major social and psychological consequences therefore primary care health services can and need to have a concerted sustained multidisciplinary sustained action towards the main purpose of the global strategy of WHO. The results demonstrate the importance of a brief but sustained intervention based on simple strategies of motivation for a healthier lifestyle.

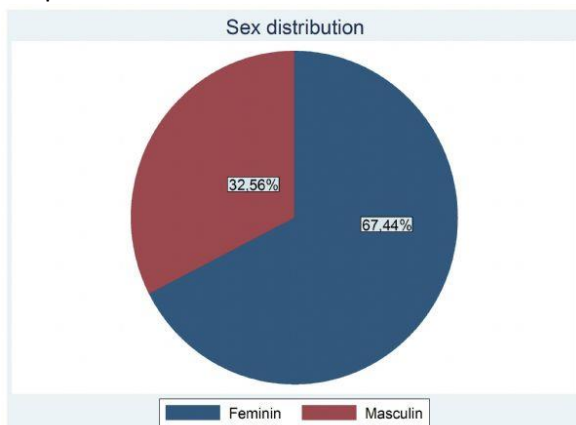
Note: These are still the preliminary results of the study that will attend to consultations made until June 2015.

Keywords: obesity, overweight, primary care, intervention.

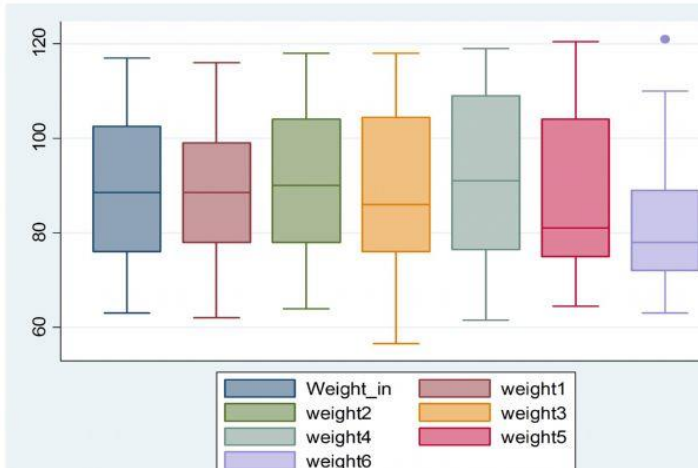
Graphic 1 – Age group distribution



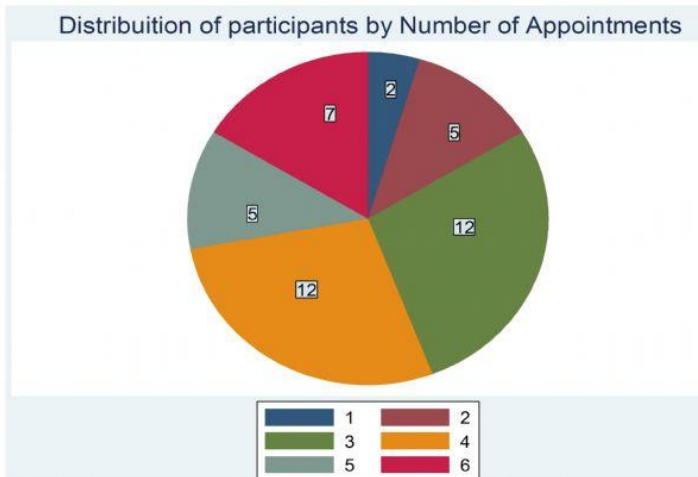
Graphic 2 – Sex distribution



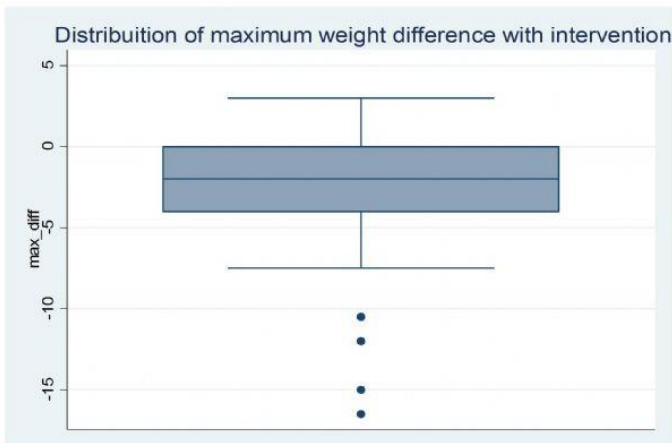
Graphic 3 – Weight evolution along appointments



Graphic 4 – Distribution of participants by number of appointments



Graphic 5 – Distribution of maximum weight difference with intervention



P-0640

Vitamin D supplementation: actual evidence recommendations

Silvia Martins¹, Pedro Cardoso Ferreira²

¹Unidade de Saúde Familiar Lagoa, Unidade Local de Saúde de Matosinhos

²Unidade de Saúde Familiar Dunas, Unidade Local de Saúde de Matosinhos

Background & Aim

Vitamin D (VitD) deficiency is a highly prevalent condition and is a worldwide public health problem, affecting all age groups. Some studies have shown an association with increased fracture risk, functional limitations, cancer, hypertension, diabetes, cardiovascular disease, dementia, depression and death. There is evidence that timely diagnosis allows early therapy in risk groups.

The aim of this review is to summarize the most common indications of VitD supplementation based on actual evidence.

Methods

PubMed based review was made of English and Portuguese publications: reviews, guidelines and clinical orientation norms between 2005 and 2015 were included.

MeSH terms: vitamin D deficiency; treatment;

Results

Endocrine society recommends measuring serum VitD levels as also its supplementation only in risk patients: malabsorption syndromes; reduced VitD intake; medication that interferes with VitD metabolism; darker skin pigmentation; low exposure or contraindication to sunlight radiation; laid up or nursing homes patients; obese; patients with personal history of falls or fractures; pregnant; infants; postmenopausal women; rickets; osteomalacia; osteoporosis; chronic kidney disease; hyperparathyroidism; granulomatous diseases and lymphomas.

Actually, there is no consensus about VitD serum levels to diagnosis of VitD deficiency.

Supplementation is recommended with D2 or D3 vitamin. A loading dose is recommended followed by a maintaining dose and which depend on severity of VitD deficiency and complications prevention.

Discussion

Actual evidence is not consensual respect either risks or benefits of VitD levels screening and VitD supplementation to prevent VitD deficiency in general population.

Its cost-effectiveness is demonstrated only in risk groups.

Having a patient-centered care, it is important to family physician to be warned to risk patients and initiate proper investigation before beginning VitD supplementation. It should be aware about referrals to secondary care of chronic disease patients with difficult management.

Keywords: MeSH terms: vitamin D deficiency; treatment;

P-0641

Suicide Prevention: The Role of Primary Health Care Services

Monica Mota¹, Sara Vieira¹, Joana Silva², Rui Correia¹, Ricardo Santos¹, Inês Melo Sousa¹, José Carvalho¹, António Filipe¹

¹Family Health Unit Alpendorada, Agrupamento de Centros de Saúde Tâmega I, Marco de Canaveses, Portugal

²Department of Psychiatry and Mental Health, Centro Hospitalar Tondela Viseu, Viseu, Portugal

Background & AIM: Suicide is the tenth leading cause of death worldwide and a complex and important public health issue. In Portugal, suicide rate is higher than the average European rate. About 80% of patients who commit suicide have resorted to primary health care service (PHCS) in the year preceding it, and half did so in the month of their death, which are numbers above those recorded for mental health services (MHS). PHCS providers often have the opportunity to intervene in suicide prevention. This work intends to make a review of the existing literature on suicide prevention within the PHCS.

METHOD: A review of the literature was performed by the terms "suicide", "prevention" and "primary health care", using online databases, textbooks and scientific journals.

RESULTS: Literature shows that suicide risk can be minimized by detection of individuals at higher risk and by starting appropriate treatment. For the assessment it must be considered the age, sex, race, marital status, religious involvement, presence of mental illness, social support, domestic violence, certain medical conditions, access to lethal methods, existence of previous attempts and analysis of verbal and non-verbal language. It is essential to inquire the patient about the existence of suicidal ideation or plans. The identification of individuals at high/imminent risk and the existence of family and social support networks are essential to decide for an outpatient based treatment or referral for evaluation in MHS.

CONCLUSIONS: A visit with to the primary care provider may be the only chance for the suicidal patient to engage with the health care system and access treatment. The particularities of the PHCS and the fact that its professionals monitor patients not followed in MHS, give them an important role in the identification and orientation of individuals at risk for suicide, and thus to act on its prevention.

Keywords: Suicide, Prevention, Primary Health Care

Warning Signs... Which Patients Should be Evaluated for Suicide Risk? Factors to Consider in Suicide Risk Assessment

Warning signs... Which Patients Should be Evaluated for Suicide Risk?	
"IS PATH WARM?" Ideation; Substance abuse; Purposelessness; Anxiety; Trapped; Hopelessness; Withdrawal; Anger; Recklessness; Mood change	
Factors to Consider in Suicide Risk Assessment	
Risk factors	<ul style="list-style-type: none">- Previous suicide attempt, family history of suicide- Mental disorders (depression, schizophrenia, anxiety and personality disorders, alcohol and other substance abuse)- Impulsive and/or aggressive tendencies- Anhedonia, severe anxiety/panic, insomnia, command hallucinations, intoxication, self-hate- Major physical illnesses (especially chronic conditions like chronic pain)- History of trauma or abuse- Lack of social support and increasing isolation- Easy access to lethal means- Barriers to accessing health care
Precipitants or triggering events	<ul style="list-style-type: none">- Important loss (of a relative/ friend/ relationship/ health or financial status)- Family conflict- Life events leading to humiliation or shame- Exposure to suicide of other people from the same community or famous people
Protective factors	<ul style="list-style-type: none">- Life satisfaction- Easy access to health care and development of strong therapeutic relationships- Social and family support; belongingness; sense of responsibility to others- Coping and problem-solving skills- Religious faith

Mnemonic IS PATH WARM? based on the recommendations of the American Association of Suicidology and the

American Psychiatric Association.

Modified SAD PERSONS Scale

Modified SAD PERSONS Scale		
S	Male Sex	1
A	Age < 19 or > 45 years	1
D	Depression/ hopelessness	2
P	Previous attempts/psychiatric monitoring	2
E	Ethanol or other substance abuse	1
R	Rational thinking loss	2
S	No Spouse (if divorced, widowed, separated, or single)	1
O	Organized plan	2
N	No social support	1
S	Stated future intent	1

Modified SAD PERSONS Scale, according to Oxford Handbook of Emergency Medicine (2006). The score is calculated from ten yes/no questions, with points given for each affirmative answer as shown in the figure. If the patient scores 0-5 points it may be safe to discharge (depending upon circumstances); if scores 6-8 points probably the patient requires psychiatric evaluation; if scores >8 probably the patient requires immediate Hospital admission.

Orientation of the Patient with Suspected Suicide Risk in Primary Health Care Services

Orientation of the Patient with Suspected Suicide Risk in Primary Health Care Services		
Suicide Risk	Risk Factors, Warning Signs and Protective Factors	Action Based on Level of Risk
High acute risk	<ul style="list-style-type: none"> - Persistent ideation - Strong intention to act/existence of plan - Not able to control impulse - Recent suicide attempt/ preparatory behavior - Acute state of mental disorder - Precipitating events - Inadequate protective factors 	<ul style="list-style-type: none"> - Maintain direct observational control of the patient - Limit access to lethal means - Immediate transfer with escort to Emergency Care Setting for Mental Health Service (MHS) support
Intermediate acute risk	<ul style="list-style-type: none"> - Current suicidal ideation - No intention to act - Able to control the impulse - Without recent attempt/ preparatory behavior - Presence of risk factors or warning signs in a patient with limited protective factors 	<ul style="list-style-type: none"> - Refer to MHS for evaluation (contact the MHS provider to determine the acuity of referral) - Limit the access to lethal means
Low acute risk	<ul style="list-style-type: none"> - Recent suicidal ideation or thoughts - No intention to act/no plan - Able to control the impulse - Without previous attempts - Existence of protective factors - Limited risk factors 	<ul style="list-style-type: none"> - Treat presenting problems (depression, anxiety, ...) - Address safety issues - Promote strengthen of social and family support networks - Document the therapeutic strategy - Consider consultation with MHS provider if the patient has an unsatisfactory response to treatment
<p>If no increased acute risk, continue routine care/ treatment of the underlying condition and periodically reassess the risk.</p>		

Orientation of the Patient With Suspected Suicide Risk in Primary Health Care Services. According to the recommendations of VA/DoD Clinical Practice Guideline for Assessment and Management of Patients at Risk for Suicide (2013), Evaluation and Treatment of Patients with Suicidal Ideation (published in American Family Physician, 1999) and Suicide Prevention Toolkit for Rural Primary Care (Suicide Prevention Resource Center, 2013). MHS - Mental Health Services.

Suicide



P-0642

Overweight asymptomatic patients in GP practice-biochemical approach to understand illness

Ilze Skuja¹, Gita Krievina¹, Inga Stukena², Aivars Lejnicks²

¹Riga Stradins University

²Riga Eastern Clinical University Hospital

Background and Aim. Adiposity is a world-wide problem which leads to Diabetes Melitus Type2 (DM), nonalcoholic fatty liver disease (NAFLD) and coronal heart disease (CHD). Unfortunately patients with enhanced BMI think that they are healthy. They often do not have any symptoms or limitations of life quality and don't notice how illness is approaching stealthily. The aim of this work is to find patients with DM, NAFLD, CHD in early asymptomatic stages.

Methods. In 159 patients (30-45 years, asymptomatic) glucose (Glu), HOMA-IR, Total cholesterol (TC), HDLC, non-HDLC, LDLC, triglycerides (TG), GGT, AST and ALT were estimated. VCAM, tPAI-1, chemerin and E-selectin levels were measured by Luminex xMAP technology. Patients were divided into three groups according to BMI- normal weight, overweight and obese. All biochemical parameters and cytokines were compared between groups.

Results. Significant ($p < 0.05$) positive correlations between BMI and ALT ($r = 0.28$), AST ($r = 0.42$), GGT ($r = 0.43$), TG ($r = 0.49$), Glu ($r = 0.36$), HOMA-IR ($r = 0.67$), tPAI-1 ($r = 0.33$), VCAM ($r = 0.54$) and negative correlation between HDLC ($r = -0.36$) and chemerin ($r = -0.33$) were found in the whole group. There were significant ($p < 0.05$) differences in levels of glucose (Glu), HOMA-IR, HDLC, non-HDLC, TG, GGT, AST, ALT, VCAM, tPAI-1, chemerin and E-selectin between normal weight, overweight and obese patient groups.

Conclusions. Differences in cytokine levels between groups showed the inflammation process and higher risk of CHD, NAFLD and DM of overweight and obese persons. It is too expensive to make such cytokine analyses in GP practice, but even every day used biochemical analyse such as HDLC, Glu, HOMA-IR, TG, ALT, AST and GGT had statistically significant differences. It is wise to measure level of Glu, ALT, AST, GGT, HDLC and TG in overweight and obese patients in GP practice to diagnose illnesses in earlier stages and to start quicker treatment and prophylaxis.

Keywords: overweight, triglycerides, cholesterol, glucose, cytokines

Parameter levels in patient groups

	ALT (U/L)	AST (U/L)	GGT (U/L)	GLU (mmol/L)	HOMA- IR (mmol/L)	HDLC (mmol/L)	TG (mmol/L)	VCAM (ng/mL)	E- selectin (ng/mL)	t-PAI-1 (ng/mL)	Chemerin (ng/mL)
Normal weight	24 [21;26]	20 [17;26]	14 [10;18]	4.8 [4.5;5.1]	0.99 [0.43;1.47]	1.64 [1.46;1.92]	0.81 [0.61;1.06]	1003 [884;1089]	57.3 [42.9;75.8]	120 [88;140]	45.8 [38.2;57.2]
Overweight	26 [22;29]	22 [17;37]	19 [12;36]	5.2 [4.8;5.4]	1.84 [0.96;2.85]	1.43 [1.23;1.71]	1.14 [0.85;1.68]	1085 [1001;1239]	53.5 [36.2;75.5]	127 [101;146]	42.5 [34.2;51.8]
Obese	28 [23;32]	32 [24;38]	25 [17;45]	5.3 [4.9;5.7]	3.15 [2.22;4.08]	1.30 [1.15;1.69]	1.45 [1.04;2.12]	1283 [1178;1414]	42.7 [32.8;64.5]	155 [120;206]	40,1 [30.9;46.6]

P-0643

Iron deficiency anemia in young adult man after wet-cupping therapy (Al-hijamah)

Didem Sunay, Nevgül Demir, Feyza Yücel, Rukiyye Türker

Department of Family Medicine, Keçiören Training and Research Hospital, Ankara, Turkey

Background and AIM: Wet cupping therapy (WCT) that was used in Europe at middle ages, at the present time has been used as an alternative treatment method throughout the world. In Asia, Muslim people, because of religious beliefs, are very interested in Al-hijamah, which is one of the WCT methods used in prophetic medicine and is recommended by prophet Muhammad. Al-hijamah was reported to decrease serum ferritin in healthy subjects. In this case report we submitted a young adult man with iron deficiency anemia which was developed probably after Al-hijamah.

METHODS: A 40-year old man attended to the out-patient clinic of family medicine department with dizziness and weakness. No pathological finding was determined in his physical examination. Laboratory findings were; hemoglobin 11.1g/dl, hematocrit 36.3%, MCV 69.7f L, RDW %30.5, iron 25ug/dl, ferritine 6.3 ng/ml.

RESULTS: The patient was diagnosed with iron deficiency anemia. Research for gastrointestinal bleeding was planned, but he refused advanced research and noted that he occasionally gave blood for polycythemia by himself, that once he had told to have this disease. Although he has not give blood for several years, last year he received Al-hijamah for hot flushes and heat intolerance, and lost 500 ml blood in this intervention. This blood lost was thought to be the reason of his anemia but fecal occult blood assessment was done. 100 mg per day iron supplementation was started to the patient after the negative results of 3 times repeated fecal occult blood assessment. One month later his laboratory results were; hemoglobin 12.5g/dl, hematocrit 39.7%, MCV 74.2f L, RDW %21.7, iron 45ug/dl, ferritine 14.3ng/ml.

CONCLUSION: It can be said that our patient had had anemia before procedure that became deeper after it. As primary care physicians we should question our patients with anemia for such procedures.

Keywords: anemia, man, wet cupping

Al-hijamah



Al-hijamah cupping <http://www.al-shifaclinic.btck.co.uk/HijamaCupping>

P-0644

Organisation of Turkish Speaking Healthcare Professionals Associations Around Europe

Cemal Kavasogullari¹, Cemal Sakalli¹, Cankut Yuksel², Serdar Dalkilic², Kandemir Berova²

¹Turkish Cypriot Healthcare Professionals Association

²European Federation of Turkish Healthcare Professionals

Background and Aim

Literature shows patients who belong to minority groups are more likely to consult healthcare professionals of the same race or ethnic group. It is also well documented that minorities or ethnic communities are less likely to have access to healthcare services or are worse at utilizing available healthcare resources compared to the native population. Research from Germany, UK and various other European countries show that Turkish Speaking Population living in European countries do belong to this under-served population with particular problems in accessing healthcare. We hereby present European Federation of Turkish Healthcare Professionals (EFTHP), an umbrella organisation established around Europe. EFTHP and member organizations aim to provide Turkish speaking community in their respective countries with educational and informative activities locally in order to improve their health, well-being and access to healthcare.

Method

Number of Turkish speaking population in each country have been obtained from embassy and consulate resources where available. Member sizes of each organisation has been obtained from EFTHP archives and graphed according to population served. Countries and locations of each organisation has been shown on a map and contact details have been provided.

Results and CONCLUSIONS:

Turkish speaking communities in Europe has significantly worse access to healthcare resources. Number of Turkish speaking healthcare professionals across the European continent has constantly increased over the last 10 years but this raise is not proportional to the increase in Turkish speaking migrant population. Activities of member organisations have been well perceived by the communities but there is significant gap between demand and supply. There currently are 11 member organisations from 5 EU countries -Germany, France, Austria, United Kingdom, Switzerland- and 2 Non-EU countries -Turkish Republic of Northern Cyprus, Turkey-. There are 2004 registered members in total as of May 2015.

Keywords: Turkish healthcare professionals, Turkish speaking community in Europe, ethnic health, migrant health

ATSEF



Sign of EFTHP

P-0645

Patient-Centered Medical Home Curricular Development Utilizing Weight Management Group Visits to Teach Group Facilitation and Leadership Skills

Susan Saffel Shrier, Katherine Fortenberry, Rebecca Cannon, Sydney Abbott

Department of Family and Preventive Medicine, University of Utah School of Medicine, Salt Lake City, Utah, USA

BACKGROUND & AIMS:

Group visits are an ideal venue for teaching Patient-Centered Medical Home concepts and meeting ACGME Milestones competency requirements. The primary goal of this project was to develop a program to teach resident group facilitation and leadership skills, while improving patient access and team-based delivery. Secondary goals include enhancing residents skills in nutrition knowledge, weight management, and motivational interviewing.

METHODS:

Group Visits

Family medicine resident participates in three consecutive group sessions, along with either a faculty clinical psychologist or registered dietitian nutritionist. Residents first review online group facilitation and leadership material, and complete pre/post nutrition/obesity knowledge and obesity attitudes surveys. Each resident observes and participates in the first two sessions, and leads the third session. The faculty member provides debriefing and feedback using the group facilitation competency evaluation.

Material Development

Evidence based program topics were selected based upon an exhaustive literature review. Literature review for program development included: international and national obesity guidelines, weight management RCTs (diet, exercise, and behavior), recent systemic review articles. A similar process was conducted in the development of the group facilitation education materials, resident evaluation, and obesity attitude surveys. Periodic review and revision of materials is ongoing.

RESULTS:

An eight week workbook was created based on the identified evidence based topics, Figure 1. The program involves a holistic approach to weight management to include biological, psychological and social aspects, Figure 2. Each session emphasizes individual goal setting, Figure 3. In addition, a resident Group Facilitation Skills Checklist was developed to evaluate effective teaching, group dynamics, problem solving and motivational interviewing, Figure 4.

CONCLUSION: The Patient-Centered Medical Home concept includes care delivery via group visits. Group visit development and resident facilitation training are enhanced with a weight management and team approach format. The group visit is ideal for addressing the global obesity epidemic.

Keywords: Patient-centered medical home, group visits, obesity, weight management, resident training

Figure 1: Program Schedule

The SEE Program: Smart Enjoyable Eating

Class Schedule

Week 1: Weight Loss and You: Fitting Weight Loss Into Every Day Life

Week 2: Your Food Balance – The Principles of Weight Management

Week 3: Physical Activity: Let’s Move!

Week 4: Making MyPlate Your Plate: Meal Planning for Success

Week 5: Psychology of Eating: Why Do We Eat?

Week 6: Food Labels and Recipe Modification: How to Make Healthy Food Choices

Week 7: Shopping on a Budget: How to Eat Healthy While Spending Less

Week 8: Moving Forward with Weight Loss



Figure 1: Program Schedule

SEE program weekly schedule

Figure 2: Factors contributing to weight management

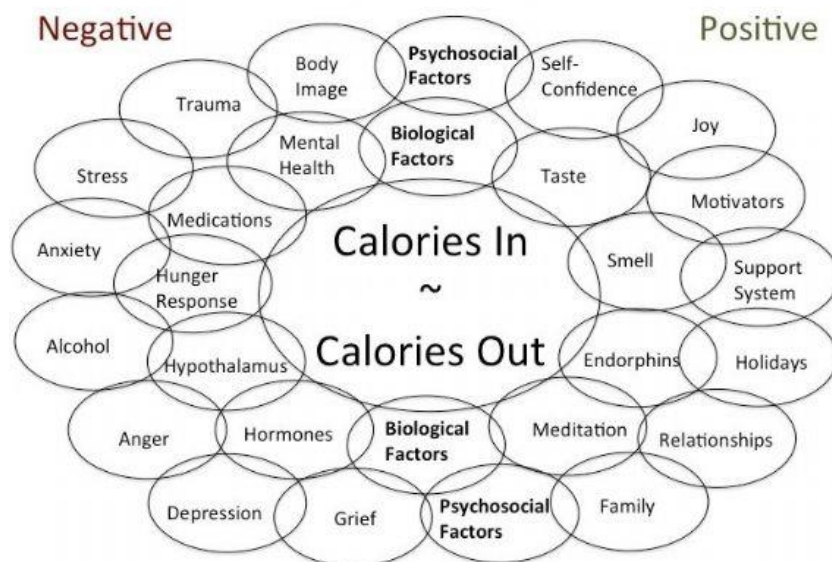


Figure 2: Factors Contributing to Weight Management
Possible factors contributing to management of weight

Figure 3: Communication Sandwich

Communication Sandwich: Weight Loss and You

I do well with:

But it looks like I have several other areas that need improving. Particularly:

How this goal will help me:

Where can we go from here?
My S.M.A.R.T. goal related to motivation, barriers, and lifestyle changes is:

Goals should be: Specific, Measureable, Attainable, Realistic, Timely

Figure 3: Participant Goal Setting Activity

See program participant goal setting activity

Figure 5: Sample Activity

Figure 5: Sample Activity from Week 4

	Fruit	Vegetables	Grains	Protein	Dairy	Other
	 <small>Choose MyPlate.gov</small>	 <small>Choose MyPlate.gov</small>	 <small>Choose MyPlate.gov</small>	 <small>Choose MyPlate.gov</small>	 <small>Choose MyPlate.gov</small>	<small>(include foods that contain calories but do not fit into a food group, such as soda, chips, candy, donuts, etc.)</small>
Breakfast			<small>Make half your grains whole.</small>	<small>Aim for lean protein sources.</small>	<small>Choose skim or low fat options.</small>	
Snack						
Lunch						
Snack						
Dinner						
Snack						
Totals:						
	<small>1½-2 cups</small>	<small>2-3 cups</small>	<small>6 ounces (or ounce equivalent)</small>	<small>5-6 ounces</small>	<small>3 (1 cup) servings</small>	<small>Eat sparingly.</small>
Water Intake (8 ounces):	<input type="checkbox"/> <input type="checkbox"/> <input type="checkbox"/> <input type="checkbox"/> <input type="checkbox"/> <input type="checkbox"/> <input type="checkbox"/> <input type="checkbox"/> <input type="checkbox"/> <input type="checkbox"/>					

Sample Activity from Week 4

Figure 4: Group Facilitation Checklist

Group Facilitation Skill Set Checklist

Resident: _____ Observer: _____ Session Topic: _____ Date: _____

Directions: Mark only observed behaviors in the left column. Then, mark one ratings box per row. Record important comments and behavioral observations in the notes section.

Group Leading Skill Set <i>Mark only what you observe in session</i>	<i>Needs Improvement</i>	<i>At expectation</i>	<i>Exceeds expectation</i>
EFFECTIVE TEACHING STYLE <input type="checkbox"/> Clearly describes goals and objectives <input type="checkbox"/> Encourages interactive vs didactic format <input type="checkbox"/> Politely corrects incorrect answers <input type="checkbox"/> Repeats correct answers <input type="checkbox"/> Repeats key points to reinforce retention <input type="checkbox"/> Praises progress <input type="checkbox"/> Appropriately calls on interprofessional team members	<input type="checkbox"/> Uses 0 - 3 elements	<input type="checkbox"/> Uses 4 - 5 elements	<input type="checkbox"/> Uses 6+ elements
Notes:			
GROUP DYNAMIC ELEMENTS <input type="checkbox"/> Encourages all patients to participate (including quiet patients) <input type="checkbox"/> Appropriately redirects dominant patients <input type="checkbox"/> Encourages group to answer each others' questions <input type="checkbox"/> Uses summarizing statements to transition topics/focus	<input type="checkbox"/> Uses 0 - 1 elements	<input type="checkbox"/> Uses 2 elements	<input type="checkbox"/> Uses 3+ elements
Notes:			
PROBLEM SOLVING SKILLS <input type="checkbox"/> Effectively walks patients through Problem Solving Activity <input type="checkbox"/> Helps patients set SMART goals	<input type="checkbox"/> Uses 0 elements	<input type="checkbox"/> Uses 1 element	<input type="checkbox"/> Uses 2 elements
Notes:			
MOTIVATIONAL INTERVIEWING SKILLS <input type="checkbox"/> Elicits patient goals <input type="checkbox"/> Comments on patient ambivalence <input type="checkbox"/> Elicits patients' reasons for change <input type="checkbox"/> Encourages change talk <input type="checkbox"/> Avoids confrontation and direct persuasion	<input type="checkbox"/> Uses 0 - 1 elements	<input type="checkbox"/> Uses 2 elements	<input type="checkbox"/> Uses 3+ elements
Notes:			

Figure 4: Group Facilitation Checklist

Family medicine resident facilitation evaluation

P-0646

Oral and Dental Health Conditions of Patients Attending to Ankara University Faculty of Medicine, Family Medicine Polyclinics with Family Medicine Perspective

Zeynep Bayraktutar Daldal¹, Zehra Dağlı², Mehmet Urgan²

¹mamak onur uğurlu family helath center, ankara, turkey

²department of family medicine, ankara üniversity,ankara,Turkey

Children or adults do not visit a dentist regularly, but do consult only when they have symptoms. Through primary care preventive medicine practices, disorders that could affect general health can be prevented by early detection and early intervention as a result of periodic health examinations. Thinking each family physician consultation as an opportunity for oral and dental health, we aimed to identify our patients' oral and dental health status during physical examination due to other reasons for encounter. Between April 1, 2014 – June 31, 2014 three hundred twenty-eight people were interviewed face to face. Oral and dental examinations were performed by the same family physician in family medicine clinical setting..While 53.7% of the respondents had at least one decayed tooth, 64% had at least one missing and 87.5% had at least one filled tooth, and 65.2% of the respondents had tartar. In the presence of cardiovascular and respiratory diseases, diabetes mellitus and rheumatic diseases, DMFT index was significantly higher. In comparison of DMFT index with medical treatment, usage of antihypertensive, antidiabetic, antihyperlipidemic and anticoagulant drugs increased the DMFT index, that increase was statistically significant. While first dental examination gets older, DMFT index also increased. Increased frequency of tooth brushing gradually decreased DMFT index. The ratio of daily use of the auxiliary cleaning products was 15.5%. In conclusion, individual oral hygiene habits are inadequate. Patients do not share their problems on oral health status, unless they are especially questioned. Family physicians have an important role in ensuring periodical health control habits, provision of oral hygiene and proper nutrition education, and informing individuals especially since early childhood. it may turn the attendances of the patients to primary care into an opportunity to protect oral and dental health of the patients who do not receive regular dental care.

Keywords: Oral and Dental Health, Family Physician, Preventive Medicine, Periodic Health Examination, DMFT index

P-0647

Vaccination Rates of The Students Studying in Primary and Secondary Schools in Yenişehir, Diyarbakir

Funda Gökğöz Durmaz¹, Fatma Gökşin Cihan², Ahmet Yılmaz³, Hamza Aslanhan³, Halil Yendim¹

¹Diyarbakır Yenişehir Toplum Sağlığı Merkezi

²Necmettin Erbakan Üniversitesi Meram Tıp Fakültesi Aile Hekimliği Ana Bilim Dalı

³Dicle Üniversitesi Tıp Fakültesi Aile Hekimliği Ana Bilim Dalı

AIM: In this study, we aimed to determine the immunization rates of the students studying in primary and secondary schools, in a vaccination operation conducted by Yenişehir Community Health Center and to reveal the difficulties encountered.

METHOD: This study was a cross-sectional descriptive study. Previously, a written consent form was sent to the school administrators and parents. Doctors and nurses went to schools in Yenişehir district between 27.11.2014-29.12.2015. Vaccines, procured by Diyarbakır Public Health Directorate, were implemented to kindergarten, first class and eighth class students. The number of applied vaccinations were recorded to the ministry information systems.

RESULTS: During the vaccination operation, 47 central and 20 rural schools, a total of 67 schools, were visited. According to the national vaccination schedule, Measles, Mumps and Rubella (MMR) vaccine were administered to kindergarten students. Diphtheria, tetanus, acellular pertussis, inactivated polio vaccine (quad combination vaccine) and MMR were administered to first class students; tetanus adultive diphtheria (Td) were administered to eighth class students. 1295/2609 (49.63%) of kindergarten students were vaccinated. 4042/5477 (73.79%) of first class students were vaccinated with MMR and 75.36% (n: 4128) were vaccinated with quad combination vaccine. 2930/5086 (57.60%) of eighth year students were vaccinated with Td.

CONCLUSIONS: The vaccination schedule differs by socio-economic conditions, migrations and the geographic location associated with epidemics of infectious diseases for every nation. To implement the booster doses in vaccination schedule without any missing is very important in terms of ensuring full immunity and disease eradication. In our study, vaccination rates in the district of Yenisehir was found well below the expected level. The preconception "MMR vaccine constitutes SSPE" in parents of kindergarten and first grade students, reduced vaccination rates. Training seminars should be organized to increase public awareness and to correct misinformations.

Keywords: school, vaccination rates, booster doses

P-0648

The Relation of Asthma and Allergic Diseases Diagnosed by Doctor with Fast Foods in Schoolchildren

Betül Battaloğlu Inanç

Muğla Sıtkı Koçman University, Faculty of Medicine, Family Medicine Department

OBJECTIVE: It would not be right to link the reasons for the worldwide increase in incidents of childhood obesity and those of allergic diseases only to genetics. Obesity, asthma and allergic diseases can be prevented through the consumption of healthy food. In this study, children's eating habits, obesity, asthma and other allergic diseases were intended to determine their relationship with each other.

METHODS: In a high socioeconomic level school in Mardin, asthma and allergic diseases of children aged between 7-15 were diagnosed by a doctor, and their eating habits between meals, food types they buy from the school canteen and their family data were determined by survey.

RESULTS: Obesity and overweight was higher with the boys than the girls. 21.7% of the girls, 13.4% of the boys had allergic diseases. Allergic diseases were remarkably frequent with girls ($p<0.0001$). 1.6% of the girls and 2.3% of the boys had asthma. Allergic diseases was higher with the overweight and obese groups. Children who had breakfast regularly had significantly less tendency to be overweight or obese ($p<0.00001$).

CONCLUSION: Genetic predisposition is the most important factor in emerging obesity and allergic diseases. However, it is not possible to explain the worldwide increase of obesity, allergic diseases and asthma only by genetics. The part played by complex dietary factors should be explained for obesity, asthma and other allergic diseases and understood through a multidisciplinary approach.

Keywords: Obesity, Asthma, Fast-Food

P-0649

Short stature and low weight in schoolchildren

Betül Battaloğlu Inanç

Muğla Sıtkı Koçman University, Faculty of Medicine, Family Medicine Department,

AIM: Evaluated the frequency of short stature and low weight between two primary school children aged 6-16 years of children in Mardin province in 2010 and 2011. **MATERIAL-METHOD:** Two elementary school children', heights and body weights were measured. Body mass index (BMI) was calculated with the formula; body weight (kg)/ body height (m²). Short stature and low weight were statistically analyzed. **RESULTS:** There were 834 (51%) boys and 804 (49%) girls. The mean body height, weight, BMI and age was 143.21 ± 13.58 , 38.38 ± 13.06 , 17.86 ± 3.56 and 11.07 ± 2.00 , respectively. Boys mean body height, weight were 142.58 ± 13.92 , 37.87 ± 12.83 , respectively. Girls mean body height, weight were 143.86 ± 13.19 , 38.90 ± 13.29 , respectively. Height and weight difference was so significantly between gender ($p<0.05$), there was no difference between BMI ($p>0.05$). ≥ 85 p. presence of children was statistically significant among the children with short stature ($p<0.00$) There was no one of the children tall in short stature children' ($p<0.00$). There were no difference between growth speed ($p>0.05$). Between schools' in the children BMI ($p<0.00$), height ($p<0.05$) and weight ($p<0.00$) were statistically different

with each other. DISCUSSION: Evaluate of growth and development status for children anthropometry is widely known as a very useful instrument. In school health working children' and family education should be handled together and teachers cooperation should be provide. Growth references lower and upper percentiles. should given to the teachers low or high measurement values should be advise to send the physician control.

Keywords: Child; Short Stature; Low Weight; Anthropometric Measurement

P-0650

Pilot study: dance and anxiety in primary care

Marta Arbolí, Carla Carreras, Jesus Garbayo, Sara Davies, Ana Garcia, Ainhoa Toscano, Joan Campos, Clara Ortí, Maria José Pujol, Maria Dolors Carvallo, Angeles Santos, Pilar Molas
Primary Care Center Chafarinas, Barcelona. Catalan Health Institute. Spain.

BACKGROUND & AIM

The recurring nature and the prevalent condition of the anxiety disorder, specially in women, represents a significant burden to families and society having a high negative impact on the quality of life.

To asses the effect of a dance program in order to reduce the score of anxiety.
Knowing whether there are significant changes in the self perception of health status before and after the intervention.

METHOD

It is a pilot study of a randomised controlled trial (N=30). There are two groups: control and intervention. It has been approved by the Scientific Research Ethics Committee IDIAP Jordi Gol.

The intervention consists in dance sessions, once per week, during 3 months. The purpose is that the patients express themselves with creative movement, not to create a choreography in order to do a performance. The therapist is a young general practitioner with lot of experience in dance and expression.

Inclusion criteria: women from 55 to 65 years old with diagnosis of anxiety disorder, confirmed by a clinical interview and Goldberg's questionnaire.

Both groups were follow up at the beginning of the intervention, at the end of it and three months after it had finished.

Primary outcomes: level anxiety measured through the Goldberg questionnaire.

RESULTS

Including 30 women randomised into two groups initially homogeneous for all variables. Only differences for hypertension ($p=0,025$), dyslipidemia ($p=0,028$) and the intervention group feeling of more walking limitation than the control group ($p=0,032$). The 70% of the participants in the intervention group have done 90% of the sessions. Anxiety score decreases i the intervention group and increases in the control group ($p=0,053$) after the dance therapy intervention. No significant differences in the Euroqol scale.

CONCLUSIONS

Dance therapy could be a useful method to decrease the score of the anxiety disorder measured through Goldberg's questionnaire.

Keywords: [anxiety], [primary care], [dance]

Dance as a non verbal communication to express yourself



Dancetherapy



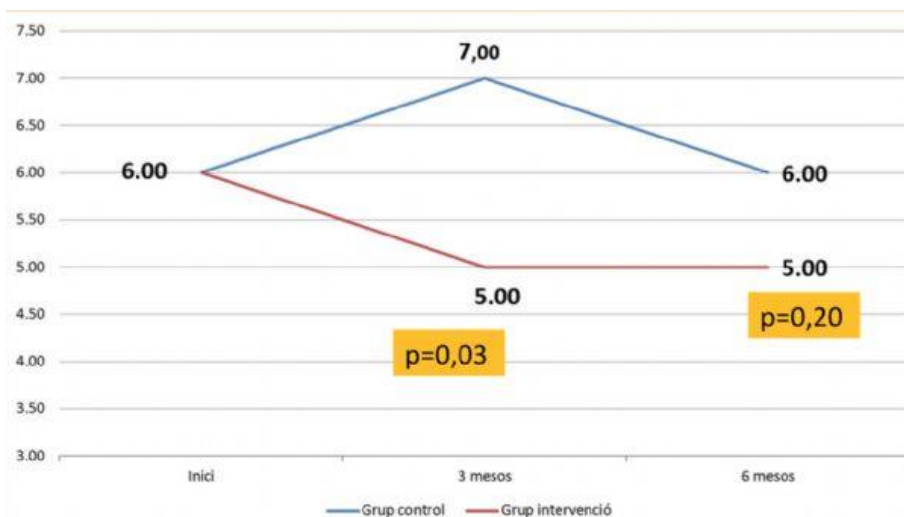
Intervention



Intervention

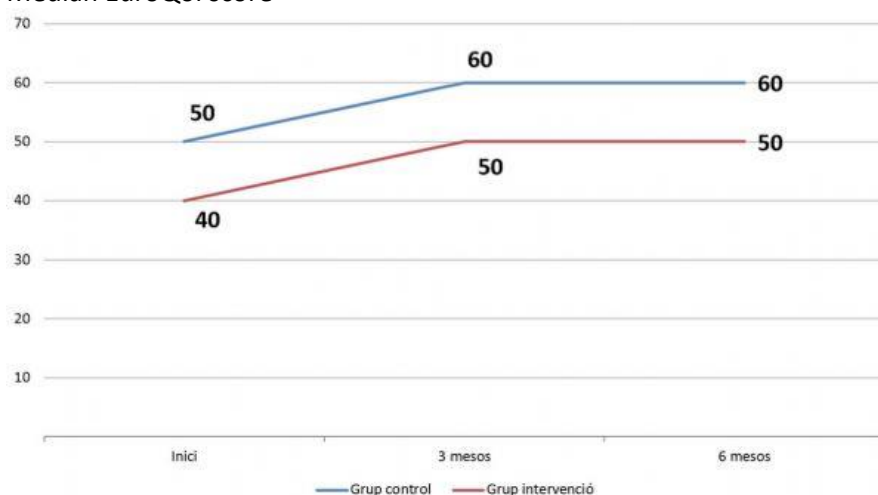


Median Goldberg Subscale Anxiety



Anxiety score decreases in the intervention group and increases in the control group ($p = 0.053$) after the dance therapy intervention. No significant differences 3 months after intervention has finished.

Median EuroQol score



No significant differences in the Euroqol score.

P-0651

Rational Drug Use Among Nurses Working at University Hospitals

Edibe Pirincci¹, Turgut Bozan²

¹Firat University School of Medicine. Department of Public Health, Elazig

²Training and Research Hospital Diyarbakir

BACKGROUND & AIM: This study aims to examine the attitudes of nurses at university hospitals toward rational drug use and their knowledge about the drugs administered both to themselves and to patients.

METHOD: This is a cross-sectional and descriptive study. The author did a questionnaire form with all the nurses (416 persons) at Elazig Firat University (response rate: 71%). The data collected were entered into the SPSS package program. The confidence interval of the results is 95%, and the threshold for statistical significance is $p < 0.05$.

RESULTS: Of these nurses, 69.2% consult a physician first when they get ill, 96.3% use the drugs prescribed by their doctors, and 76.9% use the drug for the period of time suggested by their doctors. Of them, 87.8% are informed about the effects of the drug they use, 69.2% are informed about the side effects of the drugs they use. The correlation between nurses' checking the expiration date of the drug they use and their age and educational

levels is not statistically significant ($p>0.05$), while their rate of checking this date increases in direct proportion with their length of professional service ($p<0.05$). To the question, "Which drug would you use without consulting a physician when you get ill?" the most frequent response is pain killers, the second is the drugs for colds and the third is antibiotics. The most frequent clinical drug administration error is failing to recollect to administer the drug (40.7%), and the second most frequent error is administering an incorrect dosage of the drug (39%). Of the nurses, 90.2% would like to be trained about rational drug use.

CONCLUSION: The nurses have a lack of knowledge about rational drug use and reported that they do make drug administration errors. These deficiencies should be ameliorated by providing on-the-job training to them.

Keywords: nurse, rational drug use, hospital

P-0652

Saudi Female School Teachers' Knowledge on and Opinion of Physical Exercise for Children

Ghada A. Al Arfaj, Abdulaziz Al Odhayani

College of Medicine in King Saud University

BACKGROUND:

Studies showed a correlation between physical activities in children and cardiovascular disease risk factors. In Saudi Arabia, there is significant lack in studies evaluating physical activity levels among children.

AIM:

To assess the teachers' level of knowledge regarding the female students physical activity

Methodology

A cross-sectional study.

Place: Al-Abna'a school.

A sample size was 314

Three focus group were conducted to develop and improve the research questionnaire.

Ethical and Legal Considerations were considered.

Results

the research results showed the followings:

- 86.2% of the teachers thought that all female students should have physical activity and physical education classes in school.
- 88% believed that female students are not doing enough physical exercise as they should due to many reasons which include
 - o school-related reasons including availability of fatty and unhealthy food in school (67.3%) and unavailability of PE classes (56.6%);
 - o student-related reasons such as students' preference to do other types of activities (64.8 %) and lack of student motivations (56.1%); and
 - o family-related and other reasons like parental inactivity (61.7%), cost of sport facilities (63%) and cultural disapproval of PE for girls (51%).
- 87.7% represented low levels of knowledge regarding physical exercise recommendation for children.

The CONCLUSION:

The majority believe that physical exercise is important. Teachers' levels of knowledge regarding the recommendation are low. Some barriers were identified such as lack of social and parental support, and lack of suitable facilities.

Keywords: School, teacher, children, physical activities, knowledge

Level of Knowledge

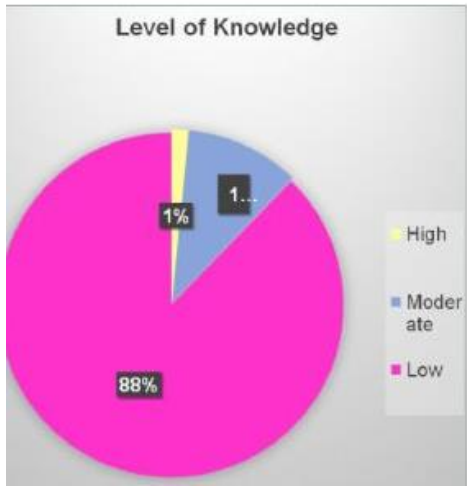


Table 1: Socio-Demographic Characteristics of the Participants

Socio-Demographic Characteristics		#	%
Age in years	20-30	59	30.1
	31-40	80	40.8
	41-50	50	25.5
	>50	7	3.6
Marital Status	Married	155	79.1
	Single	33	16.8
	Other	8	4.1
Years of Teaching Experience	<5	67	34.2
	5-10	36	18.4
	>10	93	47.4
Major	Science	32	16.3
	Literature and Languages	26	13.3
	Social Sciences	9	4.6
	Religion Studies	31	15.8
	Other	98	50.0

Table 2: Teachers' Beliefs Regarding Physical Exercise for Children

Teachers' Beliefs	Yes		No		Do not Know	
	#	%	#	%	#	%
Physical exercise is as important and beneficial for children as it is for adults.	190	96.6	1	.5	5	2.6
The negative effects of physical exercise in children outweigh the benefits.	17	18.7	179	91.3	0	0
All children should participate in regular physical exercises.	182	92.9	14	7.1	0	0
Female students are not doing enough physical activity as they should.	173	88.3	14	7.1	9	4.6

Table 3: Teachers' Opinion regarding Reasons behind Female Studentsâ€™

General Issues		
Cost		125 63.8
Distance and unavailability of transportation	93	47.4
Lack of facilities	76	38.8
Societal disapproval for female participation in sports	62	31.6
Weather	61	31.1
Medical or Physical Issues		
Obesity	98	50.0
Bronchial asthma	80	40.8
Anemia	61	31.1
Diabetes mellitus	47	24.0
Unhealthy diet		
Eating fatty and unhealthy food in school	132	67.3
Missing breakfast	103	52.6

Table 4: Teachersâ€™ knowledge on physical exercise recommendation

Recommendations for Children's Physical Activity	#	%
How frequently should any child above 2 years participate?		
Once a week	13	6.6
Twice a week	39	19.9
Three times a week	88	44.9
Every day	56	28.6
For how many minutes?		
At least 60 a day	21	10.7
30, five days a week	75	38.3
Fewer than 20 a day	90	45.9

P-0653

Falls and Home Accidents at Old Age: A Qualitative Research about the Home Ergonomy and Aging in Place

Suzan Yazici, Serkan Karkuş
Akdeniz University

Background & AIM: Falls are among the main indoor accidents leading to increased morbidity and mortality in old age. It is possible to decrease the rate of accidents and falls at homes. The aim of this study is to evaluate the ergonomy of houses regarding the risk of falls and home accidents, to identify the risky areas at home and to advise recommendations of home adaptation for those areas.

METHOD: Qualitative methodology has been used. 15 interviews have been done at 10 homes in Adiyaman, Gölbaşı district. The Ergonomic Evaluation form has been used to evaluate the ergonomy of the houses. Interviews were audiotaped and pictures were taken. The elderly have been informed about risky areas at their homes and advises were given.

RESULTS: In majority of the houses, the ergonomy was not suitable concerning the physical limitations of the elderly. The stairs have been found as the main place for previous falls. Some participants experienced multiple falls at the same location.

CONCLUSION: Building a safe environment in old age is crucial for the prevention of falls and for an independent life. There is lack of resources available for in-home adaptations which could be beneficial for the elderly living at home.

Keywords: Old age, home ergonomy, falls, safety

barriers at homes



stairs



barriers at homes



stairs



P-0654

Acupuncture Treatment for Metabolic Syndrome

Esra Pektaş¹, Sultan Oksuz Zortul¹, Abdussemet Zortul², Özlem Özer¹

¹Department of Family Medicine, Ataturk University, Erzurum, Turkey

²Department of Radiation Oncology, Ataturk University, Erzurum, Turkey

Obesity is the most common public health problem in modern society. It is preventable problem has decreasing rates in developing and developed countries, also in Turkey. Although genetic factors are responsible for %30-70 of obesity, age, gender, consumption diet with high caloric intake, changing conditions of lifestyle and behaviours, decreased physical activity have caused increasing of obesity rate.

Obesity prevalence varies as country and region. Obesity prevalence in adults is %15-60. Obesity may cause both cardiovascular diseases, certain cancers, diabetes, dyslipidemia, digestive, pulmonary, musculoskeletal system diseases and psychologic, psychosocial effects might affect time and quality of life negatively. In addition to diet and exercise programs, affinity of complementary and alternative medical applications have been increased on a large scale to prevent and treat obesity. These treatments are such as phytotherapy, acupuncture and non invasive body shaping. Although some of limitations, effectiveness of these treatments has been seen in scientific literature.

Effectiveness of acupuncture treatment for obesity was exposed in many clinical trials. It can affect appetite, intestinal motility, and metabolism, as well as emotional factors such as stres. Benefits of acupuncture are weight loss, decreased BMI, decreased weight circumference, decreased TG and LDL, decreased fasting blood glucose levels, these are all, components of metabolic syndrome. Metabolic syndrome is related with many kinds of diseases such as, insulin resistance, diabetes mellitus, hypertension, polycystic ovarian syndrome, obstructive sleep apne syndrome. Thus if metabolic syndrome is prevented, other diseases related with it are also prevented. Mechanisms of acupuncture treatment are regulation of neuropeptides, the adipokins, hypotalamus-pituitary-adrenal cortex axis and sympathetic-adrenal cortex axis. Acupuncture treatment is compared with anti-obesity drugs and surgery technics; adverse effects and complications are rare seen and is not invasive and expensive as other methods and it also balances the whole person. It gives them an oppurtunity to experience health.

Keywords: Metabolic syndrome, Acupuncture, Obesity

P-0655

Evaluation of smoking characteristics and success prevalence of the patients admitted to a smoking cessation clinic in Turkey

Kamile Marakoğlu

Department of Family Medicine, Selcuk University Medical Faculty, Konya, Turkey

Prof. Dr. Kamile MARAKOĞLU1, MD. Nisa Çetin KARGIN1, MD. Rahime Merve UÇAR1, MD. Muhammed KIZMAZ1

1 Department of Family Medicine, Selcuk University Medical Faculty, Konya/TÜRKİYE

OBJECTIVES: In this study, it was aimed to evaluate the prevalence of smoking cessation success in the 1stmonth, 3rdmonth, 6thmonth, 1styear and 2ndyear after smoking cessation in patients who stopped smoking with medical treatment accompanied by behavioral therapy at our smoking cessation clinic.

METHODS: In this cross-sectional and descriptive study, 3322 people who applied to quit smoking were advised one of the most suitable medical treatments accompanied by behavior therapy after their health queries and examinations were made, and Fagerström scores were evaluated. Smoking cessation patients were followed-up clinically and calling after smoking cessation.

RESULTS: The frequency of success in the cases using varenicline in the 1stmonth was 63.5%, in the 3rdmonth 46.8%, in the 6th month 32.1%, 1styear 25.6%, and success rates was 19.9% in the 2ndyear. The success rate in the cases using bupropion in the 1stmonth was 49.9%, in the 3rdmonth 35.6%, in the 6thmonth 26.4%, 1styear 21.9%, and success rates was 16.0% in the 2ndyear respectively. The success rate in the cases using NRT was 53.2%1stmonth, 24.3% in the 3rdmonth, and 27.3% in the 6thmonth, respectively. The frequency of smoking cessation in the cases using varenicline in the 1st,3rd,6th,12thand 24thmonth was significantly higher compared to the cases using bupropion.

CONCLUSIONS: It has been observed in this study that varenicline as a smoking cessation drug is better tolerated than other medications and it seems to be more effective.

Keywords: Smoking Cessation, Varenicline, Bupropion

Table 1:The success rate of the patients quitting smoking in the 1st, 3rd, 6th months, 1st year and 2nd years.

Treatment	Successful		Unsuccessful		Total		
	n	%	n	%	n	%	
1st month							
Varenicline+BT	766	63.5	440	36.5	1206	100.0	X ² =44.094 p=0.000
Bupropion+BT	559	49.9	561	50.1	1120	100.0	
NRT+BT	25	53.2	22	46.8	47	100.0	
BT	12	17.1	58	82.9	70	100.0	
Total	1362	55.8	1081	44.2	2443	100.0	
3rd month							
Varenicline+BT	548	46.8	22	53.2	1170	100.0	X ² =34.504 p=0.000
Bupropion+BT	405	35.6	733	64.4	1138	100.0	
NRT+BT	9	24.3	28	75.7	37	100.0	
BT	5	7.1	65	92.9	70	100.0	
Total	967	40.0	1448	60.0	2415	100.0	
6th month							
Varenicline+BT	386	32.1	815	67.9	1201	100.0	X ² =9.764 p=0.000
Bupropion+BT	319	26.4	891	73.6	1210	100.0	
NRT+BT	6	27.3	16	72.7	22	100.0	
BT	4	6.7	56	9.3	60	100.0	
Total	715	28.7	1778	71.3	2493	100.0	
1st year							
Varenicline+BT	298	25.6	865	74.4	1163	100.0	X ² =4.518 p=0.034
Bupropion+BT	261	21.9	931	78.1	1192	100.0	
Total	559	23.7	1796	76.3	2355	100.0	
2nd year							
Varenicline+BT	211	19.9	848	80.1	1059	100.0	X ² =4.857 p=0.028
Bupropion+BT	133	16.0	699	84.0	832	100.0	
Total	344	18.2	1547	81.8	1891	100.0	

P-0656

Physicians How Much They Know and How Much Aware of the Chronic Hepatitis C: A Study With Questionnaire

Nuket Bayram Kayar¹, Yusuf Kayar², Ahmet Danalioglu², Vusale Gozutok¹

¹Department of Family Medicine, Bagcilar Education and Traditional Hospital, Istanbul, Turkey

²Department of Internal Medicine, Bezmialem Vakif University, Istanbul, Turkey

INTRODUCTION: Hepatitis C virus seroprevalence was reported as an average of 3% across the world and 0.9% in our Country. One of the reasons for the inadequate diagnosis and treatment of hepatitis C is inadequate knowledge and awareness of physicians.

AIM: The aim of this study is to measure the level of knowledge and awareness of physicians about chronic hepatitis C infection.

METHOD: 125 family physicians and 76 internal medicine specialists working in Istanbul were included in the study. The participants were requested to complete questionnaire at the same meeting.

RESULTS: Of the physicians, mean age was 30.9±7.1 years (range 23-45) and 84(42%) male. Four of physicians (2%) had chronic hepatitis C and 12(6%) had never the test. Physician of 17(8.4%) had chronic hepatitis C in relatives.

Answers to questions were as follows: HCV can be transmitted by sexual contact 89%. The maternal transmission is possible 74%. Sharing of shaving materials may cause transmission % 69. In addition, the physicians answered as HCV can transmitted by kissing (17%), by using the same toilet (3%), by working in the same environment (4%). Positive family history of hepatitis C and specialties of physicians were not significant factors to increase the awareness of hepatitis C infection. Physicians between 23-28 age were significantly less aware of hepatitis C.

CONCLUSION: The knowledge and awareness of physicians about hepatitis C infection are not enough to effectively prevent the transmission of infection and to catch the patients who need therapy. So attention should be given to screening programs and the training of physicians in primary care.

Keywords: Awareness, Hepatitis C, Doctors

P-0657

The Elli-Khemsin project: Community based participatory research about the loyalty conflict in second generation migrants after 50 years of Moroccan and Turkish immigration

Hulya Tatli¹, Geoffroy Laurent¹, Sabine Wibaut¹, Sergio Costa², Lidwuina Deneys², Lula Baguet², Erol Telyak³, Hamza Assadi³, Meltem Kizil³, Basma Challal³, Yuksel Karaca³, Nassima Bouazziz³

¹ETMS. Private health center Espace Temps, Gilly, Belgium

²AJMO Accompagnement Jeunes en Milieu Ouvert, Charleroi, Belgium

³High school students, Charleroi, Belgium

Introduction

“Would you consider yourself more Turkish or Belgian”? To make a choice between Belgium and Turkey is like making one between my mother and father claims a Belgian-Turkish teenager. That reveals the deep feeling of descendants of Moroccan or Turkish immigration in Belgium we commemorate the 50th anniversary this year. When two objects of desire are in contradiction, that may give rise to loyalty conflict. And that is exactly what we are interested in: the loyalty feeling between parental culture and the one of the native country. This project aims to take interest in the fruits of the immigration and more particularly in the teenagers born of immigrant parents in Belgium by the realization of a video by whom it concerns first, with the help of professionals. How do these teenagers daily manage this far-out situation? The aim of this project is to illustrate these silent questionings. The realized video will be broadcasted in schools to allow other teenagers to identify with the characters and to open up the debate.

Methods

The association ETMS (Private health center Espace Temps) has signed a partnership declaration with the Center of Immigration of Charleroi and the association Accompaniment of Teenagers in Open Custody (AJMO) to elaborate a participatory research in community health. Recruitment of participants, meetings with teenagers, storylines writing, shooting, editing and presentation of the video to an interested audience were the following steps.

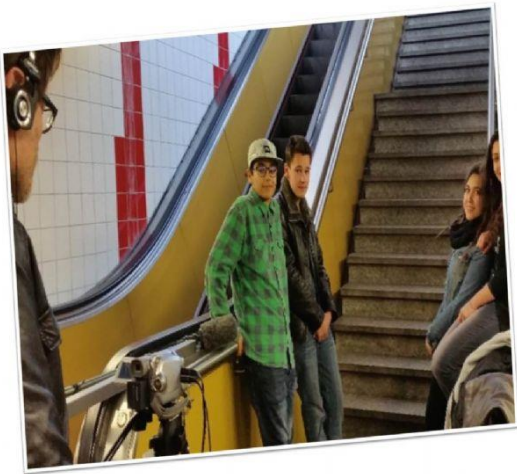
Results

A psychologist, a family doctor, a nurse practitioner, a cameraman, social workers, and six teenagers of Turkish, Moroccan or Algerian origin take part to the project that has lasted for one year.

The video will be ready end 2015 and will allow to debate sensitive topics and the creation of a partnership with schools that are interested in using this tool for educational purposes.

Keywords: Family Practice, Community-Based Participatory Research, Intergenerational Relations, loyalty conflict

shooting in de tube



shooting the video



Preparing the stories



the photo is illustrating de process of preparing the video

P-0658

The importance of health education in eradicating scabies morbidity: a family case study in Indonesia

Fika Ekayanti

Department of Community Medicine, State Islamic University of Syarif Hidayatullah, Jakarta, Indonesia

Background and Aim

Scabies is a common disease in developing country such as Indonesia. Health education has an important role to prevent the infestation and reinfection of the parasite. The case study aimed to describe the importance of health education for eradicating the morbidity because of scabies.

Case presentation

A male patient showed into clinic on May 2015 with itching. He said the predilection was around hands, inguinal and genital. He said that the symptom occurred first to his son. The nephew who stayed in the boarding school stay for some night and slept in his son's room. They were brought to the clinic around a month ago and have been healed. However, it occurred to him, his wife and his daughter. The morphology of his lesion was unclear. When it was inspected on his wife, it showed clear canalculated lesions. They were medicated with cream permethrin 5% and asked to clean all the household contacts. They were told about the importance of that action to end the transmission of mites.

Discussion

First encounter of the patient's son, the education about importance of prevention for eradicating the mites seemed to be neglected. WHO has recognized scabies as one of community neglected tropical diseases (NTDs). Children who stay in boarding school in Indonesia, which has a tropical climate, is the most vulnerable sector of society. They become the agent for scabies transmission. Education to the patient and family or other related person has an important role to eradicate the manifestation. Commitment of health provider to explain reason for the action, is needed as preventive care.

Conclusion

Scabies as an NTD, has to be prevented by early detection and education to the vulnerable community. Neglecting education would suggest further distribution and recurrence of the disease.

Keywords: scabies, health education, morbidity.

canaliculated presentation



Lesion in the lower abdomen

P-0659

What have we improved in chronic respiratory pathology to stop smoking?

Juan Carlos Montalva Barra¹, M Teresa Magdalena Carreres¹, Luis Manclús Montoya³, Oscar Martinez Ferris², Teresa Benavent²

¹CS Carcaixent- H de la Ribera

²CSI Alzira- H de la Ribera

³SUH Hospital de la Ribera

We know from previous studies that smoking is a key factor of production exacerbation and chronic pulmonary disease (EPOC). Given that we see in our consultations a number of high exacerbations because of snuff decided to try to get in EPOC and asthma and even the decline of smoking cessation for control of such patients

Prospective multicenter study of patients with EPOC and asthma intention to leave the snuff and control both exacerbations and subsequent treatment to try to stratify the improvement and the cost of such patients after leaving the snuff

38 patients with COPD / Asthma motivation were selected according to maximum Richmond test (test score October 7 points) and also had a moderate to high dependence (Fragerström test) established and monitored by nurses and doctor to assess progress and adjusting treatment.

the average age of the patients was 50.66 years (55.5 years for men and less for women, 47.9 years). 34.2% of patients were COPD and Asthmatic rest (65.8%)

Three months 70% of patients left the snuff (50% of men but 100% of women) and at 6 months was achieved increase tobacco cessation 80% (rising to 60% men) with a decrease of habit smoking next 90% of patients COPD 40 queries primary care physician were required with a single and 2 emergency hospitalizations and managed to leave the patient at the end of work with 2 drugs bass

Asthma primary care consultations 29 8 fieron necessary and emergency department without specifying income Through this study we show that the involvement of medical and nursing can achieve control of patients with moderate to high motivation to leave the snuff to achieve a clear improvement in the number of exacerbations and complications of chronic respiratory diseases in our consultations

Keywords: Pulmonar chronic, asthme, smooking

primary care

primary care emergency hospitalization

40

2

P-0660

Importance of primary care at fighting against obesity: A case report

Burcu Aykanat, Elif Altunbaş Ateş, Turan Set

Department of Family Medicine, Karadeniz Technical University Medical Faculty, Trabzon, Turkey

BACKGROUND&AIM: Obesity, which is the base to the emergence of many diseases, is a major health problem affecting the survival and quality negatively with increasing incidence. In this study, we aimed to explain the importance of primary care fighting against obesity, by showing a patient who present to primary care, how she lose weight with the implementation of a diet, exercise program and motivational approach.

CASE: A 36-year-old female patient who cannot lose weight for years and who failed in her diet programs before was included in our slimming program by accepting our proposal. When she was attended to our outpatient clinic she was 104.3 kg. She was 1.64 m in height, 118 cm in waist circumference and 133 cm in hip circumference. Her BMI was 38.8 and fat ratio was 44.5%. According to her laboratory findings biochemical values were normal as fasting glucose and thyroid functions. We performed a diet, suggested her to chew food while eating, drinking at least 2 liters of water per a day and walking at least 120 minutes per week. She called for controls to be weighed at intervals of 15 days to our family medicine clinic. Patient was motivated to be weakened and reminded recommendations on each visit. Patient was satisfied with the diet program and loses weight without starving. She lost about 2 kilos in measurements every 15 days. The patient weighed 89.3 kg at the end of 3.5 months and fat ratio measured as 39.8%.

CONCLUSIONS: Applying diet program in family medicine clinic, making checks in 15 days and motivation during the controls helped patient to lose weight. As a result, our patient lost 15 kilos at 3.5 months. This shows effectiveness of regular follow-up and motivation. In this respect, family physicians who can give continuous care has an important role in the fight against obesity.

Keywords: Obesity, primary care, continuous care

P-0661

The Study of The Presence Of Depression Among The Employees Of Medical Centre 'Zitishte'

Tamara Draskovic¹, Anelya Roshu², Xenia Pantic¹

¹medical centre zitishte, emergency unit

²medical centre zitishte, general practice

The INTRODUCTION:

The depression is a common mental disease which can be described as being in a sad mood with loss of interest and satisfaction, lack of energy, the sense of guilt and low self – esteem, eating or sleeping disorders, problems with concentration. These problems can be chronic or repetitive and prevent a subject from executing his duties on a daily basis.

The OBJECTIVE:

The aim of this study is to determine the frequency of the state of depression among the employees and to examine the relations between depression and stress and the presence of somatic disorders.

METHOD:

This research was conducted from 11/1/2014 till 4/1/2015 at Medical Centre 'Zitiste'. Using the method of the random choice we included 100 employees from different Medical Centre departments, 51 female and 49 male subjects. Beck's depression inventory has been used in this research. We have gathered the data based on gender, education and years of the employment. The statistics has been done by X2 tests to estimate the significance of the gained results.

RESULTS:

The presence of different states of depression has been found with 38/100 subjects. The rest of 62 subjects showed normal state of humor. We can conclude that the majority of our subjects are in a good, positive mood. We have noted that there is a considerable link between depression and the years of service as we have

perceived that the women suffer from depression more. This survey is anonymous, therefore we can not determine if depression is connected to a working place.

CONCLUSION:

It is very important to identify the symptoms of depression in time and start the treatment as soon as possible, for this is the best way to prevent the grave consequences depression can lead to.

Key words: Depression, humor, Beck's inventory

P-0662

Applying personalised medicine to healthcare: raising awareness, preventing and treating diseases

Helene Alavere

Estonian Genome Center, University of Tartu

Effective treatment of hypertension is an important part of preventing many cardiovascular diseases. Effective treatment requires good medication adherence. Information about personal genetic risks gives the subject the opportunity to consciously participate in the decision making process of the treatment, including making the decisions that are realized through compliance.

The Estonian Genome Center, University of Tartu (EGCUT) is ready to provide the physicians and subjects with the information about personal genetic risks of cardiovascular diseases. However, before finalising the development of the information providing service, it is essential to study the effect of providing individual genetic feedback on medication adherence, health behaviour and treatment effectiveness in ambulatory medical practice of hypertension. The information which shall be collected during the study is about the acceptability of providing and receiving genetic feedback and it is important in developing the marketing strategies for the service. So far, there has been little research on the association between the feedback on personal genetic risks and medication adherence. That is why the planned study has the potential to significantly contribute to the international scientific discourse concerning personalised medicine.

The general objective of the study is to evaluate the applicability of personalised medicine (providing individual feedback about genetic risks) in ambulatory medical practice of hypertension.

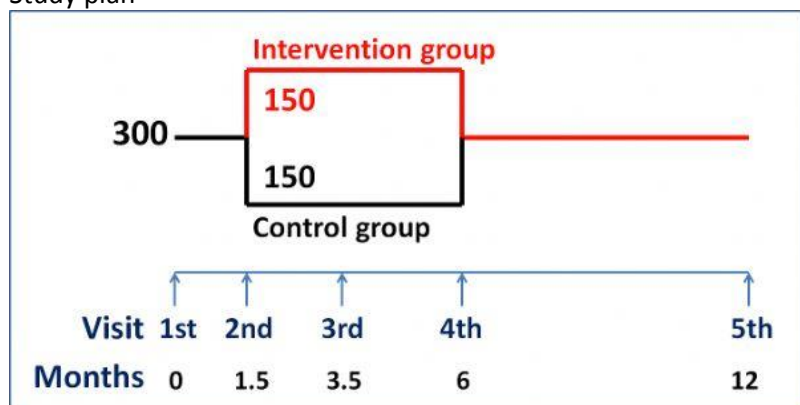
Sub-objectives are to evaluate the effect of providing individual feedback about genetic risks on medication adherence (the primary outcome); and to evaluate the effect of providing individual feedback about genetic risks on treatment effectiveness of hypertension and health behaviour (the secondary outcomes).

The participants will be recruited at family practices in Estonia.

Genetic analysis will be conducted at the Estonian Genome Center of the University of Tartu and the feedback about the personal genetic risks will be given by family practitioners.

Keywords: personalised medicine, genetic testing, prevention and treatment of hypertension

Study plan



P-0663

Associations of Physical Activity with Sleep Quality and Perceived Stress Scale Among Medical Students

Bahriye Arslan, Funda Yıldırım Baş

Department of Family Medicine, Süleyman Demirel University, Isparta, Turkey

AIM: We conducted this study to investigate the association of physical activity with sleep quality and perceived stress level among Turkish medical students.

METHODS: This study was conducted in the Faculty of Medicine at Süleyman Demirel University in Turkey. The students reported with questionnaires. The questionnaires contained questions regarding each student's age, sex, height, weight, smoking, alcohol and drug use, and disease history. Physical activity was assessed using the International Physical Activity Questionnaire (IPAQ), sleep quality was measured via the Pittsburgh Sleep Quality Index (PSQI) and perceived stress was examined using Cohen's Perceived Stress Scale (PSS). Non-normally distributed continuous variables are expressed as median and interquartile range (median [IQR25-IQR75]) and were compared with Mann-Whitney U tests. The relation between IPAQ score and PSQI and PSS scores was determined using Spearman's correlation coefficient.

RESULTS: Of the 905 students, 462 students (54.2%) were female. The age of participants ranged from 18-28 and the mean age was 20.73±1.9. Participants were classified according to their IPAQ scores; some 256 (30%) students were physically inactive. On the other hand, when classified according to their PSQI global score, 392 (46%) students had a poor sleep quality. There was a strong correlation between IPAQ score and PSQI and PSS scores. Physically active students had significantly higher levels of sleep satisfaction and lower levels of stress. Similarly, the PSS score was well correlated with the PSQI score. Students with low levels of stress were more likely to express satisfaction with their sleep

CONCLUSION: The results of the present study indicate that an increased PA level is associated with higher quality sleep and decreased perceived stress levels.

Keywords: sleep, physical activity, physiological stress

P-0664

Subclinical hypothyroidism and psychiatric symptoms

Patricia Elena Oscanoa¹, Max Alexander Encarnación¹, Marta Bandrés², Susana Elisabeth Riesgo², Nerea Trecet¹, José Romero²

¹CAP Amadeu Torner

²ABS Santa Eulalia Sud

Background & AIM:

To determine the prevalence of anxiety and depression in patients with a previous diagnosis of subclinical hypothyroidism (SH) using Goldberg and Beck anxiety and depression inventory, and the therapeutic management.

METHOD:

A cross-sectional study was conducted in an urban primary care center in January and February 2015. All patients ≥ 18 years diagnosed with SH without previous diagnosis of anxiety or depression or cognitive impairment were included, recorded in the medical record. Of 673 patients with SH, 187 randomly selected were administered: 161 Goldberg inventory (patients without anxiety or depression after SH) and 26 Beck inventory (those with anxiety or depression after HS to assess the current intensity of symptoms). Statistical analysis was conducted in SPSS.

RESULTS:

N = 187, 77.5% women, mean age: 57.48 years (SD: 16.7), 65.2% were married, 26.7% with secondary education, occupationally active 35.8% and 92.5% were Spanish.

44.4% had arterial hypertension, 2.7% atrial fibrillation, 10.7% diabetes mellitus 2, 58.3% dyslipidemia and 22.5% obesity.

The average duration of SH was 5.6 years (SD: 4.8). Of the sample, 34.8% received thyroid hormone, 15% anxiolytics and 12.8% antidepressants.

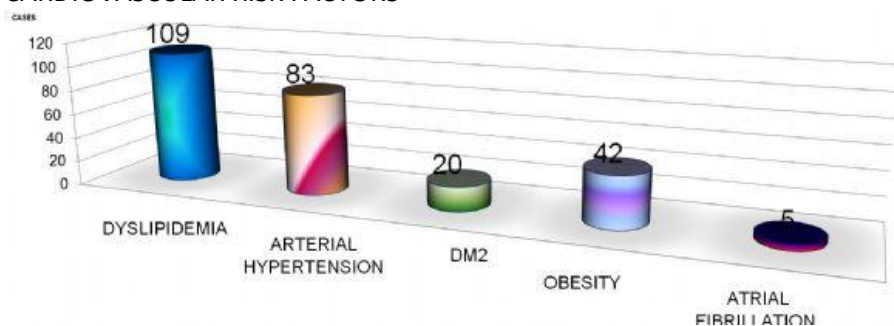
Regarding Goldberg inventory, 26.7% were positive for anxiety (CI: 19.9%-33.5%, $p < 0.05$) and 33.5% for depression (IC: 26.2%-40.8%, $p < 0.05$).

CONCLUSIONS:

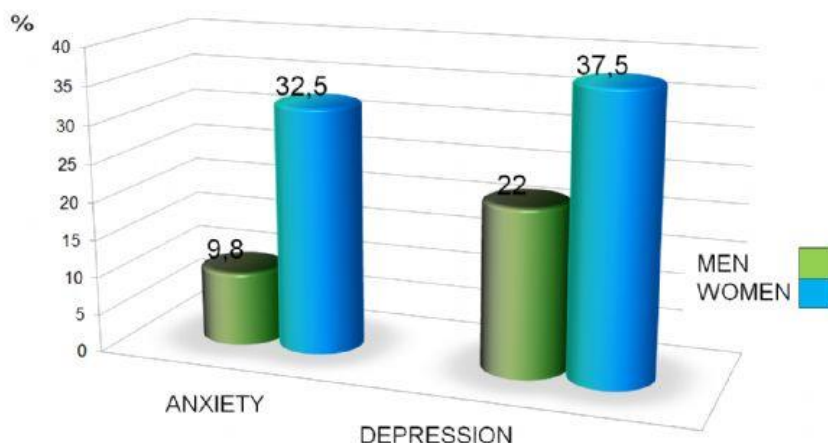
In this study, SH is associated with anxiety and depression. We found a high prevalence of both with Goldberg inventory, for what we think we should follow up on patients with SH if present these pathologies and perform appropriate management with antidepressant and psychological treatment. Consideration should be given to start thyroid hormone because there are trials that guarantee an improvement in this type of patient. Also, most patients with HS have dyslipidemia and hypertension, so it is important to control cardiovascular risk factors.

Keywords: subclinical hypothyroidism, anxiety, depression

CARDIOVASCULAR RISK FACTORS



GOLDBERG POSITIVE FOR ANXIETY AND DEPRESSION



P-0665

Role of nurse practitioners in reducing cardiovascular risk factors: a retrospective cohort study

Zalika Klemenc-Ketis¹, Alenka Terbovc³, Bostjan Gomiscek⁴, Janko Kersnik²

¹Department of Family Medicine, Medical Faculty, University of Maribor, Maribor, Slovenia

²Department of Family Medicine, Medical Faculty, University of Ljubljana, Ljubljana, Slovenia

³Zdravstveni dom Kranj, Osnovno zdravstvo Gorenjske, Kranj, Slovenia

⁴University of Maribor, Faculty of Organizational Sciences, Kranj, Slovenia

Background and aim

A new model of 'renewed' family practice was introduced in Slovenia as a pilot project in 2011, in which nurse practitioners are included in a team carrying out preventive activities and managing patients with stable chronic diseases. In this study we wanted to determine the impact of nurse practitioners' counselling on reducing cardiovascular risk factors in patients participating in routine preventive check-ups.

Method

This retrospective cohort study was conducted in 16 family medicine practices (eight renewed and eight regular family practices). In each family practice, a systematic sample was selected of registered patients participating in cardiovascular preventive check-up. Data on sex, age, blood pressure value, cholesterol value, blood sugar value, smoking, level of physical activity, and cardiovascular risk were collected. Patients attending renewed family practices received counselling on risk factors from nurse practitioners (test group), and patients attending regular family practices received the counselling from family physicians (control group). Data were collected again at least one and no more than five years after the baseline consultation. This study was a part of CPC+ (Upgraded Comprehensive Patient Care).

Results

There were 128 patients in the test group and 129 patients in the control group. At the control visit, the patients counselled by nurse practitioners had significantly lower levels of systolic blood pressure and cholesterol and practiced regular physical activity significantly more often than patients counselled by family physicians.

Conclusion

Nurse practitioners can be successful when counselling patients on cardiovascular risk factors during their preventive check-ups.

Keywords: Primary care, nurse practitioner, preventive care

This study was a part of CPC+ (Upgraded Comprehensive Patient Care) project.



The clinical characteristics of patients in the test and control groups after the study

Characteristic	Test group (N, %)	Control group (N, %)	p (chi-square test)
Smoking (yes/no)	27 (21.1) / 101 (78.9)	34 (26.4) / 95 (73.6)	0.379
Physical activity (less than 2-3 times per week / 2-3 times per week or more)	24 (18.8) / 104 (81.2)	51 (39.5) / 78 (60.5)	< 0.001
Cardiovascular risk level (less than 20% / 20% or more)	87 (75.0) / 29 (25.0)	74 (63.8) / 42 (36.2)	0.087
	Test group (mean \pm standard deviation)	Control group (mean \pm standard deviation)	p (independent t-test)
Systolic blood pressure (mmHg)	131.6 \pm 12.5	136.4 \pm 16.7	0.009
Diastolic blood pressure (mmHg)	85.4 \pm 8.6	85.2 \pm 9.6	0.889
Cholesterol (mmol/l)	5.5 \pm 1.1	5.8 \pm 1.5	0.030
Glucose (mmol/l)	6.6 \pm 1.8	6.3 \pm 1.7	0.210
Body weight (kg)	84.7 \pm 16.1	82.6 \pm 15.7	0.301

FARMAPRES project. Opinion of primary health care centers' professionals about the role of community pharmacy offices in the control of blood pressure

Francisco Javier Sanz García¹, Vicente Giner Galvañ², José Ramon Ramos Segura³, Juan José Tamarit García⁴, Belén Roig Espert⁵, Irene Bonig Trigueros⁶, Mila Reig Botella², Francisco Valls Roca⁷, Vicente Pallarés Carratalá⁸

¹Unidad de HTA y Riesgo Cardiometabólico. Medicina Familiar y Comunitaria. Hospital Virgen de los Lirios, y CS La Fábrica, Alcoy, Alicante, España

²Unidad de HTA y Riesgo Cardiometabólico. Servicio de Medicina Interna. Hospital Virgen de los Lirios, Alcoy, Alicante, España

³Medicina Familiar y Comunitaria. Centro de Salud la Fábrica, Alcoy, Alicante, España

⁴Servicio de Medicina Interna. Hospital General Universitario, Valencia, España

⁵Unidad de HTA. Servicio de Medicina Interna. Hospital de Manises. Valencia, España

⁶Hypertension Unit. General Internal medicine department. Hospital de Vinaroz. Vinaroz, Castellón, España

⁷Medicina de Familia y Comunitaria. Centro de Salud de Benigànim. Valencia, España

⁸Medicina Familiar y Comunitaria. Unidad de Vigilancia de la Salud. Unión de Mutuas. Castellón, España

OBJECTIVE: To know the opinion of sanitary professionals working at the Primary Health Care Centers (PCHc) about the potential role of Community Pharmacy Offices (cPhO) in the management of blood pressure (BP).
Design and METHOD: Survey structured into 12 questions with semi closed answers was addressed to physicians (Ph) and nurses (Nr) of the 250 PCHc in the Comunitat Valenciana (CV), a region in the east coast of Spain.
RESULTS: 952 professionals answered the survey. Most participants were Ph (63.1%), females (50.8%) with 20.9±10.0 years of experience. More than 20 reasons were considered as potential advantages of cPhO for BP control compared with PCHc (Table). 3.9% of participants believed that cPhO have not any advantage. The most common answers to the question What do you think is the role of the cPhO in the management of BP? were: Easier detection of undiagnosed and/or uncontrolled hypertension (35.7%), Coordinated aid for the PCHc (30.4%), and None (18.7%). The percentage of those thinking that cPhO have not any potential role was significantly lower in Alicante (13.3 % vs. 20.2 and 20.7 % for Castellón and Valencia), without differences in gender, experience or professional collective. The majority (62.9 %) of participants thinks that the cPhO are fulfilling their role, with 3.9% saying that they Do not know. Those with a negative point of view were mainly men (34.8 vs. 28.3%) and Ph (34.9 vs. 25.0%) ($p>0.05$ for both). It was pointed 13 different reasons to think that cPhO are not fulfilling their role, mainly: Inadequate measurement methodology (24.1%), Ignorance about the disease (16.7 %), Tendency to overestimate BP values and alarm patients (16.3%), No coordination with PHCc (8.9%).
CONCLUSION: The majority of professionals working at PCHc think that cPhO has advantages for management of BP, mainly flexibility, accessibility and lower WCE.

Keywords: blood pressure, control, pharmacy offices

Advantages of cPhO for BP control compared with PCHc

Advantages of cPhO for BP control compared with PCHc

Advantages of cPhO for BP control compared with PCHc	(%)	Advantages of cPhO for BP control compared with PCHc	(%)
"Greater flexitime"	21.8	"Lower cost"	2.3
"Lower white coat effect (WCE)"	17.2	"An additional resource"	1.3
"Greater closeness and accesibility"	16.1	"Greater cost"	0.6
"Greater closeness and accesibility, and lowerWCE"	10.8	"BP overestimation and alarmist interpretation"	0.3
"Low WCE and greater flexitime"	7.0	"They are actually participating"	0.4
"Greater closeness and flexitime"	5.9	"Others"	0.2
"Greater closeness and accesibility, and lower WCE and cost"	4.8	"New Ht detection"	0.2
"Nothing"	3.9	"Population's greater confidence"	0.2
"Greater closeness and lower WCE"	3.3	"Referral to Health Centers"	0.1

cPhO: Community Pharmacy Office. PCHc: Primary Health Care Center. WCE: White Coat Effect. Ht: Hypertension.

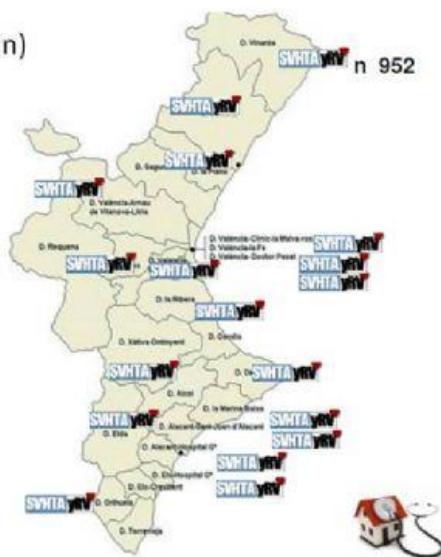
Advantages of cPhO for BP control compared with PCHc

FARMAPRES project. Comunidad Valenciana (Spain)

FARMAPRES project.
Comunidad Valenciana (Spain)

- 18/24 Health Departments
- 138/250 PCHc
- 952 Professionals

Survey structured into 12 questions with semi closed answers was addressed to physicians (Phy) and nurses (Nr) of the 250 PCHc in the Comunitat Valenciana (CV), a region in the east coast of Spain.



FARMAPRES project. Comunidad Valenciana (Spain)

Main results

Main results

	Total	Castellón	Valencia	Alicante	p*
Males (n, %)	391, 41,1	98, 34,8	198, 46,5	89, 38,2	<0,0001
Females (n, %)	484, 50,8	166, 58,9	202, 43,4	113, 48,5	
Physicians (n, %)	601, 63,1	159, 36,4	296, 69,5	136, 58,4	<0,0001
Nurses (n, %)	320, 33,6	121, 42,9	120, 28,2	79, 33,9	
Years of experience	20,9 ± 10,0	23,5 ± 10,0	22,8 ± 9,4	22,9 ± 9,4	0,791
≥ 10 years exp. (%)	716, 75,2	222, 78,7	314, 73,7	172, 73,8	0,298
≥ 20 years exp. (%)	537, 56,4	172, 61,0	231, 54,2	128, 54,9	0,341

Main results

P-0667

Disability, Home Accidents And Family Medicine Role

Serkan Bayad, Vildan Mevsim

Department of Family Medicine, Dokuz Eylul University, Izmir, Turkey

Introduction

The home environment is the most essential factor for children's injuries, half of injuries happens at home. Batteries are the one of the home hazards, ingestion or insertion of batteries can occur easily and is often unnoticed. It causes several symptoms like dysphagia, fever, respiratory distress, restlessness, electrolyte leakage, pressure necrosis, metal toxicity or tissue damage by alkaline.

It is estimated that % 10 of children globally suffer from some kind of disability. Prevalence of injury among disabled children is % 4.4. We meet frequently children with home accidents in family medicine unit(FMU). For this reason we discussed in this case disabled children home accident and family physician role at management, prevention strategies.

Case presentation

Intellectual disabled 5 y children was brought to FMU, insert remote control battery from rectal way. Parents has noticed but lately. Battery was palpable on examination and removed. It was bitten and found openings around. We called Poison information Center(PIC). The patient was sent to emergency service(ES) because of PIC recommendation, another battery ingestion or insertion suspect and absence of radiograph. At ES, nothing detected on X-ray. Patient was monitored. In follow-up process no symptom was detected. Possible situations was told and patient discharged. Patient was taken to our follow-up again. Any pathological condition didn't reveal. Information was given the family about home accidents. A security list was created. PIC, ES and FMU numbers were taught.

Conclusion

The most effective management strategy at home accidents is prevention. Family physicians should know management and prevention for home accidents. Their position is very important because of relatives with patients. Home care service is an opportunity for patients and physicians. Also other health care professionals should be responsible. For detailed prevention programmes, state policies should be created and media support is necessary.

Keywords: disabled children, home accidents, family medicine

P-0668

Digital Referencing in Dermatology: A sign of the times

José Bastos Silva¹, Lia Rafaela Beleza¹, Susana Catarino¹, Maria Miguel Sa²

¹USF Vale do Vouga, ACeS Entre Douro e Vouga, São João da Madeira, Portugal

²USF Famílias, ACeS Entre Douro e Vouga, Santa Maria da Feira, Portugal

Background & AIM: Basal cell carcinoma (BCC) is the most common skin cancer and its incidence varies depending on the predominant skin type in a given population and sun exposure habits, standing in Portugal close to 100 new cases per year per 100,000 inhabitants. Nodular BCC is the most common subtype. Clinically, lesions appear as pink papules with raised edges and pearly or pigmented appearance. The prognosis of BCC has improved substantially in recent decades, due to earlier diagnosis and surgery with fewer sequels. The aim of this clinical case is to show the efficacy and advantages of digital referencing of dermatological cases.

METHODS: Direct interview, clinical data query in the Portuguese health data platform.

RESULTS: Male, 62 years old, no toxic habits. Past medical history: hypertension, dyslipidemia. Regular medication: aspirin 150 mg id, simvastatin 20 mg id, (amlodipine 5 mg + 20 mg olmesartan) id. History of present illness: patient comes to family doctor office with burning sensation around a lesion on the back with 2-3 months of evolution. Physical examination revealed a pigmented lesion of the dorsal region of about 10mm long axis. Patient was referred to the dermatology consultation at reference hospital through P1 Alert® system with two pictures attached. One month and 17 days later, nevus excision was done having the histological examination showed a correspondence to BCC of nodular type.

CONCLUSIONS: Digital-referencing with image in dermatology allows prioritizing urgent situations, facilitating the screening and evaluation of patients with limited access to secondary health care. Although with limitations, these storage and image transmission systems provide high levels of diagnostic accuracy, are beneficial in terms of cost and are more convenient for primary care health professionals, as for patients as well.

Keywords: Basal basal cell carcinoma, digital referencing, diagnostic accuracy

Lesion of the skin on the back



Normal size

Lesion of the skin on the back



Enlarged and Focused

P-0669

Before the onset of psychosis – empowering family doctors

Sofia Correia Pinto¹, Joana Carneiro², Oriana Correia Pinto³, Inês Domingues Teixeira⁴

¹USF S. João do Porto, Porto, Portugal

²USF Garcia da Horta, Porto, Portugal

³Serviço de Psiquiatria, Centro Hospitalar Vila Nova de Gaia, Porto, Portugal

⁴USF Ribeira Nova, Lisbon, Portugal

Background & AIM:

About 15% of the general population experience auditory hallucinations and 15-20% paranoid thoughts. On average 2 to 3% of the adult population will develop overt psychosis and 6% subthreshold psychosis. Some individuals are “at risk mental state” (ARMS) of developing this condition, 18% of which will develop psychosis at six months and 36% at three years.

Early intervention has earned increasing interest and it has been shown that it can prevent or delay the onset of psychosis, or at least diminish the duration of untreated psychosis, ultimately improving outcomes.

We aim on increasing family doctors’ knowledge of early warning signs for psychotic disorders and suggest a protocol on adequate management of individuals who are ARMS of developing psychosis.

METHODS:

Literature review of selected articles and books deemed relevant by the authors, using Medline/Pubmed database with the combination of the following key-words: “psychosis”, “primary health care”, “prevention”.

RESULTS:

The onset of psychosis usually occurs in individuals at 16 to 30 years of age. Specific criteria have been established to identify the people who are ARMS of developing overt psychosis. Regular monitoring, psychotherapy or in some cases pharmacotherapy should be offered to individuals in this group.

CONCLUSION:

Family doctors have a multi-dimensional view of the patient and can provide a low stigma environment in which to assess and treat patients with psychiatric disorders. They play a crucial role in creating awareness about signs and symptoms suggestive of ARMS or overt psychosis, identifying them at a very early stage and preventing any delays in treatment.

A close working relationship between specialist mental health services and primary care is essential.

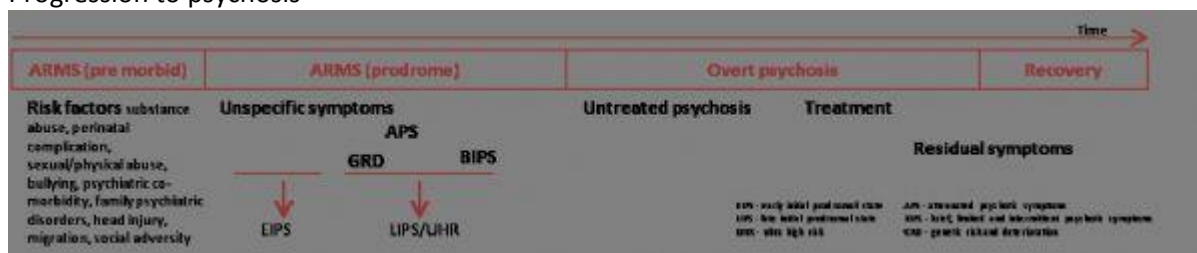
Keywords: prevention, psychosis, primary health care

Family doctor



Family doctors have a crucial role in early detection, initial approach and monitorization

Progression to psychosis



The diagram shows the progression before and after overt psychosis ensues

P-0670**An evaluation of the awareness and attitudes towards life style changes in a group of hyperlipidemic patients**

Merve Esen Arslan, Işık Gönenc, Emine Zeynep Tuzcular Vural, Refik Demirtunç
Haydarpaşa Numune Training and Research Hospital

Background and AIM: In this cross-sectional study evaluation of knowledge levels related to hyperlipidemia(HL), life style changes(LSC) and complications of HL and behavioral characteristics of LSC in hyperlipidemic patients was aimed.

METHOD: A questionnaire composed of 31 questions inquiring the knowledge and awareness of LSC in hyperlipidemic patients was used to obtain data from 302 hyperlipidemic patients.

RESULTS: The mean age of participant was 50.6±13.2 years, 73.8 % was women, 35.8% had primary educating. 28.5 % of the participants were recently diagnosed with HL, 59.6% had a positive family history and 30.8 % were using drugs for HL.53.3% was obese. Although 229 of the patients said cholesterol levels decrease with weight loss, 38.9%of these patients hadn't tried to lose any weight. 50.5% of participants who said overweight people had high cholesterol levels, was obese. 55.3 % of patients who said daily 30 minutes of physical activity is necessary, didn't do any physical activity. 26.8 % of participants who knew reducing daily fat intake would decrease cholesterol, didn't make any dietary changes. 44.0% of patients who knew alcohol raised cholesterol levels, quit alcohol after the diagnosis. 47.4% of aware of smoking worsening hyperlipidemia, has quit smoking. Increased risk of myocardial infarction is most well-known complication of the HL by 80.5%. Male sex, age over 55, higher level of education and income, family history, HL medication usage were statistically significantly related with high knowledge scores. Female sex, Women, age over 55, low levels of education and income, using medication for additional diseases, former diagnosis of HL, non-smoking and no alcohol, obesity statistically significantly increased HL behavior scores.

CONCLUSION: CVD deaths has become the number one cause of death all over the world. LSC has an important role for preventing and treatment of CVD in the primary care.

Keywords: hyperlipidemia, life style changes, awareness

Table1-Sociodemographic variables and habits of participants

	Group	N	Mean	SD	Median	p
Gender	Male	79	16,5	4,3	16	<0,001
	Female	223	19,0	3,2	20	
Age (years)	≤54	184	17,8	4,0	19	0,003
	≥55	118	19,2	3,1	20	
Education	Primary School and below	124	18,8	3,6	19,5	0,039
	Secondary School and above	178	18,0	3,7	19	
Monthly income	≤1000 TL	72	18,5	3,3	19,0	0,009
	1000-3000 TL	191	18,8	3,5	20,0	
	≥3001 TL	39	16,3	4,7	16,0	
Comorbidity	Yes	212	18,8	3,5	19,5	0,001
	No	90	17,3	4,0	18	
Using Medication	Yes	184	19,0	3,4	20	0,001
	No	118	17,5	4,0	18,5	
Duration of HL	Newly Diagnosed	86	17,4	3,7	18	0,007*
	≤1 year	18	18,3	3,4	19	
	>1 year	192	18,7	3,7	20	
Smoking Habits	Smoking	68	15,8	3,8	16,5	<0,001
	Non smoker	173	19,5	3,0	20,0	
	Past smoker	61	18,0	4,1	19,0	
Alcohol Consumption	Regular Drinker	42	13,9	4,2	14,0	<0,001
	Non Drinker	230	19,3	2,9	20,0	
	Past Drinker	30	17,3	3,5	18,5	
BMI kg/m ²	≤24,9	44	18,2	4,8	19,0	0,001
	25-29,9	97	17,4	3,5	17,0	
	≥30	161	19,0	3,3	20,0	

Table2-Knowledge scores of participants.

	Group	N	Mean	SD	Median	p
Gender	Male	79	15,5	3,3	16	0,044
	Female	223	14,6	3,5	15	
Age	≤54	184	14,3	3,6	15	0,002
	≥55	118	15,6	3,0	16	
Education	Primary School and below	124	14,3	3,4	15	0,035
	Secondary School and above	178	15,2	3,4	16	
Monthly income	≤1000 TL	72	13,9	3,7	15	<0,001*
	1000-3000 TL	191	14,8	3,3	15	
	≥3001 TL	39	16,7	2,8	17	
Medication for HL	Yes	93	15,5	3,0	16	0,034
	No	209	14,5	3,6	15	
Family History of HL	Yes	180	15,2	2,9	16	0,01
	No	122	14,1	3,9	15	

P-0671

Positive impact of systematic training on physical improvement and biological maturity of young athletes (11-12 years)

Evangelos Theodorou¹, Apostolos Manolis², Eleni Leontidou², Chrysoula Florou³, Konstantinos Tilkeridis⁴, Michail Vakas⁵, Osman Nalian⁶, Elpida Nikitidou², Grigorios Trypsianis⁶, Konstantinos Kazakos⁴

¹2nd Primary School of Alexandroupolis, Kapodistriou 26, 68100 Alexandroupolis, Greece

²Health Center of Iasmos, Komotini, Greece

³Hellenic Tennis Federation, Imittou 267, 11631 Athens, Greece

⁴Department of Orthopaedic Surgery, Medical School, Democritus University of Thrace, Alexandroupolis, Greece

⁵University hospital of Alexandroupolis, Greece

⁶Laboratory of Medical Statistics, Medical School, Democritus University of Thrace, Alexandroupolis, Greece

Background & Aim. The purpose of this study is to investigate the influence of systematic training in physical growth and biological maturity in prepubertal males.

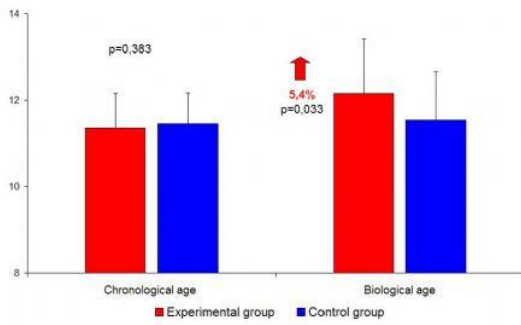
Method. The sample consisted of 177 pupils in fifth and sixth grade of primary school in the city of Alexandroupolis, who participated voluntarily. Physical activity levels were estimated with questionnaires. Subjects were subdivided into "control group" (prepubertal, whose only physical activity was the physical education of school and they never participate in systematic training, n=95) and "experimental group" (prepubertal, whose the weekly physical activity included, physical education in their schools and additionally 3-4 training units organized training in various sports clubs in the city, n=82). The following parameters were recorded: the biological age, measured by determination of skeletal age; bone density, measured by ultrasound methods; anthropometric and morphological features, such as height, body composition, selected diameters, circumferences and skinfolds; motor ability tests (Astrand's test, speed shuttle run test, vertical and horizontal jump, handgrip strength test, sit and reach test, sit ups, hanging with bent elbows, pulls at horizontal bar). **Results.** It was found that the "experimental group" exhibited older biological age (12.15 ± 1.26 years vs 11.53 ± 1.13 years, $p=0.033$), higher bone density (by 6.7%, $p<0.001$), lower BMI and body fat (by 7.7% and 14.0%, respectively; both $p<0.001$), better anthropometric features and higher performance throughout all motor ability tests ($p<0.05$), compared to "control group".

Conclusions. The present study demonstrated that the systematic physical activity has a positive effect on both the physical and the biological maturity of pre-pubertal children. This effect is mainly expressed through strengthening bone due to the increased bone density and the improvement of kinetic skills of pupils who participate in organized extracurricular sport-activities.

Keywords: young, training, maturity

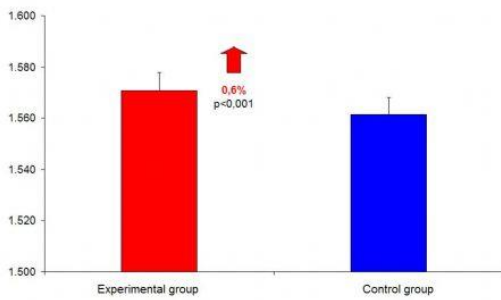
Children's chronological and biological age in relation to systematic

Children's chronological and biological age in relation to systematic



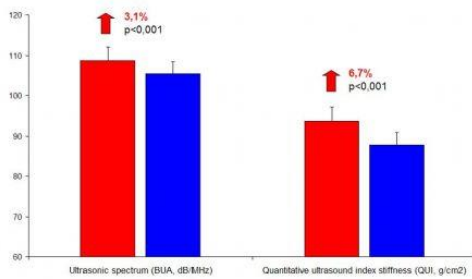
Children's bone density in relation to systematic training

Children's bone density in relation to systematic training



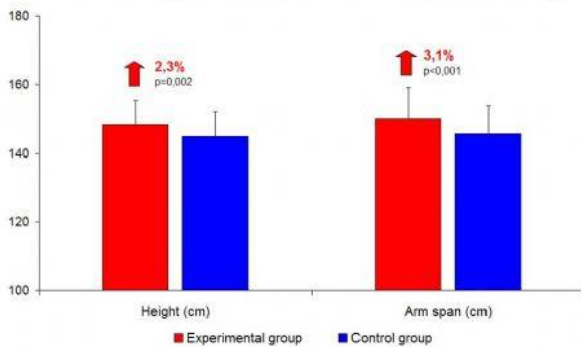
Children's bone density in relation to systematic training

Children's bone density in relation to systematic training



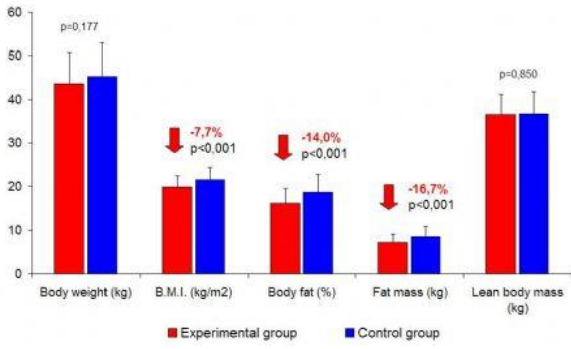
Children's height and arm span in relation to systematic training

Children's height and arm span in relation to systematic training



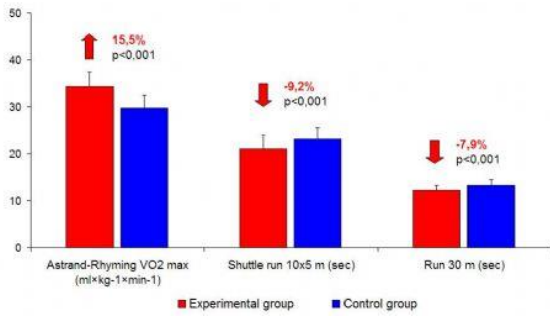
Children's body composition in relation to systematic training

Children's body composition in relation to systematic training



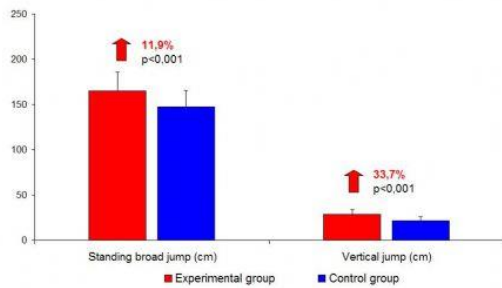
Motor ability tests in relation to systematic training (I)

Motor ability tests in relation to systematic training (I)



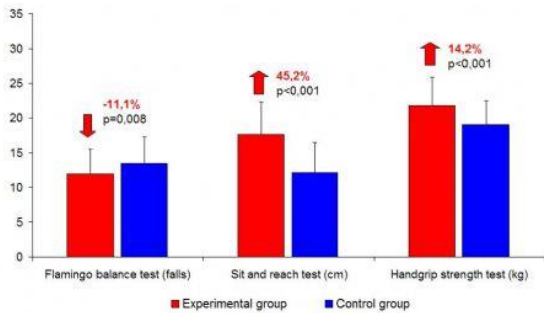
Motor ability tests in relation to systematic training (II)

Motor ability tests in relation to systematic training (II)

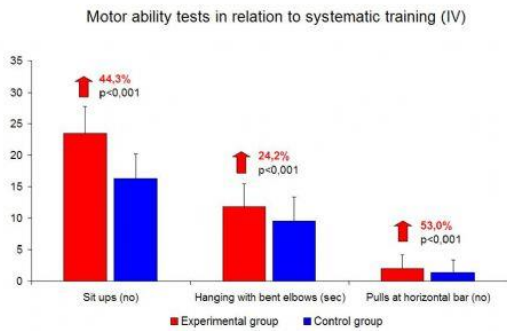


Motor ability tests in relation to systematic training (III)

Motor ability tests in relation to systematic training (III)



Motor ability tests in relation to systematic training (IV)



P-0672

Hyperemesis Gravidarum

Ebru Kender

Department of Family Practitioners University of Medeniyet Göztepe Education and Research Hospital, İstanbul, Turkey

Nausea and vomiting are early and common signs most frequently seen in pregnancy. These symptoms can start in the first trimester and can last until the end of pregnancy and can be seen among %75 of pregnant women. Hyperemesis gravidarum (HG) is a severe form of nausea and vomiting seen in pregnancy, usually described with dehydration, malnutrition and at least %5 loss of the total body weight. The prevalence can change between %0.3 and %2. It is reported that in HG there can be electrolyde and acid-base imbalance, anemia, ketonuria and neurological signs like lethargy and these patients usually need internation. HG influence not only the physical but also mental status and life quality of the pregnant women and cause loss of functionality. Aldought the etiology and pathogenesis of HG has not been clear yet, it is suggested that endocrine and psychological factors are having a role.

In literature it is reported that there can be a relation between HG and psychological illnesses. Studies reveal that HG diagnosed patients have much more mental problems comparing with the control group. It is found out that in patients diagnosed with HG the level of depression and anxiety is higher that the healty pregnant women, pregnants diagnosed with HG show up much more with major depression, anxiety disorder and some personal disorders. Pregnancy is a period where there are worries about the changing body shape and weight and it is proposed that pregnants with eating disorders can hardly tolerate this period. In our study it is aimed to identify the social, demographic and clinic status of patients diagnosed with HG who are hospitalised in women health and birth clinic and also research their eating attitudes and their level of anxiety and depression.

Keywords: hyperemesis, anxiety, eating disorders, depression

nausea



illustration of a woman with hiperemesis gravidarum

P-0673

Vaccination rates of geriatric population: a cross-sectional investigation from Antalya

Ramazan Vural¹, Suzan Yazıcı², Mehmet Özen¹, Hasan Kurşun¹

¹Family Practice Clinic, Antalya Training and Research Hospital, Antalya, Turkey

²Department of Gerontology, Akdeniz University, Antalya, Turkey

BACKGROUND& AIM: The weaker immune system, decreased immune response to vaccinations and a higher incidence of complications from infectious diseases in old age are among factors why vaccination in old age is on the agenda. Pneumococcus, influenza, herpes zoster and tetanus are vaccinations advised for the older population. The aim of the research is to evaluate the vaccination rate of the population 60 years and older and to discuss vaccination at old age.

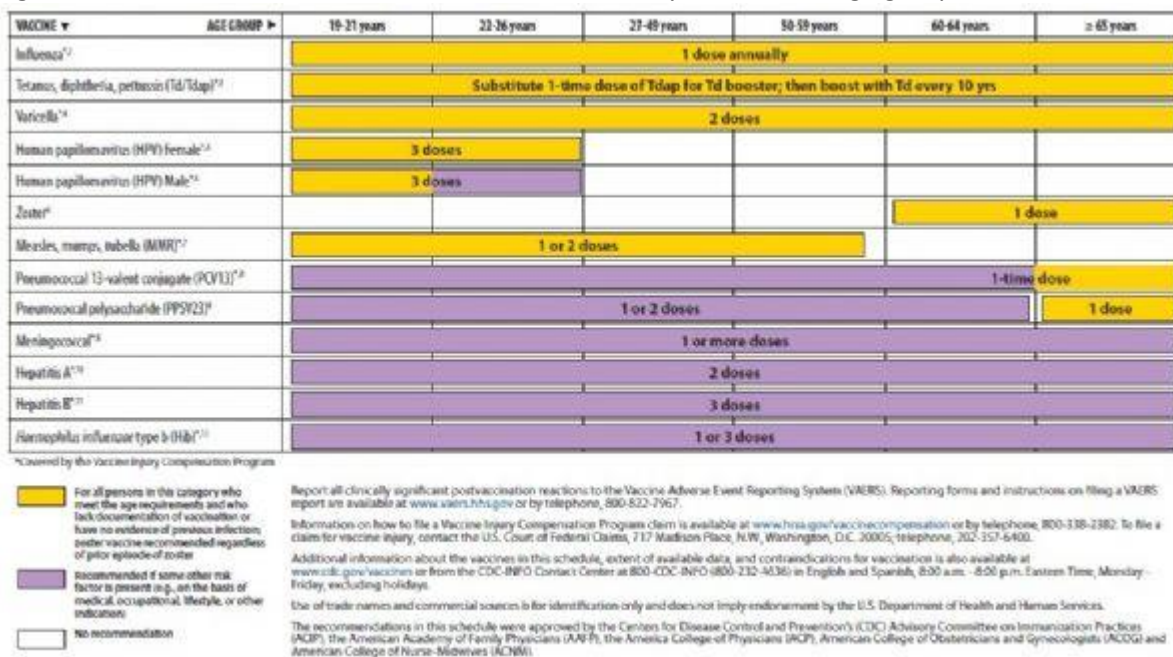
METHOD: The descriptive, cross-sectional and prospective research is using quantitative methodology. 298 persons over the age of 60, who were attending Antalya Training and Research Hospital Family Practice Clinic between December 2013 and February 2014 have been interviewed. Data is analyzed using SPSS software program.

RESULTS: 54% of the respondents were women, and 46% were men. The average age was 69.1. 234 of the respondents were under the age of 75 whereby 64 were 75 years and older. 38.6% of the respondents were vaccinated against Influenza, 10.7% against tetanus and 8.1% against pneumococcus. No correlation has been found between vaccination percentage and education, gender and age. Statistically no significant difference was found for the vaccination rates between the age groups under 75 and 75 and older.

CONCLUSIONS: The vaccination rates for the older population was found to be under the target levels. The rates could be increased sensitizing by informing the older population about vaccination by the health care staff. A higher level of vaccination could enable the society to become immunized.

Keywords: Geriatric population, vaccination

Figure 1. Recommended adult immunization schedule, by vaccine and age group



Source: CDC. Recommended Adult Immunization Schedule – United States – 2015.
www.cdc.gov/vaccines/schedules/downloads/adult/adult-schedule.pdf

Table 1. Vaccination rates by age groups and vaccination status

Vaccination status		Age groups						p (Pearson chi- square)
		60–74 years		75 years and over		Total		
		n	%	n	%	n	%	
Influenza vaccine	Yes	88	37.6	27	42.2	115	38.6	0.505
	No	146	62.4	37	57.8	183	61.4	
Pneumococcus vaccine	Yes	18	7.7	6	9.4	24	8.1	0.661
	No	216	92.3	58	90.6	274	91.9	
Tetanus vaccine	Yes	24	10.3	8	12.5	32	10.7	0.607
	No	210	89.7	56	87.5	266	89.3	

P-0674

Colorectal cancer screening knowledge, attitudes, and practices of family physicians in Samsun, Turkey

Mustafa Kürşat Şahin, Servet Aker

Canik Community Health Center, Samsun, Turkey

Background &AIM: “Colorectal cancer (CRC), which ranks third in cancer morbidity and second in cancer deaths worldwide, can be detected early and prevented with mass screening programs. Family physicians (FP) have a key role in screening practice due to frequent contact with large proportion of population. The aim of our study is to explore the current knowledge, attitude and practice of family physicians toward CRC screening and to identify the barriers of conducting such a screening.

METHOD: A cross-sectional descriptive study was carried out among FP working in family health center in Samsun, Turkey. Self-administered questionnaires which consisted of demographic data, qualification, background on the primary care clinic, practices on colorectal cancer screening and barriers to CRC screening were distributed. Data were analyzed using SPSS 22.0 package program. In the analysis, frequency and percentage from descriptive criteria were used.

RESULTS: The study included 251 FP. There were 87 (34.7%) female and 164 (65.3%) male physicians. The average age of FP were 43.37 ± 6.66 year, average working experience of FP were 18.52 ± 6.57 year, average number of a patients seen per day were 60.47 ± 19.59 . One hundred sixty four (65.3%) physician didn't follow any guideline. Two hundred (79.7%) physician order screening test but half of physicians didn't know correct timing when screening began and stopped. Only 83 (33.1%) FP ordered fecal occult blood test correct frequency and 31 (12.4%) FP recommended colonoscopy every 10 year. The most common barrier stated by FP was “patient refusal”

CONCLUSIONS: This study indicates that CRC preventive activities among primary health care provider is still poor in Samsun, Turkey. Knowledge gaps about the timing and frequency of screening and suboptimal screening delivery were evident.

Keywords: colorectal cancer, screening, family physician, fecal occult blood test, colonoscopy.

P-0675**Prostate cancer screening knowledge, attitudes, and practices of family physicians in Samsun, Turkey**

Mustafa Kürşat Şahin, Servet Aker

Canik Community Health Center, Samsun, Turkey

Background &AIM: The prostate cancer is the second most common cancer worldwide for males, and the fifth most common cancer overall. The aim of this study was to evaluate family physicians' knowledge, attitudes and practice related to prostate cancer screening.

METHOD: A cross-sectional descriptive study was carried out among family physicians (FP) working in family health center in Samsun, Turkey. Self-administered questionnaires which consisted of demographic data, qualification, background on the primary care clinic, practices on prostate cancer screening and barriers to prostate cancer screening were distributed. Data were analyzed using SPSS 22.0 package program. In the analysis, frequency and percentage from descriptive criteria were used.

RESULTS: The study included 244 family physicians. There were 85 (34.8%) female and 159 (65.2%) male physicians. The average age of FP were 43.39 ± 6.74 year, average working experience of FP were 18.54 ± 6.61 year, average number of a patients seen per day were 60.45 ± 19.48 . One hundred thirty three (44.4%) family physicians did not do prostate cancer screening. Almost all didn't follow any guidelines. Hundred fifty three (62.7%) physician order only prostate specific antigen (PSA) and 182 (81.3%) of physicians felt screening was effective. Physicians' most common cause to order PSA was suspicious to prostate enlargement clinical symptoms.

CONCLUSIONS: Prostate specific antigen screening for prostate cancer screening is not uniformly recommended by national organizations or primary care physicians (PCPs). But physician use PSA as a cancer screening tool and didn't follow any guideline. Training may be prepare for family physician related prostate cancer screening.

Keywords: prostate cancer, screening, family physician, prostate specific antigen

P-0676**Cervical cancer screening knowledge, attitudes, and practices of primary health care workers in Samsun, Turkey**

Mustafa Kürşat Şahin, Servet Aker

Canik Community Health Center, Samsun, Turkey

Background &AIM: Cervical cancer is one of the ten most frequent cancers in Turkey. Early diagnosis and treatment is crucial for decreasing the mortality rate in the cervical cancer. The aim of this study was to evaluate of primary health care workers' knowledge, attitudes and practice related to cervix cancer screening.

METHOD: A cross-sectional descriptive study was carried out among primary health care workers (PHCW) working in family health center in Samsun, Turkey. Data were collected by the researcher, applying face-to face structured interview techniques with a questionnaire developed after a relevant literature review. Data were analyzed using SPSS 22.0 package program. In the analysis, frequency and percentage from descriptive criteria were used.

RESULTS: There were 84 (35.3%) nurse, 145 (60.9%) midwife and 9 (3.8%) others. The average age of PHCW was 35.37 ± 6.60 year. Most of them (85%) were married, but only half of PHCW have done pap-smear. 190 (81.2%) of PHCW had heard HPV vaccine, but only 37 (16.7%) of them had known correct dosage. Only three percentage (n: 7) of participant ha heard Kato's self-scraping pap-smear device and 177 (76%) of workers desired to use Kato's device. Nurses and midwives knowledge about cervical cancer was limited.

CONCLUSIONS: Half of PHCW in our population had never had a Pap smear and wanted to use the Kato's device. Training programs can be prepared about cervical cancer for PHCW.

Keywords: cervical cancer, screening, family physician, pap-smear, HPV vaccine

P-0677

Breast cancer screening knowledge, attitudes, and practices of primary health care workers in Samsun, Turkey

Mustafa Kürşat Şahin, Servet Aker

Canik Community Health Center, Samsun, Turkey

Background & AIM: Breast cancer is the most common cancer seen in women, both in developed and also in developing countries, and ranks first in mortalities from cancer. The aim of this study was to evaluate of primary health care workers' (PHCW) knowledge, attitudes and practice related to breast cancer screening.

METHOD: A cross-sectional descriptive study was carried out among PHCW working in family health center in Samsun, Turkey. Data were collected by the researcher, applying face-to-face structured interview techniques with a questionnaire developed after a relevant literature review. Data were analyzed using SPSS 22.0 package program. In the analysis, frequency and percentage from descriptive criteria were used.

RESULTS: Total 228 PHCW participated our study. There were 80 (35.1%) nurse, 139 (61%) midwife. The average age of PHCW was 35.43 ± 6.62 year. 195 (85.5%) of them were married. The prevalence of breast self-examination was 82.9% (n: 189), breast clinical examination was 30.7% (n: 70) and mammogram was 18.4% (n: 42). Fifty (24.1%) of PHCW had heard BRCA1-2 gene mutation test. Nurses and midwives knowledge about breast cancer was limited.

CONCLUSIONS: Health professionals are a direct source of medical information to the public. The use of breast clinical examination and mammography was found lower than expected when considering the fact that participants were health care Professional. Health education programs are essential to encourage and improve PHCWs' practice of breast cancer screening.

Keywords: breast cancer, screening, family physician, breast self examination, mammogram

P-0678

The Turkish Validity and Reliability of Desicinal Balance Scale

Tugba Onat, Dilek Guldal

Department of Family Medicine, Dokuz Eylul University, Izmir, Turkey

Background: There are different types of treatments about obesity like medical, surgery, diets, physical activity. Models for behaviour changes are become popular and studied all over the world. The Transtheoretical Model is a paradigm for behavior change in individuals and is the theory that guided this project. It has been used as a method to determine individuals' readiness to change behaviors. The constructs or framework of the TM include: the Stages of Change, Self-efficacy, Decisional Balance, and Processes of Change. We realised that there is no turkish version of the desicinal balance scale. And we decided to establish the Turkish validity and reliability of desicinal balance scale, validity and reliability of which was proven and used the most frequently among the scales that assess TTM.

METHODS: The design of this study was methodological translation and re-translation is performed. After face and content validity cigarette used for criterion validity.

Test-retest, Split-half, Cronhbach-alfa used for reability.

Analysis of data was performed in SPSS 15.0 program

RESULTS: 100 participants who are obes and cigarett smokers were participated the study. Obesity decisional balance scale total score and smoking cigarette decisional balance scale total score correlation was $r=0.289$ $p=0.017$. For the internal reability Cronbach-alfa was 0.715.

For the test re-test was applied to 30 participants and test re-test correlation was $r=0.978$ $p=0.00$.

Conculisition: these results revield that desicinal balance scale is valid and reliabile in Turkish language.

Keywords: obesity decisional balance self efficacy validity reability

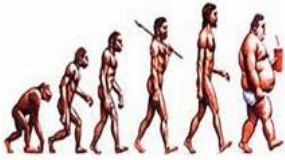


figure2



corelation of decisional balance

pearson r

obesity cigarette decisional balance scale ,289 p <0,05

Pozitif results decisional balance scale ,247 p <0,05

Test re-test corolation

	Test	Re-test
Test	1	,978
Re-test	,978	1
	p <0,05	p <0,05

P-0679

Stroke: People can recognize the symptoms and come to the health center at the right time ?

Hector Leonardo Lugo Ramos, Rocio Lobato Martinez, Jose Maria Fernandez Gonzalez
Hospital Jerez de la Frontera - Cadiz

OBJETIVES

To assess the degree of information and knowledge of the people against stroke as common pathology in our environment. Assess the degree of education in recognizing symptoms, initial acting or therapy against stroke.

METHODS

Survey written and/or directed telephone about stroke in patients who went to a health center or a hospital emergency room, regardless of the reason for your request. The survey asks about sex, age, warning signs of stroke and to conduct take.

RESULTS

A total sample of 154 patients, found that 31% of respondents do not know the warning signs for stroke (similar results with both sexes with an average age of 53.5 years old). Of those who did know recognize 5% administer

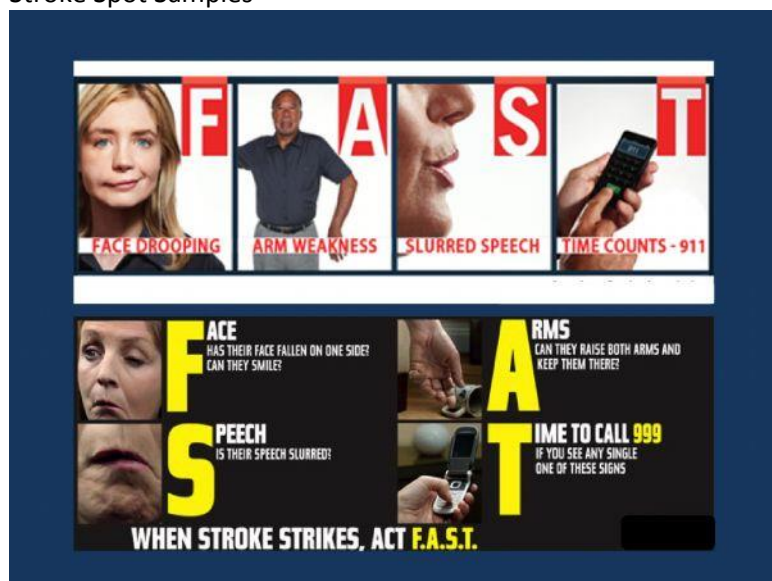
any medication(antihypertensive, antiplatelet). 48% emergency call, 42% would go directly to the hospital, 7% expect at home to see if symptoms were improved and the remaining 3 % would go to the nearest health center.

CONCLUSIONS

Despite the many education campaigns and development of information held among the public, stroke remains a disease whose initial symptoms are not widely recognized by the population. By contrast, the user does know detect symptoms also knows he must act quickly to optimize the treatment of this disease. That is why we must continue working on all levels, mainly from primary care in patient education to comprehensive care effectively start within the first hours after a stroke.

Keywords: Stroke, Health Education, Primary Care.

Stroke Spot Samples



P-0680

Use of inhibitors of the dipeptidyl-peptidase-4 (idpp-4) in diabetic patients in primary care

Jose María Fernandez Gonzalez¹, Hector Leonardo Lugo Ramos¹, Inmaculada Saucó Colon²

¹HEALTH CENTER OF LA GRANJA-MANUEL BLANCO, HOSPITAL OF JEREZ DE LA FRONTERA.

²HEALTH CENTER OF SAN BENITO, HOSPITAL OF JEREZ DE LA FRONTERA.

OBJECTIVE

To evaluate the use of inhibitors of the dipeptidyl-peptidase-4 (IDPP-4) in diabetic patients in primary care and its impact on the reduction of glycosylated hemoglobin.

MATERIAL AND METHODS

Cross-sectional study using data collection of the medical history. Were selected to all diabetics of a urban health center take IDPP-4, either alone or associated with other antidiabetic agents, excluding 10 due to lack of registration of the glycosylated hemoglobin.

RESULTS

Were selected 326 diabetic patients, of whom 52.1 % were male and 47.9 % women. The mean age was 66.6±11.5 years. The 84% also took metformin, sulfonylureas 25.8 per cent, 4.3 per cent glinidas, the 1.5 % thiazolidinediones, the 0.6 % inhibitors of the alpha-glucosidase inhibitors, and the 21.5 % insulin. Of the IDPP-4, 60.7 % were taking sitagliptin, the 32.5 % vildagliptina, the 3.7 % linagliptina, and 3.1 % saxagliptina. The average

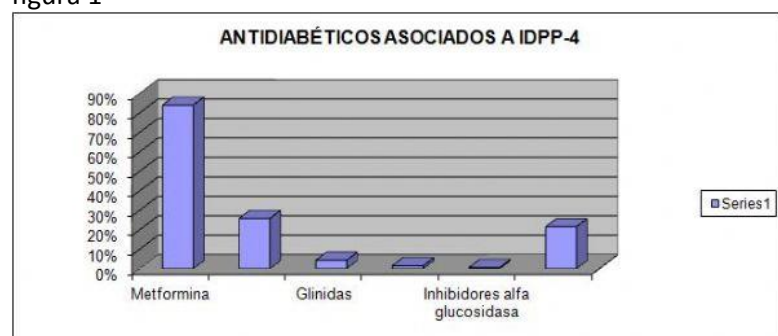
number of glycosylated hemoglobin before treatment with IDPP-4 more metformin was 8.1 ± 0.9 and the current 7.7 ± 1.2 , with an average reduction of glycosylated hemoglobin of 0.32 (95% CI: 0.16 -0.49, $p=0.06$), being less than the reduction in the IDPP-4 associated with other antidiabetic agents (0.09, 95% CI: 0.07 -0.12, $p>0.08$). These results are somewhat lower than those described in clinical (reduction of around 0.40 % -1.05% of glycosylated hemoglobin. The time of treatment with IDPP-4 was less than 1 year in the 33.8 %, 1-2 years in 36.9 %, 2-3 years in 24.6 % and more than 3 years at 4.7 %, no differences were found between the groups.

CONCLUSION

The use of IDPP-4 associated with metformin decreases a 0.32 average in the glycosylated hemoglobin, although this result is not statistically significant. More studies are needed to obtain findings with greater reliability.

Keywords: DIABETES, Treatment, PRIMARY CARE

figura 1



P-0681

Retinography in primary care

Jose María Fernandez Gonzalez¹, Hector Leonardo Lugo Ramos¹, Pedro Guijo Gonzalez²

¹HEALTH CENTER OF LA GRANJA-MANUEL BLANCO, HOSPITAL OF JEREZ DE LA FRONTERA.

²INTENSIVE CARE UNIT HOSPITAL OF JEREZ DE LA FRONTERA

OBJECTIVE

To determine the usefulness of the Primary Care retinography interpreted by family doctor as a tool in early diagnosis of glaucoma.

MATERIAL AND METHODS

Study made in Primary Health Care in collaboration with specialized care, with $n=196$ (comprehensive study conducted in 194 patients; losses: 2 (not came to perform the tests),

Sectional and descriptive study with assessment by two observers in parallel, comparing interpretation by family physicians in color fundus photographs made in Primary Care with the study of ophthalmologists.

Inclusion criteria: diabetics, between 40-70 years and hypertensive; of exclusion: does not meet the previous, diagnosis of known Glaucoma and/or non-availability of retinography assessable.

Dependent variable: diagnosis of chronic glaucoma (qualitative and dichotomous nominal); independent: excavation papillary, age, sex. Validity of the test from sensitivity, specificity, interobserver concordance (index Kappa and quotient correlation), positive and negative predictive values, positive likelihood ratio and negative, calculated by SPSS 15.0.

Possible limitations: lack of specific computing tools of measurement papillary, small sample, evolutionary nature of glaucoma, low prevalence of glaucoma.

RESULTS

Of n=194: 91 females and 103 males. Incidence of glaucoma of 3 %, intraclass correlation coefficient and kappa index moderate, with higher interobserver correlation for assessable qualitative quantitative, high specificity (right eye OD= 93 %, left eye OI=93.1 %), negative predictive value (OD 93.5 %, OI 97 %) and positive likelihood ratio (OD 3.05;OI 5.35), good for screening tests; low sensitivity (OD21.4 %;OI37,5 %), positive predictive value (OD and OI20 %) and negative probability quotient (OD 0.8;OI0,67).

Conclusion

Retinography may be a good tool for screening for glaucoma by being very specific with positive probability quotient high and low false-negative rate.

Keywords: Primary Prevention, RETINA, PRIMARY CARE

P-0682

An Irritant Contact Dermatitis Caused By Buttercup: A Case Report

Selman Erturhan¹, Ali Ramazan Benli², Muhammet Ali Oruç³, Senay Demir Yazıcı⁴, Hilal Ozkaya⁵

¹Altinyayla Hospital, Altinyayla, Sivas, Turkey

²Department of Family Medicine, Medical Faculty, Karabuk University, Karabuk, Turkey

³Turkish Medicines and Medical Devices Agency, Ankara, Turkey

⁴Department of Physical Examination and Rehabilitation, KBU Karabuk Education and Research Hospital, Karabuk, Turkey

⁵Department of Family Medicine, IBB Darulaceze Nursing Home, Kayisdagi, Atasehir, Istanbul

A 69 years old woman applied our policlinic because of the wounds in her both legs. The patient was asked how those injuries happened. The patient had had knee pain for a long time and the pain killers didn't help her, so she applied some buttercup which she grinded with a method which she had learned from her mother on her legs and covered them with pieces of muslin a day ago. When she uncovered her legs after an hour, she realized the injuries on her legs. According to the results of physical examination of the patient, all of the vital symptoms were stable, lab findings were also normal except for the level of plasma glucose and triglyceride. She was under the treatment of hipertansion and hyperlipidemia. There was a swollen erythema plague on her right leg and there was a erythema plague whose edges were livid and upside was yellow. Wounds were cured with topical fusidic acid treatment for 2 weeks and fomentation was done every day. When we asked the patient if the treatment which she had applied helped her knee pains or not, her answer was 'a little bit'.

The samples of the plant which was supplied from the patient were defined as *Ranunculus illyricus* L. Many people use plants like Ranunculaceae family as traditional treatments. *Ranunculus* (buttercup) is named in Sivas and in Turkey as 'dügün çiçeği'. Ranunculaceae contains the lactoneranunculin, and when fresh plants are bruised, ranunculin is converted to the irritant protoanemonin.

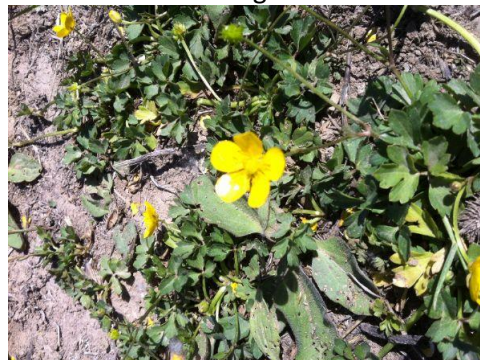
In conclusion, plants applied to the skin may show positive effects on some dermatological and rheumatic diseases, but they may also have many adverse effects. Anamnesis should include informations about alternative treatment methods.

Keywords: Buttercup, Contact Dermatitis, Ranunculin

Figure1



Figure2



P-0683

Adherence to Medications for Tobacco Dependence Factors Associated with Discontinuation of Bupropion and Varenicline

Selman Erturhan¹, Ali Ramazan Benli², Muhammet Ali Oruç³, Pınar Kalpakçı⁴, Mustafa Cortuk⁵, Yeltekin Demirel⁴

¹Altinyayla Hospital, Altinyayla, Sivas, Turkey

²Department of Family Medicine, Medical Faculty, Karabuk University, Karabuk, Turkey

³Turkish Medicines and Medical Devices Agency, Ankara, Turkey

⁴Department of Family Medicine, Medical Faculty, Cumhuriyet University, Sivas, Turkey

⁵Department of Chest Disease, Medical Faculty, Karabuk University, Karabuk, Turkey

Background & AIM: We aim to determine the factors which affect the level of regular usage of varenicline and bupropion and the factors which affect the adherence to those two drugs, so we'll find how those situations affect the success of the treatment.

METHOD: The working group consisted of 413 university staff, who are amongst people who had applied to our 'smoking cessation clinic' between March and October in 2011. A face-to-face survey was conducted after 1-year following the day of quitting. As success criteria the oral confession of patient and exhaled carbonmonoxide(CO)<5ppm were deemed. The data was analysed by SPSS-20-software. The significance decisions were given as $p < 0,05$. According to the property of comparison, one of the following significance tests was used: independent-samples t test, paired-samples t test, Mann-Whitney U test, chi-square test.

RESULTS: 16 patients never used the drugs they had taken (3,95%). The rate of the people who used the drug ≥ 45 days was 35,7% for varenicline and %11,2 for bupropion ($p=0,000$). The patients who had used their drug ≥ 45 days were more successful. The most frequent reasons of discontinuation the medication were side effects (31,5%), feeling that they didn't need medication anymore (17,2%) and not witnessing any benefit of the drug (9.3%). The rate of interrupting the medication since the patients didn't need the drug any more was much more in the group of patients who used varenicline($p=0,005$) and the rate of interrupting the medication since the patients didn't witness any benefit of the drug was much more in the group of patients who used bupropion ($p=0,022$).

CONCLUSIONS: ≥ 45 days usage of smoking cessation drugs increases the success. Studies must be carried out to improve the patients adherence to treatment to increase smoking cessation rates.

Keywords: Tobacco Dependence, Bupropion, Varenicline

Table 1. Time Period of Drug

Time Period of Drug	Used Drug	%
Never used the drugs		3,95%
Used the drug ≥ 45 days	Varenicline	35,7%
	Bupropion	11,2%
Used the drug < 45 days		49,15%
Total		100%

Table 2. The reason for used drug < 45 days

Cause used the drug < 45 days	%
Side effects	31,5%
Feeling that they didn't need medication anymore	17,2%
Not witnessing any benefit of the drug	9.3%)
Others	42%
Total	58%

P-0684

Family doctor - A Pillar in the Education and Trainings of Patients Suffering from Diabetes Mellitus type 2

Elizabeta Tome Bozhinovska

Private Health Facility " PZU. Dr. Beti", Bitola, Republic of Macedonia

AIM: Evaluation of the education and training of DM type 2 patients

METHODOLOGY: It was conducted a twelve month monitoring on a total of twenty-two newly diagnosed Diabetes Mellitus type 2 patients, among which, 10 of the patents were male and 12 female, at the age of 41 to 67 years. Glycolic and lipid indicators, blood pressure, BMI and abdominal fat were monitored during this research.

RESULTS: The results shown in 32% of the cases, there was a need for second anti diabetic. The troubling thing was establishing of artery-hypertension by setting up 52% diagnose on diabetes type 2. Antihypertensive therapy is recommendable in the first 6 months. In the first 6 months achieved goal values on the blood pressure only at 32% of the patients, from which the recommendation on using second anti hypertension medicine or combined therapy stems. The improvement of the lipid indicators especially on the HDL cholesterol is achieved at the end of the education and training, where the proper nutrition and the hygienic advices come in action. When it comes to the BMI (Body Mass Index) we have experienced the slowest alterations.

After 12 months we have observed slight improvement of the BMI. The results are:

- 47% had BMI up to 25 kg/m²
- 41.2% had BMI up to 29.9 kg/m²
- 11,8% had BMI up to 39,9 kg/m²
- 7% had BMI above 40 kg/m²

CONCLUSION

The family doctor plays central role in the training and education in the cases of patients with newly discovered diabetes mellitus type 2, in order to achieve better metabolic control. The aim is to motivate the patients to comply to certain diet and a life style, through which they will decrease their fat and at that way will decrease the risk from secondary complications that stem from the diabetes.

Keywords: Diabetes, Patients, Research, BMI, Hypertension

P-0685

A Preliminary Study on Awareness, Perceptions and Related Factors Affecting Family Physicians' Practices on Electronic Cigarettes

Ozlem Tanriover¹, Seyhan Hidiroglu², Pinar Ay²

¹Department of Family Medicine, Yeditepe University, Faculty of Medicine, Istanbul, Turkey

²Department of Public Health, Marmara University School of Medicine, Istanbul, Turkey

Background and AIM:

Electronic cigarettes are devices that provide a battery-powered heating element to transform nicotine solution into vapour. Evidence shows the rapid increase of the popularity of e-cigarettes, although they are not FDA approved as quit smoking devices. Despite the expectation that family physicians encourage and orchestrate the smoking cessation efforts of their patients, there may be persistent uncertainty regarding the physician's precise role in managing the nicotine addicted patient. New developments in nicotine addiction and smoking cessation as with the emergence of the electronic cigarettes, add some measure of complexity to the clinician's important role in directing patients' smoking cessation efforts. In this study, our aim was to determine the family physicians knowledge, attitudes and behaviors on e-cigarettes and to clarify the factors affecting them.

METHOD:

A semistructured questionnaire consisting of 37 questions was prepared and distributed to 250 FPs. Questions mainly focused on demographic characteristics, knowledge and own use of electronic cigarettes, general attitudes against e-cigarettes, and daily practices while performing counselling on tobacco use.

RESULTS:

The mean age of the study participants was 42.1 ± 7.5 years. One-fourth of the physicians (24.1%, n=48) stated that they did not inquire about the amount of tobacco use. Moreover, 69.2% (n=137) believed that they did not receive adequate smoking cessation training. One hundred and eighty (n=88.2%) physicians have heard of electronic cigarettes and 61.2% (n=125) stated that electronic cigarettes were healthier than tobacco cigarettes and furthermore 55% (n=112) believed that risk of cancer was lower in electronic cigarettes users.

CONCLUSION:

Family physicians feel inadequate in their smoking cessation training and knowledge on electronic cigarettes. They should counsel patients based on their reported tobacco and their e-cigarette use behaviors and interests. In order to do this, family physicians should be trained about new developments in nicotine addiction and smoking cessation.

Keywords: Electronic cigarettes, smoking, family physicians,

P-0686

Slovenia National Programme on NCDs Prevention at Primary Healthcare

Pia Vracko, Breda Cus, Sanja Vrbovsek, Jozica Maucec Zakotnik

Center for Management of Preventive and Health Promotion Programs, National Institute of Public Health, Ljubljana, Slovenia

Background&AIM: Chronic non-communicable diseases represent a major burden of disease in Slovenia. Cardiovascular diseases are the leading cause of mortality in 2012, accounting for 39% of all deaths (men 32%, women 46%), followed by cancer (30%, men 35%, women 26%) and respiratory diseases (7,2% for both genders). Their common risk factors can be successfully addressed by support for healthy lifestyles at the primary healthcare level.

METHODS: Prevention and control of NCDs, including cardiovascular diseases, diabetes, and chronic respiratory diseases, has been carried out in Slovenia at the primary health care level since 2002 as systematic and universally accessible program. In 2011 it was upgraded to introduce registered nurses to deliver preventive services. Target population are adults above 30 years. Key components are screening for NCDs and their risk factors, and nonpharmacological support to lifestyle change, delivered by specially trained experts in 61 Health Education Centres across Slovenia. The program includes workshops for healthy weight loss, healthy diet, physical activity, quit smoking and alcohol consumption, and support in dealing with depression. The aim is to encourage individuals to actively taking care of their health, by gaining necessary skills, and by developing appropriate behavioural patterns for healthy lifestyle.

RESULTS: Over one million persons have been screened for NCDs over more than 10 years and over 350.000 people participated in program to support lifestyle change. In the last twenty years, the number of deaths from all types of CVDs halved in Slovenia. Compared to year 2000, the number of deaths from these diseases is reduced by around 1,200 annually. Since 2009, the leading cause of death in men is cancer and CVDs in women.

CONCLUSIONS: National programme on integrated NCDs prevention in Slovenia is successful at reducing the burden of NCDs, however the fraction attributable to preventive program still needs to be determined.

Keywords: non-communicable diseases, prevention, healthy life-style

Figure 1: Number of health education workshops and cumulative number of participants in program to support lifestyle change at primary healthcare level in Slovenia, 2002 - 2013

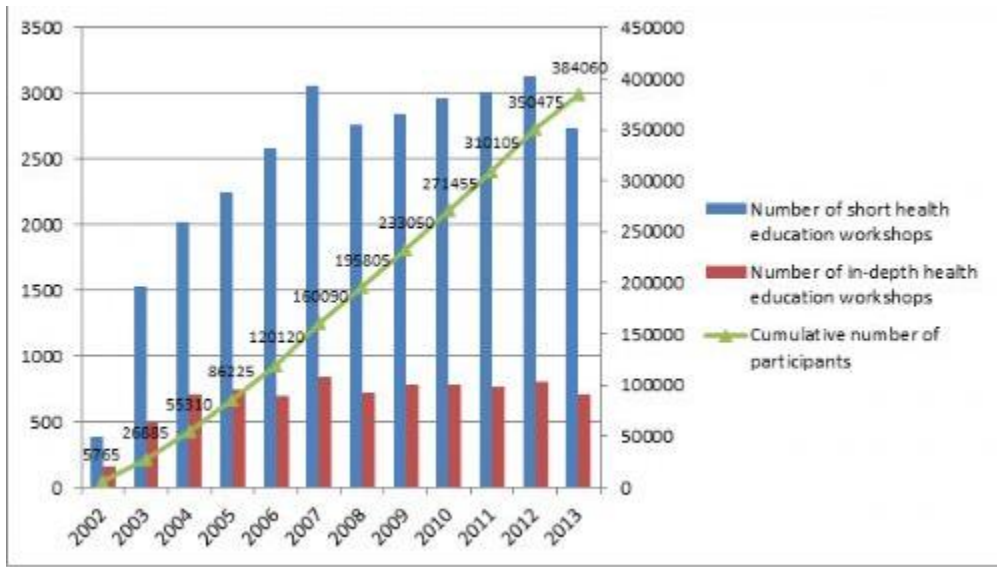
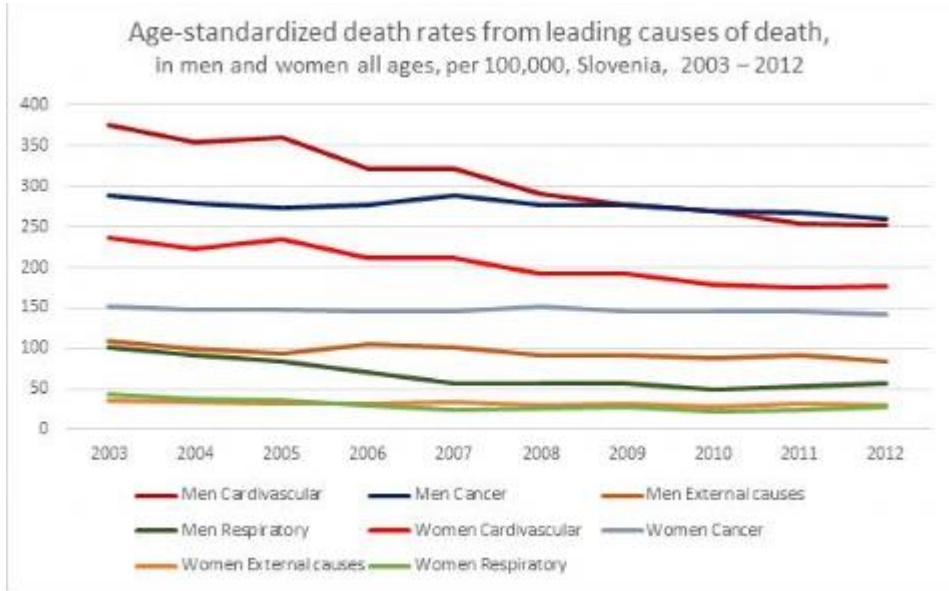


Figure 2: Age-standardized death rates from leading causes of death in men and women all ages, per 100,000, Slovenia, 2003 - 2012



P-0687**Evaluation of Blood Pressure Differences Between Both Arms of Smokers**

Gulumser Kir Dogru, [Bektas Murat Yalcin](#), Mustafa Unal
Department of Family Medicine, Ondokuz Mayıs University, Samsun, Turkey

Background & AIM: Cigarette smoking and elevated blood pressures are among the most important risk factors for CVD. Although it is recommended that blood pressure measurements should be taken at both extremities, this practice is not used routinely by many clinicians. There are accumulating data that discordance between two extremities had important clinical outcomes. The aim of this study was to investigate this difference in smokers. **METHOD:** This as a cross-sectional and retrospective study. 500 participants who admitted to the Ondokuz Mayıs University Family Medicine Smoke Cessation Clinic between June 2011 and June 2012 were included in the study. Two consecutive blood pressure measurements from both limbs were recorded in their first application. Their demographic, anthropometric measurements (BMI and waist circumference) and smoking features were also investigated. Discordance between their systolic (SBP) and diastolic blood pressure (DBP) measured in both limbs were investigated.

RESULTS: The mean right arm SBP was 111.49 ± 15.2 and DBP was 69.80 ± 11.77 mm Hg while left SBP was 109.68 ± 14.9 and DBP was 68.63 ± 11.43 mm Hg respectively. There was no difference between two limb SBP measurements in 33.2% of the participants (n = 166) however 34.2% of the participants' (n = 178) had >10 mm Hg difference between two arms. The regression analysis shown that to start smoking at an early age (<18) is an independent risk factor for difference between >10 mm Hg in SBP ($p < 0.001$, 95% CI; 0.101-0.345) and in DBP ($p = 0.002$, 95% CI; 0.101-0.345) in both arms.

CONCLUSION: We found that an important percentage of the patients had >10 mm Hg difference of blood pressure in their both arms. These patients might need more cardiovascular evaluation. Bilateral blood pressure measurement should become a routine part of the evaluation of cardiovascular examination in the primary care.

Keywords: Primary health care, blood pressure smoking cessation

P-0688**The Compliance of the Ex-Smokers to Recommendations about Diet and Exercise**

Gulumser Kir Dogru, [Bektas Murat Yalcin](#), Mustafa Unal
Department of Family Medicine, Ondokuz Mayıs University, Samsun, Turkey

Background & AIM: Smoking is the most leading cause of the preventable deaths in the world. Many times the backbone of smoking cessation therapy and preventing recurrence depends on several life style changes including weight control. The aim of our study is to investigate the compliance of diet and exercise life styles of the smokers who underwent smoking cessation treatment.

METHOD: In order prevent weight gain after cessation every smoker received recommendations about diet and exercise (In a personalized structured session lasting at least 25 min.) as a part of their treatment (motivational interview, nicotine replacement therapy, drugs or combination of them) at Ondokuz Mayıs University Family Medicine Smoking Cessation Clinic. 460 smokers who admitted to our clinic between the dates of June 2012 to June 2013 were phoned and 335 patients who agreed to participate this study were investigated about their compliance of diet and exercise recommendations.

RESULTS: 42.4% (n=142) of the participants were female, with a mean age of 40.1 ± 9.8 years. The mean Fagerström Nicotine Dependence Test score of the participants was 5.8 ± 2.43 , with no statistical difference between genders. The male smokers had higher mean package / year of (24.1 ± 12.0) compared with female smokers (19.3 ± 11.3) ($t=3,675$, $p < 0.0001$). The cessation rate in two years was 16.1% (n= 54). Regardless of the smoking status (ex-smokers, smokers and recurrent smokers) most of the participants (n=283, 84.5%) claimed that they didn't make any increase in their physical activity or controlled their diet in two years period ($p > 0.05$). Ex-smokers weight was increased ($F=64.642$, $p < 0.001$) and they concluded that their daily calorie uptake was increased ($\chi^2=119.887$, $p < 0.001$) in this period.

CONCLUSION: Although every ex-smoker had recommendations about weight management, their weight was

increased in two years period. Ex-smokers must be screened more frequently and carefully in order to prevent weight gain.

Keywords: health care, smoking cessation, health promotion, weight gain

P-0689

Screening behaviours and awareness of breast, cervical and colon cancer among nurses in an urban hospital of Turkey

Ahmet Gürhan Poçan¹, Gonca Çoban², Çiğdem Gereklioğlu¹, Süheyl Asma¹, Altuğ Kut³

¹Department of Family Medicine, Baskent University School of Medicine, Adana, TURKEY

²Department of Obstetrics and Gynecology, Baskent University School of Medicine, Adana, TURKEY

³Department of Family Medicine, Baskent University School of Medicine, Ankara, TURKEY

BACKGROUND & AIM

Nurses constitute the group of health workers who can provide information to the women on cancer. The lack of a regular screening programme for and the low rate of BSE and MMG for breast cancer and pap smear for cervical cancer in Turkey led us to perform this study.

The purpose of the study was to assess knowledge, awareness and attitudes about breast, colon and cervical cancer risk factors, symptoms and screening behaviours among nurses at the university setting in a urban region of Turkey.

METHOD

The study was conducted as a cross-sectional survey among nurses working in Başkent University Adana Hospital. The survey was designed to investigate the demographic characteristics of the nurses and their knowledge on risk factors of these cancer forms and to reveal the awareness of symptoms and attitudes in screening programmes. Participants are informed about the study, after their agreement the questionnaire applied. Data was evaluated using the SPSS for Windows. All tests were two-sided and differences were considered significant when p is <0.05.

RESULTS

The study have shown that nurses who knew well about symptoms, risk factors and screening methods of cancer were more likely to use breast and cervical cancer screening methods.

CONCLUSIONS

In fact, nurses do not have a primary role in the education about the cancer risks and prevention as well as screening methods; however, they have been chosen for this study for two reasons; they were expected to have higher knowledge about cancer due to highly scientific working conditions than counterparts working outside the university hospital and the second reason was the fact that women in our country feel nurses more closely to ask something about the sex specific cancers such as breast and gynecological cancers. Thus, they can constitute a model of health promotion for women.

Keywords: Cancer screening, health behavior, nurse education

Table 1

Department	N	%
Internal diseases	43	25,1
Surgery	66	38,6
Gynecology and obstetrics	10	5,8
Pediatrics	52	29,8
Total	171	100

Table 2

Domain of scale	N	Mean score	P value
Being confident knowledge about cancer screening tests	61	49,26	0,045
Recommendation attitude about screening tests for patients, family members and friends	134	48,39	0,011
considering importance for their profession about cancer screening	158	47,94	0,057
Occupational department			
Internal diseases	43	46,85	0,766
Surgery	66	47,94	0,875
Gynecology and obstetrics	10	46,44	0,430
Pediatrics	52	48,36	0,120
Previous malignant disease and family history of malignant disease	47	47,49	0,827

P-0690**Factors affecting people's capacity for self-control in smoking cessation**

Esra Zengin¹, Adem Bahadır², İsmail Kasım³, İrfan Şencan³, Rabia Kahveci³, Adem Özkara⁴

¹Department of Family Physician, Dr. Fahrettin Uğur Refahiye State Hospital, Erzincan, Turkey

²Department of Family Physician, Rize Kalkandere State Hospital, Rize, Turkey

³Department of Family Physician, Ankara Numune Research and Teaching Hospital, Ankara, Turkey

⁴Department of Family Physician, Hitit University Çorum Faculty of Medicine, Çorum, Turkey

BACKGROUND & AIM: Smoking leads to the preventable death of 5.4 million people every year. In the group of people who can not quit smoking the ability of coping with problems is worth exploring. The aim of this study is to investigate self-control attitudes of patients and effects on smoking cessation.

METHODS: This study includes 158 patients in three groups who applied to family medicine outpatient clinic in 2015. A questionnaire to investigate sociodemographic characteristics was admitted to the patients with a self-control questionnaire. Three groups consists of non-smokers, smoking quitters and non quitters.

RESULTS: 102 of 158 included patients were smokers. 54.9% of smokers had physical ailment. The rates of smoking cessation was 50%. Older age, male sex, having 3 or more children, education and physical ailment were determined to be associated with quitting smoking. In the patients who quit smoking points that belong to self-control and components were higher compared to patients who did not quit. According to the regression analysis results; in Model-I while self-control (OR=1,102, p=0,001), being male (OR=9,763, p=0,014), having university graduate (OR=0,188, p=0,035) and having physical ailment (OR=33,756, p=0,001) are effective factors in quitting smoking, according to the Model-II experiential self-control (OR=1,205, p=0,001), regenerative self-control (OR=1,163, p=0,001), being male (OR=25,482, p=0,002), having university graduate (OR=0,056, p=0,001) and having physical ailment (OR=53,629, p=0,001) were determined as effective factors in quitting smoking.

CONCLUSION: Family physicians have an invaluable role in helping a smokeless society. Interventions to increase self-control among members of the society seem to be effective in reducing smoking rates.

Keywords: smoking, self-control, schedule

P-0691

General Health Conditions and Smoking Habits of Firefighters in Ankara

Gizem Bilgin, Tijen Sengezer, Adem Ozkara, Gamze Bal Erbas

Department of Family Medicine, Ankara Numune Training and Research Hospital, Ankara, Turkey

OBJECTIVE

In this study, the aims are stating the medical conditions of firefighters a risky occupational group, investigating smoking behaviors and advice to policy makers for making their health conditions better.

METHOD

This is an observational and descriptor research. All of 881 firefighter who apply ANEAH Sıhhiye Family Medicine Polyclinic for routine medical screening are involved in the study. Medical records of the fire officers are taken by the face to face and detailed examination forms including occupational and smoking histories, chronic illnesses are filled in.

RESULTS

98.3% of firefighters were male (n=774), 1.7% were female (n=13) from the 787 firefighters who are participated in the study. The average age 43.6, average height is 173.4 cm, average BMI has been found 27.3. The average working time in fire department is 16.7 years. 33.9% of firefighters (n=267) have disease that diagnosed previous. 31,5 % of firefighters (N=248) have had an operation. 17,9 % of firefighters (N=141) have had an occupational accident, had been injured. Smoking rates in firefighters is 48'4% (n=381). The rate of quit smoking is 24,3 % (N=24,3). The rate of thinking about quit smoking is 63,2% (N=239). 75,3% of smokers (N=283) has tried to quit smoking before. 27,4% of firefighters (N=216) do exercise regularly.

CONCLUSION

An action plan to improve the health of firefighters should be established.

Family physicians should take preventive measures to improve firefighter health and should monitor firefighter with chronic diseases. Firefighters should be encouraged to contact their family physician.

Firefighters with the highest smoking rates(%48) compared with the average of Turkey (TÜİK 2012, 28%; %41 man, %18 women) should be encouraged to quit smoking.

The food quality at workplace and diet of firefighters which have the rate of obesity as 21% have to be increased. Firefighters should be encouraged to make exercises and sports activity.

Keywords: Firefighters, Health Conditions, Smoking Habit, Ankara

Ankara



Ankara Fire Department

Istanbul



1908 After Great Istanbul Fire

Illnesses

Illnesses (N=267)		
	Number(n)	Percentage (%)
DM	46	17,2
HT	62	23,2
HL	16	6
CAD and other cardiovascular diseases	27	10,1
Chronic HepB	18	6,7
Herniated disc	27	10,1
Reflu, gastritis and other GIS diseases	25	9,4
Dermatologic disorders	13	4,9
KOAH, asthma, bronchiectasis	24	9

Diseases that diagnosed previous

P-0692

Inflammation and Novel Atherogenic Markers in Nondiabetic Obese Patients: Neutrophil to Lymphocyte Ratio, Atherogenic Index of Plasma

Ozlem Cigerli¹, Asli Dogruk Unal², Hulya Parildar¹, Nilay Ergen³, Ozlem Tarcin², Betul Ugur Altun², Nilgun Guvener Demirag²

¹Department of Family Medicine, Baskent University, Istanbul, Turkey

²Department of Endocrinology, Baskent University, Istanbul, Turkey

³Department of Physiology, Baskent University, Istanbul, Turkey

Background & AIM: Inflammation plays a key role in obesity and atherosclerosis. We aim to assess the relations between Framingham risk score (FRS) and Hs-CRP, ferritin, neutrophil to lymphocyte ratio (NLR), Atherogenic Index of Plasma (AIP) for evaluation of inflammation and subclinic atherosclerosis in nondiabetic obese patients with no history of coronary heart disease or stroke.

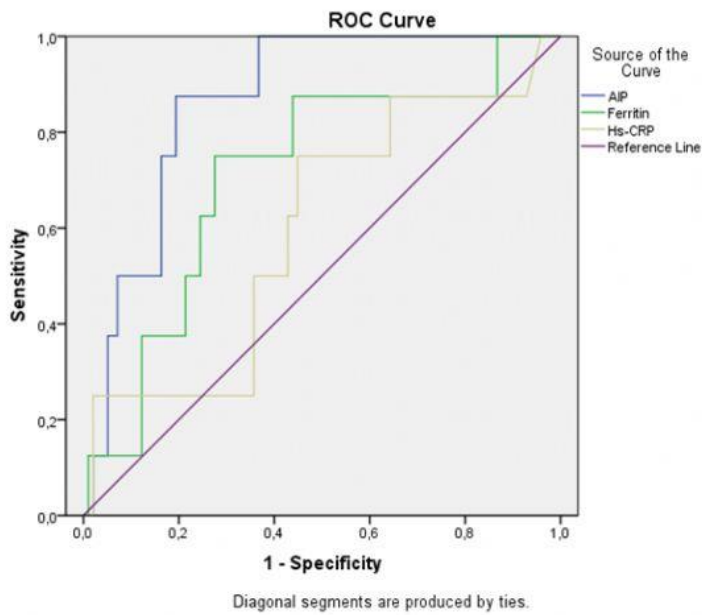
METHOD: In this study included 185 nondiabetic obese patients and 90 age-sex matched normal weight healthy controls. Blood cell count, differential leukocyte count, Hs-CRP, ferritin, lipids and other parameters were measured. Logarithmic ratio of triglycerides to HDL was defined as AIP. ROC curves conducted to evaluate the performance of the inflammation variables in detecting FRS \geq 10% for study population at moderate to high cardiovascular disease risk.

RESULTS: The mean age of the obese patients was 37.8 \pm 10.7 years (range 17-55) and female patients were 64.3 % (n=119). Mean BMI was in obese patients 35.6 \pm 5.6 and 22.9 \pm 2.2 in controls (p<0.001). Mean serum, ferritin, Hs-CRP levels, neutrophil and platelet count, NLR, AIP and Framingham risk scores of obese patients were significantly higher than controls. Framingham risk scores, AIP, ferritin were significantly higher in obese male patients than obese female patients. Positive correlations were found between BMI and platelet, neutrophil, and lymphocyte Hs-CRP, ferritin, Framingham risk score, NLR, AIP, levels. The ROC analysis demonstrated AIP which has an area under the curve of 0.841, has a high performance in detecting cardiovascular risk according to the Framingham scale (\geq 10%).

CONCLUSIONS: Novel biomarkers as NLR, AIP appear to be related with Hs-CRP levels and useful as inflammatory markers for evaluation in clinical setting. These markers are also inexpensive, cost-effective, simple applicable, and universally available tests. Framingham risk score is significantly higher and also AIP may contribute as a considerable marker for prediction of subclinic cardiovascular risk in nondiabetic obese patients.

Keywords: Obesity, Inflammation, Atherosclerosis, Blood Count

Figure 1



ROC curves for Hs-CRP, ferritin, and AIP variables in detecting Framingham risk score ($\geq 10\%$).

Table 1

	Control Group (n=90)	Obese Group (n=185)	<i>p</i>
Age (years, mean \pm SD, range)	36.9 \pm 10.1 (19-55)	37.8 \pm 10.7 (17-55)	0.541
Gender (F/M, n)	67/23	119/66	0.060
BMI (kg/cm ²)	22.9 \pm 2.2	35.6 \pm 5.6	<0.001
Systolic blood pressure (mmHg)	116.6 \pm 12.3	131.9 \pm 18.3	<0.001
Diastolic blood pressure (mmHg)	74.9 \pm 7.7	82.8 \pm 9.6	<0.001
Family history of diabetes (n,%)	48 (53.3)	110 (59.8)	0.188
Family history of coroner heart disease (n,%)	20 (22.2)	61(33.5)	0.036
Current smoker (n,%)	23(25.6)	51(27.6)	0.421

Demographics, comorbidities, and family history of obese patients and normal weight control subjects.

Table 2

	Control Group (n=90)	Obese Group (n=185)	<i>p</i>
Female Hemoglobin (g/dL)	13.2 \pm 0.8	13.3 \pm 0.8	0.888
Male Hemoglobin (g/dL)	15.2 \pm 0.8	15.1 \pm 0.9	0.955
Neutrophil ($\times 10^3/\mu\text{L}$)	3.4 \pm 0.8	4.4 \pm 1.6	<0.001
Lymphocit ($\times 10^3/\mu\text{L}$)	2.4 \pm 0.5	2.5 \pm 0.7	0.193
Platelet ($\times 10^3/\text{mm}^3$)	256.1 \pm 46.0	275.7 \pm 59.0	0.006
MPV (fL)	7.7 \pm 0.8	8.0 \pm 1.2	0.025
NLR	1.5 \pm 0.4	1.9 \pm 0.7	<0.001
PLR	111.4 \pm 30.1	117.8 \pm 37.7	0.133
AIP	0.18 \pm 0.2	0.46 \pm 0.3	<0.001
Ferritin (ng/mL)	48.4 \pm 57.8	69.1 \pm 74.3	0.033
Hs-CRP (mg/L)	1.29 \pm 1.2	5.3 \pm 4.4	<0.001
FRS	1.73 \pm 2.6	2.98 \pm 4.8	0.007

Comparison of mean hematologic laboratory findings, inflammation markers and Framingham risk scores in obese patients and normal weight control subjects

P-0693

Behavior of Health Workers in Treating Pulmonary Tuberculosis in Manado Community Health Center, North Sulawesi, Indonesia

Henry Palandeng¹, Joy Zeekeon², Dina Rombot¹, Natasha Pongoh³

¹Department of Community Medicine, Faculty of Medicine, Sam Ratulangi University

²Health Department, Manado City

³Medical Student at Faculty of Medicine, Sam Ratulangi University

Tuberculosis is an infectious disease caused by the bacteria *Mycobacterium tuberculosis*, which has become a global threat. There is Tuberculosis control efforts that have been made to reduce the incidence and prevalence of this disease. The success of Tuberculosis treatment cannot be separated from the role of health professionals in this case health workers, which have a direct contact with patients with Tuberculosis. This study aims to determine the behavior of particular knowledge, attitude, and practice of health workers in community health centers, in Manado City. This is a descriptive study. Sampling in this study are 75 health workers. The data was collected through questionnaires. The result showed that majority of respondents are 26-35 years, were 39 respondents (52,0%); most of them are female with 65 respondents (86,7%) and it shows that the career development stages of this age group are included in the third phase is the implementation which the individual began to apply their knowledge to work according to their expertise. In this study, we found that the respondents have good knowledge, attitude and practice for treating patients with tuberculosis. Hence, the health workers are expected more frequently providing information so that the public can better prevent the spread of this Tuberculosis disease.

Keywords: Health Workers, Tuberculosis, Knowledge, Attitude, Practice

Table 1

Characteristics	N	%
Age		
17-25 years	1	1.3
26-35 years	39	52
36-45 years	21	28
46-55 years	14	18.7
Gender		
Men	10	13.3
Women	65	86.7

Characteristics of health workers according to age and gender

P-0694

Care Burden of Caregivers of Home Health Care patients and Related Factors

Pemra C. Ünalın, Nazire Öncül Börekci, Seda A. Özkul, Çiğdem Apaydın Kaya
department of family medicine, marmara university, Istanbul, Turkey

OBJECTIVE:

Caregiver is the person who is helping the patient to deal with the illness and this help includes physical, emotional and tangible support. This intensive working effects the caregivers of the patients who are confined to house or bedridden. This study explores the patients' and caregivers' characteristics, burden of care and potential factors effecting this.

METHOD:

Caregivers of the registered patients of our home health care unit, aged 65 years or older, with Serebrovascular Disease were included. 69 caregivers were assessed using Zarit Caregiver Burden Inventory, sociodemographic information form, general self-efficacy scale, Inventory of socially Supportive Behaviors. All scales were 5-point Likert scale. Zarit Caregiver Burden Inventory consists of 22 items with total points of 88. 3 items selected from Inventory of socially Supportive Behaviors with total points of 12 and 5 items from General Self-efficacy Scale with total points of 25 were used for assessment. Chi-square and Student-T tests were used in the data analysis, $p < 0,05$ was significant.

RESULTS:

Caregivers were at the mean age of 48,22 ($\pm 10,6$) with the mean duration of caregiving of 4,61 ($\pm 3,64$) years. Of the 69 caregivers, 85,5 % (n=59) were female, 63,8 % (n=44) had low education level (≤ 5 years), 79,7% were giving care continuous. Social Support Point, Self-efficacy Point and Zarit Caregiver Burden Inventory mean scores were 3,5 ($\pm 2,44$), 19,8 ($\pm 4,43$) and 54,9 ($\pm 11,24$) respectively. Self-efficacy scores were higher at male gender, intermittent caregivers and higher education level (> 5 years) ($p=0,033$ $p=0,006$ $p=0,006$ respectively). These groups had no statistically significant association with Social Support and Caregiver Burden

CONCLUSION:

In this study Burden of care was assessed at severe levels and Social support was poor among our patients. By comprehensive studies, exposure of the factors contributing to burden in caregivers would be beneficial for both the patient and the caregiver.

Keywords: caregiver burden, home health care, social support, self-efficacy

P-0695

Staying as 'healthy' physicians within the computer-based workplaces Improving the quality of life

Hulya Parıldar¹, Ozlem Cigerli¹, Aydan Aksoyek², Taner Canatar³, Bahadır Yazicioglu⁴, Altug Kut⁵

¹Department of Family medicine, Baskent University, Istanbul, Turkey

²Department of Family medicine, Baskent University, Adana, Turkey

³Family Medicine Specialist, Adana, Turkey

⁴Department of Family medicine, Ondokuz Mayıs University, Samsun, Turkey

⁵Department of Family medicine, Baskent University, Ankara, Turkey

Background and AIM:

Computer-based working and prolonged sitting hours are common among physicians, probably making them at increased risk for musculoskeletal disorders. We aimed to determine the frequency of musculoskeletal complaints (MSC) among physicians.

METHODS:

The present study was a cross-sectional analysis done among 100 physicians working in the outpatient polyclinics in the hospitals, in 2015. This cross-sectional study was performed in physicians working in outpatient polyclinics. They were asked to complete the extended Nordic Musculoskeletal Questionnaire and Visual Analog Scale (VAS) for pain assessment. Student T test ve Pearson Correlation tests were used for comparative statistical analysis.

RESULTS:

Mean age of study subjects was 34.8 ± 7.9 (min=25, max=58), mean BMI was 24.1 ± 3.6 (min=18.2, max=35.8) and 71% were female. Regular physical activity was reported in %21,9. 96% of them did not have any ergonomic training. Regarding hours at work spent in front of a computer, 60 (20%) reported spending >8h/day, (22%) spent 0-2 h/day.

73% of the physicians reported having MSC in one or more regions in the last 12 months; pain/stiffness in the neck and back were the most frequently reported complaints; 43.8% and 24.6%, respectively. Among the physicians who had MSC, 24.7% reported workloss or disability and 58.9% prevention of after-work activities. Mean VAS values over 5 was 49.3%. There was significant increase in complaints among the physicians who spent >4 h/day working on computers ($\chi^2:3.729$, $p=0.045$).

CONCLUSIONS:

The prevalence of MSC and work disability due to these complaints are high among physicians. The prevalence of MSC may be affected by work setting, practice specialty and regular physical activity during work. The physicians themselves need to be aware of the importance of ergonomic training and working conditions. Occupational health of the people working in the computer field with prolonged sitting hours concerns the public health.

Keywords: quality of life, musculoskeletal complaints, ergonomy

P-0696

Factors influencing utilization of hearing protection devices in high-noise workplace environment

Uzuner Ayşe¹, Hoşcan Ahmet Yahya¹, Avcı Kübra Ceren¹, Gültekin Ibrahim¹, Çukadaroğlu Çağrı², Kaya Gülin¹, Gürün Hande¹, Save Dilşad¹

¹Marmara University, School of Medicine, Department of Public Health

²Turkish Ministry of Health

Background & AIM:

Noise is a serious environmental pollutant because of rising urbanization and industrialization in today's world. Related with this noise-induced hearing loss one of the most important public health problems. Although hearing protection devices (HPD) were available and advised to use for prevention from hazardous health effects of noise it still remain as a neglected area in many workplaces.

This study aims to find out HPD utilization rates and influencing factors which may help to definition of accurate strategies for promoting risk recognition.

Method

The study was carried out in five different bus garages in Istanbul. A questionnaire was applied face to face for each individuals who accepted to participate the study (n=222). The noise level measurements for different working environments were evaluated. Chi-square, t-test and Mann-Whitney U-test applied for statistical comparisons.

RESULTS:

The percentage of the participants who declared to use HPD was found to be 38,7%. Among those who knew that the noise exposure may cause to hearing loss HPD use was not different from those who did not know. The only difference was found for those who perceive the environment noisy to have higher utilization rates of HPD comparing with those who did not. The common reason for not to use of protective equipment was lack of the knowledge of the necessity of continuously HPD during working hours (25%, n=54).

CONCLUSION:

The results of the study indicate that medical doctors in workplaces must play an important role in promoting the regular and efficient use of HPD. The educational and motivational efforts should also concentrate on changing the workers' ability to understand health risks.

Keywords: Hearing protection devices; Risk perception; Noise exposure; workplace

Figure 1. The status of participants' use of HPD according to participants' level of education

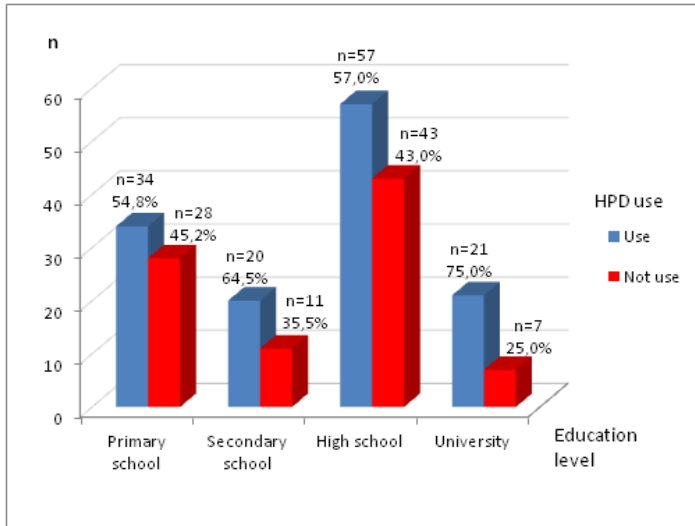


Figure 2. The relation between participants' perception of noise and HPD use

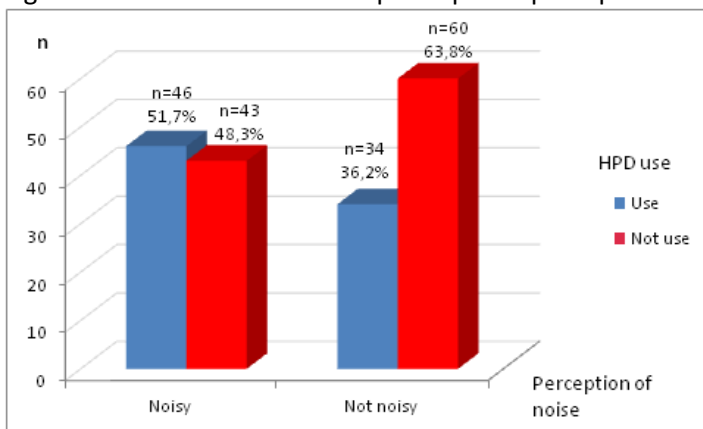


Table 1. The relation between HPD use according to participants' and workplace characteristics

	HPD Use				Total		p
	Use		Not Use				
Effect of noise on hearing loss	n	%	n	%	n	%	
Known	66	42,9	88	57,1	154	100,0	p=0,059
Unknown	18	29,0	44	71,0	62	100,0	
Providing HPD by company	Use		Not Use		Total		p<0,001
Provided	83	51,2	79	48,8	162	100,0	
Not provided	1	1,9	53	98,1	54	100,0	
Caring about own health	Use		Not Use		Total		p=0,286
Yes	80	41,5	113	58,5	193	100,0	
No	9	31,0	20	69,0	29	100,0	
Environmental noise level	Use		Not Use		Total		p=0,189
Noisy (>85dB)	6	60,0	4	40,0	10	100,0	
Not noisy (?85dB)	83	39,2	129	60,8	212	100,0	

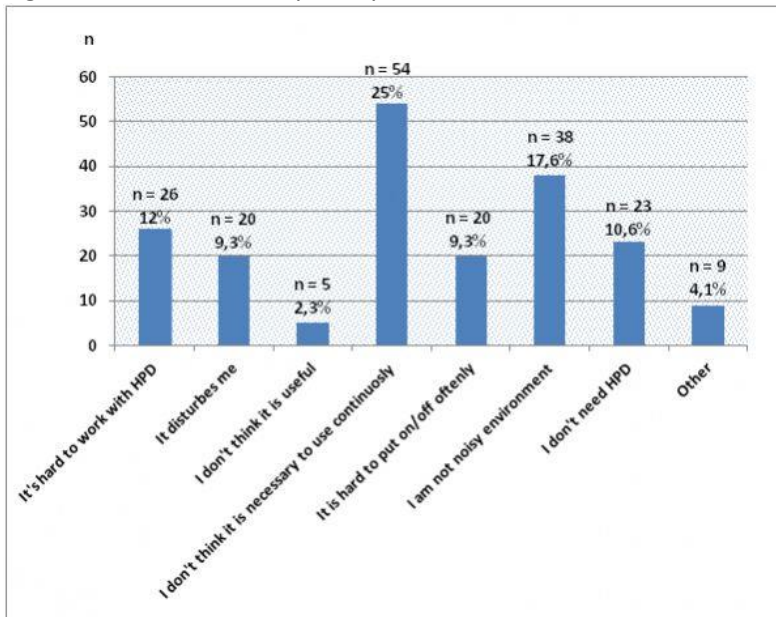
Table 2. The status of company's giving information about how employees use HPD

Information about HPD	n	%
Yes	175	81,4
No	40	18,6

Table 3. Multivariate analysis of factors which affects the participants' non-use of HPD

	OR (Odd's Ratio)	Confidence Interval (%95)	p Value
Age	0,957	0,917 - 0,997	0,038
Effect of noise on hearing loss	1	-	-
Known	2,220	1,128 - 4,368	0,021
Not known			
Education level	1	-	-
Primary school	3,766	1,246 - 11,377	0,019
Secondary school	2,284	0,676 - 7,717	0,183
High school	2,112	0,752 - 5,927	0,156
University			
Environmental noise level	1	-	-
Not noisy (?85 dB)	0,231	0,082 - 0,653	0,006
Noisy (>85 dB)			

Figure 3. The reasons of participants' non-use of HPD



P-0697

Diagnosis and Prevention of Nephropathy Progression in Type 2 Diabetic Patients

Monica Vanessa Mota¹, Tiago Barra², Sara Silva¹, Ricardo Santos¹, José Carvalho¹, Rui Correia¹, Inês Melo E Sousa¹, Frederico Salgado¹, António Filipe¹

¹Unidade de Saúde Familiar Alpendorada, Agrupamento de Centros de Saúde Tâmega I, Marco de Canaveses, Portugal

²Unidade de Nefrologia e Diálise, Centro Hospitalar Tondela-Viseu, Viseu, Portugal

INTRODUCTION: Nephropathy is an important cause of morbidity and mortality in diabetic patients and could be subject of early diagnosis and intervention in order to prevent progression to end stage renal disease. The healthcare team can implement effective strategies in this area, namely: control modifiable risk factors such as hypertension and hyperglycemia; early diagnosis through annual albuminuria dosing and estimation of glomerular filtration rate; and implementation of measures that can delay progression for established nephropathy stage. This study aims to analyze the situation of Family Health Unit (FHU) Alpendorada regarding diagnosis and prevention of nephropathy in type 2 diabetic patients.

METHODS: We conducted a descriptive retrospective study, targeting type 2 diabetics followed-up at FHU Alpendorada in 2014. Data were collected through clinical software SClínico[®], PDS[®], PEM[®] and MIM@UF[®]. Statistical analysis was made through IBM SPSS Statistics[®] using techniques of descriptive and inferential statistics.

RESULTS: We highlight that almost 90% of individuals had undergone nephropathy screening. Of these, 24.1% had incipient nephropathy and 5.2% established nephropathy. On what concerns to preventive measures, almost 100% of patients had a register of hemoglobin A1c, 74.2% of which below 7.0%. All patients had blood pressure registration, 50.7% lower than 140/90mmHg. In patients with indication to perform angiotensin II receptor antagonists or angiotensin-converting-enzyme inhibitors, 82.6% were prescribed with these drugs. Approximately 92% of patients were tested for LDL-cholesterol, 54.8% had values ≥ 100 mg and of these, 50.8% were receiving statin. In patients with albuminuria, cardiovascular risk increased with the progression to established nephropathy stage. The main reasons for referral to nephrology consultation were GFR < 60 ml/min/1.73m² and albuminuria ≥ 300 mg/24h, each of these involving 30.0% of the patients with established nephropathy.

CONCLUSIONS: In FHU Alpendorada, early diagnosis and measures for nephropathy prevention and delaying in type 2 diabetics are in general implemented in accordance with latest guidelines.

Keywords: Diabetes, Nephropathy, Diagnosis, Progression, Prevention

Figure 1 - Patient Distribution by Gender and Age Group

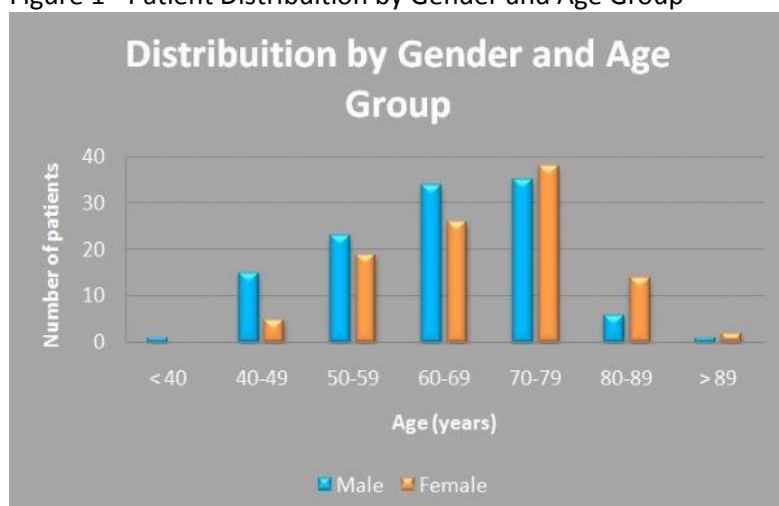
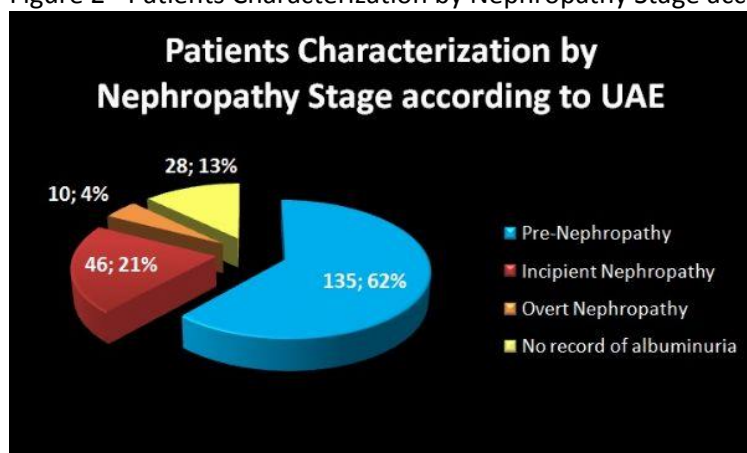


Figure 2 - Patients Characterization by Nephropathy Stage according to UAE



UAE - Urinary Albumin Excretion

Figure 3 - Patients Characterization by Nephropathy Stage

Patients Characterization by Nephropathy Stage					
	Pre-Nephropathy	Incipient Nephropathy	Overt Nephropathy	No record of albuminuria	Total
Age (average, years)	65,8	65,7	66,7	71	66,5
Time since diabetes diagnostic (average, years)	8,7	9,3	12	9,5	9,01
CVD risk (average)	5,1%	6,8%	9,7%	-	-
HbA1C < 7%	80% (N=108)	63% (N=29)	40% (N=4)	71,4% (N=20)	74.2% (N=161)
BP < 140/90 mmHg	60,7% (N=82)	56,5% (N=26)	30% (N=3)	67,9% (N=19)	59,4% (N=130)
Indication for ARB/ACE inhibitor therapy, with prescription	83% N=44	78,3% N=36	100% N=10	-	41,1% (N=90)
Nephropathy codification in patients problem list	1	1	2	2	6

HbA1C - glycosylated hemoglobin; BP - Blood Pressure; ARB - Angiotensin Receptor Blockers; ACE - Angiotensin Converting Enzyme Inhibitor; CVD - cardiovascular disease.

P-0698

Vitamin C and Influenza infections

Ana Marta Garcia, Luís Miguel Paixão
UCSP Fernão de Magalhães, Coimbra, Portugal

Background & AIM: About common cold, a 2013 Cochrane systematic review concluded that Vitamin C supplementation may be useful to prevent it in people exposed to periods of severe physical exercise, but fails to reduce it in general population, and refers that Vitamin C has shown consistent effect on decreasing duration and severity of colds. Would the results be similar when referring specifically to influenza infections? The aim of this review was to evaluate the effect of Vitamin C in the prevention and treatment of influenza infections.

METHOD: Evidence based databases including Pubmed articles combining the MESH key words "Vitamin C" and "Influenza" were searched.

RESULTS: 169 articles were found; 8 corresponded to the review aim: 3 systematic reviews, 1 prospective controlled study, 1 RCT, 3 in vitro studies. In vitro studies show that ascorbic acid can boost immune response and inhibited proliferation of influenza virus in cell cultures. One RCT included in a review demonstrates lower

incidence of pneumonia and hospitalization permanence in patients with influenza infections that received vitamin C 300 mg/day. A prospective controlled study reported significant decreased of reported flu and cold symptoms in the group taking 1000 mg of Vitamin C. One RCT hasn't showed any effect of a multivitamin compound containing ascorbic acid in influenza infection prevention in elderly. The hypothesis that combined inhalation/oral supplementation of ascorbic acid may prevent influenza infection was raised in a review. CONCLUSIONS: Most of the existent evidence about vitamin C use in influenza infections is based on in vitro studies. The little and poor evidence found about its preventive or therapeutic role is in keeping with the consistent one founded to common cold, namely, probably no effect on prevention and maybe an effect in decreasing duration and severity of symptoms. Nevertheless, further therapeutic RCTs are warranted.

Keywords: Vitamin C, Influenza, Prevention, Treatment

P-0699

Does educational status affect the frequency of home accidents? A descriptive study from Istanbul, Turkey

Nurdan Yiğit¹, Tefik Bayram¹, Gizem Erdem¹, Emre Kocazeybek¹, Fatma Zehra Avşar¹, İsmail Dikmen¹, Oğuz Kaan Şimşek¹, Yasemin Çomak¹, Hayriye Kubilay Yüksel², Dilşad Save¹

¹Marmara University, School of Medicine, Department of Public Health

²Turkish Ministry of Health

BACKGROUND AND AIM

Home accidents has high prevalence and cause serious mortality and morbidity among infants and children. The main questions of the study are if current knowledge and practice of preventive measures sufficient to decrease the prevalence and if higher educational status of women may help to decrease the prevalence.

Thus aim of the study is to evaluate knowledge, attitude and practice of mothers who has 0-5 years old children and the factors affecting them.

METHOD

This study is a descriptive study and carried out in two Family Health Centers in Istanbul, Turkey. The questionnaires were administered by face to face interviews to the mothers who admitted to these centers and have 0-5 years old children (n=204). Chi square and t_-test were used in statistical comparisons; p<0,05 is considered as significant.

RESULTS

Type of home accidents were identified as fall(70,5%), shock(50,5%), burn(17,4%), drowning(7,9%), cutting and penetrating traumas(10,6%), poisoning(9,0%). Having any type of accident was 92,6%. The most common cause of poisoning was cleaning products(bleach: 27,3%; soap: 13,6%; shampoo: 13,6%; dish soap: 4,5%). The most common precaution taken was keeping cigarette, match, lighter away of children(80,3%). It is significantly seen that mothers who has university/upper level educational status(p <0,001) and have taken first aid courses take more precautions(p <0,001). However, there was no significant difference between educational status and frequency of accidents.

CONCLUSION

Taking the results of this study into consideration, awareness and knowledge about the preventive measures need to be improved in community. The current education program was not found to be sufficient to prevent home accidents. Specific courses aiming parent population could be more beneficial.

Keywords: home accidents, knowledge attitude and practice, fall, educational status, health education, preventive medicine.

Figure 1. Mean differences of scores of preventive measures about home accidents

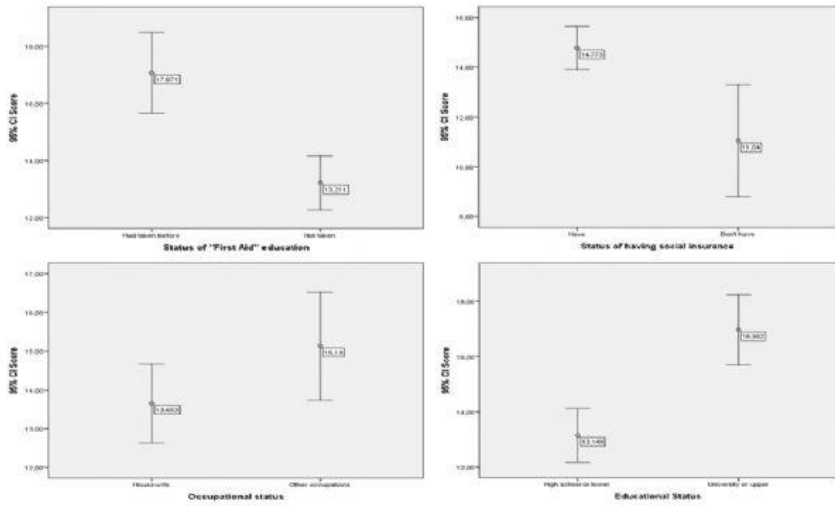


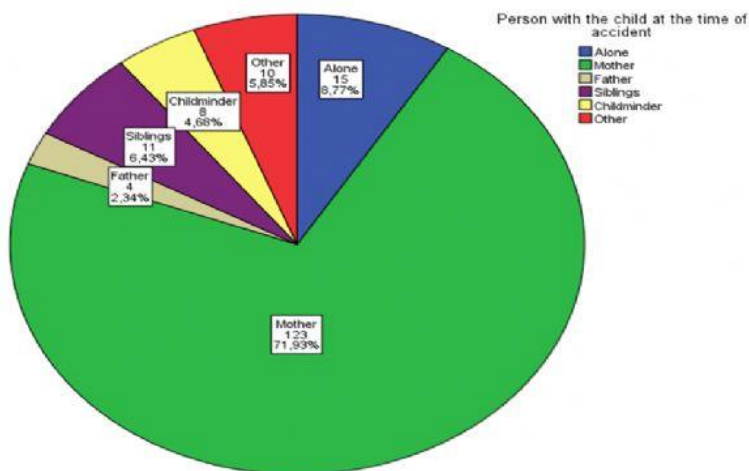
Table 1. First intervention after accident

Category		n	%
First intervention after falling	Compressing with a tissue, cotton, gauze etc.	28	18,9
	Cold compress	60	40,5
	Taking to a hospital	85	23,8
	Creaming	7	4,7
	No intervention	11	7,4
	Cleaning with wet wipe	4	2,7
	Other	3	2,0
First intervention after hitting	Cold compress	79	71,8
	Taking to a hospital	19	17,3
	Creaming	8	7,3
	Compressing with a tissue, cotton, gauze etc.	1	,9
	Cleaning with cologne	1	,9
Other	2	1,8	
First intervention after burning	Cold compress	15	31,9
	Creaming	9	19,1
	Taking to a hospital	21	44,7
	Other	2	4,3
First intervention after choking	Giving back blows	29	72,5
	Taking the object from throat	3	7,5
	Taking to a hospital	7	17,5
	Other	1	2,5
First intervention after cutting and penetrating trauma	Compressing with a tissue, cotton, gauze etc.	15	39,5
	Plastering	11	28,9
	Cleaning with water	2	5,3
	Taking to a hospital	10	26,3
First intervention after poisoning	Taking to a hospital	24	96,0
	Regurgitate	1	4,0

Table 2. Preventive measures taken for accidents

Category	n	%
All the household electrical outlets are covered with special plastic protectors.	70	37,4
I keep all the materials that containing chemical substances (cleaning products etc.) out of reach of children or in special locked cupboards.	156	76,8
I keep furniture away from windows.	130	64,0
I took necessary security measures about glass made tables and coffee tables thinking of my children.	112	55,4
I made the corners and edges of the furnitures and/or fireplace safe.	78	39,0
I am sure that cigarettes, lighters and matches are out of reach of children	163	80,3
I fixed protective apparatus to the doors and windows in order for my children not to compress their hands and fingers.	49	24,1
I fixed protective locks to the drawers in order for my children not to compress their hands and fingers.	47	23,3
I made the balconys safe.	126	62,1
We have child locks in our windows.	98	48,3
I enlightened the corridors appropriately.	146	73,4
I made the stairs safe for children and/or I fixed a security gate.	58	28,1
I took safety measures about electronic devices like TV and stereo in order for my children not to reach them.	113	55,7
I took the necessary measures in the bath tube in order for my children not to slide.	126	62,1
I save drugs in a special locked box or cupboard.	151	74,4
I fixed a special lock to the closet in order to prevent drowning, poisoning or finger compressions.	156	77,2
I keep knives and forks, washing liquids and plastic packings out of reach of children and in locked cupboards	129	63,9
I can keep following the foods are cooked on the stove during cooking without forgetting.	160	78,8
I took special precautions for the foods cooked on the stove, boiling pots and pans in order to prevent access of my children.	123	60,6
I took special precautions to prevent children playing with power buttons of stove and oven.	75	36,9
I took necessary precautions to prevent children switching on electronic devices like refrigerators and ovens.	79	38,9
I keep the chairs and stools away of the worktop and stove to prevent climbing of my children	138	68,0
I pay attention not to leave small objects close to my children to prevent taking them in mouth and choked.	159	79,1
I make sure that the toys are suitable for age of my children.	115	55,3
I know the size of the objects that could cause my children drowning.	121	58,8
I check the water temperature in bathroom before putting my children in it.	117	56,5

Figure 2. Person with the child at the time of home accident



P-0700

Evaluation of knowledge and attitudes about adult vaccines, and the vaccination rate in adults over the age of 18, the first findings

Melahat Akdeniz, Bekir Ineli

Department of Family Medicine, Akdeniz University, Antalya, Turkey

Background: Immunization against vaccine preventable diseases is one of the most important and beneficial public health measures available. Vaccine-preventable disease (VPD) continues to take a heavy toll on adults despite the widespread availability of effective vaccines such as influenza, pneumococcal infections, herpes zoster, human papillomavirus, hepatitis B, and tetanus, diphtheria, and pertussis. However, utilization rates among adults remain low, well below World Health Organization' target levels. Studies on adult vaccination rates are very low and the data are limited in Turkey. In this study, It is evaluated of vaccination status of adults, the knowledge about vaccines and attitudes related immunization attitudes.

Materials and Methods; This study is done by a questionnaire application that we developed on patients presenting for any reason in Family Medicine Clinic. The questionnaire was filled with face to face interviews.

FINDINGS: The number of people participating in the study are 210 Until 1 June 2015. Percent 22 of study participants are health workers. The proportion of patients with chronic disease is 34%. The proportion of people stating that the information on adult vaccines is 41.9%. The proportion of people stating that informed about the vaccine by health care workers is 10.7%. The most known vaccine is influenza vaccine (69%); and the least known vaccine is haemophilus influenzae type b vaccine (12.6%). Those taking no vaccination rate was 66.5%. The most received vaccine is tetanus vaccine (46%). The most frequently reported reasons for not getting vaccine are the lack of information about the vaccines. 66.5% of respondents are demand to inform themselves by their family practice.

CONCLUSION: The knowledge about Adult Immunization is insufficient in the community. utilization rates among adults are very low. Participants are expected to inform the vaccines they need to make by their family physician.

Keywords: Immunization, adults vaccines, knowledge and attitudes

P-0701

Knowledge, attitudes and practices concerning Middle East respiratory syndrome among Umrah and Hajj pilgrims in Samsun, Turkey, 2015

Mustafa Kürşat Şahin¹, Servet Aker¹, Ebru Kaynar Tuncel²

¹Canik Community Health Center, Samsun, Turkey

²Bafra Community Health Center, Samsun, Turkey

Background & AIM: The number of pilgrims attending the annual Hajj or Umrah each year is about 10 million, and these pilgrims originate from 184 countries. After its emergence in June 2012, most cases of MERS-CoV infections were reported from Saudi Arabia. The aim of this study is evaluated Umrah or Hajj pilgrims' knowledge, attitudes, and practices about MERS-CoV. METHOD: We conducted a KAP survey that addressed MERS and its prevention among Umrah or Hajj pilgrims during six weeks, from 4 May to 12 June 2015. Data were collected by the researcher, applying face-to face structured interview techniques with a questionnaire developed after a relevant literature review. Data were analyzed using SPSS 22.0 package program. In the analysis, frequency and percentage from descriptive criteria were used. RESULTS: A total of 259 pilgrims participated. They were between 17 and 85 years old (median: 59 years), and 47.5% (123/259) were male. Nearly half (119/259) had a primary school degree. Some of the participants had pre-existing chronic medical conditions.(Table 1) Seventy-eight per cent (203/259) of respondents performed Hajj or Umrah for the first time. Nearly half of them(131/259) had heard MERS from TV or health professional. When informed about the potential effectiveness of prevention measures against respiratory infection (use of face masks and disposable tissue, hand hygiene, social distancing and avoiding touching eyes, nose and mouth) most pilgrims were willing to apply such measures. CONCLUSIONS: Although the results cannot be extrapolated to all Hajj pilgrims, they show that pilgrim's departing from Turkey were aware of the ongoing MERS epidemic

Keywords: Hajj, Umrah, MERS, prevention & control, viral infection, respiratory infection

P-0702

Allergic contact dermatitis caused by a cell phone cover

Gülben Sarıcı¹, Yasemin Korkut²

¹Department of Dermatology, Dumlupınar University, Kütahya, Turkey

²Department of Family Medicine, Dumlupınar University, Kütahya, Turkey

AIM:

Allergic contact dermatitis(ACD),is also called dermatitis venenata.ACD results when an allergen comes into contact with previously sensitized skin.ACD results from a specific acquired hypersensitivity of the delayed type, also known as cell-mediated hypersensitivity or immunity. The most common causes of contact dermatitis are the following:toxicodendron,nickel, formaldehyde, bacitracin and rubber compounds.

CASE:

Symmetrical,sharply demarcated erythematous,squamous plaques on the cheeks were observed in the physical examination of 32-year-old female patient admitted to polyclinic with complaints of pruritic eruption in the facial region.When questioned that contacting allergens by considering contact dermatitis,it was learned that the patient has talked with a mobile phone about 3 hours per day.

Pruritic eruptions have occurred on the abdominal region in patients 1 year ago,the patient's complaint was considered to be due to belt buckle,patch test was performed,it was determined that the patient has nickel allergy.

It was considered that the patient's symptoms were depending on the mobile phone,therefore it was said to the patient that she should give up contact with mobile phone or the metal parts of mobile phone should be coated with nail polish.Symptoms were resolved completely 15 days after starting topical steroids.

CONCLUSION:

Nickel ranks as the most common allergen tested by the NACDG(North American Contact Dermatitis Group),with 16.7% of patch test clinic patients reacting to it.In patch test clinics worldwide, nickel is the most common allergen.The relevance of these reactions has been estimated to be 50%, suggesting that although this is a common allergen it is not always relevant to the dermatitis in question. Some clinicians advocate coating nickel-containing surfaces such as snaps on jeans with clear nail polish to prevent leaching by sweat onto the skin. However the nail polish can rub off and should be reapplied if it is effective.

Keywords: Dermatit, Cell Phone, Nikel

P-0703

Measurement of knowledge about Sexual Health in Kutahya

Yasemin Korkut, Işıl Atmaca

Department of Family Medicine, Dumlupınar University, Kütahya, Turkey

AIM:The purpose of this research is to determine the knowledge and beliefs about sexual health of people living in Kütahya.

METHODS:

The sample of the survey conducted in Kütahya who agreed to participate in the research consisted of 105 people between 17-80 years of age. This study is cross-sectional and descriptive type. Data were collected using a questionnaire. Evaluation of the data; definitive tests were used.

RESULTS:

The average age was 33.80. Only 6.7% of the participants' family and can talk freely around this issue and information from friends about sexuality 45.7%, 22.9% that they had received from the partner.

8.5% of the women in the study, 2.5% of men had received information about sexual and reproductive health of men and 73.4% of 80.6's% of women reported that they had received this information from the mass media.

Secure the opinions of the participants asked said they heard about the sexual intercourse for the first time 9.4%, said the need to use protection methods 44.7%. The participants in the prevention of sexually transmitted diseases were seen to have a clear picture of 63%

CONCLUSION:

In the faculty of medicine of the participants where the students sexual health-related personal hygiene and sexually transmitted is determined to have false beliefs about infection, family medicine clinic in the medical or allied health workers by sexual and reproductive health related information and misinformation on the subject of providing consultancy services and a little bit will be more effective in preventing beliefs.

Keywords: information, sexuality, protection

P-0704

"{" Evaluation Of Complete Blood Count Profile Of Who Refer For Occupational Health Examination }"

Gülseren Oktay¹, Yunus Emre Kuyucu², Nagihan Yıldız Çeltek¹, Ramazan Tetikçok¹, Ufuk Ünlü¹

¹Department of Family Medicine, Gaziosmanpaşa University Faculty of Medicine, Tokat, Turkey

²Department of Biostatistics, Gaziosmanpaşa University Faculty of Medicine, Tokat, Turkey.

"" **AIM:** The purposes of occupational health service are keeping employees healthy and resuming this, protecting employees from potential harmful effect of working conditions, and to employ people according to their physiologic and psychologic health. During reference many diseases may be detected in the early period via required examinations. We aimed to evaluate, retrospectively, complete blood count (CBC) values.

METHODS: Patients, whom diagnoses are occupational health examination, who refer to Gaziosmanpaşa University of Family Medicine policlinic between the date of 01.01.2014-01.03.2015 were accepted to this study. CBC values were evaluated retrospectively. Patients who were not studied CBC were excluded from the study. Hemoglobin, hematocrit, Platelet, Red Blood Cell, White Blood Cell values are saved.

RESULTS: 124 patients are diagnosed as occupational health examination by Gaziosmanpaşa University of Family Medicine policlinic between the date of 01.01.14- 01.03.15, however 76 patients were studied CBC. Most of the patients (63,2%) were males. The average age of the patients was $31,57 \pm 7,56$ and the average hemoglobin value was $15,4 \pm 1,99$ mg/dl. 7,1 % of women were anemic, while there was not anemic patient among men. 19 male patients' (39,6%) hemoglobin values were over 17 mg/dl and 2 female patients' hemoglobin values were over 15 mg/dl.

CONCLUSIONS: Common diseases among society are encountered among employees population frequently. So anemia is still one of the most important public health problems of the improving countries. This study 2,6 % patients were anemic. In this study it is seen that 27,6% of the patients should be examined as polycythemia and to examine reasons of relative erythrocytosis. Finally, many diseases can be diagnosed in asymptomatic period during occupational health examinations. Therefore, to allowing enough time for patients is important, but this is only be

provided by reducing the intensity of the patient and workload "".

Keywords: occupational health examination, complete blood count, outpatient services

P-0705

Does our elderly vaccinated?

Sıdıka Büşra Korkmaz, Mavişe Esra Ünüvar, Güzel Dişçigil
Department of Family Medicine, Adnan Menderes University, Aydın, Turkey

Nowadays, an increasing number of aged people are living a healthy and still vigorous and independent life. For a healthy and functional late-life, preventive health services are becoming important.. One of the most important of these preventive approach is vaccination.

After receiving the necessary permits for our work as a cross-sectional analytical study, we applied a questionnaire what the applicant 60 years of age and immunization were reached by phone calls person on the circumstances at Adnan Menderes University between January 2010 and May 2014 Family Medicine Outpatient Clinic, In this study, The data of 400 elderly individuals whom admitted to our clinic were analyzed. We evaluated the data we obtained statistically.

279 female patients (69.8%) and 121 men (30.3%). Those in the 60-69 age range from 201 patients (50.3%), those in the 70-79 age range 135 (33.8%), those over 80 and 64 (16%) were men. Those who perform the influenza vaccine 4 (1%), those who make the pneumococcal vaccine 4 (1%), those who get tetanus vaccine 5 (1.3%) were men. When asked me why people who are not vaccinated with the vaccine; those who make the flu vaccine 241 (60.3%) did not know, 153 (38.3%) not be in need of., 2 (0.5%) in the form of replying forgot; those taking 241 of pneumococcal vaccine (60.3%) did not know, 152 (38%) di not be in need of. 234 of those taking tetanus vaccination (58.5%) did not know, 159 (39.8%) not be in need of.

The majority of elderly individuals in the study were not taking the vaccine. This result showed that ther is not enough awareness of elderly about vaccination, family medicine practice to emphasize the importance of vaccination in the elderly and illustrates the need to be informed about it

Keywords: Vaccines, preventive medicine, old age

P-0706

Fatigue and Sleeping Quality in Medical Students

Kübra Uyar, Rana Gündoğan, Özge Berfu Gürbüz, Nilgün Özçakar
Dokuz Eylul University Faculty of Medicine, Family Medicine Department, Izmir

Background&AIM: Sleep is one of the physiological steps of physically and mentally healthy living. Sleep quality is related with feeling fit and being ready for a new day after waking up. The people who have poor sleep quality are forced for issues requiring further attention and concentration during day period. One of the most important factors affecting quality of sleep is fatigue. Tired people have difficulty in sleep transition period and restful sleep process. Medical students are among the groups that having intensive stress, fatigue and sleep problems. Stress, strain and hard theoretical/practical training of medical education makes a reduction in time spent asleep and also sleep quality.

METHODS: In our cross sectional study we applied to 4,5 and 6th grade medical students a questionnaire including socio-demographic characteristics, Pittsburg Sleep Quality Index (PSQI) and Piper Fatigue Self-Report Scale (PFSS). Chi-square and t tests were used for statistical analysis, $p<0.05$ was considered significant.

RESULTS: Participant's (n=290) mean age was 23.47 ± 1.33 and 53.8% were male. It's found that alcohol use 40.3% (n=117), nutritional drug use 40.7% (n=118) and smoking 19% (n=55). Participants who prefer to sleep in dark were 86.2% (n=250). They think that drinks they used before going to bed partially affect their sleep quality (37.9%). PSQI average was 10.56 ± 2.54 (min:5-max:19). The 98.6% of participants have poor sleep quality. PFSS mean score was 2.85 ± 0.83 (min:1-max:5) and 79% of them (n=229) had mild stage fatigue. The PSQI and PFS scores was related statistically significant ($p<0.05$).

CONCLUSION: We found a significant relationship between the levels of fatigue and sleep quality. Although large proportion of participants has bad sleep quality, the level of fatigue was mild. Arrangements should be made to correct the poor sleep quality which affects the quality of life and fatigue levels contributing to the high rate sleep quality might be reduced.

Keywords: Fatigue, sleep quality, medical student

P-0707

Demonstration of the Fact of Active Aging with Fully-Protected Cognitive Processes of an Old Person Living in Residential Home

Gül Kayserili¹, Nil Tekin²

¹Narlidere Residential and Nursing Home, Neuropsychology, Izmir

²Narlidere Residential and Nursing Home, Family Medicine, Izmir

OBJECTIVE: Maintaining the health in the advanced age and active aging is becoming more and more significant as the elderly population increases in the world and our country. It was shown in our study with a case that in spite of advanced elderly phase and risk factors, maintained cognitive functions functioning like a healthy adult can be possible by means of the effort of active aging.

METHOD: In this study, data of woman, 88-year old, university graduate living in residential home are presented. Data about cognitive functions by clinic interview and observation were obtained with Mini Mental Status Evaluation (MMSE), 5 words test (5WT), Wechsler memory scale number range sub-test (WMS-SMT), clock drawing test (CDT).

FINDINGS: It was learnt that the person walked regularly and traveled frequently and read books with daily newspaper regularly. It was noted that she sustained her social life by including new persons in the relations with family and friends and cared about healthy eating. Moreover, she developed individual coping skills for protecting herself mentally in spite of trauma history she lost her child and also long recent operation process. As a result of neuropsychological tests conducted, MMSE score was 30 above 30, 5WT score was 10 above 10, CDT score was 4 above 4 and WMS-SMT score was 6 above 7.

CONCLUSION: Healthy diet, physical activity, being efficient in daily life, sustaining social relations by renewing and developing individual psychological suggestion techniques were observed in the case. Moreover, she

continues cognitive activities regularly such as reading and traveling making a number of parts of brain function simultaneously. Consequently, based on total scores achieved in cognitive rating scales, the significance of active aging, the fact that cognitive functions can be maintained in spite of a number of advanced age risk factors were revealed in this case.

Keywords: Old age, Active aging, cognitive functions

P-0708

Evaluation the Results of a Health Scan Conducted in a Rural District of Konya

Kamile Marakoğlu, Muhammed Kızmaz, Nisa Çetin Kargın, Seda Sazak, Ali Altınok, Emre Ay, Ahmet Ayrancı, Asiye Betül Cebeci, Ramazan Duran, Abdurrahman Altun

Department of Family Medicine, Selcuk University Medical Faculty, Konya, Turkey

AIM: To reach the patients who cannot find the opportunity to reach a hospital or a doctor due to financial or other reasons, and to provide health care to the place where they live are among the tasks of Family Physicians. For this purpose, this study aimed to evaluate the results of a health scanning conducted in a rural district of Konya.

MATERIAL-METHOD: On April 20, 2015 health screening was performed in Taşkent, a town in Konya, by Faculty of Medicine of Selcuk University. Examinations were performed in a fixed area, and a short questionnaire was administered through face-to-face interviews with 112 patients. Prescriptions were written to patients who required treatment as a result of medical history and physical examination.

RESULTS: Of the 112 patients who participated in our screening 67.9% were female and 32.1% were male. The mean age of the patients was 57.33 ± 14.76 , 89.3% were married, 3.6% single and 7.1% were divorced. 24.1% of patients were at normal weight, 33.9% were overweight and 41.1% were obese. 46.42% of the complaints of the patients were pain. 55.7% of the patients with pain were complaining of musculoskeletal pain. Blood glucose starvation of 106 people and the postprandial blood glucose of 6 people was measured with a glucometer device. 41.1% of the patients were considered normal, 25.9% DM and 33% were considered prediabetes according to of measured blood glucose. According to the history and measured blood pressure of the patients, 33% had a diagnosis of hypertension.

CONCLUSION: DM, HT and obesity that have become important public health problems in all over the world and our country have been found to be prevalent in this district. It is essential that family physicians diagnose chronic diseases with simple examination and tests in the first step, train the patients, not delay treatment and refer them to specialist.

Keywords: Health screening; family medicine; obesity; hypertension; diabetes

Picture 1



Picture 2



Picture 3



Table 1. Sociodemographic characteristics and anthropometric measurements

Gender	%	n
Female	67,9	76
Male	22,1	26
Marital Status		
Married	89,3	100
Divorced	5,1	8
Single	2,6	4
Number of children (Median±SD)		3,60±2,02
Height (m)		
Female	1,55±0,061	
Male	1,62±0,081	
Weight (kg)		
Female	72,22±13,5	
Male	71,39±11,9	
BMI(kg/m ²)		
Female	29,7±5,23	
Male	26,98±3,67	
Waist Circumference(cm)		
Female	104,86±10,52	
Male	100,72±11,45	

P-0709

An effective educational model for the empowerment of exclusive breastfeeding

Naciye Irmak, Arzu Uzuner, Burcu Başaran, Sevim Aksoy, Esmâ Özçelik
Marmara University Family medicine department

Introduction and BACKGROUND: Breastfeeding education by group during the prenatal period provides significant increase in the frequency of exclusive breastfeeding for the first six months according to the individual breastfeeding education. In this paper a “person-centered training module for the empowerment of personal development” structured according to the principles of adult education is presented.

METHOD: The training was realized by the participation of a group of 6 to 8 pregnant women in the second and third trimester of their pregnancy. A first session of 45 mn was followed by a break of 10 mn and a second session of one hour. All the participants were motivated to actively participate in the training. And also by highlighting the experienced mothers’ beneficial sharings were also supported as a group interaction. The themes related to the barriers against exclusive breastfeeding and to how to overcome these obstacles, were used in the role-play section, video and slide presentation. It was aimed to attract mothers’ attention by using cultural and traditional motifs in the role-play. And also the breastfeeding position was shown to every pregnant woman one by one on model babies and they were requested to practice by themselves and an appropriate improving feedback were

given. At the end of the training, the mothers' questions were answered without time limitation. The training ended by taking the mothers' written feedbacks about the education and by the distribution of brochures and small gifts for baby care.

Discussion-CONCLUSION: The advantages of this education program were: being designed by experienced people by considering the principles of adult education, being a cost effective packet programme with standardized content applicable in primary care. The limitation is the requirement for a suitable physical environment for group training. The effectiveness of this programme can be evaluated by applying it to many pregnant women and by observing them via scientific methods.

Keywords: mother milk, education, breastfeeding

Person-Centered Training Module For The Empowerment of Personal Development

Modul	Title	Issue	Time (min)
1.	Opening	The purpose of meeting	5'
2.	Acquaintance	The participants identified themselves	10'
3.	Role play	2 case – grand group discussion	30'
4.	Coffee break		10'
5.	Slide show	The importance of breastfeeding	20'
6.	Short film	The demonstration of breast feeding	5'
7.	Practice	The technique of breastfeeding	10'
8.	Evaluation	Summarise of what we learned- get feedback	15'
	Total	(1 h 45 min)	105'

P-0710

Evaluation of the Relationship Between Fluid Consumption Habits and Metabolic Syndrome

Şükrü Ümit Eren¹, İsmail Arslan², İzzet Fidancı³, Gökçe Dilek Işcan⁵, Salih Dilber⁴, Oğuz Tekin²

¹Kızılırmak County Public Hospital, Çankırı

²Ankara Training and Research Hospital Family Practice Clinic, Ankara

³Atakum Community Health Center, Samsun

⁴Orta County Public Hospital, Çankırı

⁵Gölbaşı Community Health Center, Ankara

PURPOSE: We aimed at comparing the fluid consumption amounts and fluid consumption habits of the patients, who live in Ankara and evaluating the relationship between these features and Metabolic Syndrome (MetS).

MATERIAL-METHOD: 102 from Bahcelievler (urban) and 99 from Huseyingazi (rural) (totally 201) patients attended to our study and asked sociodemographic attributes, fluid consumption habits and 24 hours of fluid consumption amounts and the "International Physical Activity Questionnaire". The data was analyzed via SPSS 16.0

FINDINGS: in our study MetS is seen at the rates of 60.5%, 54% and 57.7% respectively in women, men and in general. The factors that may affect MetS were assessed through logistic regression analysis. "Living in rural areas" was increasing the risk of MetS incidence 1.5 times ($P=0.02$). We saw that MetS prevalence increased with "age" ($P=0.001$) and it was significantly

higher in "women" ($P=0.006$). MetS prevalence was found lesser in those with "high physical activity" ($P=0.001$). Considering the relationship between the consumed fluid type and MetS, we observed that MetS prevalence was lesser in those consuming "calorie-free fluid" ($P<0.001$), with "high water consumption" ($P<0.001$) and with "higher daily total fluid consumption" ($P=0.007$). And we saw that the MetS prevalence had increased in those who "consume calorific fluids" ($P<0.001$). "Keeping water on dining table" ($P=0.003$) and "carrying water during the day" ($P<0.001$) increase the amount of water drunk.

RESULT: The beverages consumed by patients and their amounts of calorie are as important as the calorie they receive with feeding. Fluid intake must be provided sufficiently both in the struggle with obesity and MetS; it is necessary to emphasize that the fluid need should be met by calorie-free beverages. The consumption amount of water, which is a calorie-free and easy accessible beverage, must be increased. "Drink water for a dirt cheap treatment."

Keywords: metabolic syndrome, fluid consumption, water consumption

Metabolik Sendromlu Olan ve Olmayan Bireylerin Sıvı Tüketim Durumları
Liquid Consumption of Metabolic Syndrome and Non- Individuals

	METABOLIC SYNDROME	N	Mean	Std. Deviation	Std. Error Mean	P
DAILY CONSUMPTION OF WATER	(+)	116	1088,36	660,348	61,312	<0.001
	(-)	85	1570,00	956,127	103,707	
DAILY TOTAL FLUID CONSUMPTION	(+)	116	2431,4655	881,41808	81,83761	0.007
	(-)	85	2824,7059	1170,30784	126,93771	
DAILY CONSUMPTION OF CALORIFIC FLUID	(+)	116	1143,5345	837,34701	77,74572	<0.001
	(-)	85	647,0588	645,55960	70,02077	
DAILY CONSUMPTION OF CALORIE-FREE FLUID	(+)	116	1287,9310	786,97607	73,06889	<0.001
	(-)	85	2177,6471	1309,20518	142,00324	

P-0711

Periodic Health Examination And The Case Of Asymptomatic Colorectal Cancer

Meryem Solak Karabörk¹, Yaşar Koşar¹, Ertan Bülbüloğlu², Ayşegül Erdoğan³, Mustafa Çelik¹

¹Department of Family Medicine, Kahramanmaraş Sütçü İmam University, Kahramanmaraş, Turkey

²Department of General Surgery, Kahramanmaraş Sütçü İmam University, Kahramanmaraş, Turkey

³Department of Public Health, Kahramanmaraş Sütçü İmam University, Kahramanmaraş, Turkey

INTRODUCTION: In terms of mortality and morbidity rates, colorectal cancer is one of the most common cancers in the world. With screening tests, precancerous lesions or tumors can be detected earlier thus decrease in morbidity and mortality rates is achieved. In this study detection of an asymptomatic colorectal cancer case during periodic health assessment is discussed.

CASE: 67-year-old male visits his family doctor for periodic health assessment without any complaint. Patient has been followed with essential hypertension diagnose for 20 years. His vital findings are stabile and his examination is insignificant. In laboratory tests; WBC: 5.4 K/UI, Hb: 15.1 g/dl, HTC: 45.9%, MCV: 84.2 fl, Ferritin: 7.8 ng/MI. Fecal occult blood test is positive in two consecutive samples.

Colonoscopy is performed in the gastroenterology department: A 5 mm polyp in the distal transverse colon, a 7 cm polypoid mass in the proximal descending colon and a 17 mm polyp in the distal sigmoid colon are detected.

Polypectomy is performed. Biopsy of specimens are found to be consistent with adenomatous polyps.

Surgery is recommended by general surgeon because of its size (more than 6cm) and malignancy risks. Patient underwent laparoscopic left hemicolectomy, with general anesthesia. Left hemicolectomy material is consistent with tubulovillous adenoma.

DISCUSSION and CONCLUSION: Morbidity and mortality rates of Colorectal Cancer remains as an important public health issue in our country likely to the world rates. Decrease in morbidity and mortality rate and decrease in the health expenses with early diagnose is shown in previous studies. To this end, each country constitutes a screening test program according to their own characteristics. Family doctors keep an important role for early detection of asymptomatic colorectal cancer cases with fast, easy and cost-effective approach.

Keywords: colorectal cancer, family medicine, periodic examination

P-0712

Medical Students' Knowledge and Vaccination Status In The Last Year Of Their Education

İlyas Erken, Sema Kılıç, Ozan Fırat Kuz, Gizem Limnili, Nilgün Özçakar

Department of Family Medicine, Dokuz Eylül University Medical Faculty, Izmir, Turkey

Background&Aim

Preventive health service can be grouped as for people and environment. Immunization has an important position in preventive health care. Vaccination service evaluated in two groups as childhood and adulthood vaccines. Both in countries and worldwide, immunization of adults isn't at desired level that vaccine-preventable diseases lead to undesirable results. To have current information and right application of adulthood vaccines is a particular importance for physicians. In this regard, different types of vaccines, knowledge about immunization have been studied and found insufficient; a need for more informed work for society health was stated.

Our aim is to determine level of vaccination knowledge and vaccination status of medical students in the last year of their education.

Methods

In this cross-sectional study, a questionnaire applied to Grade 6 students, to determine the vaccination status and knowledge of vaccines

Results

In our study 51.1% of 176 participants is female and mean age is 24.45±1.01 (min=22, max=31).

In evaluation of vaccination status; 88.6% vaccinated for hepatitis B, 7.4% for pneumococcus, 4% for HPV, 74.4% for tetanus, 18.8% for flu. Their reason asked for not being vaccinated; 44.3% had no reasons, 30.1% thought

vaccination is not necessary. There was no significant difference between genders for reasons not being vaccinated ($p > 0.05$). Right answers about vaccine protection level was; 81.9% for hepatitis B, 64.2% for HPV, 49.4% for tetanus. Hepatitis B vaccination schedule responded correctly (92.6%). Rappelling HPV wasn't known (33.5%), while age range of the application correctly answered (52.3%). Participants stated that flu vaccine can be applied to pregnant (64.8%).

Conclusions

Medical students' knowledge about adult vaccination found moderate. More importance should be given on this issue. Medical students should complete their knowledge of adult immunization like other ages; it will provide the improvement of health care quality in terms of preventive health.

Keywords: Adult, vaccination

The Sociodemographic Attributes of the Participant Students

		N	%
Gender	Female	90	51.1
	Male	86	48.9
Place of residence	With family	24	13.6
	In a dorm	7	4.0
	With flat mates	145	82.4
Vaccination status	Hepatitis B	156	88.6
	Pnuemococcus	13	7.4
	Tetanus	131	74.4
	Flu	33	18.8
	HPV	7	4.0
Reason for not being vaccinated	Had no reasons	78	44.3
	Thought vaccination is not necessary	53	30.1
	Inability to find Time	12	6.8
	To be expensive	7	4.0
	Laziness	7	4.0
	Others	19	10.8

P-0713

A Case with Caesarean Section Scar Endometrioma

Ilyas Erken¹, Gizem Limnili², Nilgun Ozcakar¹

¹Department of Family Medicine, Dokuz Eylul University, Izmir, Turkey

²Medical Center, Dokuz Eylul University, Izmir, Turkey

Background&AIM:

Endometriosis is defined as presence of functioning endometrium outside uterus. Prevalent complaints are menstruation related nodule, pain and infertility. Medical or surgical treatment can be planned. Endometriosis rate is 10%-44% and seen commonly in ovaries. Usually seen in uterine environment but can also seen in distant tissues like rectovaginal septum tissue, cecum, ileum, the inguinal canal, abdominal and perineal scars, ureter, bladder and umbilicus. Abdominal wall placement is very rare. Majority of them developed in abdominal surgery, especially gynecological surgery scar tissue.

CASE:

A 33 year-old case (G1P1) of our clinic had left side ovarian endometriosis before pregnancy, was presented with a painful nodule 2 years after caesarean surgery. Nodule was located on the left side of abdominal wall. The patient told that it was getting bigger and painful with dysmenorrhoea during menstruation. In physical examination mass was palpated at superior part of Pfannenstiel incision, 5-6cm left side of midline, 4cm in size; fixed and painful. Gynecologic examination was normal. Ultrasound showed subcutaneous complex cystic and solid mass, size of 4x2cm. Diagnostic excisional biopsy was performed and revealed a yellow, irregular shaped solid mass; 4x2cm sized located in the subcutaneous region of the left pubis. Pathological diagnose was scar endometrioma. One month after the surgery complaints were lost. 3 months postoperatively, recurrence was not observed.

CONCLUSIONS:

There is an increase in endometriosis cases due to gynecological surgery. The pathophysiology of the scar endometriosis may be due to the direct implantation of the endometrial tissue in scars originated at operation, or induce the surrounding tissue to undergo metaplasia, alternatively, the endometrial tissue may reach the surgical scar through lymphatic or vascular pathway. In women with of abdominal masses on the front wall endometriosis should be kept in mind; the presence of previous surgeries and symptoms with menstrual periods supports diagnosis.

Keywords: Scar endometriosis, Caesarean Section, Surgical procedure

Figure



P-0714

Cytology: About reviews

Ana Cristina Menendez Lopez¹, Lazaro De Castro Peral², Juana Jimenez Martinez³, Javier Arnes Acevedo¹, Francisca Maria Aceituno Villalba¹, Sonia Falla Jurado¹, Maria Dolores Bosque Mata¹, Alicia Sanchez Martinez¹, Inmaculada Pacheco Ruano¹

¹SAN JAVIER HEALTH CENTRE, MURCIA HEALTH SERVICE, SPAIN

²SAN PEDRO HEALTH CENTRE, MURCIA HEALTH SERVICE, SPAIN

³TORRE PACHECO HEALTH CENTRE, MURCIA HEALTH SERVICE, SPAIN

BLACKGROUNDS AND AIMS

Based on the last Bethesda classification (1), in which ASCUS has been subdivided into two categories, ASC- H, as ASCUS suggestive of HSIL and ASC- US, as undefined ASCUS, we have reviewed 25 pathological cytologies throughout a year in our Health Centre, in order to unify the protocol for cervical cancer prevention in area 8, reminding that HPV is the main casual agent and sexually transmitted via.

METHOD:

This is a descriptive study, reviewing 1,379 cytologies performed for one year (November 17, 2013 to November 16, 2014) at San Javier Health Centre, using the G-STAT 2.0 statistical analysis.

RESULTS:

Source: Spanish 69.33%, 13.70%South American, 9.43% Arab and 7.54% rest of Europe. The month in which more cytologies are made is July: 11.02% and the least, 2.39%, in August. Cytological RESULT: normal 98.19%.

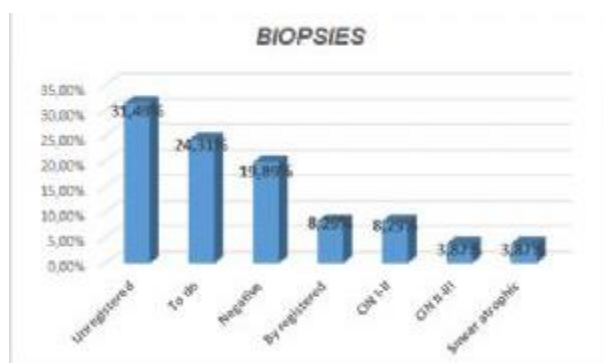
The average age of the pathological cytologies is 34.52 years. Diagnosis: 46.41% ASC, ASC-H 30.94%, 14.92% CIN-I and CIN-II 7.73%. Without a gynecological history: 60.22%, with a history of conization or CIN-I: 3.87%, respectively. 71.82% priority Inter-consultations to cervical pathology were made. From the ordered and registered HPV, 16.02% were positive; from this 3.87% were vaccinated for high risk. Regarding carried out biopsies; the 19.89% was negative, the 8.29% CINI-II and CIN3.87II-III. No surgical intervention was performed, 48.07%. In relation to the subsequent revision: after a month 16.02%, 12.15% 3 months, 6 months 3.87%, 3.87% 12 months, cytology control after 6 months 19.89%, 3.87% medical discharge; rest not registered.

CONCLUSIONS:

- 1.-The presence of ASCUS or AGUS on cytology does not necessarily mean malignancy.
- 2.-Without forgetting that although most of the time they correspond to benign alterations, this group of women have a higher risk of significant pathology. HPV screening cost efficacy can be an alternative to colposcopy.

Keywords: cytology, squamous cells, papilloma

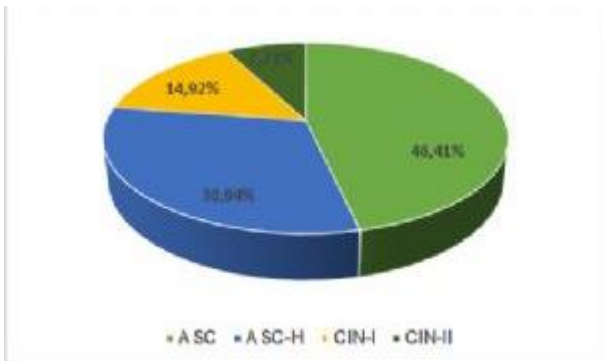
BIOPSIES



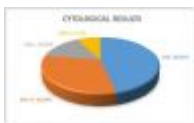
Biopsies



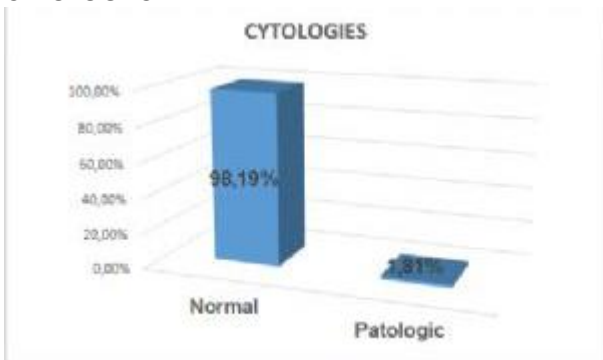
CYTOLOGICAL RESULTS



Cytological results



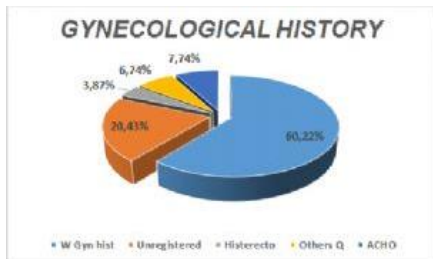
CYTOLOGIES



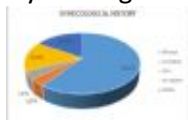
Cytologies



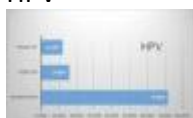
GYNECOLOGICAL HISTORY



Gynecological history

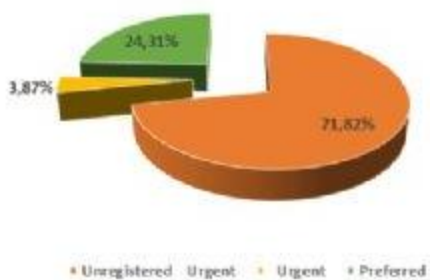


HPV



INTERCONSULTATIONS

INTERCONSULTATIONS

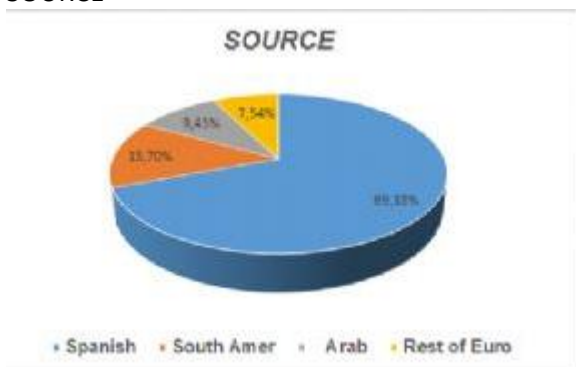


Interconsultations

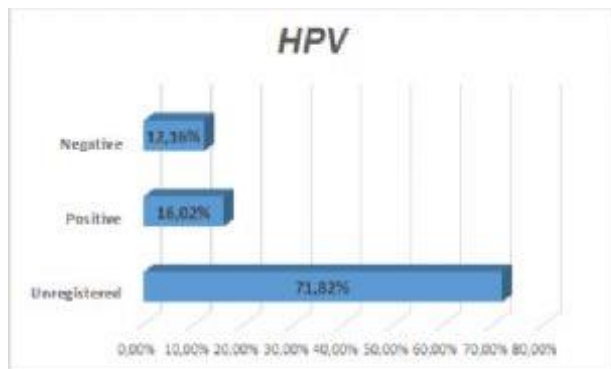
Source



SOURCE



HPV



P-0715

Vascular remodeling caused by high blood pressure in premenopausal women

Adriana Simkova¹, Sona Kinova², Juraj Simko¹

¹Ambulance of general practitioner, Pezinok, Slovak Republic

²1st. department of internal medicine, Faculty of Medicine, Comenius University Bratislava, Slovak Republic

Arterial hypertension (AH) is one of the major risk factors (RF) affecting blood vessel and heart. The impact of classical RF is depend also on sex. Cardiovascular diseases (CVD) in women occur about 10 years later than in men.

Compliance of arteries in younger women is expected to be preserved to protective hormonal profile despite hypertension.

Our aim was to compare pulse wave velocity (PWVao), systolic blood pressure in aorta (SBPao), pulse pressure (PP) and index of left ventricle mass (LVMi) in premenopausal women with and without AH.

Patients and methods

From the cohort of 81 premenopausal women (without history of CVD), 26 (32%), mean age 42y had AH, control group 55(68%) women, mean age 39y without AH. Antihypertensive therapy (mainly RAAS antagonists) had 21 women, 5 were without treatment. PWVao and other hemodynamics parameters (SBPao, PP) were measured using Arteriograph-Tensiomed, which estimates global aortic stiffness. LVMi was derived from standard echocardiographic examination.

Results

The PWVao was significantly higher in women with AH (8,89m/s) comparing to a control group (7,79m/s). The differences of mean values of SBPao (135mm/Hg vs 112,29mm/Hg) and PP (57mm/Hg vs 47mm/Hg) were significantly different and both unfavourable in patients with AH. The difference in LVMi wasn't stistically significant. In mean age, there was no statistically difference.

Conclusion

The aortic compliance is lower in premenopausal women with AH. LVMi wasn't different significantly. Pathologic alternation of blood vessels probably occur earlier than in the heart.

Keywords: vascular remodeling, arterial hypertension, premenopausal woman

P-0716

Stress - type urinary incontinence. What are the most common causes of stress incontinence in women?

Inga Evaltaite Budvytiene¹, Agne Sumilaite¹, Kazys Simanaukas¹, Sonata Bariliene²

¹Department of Faculty of Medicine: Clinic of Internal Diseases And Family Medicine, Vilnius University, Vilnius, Lithuania

²Lithuanian University of Health Sciences Hospital Clinics, Kaunas, Lithuania

BACKGROUND: Stress incontinence is a leading type of urinary incontinence and mostly it is an undiagnosed problem, especially by elderly women. Our study reveals the main risk factors for developing stress incontinence. **METHOD:** A prospective, limited time, cohort study was enrolled in 2014. 155 women attended, who were older than 18 years-old and were asked to fill in a questionnaire. In this study was used two forms: ""King's Health Questionnaire – KHQ"" , which was established by C. J. Kelleher and other authors in 1997 and adapted form, composed by medical doctor S. Bariliene in 2008.

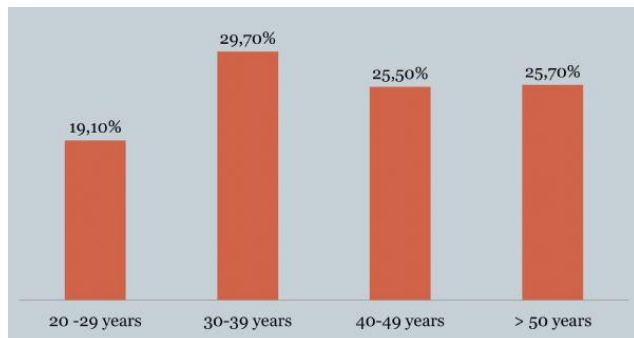
Results from a study were analysed with a program ""SPSS"" and ""MS Excel2014"".

RESULTS: 155 women were examined, 23,87%(37) reported to have urinary incontinence problem. 34,19%(53) denied they have urinary incontinence, but as it showed later, they all faced this problem. Overall, the study demonstrated that 57,41%(89) of women need to cope with this problem. The results exposed that a stress incontinence was the most common type, 71,91%(64). It showed that the average age of women, who has stress incontinence is 45.86 years-old and this index is statistically reliable ($P=0,003$), when it was compared with healthy woman. Moreover, the results disclosed an inheritance factor is statistically reliable ($P=0,019$). There was a statistically reliable difference between woman who had delivered a child and the once who had not had ($P=0,006$). Indeed, the most revealing factor is that the number of labour, makes no difference for developing urinary incontinence.

In CONCLUSION: The possibility of developing stress incontinence increases with an age, particularly if the first-line relative has this problem. Another factor – the number of labour was investigated, it demonstrated there is no statistical difference between the number, but the fact that women had delivered a child, makes her chance of having a stress incontinence higher.

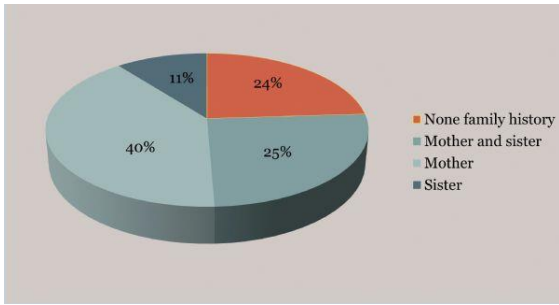
Keywords: Urinary incontinence, stress incontinence, cause factors.

Distribution of stress incontinence between different age groups.



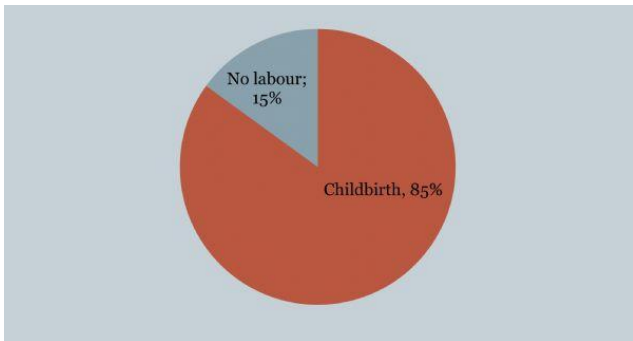
Distribution of stress incontinence is high in all groups. The average age of women is statistically reliable ($P=0,003$), when it was compared with healthy woman.

Inheritance role for developig stress incontinence.



Study revealed that 76% women had a family history of stress incontinence. An inheritance factor is statistically reliable (P=0,019).

Labour as a risk factor.



Study showed that 85% of women who delivered a baby have urinary incontinence. There was a statistically reliable difference between woman who delivered a child and the once who had not (P=0,006).

Prevalence of stress incontinence according a fact of delivery.

Stress incontinence	Childbirth	No labour
Positive (n= 79)	60% (n= 72)	21% (n= 7)
Negative (n= 76)	40% (n=50)	79% (n= 26)

Woman who had at least one child have nearly 3 times higher risk of developing stress incontinence than woman who have not.

P-0717

Validity Of Breast Cancer Risk Analysis Models Gail, NCI And NSABP To Evaluate The Risk Of Turkish Women

Elif Altunbaş Ateş¹, Betül Bozkurt²

¹Department of Family Medicine, Karadeniz Technical University, Trabzon, Turkey

²Department of Breast and Endocrine Surgery, Ankara Numune Training and Research Hospital (ANTRH), Ankara, Turkey

Background&AIM: The best protection against breast cancer, which is the commonest cancer in women, is early detection. The breast cancer risk assessment tools most in use are the Gail model, the NSABP and NCI models. We studied a group of Turkish women with a previous diagnosis of breast cancer to ascertain if these models could be applied to Turkish women. Could we predict that they would have breast cancer?

METHODS: We retrospectively evaluated 1334 patients who had diagnosed breast cancer in ANTRH between April 1998 and December 2014. To evaluate Gail, NSABP and NCI models we collated the requisite parameters, age at diagnosis, age at menarche, age at first childbirth, history of previous biopsy, history of breast cancer in a first degree relative. We included patients whose 5 years risk, calculated by Gail and NSABP models was found to be greater than 1.67 as high risk for developing breast cancer. High risk patients calculated by the NCI model are those whose risk is greater relative to women of the same age with no risk factors.

RESULTS: In our study the Gail model identified 32.4 % of the patients who had a diagnosis of breast cancer as being at high risk. The NSABP model identified 19.3% as being at high risk and the NCI identified 20.1%.

DISCUSSION: Comparing the sensitivity of the three models the Gail model was the most sensitive; however it only identified 32.4% of those patients who developed breast cancer as being at high risk. When we compared these models we found that, although there is a correlation between the results, the results are significantly different.

CONCLUSION: As a result of the model's low sensitivity and poor concordance we conclude that these three models are not applicable to a Turkish women. There is a need to organize a new risk assessment model with addition of different parameters to validate Turkish women.

Keywords: Breast cancer, Risk Assessment Models, Turkish Women

P-0718

The Relationship Between Sex Hormone Binding Globulin and Metabolic Syndrome Parameters with Obesity in Premenopausal Women

Seher Sayın, Ruhuşen Kutlu, Fatma Gökşin Cihan

Department of Family Medicine, Meram Medical Faculty, University of Necmettin Erbakan, Turkey

Background and AIM: Metabolic syndrome (MetS) includes the abdominal obesity, hypertriglyceridemia, low high-density lipoprotein (HDL) concentrations, hypertension, and hyperglycaemia. Sex hormone binding globulin (SHBG) is the major binding protein for gonadal steroids in the circulation. The aim of this study was to determine SHBG and MetS parameters concentrations in premenopausal women and to evaluate the relationships between these parameters with obesity.

METHOD: This study was carried out on 150 premenopausal women referred to the Outpatient Clinic of Family Medicine, Meram Medical Faculty Hospital. Patients were divided into three groups according to the body mass index: normal-weight, overweight and obese women. The blood pressure was measured. Low-density lipoprotein cholesterol (LDL-c), high-density lipoprotein cholesterol (HDL-c), total cholesterol (TC), triglyceride (TG), fasting blood glucose (FBG) and SHBG levels were examined in the blood samples of the patients. Fat distribution and body compositions were assessed with a portable impedance analyzer (Tanita®). One way ANOVA and Pearson correlation tests were used to determine relationship between variables. All statistical analyses were performed using SPSS 20 software. P value less than 0.05 was considered as significant.

RESULTS: The mean age of the patients was 31.37 years (SD=8,33). The mean age was similar between the groups (p=0.097). In the obese group, FBG (p=0.000), LDL-c (p=0.001), HDL-c (p=0.001), TC (p=0.009), TG (p=0.002), uric acid (p=0.000), systolic (p=0.000) and diastolic blood pressure levels (p=0.017) were significantly higher than non-

obese group. In the obese group, SHBG levels was significantly lower ($p=0.005$). A significant negative correlation was found between the SHBG levels-fat percentage ($r=-0.206$, $p=0.012$) and SHBG levels-waist circumference ($r=-0.237$, $p=0.003$).

CONCLUSIONS: These results suggest that low plasma SHBG level may represent a significant predictor of the obesity in premenopausal women.

Keywords: Metabolic syndrome, sex hormone binding globulin, premenopausal woman.

P-0719

Bilateral galactorrhea: more than a pregnancy?

Ana Sofia Rocha, André Pereira Lourenço, Inês Espiga Macedo, Pedro Moreira Castro
USF Modivas, ACES Póvoa de Varzim/Vila do Conde, Porto; Portugal

Background

Galactorrhea is a common breast complain. If bilateral it is frequently caused by lactation, physiologic galactorrhea or hyperprolactinemia, which may be due to medication, endocrine tumors or abnormalities.

Case report

A 23-year-old female, living in consensual union, graduated, nurse. Belongs to a nuclear family, Duvall cycle I, Graffar classification II. No premorbidities or significant family history.

In June 2014 she came to the family doctor for a preconceptional consultation, which was entirely normal. Returned in August 2014 with complaints of galactorrhea for the past week, performed a pregnancy test which came back negative. She denied taking medication or any history of substance abuse. Physical examination showed a serous bilateral nipple discharge and no other findings were presents. Laboratory tests revealed an elevated serum prolactin, normal thyroid function and a normal mammary ultrasound. CT scan imaging of the brain was then performed and showed a pituitary mass with 3.5 mm diameter. She was referred to endocrinology which only took place in January 2015. Meanwhile she became pregnant and at the time of the consultation she already had a thirteen weeks pregnancy. Further study through brain MRI and treatment decisions were postponed until the postpartum period. Despite being a health professional she is very anxious and fearful dealing with two life-changing situation at a time.

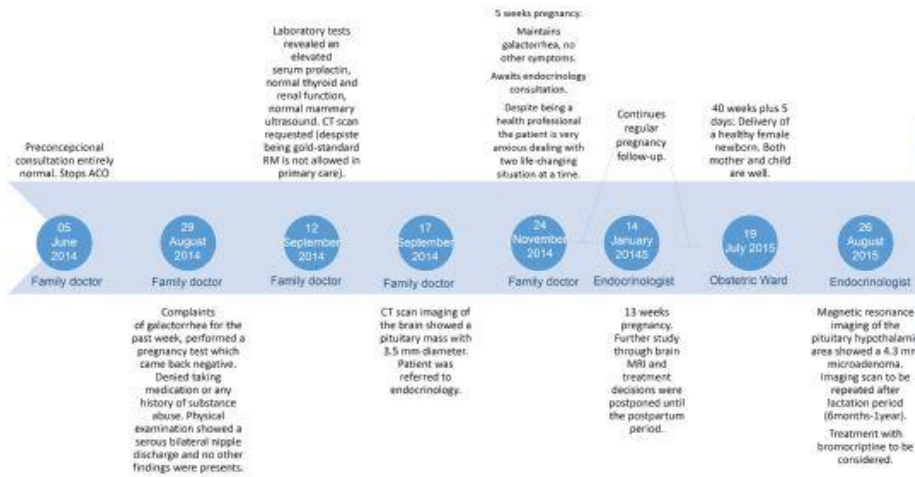
Discussion

Family doctor is usually the first contact within the health care system and must deal with all kind of medical problems. In this case it means not only to recognize and diagnose the disease but also to deal with the pregnancy and psychological allocation of the patient. This case exposes the importance of the holistic approach and how the life circumstances of our patients affect their sense of illness.

Keywords: galactorrhea, pregnancy, pituitary adenomas, illness

Case Report

A 23-year-old female, nurse, living in consensual union. Belongs to a nuclear family, Duvall cycle I, Graffar classification II. Healthy, no pre-morbidities or significant family history:



P-0720

Assessment of the risk factors influencing osteoporosis in patients who were admitted to outpatient menopause clinic

Ahmet Gürhan Poçan¹, Çiğdem Gereklioğlu¹, Kenan Topal², Süheyl Asma¹

¹Baskent University Medical Faculty, Family Medicine Department, Ankara/Turkey

²Adana Numune Training and Research Hospital, Family Medicine Department, Adana/Turkey

BACKGROUND and AIM: To investigate the risk factors affecting osteoporosis in patients who were admitted to outpatient menopause clinic and to determine their relationship with osteoporosis.

METHOD: The association between postmenopausal osteoporosis and history of pregnancy, oral contraceptive (OCS), antiresorptive, calcium, hormone replacement therapy (HRT) use, smoking, alcohol and caffeine consumption, diet and physical activity were questioned in 1139 patient. Total BMD of the femur and lumbar spine were used for statistical analysis and T scores above -1 were accepted as normal, between -1 and -2,5 as osteopenia and -2,5 and below as osteoporosis according to WHO criteria. Two independent sample t test, One Way Anova, Chi-square test and Logistic Regression Analysis were applied.

RESULTS: Mean age of the patients was 53.5±6.7 years. Mean duration of menopause was 7.1±6.2 years (range 1-31), mean age of menopause was 46.3±5.1 years. While 88.6% of the patients had natural menopause, 11.4% had surgical menopause. Mean BMI was found as 29.6±5.1. Femur and lumbar BMD (p= 0.000, p= 0.003) and T scores (p= 0.000, p= 0.000) of these patients were found to be statistically significantly higher than those of the patients with normal weight and increase as BMI increased. Femur T scores were seen to be influenced by OCS (p=0.035), HRT (p=0.003), antiresorptive treatment (p=0.000) use, caffeine consumption (p=0.020), history of fragility fracture (p=0.025), BMI (p=0.000). Lumbar T scores were seen to be influenced by menopause type (p=0.047), HRT (p=0.038) antiresorptive treatment (p=0.000), smoking (p=0.036) and BMI (p=0.000).

CONCLUSION: Femur and lumbar T scores were found to be lower in patients with normal or low BMI and who are smoking. The scores were higher in patients who had previously used OCS and currently using HRT, who regularly consume dietary calcium. Early detection of particularly modifiable risk factors may reduce osteoporosis risk.

Keywords: Postmenopause, Osteoporosis, Bone Mineral Density

Table 1. Comparison of the BMI according to the femoral neck and lumbar spine T scores.

	Normal	Osteopenia	Osteoporosis	F	p
BMI according to the femoral neck T score (kg/m ²)	30.8±5.1	28.2±4.7	25.7±3.7	52.67	0.000
BMI according to the lumbar spine T score (kg/m ²)	30.5±5.3	29.3±4.8	28.3±5.1	14.13	0.000

P-0721

Does family planning method changes according to birth place?

Binali Çatak¹, Can Öner²

¹Kafkas University School of Medicine

²Istanbul Bilim University School of Medicine

Unmet need for contraception can lead to unintended pregnancies. To use contraceptive methods which are mainly related with sociodemographic features and service-related barriers. Policy-makers can only strengthen contraceptive programs by using data on barriers of contraceptive use. The main objective of this study was to compare use of contraceptives in two groups of women: Home delivered and hospital delivered women.

The data of this study was derived from part of prenatal and postpartum care of an other study namely "Unplanned home birth and affecting factors". This study was designed as case control study. The "case" group consisted of 229 women who had "unplanned home deliveries" and "control" group (n=458) of women giving birth in hospitals. The data were analyzed in the SPSS package program

Mean age of case group was 26,5±6,1 years, and control group was 27,5±5,3 year (p=) The median of total pregnancy count was 2 (1-9) and 1 (1-10) in case and control groups respectively. On the other hand median of lived children count was 3 (0-9) in case group and 2 (1-10) in control group. Unintended pregnancy rate was 20,8% (n=36) in case group where as it was 9,6% (n=37) in control group.

Contraceptive non users rate reaches up to 40,5% in case group and 42,5% in control group before delivery and decreases in both groups 24,3% and 25,3% after delivery. In both groups only one thirds of women used modern contraceptive techniques before delivery (27,7% vs 30,6% case and control groups respectively). After delivery the use of modern contraceptive techniques increases in both groups but there was no significant difference between groups (39,3% vs 43,8% case and control groups respectively).

There is no difference between use of contraceptives before and after delivery in women who delivered home and hospital.

Keywords: family planning, home birth, contraception

Table 1: Family planning status of two groups

		Home delivery n=173,(%)	Hospital delivery n=384,(%)	p value
Pregnancy wanting status of Women	Wanted	120 (69,4)	319 (82,6)	0,001
	Never wanted	17 (9,8)	30 (7,8)	
	After wanted	36 (20,8)	37 (9,6)	
Pregnancy wanting status of husband	Wanted	132 (76,3)	335 (86,8)	0,005
	Never wanted	14 (8,1)	22 (5,7)	
	After wanted	27 (15,6)	29 (7,5)	
Family Planning before pregnancy	None user	70 (40,5)	164 (42,5)	0,490
	Conventional	48 (27,7)	118 (30,6)	
	Modern	55 (31,8)	104 (26,9)	

	None user	42 (24,3)	98 (25,4)	
Family Planning after pregnancy	Conventional	68 (39,3)	169 (43,8)	0,413
	Modern	63 (36,4)	119 (30,8)	
Total		173 (100,0)	386 (100,0)	

P-0722

The frequency of cesarean sections in primiparous women and affecting factors: cross-sectional type field study

Binali Çatak¹, Can Öner², Sevinç Sütü³, Selçuk Kılınç³

¹Kafkas University School of Medicine

²Istanbul Bilim University School of Medicine

³Burdur Public Health Directorate

In Turkey parallel to the developments in the World this rate has risen to 48.1% in 2013. The purpose of this study is to determine cesarean birth rates and to find out factors affecting the cesarean birth in primiparous women. The universe of the research this cross-sectional type was formed by 223 primiparous women. The data was collected with data collection form prepared by the researchers using face-to-face interview technique. In these analyses, chi-square and Backward LR logistic regression analyses were used.

In multivariate analyses, the place of delivery (OR: 11.2 [2.9-42.46] in private hospital and OR: 6.1 [2.6-14.1] in university hospital); time of the birth (OR: 7.1 [3.1-16.0]); doctor's effect (OR: 4.0 [1.8-8.95]) and husband's employment status (OR: 2.23 [1.0-4.7]) have been identified as factors affecting the caesarean delivery among these factors.

Although the results don't show all of the factors affecting the caesarean delivery in primiparous, they also reveal that medical reasons are not the only reason in this increase trend. Health policy makers and health professionals are required to identify the causes of this increase and to take measures.

Keywords: cesarean delivery rate, primiparous women, risk factors, social predictors

Table 1: Sociodemographic features of women

Sociodemographic features		Normal	Cesarean	Total	P
		%,(n=94)	%,(n=120)	%,	
Residence	Village/Town	36.2	21.6	28.0	0.019
	City	63.8	78.4	72.0	
Age	≤ 19	24.4	13.3	18.2	0.017
	20–29	69.1	70.0	69.6	
	≥30	6.5	16.7	12.2	
Family type	Nuclear family	73.4	85.8	80.3	0.023
	Extended family	26.6	14.2	19.7	
Household count	≤ 4	87.2	93.3	90.6	0.128
	≥ 5	12.8	6.7	9.4	
Consanguinity	Yes	4.3	6.7	5.7	0.447
	No	95.7	93.3	94.3	
Formal marriage	Yes	99.0	96.7	97.7	0.275
	No	1.0	3.3	2.3	
Women' Education	Elementary or below	13.8	10.0	11.6	0.387
	Secondary school or above	86.2	90.0	88.4	
Husband's education	Elementary or below	17.0	11.6	14.0	0.263
	Secondary school or above	83.0	88.4	86.0	
Health insurance	No	11.7	3.3	7.0	0.017
	Yes	88.3	96.7	93.0	
Husband's occupation	Unemployed	8.5	4.1	6.0	0.020
	Public/private sector	54.2	72.5	64.4	
	For own	37.3	23.4	29.6	
Women' occupation	Employed	15.9	20.8	18.7	0.364
	Unemployed	84.1	79.2	81.3	

Table 2: Birth and infant features

		Normal	Cesarean	Total	P
		%,(n=94)	%,(n=120)	%,(n=214)	
Knowing problems associated with normal delivery	Yes	6.3	13.3	14.9	0.097
	No	93.7	86.7	85.1	
Knowing problems associated with cesarean delivery	Yes	14.8	14.1	14.0	0.744
	No	85.2	85.9	86.0	
Informed about delivery types	Non-informed	60.6	49.1	54.6	0.095
	Informed	39.4	50.9	45.4	
Physician affect the delivery type	Yes	55.3	84.1	71.4	0.001
	No	44.7	15.9	28.6	
Gestational week	≤ 37 week	14.8	19.1	17.2	0.412
	≥ 38 week	85.2	80.9	82.8	
Birth place	University hospital	3.1	20.0	12.6	0.001
	Private hospital	14.8	35.8	26.6	
	State hospital	82.1	44.1	60.7	
Sex of infant	Female	48.9	51.6	50.4	0.692
	Male	51.1	48.4	49.6	
Weight of infant &	≤ 2500 gr	8.5	12.5	10.7	0.350
	≥ 2500 gr	91.5	87.5	89.3	

& 3 data is missing in cesarean group

Table 3: Factors related with caesarean delivery

Dependent variable: Delivery type			
Independent variable		Odd's Ratio	95% CI (Min-Max)
Birth place	Private hospital	11.259	2.985–42.469
	University hospital	6.137	2.635–14.295
	State hospital	1 (Reference)	
Husband occupation	Unemployed	0,758	0.163–3.514
	Public/private sector	2.233	1.054–4.732
	For own	1 (Reference)	
Physician affect the delivery type	Yes	4.039	1.821–8.958
	No	1 (Reference)	
Birth time	08:00–17:29	7.140	3.187–16.000
	17:31–07:59	1 (Reference)	

P-0723

Predictors of Knowledge Level and Awareness towards Breast Cancer among Turkish Females

Umit Aydogan¹, Yusuf Cetin Doganer², Zafer Kilbas³, James Edwin Rohrer⁴, Oktay Sari¹, Necibe Usterme¹, Servet Yuksel¹, Halil Akbulut⁵, Salih Mujdat Balkan⁶, Kenan Saglam⁷, Turgut Tufan³

¹Department of Family Medicine, Gulhane Military Medical Faculty, Ankara, Turkey

²Department of Family Medicine, Turkish Military Academy, Primary Care Examination Center, Ankara, Turkey

³Department of General Surgery, Gulhane Military Medical Faculty, Ankara, Turkey

⁴Department of Family Medicine, Mayo Clinic, Rochester, MN, USA

⁵Department of Family Medicine, 4th Air Force Base, Ankara, Turkey

⁶Department of General Surgery, TOBB ETU Hospital, Ankara, Turkey

⁷Department of Internal Medicine, Gulhane Military Medical Faculty, Ankara, Turkey.

Background & AIM: Breast cancer (BC) is the most-common malignancy of women worldwide. Though slight difference among developed and developing countries, BC remains as the most common cancer type of women in Turkey. This study aimed to identify the level of knowledge, awareness, and their potential predictors towards BC in Ankara, Turkey.

METHOD: The present descriptive study was conducted on 376 females attending to a breast health outpatient clinic. Self-administrative questionnaire was designed to evaluate knowledge level about BC and predictors effecting its level. Data analysis was performed using the chi-square test. A value of $p < 0.05$ was considered statistically significant.

RESULTS: Mean age of the participants was 46.16 ± 9.93 (22-75). Majority (92.6 %) were married; 41.5% educated less than nine years. Most of the women were housewives (82.7%) and, were living in the urban region (86.4%). Predictors of effecting responses to seven knowledge and awareness questions about BC vary from demographic features including older age groups, higher educational levels, being married, living in an urban area, being employee, smoking, having greater BMI to additional attributes associated breast health such as the increased number of births, applying for the purpose of control, positive family history of breast diseases, any diagnoses of breast diseases and performing BSE practice.

CONCLUSION: It was determined that females in Turkey have better knowledge of BC than other developing countries even though it is not in the desired level. These findings revealed that females should be more informed about BC risk factors, prognosis and treatments by primary health-care providers to get through the ascending burden of this disease.

Keywords: Breast cancer, female, knowledge, awareness

Table 1. Comparison of answers to the knowledge questions about breast cancer (N=376).

Variables	Questions		X ²	P [†]
	Q1. Has a familial transmission			
	No	Yes		
Educational level			13.022	0.001
0-8 years	51.7%	35.1%		
9-11 years	35.2%	39.4%		
≥12 years	13.1%	25.5%		
Family history of breast disease	20.7%	29.9%	3.871	0.049
BSE	71.7%	83.1%	6.903	0.009
Age periods of 1st pregnancy			10.742	0.005
≤20 years	45.5%	32.0%		
21-24 years	26.9%	42.9%		
≥25 years	27.6%	25.1%		
	Q2. Is a curable disease			
Educational level			6.161	0.046
0-8 years	54.3%	38.6%		
9-11 years	27.1%	40.2%		
≥12 years	18.6%	21.2%		
Location (urban)	78.6%	88.2%	4.538	0.033
Diagnose of Breast disease	40.0%	55.9%	5.768	0.016
BSE	68.6%	81.0%	5.292	0.021
	Q3. Is a mortal disease			
Age groups			8.004	0.046
20-39 years	27.7%	17.4%		
40-49 years	42.9%	42.0%		
50-59 years	20.6%	25.4%		
≥60 years	8.8%	15.2%		
BMI classification (kg/m²)			13.094	0.001
18-24.9	52.9%	34.1%		
25-29.9	30.3%	39.1%		
≥30	16.8%	26.8%		
Apply for the purpose of control	37.4%	47.8%	3.923	0.048
	Q4. Easily spread out to other organs			
Age groups			8.799	0.032
20-39 years	29.9%	17.3%		
40-49 years	40.1%	45.3%		
50-59 years	20.8%	24.0%		
≥60 years	9.1%	13.4%		
Family history of breast disease	20.8%	32.4%	6.495	0.011
Smoking	18.3%	29.1%	6.075	0.014
BSE	71.1%	87.2%	14.486	<0.001

Table 1 (continued)

	Q5. Breastfeeding is protective			
Marital status (married)	89.2%	96.5%	7.359	0.007
Apply for the purpose of control	34.5%	49.1%	8.274	0.004
	Q6. Cause to lose female characteristics			
Age groups			9.968	0.019
20-39 years	24.8%	16.2%		
40-49 years	44.0%	29.7%		
50-59 years	21.5%	29.7%		
≥60 years	9.7%	24.3%		
BMI classification (kg/m²)			10.770	0.005
18-24.9	48.7%	21.6%		
25-29.9	32.4%	43.2%		
≥30	18.9%	35.1%		
Number of births			10.338	0.006
1	23.9%	10.8%		
2	60.8%	54.1%		
≥3	15.3%	35.1%		
	Q7. Gender of physician is important			
Number of births			8.460	0.015
1	22.6%	23.1%		
2	62.0%	43.6%		
≥3	15.4%	33.3%		
Diagnose of Breast disease	54.9%	35.9%	5.064	0.024

BMI, Body mass index; BSE, Breast self-examination.

*Chi-square analysis

Table 2. Multivariate regression analysis of answers to the knowledge questions about breast cancer (N=376)

	P	OR	95% CI	
			Lower	Upper
Q1. Has a familial transmission				
Age groups (>=60 years) vs (20-39 years)	0.024	2.976	1.153	7.677
Educational levels (≥12 years) vs (0-8 years)	0.008	3.151	1.355	7.326
BSE	0.031	1.838	1.057	3.195
Age periods of 1st pregnancy (21-24 years) vs (≥25 years)	0.019	2.103	1.132	3.906
Q2. Is a curable disease				
Location (Urban vs Rural)	0.033	2.243	1.068	4.709
Diagnose (Y vs N)	0.021	1.981	1.109	3.539
Q3. Is a mortal disease				
Age groups (>=60 years) vs (20-39 years)	0.046	2.643	1.015	6.883
Employment status (employed vs housewife)	0.044	2.209	1.022	4.772
BMI (25-29.9) vs (18-24.9)	0.030	1.811	1.059	3.098
BMI (≥30) vs (18-24.9)	0.024	2.065	1.101	3.872
BSE	0.031	1.933	1.062	3.518
Smoking (Y vs N)	0.006	2.143	1.246	3.687
Q4. Easily spread out to other organs				
Age groups (40-49 years) vs (20-39 years)	0.036	1.962	1.045	3.681
(50-59 years) vs (20-39 years)	0.015	2.553	1.196	5.448
(>=60 years) vs (20-39 years)	0.005	4.185	1.553	11.278
Marital status (Married vs others)	0.032	2.766	1.093	6.998
BSE	<0.001	3.413	1.857	6.274
Family history of breast disease (Y/N)	0.019	1.848	1.105	3.091
Diagnose (Y vs N)	0.015	1.804	1.120	2.907
Smoking (Y vs N)	0.002	2.463	1.403	4.322
Q5. Breastfeeding is protective				
Marital status (Married vs others)	0.003	4.489	1.662	12.126
Employment status (employed vs housewife)	0.039	2.176	1.039	4.555
Apply for the purpose of control	0.004	2.007	1.245	3.234
Q6. Cause to lose female characteristics				
BMI (≥30) vs (18-24.9)	0.024	3.335	1.169	9.515
Q7. Gender of physician is important				
Number of births (2 vs ≥3)	0.010	0.294	.116	.750

BMI, Body mass index; BSE, Breast self-examination.

P-0724

Knowledge, Attitude And Practice Towards Osteoporosis Among Young Women

Asım Koç, Cenk Aypak, Hülya Yıkılkan, Derya İren Akbıyık, Süleyman Görpelioğlu

Department of Family Medicine, Dışkapı Yıldırım Beyazıt Training and Research Hospital, 06110 Ankara, Türkiye

Background & Aim

Osteoporosis (OP) is a global health problem. The disability due to OP is greater than that caused by cancers and is comparable that lost to a variety of chronic non-communicable diseases.

It is intuitive that primary preventive measures including early detection of risk factors for OP, educating the individuals at risk on preventive measures, and timely intervention will reduce the morbidity and mortality.

Therefore, we aimed to evaluate the knowledge, attitude and practice towards preventing OP among young Turkish women.

Methods

This study was carried out among 18-35 years old females who attended to outpatient clinics of Family Medicine Clinic in Dışkapı Yıldırım Beyazıt Training and Research Hospital. A questionnaire was used to assess knowledge, beliefs, and practices towards OP. The questionnaire to assess practices related to OP included questions on positive and negative behaviours towards OP. The positive behaviours assessed were dietary calcium intake, physical activity and exposure to sun. The negative behaviour assessed was on smoking status.

Results

A total of 218 women (mean age= 26.2 5.6 years) enrolled in study. The median score of knowledge about OP was 40, out of a total score of 100. The knowledge revealed that, 138 (63.3%) had a poor score and 80(36.7%) of the participants had a good score. In the group who had high knowledge score than median (n=80); 30% (n=24) were smokers, 8(10%) were not exposed to the sun for at least 10 minutes a day and 56.2% (n=45) of the participants achieved the Recommended Daily Allowances (RDA) for Calcium. 64 (80%) were not engaged in the recommended exercises in type and duration.

Conclusions

Awareness for OP was low and practices towards preventing OP were inadequate. An immediate need exists to promote osteo-protective lifestyle practices among young women.

Keywords: Osteoporosis, Women's Health, Health Knowledge, Attitudes, Practice

Some behavioral status of the participants

	According to information points	According to information points		According to the pre-training condition	According to the pre-training condition	
	High-score group	Low-score group	p	Positive	Negative	p
Smoking	24 (%30)	12 (%8,7)	<0,001	17 (%24,6)	19 (%12,8)	0,028
Regular exercise	16 (%20)	10 (%7,2)	0,005	11 (%15,9)	15 (%10,1)	0,2
Sun exposure	50 (%62,5)	48 (%34,8)	<0,001	39 (%56,5)	59 (%39,6)	0,019
RDA for Calcium	35 (%43,8)	34 (%24,6)	0,003	34 (%49,3)	35 (%23,5)	<0,001

P-0725

Beliefs And Behaviors of Women About Breast Cancer And Breast Self Examination

Nazli Sensoy¹, Serife Ozdinc², Nurhan Doğan³

¹Department of Family Medicine, Afyon Kocatepe University, Afyonkarahisar, Turkey

²Department of Emergency Medicine, Afyon Kocatepe University, Afyonkarahisar, Turkey

³Department of Biostatistics and Medical Informatics, Afyon Kocatepe University, Afyonkarahisar, Turkey

AIM: The health belief model is one of the models, used widely in understanding and explaining the person's attitudes and behaviors toward early detection. This study was aimed to determine the behaviors and beliefs, influencing breast cancer early detection in the content of health belief model.

MATERIALS-METHODS: The research has been planned in a descriptive nature with the population of the research constituted by the 126 women healthcare professionals who work at the University Hospital. Research data were collected by a data form which was included sociodemographical characteristics and Champion's Health Belief Scale. The scale assesses health beliefs components such as perceived susceptibility, perceived benefits of mammography screening, and perceived barriers to mammography screening. Data were analyzed with mean and percentage values, Mann Whitney U and Kruskal Wallis H tests on SPSS version 18.0 package program.

RESULTS: The mean age of women were 30 ± 6.8 years, 52.3% were married, 88.8% had high school graduates, and 52.3% were nurses. The results determined that 28.6% of the women had their regular breast self-examination (BSE) monthly, 21.4% had breast cancer in the family, 83.3% received BSE education, 55.6% of them received education before graduation. There was a significant difference in the scores on barriers between the of women healthcare professionals' who performed BSE and those who did not perform BSE and perceived barriers was low ($p < 0.02$). However, there was no statistically significant difference in the scores on benefits, confidence, susceptibility, seriousness, and health motivation between the groups and subscale scores was found to be high.

CONCLUSION: The results of this study showed that beliefs were effective on BSE performance.

Keywords: Breast Cancer, Breast Self-Examination, Early Diagnosis, Champion's Health Belief Model,

Table 1. Some Characteristics of Women's Health Staff

	n	%
Occupations		
Assistant	27	15.1
Nurse	66	21.4
Intern	14	52.4
Lecturer	19	11.1
Marital Status		
Married	66	52.4
Single	60	47.6
Education		
High school	14	11.1
College	112	88.9
Breast cancer in the friends		
Yes	23	18.3
No	103	81.7
Breast cancer in the family		
Yes	27	21.4
No	99	78.6

BSE Performance Status

Yes	90	71.4
No	36	28.6
The Incidence BSE		
Once a month	36	28.6
Engaged in irregular	50	42.8

P-0726

Women Protected with two IUDs for 10 years: A Case Report

Engin Burak Selçuk, Şule Barış, Burcu Kayhan Tetik

Department of Family Medicine, Inonu University Medical Faculty, Malatya, Turkey

Family planning includes all of the services given to families to provide them to decide to when and how many children they would have. Intrauterine devices (IUD) are one of the widely used family planning methods, in our country.

CASE: A 54-year-old, multiparous woman patient, had admitted to a healthcare institution and had an IUD inserted, as a method of birth control, 15 years ago. Then, when the patient admitted to a primary health care facility for routine smear control, 10 years ago, they couldn't visualize the removal string of the IUD and thinking that the first one had dislocated, inserted a second IUD, without taking a direct radiograph. Then the patient had admitted to a healthcare clinic to have the IUD removed, upon reaching menopause, last year. After removing the device, they obtained a direct radiography. They observed image of another IUD on the radiograph and it was understood that the woman had been carrying two devices since long time. The patient was referred to gynecology outpatient clinic of our hospital. In clinic the string of the IUD couldn't be visualized by speculum examination. Echo of the IUD was defined in the uterus with ultrasonography. The device couldn't be removed in the outpatient conditions and hysteroscopy planned. During hysteroscopy, the IUD was found to invade the myometrium. The patient underwent total abdominal hysterectomy - bilateral salpingo-oophorectomy

CONCLUSION: The family planning services are one of the most important parts of the preventive health services. As prescribed by the evidence, the patients should be monitored at regular intervals, they should be informed and complications should be discussed at every visit, and the next appointment should be planned. Updating the family physicians' knowledge about family planning periodically will contribute to the learning new methods as well as preventing possible complications.

Keywords: Family planning, IUD, Periodic examination

P-0727

Eating Disorder in Emergency Department

Veronica Parent Mathias¹, Juan Maria García Lopez¹, Lorea De Unamuno Lumbreras², Irina Yezerska³, Ana Rando Jimenez¹, Raquel Gomez Bravo⁴

¹Department of Emergency of Regional Hospital, Málaga, Spain

²Andalusian Public Health Service, Spain

³Cantabria Public Health Service, Spain

⁴Semfyc, Spanish Family Medicine Society, Spain.

Background. Case

16 year old brought to the emergency department of AP by unconsciousness while she was dancing. Before she comments her partners dizziness, but not palpitations or visual disturbances.

She Refer cramps and headache in the past two weeks. Six months ago presented an episode of abdominal and precordial pain. 5/30 menstrual cycle, but 8 months ago it disappear. Very good student, above average ratings. She has many friends and social relationships. Recent divorce of parents. Good student in the dance academy which since seven years ago, she loves dance and she refers the mother to be a professional.

Method

We conducted a clinical interview when she arrive at our Emergency Department. In the physical examination was highlighted a pale skin, thinness and The body mass index¹⁶. Tanner 3.

Asymptomatic when she arrived, we decided to refer the following analitic dates to her Family Physician because we suspect a disorder in her Eating behaviour.

RESULTS:

Potassium 2.5 mEq / L

CO₂: 29 mEq / L

Calcium: 8.2 mEq / L

Phosphorus: 4.2 mEq / L

A history of chest and abdominal pain can be able to a possible esophagitis, which may be secondary to vomiting. Amenorrhea by excessive exercise, caloric restriction and loss weight. La hypokalemia and / or low levels of ionized calcium can be the cause of cramps, headache, dizziness and heart rhythm disturbances.

Treatment and Action Plan

Requires family education, nutritional counseling and psychiatric treatment. It is derived endocrinology and to our Mental Health Unit.

CONCLUSIONS

Eating disorders appears in adolescents above 14-18 years. Clinics and a good doctor-patient relationship is essential to reach the diagnosis. The goal of the therapy in patients with Ealing disorders is to get weight regain and the own awareness of the disease.

Keywords: Eating Disorder, Syncope, Emergency

P-0728

Body composition and Eating Disorders in a woman risk population

Veronica Parent Mathias¹, Jose Ramon Alvero Cruz², Jeronimo Garcia Romero², Francisco Rivas Ruiz³

¹Emergency Department Regional Hospital, Málaga, Spain.

²Department of Sport Medicine, Andalusia Tech, Malaga University, Spain.

³Research Unit, Costa del Sol Hospital, Marbella, Malaga, Spain.

BACKGROUND AND AIM: Eating disorders (ED), anorexia nervosa (AN), bulimia nervosa (BN) and its variants are significant mental health problems affecting mainly young women and can become severe disorders, high mortality and dysfunctionality, especially students and dance professionals (risk population). For a family physicians is crucial the early diagnosis of an ED.

To determine in our risk population the sensitivity and specificity of body mass index regarding the diagnosis of eating disorders.

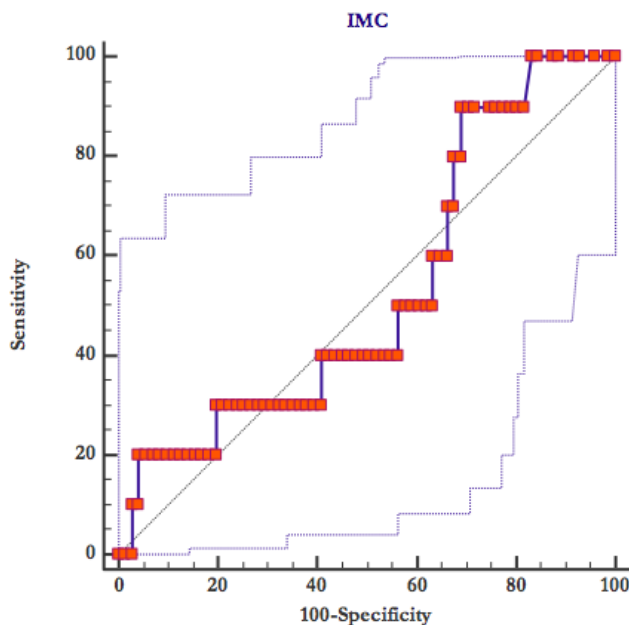
METHOD: We have studied 81 students of dance, women 13.3 ± 3.2 years, weight 45.4 ± 9.9 kg, height: 151.3 ± 12.1 cm and body mass index: 19.6 ± 2.3 kg / m². BMI was calculated conventionally. We used the EAT-26 questionnaire, administered to evaluate the ED with three subscales (dieting, bulimia and oral control). A statistical study was performed using the Spearman correlation coefficient, after rejecting the normality of the variables. Further analysis using ROC curves (Receiver Operating Characteristics), allowed to determine the sensitivity and specificity of BMI for the diagnosis of TCA. MedCalc for Windows program was used and a level of significance was set at all analyzes of $P < 0.05$.

RESULTS: The weight (Rho: -0.236) and height (Rho: -0.31): Significant correlations with age and bulimia subscale (-0.28 Rho) are found, all $P < 0.05$. ROC curve analysis, found values of area under the curve (AUC) of the BMI 0.56 ($P > 0.05$). The sensitivity and specificity (S / E) of the variable are 30% / 98%.

CONCLUSIONS: The BMI has not the highest sensitivity and specificity for the diagnosis of eating disorders. Based on the results, we suggest to study other variables of body composition to control the ED. The weight and height has a significant correlations with the age and bulimia subscale, so BMI can be used in this subscale.

Keywords: Eating Disorder, Test, Body mass index

BMI



BMI ROC curve analysis

P-0729

Is imaging necessary in women with mastalgia?

Mehmet Arslan¹, Halime Seda Kucukerdem¹, Huseyin Can¹, Ercument Tarcan²

¹Izmir Katip Celebi University Ataturk Training and Research Hospital, Family Medicine Clinic, Izmir, Turkey

²Izmir Katip Celebi University Ataturk Training and Research Hospital, General Surgery Clinic, Izmir, Turkey

Background-AIM: Mastalgia is the most common symptom in women, who has gone under breast imaging. 70% of women faces with mastalgia at least once in their lifetime (1,2). In our study, we aimed to investigate the examinations and the results of the females referred to our outpatient clinics with mastalgia and to determine the frequency of malignancy.

METHOD: Files of all the patients referred to IKCU Ataturk Training and Research Hospital General Surgery Outpatients Clinics between June - November 2014 has been investigated retrospectively. Cases only with breast pain complaint (n=308) out of 1396 women has been included in the study. Women with lump in breast, nipple discharge, redness, breast retraction and similar symptoms and pregnant and lactating women were excluded. Breast examination findings, ultrasonography (USG) and mammography results and whether biopsy is done or not has been investigated. Descriptive data has been given as mean±standard deviation (minimum-maximum values) and percentage (number).

RESULTS: Mean age was 42.4 ± 11.9 (16-74) years. 57.5% (n:177) of the women were over 41 years old, 57.5% (n:177) had bilateral mastalgia. 91.9% of the breast examinations were found to be normal. USG was required from 267 (86.6%) women but 51 (16.5%) of them didn't undergo. Out of 182 (59%) women that has been required mammography, 32 (%10.3) women didn't undergo. Pathologic investigation was required from 23 (7.4%) patients. Considering diagnoses; fibrocystic changes in 27.3% (n:84), ductal ectasia in 8.1% (n:25), fibroadenomas in 4.9% (n:15), reactive lymphoid hyperplasia in 1% (n:3) was observed. Only 1 (0.3%) woman was diagnosed with invasive ductal carcinoma.

CONCLUSION: According to researches, 0.5% of the women with mastalgia were diagnosed with breast cancer (2). In our study this rate was found as 0.3%. Considering these results, it is suggested that breast pain is not an important symptom of breast cancer.

Keywords: Cancer, breast pain, frequency

Results of USG Investigation

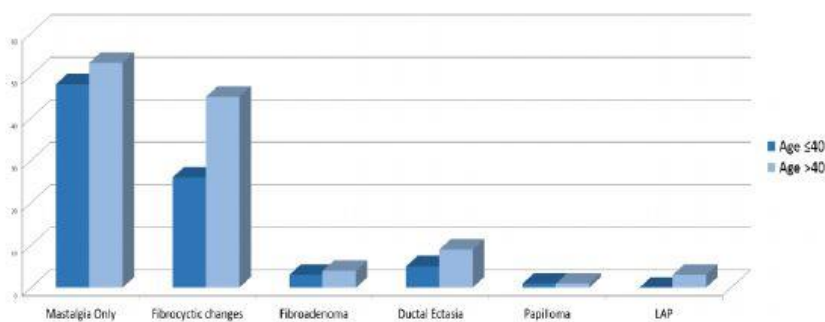
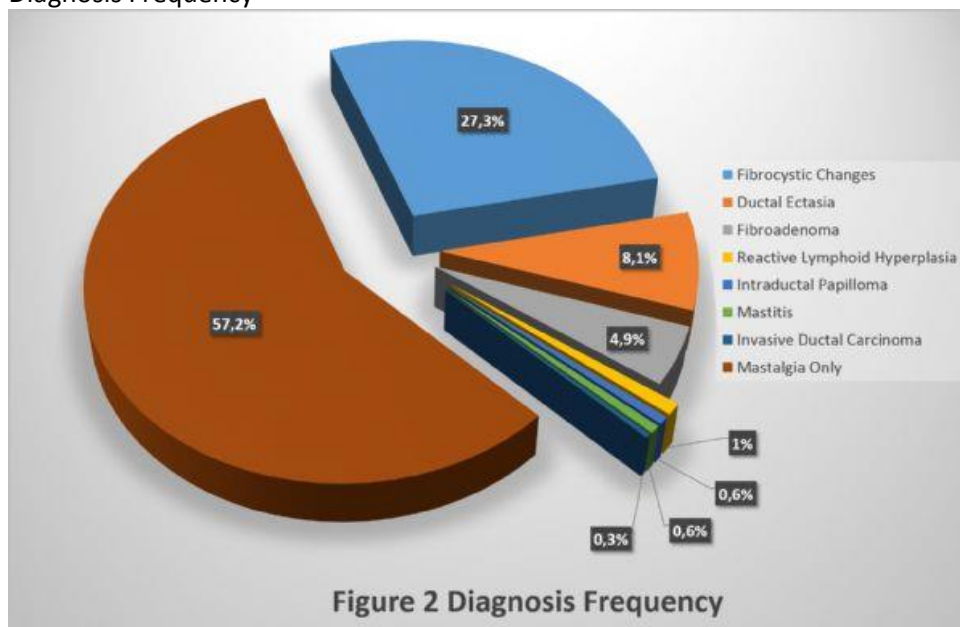


Figure 1 Results of USG Investigation

Table 1 Results of Mammography Investigation

Results	Number	In patients who made mammography (%)	In all patients (%)
BI-RADS 0	4	2,2	1,3
BI-RADS 1	48	26,3	15,6
BI-RADS 2	75	41,2	24,4
BI-RADS 3	21	11,5	6,8
BI-RADS 4	2	1,1	0,6
Womens didn't undergo mammography	32	17,5	10,3
Total	182	100,00	59

Diagnosis Frequency



P-0730

Approach and Treatment of Female Urinary Incontinence in Primary Care: a Protocol

Nuno Namora, Maria João Abreu, Luísa Feraz, Fernanda Rodrigues
 USF DuoVida - ACES Alto Ave, Portugal
 Background

Urinary incontinence (UI) is a common symptom, which can dramatically influence the physical, psychological and social well-being in affected individuals. The UI represents an important challenge for General Practitioners (GPs). Considering that the majority of patients are not treated, GPs are at the ideal position to track and address the UI. The UI prevalence increases with age and affects more women than men (2: 1). Most UI are classified as stress, urge, or mixed (combination of both symptoms).

Aim

Systematize, given the current evidence, the more appropriate diagnostic approach and treatment of female urinary incontinence in Primary Health Care.

Set recommendation standards for GPs regarding indications for referral.

Methodology

It was performed a literature review of clinical guidelines published from 2009 to December 2014, using the following keywords: urinary, incontinence, women.

Results

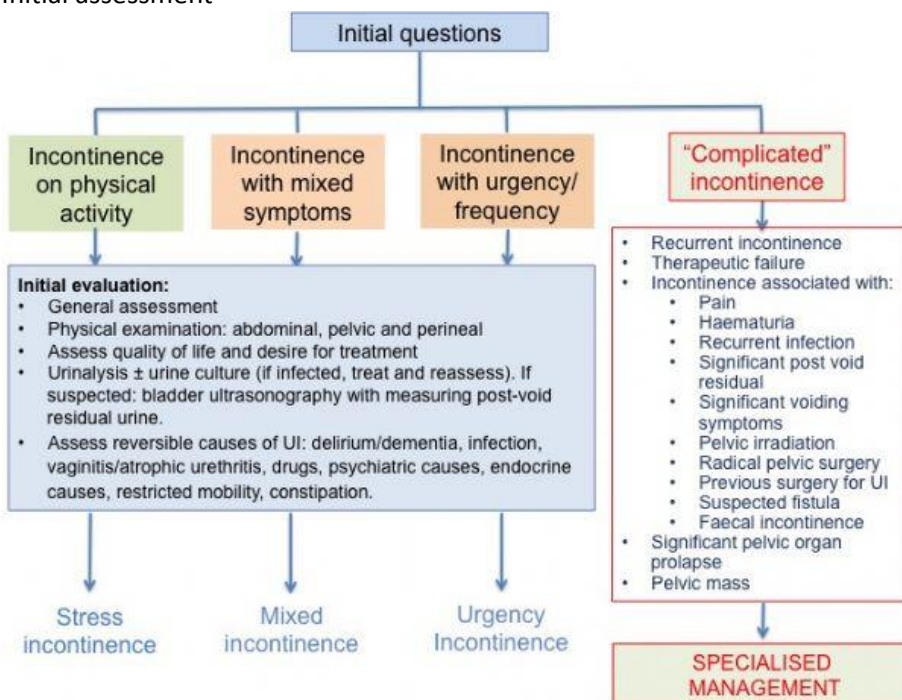
In most cases, a correct anamnesis of the patient is enough to distinguish the type of incontinence and select the cases with complicated incontinence, which requires a referral immediately. In the case of stress and urge incontinence, empirical treatments such as lifestyle changes, treatment of reversible causes of UI, training of the pelvic floor muscles, bladder training and treatment of atrophic vaginitis should be initiated. If not effective, a specific pharmacology treatment should be prescribed according to the type of incontinence. In case of failure thereof, the patient should be referred to secondary health care.

Discussion

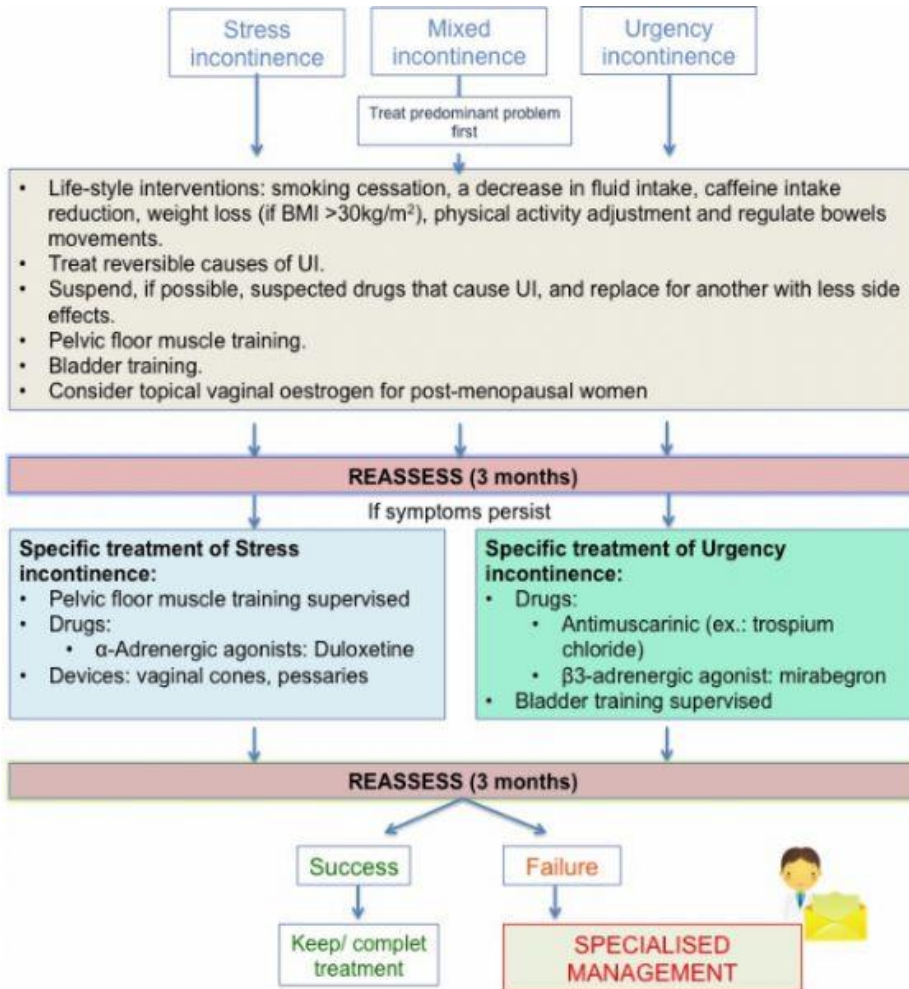
A flowchart approach and treatment of urinary incontinence can contribute to help GPs to address this problem, and more importantly, improve the quality of life of patients.

Keywords: Female Urinary incontinence, Protocol

Initial assessment



Management



P-0731

Vulvar lichen sclerosus approach in Primary Health Care

Hugo Ribeiro¹, Mariana Fonseca², Elisa Paredes³

¹Personalized Health Care Unit Barão do Corvo, Health Centers Group Grande Porto VII, Vila Nova de Gaia, Portugal

²Family Health Unit Anta, Health Centers Group Grande Porto VIII, Espinho, Portugal

³Department of Gynecology and Obstetrics, Hospital Center of Vila Nova de Gaia/Espinho, Vila Nova de Gaia, Portugal

Background and AIM:

Vulvar lichen sclerosus is a benign, chronic, progressive dermatologic condition, with an unknown etiology and an estimated range of 1 in 300 to 1000 women.

The aim of this review is to highlight the importance of early diagnosis and treatment of vulvar lichen sclerosus in Primary Health Care.

METHOD:

A review was performed for papers published between January 2005 to March 2015, in Portuguese/English, in the medical databases Medline/Pubmed and Cochrane Library.

RESULTS:

Vulvar lichen sclerosus diagnosis is based on characteristic clinical manifestations, such as vulvar pruritus, anal discomfort, dyspareunia and dysuria. Typically, it is expressed as white, atrophic papules that may coalesce into plaques.

This pathology can result in physical dysfunction and impaired quality of life. Some studies have suggested that distortion of vulvar anatomy can be prevented if treatment is initiated early in the course of the disease.

The initial management of vulvar lichen sclerosus involves patient education and medical therapy. Although many treatments have been suggested to treat it over the years, only potent or ultra-potent corticosteroids remain as the treatment of choice.

Referral to a specialist is indicated when a patient does not respond after a six months empiric therapy, when there are doubts about the diagnosis or when a vulvar intraepithelial neoplasia or carcinoma is suspected.

CONCLUSIONS:

Vulvar lichen sclerosus is an often misdiagnosed, delay diagnosed and mistreated gynecologic disease. Biopsy is rarely needed to diagnose this pathology, so family physicians are in a privilege position to early diagnose and treat this condition, preventing physical dysfunction and impaired quality of life.

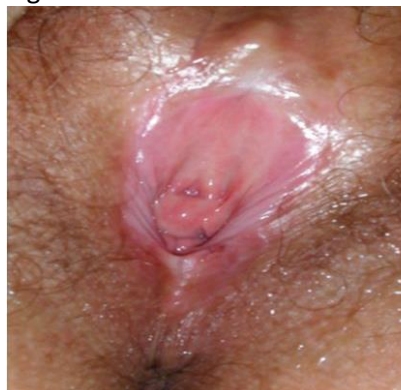
Keywords: “lichen sclerosus”, “vulva”, “vulvar disease”

Figure 1: Classic vulvar LS



The typical lesions are porcelain-white papules and plaques

Figure 2: Advanced vulvar LS



Clitoris becomes buried under the clitoral hood, the labia minora disappear, and the introitus narrows

P-0732

Life Quality Assessment among Woman with Urinary Incontinence

Daiva Puskoriute¹, Kazys Simanuskas¹, Sonata Bariliene²

¹Vilnius University, Faculty of Medicine: Clinic of Internal Diseases And Family Medicine, Vilnius, Lithuania

²Lithuanian University of Health Sciences Hospital Clinics, Kaunas, Lithuania

INTRODUCTION:

Urinary incontinence (UI) is a common, distressing and embarrassing problem. It has a big impact on the quality of life. It affects not only physical health, but also limits daily activities, mental and sexual life, has a strong impact on economic well-being as well. The research was done to assess how UI affects women's lives.

METHODS:

The research was done by anonymous questionnaire among women older than 18 years old. It had 56 questions and a block of 'King's Health Questionnaire' questions. Quantitative analysis was done by using SPSS 20.0 and MS Excel 2007. The survey was conducted in Vilnius Antakalnis polyclinics in 2014 years.

OBJECTIVES:

- to assess the impact of UI on women's daily activities, physical, mental and sexual health.
- to estimate the impact of UI on women's economical well-being.

RESULTS:

84 out of 289 women had UI and 95 % of the women with UI stated that urinary incontinence has moderate, big and very big impact on their lives. Women who do not have urinary incontinence rated their general health at the higher level than women with UI ($P < 0,05$). Also, women with UI had higher costs related with their health status ($P < 0,0001$). The highest impact of UI was on sleeping at night and reduced energy level during the next day, sexual activity, communications with friends and relatives ($P < 0,0001$).

CONCLUSIONS:

UI has a negative impact on the women's life quality. It affects negatively their daily life, physical activity, personal relationships, limits social life, disturbs sleeping, causes negative emotions. UI causes additional financial costs, and therefore has a significant impact on the women's economic situation.

Keywords: urinary incontinence, women, quality of life, King's Health Questionnaire

P-0733

Efficacy of treatment of vulvar condylomata with sinecatechins

José Damián Garcés¹, Victoria Bravo², José Luis Muñoz², Cristina González², Gregorio López², Alvaro Tejerizo², Cristina Almansa², Alvaro Díez², Jesús Salvador Jiménez², Isabel Blasco¹, Reyes Oliver²

¹Centro de Salud "General Ricardos". Madrid. Spain

²Hospital Universitario 12 de Octubre. Madrid. Spain

We report the case of a patient of 32 years referred to the Unit Lower Genital Tract with HSIL cytology and vulvar warts. In clinical interview relates the beginning of sex at 18 relationships, and reports that he has had about 60 sexual partners in the past 3 years (over 30 in the last year), not consistently used condoms, no current stable partner and is an ex-smoker. Plan with Mirena. 4 years wearer ACO was a year ago. It is not vaccinated for HPV. Colposcopy in which an atypical transformation zone type 2 acetowhite epithelium and extensive areas of mosaic grade 2. In the vulvoscopy was observed multiple warts were observed in the labia and in the perianal area.

Were also performed cervical biopsy a microlegrado. Preoperative treatment was requested and instill it with Sinecatechins for vulvar warts. With histological diagnosis of HSIL in cervical conization was performed. The

patient was cited one month after starting treatment with Sinecatequinas. He said that the response had been very good with disappearance of most of the initial warts, a fact that was observed on physical examination. However it was observed a large inflammatory and edematous reaction entire vulva although completely asymptomatic. The table was classified as allergic reaction to treatment and was prescribed topical treatment with corticosteroids. At 3 weeks the normal vulva with 3 Residual warts was observed. In conclusion, one can say that Sinecatechins are an effective tool for the eradication of vulvar warts. In our experience tolerance is good as q increases adherence. Allergic reactions, as described in this case report, are rare.

Keywords: Sinecatechins, vulvar warts

Image after administration of corticosteroids



Observed several residual condyloma

Image after treatment application



The quick response and the allergic reaction is observed treatment

Previous image to treatment Previous



Multiple vulvar warts are observed

P-0734

spontaneous twin pregnancy in a bicornuate uterus

Ana Filipa Leite Abreu¹, Maria Inês Araujo Antunes²

¹usf physis, vizela, portugal

²usf ponte, guimarães, portugal

Background & AIM:

The felling fusion of Müllerian ducts results a failure in embryonic development and occur in 0.1-3% of fertile women. The most common is the bicornuate uterus, malformation characterized by the existence of two uterine bodies connected to a common cervical channel. Inherent to this occurrence are several anomalies, however they all have a common outcome: variations in standard fertility patterns for age.

METHODS:

Clinical interview and clinical process consultation

RESULTS: Case report

31 years old multiparous woman, without infertility history, who uses a query in our Family Health Unit (USF Physis) to start a pregnancy monitoring plan. The anatomic malformation was diagnosed in youth. Against all odds both pregnancies occurred spontaneously. The 3-D ultrasound confirmed the presence of two amniotic sacs, one in each uterus. The gestational age of each fetus was respectively 6 weeks and 4 days and 3 weeks and 2 days. This fact proves the existence of different fertilization times for each fetus. It was decided to send the patient to the referral hospital as a risk pregnancy for directed care. Actually with 20 weeks, the prenatal course follows uncomplicated for mother and babies. Due to the current knowledge and patient obstetric history, the babies should be delivered by elective bilateral low transverse caesarean section.

CONCLUSIONS:

A spontaneous twin pregnancy in this context is rare and cases of term pregnancy for both fetuses are almost nonexistent. Once these cases are very rare, there is no uniform guideline to manage them appropriately. For this reason a timely diagnosis and an optimal prenatal care are essential. Due to proximity between family physician and patient, the knowledge of such cases and possible complications minimizes the risks from a non planned pregnancy.

Keywords: Bicornuate uterus; Fertility; Spontaneous twin pregnancy

obstetric ultrasound of a twin pregnancy in a bicornuate uterus



An ultrasonogram performed at 6 gestational weeks showing two embryos occupying separate horns of a bicornuate uterus.

Related cases in the literature of twin pregnancy in a bicornuate uterus

Number	Year	Reference	Status at birth	Method of delivery
1	1953	Bhagwat		
2	1957	Laird		
3	1962	Keisar		
4	1979	Green		
5	1984	Ahram	Both sane	
6	1988	Tanaka	Both sane	
7	1991	Celiloglu	Perinatal death	Uterine rupture
8	1996	Barmat	Abortion	
9	1998	Kucziynski	Both sane	Caesarean section
10	2005	Aruh	Both sane	
11	2005	Suh	Perinatal death	
12	2006	Arora	Both sane	Caesarean section
13	2011	Barquet	Both sane	Caesarean section
14	2011	Cruceyra	Both sane	Caesarean section
15	2012	Pérez-Ezquerria	Perinatal death	Vaginal
16	2013	Doruk	Both sane	Caesarean section
17	2015	Ours		

Spontaneous twin pregnancies in case of uterus bicornis unicollis were reported rarely.

P-0735

Physical, psychological, and menopause-related symptoms in a community-based sample of Turkish Women

Özlem Onur Köse¹, Dilsad Save², Alper Baba³, Orhan Gündüz⁴

¹Turkish Republic of Ministry of Health, Directorate of Istanbul

²Marmara University, School of Medicine, Department of Public Health

³Izmir Institute of Technology, Department of Civil Engineering, Izmir, Turkey

⁴Dokuz Eylul University, Department of Environmental Engineering, Izmir, Turkey

Background & Aim

Although menopause is one of the most important period in women health, the studies exploring association of individual factors such as obesity, lipid, cotinine levels, environmental factors and menopausal symptoms were in limited numbers. This study is designed to determine menopause prevalence and the relations between environmental and individual factors at over 45 years aged women in rural and urban religion.

Method

This is a cross sectional study which has been performed on a 542 women population at over 45 years aged. living in Çanakkale, Çan and Bayramiç district. Face to face questionnaire were applied and blood samples were collected. The questionnaire was consisted of socio-demographic characteristics, reproductive health issues and Menopause Rating Scale for menopausal symptoms assessment. The study was supported by the Scientific and Technological Research Council of Turkey (TUBITAK- ÇAYDAG- 106Y041).

Results

Participants average age was 60,5±10,2. Average age of menarch was 13,9±1,5 and for menopause was 45,6±5,8. Of the women 82% were postmenopausal. The most common menopausal symptom was joint complaints with

38%, and then sexual complaints with 37%. Menopausal complaints were more severe in rural region. Of the women 51% were obese and morbidly obese. The complaints were severe in overweight women. The level of Total Cholesterol were high in postmenopausal women (213±43). There were no relation between cotinine and menopause. The level of lead decreased over 10 years of menopause.

Conclusions

The study group were consist of obese, high cholesterol level women. The majority of women experienced mild or severe complaints but did not seek for health care. The health services must be accessible in all units of country and women must be counselled for gaining health promoting behaviour.

Keywords: menopausal symptoms, environmental factors, individual factors, urban/rural, health-care

Table 1. Distribution of Participants According to Their Menopausal Symptoms Severity

	Not at all		A little bit		medium		Quite severe		Extremely		Total	
	n	%	n	%	n	%	n	%	n	%	n	%
hot flashes, sweating	173	31,9	38	7,0	112	20,7	107	19,7	112	20,7	542	100,0
Cardiac complaints	260	48,0	74	13,7	115	21,2	67	12,4	26	4,8	542	100,0
Sleep disturbances	313	57,9	27	5,0	102	18,9	61	11,3	38	7,0	541	100,0
Depressed mood	207	38,2	55	10,1	140	25,8	96	17,7	44	8,1	542	100,0
irritability	182	33,6	31	5,7	153	28,3	115	21,3	60	11,1	541	100,0
Anxiety	243	44,8	38	7,0	136	25,1	93	17,2	32	5,9	542	100,0
Mental and physical weakness	57	10,5	33	6,1	130	24,0	152	28,1	169	31,2	541	100,0
Sexual problems	90	19,2	11	2,3	101	21,5	93	19,8	174	37,1	469	100,0
Urinating problems	259	47,8	45	8,3	101	18,6	82	15,1	55	10,1	542	100,0
Dry vagina	426	79,0	25	4,6	59	10,9	20	3,7	9	1,7	539	100,0
Joint and muscle pains	107	20,0	25	4,7	79	14,7	121	22,6	204	38,1	536	100,0

Multivariate Analysis of Factors Affecting Hot Flushing and Sweating

hot flashes, sweating	B	p	OR	%95 CI	
AGE (years)					
<54 *		0,042	1		
55-64	0,790	0,012	2,203	1,190	4,078
> 65	0,286	0,242	1,331	0,825	2,146
Body Mass Index					
Weak /Normal*		0,087	1		
Overweight	-0,367	0,177	0,693	0,407	1,180
Obese / morbid obese	-0,458	0,035	0,633	0,413	0,968
High Cholesterol	0,010	0,961	1,010	0,683	1,492
EDUCATION					
Above primary school graduate	0,256	0,276	1,292	0,815	2,050
WORKING STATUS					
Housewife *		0,185	1		
Unpaid family worker	0,173	0,620	1,189	0,600	2,357
Worker	0,496	0,160	1,642	0,821	3,284
Postmenopause*		0,002	1		
Perimenopause	1,461	0,001	4,312	1,859	10,004
Premenopause	1,277	0,005	3,584	1,470	8,741

Multivariate Analysis of Factors Affecting Cardiac Complaints

Cardiac Complaints	B	Standart Hata	P	OR	OR için %95 GA	
					Alt sınır	Ust sınır
AGE (years)						
<54 *			0,006	1		
55-64	0,804	0,283	0,004	2,235	1,285	3,889
> 65	0,582	0,233	0,012	1,790	1,134	2,824
BodyMass Index						
Weak /Normal*			0,521	1		
Overweight	-0,237	0,258	0,358	0,789	0,476	1,308
Obese / morbid obese	-0,191	0,204	0,349	0,826	0,554	1,232
High Cholesterol	0,297	0,187	0,112	1,345	0,934	1,939
EDUCATION						
Above primary school graduate	0,542	0,222	0,014	1,719	1,113	2,653
WORKING STATUS						
Housewife *			0,013	1		
Unpaid family worker	0,853	0,349	0,014	2,348	1,184	4,653
Worker	1,030	0,351	0,003	2,800	1,407	5,571
Postmenopause*			0,182	1		
Perimenopause	0,343	0,407	0,399	1,410	0,635	3,128
Premenopause	-0,291	0,430	0,499	0,748	0,322	1,737

P-0736

{Prenatal Screening}

Marta Sousa Santos¹, Lisete Aires Silva², Joana Andrade Barros², Simão Martins³, Umbelina Mesquita⁴

¹UCSP Boticas, ACES Alto Tâmega e Barroso, Portugal

²USF Terras Souza, ACES Tâmega 2 - Vale Sousa Sul, Portugal

³USF Hygeia, ACES Tâmega 3 - Vale Sousa Norte, Portugal

⁴USF Torrão, ACES Tâmega 3 - Vale Sousa Norte, Portugal

BACKGROUND & AIM: Prenatal diagnosis (PND) is the performance of procedures for determining whether an embryo or fetus is a carrier or not of congenital anomaly. PND includes Prenatal Screening (PNS).

PNS is used for diseases such as Down Syndrome or Trisomy (T) 21, Edwards Syndrome (T18) and Patau Syndrome (T13), but T21 is by far the paradigm of PNS, given its prevalence and relevance in social and public health. The aim of this work was to review the literature on PNS performance.

METHOD: Research in the main medical articles databases, guidelines and cross- references.

RESULTS: The 1st trimester of pregnancy is the period indicated for the performance of PNS.

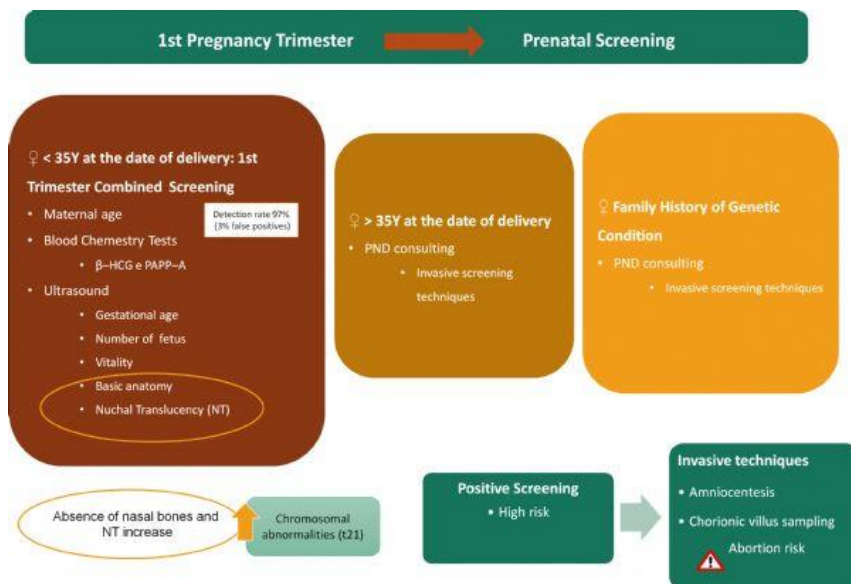
Women under 35 years at the date of delivery shall perform the combined screening of the 1st trimester. This includes maternal age, ultrasound and blood chemistry tests, and is currently accepted as the best method. The biochemical markers used are β subunit of human chorionic gonadotropin and pregnancy-associated plasma protein A. The ultrasound, among other parameters, evaluates nuchal translucency, which value, when increased, is associated to chromosomal abnormalities, including T21, as well as the absence of nasal bones.

When the screening is positive, based on a high risk, invasive techniques of screening are indicated as amniocentesis and chorionic villus sampling.

Women over 35 years at the date of delivery should be referenced to a PND consulting, as well as those with a family history of genetic condition, to perform invasive diagnostic techniques.

CONCLUSIONS: The 1st trimester combined screening is indicated for all pregnant. Most of the time the prenatal screening has a negative result which will provide a smooth pregnancy.

Keywords: Prenatal screening



P-0737

Do You Prefer Preconception Care Instead of Prenatal Care for Primary Health Care

Sultan Oksuz Zortul, [Ozlem Ozer](#)

Department of Family Medicine, Ataturk University, Erzurum, Turkey

Worldwide, maternal and child health faces rigid challenges depending on the status of development of the country. Various kind of health policies were applied from past to present day. In the last decades prenatal care was cornerstone but the effectiveness of prenatal care was limited because of its timing. Thus health care professionals emphasize importance of preconception care before prenatal care. In Turkey preconception care had been given by any doctor at the time of 1930s. Then it was given by mother and child health care centers. Nowadays family physicians give this care. The movement to establish family medicine in Turkey started at least 10 years ago.

Every woman of reproductive age who is capable of conceiving is a candidate for preconceptional care, regardless of whether she is planning to become pregnant.

Preconception care is the provision of biomedical, behavioural and social health interventions to women and couples before conception occurs. It is defined as a set of interventions that aim to increase mothers and infants' level of wellness and to avoid hazardous substances before becoming pregnant to reduce morbidity and mortality.

The core components of appropriate preconception care consist of risk assessment, health promotion, clinical and psychosocial interventions. We identified several priority areas, such as FINDS (family violence, infections and immunization, nutrition, depression, and stress) for risk assessment or BBEEFF (breastfeeding, back-to-sleep, exercise, exposures, family planning and folate) for health promotion. Physical examination also is needed to be aware of health care professionals. It should consist weight-height measure, blood pressure measure, breast examination, pelvic examination.

Preconception care prevents the barriers in front of a healthy pregnancy such as unplanned pregnancy, age related risks, family and genetic history problems.

Keywords: primary health care, preconception care, prenatal care.

P-0738

Primary Ovarian Insufficiency – a case report

Catarina Bica, Nuno Sena De Barros, Andreia Gonçalves, Ana Sofia Rua, Luís Ribeiro
USF Marquês de Marialva, Cantanhede, Portugal

BACKGROUND: Primary hypogonadism in women is defined as ovarian failure accompanied by high serum follicle-stimulating hormone (FSH) concentrations. Premature ovarian failure (POF), now called primary ovarian insufficiency (POI), is a primary hypogonadism in a woman under the age of 40 years with a normal karyotype. POI is characterized by loss of oocytes, lack of folliculogenesis and ovarian estrogen production, and infertility. The presenting symptoms are similar to those of menopause.

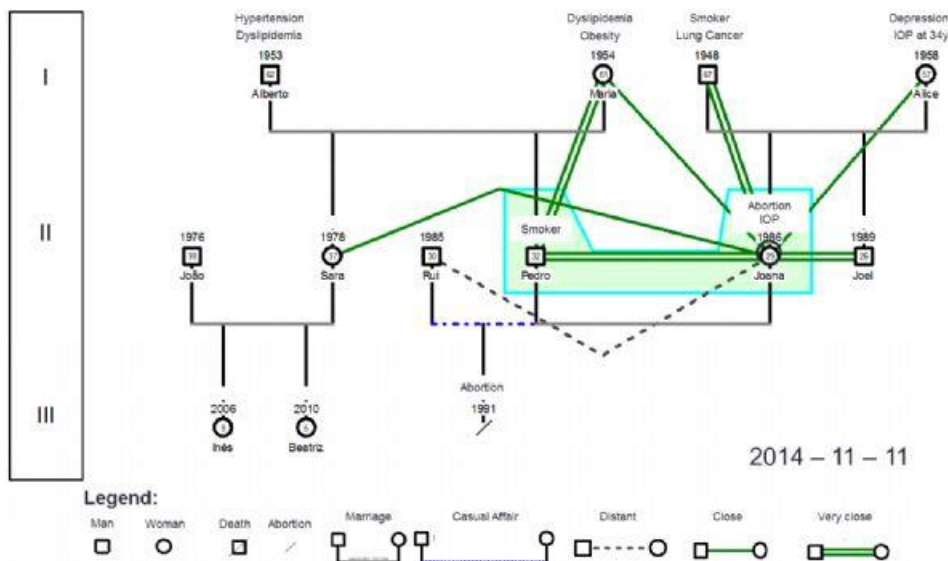
AIM: This case report aims to alert the general practitioners to these symptoms, in order to refer these women as soon as possible to reference fertility centers.

Method & RESULTS: Woman, 28 years old, designer, married, without children. Duvall life cycle fase I. Previously healthy, with menarche at 9 years old, regular cycles 28/5, G1P0: one voluntary abortion at 23 years old. Her mother and her maternal grandmother both had POI at 34 and 38 years old, respectively. She comes to our consultation for the first time complaining of amenorrhea for about six months, symptoms of estrogen deficiency with two years of evolution and failure in becoming pregnant in the last year. We asked for an analytic study and a gynecologic ultrasound. One month later she returns with the results revealing high serum FSH levels (112,0) and low estradiol <5. The anti-müllerian hormone's levels were <0,10. The patient was diagnosed with POI, confirmed in the ultrasound, and was sent to our reference fertility center to further genetic study.

CONCLUSION: There are several known causes of ovarian failure, including chromosomal defects, exposure to radiation, certain drugs and autoimmune disease. The list of mutations that can cause ovarian failure has increased rapidly, as discoveries from the human genome project increase our understanding of the factors involved in ovarian development. Unfortunately, the etiology remains unknown in approximately 75 to 90% of cases.

Keywords: primary ovarian insufficiency, FSH levels, infertility

Figure 1



Genogram and Mitchell's psycho-figure.

P-0739

Influencing factors in female physical capacity

Susana Sanchez Ramon¹, Inmaculada García Rupérez¹, M^a Del Mar De La Torre Carpenente², Yolanda González Silva⁵, Raquel Gómez Bravo⁷, Teresa Montero Carretero⁵, Carmen Fernández Alonso⁴, Yolanda Valpuesta Martín⁶, Sonia Herreros Velázquez³, Ana Belén López Tarazaga¹, M^a Jesús Rollán Gómez², Virginia Carbajosa Rodríguez¹, Raúl López Izquierdo¹

¹Emergency Department; Río Hortega University Hospital. Valladolid. Spain

²Cardiology Department. Río Hortega University Hospital. Valladolid. Spain

³Neurology Department. Río Hortega University Hospital. Valladolid. Spain

⁴Servicios Centrales. Gerencia Regional de Salud, Junta de Castilla y León. Spain.

⁵Plaza del Ejército Health Center, Valladolid: Spain

⁶Peñañiel Health Center. Valladolid. Spain

⁷SEMFYC. Spain

Background and AIM: To determine the physical parameters in pre and postmenopausal women under stress (stress test). Assess the correlation between hormone and lipid levels with the estimated MET (Metabolic Equivalent) functional capacity.

METHOD: Retrospective cross-sectional study. Inclusion criteria: Being female. Outpatient from cardiology consultations or hospitalized had been subjected to an exercise test and blood test, after signing the informed consent, from April to November 2014. Clinical analysis included lipid profile (total cholesterol, LDL, HDL and triglycerides), HbA1C and hormonal (estrogen, progesterone and testosterone). High correlation MET (MET > 8.7) was assessed among: high blood pressure (BPM_{max}), maximum heart rate (HR_{max}), FSH, LH, estrogen (E), progesterone (P), testosterone (T), total cholesterol (C), triglycerides (TG), LDL (L) and HDL (H). Statistical significance $p \leq 0.05$

RESULTS: 130 patients. Age: <50 years: 19.23%; ≥50 years: 69.23%; 15 losses. Overall: MET 7.55 (± 2.06); BPM_{max} mmHg 171.27 (± 24.42); HR_{max} 135.65 bpm (± 24.63); FSH 60.58 IU / L (± 33.33); LH 27.91 IU / L (± 16.44); E 29.78 pg/mL (± 89.43); P 1.19 ng / mL (± 2.12); T 29.13 ng/dL (± 17.48); Tg 113.89 mg/dL (± 64.48); C 205.03 mg / dL (± 43.37); LDL 123.53 mg / dL (± 37.48); HDL 58.8 mg/ dL (± 12.79).

High MET: 26 patients (22.61%). MET 10.26 (± 0.62); BPM_{max} 155.96 mmHg (± 21.17), $p < 0.01$; HR_{max} 157.08 bpm (± 21.49), $p < 0.01$; FSH 29.36 IU/L (± 30.09), $p < 0.05$; LH 22.01 IU/L (± 16.13); E 59.21 pg/mL (± 5404), $p < 0.01$; P 3.11 ng/mL (± 3.89) $p < 0.01$; T 31.45 ng/dL (± 11.38)

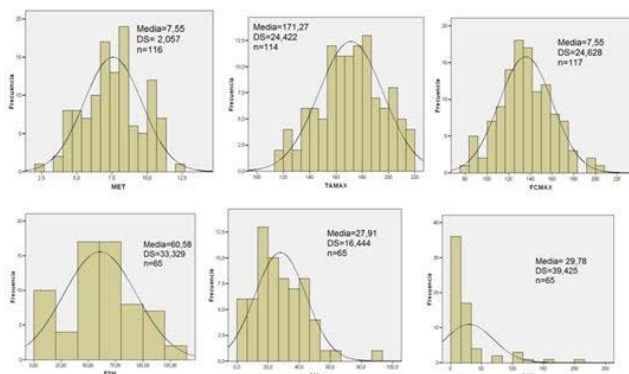
CONCLUSIONS:

Functional capacity is a strong predictor of the morbidity-mortality ratio and survival rate, while MET is an indirect measure thereof. Patients with elevated MET had significantly higher estrogen and progesterone and lower FSH levels. During exercise high MET patients responded with lower systolic BP and higher HR.

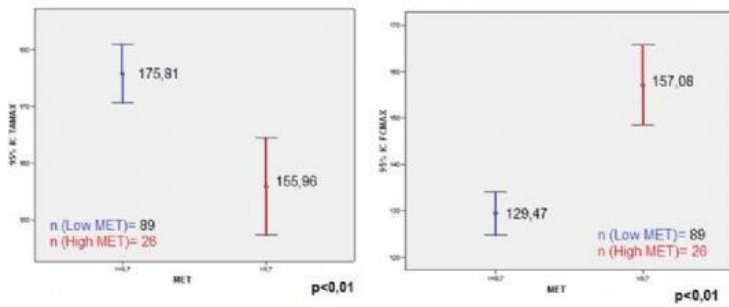
Keywords: Ergometry; Exercise test; Female

MET

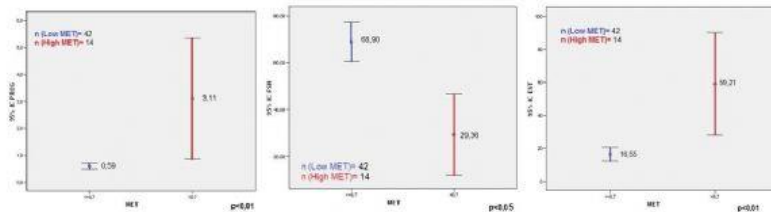
Overall:



CF Max



hormonals levels



P-0740

Articulation between Primary Health Care and Obstetrics: importance and content of the referral letter

Maria Joao Lobato Cortesao Nobre¹, Marta Renda²

¹USF Gadiana, Castro Marim, Portugal

²USF Lauroe, Loulé, Portugal

Background and AIM:

The good coordination between primary and secondary health care is essential to ensure excellence to all patients. Thus a timely and appropriate referrals, providing the hospital doctor all the necessary information, becomes crucial. During the Obstetrics stage we had the opportunity to observe the consultation requests made by Family Doctors, hearing complaints regarding the lack of information in some letters.

Therefore we decided to do a literature review regarding the referral letters, in order to understand what information needs to be conveyed between the Family Doctor and the hospital doctor.

METHOD:

This review work was based on research in Medline with the search engine Pubmed on February/2015 with the following words: “referral from primary care to secondary care” and “(((referral[MeSH Terms]) AND letter[Title/Abstract]) AND consultant[Title/Abstract]) AND ((primary care[Title/Abstract]) OR general practitioners[Title/Abstract])”. From the articles found, we select the ones written in English or Portuguese, published between January/1990 and February/2015, and excluded the ones related with specific referral to specialties non-obstetric.

We also research on Portuguese Health General Directorate and International Societies of Obstetrics webpages for documents or guidelines related with obstetrics referral.

RESULTS:

Referral and reply letters are the sole means of communication between doctors most of the time and breakdown in communication could lead to poor continuity of care, delayed diagnoses, polypharmacy, increased litigation risk and unnecessary testing.

Studies reported that specialists are dissatisfied with referral letter’s quality and content.

In the field of maternal-fetal medicine, incomplete referral letters that fail to comprehensively identify pregnancy risk factors can have significant implications for pregnancy management and delivery planning.

CONCLUSIONS:

The routine use of patient questionnaires or referral letter templates, the development of local referral

guidelines, and regular clinician education are some recommendations to improve the referral communication and save time for both general practitioners and specialists.

Keywords: referral letters; Primary care; Obstetrics

Referral Letter



P-0741

Females have severe anxiety than males

Asli Ebiloglu¹, Umit Aydogan², Oktay Sari², Halil Akbulut³, Mehmet Ak⁴, Murat Erdem⁴, Aytekin Ozsahin⁴, Kenan Saglam⁵

¹Oran Outpatient Clinic, Primary Care & Family Health Center, Beytepe Military Hospital, Ankara, Turkey

²Department of Family Medicine, Gulhane Military Medical Faculty, Ankara, Turkey

³Akinci Outpatient Clinic, Primary Care & Family Health Center, Etimesgut Military Hospital, Ankara, Turkey

⁴Department of Psychiatry, Gulhane Military Medical Faculty, Ankara, Turkey

⁵Department of Internal Medicine, Gulhane Military Medical Faculty, Ankara, Turkey

AIM: Generalized anxiety disorder (GAD) seems to affect population in different levels. Gender difference is one of the factors for anxiety severity. Prevalence of GAD is 2 fold higher in females. In this research, we aimed to identify the Beck Anxiety Scale Score (BASS) differences according to gender.

METHOD: A total of 73 patients enrolled in this study. BASS levels of female and male patients were compared. SPSS 20 for Mac used to analyze the data. Mann-Whitney U test was used to compare the groups.

RESULTS: There were 61 (83.6%) female and 12 (16.4%) male. The mean BASS in female and male patients were 26.18 ± 10.17 (7-57) and 18.83 ± 11.53 (4-49), respectively ($p=0.007$).

CONCLUSIONS: Female patients were higher BASS than males.

Keywords: Anxiety, Woman, Severity

P-0742**Menopause And Thiol/Disulphide Homeostasis**

Basri Furkan Dağcıoğlu¹, Tuncer Kılıç¹, Ahmet Keskin¹, Aylin Baydar Artantaş², İrep Karataş Eray², Yusuf Üstü¹, Mehmet Uğurlu¹

¹Department of Family Medicine, Yıldırım Beyazıt University, Faculty of Medicine, Ankara, Turkey

²Family Medicine Clinic, Atatürk Training And Research Hospital, Ankara, Turkey

Background/AIMS: Thiol/ disulphide homeostasis has a critical role on cellular events like antioxidant protection and apoptosis. There is also a growing body of evidence demonstrating that an abnormal thiol disulphide homeostasis state is involved in the pathogenesis of a variety of diseases. It is shown in many studies that the depletion of estrogen in postmenopausal period could cause oxidative stress. We aimed to investigate the relationship between menopause and thiol/disulphide homeostasis which is a new indicator for the oxidative stress.

METHODS: Thiol / disulphide homeostasis parameters were studied in the blood samples of 25 postmenopausal women and 29 women in reproductive period in the control group, who were 18 years or over and admitted to outpatient clinic of our hospital between December 2014 and March 2015. Subjects were selected from 574 patients according to exclusion criteria including history of chronic disease, smoking, alcohol consumption and malignancy. Venous blood samples were obtained from patients and centrifuged for 15 minutes at 3600 rpm to obtain plasma. After that, native thiol, disulphide, total thiol, index 1 (disulphide/native thiol), index 2 (disulphide/total thiol) and index 3 (native thiol/total thiol) levels were measured. Statistical analyzes were performed on 54 patients. All statistical analyzes were performed with IBM SPSS Statistics (V.16) computer program. $P < 0,05$ was accepted as statistically significant.

RESULTS: Native thiol and total thiol levels of postmenopausal women were significantly lower than the control group [($p < 0,001$; $Z: -4,45$) and ($p < 0,001$; $Z: -3,94$) respectively], whereas index 1 ($p: 0,006$; $Z: -2,76$) and index 2 ($p: 0,006$; $Z: -2,23$) levels were witnessed higher. (Table 1)

CONCLUSION: These findings are the first results of our continuing study and we aim to finish the process with higher amounts of patient data in order to publish the final results. Further studies may reveal the clinical importance of dynamic thiol/disulphide homeostasis on many conditions like postmenopausal period.

Keywords: Thiol Disulphide Homeostasis, Menopause, Oxidative stress

Table 1

Parameters	Groups	N	Mean Rank	p	Z
Native Thiol	Reproductive period	29	36.34	<0.001	-4.45
	Postmenopausal	25	17.24		
	Total	54			
Disulphide	Reproductive period	29	25.66	0.353	-0.92
	Postmenopausal	25	29.64		
	Total	54			
Total Thiol	Reproductive period	29	35.34	<0.001	-3.94
	Postmenopausal	25	18.40		
	Total	54			
Index 1	Reproductive period	29	22.10	0.006	-2.76
	Postmenopausal	25	33.76		
	Total	54			
Index 2	Reproductive period	29	23.17	0.025	-2.23
	Postmenopausal	25	32.52		
	Total	54			
Index 3	Reproductive period	29	30.17	0.176	-1.35
	Postmenopausal	25	24.40		
	Total	54			

P-0743

Assessment of Home Care Services Concerning Women's Health

Nevgül Demir¹, Yüksel Kurban², Nevhayat Gouwy³, Nursen Kurban¹, Didem Sunay¹

¹Department of Family Medicine, Kecioren Training and Research Hospital, Ankara, Turkey

²Department of Obstetrics and Gynecology, Kecioren Training and Research Hospital, Ankara, Turkey

³Sisli Central Family Health Center, Istanbul, Turkey

BACKGROUND: The aim of our study is assessing home care services concerning women's health by means of gynaecologic and urogynecologic problems such as urinary incontinence and genital cancers and pointing out possible deficits to support the reorganization of the team work in this area. **METHODS:** A questionnaire is applied by face to face interviews during consecutive home visits by the caregivers to 100 women who were receiving home care services. **RESULTS:** The mean age of patients was 67, 95±12, 93 (22-84). Their primary diseases registered by home care services were 33% cerebrovascular accident, 16% Alzheimer-dementia, 8% various orthopedic interventions, 6% cardiovascular disease. Concomitant diseases were mainly hypertension (57%), diabetes mellitus (46%), osteoporosis (18%), chronic obstructive pulmonary disease (15%) and besides 63% neurological deficits, 17% orthopedic problems and 5% malignancy were registered; Only 46 out of 100 patients could be questioned directly without the help of family members and 35 of these 46 patients (76%) had gynecologic or urogynecologic complaints. **CONCLUSION:** A significant proportion of old women suffer from serious urogynecologic health problems, which necessitates more efforts for care of them.

Keywords: home care, women's health, gynaecologic problems, urogynecologic problems

Primary diseases of older women patients that caused a demand for home care services

Primary diseases	n	%
Cerebrovascular accident	33	33
Alzheimer-Dementia	16	16
Cardiovascular disease	11	11
Orthopedic interventions	8	8
Mental retardation	4	4
Multiple sklerosis	4	4
Lower extremity amputation	3	3
Morbid obesity	3	3
Generalized osteoarthritis	3	3
Bilateral loss of vision	2	2
Parkinson	2	2
Epilepsy	2	2
Chronic renal insufficiency	2	2
Cerebral palsy	1	1
Amyotrophic lateral sclerosis	1	1
Common geriatric problems	5	5
Total	100	100

Gynecologic and urogynecologic complaints of patients who could answer to the questions

Gynecologic and urogynecologic complaints	n	%
Urinary incontinence	19	41.3
Vaginal bleeding	11	23.9
Pelvic pain	3	6.5
Fluor vaginalis	2	4.3
No complaints	11	23.3

P-0744

Sacral Insufficiency Fracture in a Pregnant Women

Hatice Guler, Yasemin Alagoz, Merve Erdogan
Konya Education and Research Hospital

PURPOSE

Insufficiency fractures are caused as a result of exposure of the bone whose elasticity decreased to normal or physiological stress. It is frequently seen in the elderly women having osteoporosis. But, it can be seen rarely in pregnancy or postpartum period. Sacral insufficiency fractures have no specific symptoms and also its radiography findings are frequently normal. In this paper, the clinical and radiologic findings of sacral insufficiency fracture are discussed.

CASE REPORT

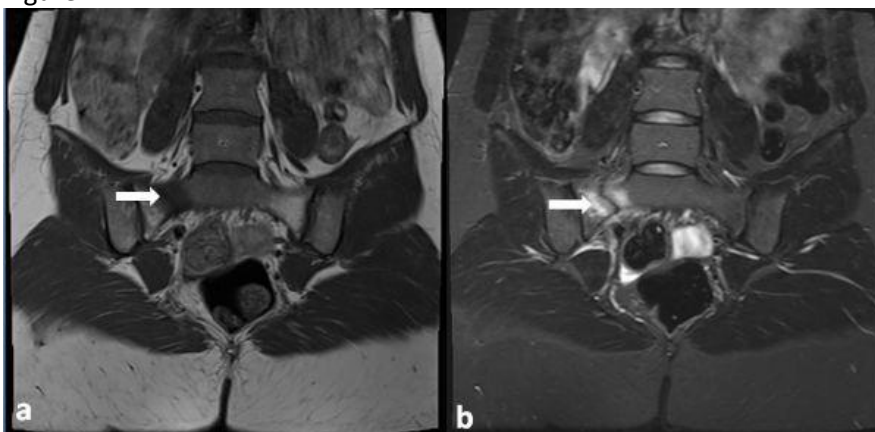
A 32-years-old female patient applied to our hospital with complaints of low back pain started in her pregnancy and increased after the delivery. Low back pain were painful and restricted particularly in the right side in the physical examination. Laboratory and radiography findings were normal. MRI examination was performed to determine the reason of pain. Linear hypointense fracture line was seen on T1 weighted series in the sacrum, and edematous signal changes was also seen adjacent to the fracture line as hyperintense areas on fat saturated T2-weighted images.

DISCUSSION

Sacrum insufficiency fractures are seen particularly in elderly women who are above 60 years old and have osteoporosis. It is rarely seen in pregnancy and postpartum period. Vaginal delivery, overweight baby, forceps use, heparin use, gaining over-weight, reduction in maternal calcium intake and vitamin D deficiency increase the risk of sacral insufficiency fracture in postpartum period. The most frequent symptom is back and low back pain. Treatment tends to be conservative. The first step is pain control. Bed rest, acetaminophen, analgesic and anti-inflammatory agents and physical therapy modalities may be used until the pain is removed. Sacrum insufficiency fracture should be certainly considered in differential diagnosis although it is an atypical case in evaluation of low back and hip pains in pregnancy and postpartum periods.

Keywords: pregnancy, sacral, fracture, insufficiency

Figure 1



Linear hypointense fracture line was seen on T1 weighted series starting from the sacrum ala extending to neural foramens localization in right sacrum (Figure 1a). Edematous signal changes (bone marrow edema) was also seen adjacent to the fracture line as hyperintense areas on fat saturated T2-weighted series (Figure 1b)

P-0745

Thinking hypothyroidism in a patient with anemia of chronic disease and hyperlipidemia: Case report

Serdar Mingir¹, Nazli Sensoy²

¹serdar mingir

²nazli sensoy

Thinking hypothyroidism in a patient with anemia of chronic disease and hyperlipidemia: Case report

AIM: The patient with anemia of chronic disease and hyperlipidemia presented management of hypothyroidism considering the patient's symptoms and signs.

METHODS: A review of the literature was made. **RESULTS:** A 41 year woman came with complaint of fatigue, overweight (BMI:39), constipation and depression. Detailed history of the patient was taken. There were early menopause (36 year). In family history, her daughter had type 1 diabetes mellitus and hypothyroidism. Physical examination of the patient was apathic view, alopecia, dry skin, fragile nails, thyroid palpable, trace amounts of bilateral pretibial edema and obesity. Blood investigations, detected hypochromic microcytic anemia, hypertriglyceridemia and hypercholesterolemia (see Table I). Differential diagnosis, It was considered the infection, vitamin deficiency, hypothyroidism, anemia, and may be connected with obesity. Patient's signs and symptoms were evaluated for hypothyroidism (see Table I). In these parameters, we thought that etiology of anemia of chronic disease and hyperlipidemia was detected in hypothyroidism. Thyroid function tests, thyroid peroxidase antibody and thyroid ultrasonography were made. We determined Hashimoto's thyroiditis. Levothyroxine 50 mg / day and 20 mg fluoxetine (for depressive mode) treatment was started. 6 weeks after the control laboratory tests showed (see Table I). Levothyroxine dose of 100 mcg / day was set. Patients complaints decreased and she is follow-up.

CONCLUSION: Anemia of chronic disease and hyperlipidemia associated with cases should be detailed history. Hypothyroidism symptoms and signs must be identified. Hypothyroidism is a common cause of anemia of chronic disease and hyperlipidemia.

Keywords: hypothyroidism, hyperlipidemia, anemia of chronic disease

Table 1. Biochemical and Hormonal Laboratory Parameters

Parameters	Before treatment	After treatment	Reference range
HGB	11,7 g/dL	11,6 g/dL	12-17.0
RBC	5,56×10 ⁶ /u	5,59×10 ⁶ /u	3.80-6.00
HCT	37,3	34,2	%33.0-50.0
MCV	67,1fL	61,1fL	80.0-100.0
MCH	21.1pg	20.7 pg	25.0-33.0
MCHC	31.4gr/dL	33.9 g/dL	28.0-39.0
RDW	16.9	14.2	9.0-15.0
Ferritin	141,6 ng/mL		13.0-150.0
Total cholesterol	154,4 mg/dL	229 mg/dL	<200
Triglycerid	694,3 mg/dL	177,4 mg/dL	<200
HDL cholesterol	42,2 mg/dL	49,2 mg/dL	40-60
LDL cholesterol	200,5 mg/dL	172,5 mg/dL	<130

VLDL cholesterol	138,86 mg/dL	35,48 mg/dL	<100
Free T3	0,53 pg/mL		1,8-4,6
Free T4	0,13 ng/dL	0,81 ng/dL	0,89-1,80
TSH	>100 uIU/mL	41,59 uIU/mL	0,27-4,2
Anti TPO	Positive		

P-0746

Prevalence of Obesity Among Lebanese Women

Yasser Yaghi¹, Shadene Yaghi², Zahra Saad², Ahmad Hesso¹

¹Beirut Arab University-Lebanon

²American University of Beirut-Lebanon

INTRODUCTION:

Overweight has become an epidemic problem worldwide and is the most rapidly growing form of malnutrition in the developed world. It is responsible for the increasing prevalence of serious health outcomes and is a leading preventable cause of death.

The aim of this study was to describe prevalence of overweight among Lebanese women over a period of 4 years and in lower socio-economic groups living in South Lebanon, an under privileged region.

Subjects and METHODS:

Data was collected from 825 ambulatory Lebanese women attending out-patient clinics in one Hospital between 2010 and 2013. All subjects were submitted to Osteodensitometry unit for routine check-up for osteoporosis. Indicators recorded were: age, height, weight, gender, Body Mass Index (BMI), Total body Fat (TBF), Gynoid fat and Android Fat. Data was analyzed using the statistical package for social sciences (SPSS).

Overweight was defined as BMI between 24.9 and 29.9kg/sqm. TBF was considered above average when it was 40% for women 41 to 60 years.

RESULTS:

The mean age of women studied was 60.92 years (SD 10.93 years). The mean BMI was 30.15kg/sqm (SD 5.22kg/sqm) while the mean TBF was 45.99% (SD 6.30%). The mean android fat was 49.76%, while the mean gynoid fat was 50.24%

CONCLUSION:

The findings of this study highlight prevalence of overweight among Lebanese women which appeared to be stable over the study period. The Total Body % Fat was above average. These findings should alert to the importance of formulating strategies to curb the progression of overweight in Lebanon. And The alarming increase in obesity prevalence raise questions about its implications for health and disease burden in Lebanon.

Limitations:

The majority of adults studied belong to a low socio-economic groups.

Keywords: BMI, TBF, Lebanon

P-0747

Ocular complication following zoledronic acid infusion

Lana El Osta¹, Badi El Osta²

¹Department of Public Health, School of Medicine, Saint-Joseph University, Beirut, Lebanon

²Georgia Regents University Cancer Center, Augusta, GA, USA

BACKGROUND AND AIM: Short-term clinical trials and subsequent extensions are not powered to detect rare adverse events such as ocular complications related to bisphosphonates. Given the large and growing number of patients receiving these medications, it is likely that physicians may encounter some patients with these side effects.

The aim of this case presentation is to recognize an inflammatory ocular complication in a patient on bisphosphonate, and to inform the patient on the eventuality of this complication before initiating the medication.

METHODS: We present a case of a recurrent acute blepharitis after the infusion of zoledronic acid.

RESULTS: A 62-year-old osteoporotic female presented for management of a recurrent swollen left eye since the introduction of the zoledronic acid 3 years earlier. It was initially painless, and appeared 48 hours after each infusion, with spontaneous and complete resolution 5 days later. Lately, the recurrent swollen eye lasted longer and was more expanded. It was associated to burning, dryness, and photophobia with no diplopia. Ophthalmologic exam including a slit-lamp showed edema and redness of the left upper lid, with no exophthalmos, and no elevated intraocular pressure. The vision was unaffected. A swabbing of the eyelid secretions was negative for bacteria and fungi. A topical treatment was administered, including steroid eye drops and ointment as well as artificial tears, and lid hygiene recommended. Two weeks later, the woman was completely recovered.

CONCLUSION: Bisphosphonates are widely used for the treatment of osteoporosis. Healthcare care providers should be aware of ocular complications related to these medications and must inform their patients, so that they can seek immediate assessment.

Keywords: Bisphosphonates, Osteoporosis, Recurrent blepharitis, Ocular complications

Unilateral acute blepharitis in a female patient receiving zoledronic acid for postmenopausal osteoporosis



Imputability of the zoledronic acid

To assess the imputability of the zoledronate, the WHO Causality Guide of Suspected Adverse Reactions was used. This case of periorbital inflammation may be classified as “certain” adverse effect of the zoledronic acid because it satisfied the following criteria:

- Plausible time relationship to the bisphosphonate intake
- Plausible response to the rechallenge and dechallenge
- Absence of concurrent disease or other drugs predisposing to the complication. No new treatments have recently been initiated. There were no indicators of any other diagnosis with the patient: no previous ocular diseases, no clinical signs of seborrheic dermatitis or rosacea, no history of new allergen introduction, no evidence of infection,...

P-0748

Preferences of Pregnant Women in the Central District and Surrounding Areas of an Eastern Province in Turkey for Cesarean or Vaginal Birth, and Associated Factors

Edibe Pirincci¹, Berrak Yildirim Aksakal², Ibrahim Halil Akkus²

¹Firat University School of Medicine. Department of Public Health, Elazig/TURKEY

²Public Health Institution, Elazig/TURKEY

BACKGROUND & AIM: The aim of the study is to identify the rate at which pregnant women in the central district and surrounding areas of an eastern province in Turkey prefer cesarean versus vaginal birth and to reveal the associated factors.

METHOD: The population of the study comprised pregnant women who were registered for one of the 173 family practice centers located in the center and surrounding districts of Elazig, Turkey, and who visited one of such family practice centers for a routine pregnancy check up during the period of time that coincided with the study. The survey was administered to the first four of these visiting pregnant women. The sample contained 628 pregnant women. **RESULTS:** The mean age of the pregnant women was 28.52±5.43 years. For the question as to their preferred mode of birth in the absence of any medical indication for cesarean birth and given the opportunity to choose either mode of birth, the responses were distributed as follows: cesarean birth (17.8%). A significant increase was observed in the preference for cesarean birth as educational status and income level increased ($p<0.05$). Among the pregnant women who had already had a cesarean birth, a significant proportion stated that they would prefer that mode again ($p<0.01$). Similarly, those with a previous experience of miscarriage chose to have a cesarean birth for their current pregnancy ($p<0.05$). The number-one reason for the preference of vaginal birth was viewing it as "healthier and better," followed by "early recovery." However, the factors in the preference for cesarean birth were as follows (in descending order): "fear of vaginal birth," "the wish to avoid pain."

CONCLUSION: Pregnant women have high levels of preference for cesarean birth. It is recommended that information activities should be organized so as to allay their fears.

Keywords: pregnant, cesarean birth, vaginal birth, preference

P-0749

"{"How dressing styles of women effects Vitamin D levels?"}"

Neslihan Övet, Gülsen Ceyhan Peker, Ayşe Selda Tekiner

Department of Family Medicine, Ankara University School of Medicine, Ankara, Turkey

“Background and AIM: The aim of this research was to investigate the prevalence of Vitamin D (Vit D) deficiency and relationship of this with dressing styles of women.

METHODS: This cross sectional study was conducted at Ankara University School of Medicine Outpatient clinics of Family Medicine and Physical Therapy and Rehabilitation between May- October 2012 and at the same months in 2013.

312 premenopausal women whose Vit D values were analysed before for their complaints were interviewed face to face during their control visit. Participants were divided into two groups according to their dressing styles (Veiled or modern clothing style).

RESULTS: Vit D deficiency among all participants were 66%. Severe Vit D deficiency was 23%, only 9.3% of the whole group had normal levels. When we compared normal Vit D levels of veiled women to women with modern clothing, only 3.7% of the first group had normal levels whereas this was 13% in the second group ($p<0.05$).

Severe Vit D deficiency (44.4%) and inadequacy (43%) were more prominent in veiled women whereas these levels were 6.8% and 43.5% respectively in women of modern clothing. This situation may result from restricted sun exposure and permanently being in closed areas like houses. CONCLUSION: The community should be informed about the importance of sun exposure and Vit D.” ”

Keywords: Vitamin D, Women, Clothing style

Figure 1. Mean values of Vitamin D in two groups

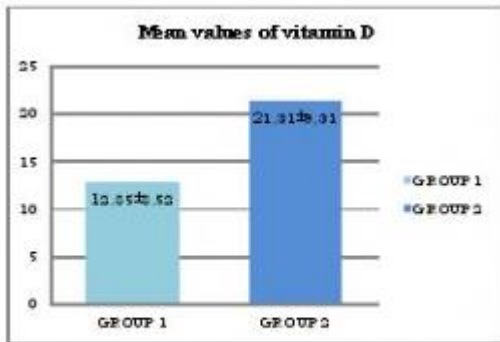
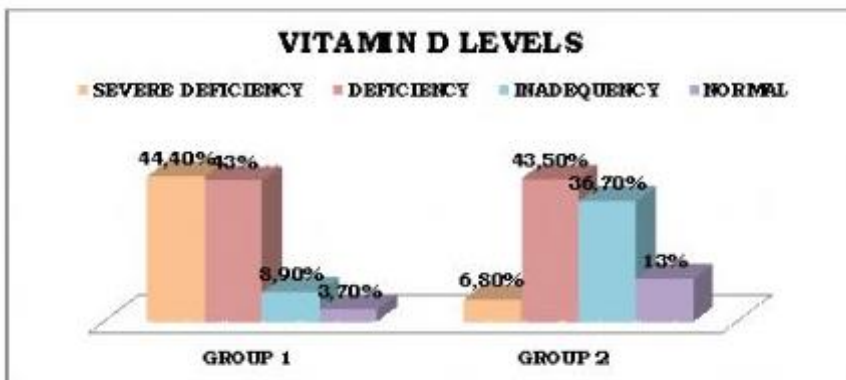


Figure 1. Mean values of Vitamin D in two groups

Figure 2. Levels of Vitamin D among the two groups.



P-0750

The Frequency of Smoking Exposure Among Pregnant Women

Yusuf Akyüz¹, Oktay Sari¹, Mustafa Dinç², Ümit Aydoğan¹

¹Gulhane Military Medical Academy, School of Medicine, Department of Family Medicine, Ankara, Turkey

²Gulhane Military Medical Academy, School of Medicine, Department of Endocrinology and Metabolism, Ankara, Turkey

Introduction

Smoking and exposure to cigarette smoke may cause some problems both for mother and her fetus during pregnancy. Detailed questioning about smoking habits of pregnant and counselling have an important place in the first step in the course of observing. In our study, we evaluated smoking and passive smoking status of pregnant women.

Method

The pregnant were included in our study admitted to our outpatient clinic. A questionnaire was filled by pregnant including the demographic characteristics and smoking habits of the pregnant, and characteristics of smokers where living in a household with them and analysis was performed in accordance with this data.

Findings

The average age of the 188 women who recruited the study was 29.37 ± 6.02 years (18-42 years). There were 17 pregnant in the first trimester (9%), 28 in the second trimester (14.9%) and 143 in the third trimester (76.1%). When asked about the smoking habits of pregnant, it was learned that 168 women did not smoke (89.4%). 136 of them (%72,3) had never smoked so far, and 32 (%17) gave up smoking because of pregnancy. 20 (%10,6) smoked sometimes during pregnancy. 12 smoker (%60) had high school and upper graduation. When asked to pregnant women whether anyone to smoke or not to smoke in their homes, although 104 pregnant (%55,3) replied no, 84 women (%44,7) replied yes. When they were asked about who smoked in the house, 54 of them (%64) consisted of their spouses.

Conclusion

It is understood that smoking is a kind of illness and smokers must be treated. Pregnancy is an important period of life. Smoking is a preventable risk factor, and the counseling training and the pregnancy monitoring performed at regular intervals are important for maintaining a healthy pregnancy, and the role of family physicians is significantly great in here.

Keywords: Pregnancy; Smoking; Smoke exposure

P-0751

Relationship between vaginal infection and anemia during pregnancy

Daiva Dvareckyte, Egle Zekonyte, Kazys Simanuskas

Vilnius University, Faculty Of Medicine: Clinic of internal diseases, family medicine and oncology, Family medicine center, Vilnius University, Vilnius, Lithuania

Background and AIM: Vaginal infection is the most common reason for women applying to the family doctor or obstetrician-gynecologist, accounting for about 60-70 percent all gynecological pathology. One of the risk factors potentially having a connection with vaginal infection is anemia, which is still one of the most common public health issues, in both developing and developed countries. Anemia during pregnancy not only has a negative effect on both mother and fetus and often leads to unfavorable pregnancy, childbirth outcomes, but also weakens the immunity of pregnant women, which leads to changes in the vaginal ecosystem and the occurrence of vaginal infections. The aim of the study was to find links between vaginal infections and anemia during pregnancies in the Family medical center of Vilnius University Hospital Santariskiu clinic in Lithuania.

METHODS: A total of 498 medical records of pregnant women were included as a study subject from year 2011 to 2014. The main hematological indicators (Hgb, Hct, MCV, MCHC) and vaginal smear results (leukocytes, agents) during pregnancy were assessed. The data was processed and analyzed using Microsoft Office Excel 2007 and the

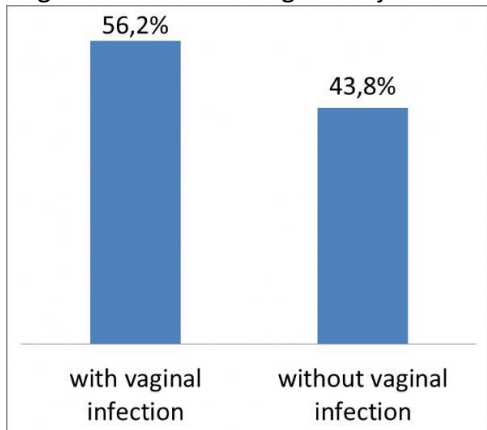
Statistical Package for Social Science version for Windows 17.0. The statistical difference was considered significant if the P value was below 0.05.

RESULTS: The analysis showed that the prevalence of prenatal vaginal infection morbidity among all subjects, was 56.2% (n=280) and anemia - 38% (n=188). Anemia was diagnosed in 39% (n=109) of patients with vaginal infection. There was no significant difference between anemia and vaginal infection during pregnancy.

CONCLUSIONS: The study showed that anemia among pregnant women has a connection as a risk factor to vaginal infection in Santariskiu clinic Family medical center.

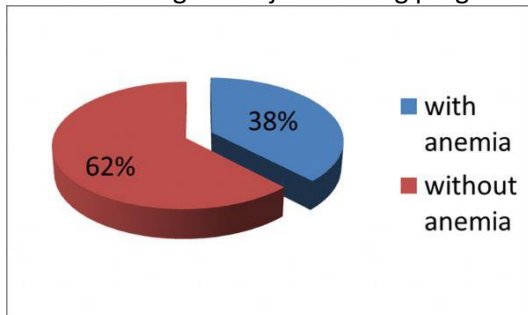
Keywords: pregnancy, vaginal infection, anemia

Vaginal infection among all subjects during pregnancy



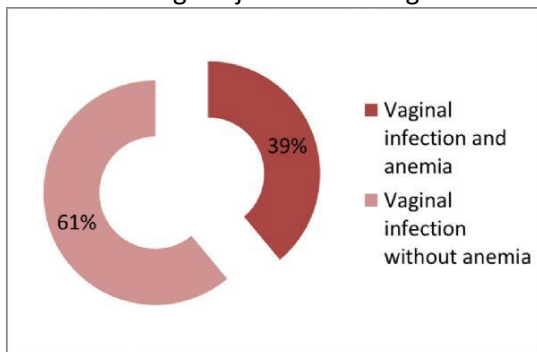
[picture 1]

Anemia among all subjects during pregnancy



[picture 2]

Anemia among subjects with a vaginal infection during pregnancy



[picture 3]

P-0752

Analysis of the treatment for vaginal infection during pregnancy

Daiva Dvareckyte, Egle Zekonyte, Kazys Simanauskas

Vilnius University, Faculty Of Medicine: Clinic of internal diseases, family medicine and oncology, Family medicine center, Vilnius University, Vilnius, Lithuania

Background and AIM: Vaginal infection is the most common reason for both pregnant and not pregnant women applying to the family doctor or obstetrician-gynecologist. The aim of the study was to carry out a vaginal infection treatment analysis during pregnancy in the Family medical center of Vilnius University Hospital Santariskiu clinic in Lithuania.

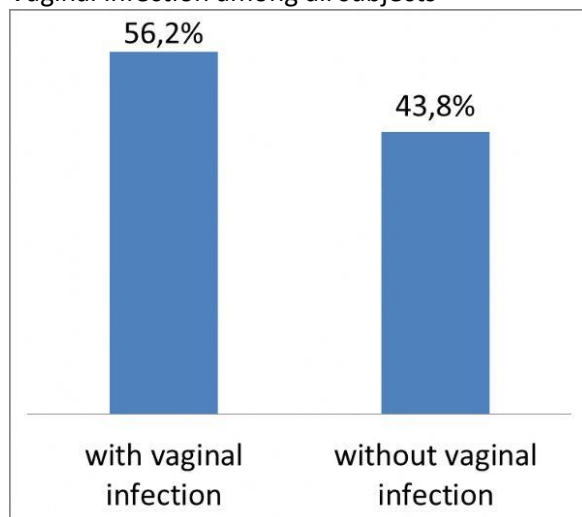
METHODS: A total of 498 medical records of pregnant women were included as a study subject from year 2011 to 2014. The main symptoms (vaginal irritation, painful intercourse, vaginal discharge, bleeding after intercourse), vaginal smear results (leukocytes, agents) and the treatment during pregnancy were assessed. The data was processed and analyzed using Microsoft Office Excel 2007 and the Statistical Package for Social Science version for Windows 17.0. The statistical difference was considered significant if the P value was below 0.05.

RESULTS: The analysis showed that prevalence of prenatal vaginal infections morbidity among all subjects was 56.2%. 70% of them were assigned treatment, $p < 0.05$. Symptoms occurred among 36% of pregnant women with vaginal infection, $p < 0.05$. Whereas vaginal smear results found 39% Gram rods negative, 31% Gram cocci positive, 28% candida, and 1% Gram rods positive, indicator cells, gonococci and trichomonas each, $p > 0.05$. Leukocytes covering the field of vision occur in 44% of vaginal smears, > 20 cells/field in 25%, 5-20 cells/field in 25%, 0-5 cells/field in 39%, $p < 0.05$. Recurrence after treatment equals 20%, $p < 0.05$. The fixed combination of Nifuratel and Nystatin is the most frequently (37%) selected treatment.

CONCLUSIONS: According to our study the treatment for a vaginal infection among pregnant woman is based on the symptoms and the results of a vaginal smear. The recurrence of vaginal infection after treatment is 20%. The fixed combination of Nifuratel and Nystatin is the most frequently selected cure.

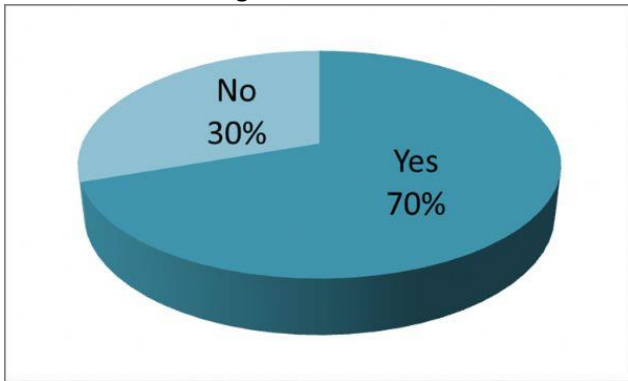
Keywords: pregnancy, treatment, vaginal infection

Vaginal infection among all subjects



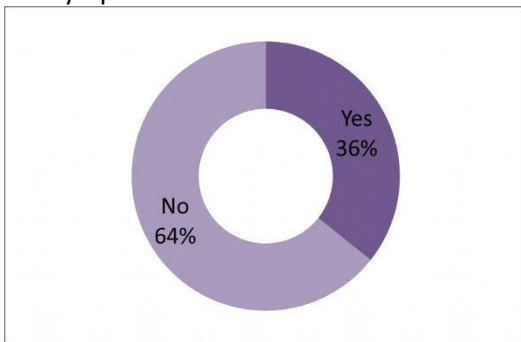
[picture 1]

Was treatment assigned?



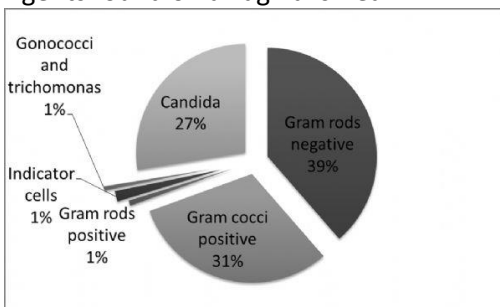
[picture 2]

Did symptoms occur?



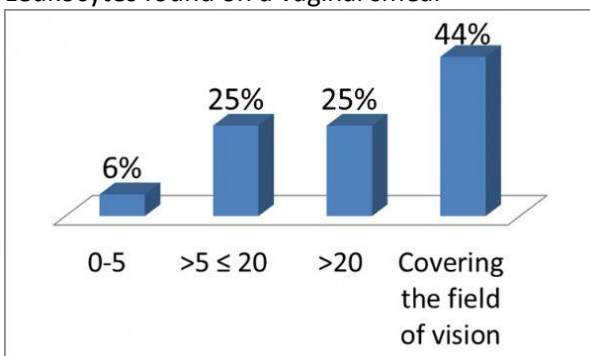
[picture 3]

Agents found on a vaginal smear



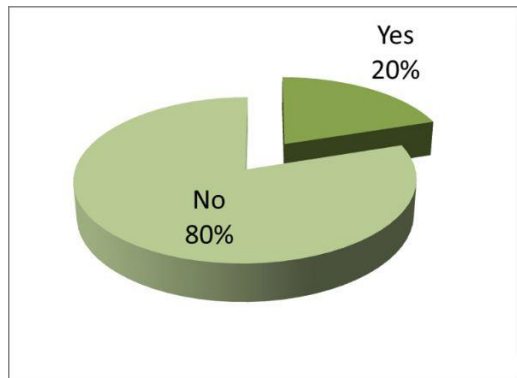
[picture 4]

Leukocytes found on a vaginal smear



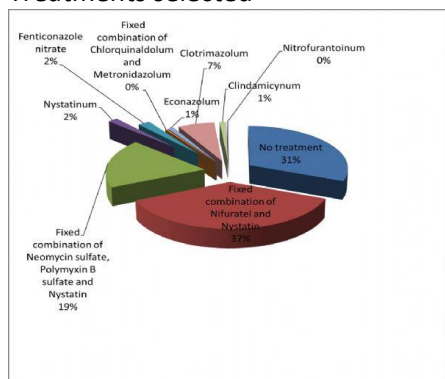
[picture 5]

Was there a recurrence after treatment?



[picture 6]

Treatments selected



[picture 7]

P-0753

Risk factors of vaginitis analysis in pregnant women

Egle Zekonyte, Daiva Dvareckyte, Kazys Simanauskas

Vilnius University, Faculty Of Medicine: Clinic of internal diseases, family medicine and oncology, Family medicine center, Vilnius University, Vilnius, Lithuania

Background and AIM: Vaginitis - one of the reasons why women go to see an obstetrician-gynecologist and pregnancy is one of the most important risk factors to get this infection. During pregnancy vaginitis is associated with a great number of gynecologic and obstetric complications, such as preterm birth, postpartum endometritis, inflammatory pelvic disease or low birth weight. The aim of the study was to analyse prevalence of risk factors among pregnant women in the Family medical center of Vilnius University Hospital Santariskiu clinic in Lithuania.

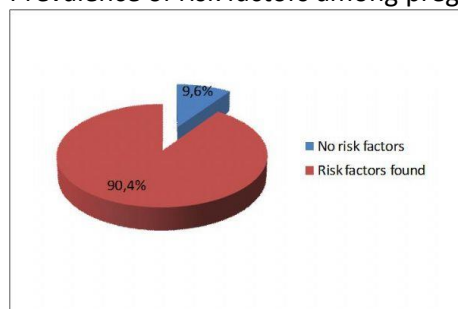
METHODS: There was reviewed 498 medical records of pregnant women from 2011 to 2014. Risk factors such as older age (>35 years), bigger weight (BMI >24,9), urinary tract infection, chronic infection (carrying B group beta-haemolytic streptococcus infection, trichomoniasis and CMV infection), arterial hypertension, diabetes mellitus and multiple pregnancy were assessed during the study. The data was processed and analyzed using "Microsoft Office Excel 2007" and the "Statistical Package for Social Science version for Windows 17.0". The statistical difference was considered significant if the "P" value was below 0.05.

RESULTS: The analysis showed that 90,4% pregnant women with vaginitis had at least one risk factor. The most common risk factor was urinary tract infection 37,5%. 15,7% women had a chronic infection, 12,9% – bigger weight and 15,4% pregnant women were older age. Also there were 1,8% women with diabetes mellitus, 2,1% women with arterial hypertension and 1,1% women with multiple pregnancy. Significant statistical difference was found between urinary tract infection and vaginitis " $p < 0.05$ ".

CONCLUSIONS: In this study the most common risk factors were urinary tract infection, chronic infection and older age. There was a significant difference between urinary tract infection and vaginitis.

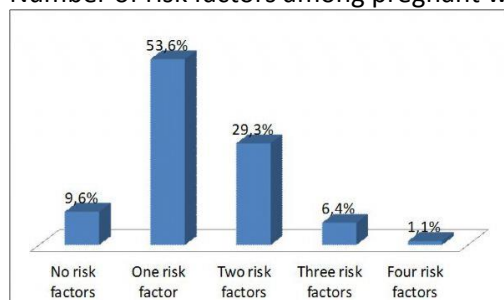
Keywords: Vaginitis, risk factors, pregnancy.

Prevalence of risk factors among pregnant women with vaginitis



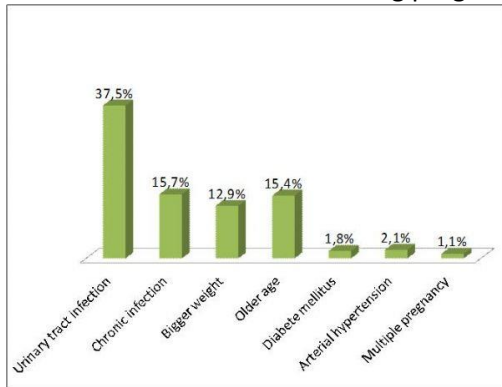
Picture 1

Number of risk factors among pregnant women with vaginitis



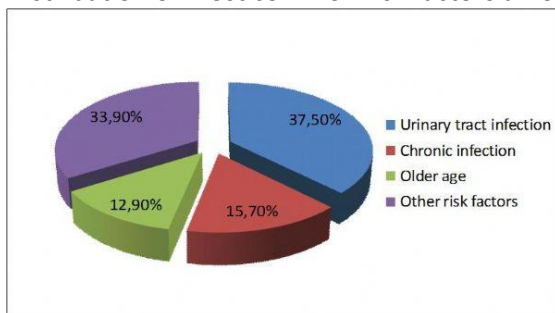
Picture 2

Distribution of risk factors among pregnant women with vaginitis



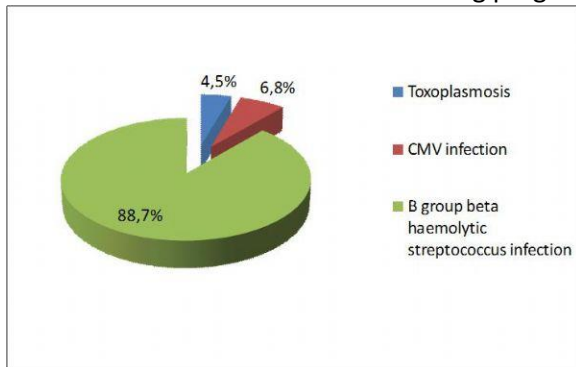
Picture 3

Distribution of most common risk factors among pregnant women with vaginitis



Picture 4

Distribution of chronic infections among pregnant women with vaginitis



Picture 5

P-0754

Relationship between vaginitis and number of deliveries in pregnant women

Egle Zekonyte, Daiva Dvareckyte, Kazys Simanuskas

Vilnius University, Faculty Of Medicine: Clinic of internal diseases, family medicine and oncology, Family medicine center, Vilnius University, Vilnius, Lithuania

Background and AIM: pregnancy is one of the most important risk factors of vaginitis. Pregnant women and women who often get vaginitis should pay more attention at their hygiene. We think that women, who are pregnant not for the first time, know better how to prevent vaginitis than women who are pregnant for the first time. The aim of the study was to see if women, who are pregnant for the first time, get vaginitis more often than women, who are pregnant not for the first time in the Family medical center of Vilnius University Hospital Santariskiu clinic in Lithuania.

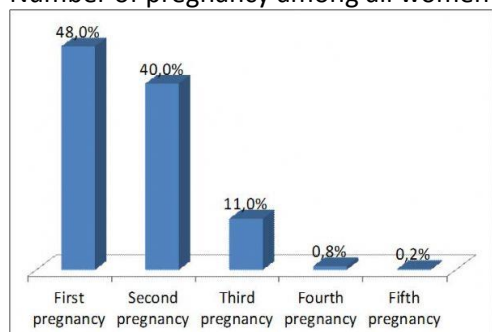
METHODS: We reviewed 498 medical records of pregnant women from 2011 to 2014. The data was processed and analyzed using "Microsoft Office Excel 2007" and the "Statistical Package for Social Science version for Windows 17.0". The statistical difference was considered significant if the "P" value was below 0.05.

RESULTS: 48% of all pregnant women were pregnant for the first time. There was more women with vaginitis, who was pregnant for the first time, than women who had 1 or more deliveries. Between women who had no deliveries or had 1 delivery, a bigger part of them had vaginitis (57,7% and 57,3%). Between women who had 2 and more deliveries, a smaller part had vaginitis (46,7%). We didn't find a statistical significant difference between deliveries number and vaginitis " $p > 0,05$ ".

CONCLUSIONS: there was more women with vaginitis among women who had no or 1 delivery, than among women who had 2 or more deliveries.

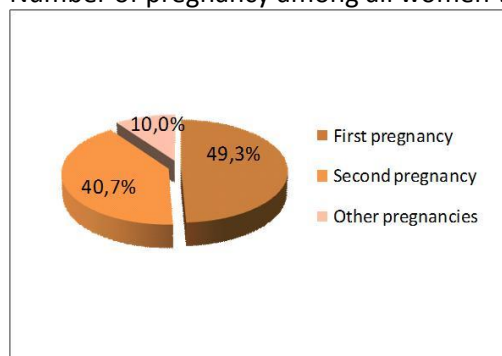
Keywords: Pregnancy, vaginitis, number of deliveries

Number of pregnancy among all women



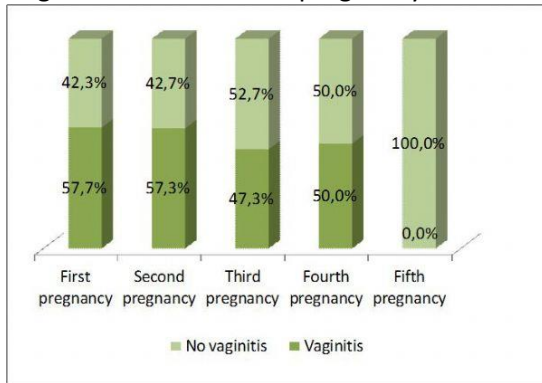
Picture 1

Number of pregnancy among all women with vaginitis



Picture 2

Vaginitis and number of pregnancy between all women



Picture 3

P-0755

Sociodemographic Characteristics Of Women Who Consulted To The Emergency Service Because Of Violence Committed Against Them

Emine Neşe Yeniçeri¹, Birdal Yıldırım², Ömer Doğan Alataş³, Ethem Acar², Burcu Harmandar Kasap⁴, Halil Beydilli², Yasemin Balcı⁵

¹Department of Family Medicine, Sıtkı Koçman University Medical Faculty, Muğla Turkey

²Department of Emergency Medicine, Sıtkı Koçman University Medical Faculty, Muğla Turkey

³Emergency Clinic, Sıtkı Koçman Training and Research Hospital, Muğla Turkey

⁴Department of Obstetrics and Gynecology, Muğla Sıtkı Koçman University Medical Faculty, Muğla, Turkey

⁵Department of Forensic Medicine, Sıtkı Koçman University Medical Faculty, Muğla, Turkey

Background and AIM: Violence against women (VAW) is a preventable public health problem. VAW is a very complex social problem rather than a disease and knowledge and skill of healthcare personnel in approaching towards women exposed to violence is an important issue. The aim of this study was to investigate sociodemographic characteristics, smoking, alcohol and substance use, place and perpetrator of the violence against women.

METHOD: Data of this study derived from the information gathered in the questionnaire forms "Evaluation of the Violence Against Women" which assessed 142 women who consulted to the Emergency Service Emergency Service of Training and Research Hospital of Mugla Sitki Kocman University because of acts of violence committed between January 2013 and December 2014. The questionnaire form contains items about sociodemographic data and those questioning pregnancy status of the woman, cigarette, alcohol and substance use, event site and perpetrator of the violence, use of alcohol or substance by the perpetrator, type and severity of the coercive acts, children experienced or witnessed violence.

RESULTS: A significant correlation was detected between level of education and increase in the severity of violent acts. Perpetrators with primary and secondary school education had exerted more aggressive violent behaviours ($p=0.039$). A positive correlation was detected between referral to violence prevention and monitoring center, fear from going home ($p=0.014$) and increase in the severity of violence ($p=0.000$).

CONCLUSIONS: Within the last two years only 142 women consulted to emergency services which is thought to be the visible tip of the iceberg. As conceivably helpful measures, increasing the level of women's educational level and female employment, development of educational programs on social gender and equality of woman and man beginning from primary school and prevention of making news and description of violent acts in written and visual media should be promoted.

Keywords: Violence; violence against women; sociodemographic; emergency service

Table 1. Sociodemographic characteristics.

Table 1. Sociodemographic characteristics.

		n (%)
Level of education	Primary-Secondary	91 (64.1%)
	Lycée	37 (26.1%)
	University	14 (9.9%)
Working status	Not working	90 (63.4%)
	Working	52 (36.6%)
Social security	No	26 (18.3%)
	Yes	116 (81.7%)
Presentation to the institute	Alone	8 (5.6%)
	With intimates	134 (94.4%)
Pregnant	Yes	9 (6.3%)
	No	133 (93.7%)
Chronic disease	No	119 (83.8%)
	Yes	23 (16.2%)
Disability	None	140 (98.6%)
	Disabled	2 (1.4%)

Table 2. Risk evaluation based on severity of violence

Table 2. Risk evaluation based on severity of violence

	Yes	No
	n (%)	n (%)
Has the violence increased in severity?	71 (65.7%)	37 (34.3%)
Has the perpetrator a habit of harmful alcohol and substance use?	61 (56.5%)	47 (43.5%)
Does perpetrator threatened with death?	66 (61.1%)	42 (38.9%)
Is any firearm present at home?	18 (16.7%)	90 (83.3%)
Does she fear to go home?	76 (70.4%)	32 (29.6%)

Table 3. Management of violence

Table 3. Management of violence

	Yes
	n (%)
Information was provided	59 (41.5%)
A safety plan was developed	19 (13.3%)
Referral to an advanced healthcare organization	24 (16.9%)
Referral to violence prevention center	17 (11.9%)
Referral for psychological support	44 (30.9%)
A follow-up plan was made	26 (18.3%)
The police was informed	50 (35.2%)

Table 4. Severity of violence

Table 4. Severity of violence

	n (%)
Threatened with a firearm	4 (6.1%)
Slapping on face, pushing (absence of injury or long-lasting pain)	25 (37.9%)
Battering, kicking, wounds, cuts and/or persistent pain	37 (56.1%)

P-0756

The importance of regular use of oral contraceptives

Funda Ekimci Deniz, Rahşan Bulut, Ayşe Semra Demir Akça, Nejat Demircan
Department of Family Medicine, Faculty of Medicine, Bulent Ecevit University, Zonguldak, Turkey

Oral contraceptives, one of the family planning methods, are frequently used both in our country and in the world. When they are used in appropriate person with accordance, this method has very high retention rate. However, irregular use of the pill and change of drug taken hours in the day reduces the retention rate significantly and formation pregnancy rates can be up to 15%. For this reason, it is important to inform people who use oral contraceptives and follow the person's compliance to treatment. This case is presented for emphasizing the importance of regular use of oral contraceptives and inform people who use oral contraceptives to protect person and baby during pregnancy.

A 26-year-old female patient was admitted to our university pregnant clinic because of pregnancy and drug use. It was learned in interview with patient that she used therapeutic combined oral contraceptive pills because of polycystic ovary syndrome but not regularly and continuously. Over 2 month delay of the period, patient made home tests by suspecting pregnancy. The patient whose test results came positive was admitted to the gynecology and obstetrics specialist on off-center. As a result of ultrasound done in the center, 11 weeks of pregnancy has been identified. Because oral contraceptives pregnancy category was X, the patient was discussed in Obstetrics and Gynecology council. The council suggested continuing period of pregnancy and close monitoring the patient who wanted continuing of pregnancy. In line with the recommendation of the Council, monitoring

the patient is continuing.

Irregular and improper use significantly reduces the retention rate of oral contraceptives. Therefore, doctors should make sure that enough information about this topic is given to patient who is advised oral contraceptives. Some proposals like pill box and applications on smartphones in order to take drugs regularly can be made.

Keywords: oral contraceptives; family planning; pregnancy

P-0757

Fertile woman deaths due to dengue fever during 2013 in Goiânia

Gustavo Aguilar Alvarenga Amorim¹, Lara Louise Guimarães Silveira¹, Ana Luisa Franco Moura¹, David Carvalho Rezende¹, Wallace Pinheiro Rodrigues¹, Lorena De Almeida Ribeiro Prudente¹, Vinicius Bernardes Mendonça Damasceno¹, Natália Carasek Matos Cascudo¹, Camila Garcia De Souza², Ayssa Teles Abrão Trad³

¹Universidade Federal de Goiás, Goiânia, Brazil

²Pontifícia Universidade Católica de Goiás, Goiânia, Brazil

³Pontifícia Universidade Católica de São Paulo, Sorocaba, Brazil

Goiânia, one of the main cities in middle-west Brazil, is well-known by the health professionals as an endemic area for dengue fever. The Public Health Ministry hopes to update all the doctors to provide them good ways for conducting their patients, although this is not enough, so there still are deaths.

The aim of this study was to identify the number of women in fertile age (10-49 years-old) dead during 2013 that has as causa mortis dengue fever.

This is a research realized at the health information division of the Goiânia's Municipal Health Secretary Epidemiology Department. The database was the obit declaration from 2013 of the fertile human living in Goiânia combine with the DATASUS. The variables are age, race, civil status, and escolar status.

As a result we found 6 deaths as dengue fever consequence, its 1,27% of the 471 documented deaths during the period. 16,66% were during January; 33,34% in February; 16,66% in March, and 33,34% during December. All them had at least graduated at the middle school, 33,33% of them are in their twenties, 33,33% in their thirties and the rest in their forties.

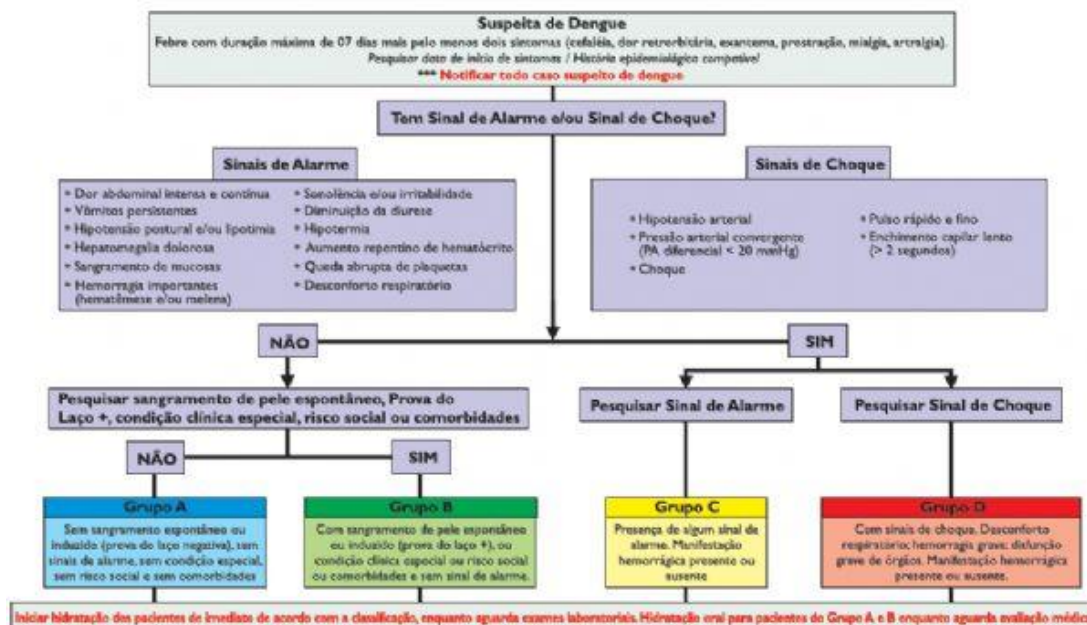
In fact, 6 deaths do not represent a major causa mortis in the city during the summer – epidemic period – even with the well structured clinical management stipulated by constantly re-evaluating the patient and classifying him in a risk group that will determine how it was supposed be conducted. With this in mind, it is possible to conclude that these deaths could really be avoided not only with a more careful management but also with better prevention of the disease.

Keywords: women, mortality, dengue fever

Dengue Fever Guideline

DENGUE

Classificação de Risco e Manejo do paciente



How to evaluate the patient and provide the correct treatment.

P-0758

Urinary incontinence in women older than 40 years

Ebubekir Demireloğlu, Davut Karakurt, Melek Cihanbeylerden, Didem Sunay

Department of Family Medicine, Kecioren Training and Research Hospital, Ankara, Turkey

AIM: Urinary incontinence (UI) is a problem that creates both physical and psychological nuisance to a woman. The aim of this study to assess UI prevalence, medical advice seeking of women and related factors.

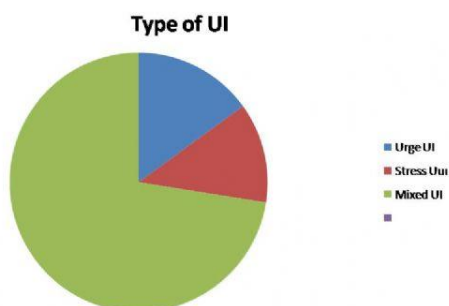
METHODS: Women over 40 years old attended to family medicine clinic between January-February 2015 were included in this cross-sectional study. Questionnaire for socio demographic, clinic characteristics, ICIQ incontinence form for UI were used.

RESULTS: A total of 148 women accepted to include into the study, mean age was 54.3±11.1 years, 63.5% of them were in menopause. UI prevalence was 28.4% (15% urge, 12.5% stress, 72.5 mixed), 50% did not consult a physician, among these women 25% thought it was normal, 47.6% of them who got advice were consulted a gynecologist, 28.6% a family physician. Mean ICIQ score was 11.4 out of 12. The mean impact score of UI symptoms on daily life was 6.8 out of 10.

CONCLUSION: It is important to assess and treat UI by family physicians because of its high prevalence and high psychosocial effects.

Keywords: urinary incontinence, women, help seeking

Type of UI in study population



UI in women



P-0759

Analysis of the informal caregivers burden of dependent persons

Ana Duarte¹, Ana Rodríguez¹, Eva Míguez², Manuel Ángel Barbosa¹, Eduardo Díaz¹, Ana Clavería¹

¹Galicia's National Health, Vigo, Spain

²Department of Economy, Vigo University, Spain

Background&AIM: Whereas caregiving has been shown to improve patient outcomes, the consequence of caregiving for caregivers themselves remains debated.

To quantify the impact of caregivers' burden on their health. To analyze the influence of their risk factors, arising from themselves and from their dependents.

METHOD: Descriptive observational study in primary care setting in Spain. Caregivers who provide care to a dependent adult population were included (N = 97). It was collected socioeconomic information, different health status measures of both the keepers and the dependent, and the load of the caregiver through Zarit scale short version (outcome variable) through a personal interview. Descriptive analysis and logistic regression was performed, with Stata 12 software.

RESULTS: The average burden was 19.4, and 61.9% of caregivers had severe overload (Zarit ≥ 17). The burden was correlated significantly ($p < 0,05$) with the degree of consanguinity, the health of the caregiver, dependent's aggressiveness and if they had psychiatric illness.

CONCLUSIONS: The informal carers of dependent persons present a high level of burden, influenced by their own health and by dependent person characteristics. This overload, the social factors that surround the caregivers and their dependent patient, raises addressing the needs of both together. Understanding the caregiver risk factors will provide insights into how intervention programs can be best tailored to them. The multiprofessional team (GPs, nurses, social workers) must look after the patient problems as much as those of his/her carer, avoiding the physical and psychological health deterioration of the latter.

Keywords: Caregivers, Humans, Aged, Quality of life, Dependence

P-0760

Pregnancy After Tubal Ligation: A Case Report

Aynur Yalçıntaş¹, Püren Cura Ecevit², Özlem Öztaş³, Burcu Kayhan Tetik⁴

¹Konya Karatay No:9 Family Health Center, Konya, Turkey

²Konya Meram No:25 Family Health Center, Konya, Turkey

³Ankara EÜAŞ Health Department, Ministry of Energy, Ankara, Turkey

⁴Inonu University Medical Faculty, Department of Family Medicine, Malatya, Turkey

INTRODUCTION:

Family planning provides individuals to have children when they wished to have and in a number they are able to take care of. According to the data from Turkey Demographic and Health Survey (TDHS 2013), 74% of married women of childbearing age have been using a contraceptive method, in Turkey. Again, in the same study it has been reported that 47.5% of them have preferred to use modern methods, whereas 9.4% of this rate have undergone tubal ligation.

CASE:

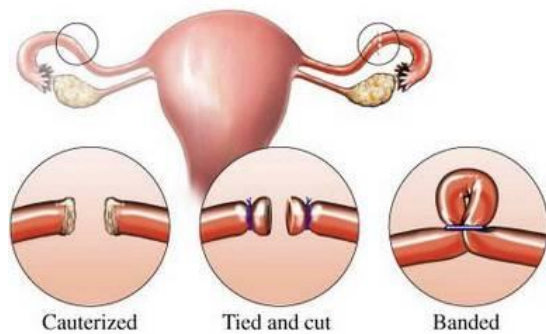
Thirty-three-year-old woman admitted to our Family Health Center with complaints of nausea, fatigue and menstruation was 10 days delayed. The patient stated that she underwent tubal ligation 7 years ago. No pathological findings were detected. The patient was convinced to make pregnancy test done, and the results were Beta HCG > 150,000 mIU / ml. The patient was informed that she was pregnant according to the laboratory data, however an ultrasound examination was required to confirm the laboratory results. Then she was referred to gynecology and obstetrics polyclinic. The ultrasound examination revealed that she was 5 weeks pregnant and the patient was directed to our family medicine center to be followed up. The patient delivered a 3500 grams, healthy baby boy at the end of 39 weeks 2 days of pregnancy by cesarean (C / S).

CONCLUSION:

There is a way of patient interview which is peculiar to family medicine physicians. To gain patients' confidence through repeated interviews is very important to convince the patients. As seen in our case, in patients in the reproductive age, the probability of pregnancy should be considered even if the patient has been protected by a method such as tubal ligation in cases of delays of menstruation, and necessary test should be requested.

Keywords: Family Medicine, Family Planning, Tubal Ligation

Tubal Ligation



P-0761

The Effect of Ferritin, Vitamin B12 and Folic Acid on Pregnancy Outcomes

Pınar Kalem¹, Ali Ramazan Benli², Murat Koyuncu³, Neriman Çetin Benli⁴, Mustafa Köroğlu⁵, Özkan Cesur⁶, Pakizer Banu Kılıçoğlu Dane⁷

¹Sabri Artam Vakfi ASM, Bahcekoy, Sarıyer, İstanbul, Turkey

²Department of Family Medicine, Faculty of Medicine, Karabuk University, Karabuk, Turkey

³Department of Emergency Medicine, Faculty of Medicine, Karabuk University, Karabuk, Turkey

⁴Baglar ASM, Safranbolu, Karabuk, Turkey

⁵Department of Hematology, Faculty of Medicine, Karabuk University, Karabuk, Turkey

⁶Department of Pediatric Surgery, Faculty of Medicine, Karabuk University, Karabuk, Turkey

⁷Department of Gynecology and Obstetric, Faculty of Medicine, Bezmialem Vakif University, Istanbul, Turkey

INTRODUCTION: A reduction occurs in levels of some minerals and vitamins due to physiological adaptation during pregnancy, and this situation causes anemia in pregnancy. In this study the effect of ferritin, vitamin B12 and folic acid levels on the outcomes of the pregnancy were evaluated.

MATERIALS-METHODS: 72 pregnant women with third trimester of pregnancy were included in the study. Vitamin and mineral analyzes of the patients were done. Whether or not iron and vitamin supplements received during pregnancy were asked, and mode of delivery and the history of postpartum problems occurred in infants were questioned.

RESULTS: Anemia was detected in 29 percent of pregnant women in the study. An increase was detected in the incidence of anemia among women with 2 or more children while the rate of anemia in primipar women was low. An increase was seen in the incidence of anemia by the number of children got higher. 60 percent of mothers of newborns with medical problems had anemia. There was no statistically significant difference in the mean birth weight considering the presence or absence of maternal anemia.

A significant difference between anemia status was not found in terms of mode of delivery and delivery at term. A difference in anemia was not detected in infants no matter their mothers took vitamin and mineral supplements or not.

CONCLUSION: To use iron supplements alone is not enough to prevent anemia in pregnancy, multivitamin use with iron is required. Together iron-multivitamin use reduces the effect of B12 deficiency. It is observed that the frequency of anemia increases while the number of pregnancy increases. In our study it is seen that anemia in the last trimester has no effect on the mode or time of delivery, weight and general condition of newborn.

Keywords: pregnancy, anemia, birth defects

P-0762

The taboo of urinary incontinence in Turkish women in wijkgezondheidscentrum De Sleep

Nele Rasschaert¹, Kristin Hendrickx²

¹Ghent University, Family medicine department

²University of Antwerp, Family medicine department

BACKGROUND: Although a very prevalent condition, urinary incontinence (UI) often stays underreported. Only half to 1/3 of the patients consults a doctor. Numbers from the EHR from wijkgezondheidscentrum De Sleep, a family medicine practice in Belgium with 50% of its patients from Turkish origin, showed a very low prevalence. This study determines the prevalence of UI in Turkish women and provides an insight in the roleplaying factors in their help-seeking behavior.

METHOD: A questionnaire, including epidemiological data, the 3 Incontinence Questionnaire, the PRAFAB score and a survey on the attitudes about urine loss, was translated to Turkish. All 18+ women from Turkish origin were invited to participate. The data were analyzed by SPSS. The qualitative part of the study consisted of in-depth interviews and the analysis by NVIVO.

RESULTS: 57,5% of the patients reported involuntary urine loss. 35,1% of these patients consulted a doctor. The

consultation rate increased as severity, 'bothersomeness' and frequency of urine loss rose. The most quoted reason for not seeking help are 'My health is in the hands of Allah', 'Urine loss is a normal consequence of having children' and 'I think the doctor will not consider this important enough to listen carefully'. The qualitative interviews confirm the role of severity and 'bothersomeness' on the consultation rate.

CONCLUSION: Urinary incontinence remains a significant but underreported problem. Urinary loss can occur at young age. This advocates the promotion of pelvic floor muscle training pre- and postnatal for prevention of UI. Only one third of the patients with UI consulted the doctor. The low help-seeking behaviour can be explained by the low severity and 'bothersomeness', and by the lack of knowledge about causes and treatments of urine loss. Information-giving and shared decision making remains therefore an important task. Shame is not an inhibiting factor for seeking help.

Keywords: urinary incontinence, help-seeking behaviour, ethnic minorities

P-0763

Physical performance and 25-hydroxyvitamin D: a cross-sectional study of pregnant Swedish and Somali immigrant women and new mothers

Paul Kalliokoski¹, Yngve Bergqvist², Monica Löfvander³

¹Dpt of Public Health and Caring Sciences, Family Medicine and Preventive Medicine Section, Uppsala University, Sweden

²Centre for Clinical Research Dalarna, Falun, Sweden

³Division of Family Medicine, Dpt of Neurobiology, Care Sciences and Society, Karolinska Institutet, Huddinge, Sweden

BACKGROUND: Vitamin D deficiency can impair muscle strength. Study aims were to examine physical performance in hands and upper legs and analyze plasma 25-hydroxyvitamin D (25(OH)D) concentrations in women with presumably low (veiled, Somali-born) and high levels (unveiled, Swedish-born).

METHODS: Women (n=123, 58% Swedish) enrolled at a Swedish antenatal clinic, were recruited. Plasma 25(OH) D was analyzed (nmol/L). Maximal hand grip strength was tested (Newtons, N), and upper leg performance(able/unable to perform squatting, standing on one leg and lifting their hips). Non-parametric statistics tested the data for differences in their ability to perform the tests. Undetectable values (<10 nmol/L) were replaced with '9' in the linear correlation statistics. A final main effect model for grip strength (in N) was calculated using stepwise linear regression for independent variables: country of birth, 25(OH)D levels, age, height, weight, physical activity, lactation status, parity, and gestational age.

RESULTS: Somali participants (35%) had 25(OH)D levels of <10 nmol/L, and 90% had <25 nmol/L; 10% of Swedish participants had <25 nmol/L of 25(OH)D, and 54% had <50 nmol/L. Somali women had weak grip strength compared with Swedish women: median 202 N (IQR 167–246) vs. median 316 N (IQR 278–359). Somali women were also weak in upper leg performance: 73% were unable to squat, 29% unable to stand on one leg, and 21% could not lift their hips; most Swedish women could perform these tests. In the final model, grip strength (N) was significantly associated with 25(OH)D levels (B 0.94, p=0.013) together with Somali birth (B -63.9, p<0.001), age (B 2.5, p=0.02) and height (B 2.6, p=0.01).

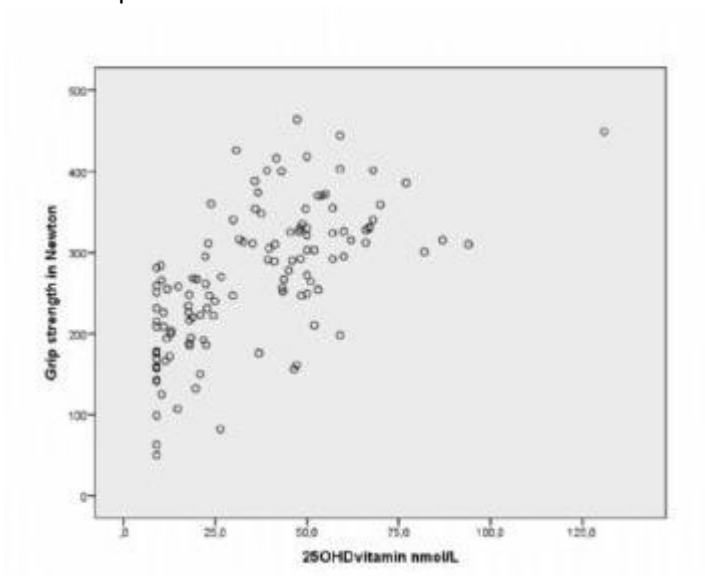
CONCLUSIONS: Many Somali women had undetectable/severely low 25(OH)D concentrations and pronounced hand and upper leg weakness; grip strength was strongly associated with 25(OH)D. Maternity health care personnel should be aware of this increased frequency and manage care accordingly.

Keywords: 25-hydroxy vitamin D, Ultraviolet B radiation, Grip strength, Physical performance, Clinical observation, Somalia, Pregnancy

1. Picture- Measuring grip strength with GRIPPIT



2. Scatterplot



3. Tabel

Final main effect model using linear regression with stepwise exclusion for maximal voluntary grip strength in 123 pregnant and new mothers. Unstandardized (B) with 95% confidence intervals (95% CI) and p-values. Significant p-values in bold.

Variable	B	95% CI	p
25(OH)D	0.94	(0.21–1.68)	.013
Country	63.9	(-97.9 – -29.9)	<.001
Age	2.5	(0.15 – 4.60)	.015
Height	2.6	(0.59 – 4.65)	.012

Independent variables included at the first step: country of birth, 25(OH)D, age, height, weight, physical activity, lactation, parity, gestational age

P-0764

Intrauterine Device Slip

Neslihan Erkuran¹, Selami Kara², Esin Taçol³

¹Spc, T. C. Ministry of Health Gölyüzü A.S.M., Bolu, Turkey

²Spc, T. C. Ministry of Health Bahçelievler A.S.M., Bolu, Turkey

³GP Dr, T. C. Ministry of Health Sarıçam T.S.M., Adana, Turkey

INTRODUCTION: Intrauterine devices (IUDs) is one of the long-acting reversible contraception method. In such a case, the IUD must be removed. In this study, we aimed to identify general socio-demographic data of patients with IUD shifted and factors in affecting early and late shifting of IUD.

MATERIALS-METHODS: The prospective, cross-sectional and descriptive study was performed between January and May 2012. For this study, we included 39 patients that they came 2. Mother and Children's Medical Center in Adana for any reason and they were determined to have the IUD shifted. A questionnaire including datas of socio-demographic, childbearing-related information and complaints about the IUD was administered to the patients in the study. IUD shifting in first six month was assessed as shifted early and the others were assessed as shifted late. The data were collected through surveys and analyzed statistically using SPSS 15.0 software.

RESULTS: The shifted IUDs were identified in 39 of the patients which admitted to the clinic at the time of the study. the average age of these patients was found 29.3 (min:17, max:46). The average age of marriage and pregnancy were found 20.6 (min:14, max:29) and 21.1 (min:15, max:30), respectively. The average times of IUDs shifting in the study were identified 15.9 months (min:1, max:72). it was found to have early shifting in 18 patients (46.2%) and late shifting in 21 patients (53.8%) in the study. There were statistically significant differences between smoking, history of heavy lifting, genital infection, age of marriage, type of delivery, breastfeeding, time of IUD administration and early-late shifting of IUD (P:0,429, P:0,273, P:0,454, P:0,406, P:0,115, P:0,956, P:0,139).

CONCLUSION: There were not statistically significant differences between smoking, history of heavy lifting, genital infection, age of marriage, type of delivery, breastfeeding, time of IUD administration and early-late shifting of IUD.

Keywords: Intrauterine device, birth control method, woman, shifting

P-0765

Impact of Vitamin D Levels and Oral Vitamin D (Cholecalciferol) Replacement Therapy on Menstrual Symptoms in Dysmenorrheic Patients

Hatice Küçükceran¹, Özhan Özdemir², Serkan Kiral³, Dilek Şensöz Berker⁴, Rabia Kahveci¹, Adem Ozkara⁵, Cemal Reşat Atalay²

¹Ankara Numune Training and Research Hospital(ANEAH) Department of Family Medicine

²Ankara Numune Training and Research Hospital(ANEAH) Department of Obstetrics,

³Ankara Numune Training and Research Hospital(ANEAH) Department of Biochemistry

⁴Ankara Numune Training and Research Hospital(ANEAH) Department of Endocrinology

⁵Hitit University Faculty of Medicine Department of Family Medicine

INTRODUCTION: This study aims to explore whether Vitamin D replacement in primary dysmenorrheic patients with severe Vitamin D deficiency (25-OH-D vitamin:0-10ng/ml) causes a more significant decrease in the severity of pain compared to patients with moderate or mild Vitamin D (10-30ng/ml) deficiency.

METHODS: Hundred patients between the age of 18 and 30, diagnosed with primary dysmenorrhea without a history of other disease, with 25(OH)D levels lower than 30 ng/mg were included. Pelvic ultrasonography was done to exclude any gynecological pathology. All patients were questioned for their sociodemographical and physical characteristics, habits, information about menstrual cyclus, character and duration of menstrual pain, whether menstrual pain affects daily life, accompanying symptoms and VAS severity of pain score was determined. All patients were planned for daily replacement therapy for 2 months and a maintaining dose (6 drops of D-Vit3 per day) in the following month.

RESULTS: Of the patients, 23% had mild, 45% moderate, and 32% severe vitamin D deficiency. VAS score and PTH levels were increased by increased Vitamin D levels. ($r = -0,320; p = 0,002; r = -0,295; p = 0,003$; respectively). Before the replacement patients' mean Vitamin D level was $13,9 \pm 6,1$ ng/ml, VAS score was 7 ± 2 , and parathormone level was $42,2 \pm 17,4$ pg/mL. While mean Vitamin D level was increased to $31,1 \pm 3,8$ ng/ml after the replacement therapy, mean VAS score decreased to $4,0 \pm 1,5$ and mean parathormone level decreased to $28,6 \pm 8,6$ pg/mL.

Change in the levels of the parameters before and after the treatment was shown by Delta(Δ). Accordingly, Δ Vitamin D level was found to be negatively correlated with Δ VAS score and Δ PTH level ($r = -0,421; p < 0,001; r = -0,380; p = 0,024$; respectively). Change in VAS score and PTH levels after the replacement(Δ) was higher in patients with severe Vitamin D deficiency, compared to patients with mild and moderate Vitamin D deficiencies.

CONCLUSIONS: Vitamin D deficiency might be a factor to aggravate dysmenorrhea and proper management might increase patients' quality of life.

Keywords: vitamin D, Dysmenorrhea, Replacement Therapy

P-0766

Because Touching is Worth More than a Thousand Images

Joana Guerra Silva¹, Ana Franganito Sardo¹, Pedro Filipe Alves¹, Maria João Nobre²

¹USF Mirante, ACES Central I, Olhão, Algarve, Portugal

²USF Guadiana, ACES Sotavento, Castro Marim, Algarve, Portugal

BACKGROUND AND AIM:

Due to its close and long contact with the population, Primary Health Care constitutes an opportunity for preventing and detecting diseases, frequently not valued or perceived by the patient. The aim of this presentation is to show the importance of a complete approach to the patient, and that the information taken from the practical skills may be richer than diagnosis complementary exams.

METHODS: Case report.

RESULTS:

Female, 54 years old, born and resident in Olhão, divorced, with 3 children, with whom she lives. Antecedents of dyslipidemia and L5-S1 discal herniation.

The patient went to her Family Physician (FP) in July/2013 in order to actualise her Cervical Cancer Screening. No complaints were presented. A partial health evaluation was done, namely breast examination. A left supraclavicular ganglion was noticed and biopsied. The result showed a poor differentiated carcinoma, of unknown origin, probably in the breast (oestrogen receptors+).

The patient was sent to the Gynaecology department in Algarve's Hospital, beginning an investigation to locate the primary tumour - mammography, breast ultrasound and magnetic resonance, suprapubic and endovaginal ultrasound, chest radiography, thoracic-abdomen-pelvic TAC and bone scintigraphy, none of which revealed any alterations. Finally, a PET showed caption areas on the right ovary and among multiples ganglion chains.

A total hysterectomy and double anexectomy were performed. The histologic diagnosis was that of a double ovarian poor differentiated serous carcinoma, with lymphatic invasion. Presently, the patient is under palliative chemotherapy, going periodically to her FP to share her evolution.

CONCLUSION:

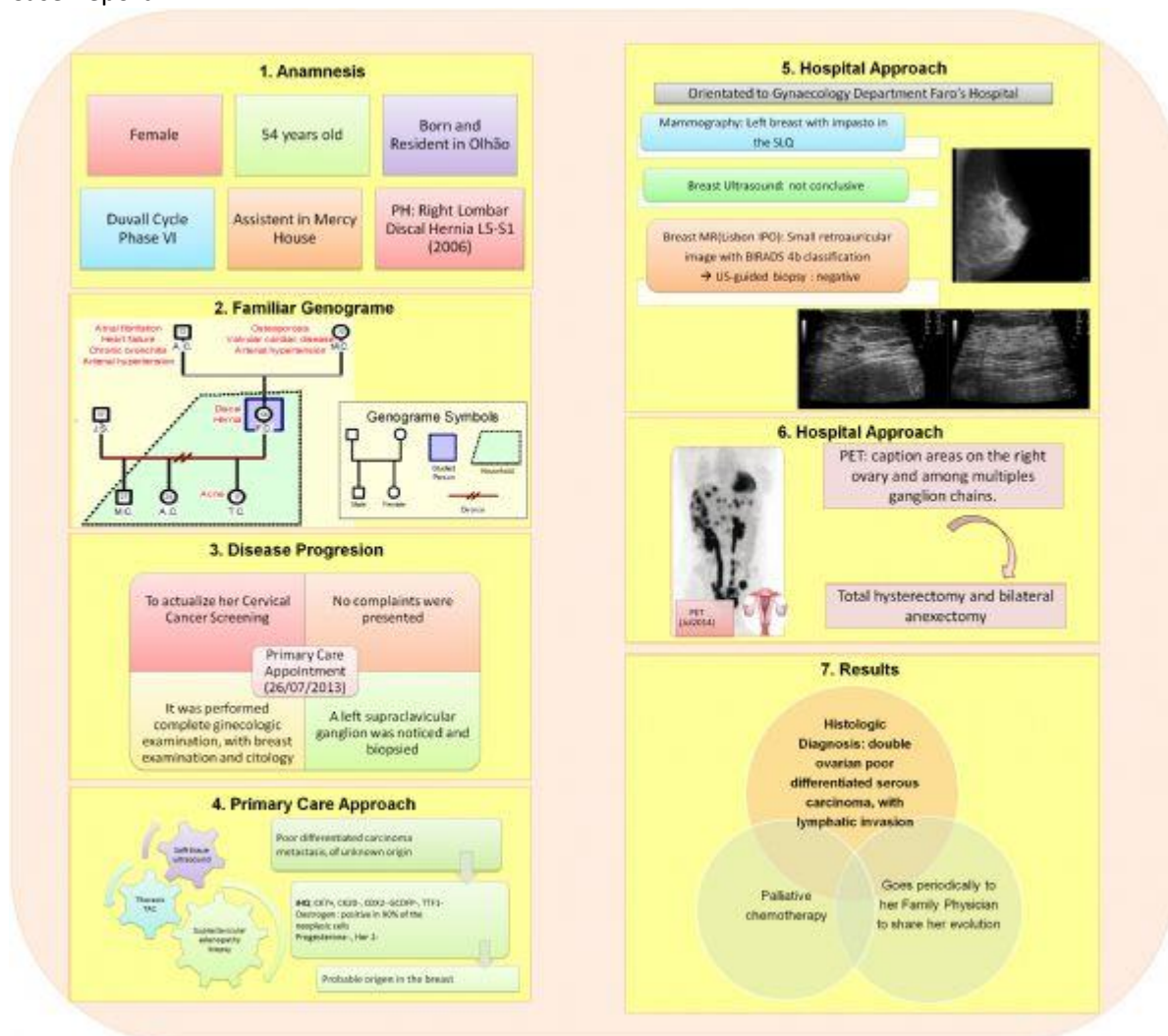
The FP is in a privileged position to intervene on the population. Performing an adequate physical examination – a breast examination in the context of a gynecological evaluation – resulted in the detection of a major pathology with great repercussions in the patient's life, concerning both the physical component, and her psychosocial-family context.

Keywords: Primary Care; Preventing; Cervical Cancer Screening;

Background and Aim

Due to its close and long contact with the population, Primary Health Care constitutes an opportunity for preventing and detecting diseases, frequently not valued or perceived by the patient. The aim of this presentation is to show the importance of a complete approach to the patient, and that the information taken from the practical skills may be richer than diagnosis complementary exams.

Case Report



Conclusion

The Family Physician is in a privileged position to intervene on the population. Performing an adequate physical examination – a breast examination in the context of a gynecological evaluation – resulted in the detection of a major pathology, not detected by the several complementary exams performed, with great repercussions in the patient's life, concerning both the physical component, and her psychosocial-family context.

P-0767

Evaluation of The Level of Knowledge, Attitudes, and Behavior of Pregnant Women Toward Drug Use During Pregnancy

Numan Güvenç¹, Hamit Sırrı Keten², Celal Kuş¹, Nagihan Sarı¹, Hüseyin Üçer¹, Önder Ercan³

¹Department of Family Medicine, Medical Faculty, Kahramanmaraş Sutcu Imam University, Kahramanmaraş, Turkey

²Department of Family Medicine, Kurtul Family Health Center, Kahramanmaraş, Turkey

³Department of Obstetrics and Gynecology, Medical Faculty, Kahramanmaraş Sutcu Imam University, Kahramanmaraş, Turkey

BACKGROUND: The aim of the present study was to evaluate the level of knowledge, attitudes, and behavior of pregnant women toward drug use during pregnancy.

METHODS: The present study included pregnant women who were admitted to the outpatient clinics at Kahramanmaraş Sütçü İmam University Faculty of Medicine between March 3, 2015 and April 3, 2015. The participants were provided information before the study, and 208 pregnant women, who provided informed consent, were included in the study.

RESULTS: The mean age of 208 pregnant women was 28.20 ± 5.96 years (min=17, max=43). The mean gestational age of the participants was 30.67 ± 9.97 weeks (min=6, max=40). Of participating pregnant women, 139 (66.8%) reported that they had a sufficient level of knowledge regarding drug use, whereas 69 (33.2%) women reported an insufficient level of knowledge. Of the participants, 44 (21.2%) reported drug during pregnancy before they knew that they were pregnant. Of the participants, 48 (23.1%) reported that they bought non-prescription drugs from the pharmacy and 160 (76.9%) reported that they did not buy non-prescription drugs from the pharmacy. Of the pregnant women, 178 (85.6%) reported that they read the package insert and 30 (14.4%) did not read the package insert. Of the participants, 75 (36.1%) reported that they were aware of the risk categories of medicinal drugs and 133 (63.9%) were not aware of risk categories. Of the participants, 100 (48.1%) agreed, 25 (12.0%) disagreed, and 83 (39.9%) had an idea about the expression, "The women should take folic acid before becoming pregnant."

CONCLUSION: The study showed a considerable lack of knowledge and false attitudes and behavior toward drug use during pregnancy.

Keywords: Pregnant, drug, knowledge level

P-0768

Contraception Methods in Unplanned Pregnancy

Burçin Kavaklı Geriş¹, Memnune Çiğdem Apaydın Kaya²

¹Burçin Kavaklı Geriş, Department of Family Physician, Marmara University, İstanbul, Turkey

²Memnune Çiğdem Apaydın Kaya, Department of Family Physician, Marmara University, İstanbul, Turkey

INTRODUCTION:

Unplanned pregnancy is one of the serious problems for woman and child. The aim of this study is to assess the use of contraceptive methods among unplanned pregnancy before the in-depth interview.

MATERIAL-METHODS:

Voluntary pregnant women who have visited Marmara University Obstetric Outpatient Clinic in two months and willing to join in-depth interview were included to the study. The pregnant women who are at the last week of pregnancy, recommended for a bed rest, have labor pain, are not included. Socioeconomic status with contraceptive use last one year before the pregnancy was questioned with face to face interview.

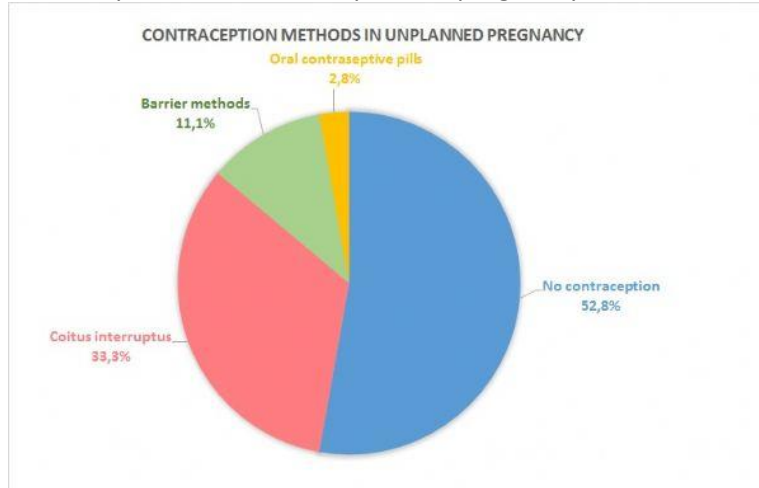
RESULTS: 111 women voluntary pregnant women were included to the study. The mean age of them was 28 ± 4.98 ; mean number of pregnancy was 2.55 ± 1.26 . 36 of 111 pregnancy (32.4%) was unplanned. 52.8% of the women have unplanned pregnancy didn't use any contraceptive method. The contraceptive methods which are used by women who have unplanned pregnancy are coitus interruptus 33.3%; 11.1% barrier methods; 2.8% oral

contraceptive pills and no intrauterin contraceptive device.

CONCLUSIONS: The high prevalence of unplanned pregnancies and low prevalence of contraceptive use among them suggest the need for education to improve women's knowledge about how and when to use the methods in order to increase their ability to plan their pregnancies. Our second plan is to investigate the problems with using the contraceptive methods in that voluntary pregnant with in-depth interviews.

Keywords: unplanned pregnancy, contraceptive methods

Contraceptive methods in unplanned pregnancy



P-0769

Health Perception and Depression in Women

Yusuf Burak Çayırılı¹, Ekin Nurhan¹, Nihat Birtane¹, Çavuş Ece¹, Burçin Göğüş¹, Çiğdem Apaydın Kaya²

¹Marmara University School of Medicine, Istanbul, Turkey

²Marmara University School of Medicine, Department of Family Medicine, Istanbul, Turkey

Background and AIM: In clinical trials determined that women have more depression signs than the men. Depression may affect the health perception potentially owing to its capability of changing humans' thoughts, feelings and mood. The aim of this study is to determine the association between depression and health perception among women in Turkey-Zümrütevler district.

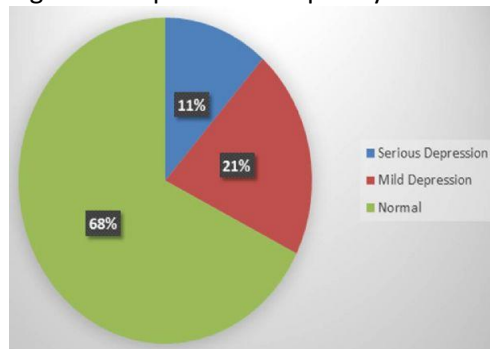
METHOD: This cross-sectional study was conducted on 210 houses in order to reach women aged 15 and older. The houses were selected by 30x7 cluster selection method in Zümrütevler in April 2015. 30 street and in each street 7 houses were selected randomly. The data was collected through face to face questionnaire covering socio-demographic factors and quinary likert scale to determine the health perception and BECK depression scale was filled by women. According to the BECK scale ≥ 17 was accepted as "depression". SPSS 20.0 was used for analysis. After frequency distributions, chi-square test was applied and Pearson correlation coefficient was calculated.

RESULTS: In 210 house, 173 women with a mean age of 40 ± 1.12 were reached. The average score of BECK depression scale was 15 ± 11.4 (min:0, max:53). Depression prevalence of the women were 32%. There were no association between education, income and BECK score ($p > 0.05$). A statistically significant association was determined in between general health perception and BECK score. The average BECK score was higher in the women reported their general health status as "middle-bad" than the "good-perfect" (17 ± 13.86 ; 12 ± 9.19 ; $p = 0.018$). Having more number of children and pregnancy were positively correlated with BECK score ($r = 0.268$, $p = 0.003$; $r = 0.294$, $p < 0.001$). But married and pregnancy at early ages were negatively correlated with BECK score ($r = -0.240$, $p = 0.003$; $r = -0.245$, $p = 0.03$).

CONCLUSION: In conclusion, about one third of women were in depression and a significant association in between depression and general health perception is determined. Depressed women perceive their own general health worse.

Keywords: Woman Health, Depression, Health Perception, BECK Depression Scale

Figure 1: Depression Frequency



Serious depression: BECK score=30-63; Mild depression: BECK score=17-29

Table 1: Some Sociodemographic Features of the Women

	Mean	Min-Max
Age	40±1.12	16-80
Persons per household	4±1.16	1-15
Age of marriage	20±3.113	13-30
Number of children	2.6±1.42	0-12
Monthly household income (Turkish Lira) (Per household poverty income was 3772 during the study period)	2000	800-11000

Table 2: Association with General Health Status and BECK Score

General Health Perception	Beck Score (Mean)
Good - Excellent	12.69±9.15
Bad - Intermediary	17.49±13.75

p=0.019

Table 3: Correlation with BECK score

	Pearson Correlation Coefficient (r)	P value
Age of marriage	-0.240	0.003
Number of children	0.268	0.01
Age of first pregnancy	-0.245	0.03
Number of pregnancies	0.294	<0.001

P-0770

Female Sexual Dysfunction in Diabetes

Nicole Santos Marques, Clara Gameiro Mendes, Ana Bastos Dias, Mariana Oliveira Lemos
USF Monte Pedral

Background & AIM: Diabetes Mellitus (DM) is one of the most common chronic diseases and long-term microvascular and macrovascular complications are a leading cause of morbidity and mortality in DM. Endothelial, vascular and neurological impairment have been associated with erectile dysfunction in men. However, although DM affects about 441 600 portuguese women, the influence of DM on female sexuality is often omitted and overlooked in clinical practice.

The aim of this work is to provide an overview of the epidemiology of Female Sexual Dysfunction (FSD) in diabetic women and discuss the impact of DM on female sexuality.

METHOD: A search for randomized controlled trials, meta-analysis, reviews and guidelines published in English, with the MeSH terms “sexual dysfunction”, “diabetes” and “women” was conducted in PubMed, Cochrane Library, EMBASE, National Guideline Clearinghouse, UpToDate and NICE.

RESULTS: The search returned a total of 113 publications, of which were selected 24. The prevalence of FSD is high among diabetic women and female sexual function index (FSFI) is lower in DM patients than in women without DM. Most studies indicates that prevalence of lower sexual satisfaction, dyspareunia, loss of libido and problems with orgasm, lubrication and arousal are higher in diabetic women. No strong association was found with duration of diabetes or cardiovascular and metabolic risk factors but depression seems to be a main predictor of FSD in DM.

DISCUSSION: DM significantly increases the risk of FSD regardless of metabolic control or duration of the disease. FSD is a complex disease in which biopsychosocial factors have an important role. In fact, as a chronic disease, DM has impact on self-image, family welfare and quality of interpersonal relationships and it can interfere negatively on all aspects of sexual response. Health care providers should address DM holistically, actively questioning the presence of DSF.

Keywords: Diabetes; women; sexual dysfunction

P-0772

Main causes of cardiovascular deaths in childbearing age women in Goiânia, GO – Brazil

Davison Rodrigues Lima Oliveira¹, Lara Louise Guimaraes Silveira¹, Gustavo Aguiar Alvarenga Amorim¹, Wallace Pinheiro Rodrigues¹, David Carvalho Resende¹, Ana Luisa Franco Moura¹, Lorena De Almeida Ribeiro Prudente¹, Vinicius Bernardes Mendonça Damasceno¹, Camila Garcia De Souza²

¹Faculdade de Medicina, Universidade Federal de Goiás, Goiás, Brasil

²Pontificia Universidade Catolica de Goias, Goias, Brazil

Cardiovascular diseases are the main causes of death in a global standardized view. The impact is not only financial as a lot of money is spent, but is also social with increased years of life lost. The objective of this study is to point the main cause of cardiovascular deaths of childbearing age women in Goiânia. This is a descriptive study conducted in the Health Information Division of the epidemiology department of health in the city of Goiânia- GO. Declarations of deaths of women in childbearing age (10-49 years) living in the city of Goiânia –GO were used as tools to collect data, as well as data on deaths of women in fertile age available at the SUS Informatics Department (DATASUS). We observed that the three main causes of death were responsible of 62 deaths, the equivalent of 13% of the deaths in the city during the year. The first cause described as 'heart disease' counted 29 deaths during the year of 2013. The second one was stroke with 18 deaths followed by acute myocardial infarction (AMI) with 15 deaths in total. The gathered data was not as revealing as it was expected. Although stroke and AMI was described as very important diseases that have to have attention, Twenty-nine deaths of the sixty-two total analyzed has no specific cause. Facts like these impairs the designing of useful strategies that could be applied. Health programs are essential to improve the health of populations, but it is not possible to plan them without knowing what the main problem affecting them is. By this way, it is also important the way the data was published and, in this case, how the doctors are filling the death certificate. Therefore, the education of physicians to fill the certificates with seriously is important to future analysis.

Keywords: Woman, Cardiovascular diseases, cardiocascular deaths

P-0773

Breast Self-Examination and Breast Cancer Awareness Among Patients Admitted to Family Medicine Outpatient Clinic

Fatma Gönül Doğan¹, Didem Kafadar²

¹Vize State Hospital, Kırklareli, Turkey

²Bağcılar Training and Research Hospital, İstanbul, Turkey

AIM: In the world 23% of women living with cancer have breast cancer. Breast self-examination(BSE) is one of the methods of raising awareness among women and starts at 20 years. Screening programs for breast cancer begins at 40 years for early detection and mamography is the golden standard. We aimed to evaluate the awareness of the patients in the family medicine(FM) outpatient clinic about breast cancer and BSE.

MATERIAL-METHOD: In our study, in a provincial state hospital close to the rural area a questionnaire was applied to the voluntary women patients over 20 years of age in the family medicine outpatient clinic. The questionnaire was prepared by the researchers and asked about attitudes towards mamography and BSE.

RESULTS: There were 155 women, the mean age was 44.13. Patients were mostly in 40-64 age group(%48.4). 58% of patients had 5 years of primary education(PE). 78.7% patients were married. 80 women(51.6%) performed BSE. 33.3% of the illiterate patients were aware of BSE. Among graduates of 5 years PE, 8 years PE and high school, the BSE performance percentages were 45.5, 68.7 and 83.3 respectively. 35% of patients performed BSE every month regulary. 42.7% patients who did not perform BSE reported that they did not know how to do BSE. History of mamography screening was 22.6% in the whole group and it was 37.3% in 40-64 age group, 26.7% in patients who were 65 and over. The patients reported that they obtained information about breast cancer and BSE mostly from television and then from friends, gynecologists, general surgeons and FM practioners respectively.

CONCLUSION: In our study, the lowest awareness of BSE was in the illiterate group, as education level increased the BSE increased. FM practioners should provide adequate information about breast cancer, screening and BSE in terms of secondary prevention.

Keywords: breast self-examination, breast cancer, awareness, screening, mamography

P-0774

Evaluation of Cases with Postmenopausal Bleeding

Tuba Ömeroğlu, Zehra Dağlı, Zeynep Bayraktutar, Ayşe Selda Tekiner, Mehmet Ungan
Department of Family Medicine, School of Medicine, Ankara University, Ankara, Turkey

OBJECTIVE: Postmenopausal uterine bleeding mainly originates from endometrial polyps, endometritis, exogenous hormone uptake, submucous myoma, atrophic vaginitis and endometrial carcinoma. Further investigation is essential particularly to exclude endometrial carcinoma. The study was carried out to detect prevalence of endometrial carcinoma in patients with postmenopausal bleeding.

METHOD: Medical records of 108 patients who applied to the gynaecology outpatient clinic of a university hospital for postmenopausal bleeding between 2011 and 2012 were reviewed retrospectively. As the results of endometrial biopsy five patients were missing, 103 patients were included in the study. The patients were categorized in four age groups. Descriptive statistics were given as mean±standard deviation and percentage. Chi-square test was used for differences between the groups. Any $p < 0.05$ was considered statistically significant.

RESULTS: Mean age of the patients was 56.91 ± 8.70 (median, 56; minimum, 39; maximum, 84) years. Seventeen (16.5%) of the patients were ≤ 49 , 52 (50.5%) were 50-59, 23 (22.3%) were 60-69, and 11 (10.7%) were ≥ 70 years old. Eleven (10.7%) patients had endometrial carcinoma, and nine (8.7%) had endometrial hyperplasia. Two (18.2%) of the patients with endometrial carcinoma were 50-59, six (54.5%) were 60-69, and three (27.3%) were ≥ 70 years old. Three (33.3%) of the patients with endometrial hyperplasia were ≤ 49 , four (44.4%) were 50-59, one (11.1%) was 60-69, and one (11.1%) was ≥ 70 years old. The difference between the groups was statistically significant ($p=0.040$).

CONCLUSION: All patients at menopausal period should be informed about the risks of endometrial carcinoma,

70% of which occurs between 45-74 years, and should be advised to consult their family physician when they have postmenopausal bleeding.

Keywords: postmenopausal bleeding, endometrial carcinoma, family physician

P-0775

Primary amenorrhea: A Case Report

Ahmet Ünal¹, Ahmet Anık², Tolga Ünüvar²

¹Department of Family Medicine, Adnan Menderes University, Aydın, Turkey

²Department of Pediatric Endocrinology, Adnan Menderes University, Aydın, Turkey

INTRODUCTION

Primary amenorrhea can be diagnosed if a patient has normal secondary sexual characteristics but no menarche by 16 years of age. If a patient has no secondary sexual characteristics and no menarche, primary amenorrhea can be diagnosed as early as 14 years of age. The incidence ranges from 0.1% to 2.5%. The most common cause of gonadal failure, and congenital absence of uterus and vagina constitutional delay.

CASE REPORT

Fifteen-year-old female patient was admitted with complaints of amenorrhea. It didn't feature in the history of the patient and family history. On physical examination; body weight was 47.5 kg (10-25p), height 149 cm (3p) and body mass index of 21.4 (50-75p) that found. There were no pathological findings in systemic examination. Breast development and pubic hair were evaluated according to Tanner stage 4. Laboratory tests were within normal limits. For the etiology of secondary amenorrhea beta-human chorionic gonadotropin (β -hCG) level is negative (<1.2 mIU/ml) determined by the patient's serum follicle stimulating hormone (FSH) 7.19 mIU/mL (N: 3.35 to 21.63), luteinizing hormone (LH) 11.62 mIU/mL (N: 2.39 to 6.6), prolactin 18.36 ng/mL (N: 1.2 to 29.93), respectively. Thyroid function tests were normal. Patient's bone age 14 years. The patient's pelvic ultrasonography (USG) were within normal. Considering progesterone failure, patients have started medroxyprogesterone acetate 5 mg for 10 days. 5 days after drug withdrawal patient first menstrual period occurred. The patient underwent the same treatment for three cycles, patient's menstrual cycle became regular and were followed.

CONCLUSION

Detailed story, detailed physical examination and laboratory findings of the evaluation of secondary sex characteristics are important in diagnosis. Primarily, pregnancy should be excluded, thyroid function tests, prolactin, FSH, LH, estradiol levels should be measured and pelvic ultrasonography should be performed to assess the genital organs. According to FSH levels it can be classified as normogonadotropik, hypergonadotropic and hypogonadotropic hypogonadism. Karyotype analysis should be performed in cases of hypergonadotropic hypogonadism, hypogonadotropic hypogonadism cranial imaging in cases to be made. Such cases should be made without delay in diagnosis and treatment. Diagnosed in primary care to many patients the chance to be caught with scrutiny.

Keywords: Primary amenorrhea, Primary Care, Diagnostics

P-0776

Breaking Bad News: is the SPIKES strategy known, used, helpful in the clinical practice of a family physician?

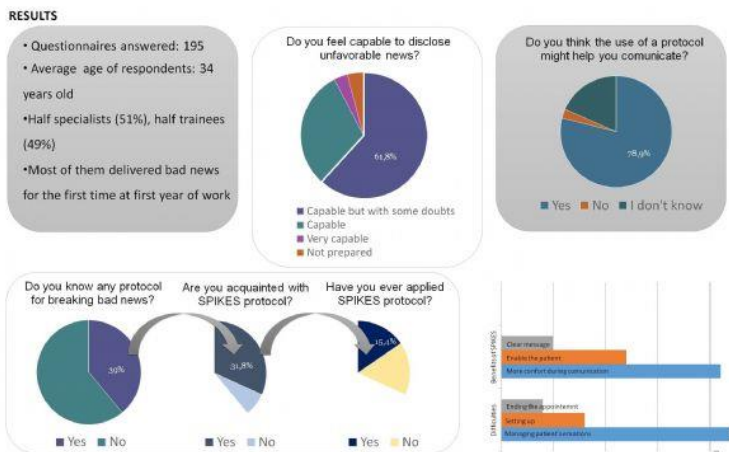
Erica Rocha, Maria Ana Sobral

Unidade de Saúde Familiar AlphaMouro, Rio de Mouro, Portugal

BACKGROUND: The right of any patient to information is consensual, though ethical and moral problems may emerge. As Family Doctors conveying bad news with a strong psychological impact on the patient is a professional and personal challenge. With this study we want to assess whether the Family Doctors feel well prepared for the task of conveying bad news and if they have the urge of improving their abilities. We selected a protocol (SPIKES) in order to confirm whether it is recognized, used in clinical practice and the benefits or difficulties when implemented. **METHOD:** A cross-sectional and descriptive study based on an on-line set of questions sent to specialists and interns in General Practice and Family Medicine; a questionnaire available in Portuguese, with 14 multiple choice and open response questions. **RESULTS:** The situations more frequently reported were those of poor prognosis (56,6%), death and chronic disease (21,6%). Most of the respondents considered themselves prepared for the task, but with some qualms about this kind of communication (57, 3%). 61,4% of the respondents identified the need for education and training in this type of communication as extremely important. Only 39, 8% were acquainted with a communication of bad news protocol. In this group 80% knew the protocol SPIKES but only 36, 7% had implemented it as a communication strategy. Among the professionals who stated the use of this protocol, 19 recognized the management of the patient's emotions as a major problem; 16 reported that a clearer announcement of the news and a greater personal comfort (11) were the main benefits of its application. **CONCLUSIONS:** The announcement of bad news is a fact within the Family Doctor's practice. It will be essential to invest, namely in pre-graduate education focused on communication techniques deemed to ease efficient transmission and management of this type of news.

Keywords: Breaking Bad News; Protocol; Communication

Results



Rammya Mathew¹, Nathan Davies¹, Jill Manthorpe², Steve Iliffe¹

¹Department of Primary Care and Population Sciences, University College London

²Social Care Workforce Research Unit, Kings College London

Background and Aims

Decision-making for someone with dementia at the end of life is complex and challenging. There is a lack of formal guidance about how to manage their needs. Practitioners often subconsciously rely on 'rules of thumb' or heuristics to make decisions about end of life care. A systematic review of the literature was performed to identify whether heuristics formally exist as an entity in palliative dementia care, and if so, to identify the context in which they are being used.

Methods

A search using broad terms related to dementia, palliative care and decision-making was conducted across four electronic databases (MEDLINE, EMBASE, PsycINFO and CINAHL).

Results

The search identified ten papers that contained an algorithm, guideline, decision-tool or set of principles that were in some form compatible with heuristic thinking. The papers addressed swallowing and feeding difficulties, the treatment of pneumonia, management of pain and agitation, ending life-sustaining treatment and ensuring a good death.

Conclusions

The use of heuristics in palliative dementia care is not formally documented in the literature. However, the review has synthesised important decision-making principles that are largely a reflection of expert opinion. These principles have the potential to be developed into simple and easy to use heuristics.

Keywords: Dementia, Palliative care, Decision-making

Table 1: Search Terms

Search Terms	
Dementia	Dementia, Alzheimer disease, delirium, amnestic and cognitive disorders, cognitive defect, cognitive impairment
Palliative Care	Palliative care, terminal care, end of life care, terminally ill patients, death and dying
Decision-making	Decision-making, algorithms, decision support techniques, decision support systems, clinical judgment, heuristic, rules of thumb

Table 2: Summary of selected papers

Theme	Publication	Summary of decision-making concepts
Swallowing and eating difficulties	(McAlister et al., 1989)	Establish the goals of feeding - is it to provide calories/ prolong life/ maintain comfort? Weigh up the risks vs benefits of available feeding options.
	(Smith et al., 2009)	Search for reversible causes of reduced eating. Encourage use of good mouth care. Review and if necessary discontinue constant and distressing attempts to continue feeding.
	(Palecek et al., 2010)	Use the term 'comfort feeding only' to reframe discussions about hydration and nutrition.

	(Gillick, 2012)	Encourage family and carers to recognise that reduced feeding can be a consequence of the dementia disease process. Look for reversible causes. Empirically modify food and hand feed to whatever extent is tolerated.
	(Schwartz et al., 2014)	Literature review - concludes that a decision to forgo artificial hydration and nutrition is in line with current evidence. Encourages multidisciplinary involvement in decision-making.
Treatment of pneumonia	(van der Steen et al., 2000)	Evaluates the use of a checklist developed in The Netherlands to make decisions about whether or not to treat pneumonia. Consider risks vs benefits of treatment. Consider the best interests' of the patient above all.
	(van der Maaden et al., 2014)	Five round Delphi study looking at optimal symptom relief of pneumonia <ul style="list-style-type: none"> • Measuring oxygen saturation does not help with the management of shortness of breath • Give oxygen if shortness of breath is burdensome • In patients with chronic obstructive pulmonary disease and shortness of breath – use corticosteroids, bronchodilators and opioids • A burdensome cough warrants opioids • There is no evidence that anticholinergics reduce sputum retention and rattling breath
Pain and agitation	(Kovach et al., 2012)	Evaluates the use of a 5-step and a 9-step decision support tool used to address pain and agitation -address the physical and environmental needs of the patient and then target symptoms with interventions. Balance sensory stimulating and sensory calming activity, trial analgesia before antipsychotic medication and review treatments regularly.
Rationalising medication	(Zagaria, 2015)	Medication not in line with the primary goals of care should be stopped. Cholinesterase inhibitors should not be prescribed for dementia, without periodic assessment of the perceived cognitive benefits and adverse gastrointestinal effects.
Ensuring a good death	(Cahill et al., 2012)	Uses information from interviews with bereaved spouses to identify a set of principles to support dementia end of life care in nursing homes: Individualised care Excellent personal care Integration of nursing homes with local healthcare systems Foster a sense of partnership between staff, residents and families.
	(Karlawish et al., 1999)	Describes a process of how to reach consensus in decision-making: Identify key decision-makers, establish dialogue and put knowledge about the patient in the foreground; then seek consensus about the current diagnosis and prognosis.
Ending life-sustaining treatment	(Callahan, 1995)	No one should live longer with advanced dementia than they would have done in the pre-technological era. In late-stage dementia there should be a shift towards stopping rather than continuing treatment.

Figure 2: Example heuristic

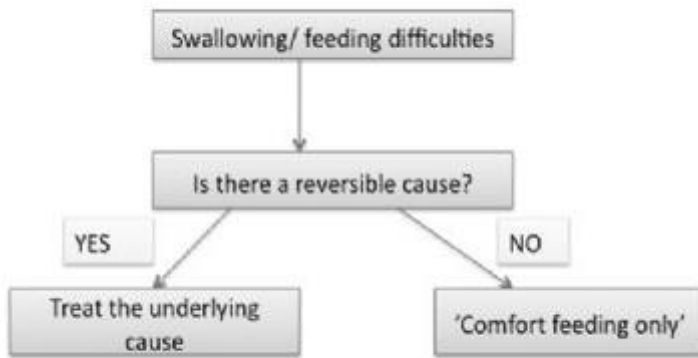
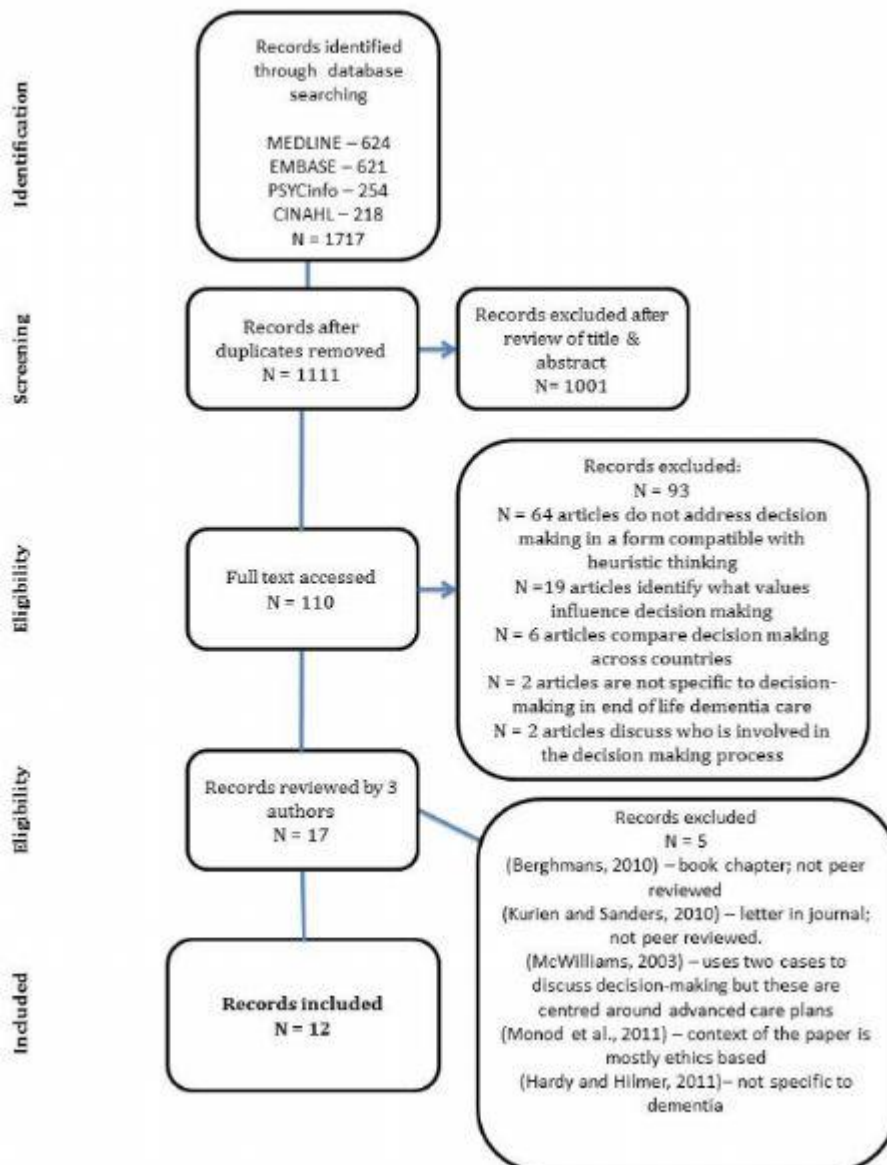


Figure 1: PRISMA



P-0778

Japanese nurses' experiences with life-support treatment and its impact on decision-making

Fumio Shaku¹, Madoka Tsutsumi²

¹Nihon University Itabashi Hospital

²Tsukuba University

Background & Aim

The Japanese sense of decision making (like OMAKASE, which means "to entrust") differs from that observed in Western countries. Recently, the decision making for terminal care patients has been discussed widely. However, it is suggested that many patients and their family members make such decisions without adequate information. In the clinical setting, we feel that it is tough for many patients and their family members to make a decision, partially because they may not be aware of the severity of the situation. Therefore, we studied how the practical experience of nurses working at hospitals influences their decision making.

Method

Self-reported questionnaires on nurses' attitudes toward life-support treatment in case it were intended for themselves or their family member in the terminal stage for cancer and non-cancer situations, and their experiences related to their patients' death, were distributed to 600 nurses working at five hospitals in Japan.

Results

In total, 475 questionnaires were returned, out of which 391 (67.9%) completed questionnaires were analyzed. The mean age of the participants was 40 ± 10.6 years, and 95.7% were females. Further, 345 of them had experience with patient death. Those hoping (hope group) or not hoping (no hope) for family's life-support treatment for cancer were 255 and 136, respectively, and the same in non-cancer situations were 275 and 116, respectively. The median of experience with patient death in the no hope group was significantly higher than that of the hope group ($p < 0.005$).

Conclusions

It is suggested that higher the experience with patient death, lesser is the hope for life-support treatment for oneself or one's family member. Based on this result, it is clear that thorough discussion regarding the reality of the situation with the medical staff seems to be indispensable to the decision making for a patient and his/her family.

Keywords: decision-making, nurse, terminal care, life-support treatment

P-0779

Fentanyl pectin nasal spray as treatment of breakthrough pain in terminal patients with amyotrophic lateral sclerosis

Pablo Alvarez Jimenez, Antonia Quiñones Perez, Karolina Wawrzycka
Närhälsan Mariestad Vårdcentral, Västra Götalandsregionen, Sweden

PURPOSE:

Amyotrophic Lateral Sclerosis (ALS) is a neurodegenerative disease characterized by a gradual death of motor neurons that causes atrophy of the voluntary muscles producing muscle and respiratory function disorders. The majority of the people affected by this disease, which causes great suffering, die a few years after diagnosis, although some can survive more than ten years.

Patients may show symptoms such as muscle weakness, atrophy, hyperreflexia, pain or bulbar symptoms such as dysphagia, dysarthria and shortness of breath. With the progression of the disease, these symptoms cause new and problematic conditions for patients with ALS, orally administrated medicament can be difficult in the stages advanced by dysphagia.

Pain is an aspect of the disease that is commonly passed by high, undervalued and potentially undertreated in ALS patients, and this becomes more evident when we talk about breakthrough pain (BTP).

CASE:

We present a case of advanced ALS with progression of the disease symptoms dyspnea, dysphagia and skeletal muscle pain which are crisis of BTP with flaccid and loss of muscle tone to cervical and upper limbs. The management of dyspnea and basal pain became controlled with slow-release morphine (340 mg per day) and fentanyl pectin nasal spray (200 mcg) for BTP was used. The patient and his family express the speed of action of fentanyl pectin nasal spray and the ease of management and safety of this medication.

CONCLUSIONS:

Pain is a common symptom in all stages of the ALS, being an aspect of the disease that commonly overlooked and a high percentage of the time is below diagnosis and treatment. Morphine is safe for the management of pain and dyspnea in ALS patients. The muscular component of pain in these patients, with sagging and loss of tone, responds adequately to the fentanyl. Side effects have not been described.

Keywords: Fentanyl pectin nasal spray, breakthrough pain, amyotrophic lateral sclerosis

P-0780

A case of idiopathic Trachyonychia

Adem Parlak¹, Nehir Parlak², Salim Özenç³, Yusuf Emrah Eyi⁴

¹Department of Family Medicine, President Guard Regiment, Ankara, Turkey

²Department of Dermatology, Etimesgut Public Hospital, Ankara, Turkey

³Department of Family Medicine, Diyarbakır Military Medicine, Diyarbakır, Turkey

⁴Department of Emergency Medicine, President Guard Regiment, Ankara, Turkey

INTRODUCTION: Trachyonychia or rough nails, may present as an idiopathic disorder of the nails or it can be associated with other dermatological conditions. The dystrophic nail findings seen in trachyonychia are characterized by brittle, thin nails, with excessive longitudinal ridging. The most common histopathologic features associated with trachyonychia are spongiosis and exocytosis of inflammatory cells into the nail epithelia; typical features of lichen planus or psoriasis can also be detected. Determining the cause of trachyonychia is challenging. Trachyonychia is much more common in children, with an insidious onset and peak age of 3 to 12 years. However, it can occur at any age. Trachyonychia can be a manifestation of a pleomorphic group of disorders or can be idiopathic

CASE: We report the clinical features in the eighteen-year-old male with idiopathic trachyonychia (twenty-nail dystrophy). Both finger and toe nails findings seen in trachyonychia are characterized by brittle, thin nails, with excessive longitudinal ridging. This gives the nail plate a rough, opaque appearance. Trachyonychia have been no associated with alopecia areata, psoriasis, lichen planus, atopic dermatitis, ichthyosis vulgaris, as well as other skin conditions.

CONCLUSION: A comprehensive review of the literature reveals that there is no single evidence based treatment for trachyonychia. Therefore, there is no universally accepted treatment for this chronic disorder and many options have been discussed in case reports. Treatment of trachyonychia is mainly cosmetic as it is not a permanently scarring condition. In patients who desire treatment, there are both topical and systemic options that have been shown in case reports to be successful. Tazarotene gel 0.1%, psoralen plus ultraviolet A (PUVA) and intralesional injection of triamcinolone into the proximal nail fold at a concentration of 2.5-10 mg/ml has been shown to be effective in patients.

Keywords: idiopathic, trachyonychia, dermatology

Figure 1. Idiopathic Trachyonychia



Brittle, thin nails, with excessive longitudinal ridging

P-0781

Polypharmacy and Irrational Prescribing in Palliative Cancer Patients: Observations from a Tertiary Cancer Hospital in India

Dr Hannah Fox, Dr Rakesh Roy

Department of Palliative Care, Saroj Gupta Cancer Centre and Research Institute, Kolkata, India

Background

The World Health Organization (WHO) estimates that globally, more than half of all medicines are prescribed inappropriately. Irrational use of medicines is a major problem in India. Patients with advanced cancer are especially at risk of polypharmacy.

Aims

- To determine the degree of polypharmacy in advanced cancer patients
- To determine the classes of medicines most commonly prescribed
- To determine if analgesia is prescribed using WHO ladder

Method

The medical records of thirty inpatients admitted December 2014-January 2015 were reviewed. Demographics, primary diagnosis and prescriptions on medicine cards were documented.

Results

The mean number of medications prescribed per patient was 11.7(range 3-29). 77% of patients were taking more than 7 medications.

100% of patients were prescribed proton pump inhibitors. Analgesics were the second most commonly prescribed medication followed by health supplements (63%) and antibiotics (57%).

70% of patients were prescribed analgesia, 53% in line with the WHO ladder. 20% were prescribed step three analgesia.

Conclusions

This study demonstrates that the number of medicines prescribed for advanced cancer patients in India is substantially higher than in Europe (7.8)[1]. Over three-quarters of the patients were taking more than 7 medications, putting them at >80% risk of adverse interactions[2].

Only 20% of patients were receiving strong opioids and approximately half of the patients did not receive analgesia according to WHO ladder. As 85% of advanced cancer patients experience pain, overall management was suboptimal(Twycross, 1996).

This study highlights the wider issues of irrational prescribing in India and the need for improved regulation and policies.

1. Kotlinska-Lemieszek A. et al., Polypharmacy in Patients With Advanced Cancer and Pain:A European Cross-Sectional Study of 2282 Patients. J Pain Symptom Manag 2014;48,6:1145–1159

2. Steinhauser KE et al. Factors considered important at the end of life by patients, family, physicians, and other care providers. JAMA 2000;284:2476–2482.

Keywords: Palliative Care Polypharmacy Cancer India

Figure 1. Frequency of prescriptions of each category of medication

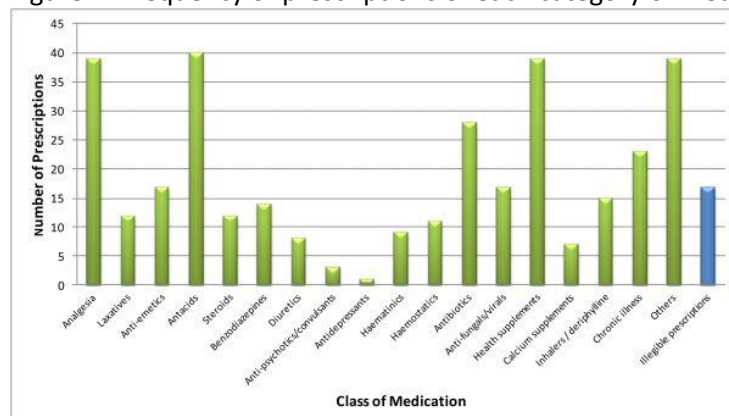
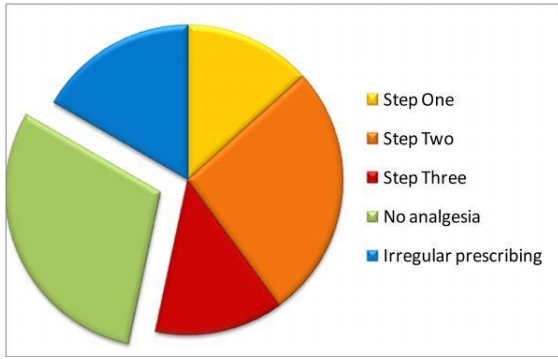


Figure 2. Analgesia prescribing according to WHO Ladder



Photograph in Kolkata



P-0782

Meditation and Relaxation practice with Palliative Care patients at home

Carmen Carrazoni¹, Manu Pérez³, Elvira Perpinyà², Roser Casas³, Nieves Navas⁴, Maria Diamanti⁴

¹ABS Via Roma - Barcelona - Spain

²CAP Sants – Barcelona

³CSMA Rubí (Barcelona)

⁴CS Almozara – Zaragoza - Spain

Background and Aims

It has been described in Medical literature the usefulness of Meditation and Relaxation practices in a regular way in order to obtain a better acceptance of illness and to reduce the stress produced by oncologic disease in patients and their caregivers. From an experiment carried out in a hospital with 800 patients and their caregivers we decided to try this practice at their homes.

Method

From January 2013 to 2014 the Palliative Care team at home help, offered the possibility of practicing Meditation to patients who were capable of doing it. An expert in this practice went to the patients' home once a week. A guided Meditation, visualization of the somatic scheme, and conscientious breathing, where the patient is aware of their body's sensations, was carried out during 20 minutes. This was followed by three or five minutes of silence and even longer if the patient needed. After the person returned to their consciousness, they could share the experience if they wished so.

Results

17 patients with highly developed cancer participated. Age between 21 and 86 years old. Two patients gave the practice up, because they felt anxiety during the silence. Between 7 and 24 Meditation sessions were carried out with excellent tolerance and acceptance. All professionals that conducted these sessions felt that the patients and caregivers pain, emotions, physiological and spiritual harmony were better managed and their response to this practice was positive.

Conclusions

The result of this experiment suggests that practicing Meditation at oncologic patients' homes is possible and well received. It is effective for pain management and better acceptance of the illness. We believe that this experience should be extended to larger groups of patients and caregivers since this practice may correspond to a valuable holistic complement to cancer treatment for non hospitalized patients.

Keywords: Meditation, relaxation, cancer

P-0783

Arabic-Speaking Individuals' Understanding and Attitudes Towards Hospice and Palliative Care in the Ambulatory Setting

Allison Peddle, Md, Melissa Castaneda, Md, Lesca Hadley, Md, Richard Young, Md
Family Medicine, John Peter Smith Hospital, Fort Worth, Texas, United States

BACKGROUND AND AIM: At John Peter Smith Hospital's International Health Clinic (IHC) in Fort Worth, Texas, we provide comprehensive primary care to various refugee and ethnic minority populations with the vast majority from Africa, Burma, Nepal, and the Middle East. Each population has its own understanding and attitudes of the death and dying process. The purpose of this study is to investigate the understanding and attitudes of Arabic-speaking cultural minorities towards Hospice and Palliative Care (HPC) to help us better understand how to provide culturally sensitive information and care in regards to HPC. **METHODS:** A modified AARP End of Life Questionnaire was translated into Arabic language using a certified Arabic language translator. The questionnaire was mailed to Arabic-speaking individuals identified from IHC database with a return stamped envelope. Questionnaires that were answered and returned to us were then translated into the English language by a different certified Arabic language translator. **Inclusion criteria:** adult Arabic-speaking patients who have moved to the United States within the past five years. **Exclusion criteria:** patients ages less than eighteen and those who do not speak Arabic. Subjects will be asked about their understanding of HPC and their personal experiences of caring for dying patients in their home countries. Sub-analyses will include comparisons of subjects' responses by age, gender and region of origin. **RESULTS AND CONCLUSIONS:** Will be ready in time for conference.

Keywords: Arabic, Hospice Care, Palliative Care, Questionnaire, Refugee

P-0784

A successful case in a Palliative Care Unity

Sara Neves Costa¹, Mariana Sousa Silva²

¹USF Mactamã, ACES Sintra, Portugal

²UCSP Póvoa de Santa Iria, ACES Estuário do Tejo, Portugal

BACKGROUND:

During medical school we were thought how to save lives but not to tend to their demise. It's important to understand and embrace another perspective of health care that focuses on symptoms palliation when there's no possible treatment. In palliative care the well-being and comfort of the patient is a priority, since the symptomatic therapy can relieve suffering and improve the quality of life during his last days.

CASE:

66 years old male, with a terminal stage gastric adenocarcinoma. Lives with his wife and is independent in daily activities.

The patient was admitted in the Oncology department for etiological evaluation of fever and digestive bleeding. On physical examination he presented poor condition, jaundice and abdominal abscess (previously diagnosed). Blood tests demonstrated cholestasis and severe anemia without clinical criteria for transfusion. It was admitted situation of last days and the patient was transferred for the palliative care unit (PCU).

During hospitalization in the PCU the patient began treatment with dexamethasone for cholestasis and antibiotherapy for the abscess, with improvement of his clinical condition. Consequently he was eligible for transfusion, which helped him recover his previous functional capacity. In order to program a possible home discharge the analgesic therapeutic was optimized and the health staff successfully empowered the patient and family to manage pain medication. After discharge the patient maintained his follow up with the outpatient palliative care team.

CONCLUSIONS:

This reported case shows that admission in a palliative care unit not always ends in patient decease. In some situations we accomplish an appropriate control of the symptoms and make possible the patient discharge to home. Such accomplishment provides better life quality in a terminal disease. This report is also an example of how much can be done when doctors admit there's no possible cure for a terminal disease.

Keywords: Palliative Care; Empowerment; Symptoms control

P-0785

International experience in Palliative Care: Give life to the last days

Sara Neves Costa¹, Mariana Sousa Silva²

¹USF Mactamã, ACES Sintra, Portugal

²UCSP Póvoa de Santa Iria, ACES Estuário do Tejo, Portugal

Background & AIM:

The portuguese postgraduate training program of family doctors includes the optional realization of international rotation. In this context we decided to experience working in the Palliative Care Unit of Hospital de L'Esperanza in Barcelona. This unit is integrated in a structured network of hospital and outpatient care with large experience in this area.

The aim of this presentation is to share our experience. This way we mean to show some aspects of the terminal patient care, including the necessary competences to communicate with the patient and his family and to give a new perspective of health care that focuses on symptoms palliation and not on disease treatment.

Justification:

The holistic approach and the longitudinal continuity of care are two competences and characteristics of the family doctor and are particularly important when treating a terminal patient.

Content:

The Palliative Care Unit of Hospital de L'Esperanza it's part of the Oncology department of Hospital del Mar and receives patients with terminal cancer or other terminal situations that require hospitalization. The primary goal of this unit is to provide the maximum comfort for the patient and his family by controlling physical and emotional symptoms. A multidisciplinary team of doctors, nurses, social workers and other health professionals provides this care and optimizes it for the specific characteristics of each patient. The treatment approaches in this unit do not aim to delay or accelerate the process of dying instead they try to give dignity and a sense of well-being during the last days. In a minority of cases is possible to discharge the patients home when there's a control of symptoms and since there's an excellent support of this patients provided by the family and the outpatient palliative care team.

Keywords: Palliative Care, International experience, Terminal disease

P-0786

"The dying patient – the family doctor's role"

Maria Ana Sobral, [Maria José Verdasca](#)

Unidade de Saúde Familiar AlphaMouro, Rio de Mouro, Portugal

INTRODUCTION: Family physicians often accompany people with a poor prognosis in the context of a holistic approach in order to provide comfort and quality of life to the patient and their family. The objective of this work is to stress the family physician's role in managing the fears and expectations of the family of the dying patient.

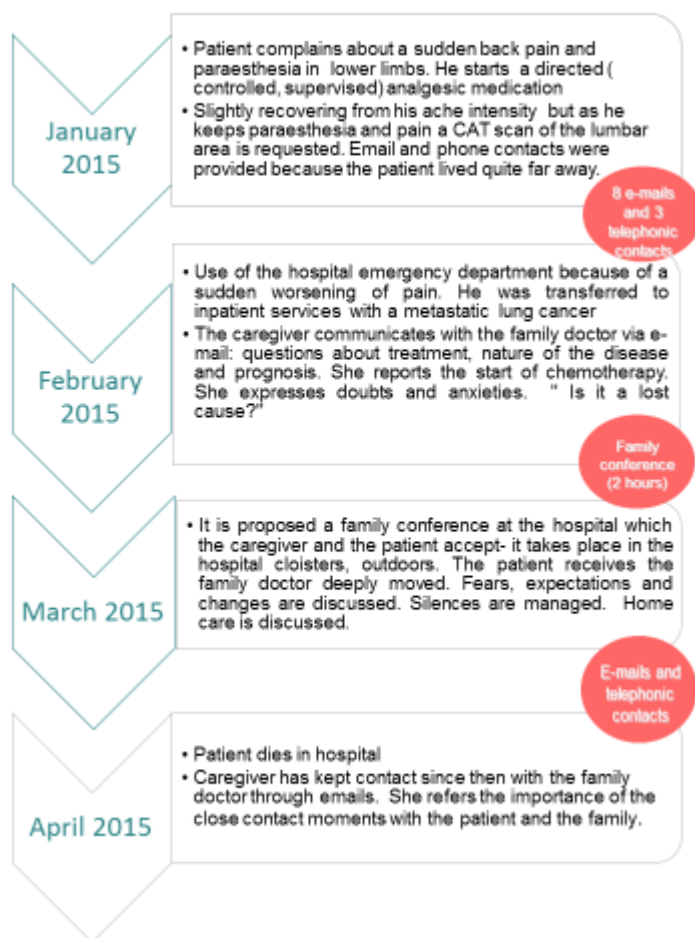
METHODS: Qualitative analysis of a case of a 63 year old male dying patient, admitted to hospital with multiple metastasis lung cancer diagnosis. The wife is the primary caregiver, with the whole family involved in the task. The data were collected through observation, with hospital visits and field notes.

RESULTS: The FPh, contacted by the wife of the patient for concern and anxiety about the diagnosis and prognosis, evaluates, in a first step the patient and family needs. A family conference is set in the internment place to work fears and expectations. A communication channel (telephone and email) is created and that resulted in an apparent decrease in anxiety levels and improved the psychosocial well-being of the patient and the family.

CONCLUSION: It is essential to maintain open communication with the family members of the dying patient. The simple intervention of recognition and support, the availability of communication means, led to a decrease in the family anxiety levels. The doctor's visit to the patient's environment, programming and integrating the family in the process of life and death was perceived as useful by the relatives.

Keywords: Communication; End-of-life; family's conference

Clinical case and communication strategies



P-0787

Crossed stories

Paula Mendes¹, Vítor Portela Cardoso²

¹USF Maxisaúde, ACES Cávado I, Braga, Portugal

²USF Gualtar, ACES Cávado I, Braga, Portugal

Background and AIM: Lung cancer is the leading cause of death from malignancy in most western countries. Only 5-15 % of lung cancer are detected while asymptomatic. Currently, screening for lung cancer are not recommended. This case demonstrates the dynamics of family medicine in the prevention, diagnosis, treatment, monitoring and palliation.

Method and RESULTS: We report the clinical case of a 50 years-old female patient, caucasian race, formerly working in a textile factory, lower-middle class Graffar. No relevant personal history. No smoking or exposure to known occupational carcinogens. Family history of gastric cancer (paternal grandmother). She went to her family physician in July 2010 to request "routine tests" and pulmonary radiography, because, one month before, her husband had been diagnosed with lung cancer. She felt anxious about the possibility to have a serious illness too. She denied any symptoms. No alterations in the physical examination. Pulmonary radiography was requested, which showed suggestive of lung cancer, confirmed by the computed tomography. Histological diagnosis revealed "moderately differentiated adenocarcinoma mixed pattern". She was submitted to pneumonectomy in January 2011 and chemotherapy and adjuvant radiotherapy. In June 2012, her husband died after a pulmonary embolism, and four months later she also died in a Palliative Care Unit. Throughout the process, the couple was followed up by their family physician.

CONCLUSION: The case presented several challenges. Family physician must not only meet their agenda, often based on standards of clinical practice guidelines, but also the patient's agenda, corresponding to their expectations, their beliefs and their fears or concerns. Thus, it's important to make use of our intuition (gut feelings) in a measured way, in a individualized approach to the patient. Finally, the management of bad news communication of is one of the roles of the family physicians, embracing the support to patients and their families

Keywords: Lung cancer, illness, gut feelings.

P-0788

A New Alternative Treatment For Radiation-Induced Skin Injury; Acupuncture

Abdulsamet Zortul¹, Sultan Oksuz Zortul², Ozlem Ozer²

¹Department of Radiation Oncology, Ataturk University, Erzurum, Turkey

²Department of Family Medicine, Ataturk University, Erzurum, Turkey

Radiation therapy uses high-energy rays (x-rays etc.) or particles (photons, electrons, or protons) to kill cancer cells by damaging their DNA. When the damaged cells die, they are broken down and eliminated by the body's natural processes. But not only cancer cells, normal cells are damaged as well. This is the cause leading to side effects, most of which are short-lived include sore skin, tiredness and hair loss. With longer treatment, these side effects may get worse. After many years, skin cancers may develop in areas previously treated by radiation. In rare cases, radiotherapy can cause significant long-term effects such as infertility or sarcomas. Although these side effects radiation therapy is precious and good choice to cure some cancers and to delay the growth of more advanced cancers. Radiation is also useful when combined with other treatments and may also be used to help treat cancer that has spread to lymph nodes or other organs. It is used to treat cancer or after a surgery as an adjuvant treatment or for palliative therapy.

Acupuncture literally means to puncture with a needle. However, the application of needles is often used in combination with moxibustion (the burning on or over the skin of selected herbs) and may also involve the application of other kinds of stimulation (laser, electroacupuncture) to certain points. In some countries, many skin diseases are treated with acupuncture such as chloasma, acne vulgaris, relieving pain of herpes zoster, promoting formation of scar tissue neurodermatitis and is also known to have an antipruritic effect. Acupuncture improves quality of life if it is applied before and after radiotherapy. It can greatly lessen the adverse reactions on the skin such as skin injury, redness and drying. It also provide protection against damage to haematopoiesis and side effects of digestive and nervous systems.

Keywords: Alternative treatment, Radiation, Skin injury, Acupuncture

P-0789

Evaluation of anxiety and depression symptoms of cancer patients' caregivers

Ülkü Bulut¹, Yusuf Adnan Güçlü², Hüseyin Can³, Mehmet Ali Kurnaz⁴, Handan Atsız Sezik⁵, Ahmet Alacacioğlu⁶, Yüksel Küçükzeybek⁶

¹Balçova Community Health Center, Izmir, Turkey

²Izmir Tepecik Training and Research Hospital, Clinic of Family Medicine, Izmir, Turkey

³Izmir Katip Çelebi University Atatürk Training and Research Hospital, Clinic of Family Medicine, Izmir, Turkey

⁴Koprukoy Family Medicine Center, Erzurum, Turkey

⁵Narlidere Community Health Center, Izmir, Turkey

⁶Izmir Katip Çelebi University Atatürk Training and Research Hospital, Clinic of Medical Oncology, Izmir, Turkey

BACKGROUND: Palliative care has been implications for terminal stage patients with depleted therapeutic approaches; today, the belief of need for palliative care with curative therapies for patients since beginning of life-threatening diseases is present. Depression and anxiety symptoms found commonly in chronic diseases like

cancer and these symptoms were also common for caregivers of cancer patients. So we aimed detecting and evaluating depression and anxiety symptoms of caregivers of hospitalized cancer patients in Izmir Katip Çelebi University, Atatürk Education and Research Hospital, Palliative Care Services.

METHODS: Study was designed as descriptive cross-sectional research. Survey performed by face to face interviews after obtaining consent of the relatives of the patients. The survey consists of Beck Anxiety Inventory, Beck Depression Inventory, Hospital anxiety and depression scale chapters and socio-demographic variables. The study was conducted with 101 volunteers in a period of three months. The patients' demographic data were summarized using descriptive statistics. Subgroup analyzes were performed using appropriate parametric and non-parametric tests.

RESULTS: In our study, 101 participants had been involved who were caregivers in palliative care. 61 of them (59.8%) were female and 41 (40.2%) were male. As a result of surveys to examine the prevalence of depression; according to Beck Depression Inventory 43.1 % and was found compared to 91.2% with the HAD scale. When the frequency of anxiety was 66.7% with Beck Anxiety Inventory 72.5% was found with the HAD anxiety scale. 39.2% of the people were depressed and 47.1% of the people were anxious according to both scales.

CONCLUSION: For palliative care services, it is important in terms of observing for mood disorders of caregivers and to provide the necessary support for caregivers because study showed that caregivers have been followed in depressed and anxious mood as well as patients.

Keywords: Palliative care, caregivers of cancer patients, anxiety, depression

P-0790

Clinical prediction of survival in terminal cancer patients: individual assessment vs. interdisciplinary assessment

Hyun Soo Yoon, Chul Min Kim, Yong Joo Lee, Jo Hi Yoon, Ha Ji Jung, Eun Kyung Sin

Department of Family Medicine, Seoul St. Mary's Hospital, College of medicine, The Catholic University of Korea

BACKGROUND: Clinician's prediction can detect things that cannot be objectively measured by test results. In fact, clinician's prediction and actual survival has a significant correlation. No studies have been conducted about the effects of team assessment to predict survival in terminal cancer patients. The aim of this study was to verify the validity of the clinical prediction between individual and team approach in predicting the survival of terminal cancer patients.

METHODS: This is a prospective observational study with hospice inpatients selected 137 people. Four doctors predicted each patients' survival. We obtain an mean value of 4 doctor's survival time. Correlation between survival and clinical expectancy was analyzed using Spearman's correlation. And we analyzed the degree of match of the evaluator by Cohen's Kappa and Intra-class correlation.

RESULTS: Clinician's prediction was correlated with the actual survival time. Team assessment was meant in overall survival group. Prediction between doctors did not match each other. The patients in short survival time have significantly high level of LDH, CRP, TB and lower level of PPS score.

CONCLUSION: Team assessment can be a good way to reduce a deviation of the predicted between clinicians. This study is thought to provide important information on hospice care in that point of the first study analyzed the concordance of clinical staff to predict in life expectancy.

Keywords: Cancer, Palliative care, Survival, Team assessment.

Clinical characteristics of patients in the study population.

	Number (%)
Age*	68.2±13.8
Sex	
Women	80(58.4%)
Men	57(41.6%)

Primary cancer	30(21%)
Hepatobiliary/Pancreas	26 (19%)
Lung	18(13.1%)
Colorectal	11(8%)
Ovary/Cervix	11(8%)
Stomach	41(30%)
Others	
Presence of Comorbidities	73(53.2%)
Presence of Metastasis	123(89.8%)
Palliative Performance Scale	61(44.5%)
≥50%	59(43.1%)
30%-40%	17(12.4%)
≤20%	
Palliative Prognostic Index(PPI)	62(45.3%)
<6	75(54.7%)
≥6	
Clinician's prediction of survival	
A	30(21.9%)
≤10 days	54(39.4%)
11-30 days	53(38.7%)
>30 days	
B	26(19.0%)
≤10 days	57(41.6%)
11-30 days	54(39.4%)
>30 days	
C	31(22.6%)
≤10 days	46(33.6%)
11-30 days	60(43.8%)
>30 days	
D	34(24.8%)
≤10 days	67(48.9%)
11-30 days	36(26.3%)
>30 days	
Doctors Median	21(15.3%)
≤10 days	48(35.0%)
11-30 days	68(49.6%)
>30 days	
Survival time†	23(1,192)
≤10 days	46(33.6%)
11~30 days	46(33.6%)
>30 days	45(32.8%)
CRP†	4.66(0.03,33.66)
Hemoglobin*	10.3±1.7
Lymphocyte†	12.1(1.8,72.0)
WBC†	8090(1230,24350)
T-bil†	0.6(0.1,28.6)
LDH†	661(246,13260)
Ever surgical treatment	59(43%)

Ever chemotherapy 23(16.8%)

Ever radiation therapy 5(3.6%)

CRP: C-reactive Protein WBC: White Blood Cell LDH: Lactate Dehydrogenase *: Mean±SD †: Median(Q1,Q3)

Correlation coefficients between clinician's prediction of survival and survival time.

	Survival time (Total)	Survival time (≤10 days)	Survival time (11-30 days)	Survival time (>30 days)
A	0.461*	0.348†	0.342†	0.229
B	0.438*	0.137	0.374†	0.225
C	0.599*	0.213	0.337†	0.292
D	0.478*	0.216	0.174	0.149
Doctor's median	0.689*	0.275	0.383	0.292

*: P-value <0.001 according to Spearman's correlation †: P-value < 0.05 according to Spearman's correlation

Inter-rater's agreement and Intra-class correlation of survival time in each clinician.

Variables	A	B	C	D
B				
≤10 days	0.360†			
11-30 days	0.252			
>30 days	0.116			
C				
≤10 days	0.299†	0.531*		
11-30 days	0.343†	0.180		
>30 days	0.259	0.270†		
D				
≤10 days	0.252	0.493*	0.340†	
11-30 days	0.264	-0.020	-0.028	
>30 days	0.526*	0.039	0.205	
Doctors' median				
≤10 days	0.449*	0.814*	0.449*	0.498*
11-30 days	0.381†	0.080	0.300†	0.285†
>30 days	0.563*	0.358†	0.446†	0.295†
ICC(A, B, C, D)		0.577		
≤10 days		0.581*		
11-30 days		0.517*		
>30 days		0.295*		

*: P-value <0.001 according to Cohen's Kappa †: P-value < 0.05 according to Cohen's Kappa ICC: Intra-Class Correlation

Differences of clinical variables among survival time groups.

Variables	<10 days	10-30 days	>30days	P-value
Age	66.3	70.4	67.9	0.372
PPS	33.7	43.9	46.2	<0.001
PPI	9.1	6.0	4.6	<0.001
WBC	10155	9808	8497	0.232
Hemoglobin	10.20	10.53	10.27	0.250

Lymphocyte(%)	10.95	12.56	18.00	0.632
T-bil	3.82	1.63	1.09	<0.001
LDH	1336	1030	627	0.006
Creatine	1.35	0.81	0.87	0.071
CRP	7.33	7.13	5.30	0.047

PPS: Palliative Performance Scale WBC: White Blood Cell T-bil: Total bilirubin LDH: Lactate Dehydrogenase CRP: C-reactive Protein

P-0791

Treating cause or consequence

Susana Elizabeth Riesgo, Brenda Elizabeth Riesgo Escudero, Antonio Carpintero Campos, Nuria Tuset Mateu, M Dolores Garcia Moriano, Davinia Blanco Cañas, Elena Pintado Outumuro
Catalan Institute of Health

The patient is a 62 year-old woman, partially autonomous for usual daily activities, who lives with her husband, retired and her main caretaker.

No known drug allergies, with a history of hypertension(2013), flaccid paraplegia(2014) and multiple myeloma(2013). Treated with Rabeprazole 40mg/24hours, Paroxetine 20mg/24hours, Duloxetine 60mg/24hours, Quetiapine 25mg/12hours, Haloperidol 15drops (if needed), Dalteparin 2500UI/ml, Gabapentin 1500mg/24hours, Morphine Sulphate 80mg/24hours and Lenolidorm-DXM (from 2015). Follow-ups are done by the Pain Management Clinic.

Upon arrival she was found in regular general condition; BP 90/60mmHg; HR 114bpm; RR 20rpm; Basal Sat.O284%; Temp.37.3°C; GCS10/15. Respiratory auscultation: widespread stertors. The case is oriented as end-of-life period. Subcutaneous line is placed and Morphine Chloride 1% 0.5ml/4hours, Butylscopolamine 20mg/8hours and Haloperidol 5mg (if needed) were started. The rest of her usual medication is suspended

TREATMENT

It was decided to provide family support, maintaining Morphine Chloride1% 0.5ml/4 hours, Butylscopolamine 20mg/8hours and Haloperidol 5mg(if needed)

EVOLUTION

After 10 hours we return to the home for a follow-up, only to find the patient in good general condition, conscious and oriented. BP 110/60mmHg; HR 103bpm; Basal Sat.O294%; afebrile. No signs of neurological deficit or meningeal irritation. GCS15/15. Respiratory auscultation:few crackles. Case is oriented as "Suspected drug poisoning in polymedicated patient"

We talk to family and decide to withdraw subcutaneous medication and begin a phased drug withdrawal. After 15 days of follow-ups, the patient remained stable, with a decrease in pain intensity. We continued with the drug withdrawal adjusting the pain treatment in conjunction with the Pain Management Clinic

CONCLUSIONS

Being fragile patients with multiple pathologies, it would be prudent to control not only daily clinical signs and symptoms, but to assess whether these are products of the disease itself or correspond to side effects of the drugs. This way, we will prevent treating drug side effects rather than the actual condition itself

Keywords: myeloma / patient chronic / polypharmacy

P-0792

Porocarcinoma: More Than a Rare Disease

Joana Guerra Silva, Ana Franganito Sardo
Algarve - ACES Central I - USF Mirante

BACKGROUND AND AIM:

Porocarcinoma is a rare skin cancer involving the eccrine sweat glands. It has a high potential of local destruction, metastization and recurrence. The aim of this report is to show the challenge to the offer of proximal care in peripheral areas in these cases that requires a close vigilance in specialized tertiary care centers.

METHODS:

Case report.

RESULTS:

Male, 63 years old, Ukrainian, emigrated to Olhão in 1999. Two years later, erythema lesions appeared on the upper face of his left shoulder. Because he did not have a Family Doctor, he recurred to a Dermatologist 5 years later, when an agglomeration of the lesions was verified. He initiated follow up in Lisbon's IPO, where the lesion was totally removed and the diagnosis of porocarcinoma was made. 6 years later it relapsed with a gangliar metastasis on the left armpit. An incomplete gangliar emptying was made, followed by radiotherapy, without complete remission. The wound was too suppurative, needing of triweekly bandages. He was attributed to a Family Doctor, beginning proximity care in articulation with IPO. Motivated by the clinic's worsening, he began chemotherapy in Faro's Hospital, in straight articulation with IPO.

CONCLUSION:

This case represents multiple challenges for the Family Doctor, not only due to its rarity, but also due to the patient's socialcultural context: emigrant who does not know the functioning of the NHS, with a follow up of his disease 300km away from his residence area and who cannot work. Due to the need of frequent treatments and of renovation of his temporary incapacity certificate for work, he maintains contact with his Family Doctor, who has a key role in the enlightenment of his doubts. The need of these patients' attribution to a Family Doctor is remarkable, so that efficient proximity health care can be made.

Keywords: Porocarcinoma; Eccrine Sweat Glands; Primary Care

Background and Aim

Porocarcinoma is a rare skin cancer involving the eccrine sweat glands, mostly affecting people in their 5th – 8th decades of live. It has a high potential of local destruction, metastization and recurrence and, therefore, a bad prognosis. The aim of this report is to show the challenge to the offer of proximal care in peripheral areas in these cases that requires a close vigilance in specialized tertiary care centers.

Case Report

Identification:

- PO, ♂
- 63 years old
- Caucasian
- Ukrainian
- Emigrated to Olhão (1999)
- Chemical Engineer (until 1986)
- Cleaning Faro's Beach
- Married

Personal History:

- Smoking Habits (20 PY)
- # Right tibia
- Medication Habits
 - Triazolam SOS
 - Prednisolone 40mg
 - Ranitidine 300mg
 - Hidroxizina 25mg

Family Characterization:

- Nuclear Family
- Phase V Duvall Cycle

Timeline:

Year	Medical Event / Action
2000	• Hypertigmented lesions
2001	• Erythematous desquamative unique lesion
2006	• Dermatologist
2012	• Relapse-progline metastasis on the left armpit
October 2012	• Lisbon IPO
November 2012	• RT (Faro)
April 2013	• Lisbon Follow-up IPO
May 2013	• He was attributed to a Family Doctor
December 2013	• QT (Faro)
February 2014	• QT (new cycle, Faro)

The graphic also includes clinical photographs of the patient's shoulder and armpit lesions at various stages, and logos for the Hospital do Faro and the Family Doctor's office.

Conclusions

This case represents multiple challenges for the Family Doctor, not only due to its rarity, but also due to the patient's socialcultural context: emigrant who does not know the functioning of the NHS, with a follow up of his disease 300km away from his residence area and who cannot work. Due to the need of frequent treatments and of renovation of his temporary incapacity certificate for work, he maintains contact with his Family Doctor, who has a key role in the enlightenment of his doubts. The need of these patients' attribution to a Family Doctor is remarkable, so that efficient proximity health care can be made.

P-0793

Palliative Care Knowledge of the Health Care Workers at a Tertiary Hospital

Hasret Korkmaz¹, Yasemin Kılıç Öztürk¹, Kurtuluş Öngel²

¹Tepecik Education and Research Hospital, Clinic of Family Medicine, Izmir, Turkey

²Izmir Katip Celebi University, Faculty of Medicine, Department of Family Medicine, Izmir, Turkey

INTRODUCTION: Although palliative care is a new discipline, it has positioned itself quickly in the other areas of medicine. The development of palliative care in Turkey has gained a momentum in recent years. This study has been carried out to determine the knowledge of health staff who work in a tertiary health institution which has a palliative care clinic. In addition, this study aims to create an awareness about palliative care.

METHODOLOGY: The sample size of the study consists of 318 medical staff (46 specialist doctors, 62 non-specialised doctors, 142 midwives or nurses, 69 allied health staff). In the study, socio-demographic form and "the level of knowledge of health staff in palliative care scale which was developed by Nakazawa Y et al. was used.

FINDINGS: The average age of participants was 33.8 ± 7.789 , female majority; the mean duration of the working in the profession was reported as 9.6 ± 7.929 years. 89.9% of health staff claimed that they did not receive training in palliative care during their vocational training and 91.5% of them stated that they did not receive training in palliative care during their work life. 79.9% of health staff indicated that they did not work at a palliative care unit. 64.5% of them qualified their own palliative care knowledge status as medium and 61.2% of them scored their palliative care knowledge level as insufficient. The majority of the health employees pointed out that they did not attend any training on pain, gastrointestinal tract, respiratory diseases, psychology / psychiatry or communication during the last year.

RESULTS: In accordance with the results obtained in this study, to increase the awareness of palliative care, palliative care topic in the education curricula and in-service training programs has been proposed to have a broader place.

Keywords: Palliative care, health staff, knowledge level, family medicine, education

Palliative Care Knowledge

How Do You Feel About Your Palliative Care Knowledge	n	%
Bad	58	18,2
Medium	205	64.5
Well	55	17.3
How Do You Describe Your Palliative Care Knowledge Level		
Insufficient	196	61.2
Sufficient	115	36.2
Very Sufficient	7	2.2

Palliative Care Training Rates of Health Care Workers

Did You Have a Palliative Care Training During Your Vocational Education	n	%
No	286	90

Yes	32	10
Did You Have a Palliative Care Training During Your Occupational Education		
No	291	91,5
Yes	27	8,5
To Have a Training About Pain In The Past Year		
No	266	83,6
Yes	52	16,4
To Have a Training About Respiratory System/ Disease In The Past Year		
No	223	70,1
Yes	95	29,9
To Have a Training About Phsicology/Phsyciatry In The Past Year		
No	265	83,3
Yes	53	16,7
To Have a Training About Gastrointestinal System/ Disease In The Past Year		
No	238	74,8
Yes	80	25,2
To Have a Training About Communication Skills In The Past Year		
No	222	69,8
Yes	96	30,2
Toplam	318	100

P-0794

Dying at home; a possibility in a rural area

Mercedes De La Cruz Herrera, Estefania Andrada Gomez, Josep Vidal-Alaball, Lourdes Martinez Moyano, Rosa Farrés Creus, Gemma Arnau Perramon

EAP Artés, Gerència Territorial de la Catalunya Central. Institut Català de la Salut. Catalunya

Reason for consultation:

Right axillary mass

Current Illness:

90 years man, autonomous in activities of daily life, preserved cognitively. Past medical history of hypertension and dyslipidaemia. No toxic habits. Not known allergies. Good family support. Initial consultation for presenting a right painful axillary mass for the last month. The mass had progressively increased in size. He explained asthenia, weakness and weight loss of 4kg in 2 months. No other symptoms.

Examination:

Patient stable. Right axillary mass of 3 x 3 centimetres, single, hard, painful to palpation and well-defined. Rest of examination without apparent abnormalities.

Complementary Tests:

Complete blood count: normocytic-normochromic anaemia. LDH cholesterol increased. Negative tumour markers. Normal chest X-ray.

Clinical judgment:

Based on the autonomy, cognitive status and presenting symptoms of the patient and in context of an axillary adenopathy and toxic syndrome, it was recommended a referral to the early diagnosis unit for study.

Evolution:

The patient chose not to do any further studies, as the probable diagnosis was likely to be cancer. The patient expressed his desire to die at home. His family (wife, sons and daughter) support his decision. A year after, he peacefully died at his home under the care of an interdisciplinary team integrated by the primary care and palliative care teams.

CONCLUSIONS:

Home medical accompaniment in the final stage of life fosters that many patients with advanced chronic diseases and/or terminal illness could maintain a good quality of life in its usual environment, respecting the will to be cared in their family environment and in a dignified and comfortable manner.

Keywords: Palliative care, rural health, cancer, autonomy

P-0795

Analysis of Inpatients in Family Medicine Palliative Care Unit

Yusuf Adnan Güçlü¹, Yasemin Kılıç Öztürk¹, Tefrik Tanju Yılmaz¹, Umut Gök Balcı¹, Nurdan Tekgül¹, Haluk Mergen¹, Kurtuluş Öngel²

¹Tepecik Training and Research Hospital, Department of Family Medicine, İzmir, Turkey

²İzmir Katip Çelebi University, Faculty of Medicine, Department of Family Medicine, İzmir, Turkey

AIM: Palliative care includes physical, psychological, social and spiritual supports to those patients with life threatening diseases and to their care givers, in order to improve their life qualities. The first palliative Care (P.C.) unit under the name of Family Medicine clinic was opened in June 2013 at Tepecik Education and Research hospital. Chronic patient care, support therapy to home care patients, pain palliation and nutritional support to cancer patients are some of the health services that our unit provide. Purpose of the study is to analysis the patients that followed-up for two years.

MATERIALS-METHODS: Age, gender, diagnosis and hospitalization period of the patients and records were analyzed retrospectively between June 2013-May2015.

FINDINGS: There was 889 hospitalizations. Bed fullness ratio was 55.14%. When repeated hospitalizations were excluded, 594 patients was found. Ages were between 17 and 101 (mean:61) and 240 (40.4%) male, 354 (59.6%) female. The diagnosis were; 37.4% (n:222) obesity, 23.2% (n:138) malignity, 16.3% (n:94) neurological deficiets, 9.6% (n:57) chronic renal deficiency, 7.4% (n:44) diabetes mellitus, 6.1% (n:36) other diseases. Mean hospitalization period was 12.96 days (min:1, max:187). 392 patient were transferred from other clinics; internal medicine 274 (63%), hemodialysis unit 79 (20.1%), anaesthesia unit 10 (2.6%), onchology+hematology unit 80 (38.4%), other units 38 (9.7%). The rest 497 hospitalization was made from out patient clinic and home care services. 209 patient was consulted; internal medicine 91 (43.5%), hemodialysis unit 80 (38.4%), anaesthesia unit 12 (5.7%), orthopedia 8 (3.8%), coronary intensive care unit 6 (2.9%), other units 12 (5.7%). 50 patients has died in the P.C.unit.

RESULTS: Most of the P.C. Unit patients were female, most of the patients were diagnosed as morbid obese, onchological and cerebro-vascular diseases.

Keywords: Family medicine, palliative, analysis.

Palliative care



Palliative care-2



P-0796

A multi-disciplinary approach to a palliative care patient

Yusuf Adnan Güçlü¹, Yasemin Kılıç Öztürk¹, Kurtuluş Öngel²

¹Tepecik Training and Research Hospital, Department of Family Medicine, İzmir, Turkey

²İzmir Katip Çelebi University, Faculty of Medicine, Department of Family Medicine, İzmir, Turkey

AIM: Palliative care approach to a bedridden female patient with electrolyte imbalance due to impaired renal function and both lower limb circulatory disorders is presented.

CASE: A 48 old female patient suffering weakness and lack of oral intake was hospitalised because of wounds on feet and ion imbalance due to pre-renal acute renal failure. She had a past history of post-viral infection related childhood blindness, hypertension and spasticity with joint deformities. She became bedridden 3.5 years ago because of rheumatoid arthritis. On physical examination, cooperation and orientation was intact, she had pain; also cachectic appearance, scoliosis, spasticity of all extremities and multiple joint deformities, atrophied limbs, complete loss of vision in both eyes and severe infected wounds at the lower extremities. Patient was consulted with dietician, physiotherapists, social service, internal medicine, cardiology, cardiovascular surgery, orthopedics, infectious disease, plastic surgery. Hydration, parenteral nutrition support, wound care and physiotherapy was planned. During the daily follow-ups with blood tests renal functions got better and hyponatremia and hyperkalemia were treated. Ampicillin sulbactam three times a day were prescribed for the infected wounds. She had a deficit of 3000 ml during the intake output follow-ups. Biochemical findings and blood count were normal. Urinary wbc: +++, Erit: +. Blood hormonal levels were at normal range. GR - bacillus produced at tissue and wound culture. Brain CT was suspicious about meningioma or subdural hematoma. Appropriate antibiotic therapy was continued. After the patient's fluid deficit has been corrected, oral nutrition was provided and the patient was externed according to her request.

CONCLUSION: In this case, interdisciplinary approach; one of the most important features of palliative care was used during the evaluation and management of the bedridden patient with severe problems.

Keywords: multi-disciplinary, palliative, family medicine

Palliative



Palliative-1



Palliative-2



P-0797

Approach to a Brugada, Wolf Parkinson White Syndrome Morbid Obesity Patient in a Palliative Care Unit

Yusuf Adnan Güçlü¹, Balcı Umut Gök¹, Yasemin Kılıç Öztürk¹, Kurtuluş Öngel²

¹Tepecik Training and Research Hospital, Department of Family Medicine, İzmir, Turkey

²İzmir Katip Çelebi University, Faculty of Medicine, Department of Family Medicine, İzmir, Turkey

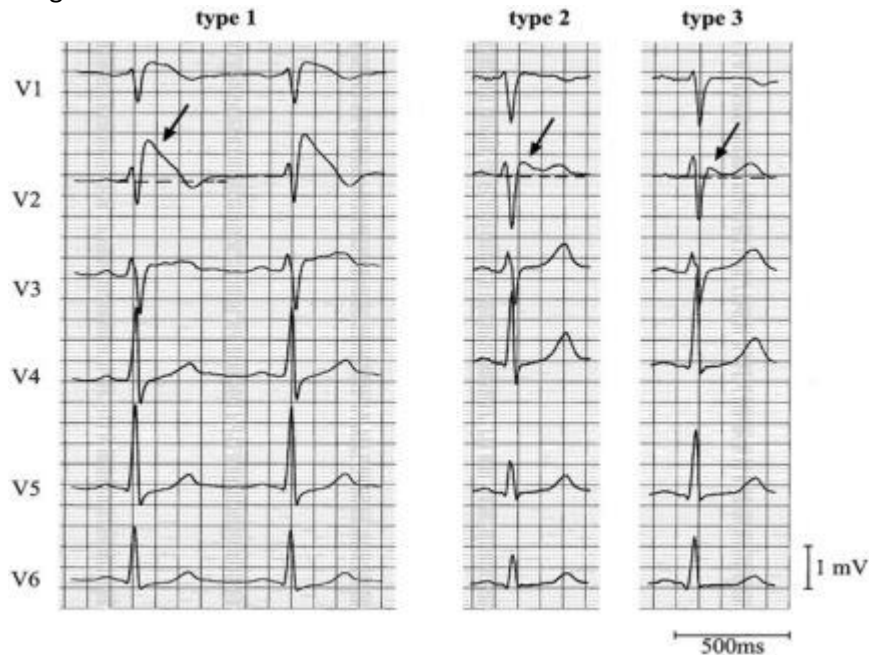
AIM: The main features of the Brugada syndrome are arrhythmias, palpitations, fainting and sudden death. Brugada syndrome must be considered if there is ECG changes from type 2-3 to type-1 for ajmaline test. In this case; it was aimed to present the approaches to a morbid obese young female patient with cardiac arrhythmia. CASE: Previously overweight patient, had previously been referred to a dietician and has lost weight for many times. She gained almost 40 kg. within 3-4 years. In November 2014; she had an operation due to Wolf-Parkinson-White (WPW) syndrome. She was admitted to obesity inpatient service for weight loss. She had ankylosing spondylitis, WPW syndrome, brugada syndrome, with a smoking history. Her father dead from lung cancer. In physical examination; both hemithorax were attending respiration equally. There were no crackles or rhonchi, no additional sound heart, murmur, abdominal comfortable, tenderness, rebound and no defense. Peripheral pulses were open. Patient were followed in the clinic. Routine blood tests were; all normal. She had ECHO and ablation with electrophysiological studies seven months ago. Preexcitation not occurred again. Ajmal patient's test was positively identified as a result of Brugada. Patient and her family were informed about the situation; she was

discharged. Patient had a medical board report with the diagnose of supraventricular tachycardia, WPW syndrome and ventricular laid Brugada syndrome that does not interfere with work. According to the list of prohibited drugs in appropriate patients that insulin resistance, metformin 1000 mg 2x1 was started. Diet and an exercise program has been edited slightly.

RESULT: A multidisciplinary approach has been followed for this morbidly obese patient with Brugada and WPW syndrome.

Keywords: Family medicine, brugada, morbid obese

brugada



P-0798

case of guillain-barré syndrome with morbid obesity

Berna Erdoğan Mergen¹, Hande Ileri², Haluk Mergen²

¹Karabağlar Community Health Center

²Izmir Tepecik Training & Research Hospital

INTRODUCTION: Guillain-Barré Syndrome (GBS) is an acute, severe and fulminant polyradiculoneuropathy in autoimmune nature. Incidence is about 1-4 cases per 100000. An ascending paralysis starting from legs, weakness evolves over hours to few days. Low cranial nerves are affected also requiring airway maintenance. In 70% of cases, a prior infectious process 1-3 week ago with Campylobacter jejuni, HSV, CMV, Epstein-Barr virus and Mycoplasma pneumoniae.

CASE: Patient whom estimated weight was 250kg has and body mass index 53, has been admitted to hospital with weakness at legs, ataxia and fall with vomiting, nausea, diarrhea and lassitude four month ago. Preliminary, the patient has been taken in the Neurology Intensive Care Unit. IVIG is implemented 5 days to quadriparetic patient. By the way, pressure ulcer occurred in the back of patient. Paresis is relieved in the following days and second cure of IVIG is not thought. Quadriparetic relieved to 3/5 in upper extremities and 2/5 in lower extremities. After, the patient is referred to our palliative clinic for physical therapy and pressure ulcer therapy. Laboratory results were as well: WBC:8500/L, Hb:11.8 g/dl, PLT:247000/L, glucose: 123 mg/dl, creatinin:0.7mg/dl, uric acid:7.4mg/dl, total cholesterol: 149mg/dl, triglyceride: 83 mg/dl, HDL:44mg/dl, LDL:88mg/dl, AST:33U/L, ALT:23U/L, ALP:52U/L, GGT:13U/L, LDH:306U/L, albumin:2.9g/dl, globulin:4g/dl, Na:134mmol/l, K:3.77mmol/l. Daily wound dressings applied and metformin 1000gr is started twice and IV furosemide therapy daily. Ciprofloxacin is started twice daily because the results of urinary test. In the 13rd day, cellulitis has begun in the

right leg. Oral antibiotherapy applied. After pressure ulcer is relieved, we thought to discharge the patient but her paresis was yet 2/5 in lower extremities.

CONCLUSION: Guillain-Barré is a rare syndrome but our case had also morbid obesity. Her weight couldn't be measured because she could not stand up.

Keywords: guillain-barré, morbid obesity, paresis

P-0799

Home care patients: Suitable household living condition requirements

Gizem Limnili, Ülkü Bulut, Ceren Kenesarı, Nilgün Özçakar
dokuz eylül üniversitesi tıp fakültesi aile hekimliği ad

Background & AIM:

Home care service aims to increase the life quality of the patient who is recovering after a hospital or facility stay, or need additional support to remain safely at home and avoid unnecessary hospitalization and providing them living independently in their social environments and at their homes. Families and society play a key role in the security, care, support and treatment of the patients who need home care. Also home environment is important for these patients. The aim of this study is to determine home environment needs of patients who need home care.

METHOD:

This is a cross sectional study including home care patients who had been visited and examined by Dokuz Eylül University Medical Faculty, Department of Family Medicine. All patients were asked about their demographic data, their house and building was examined for proper use of the patient. Descriptive analysis, mean, median, standard derivation, chi-square is used for data evaluation. $p < 0.05$ was considered statistically significant.

RESULTS:

Totally 51 patients were included the study during home care visiting. Mean age was 66.78 ± 21.86 and 58.8% was female. 13.3% were living alone, 33.3% was married. 33.3% were could not read or write. 74.5% were using health devices; most used device was a crutch. The need of new devices was 35.3%. The 31.4% of the houses were not proper for use of wheelchair or walker. The most of the stairs of the building were not proper for patients to use also there was no elevator. Fortunately 52.9% was living on the first floor.

CONCLUSION:

The importance of home care is rising in last years. Home care patients need support to have high quality of life. They need medical and daily care but also more convenient house and buildings.

Keywords: home care, elderly, family medicine

Table 1. Household conditions and health devices of the patients

	N(%)
Health devices	
Crutch	9(17.6)
Air bed	7(13.7)
Walker	6(11.8)
Wheel chair	4(7.8)
Denture	2(3.9)
Other	10(19.6)

None	13(25.5)
Household conditions	
Has a handrail in building stairs?	
Yes	20(39.2)
No	31(60.8)
Has an elevator in the building?	
Yes	14(27.5)
No	37(72.5)
Are stairs proper for stretcher?	
Yes	25(49.0)
No	26(51.0)
Is the door suitable for the patient to use?	
Yes	37(72.5)
No	14(27.5)
Are rooms spacious for the patient?	
Yes	45(88.2)
No	6(11.8)
Are rooms suitable for using health devices?	
Yes	35(68.6)
No	16(31.4)

P-0800

Understanding the experiences and quality of life issues of women with breast cancer

Ghufran Jassim

Family and Community Medicine, Royal College of Surgeons in Ireland- Bahrain, Bahrain

Palliative care is in its early stage of evolution in the Middle East and North Africa (MENA) region, and its practice encounters many challenges and barriers. Adaptation of guidelines should take into consideration the situation and unique needs in the targeted region to improve the standard of care to an internationally acceptable level. Most countries in the region are classified as category 2 in palliative care development which means that they have begun implementing various palliative care capacity-building activities but have no formal services. I have conducted a qualitative research to explore and understand the experiences and quality of life issues of women with breast cancer particularly those with a more cultural and religious basis. This is important to healthcare professionals in ensuring an individualised and sensitive approach to women with breast cancer. The results might also be applicable to migrant women who share the same cultural and religious backgrounds.

Keywords: Quality of life, Breast cancer, women

P-0801

Prevalence of Urinary Tract Infections and Related Factors in Patients who Registered Home Health Care Unit

Rabia Dane Kocasaraç¹, Elif Erdoğan Cenik¹, Mahcube Çubukçu², Mustafa Kürşat Şahin³, Şükriye Bayrak Özdin¹

¹Department of Family Medicine, Faculty of Medicine, Ondokuz Mayıs University, Samsun, Turkey

²Department of Family Medicine, Samsun Education and Research Hospital, Samsun, Turkey

³Canik Community Health Center, Samsun, Turkey

AIM: Home Health Care Unit a unit provides health services for elderly, bedridden and individuals with chronic diseases at home along within the frame of the diagnosis, and treatments of the relevant experts. Therefore, it is intended to reduce the probable physical and emotional burden related to the patient that arise by commuting to the hospital, to improve the living standard by reducing the risk of hospital infection. In this study, we investigated urinary tract infection frequency and related factors in patients who get medical support in home health care unit.

METHODS: The following study was performed on 70 patients who admitted to Samsun Education and Research Hospital Home Health Care Unit 1 to 28 February 2014. In the analysis, frequency and percentage from descriptive criteria were used.

RESULTS: There were 46 (66%) female and 24 (34%) male patients. Patients average age was 68 (range: 14-80). Three of the five patients were bedridden. The most common disease was Alzheimer (n=18,% 25,7). The other diagnosis were cerebrovascular disease, hypertension, diabetes. Fourty two patients used diaper, three patient used foley catheter, six patient used condom catheter. Urinary tract infection was detected in 12 patients. Urinary tract infection frequency was 34%. The most frequent pathogens were E. Coli (52%) in urinary culture. We were ordered a prescription to patient who had pathogens in urinary culture. Older than 50 age, women, foley or condom catheter and immobilization was detected to urinary tract infections related factors.

CONCLUSION: In recent years home health care units became even more important after the gradual increase in the elderly population and chronic disease. Urinary tract infections were common in bedridden patients.

Providers should gave education about hygien to patients and their relatives. Urinary tract infection increased mortality in bedridden patient, so infection must be treated.

Keywords: home care, urinary infection, chronic disease

P-0802

Homeless Patient with the Diagnosis of Scalded Skin Syndrome, Acute Renal Failure and Cardiac Failure- Case Report

Yusuf Adnan Güçlü¹, Kurtuluş Öngel²

¹İzmir Tepecik Education and Research Hospital

²İzmir Katip Celebi University; Faculty of Medicine, Department of Family Medicine

INTRODUCTION:

Staphylococcal scalded skin syndrome is an infectious disease which may develop due to a bacterial toxin. Fluid loss that occurs with the explosion of these blisters may cause to the corruption of the patient's blood chemistry and dehydration. The infection may be disseminated and cause a life threatening situation(sepsis) even during an effective treatment. It is aimed to highlight the approach to such a patient in this case report.

CASE:

A 72-year-old homeless male patient who had a diffuse pruritus and was treated with the diagnosis of ARF(acute renal failure) and HF (heart failure) at the palliative care service.

He was cooperated and the general state was medium. Widespread desquamation, scars and lesions due to pruritus were present on the body and face.

Laboratory findings were wbc:25000; crp:274,2; Urea:143; cre:1,6; alt:73; Procalcitonin:3.7.

Gram – bacillus at urine culture and gram+ coccus at blood culture were found.

With the diagnosis of scabies and xerosis permethrin treatment was used. Skin lesions disappeared after the treatment. More after bulleus lesions occurred during the follow-up and diagnosed as staphylococcal scalded skin. Ampicillin+ sulbactam treatment was given.

Supraventricular tachycardia occurred and Digoxin, Spironolactone, beta blocker treatment were started according to the cardiologic consultation. Skin lesions aggravated during the follow up and hypotension, dyspnea occurred and so he was transferred to intensive care unit. Respiratory arrest occurred during the intensive service follow ups and he became excitus.

CONCLUSION:

Homeless patients who are in need of care constitute a major problem at inpatient clinics because of the lack of caregivers. Despite the positive studies done for such conditions in our country there are still shortcomings about institutional care of homeless patients.

Keywords: Scalded Skin Syndrome, palliative, homeless.

Scalded Skin Syndrome



P-0803

Prevalence of the patterns of alcohol consumption in the spanish primary care

Victor Lopez Marina¹, David Rodriguez Vargas¹, Gregorio Pizarro Romero², Mireia Valle Calvet², Nuria Montella Jordana³, Rosa Alcolea Garcia⁴, Teresa Rama Martinez⁵

¹Primary Care Center of Piera. Catalanian Health Institute. Barcelona. Spain

²Primary Care Center of Badalona 6-Llefià. Catalanian Health Institute. Barcelona. Spain

³Teaching Unit of Family Medicine North Metropolitan. Catalanian Health Institute. Barcelona. Spain

⁴Primary Care Center of Besos. Catalanian Health Institute. Barcelona. Spain

⁵Primary Care Center of Masnou-Alella. Catalanian Health Institute. Barcelona. Spain

- **BACKGROUND AND AIMS:** Alcohol is the second cause of disability in the European Union countries behind the tobacco, assuming the 15-20% of the consultations performed in primary care. Given the scale of the problem, especially in men, we design this study to analyze the prevalence of the different patterns of alcohol consumption in men in the spanish primary care.

- **METHODS:** Design: a descriptive transversal multicenter study. Emplacement: 4 primary care centers. Subjects: 493 men > 17 years old, systematically selected during the recruitment period. Variables and **METHODOLOGY:** age, alcohol consumption in weekly units (standard unit drink [SUD]) and classification (abstinence, moderate and risk drinking). If risk drinking (≥ 28 SUD/week, ≥ 6 SUD/drinking opportunity), the AUDIT test is passed: if > 8 is classified as harmful use and/or dependence, and is passed the MALT-S test and ICD-10 scale (is diagnosed dependence if > 3 and > 2 , respectively). Statistics: mean (X), standard deviation (SD), percentages, CI [95%], Kappa index.

- **RESULTS:** Age (X \pm SD)=55.4 \pm 17.2 years old, 66.7% of the patients consume alcohol (average consumption of 16 \pm 12.5 SUD/week) and 17.8% are risk drinkers (CI [95%]=14.5-21.2%). 10.3% (CI [95%]=7.6-13%) have AUDIT > 8 , 9.3% (CI [95%]=6.8-11.9%) have MALT-S > 3 , 7.1% (CI [95%]=5-9.3%) have ICD-10 > 2 (figure 1). Of the risk drinkers, 66.2% (CI [95%]=56-77%) have AUDIT > 8 , of which 88.5% (CI [95%]=79.8-97.1%) are dependent by MALT-S and 67.3% (CI [95%]=54.5-80%) by ICD-10. Kappa index between MALT-S and ICD-10 is 0.423 (moderate concordance).

- **CONCLUSIONS:** Prevalence of the patterns of alcohol consumption obtained is consistent with other studies.

Moderate concordance between MALT-S and ICD-10 to diagnose alcohol dependence for overdiagnosis of MALT-S.

Keywords: Prevalence, alcohol, primary care

Figure 1

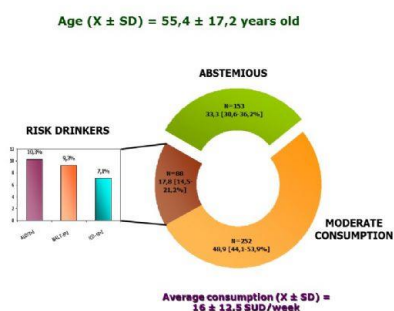


Figure 2

Classification of the risk drinkers by the AUDIT test	
Without problems (< 9)	Harmful use and / or dependence (> 8)
33,8% [23,2 – 44,5%]	66,2% [56 – 77%]

Concordance between MALT-S test and ICD-10 scale	MALT-S test	
	Harmful use (< 4)	Dependence (> 3)
Kappa index 0,423 [0,39-0,46] Moderate concordance	11,5% [5,1 – 17,9%]	88,5% [79,8 – 97,1%]
	ICD-10 scale	
	Harmful use (< 3)	Dependence (> 2)
	32,7% [24,5 – 41%]	67,3% [54,5 – 80%]

P-0804

Missed Opportunities: Intimate Partner Violence Among Men and Women in a Primary Care Center

Yesim Incecik¹, Hatice Kurdak², Nafiz Bozdemir²

¹Başkent University, Department Of Family Medicine, Seyhan / Adana

²Department of Family Medicine, Cukurova University, Adana, Turkey

BACKGROUND & AIM: Intimate partner violence (IPV) is experienced by both genders in different frequencies and varieties. However, there are some barriers in verbalizing and recognizing it. For people experiencing IPV, health care visits represent valuable opportunities. This study aims to determine the effect of screening to identify IPV among men and women in a primary care practice.

METHODS: The study was conducted in two arms. In the prospective arm, 113 people were included who applied to outpatient clinic of Cukurova University during one month. Sociodemographic information was collected and IPV screening questionnaire was administered. The questionnaire was created to identify the perpetrators and the victims, using the RADAR-SA and the Abuse-Assessment-Screen by the researchers. Surveys were conducted face-to-face and confidentially during the patients' waiting time. In the retrospective arm, 109 medical files of the previous month that were compatible with the inclusion criteria were searched for IPV diagnosis.

RESULTS: Of the enrolled, 70,8% were women. The women's mean age was 43,8±13,0 and men's was 48,0±15,8. All the male participants and 26,2% of the women had their own income. Of the women 30,0% and of the men 45,5% had at least college education. The most prevalent IPV was emotional-IPV in women and men (50,0%, 24,2% respectively). The detailed information regarding the percentages of the participants' answers to the questions are given in table 1. Of the searched medical files 51,4% were women's and rate of IPV diagnosis was

8,9% among them. There was no IPV diagnosis in the men's medical files.

CONCLUSIONS: The found IPV rates among men and women were remarkably high, however; when IPV is not screened there may be quite a number of missed opportunities of diagnosis. Moreover screening IPV in both genders and perspectives may help to identify the multifaceted IPV in primary care.

Keywords: Intimate partner violence, screening, men, women

Table 1. Participants' "Yes" Answer Rates to The Screening Questions (N=80 for Women and N=33 for Men)

The screening questions	Women n (%)	Men n (%)	p
Have you ever been emotionally or physically abused by your partner? / Has your partner ever pushed, grabbed, slapped, choked or hit you or threatened to do so?	39 (48.8)	8 (24.2)	0.016
Have you ever done that to her/him?	19 (23.7)	5 (15.2)	0.310
Within the last year, have you been hit, slapped, kicked or otherwise physically hurt by your partner?*†	7 (10.1)	1 (3.2)	0.280
Within the last year, have you done that to her/him? *†	1 (1.4)	4 (12.9)	0.008
Has your partner stopped you from going places or seeing people? / Does your partner put you down or make you feel bad about yourself?	40 (50.0)	8 (24.2)	0.012
Have you done that to her/him? Do you do that to her/him?	9 (11.3)	10 (30.3)	0.014
Does your partner prevent you from finding employment? / Does your partner maintain total control over your financial resources?	29 (36.3)	1 (3.0)	0.0001
Do you do that to her/him? *	0	8 (24.2)	0.0001
Has your partner ever forced you to have sex or perform sexual acts, which you did not want to do?	22 (27.5)	1 (3.0)	0.003
Have you done that to her/him? *	0	5 (15.2)	0.002
Are you afraid of your partner?	26 (32.5)	0	0.0001
Is he/she afraid of you?*	4 (5.0)	7 (21.2)	0.014

/ either, or *Fisher's Exact Test †women's n=69, men's n=31

Domestic Violence in Primary Care: what to expect

Sara Rigon¹, Sara Belinchon², Nina Monteiro³, Yusianmar Mariani⁴, Rosa Avino⁵, Elena Kuslova⁶, Elena Conde Valvis Fraga⁷

¹GP specialist, Bologna Italy

²GP specialist, Madrid, Spain

³GP Trainee, USF Porto Centro, Porto, Portugal

⁴GP trainee, Lethe's Health Center Unit in Ponte de Lima

⁵GP specialist, Venice Italy

⁶GP specialist, Ireland

⁷GP trainee, Madrid Spain

Background & AIM: Domestic violence is a global issue and can affect anyone or any household as it is not limited to any gender, religious, cultural or income group. Health care providers are well placed to engage in identification, support and referral of victims of domestic violence, especially GPs/FDs who are the first line of care and have a distinctive relationship with patients and families.

This poster aims to provide primary care professionals with essential knowledge on domestic violence to help colleagues identify symptoms and signs as well as support victims of such a peculiar form of violence.

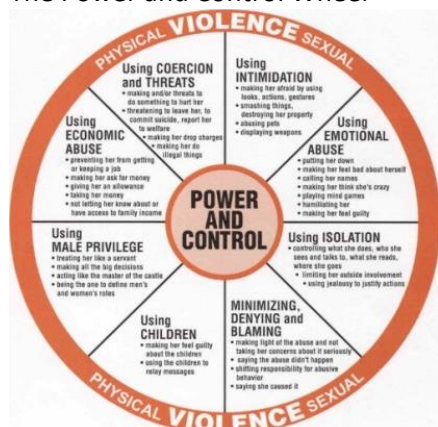
METHOD: through a review of most recent literature and guidelines on domestic violence this poster will display an overview of this epidemic phenomenon and its main unique features: circle of violence, use and abuse of power within personal relationships, isolation and acceptance of abuse, possible physical and emotional presentations and consequences on children.

CONCLUSION: education of GPs/FDs as well as, other professional health providers on this specific form of violence is the first step to an effective management and prevention of domestic violence.

RESULTS: this poster should arise awareness and inform colleagues on domestic violence. Most important, it should offer a evidence based overview as well as recommendations to assist colleagues willing to help potential victims.

Keywords: domestic violence, primary care health physicians, screening

The Power and Control Wheel



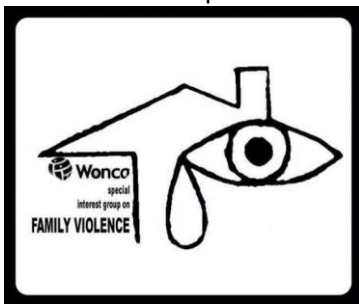
From: Domestic Abuse Intervention Programs (DAIP)

The Cycle of Violence



the level of violence usually increases at each cycle while every phase gets shorter

WONCA-VdGM special interest group on gender and domestic violence



P-0806

Prevalence of the treatment of alcohol and other drugs users classified as moderate and severe by SAMU/DF

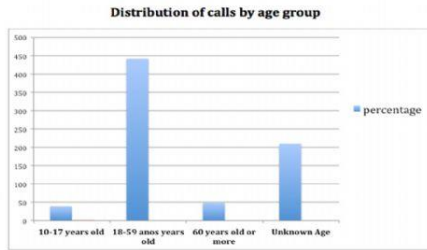
Ubirajara José Picanço De Miranda Junior, Isaac Sanglard Borel Ferraz, Ana Luiza Ataíde Moraes, Bruno De Souza Faria, Maria Cecília Dias Trindade

Escola Superior de Ciências da Saúde - ESCS - Federal District - Brazil

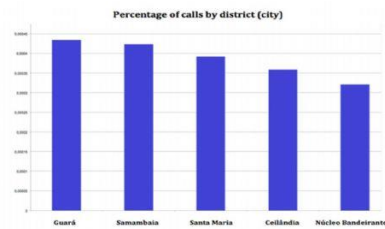
Background and AIM: the Federal District Mobile Answering Urgency Service (SAMU/DF) treats the population in urgent situations according the doctrinal principles of Brazilian health system (SUS): universality, equity, integrality. In this project the focus was the treatment of alcohol and other drugs (AD) users by SAMU-DF, emphasizing the principal demanded complaint and your classification. The project was executed by 4th grade students of medicine course from Escola Superior de Ciências da Saúde (ESCS) of Federal District-Brazil. The objective of this study is analyze the prevalence of treatment of alcohol and other drugs classified as moderate and severe by the central regulation of SAMU/DF. METHODS: exploratory study, executed from secondary data bank from SAMU/DF, covering 26.004 solicitation of medical care during the month of December 2013. 3% of those phone calls requested by alcohol and other drugs users was classified as moderate and severe by the regulator physician from SAMU/DF, corresponding to 740 phone calls. RESULTS: the highest demand of medical care was observed in male group between 18 and 59 years old, corresponding to 74,43%. From that, 79,45% was classified as moderate and 20,55% as severe. Abuse and intoxication by alcohol was the major diagnosis indicated by the medical relation, followed by abuse of other drugs, alcoholic coma and unconsciousness. The locations that realize the highest number of phone calls was in the southwest region of Federal District. CONCLUSION: the prevalence founded in this study was related mostly by intoxication and abusive use of alcohol and other drugs, alcoholic coma, convulsion and unconsciousness. Was not possible connect those diagnosis with traffic accident attended by SAMU/DF. New studies are needed to research the interconnection of alcohol and other drugs use with accidents and external morbidity causes.

Keywords: SAMU/DF; drug addiction; medical regulation

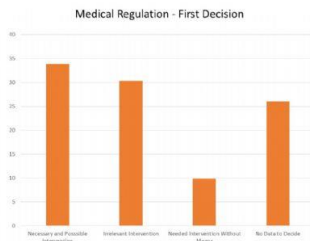
Calls by age group



Calls by district



Medical Decision



P-0807

elevated liver enzymes adherence to use of herbal drug in type 2 diabetes mellitus patient

Emrah Boyacıoğlu¹, Aydoğan Aydoğdu², Ümit Aydoğan¹, Oktay Sarı¹

¹Department of Family Medicine, Gulhane Military Medical Faculty, Ankara, Turkey

²Department of Endocrinology, Gulhane Military Medical Faculty, Ankara, Turkey

INTRODUCTION

Individuals with type2 diabetes (DM) have a higher incidence of liver function test (LFT) abnormalities than individuals who do not have diabetes. The most common abnormality is elevated alanine aminotransferase(ALT). Any diabetic patient found to have a mild chronic elevation of ALT, or elevation of ALT ≤ 250 U/L for >6 months should have screening for treatable causes of chronic liver disease, particularly hepatitis B-C and hemochromatosis, which are found with increased incidence in DM.

Some herbs are considered to be toxic to the liver. Women seem to metabolize certain toxins more slowly than men do, so their livers are exposed to higher blood concentrations of harmful substances. As you age, your liver breaks down harmful substances more slowly.

CASE

No active complaints and follow-up of 3 years, 78 year-old woman with DM was in use of oral antidiabetic. In the outpatient clinic examination elevated LFT and hyperglycemia (Table 1) were determined. The patient was

hospitalized for further examination and treatment of glycemia regulation. Acidosis was not determined. In the urine, ketones were not detected. Intensive insulin treatment was started for blood glucose control. Medical history: She had hypertension and DM. She was taking olmesartan+hydrochlorothiazide, carvedilol and metformin(1g/day). It was learned that patient was taking herbals for 2 weeks for the treatment of DM. Retinopathy and microalbuminuria weren't detected. Left-ventricular ejection fraction was found 60% after echocardiography. Abdominal ultrasonography revealed no abnormality except grade1 hepatosteatosis. After excluding other reasons lead to elevated LFT the conclusion that the herbal drug used the patient elevated LFT.

CONCLUSION

The fact that herbs are natural preparations from plants doesn't necessarily mean they are safe. It has been documented for centuries that some plant substances are toxic to the liver. For this reason while taking the medical history herbal drug usage must be questioned.

Keywords: herbal drug, elevated liver enzymes, type2 diabetes mellitus

Table 1

Parameters	Control Days									
	Day 1	Day 4	Day 6	Day 8	Day 13	Day 14	Day 18	Day 19	Day 20	Day 47 CONTROL
Glucose	455			76	129					88
HbA1C	12.1									6.5
ALT	350	321	355	459	587	590	614	561	461	17
AST	343	332	357	527	551	547	595	500	404	22
ALP	174	146			189	184	206	210	175	
GGT	100	94	96	103		131	146	156	129	
Dir. Bil.	0.47			0.51	0.47	0.50	0.49			
Tot. Bil.	1.65			1.56	1.50	1.60	1.56			
Urea	49	103		87	79					41
Creatinine	0.74			0.84	1.02					0.68
Uric Acid	4.49			8.26						
Sodium	134	135		139	136					140.1
Potassium	4.02	4.56		4.51	4.54					4.31
Total Protein	7.42				7.48					
Albumin	3.72	3.35		3.23	3.37		3.46			
LDH	266									
HsCRP	13.75									
LDL	57	411								114
HDL	43									62
Triglyceride	134									122
ft4	1.45									
TSH	0.96		1.08							
Vit B ₁₂	849									437
Amylase			86		93					
UIAC			218							
INR					1.0					

biochemistry

Table 2

TESTS	RESULTS
HBsAg	-
Anti Hbc IgG	+
Anti HCV	-
Anti HIV	-
Antids DNA	-
Anti mitokondriyal antikor (AMA)	-
Anti nükleer antikor (ANA)	-
Antisentromer (IFA)	-
Anti CMV IgM	-
Herpes Simplex tip1 IgM	-
Anti HAV Igm	-

autoimmune and infectious parameters

Table 3

TESTS	RESULTS	UNIT	REFERENCES
Albumin	45,2	%	54,6-66
Alfa-1	3,0	%	1,4-2,8
Gama	24,9	%	10,6-19,2
Beta	13,9	%	8,7-14,4
Alfa-2	13,0	%	9,1-13,8

protein electrophoresis

P-0808

Domestic violence among women and girls in Munshaat Sultan, Egypt

Hala Mohamed Elmoselhi Shaheen, [Nagwa Nashat Hegazy](#)

Department of family medicine; Faculty of medicine, Menofia university

BACKGROUND: Violence against women and girls is one of the most systemic and widespread violations of human rights worldwide. One-third of Egyptian women have been physically abused by their husbands/ father, according to EDHS 2005. Nearly 39% of women and girls think that a husband and father is justified in hitting or beating his wife/ daughter under certain circumstances

OBJECTIVES: The main objective of this study was to assess the different types of violence, explore the reasons behind this high percent of violence in Egypt and the roots of silence toward reporting.

METHODS: Females were recruited from the family health center clinic, Munshatt sultan village, using a convenient sampling technique. Qualitative approach was used to gain an in-depth knowledge of the issues. Two types of focused groups were organized, one for married women and the other for young girls. All interviews were facilitated by moderator and an observer, and followed a pre-tested questioning route. They were audio-taped, transcribed verbatim, and were then analyzed for thematic contents by the standard content analysis framework. Thematic content analysis

RESULTS: Two major themes were identified regarding the type of violence: physical and emotional violence. Difficulties in reporting for violence were different according to the age group where married women reasons were grouped in three main categories: cultural, personal and the presence of children. On the other hand girl's explanations were grouped into two main themes; financial and fear.

CONCLUSION: A major part of the domestic violence is related to the community where the thoughts of female inequity are still prevailing

Keywords: Domestic violence, Emotional abuse, inequity

P-0809

Misconceptions of family doctors and family about the profile of addicts: case study

Marijana Aleksandar Pesic, Estera Dusan Vidakovic
Institute for Students Health, Belgrade, Serbia

BACKGROUND:

Evidence-based and on the basis of the traditional understanding of the addicts are characterized as people of lower socioeconomic and educational status.

AIM:

Demonstrate through two case profiles addicts who deviate from the expected, the importance of improving the skills of recognition addicts and their needs, in order to provide care, treatment and secondary prevention.

METHOD: Case study

RESULTS:

CASE 1: Female patient J.P., 23 year old, came to be referred for therapy for a HCV infection, a doctor wasn't her chosen. In order to build patient's trust the doctor had mentioned that the usual way of transmitting the HCV is injecting drugs, but even doctors have prejudices. The Patient's story: excellent student of mathematics, functional family. She had used drugs with her boyfriend in her room while studying. Her mother didn't disturb the children while they were studying. Happy, because they're at home. One day, J.P. decided to treat. Neither the parents nor the doctors have not thought that there is a problem with excellent student.

CASE 2: Male patient J.Dj., 20 years old, accompanied by his mother, comes by referral to the Institute of Mental Health, to a specialist who deals with pathological gambling. He had recognized the problem himself and decided to treat. Mother stated that no one doubted, because he is an excellent student. Finances were not an issue as he is a student of IT and he used his knowledge and skills to win.

CONCLUSIONS:

Addictions are becoming increasingly important public health problem. Raises the question of prevention, early detection (recognition), care, treatment and secondary prevention. It is necessary to improve the skills of listening and research needs of patients by family doctors.

Keywords: Addict, excellent student, family doctors, HCV, gambling, recognition

Family



friendly doctor



gambling



parents



question



Results



Results



P-0810

Bronchial asthma and a strong need for family psychoeducation in family medicine

Maija Kozlovskā¹, Liga Kozlovskā¹, Sandra Gintere², Sandra Puce², Gunta Ticmane¹, Ruta Vintere²

¹The Rural Family Doctors' Association of Latvia

²The Riga Stradin's University

Introduction. A connection between asthma and emotional factors is determined. [Maimonides 1990, Alexander 1940, Dunbar 1948] The transformation of these people's lives involves their families. (Scott et al., 2007; Fernandes et al., 2010; Thomas et al., 2011; Di Marco et al., 2011).

Methods. The epidemiological study was made since 2014, May [ongoing] in Latvia in a family physician practice of 1400 patients, evaluating psychological aspects and need for familial psychoeducation for pediatric patients with bronchial asthma in the age of 1-18, involving data, literature analyses.

Results. The control of asthma correlates with anxiety state ($r=0.554$; $p\leq 0.001$) and trait ($r=0.357$; $p=0.000$), as well as anger ($r=0.221$; $p=0.016$). [Fernandez, 2012] Since 2014, May till, 2015 March, 75 young patients with asthma were identified, whereof 92 % percent were having familial lifestyle problems, that worsened the disease, like mold, animals, excessive air drought/humidity, allergens, and familial smoking. 88% of pediatric patients were passive smokers due to smoking of at least one of family member. Smoking mostly was outside room and correlates with asthma cases. 14% involved more than one smoker in family, aside from the pediatric patient, which correlates with the severity of child's asthma. 70% of smoking parents did not want to start hormonal treatment, and did not want to quit smoking even after an hour long explaining of the importance and meaning of asthma control.

Conclusions. There is a strong need for familial psychoeducation for pediatric patients. Attention from higher institutions must be paid to child abuse concerning passive smoking and development of such chronic condition as bronchial asthma.

Keywords: child abuse, smoking, bronchial asthma

P-0811

The angry patient: the role of mindfulness

Sara Isabel Andrade, Cristina Maria Bastos, Ana Rita Maria

Family Health Center Conde de Oeiras, Regional Health Administration of Lisbon and Tejo Value, Lisbon, Portugal

BACKGROUND:

Over the last years, several studies have examined patient aggression toward healthcare professionals including primary care physicians. Many studies reported high rates of maltreatment by patients. About 15 percent of patient-physician encounters are rated as "difficult" by the physician involved. In this context, patient characteristics, physician factors and situational issues all contribute to difficult clinical interactions.

Case description/AIM:

A 50 year-old caucasian male with no significant past medical history had a verbally aggressive behavior and physically intimidated the doctor because he refused to write a medical report. What approach would be most helpful to the patient? With this case report we want to highlight the role of mindful practice in the difficult encounter.

METHODS:

A search for articles published in the last twenty years in Cochrane Library and in Pubmed was performed using the MeSH terms "physician patient relationship", "aggression" and "mindfulness". Additional potentially relevant publications were identified by checking references of included studies.

RESULTS:

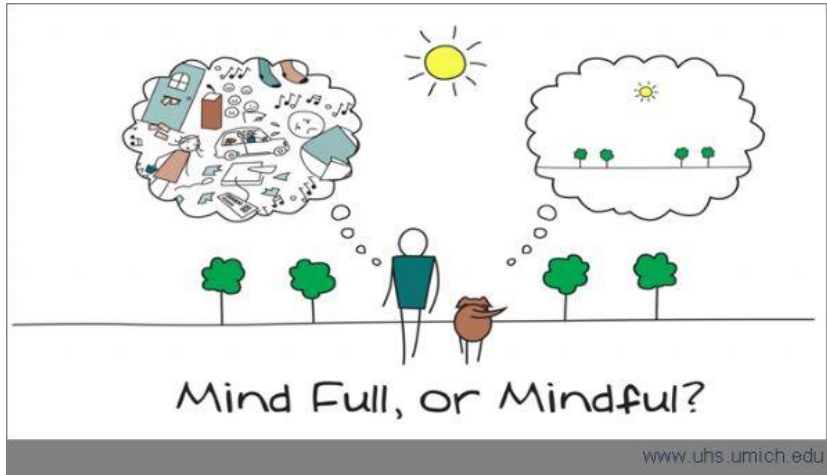
The mindful practitioner is present in everyday experience, in all of its manifestations, recognize its own errors and engage in more patient-centered communication. In addition, the mindful practice may decrease the number and intensity of difficult encounters and should be considered a characteristic of good clinical practices.

CONCLUSIONS:

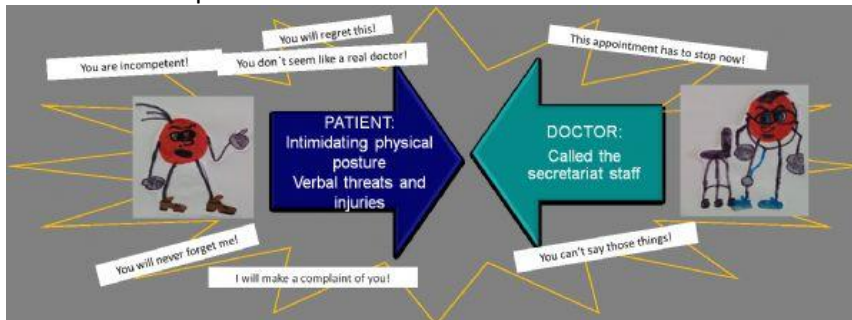
There will always be difficult relationships in the clinical practice. It's important to learn how to manage these situations so that we can turn them into productive interactions. Becoming more aware of your own physical, mental and emotional processes may contribute to a successful patient-physician relationship.

Keywords: Keywords (MeSH terms): physician patient relationship, aggression and mindfulness.

Mindfulness



Difficult doctor-patient interaction



Mindful doctor



P-0812

Evaluation of the changes in knowledge, skills, attitudes and transfer into practice after a training session on gender violence

Susana Sánchez Ramón¹, María Del Carmen Fernández Alonso², Sonia Herrero Velazquez³, Yolanda Valpuesta Martín⁴, Marta Menéndez Suárez⁸, Raquel Gómez Bravo⁶, M^a Del Mar De La Torre Carpenté⁹, M^a Del Mar González Fernández Conde⁷, Irene Repiso Gento⁵

¹Emergency Department; Río Hortega University Hospital. Valladolid. Spain

²Servicios Centrales; Gerencia Regional de Salud. Sacyl. Spain

³Neurology Department. Río Hortega University Hospital. Valladolid. Spain

⁴Peñafiel Health Center; Valladolid Spain.

⁵Valladolid Rural I Health Center; Area Este Valladolid. Spain

⁶SEMFYC. Spain

⁷Alamedilla Health Center; Salamanca. Spain

⁸Endoscopy Department. Clinical University Hospital. Valladolid. Spain

⁹Cardiology Department. Río Hortega University Hospital. Valladolid. Spain

Training in Gender Violence (GBV) is essential to raise awareness among professionals to detect and care for victims with a comprehensive approach.

OBJECTIVES:

Evaluate the changes in knowledge, skills and attitudes in health professionals who participated in a 18 hours training workshop in GV, with a previously established methodology and content. Opinion on methods, content, teaching quality and applicability to practice was evaluated.

METHODOLOGY:

Pre-workshop (online) and post-workshop questionnaire (physical) and 6 months questionnaire to assess the transfer into practice (Emailing the participants)

Study: Cross Descriptive.

Sample: 23 students attending the workshop VG

RESULTS:

60% of the 23 students were nurses and 30% physicians. 77% were professionals in training (residents). 77% were women and the age average 31.45 years. 87% hadn't received any prior course. When they were asked about the motivation to attend the course, most of them answer that they need training for the detection and management of cases. Questions on knowledge, attitudes, level of safety, resistances, perception of their role in this situation, previous experiences, were some of the dimensions explored.

The perception of safety in handling the case increased after the training activity (4.8 to 7.5)

The overall rating of the workshop has been positive, all students felt that the course has been adapted to their needs and their objectives have been achieved. They were asked to make an assessment of the different methodology and role playing method was more valued.

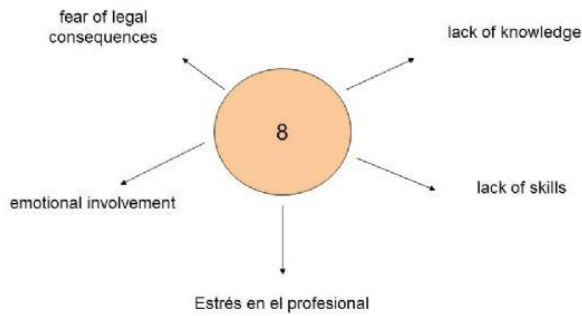
6 months after, the post-workshop survey shows that the evaluations is the same, with a slight decrease, and relate perceived usefulness and transfer into practice, where they had the opportunity.

CONCLUSIONS:

We believe that training in GV is the first step in changing attitudes and train health professionals in managing the problem. It is necessary to get motivate professionals and adapt content and methodology and assess the impact of it

Keywords: Gender Violence, knowledge; training

What aspects will generate greater difficulty boarding at VG?



Degree of safety evaluation

	INITIAL QUESTIONNAIRE	FINAL QUESTIONNAIRE	6 months
S1. Identifying risk factors	4,75	7,43	8,09
S2. Interview	4,88	7,24	6,82
S3. If I do the injury report	5,56	8,33	7,18
S4. Complete report of injuries	5,25	8,10	7,45
S5. Knowledge of resources	3,94	7,19	7,09
S6. Psychological support	4,74	7	7
S7. Coordination with other professionals	4,31	7	7
S8. Management of the aggressor if it's also their patient	3,88	6,76	5,82
S9. Assessment of life-threatening	4,75	8,14	7,55
S10. Doctor-patient relationship	5,38	8,10	7,45
AVERAGE SCORES	4,98	7,5	7,16

logos



P-0813

Reliability and Validity of The Turkish Version of "The Severity of Violence Against Women Scale"

Canan Tuz, Mehmet Ergun Öksüz

Başkent University, Family Medicine Department

Violence against women is a complex worldwide problem not only in developing countries. Information about prevalence, associated factors and consequences of violence against women in Turkey is scarce. Even if there are some questionnaires to identify the tragedy in domestic field, very little is known about the intimate partner violence at universities.

The purpose of this study is to validity and reliability of The Severity of Violence Against Women Scale (SVAW) in Turkish population. SVAW is part of Measuring Intimate Partner Violence Victimization and Perpetration which is demonstrated by Marshall LL in 1992 and is an assesment tool in Center of Diseases Control and Prevention Center(CDC).

170 female college students were included in the study in which SVAW was examined for construct validity and reliability. This study was conducted during March-April 2015 in Başkent University.

Factor analysis was performed to assess the underlying domain structure of the questionnaire and to evaluate validity, the degree to which each item is related to the hypothesized domain with which it is associated. The reliability was calculated by using Cronbach's alpha formula.

Based on clinical interpretations of a principal-components analysis, 9-domain structure was identified which included of Principle Component Analysis and Varimax rotation (Eigen Value ≥ 0.7). Scale with this nine domains expanded variance was %88.1. Item loadings were found between 0.443-0.884. The value of the scale was in level high reliability (Cronbach: 0.979). Subdomains were similar to the original survey as symbolic violence, threats of mild violence, threats of moderate violence, threats of serious violence, mild violence, minor violence, moderate violence, serious violence and sexual violence.

SVAW, a 46 item based scale, has been developed as a brief, multidimensional self-report instrument for assessing the severity of violence against women. The Turkish version of SVAW is psychometrically sound, easy to administer, reliable and valid.

Keywords: women, sexual, violence, adolescence

P-0814

Which trauma is so dangerous?

Betül Battaloğlu Inanç

Department of Family Medicine, Muğla Sıtkı Koçman University, Muğla, Turkey.

Background & AIM: In all societies and in each culture, past and present, violence has played a role in shaping our sociocultural evolution in Turkey. The analysis of the frequency of childhood traumatic events in midwifery students and the compare correlation with depression and anxiety traumatic events were aimed in this study.

METHODS: Self-report instrument was designed to evaluate abuse and neglect experiences of childhood and adolescence in the University of Mardin Artuklu Health School the Midwifery students. Childhood and adolescence lives evaluated childhood trauma questionnaire (CTQ). Depression and anxiety relates evaluated with the Beck Depression Inventory and the Beck Anxiety Inventory.

RESULTS: The students mean age were 21.4 ± 1.9 , CTQ points average was 35.8 ± 9.1 , Beck depression inventory average points was 13.7 ± 10.4 , Beck Anxiety Inventory average points was 19.8 ± 12.7 . The CTQ total points was significantly associated between depression and anxiety. ($p < 0,001$).

CONCLUSIONS: A growing body of evidence suggests that the developing brain organizes in response to the pattern, intensity and nature of sensory perceptual and affective experience of events during childhood. Threat activates the brain's stress-response neurobiology. This activation, in turn, can affect the development of the brain. Indeed, the developing brain is exquisitely sensitive to stress. These results could indicate that previously experienced emotional and physical traumas has more relationship to anxiety and depression symptoms and this pathological position which is an expected result of the trauma.

Keywords: childhood trauma, childhood Trauma Questionnaire, Beck Anxiety inventory, Beck depression inventory, midwifery students

P-0815

Sociodemographic Characteristics of Patients Applying to Alcohol and Substance Abuse Treatment and Education Center (AMATEM) in Konya

Fatma Selek Demirel¹, Başak Demirel², Fatma Goksin Cihan³, Şule Erayman Demirbaş¹, Yasemin Alagöz¹

¹Family Medicine Clinic, Konya Training and Research Hospital, Konya, Turkey

²Department of Psychiatry, Konya Training and Research Hospital, Konya, Turkey

³Department of Family Medicine, Necmettin Erbakan University, Meram Medical Faculty, Konya, Turkey

AIM: The aim of this study was to analyze the sociodemographic characteristics of the patients who had visited the Alcohol and Substance Abuse Treatment and Education Center (AMATEM) at Konya Training and Research Hospital.

METHODS: In this descriptive study, a socio-demographic data form was applied to 61 patients who had admitted to AMATEM from January 2015 to March 2015.

RESULTS: The mean age of the participants was 23.48±4.67. Of the participants, 88.5% (n: 54) were men, 23% (n:14) were married. All patients were smoking. Mean age for smoking initiation was 13.36±3.19 years old. Mean age for initiation of substance use was 16.59±4.05 years. 88,5% (n:54) participants had begun substance use in Konya city. The mostly used substance was marijuana [(55.7%) (n: 34)] and second was heroin [26.2% (n: 16)]. The rate of using multiple substances was 72.1% (n: 44). Fifty one percent of them had used their first substance when they were student (n: 31). The intravenous heroin users rate were 23% and 21.4% of them were sharing their injection equipments.

CONCLUSIONS: One fifth of patients using intravenous heroin were sharing drug injection equipments which can cause transmission of diseases like Hepatitis B and C, AIDS etc. with blood and body fluids. All of the participants were smoking. Average age for initiation of smoking was very low. Families and health care professionals should be aware of the fact that smoking leads to substance abuse. This underlines the importance of prevention of smoking as it will reduce the substance abuse also.

Keywords: substance abuse, smoking, heroin

P-0816

Aggressive patients, frequency and causes in family medicine

Amra Zalihic¹, Gordana Pivic², Mirela Mabic³, Adna Zalihic Pita⁴, Maja Pivic⁵

¹Health Care Center Mostar, Hrvatskih branitelja of A

²Health Care Center Mostar, Hrvatskih branitelja of B

³Universiti of Economy Mostar, Matice Hrvatske bb, of C

⁴Health Care Center Mostar, Hrvatskih branitelja of D

⁵Health Care Center Mostar, Hrvatskih branitelja of E

Aggressive patients are current topic in every country. Every day we have more aggressive patients in our office. The aim of our study is to examine frequency of aggress and possible causes of that.

We have divided 80 made questioners to medical workers (doctors and nurses). For analyses there were valid 73. Study is made in Health Care Center Mostar, B&H.

There were 32,9% doctors, of what 11% specialists, 6,8% primaries, 12,3% GP and 2,7 residences. Our institution is women's organization (88% women). The most were people age 25-30 and 51-55 (21,9%), and there were 27,4% workers with >25 years experiences.

78,1% participants have had any shape of aggression, in 47,4% once a month. 87,5% doctors and 73,5% nurses said that experienced aggressive attack. The most of them have experienced a quarrel (63%), insults (54,8%), threats (38,4%), physical attack (2,7%) and unjustifiably snitching (58,9%). As causes, subjects mentioned a long of waiting (80,7%), the health care system as a whole (75,4%), the amount of time devoted to patient (57,9%), the scope of rights of the insured (57,9%), dissatisfaction with the quality of medical services (43,9%) and physician relationship to the patient (35,1%).

CONCLUSION: the most participants said that aggressive patients are more often (58,9%), 32,9% think that

situation is the same, and only 8,2% think that is less than earlier. Reason for these results could be numerous number of young people who have not had the chance to experience aggression. The most participants mean that reason of aggression is length of waiting. Why? We use appointments, which patients do not respect, and on this way they make crowd and physician don't have enough time. We think that our health system must support family physicians for better satisfaction of patients and physicians what could result in the reduction of aggression.

Keywords: Aggression, patients, causes

P-0817

Exposure To Domestic Violence Among Women Aged 15 And Older

Edibe Pirincci¹, Evrim Celebi², Ayse Birsen Durmus³

¹Firat University, School of Medicine, Department of Public Health, Elazig, TURKEY

²Firat University, School of Nursing, Elazig, TURKEY

³Firat University, College of Health Services, Elazig, TURKEY

BACKGROUND & AIM: This study aims to determine exposure to domestic violence among married women at 15 years of age and older.

METHOD: This study is descriptive and cross-sectional. It was conducted in the city of Elazig with 792 married women selected from those who visited primary healthcare centers using simple random sampling. In the field work, the authors contacted 760 women. The questionnaires were filled out during interviews in their homes. To evaluate the data collected, the author used the SPSS package program for statistical analysis. In comparisons, values of $p < 0.05$ were deemed to be statistically significant.

RESULTS: The average age of the participating females is 35.72 ± 10.84 years. Of the participant females, 47.4% were exposed to violence by their husbands at least once during their marriages, 20.8% experienced violence by their husbands at least once during pregnancy, and 36.1% were exposed to violence by their husbands in the last year. Of those who are illiterate, 65.5% experience violence by their husbands, while this rate is 26.2% among university graduates ($p < 0.001$). The rate of women being exposed to violence increases in direct proportion to their age ($p < 0.001$). The rate of women subjected to violence by their husbands decreases in inverse proportion to their husbands' level of education ($p < 0.001$). The rate of domestic violence is 52.1% among housewives, while this rate is 30.2% among working women ($p < 0.001$). Of those who are 19 or younger, 56.2% are exposed to violence, while 42.5% of women above 20 years age experience violence ($p < 0.0001$). The better the economic status, the lower the violence level gets ($p < 0.001$).

CONCLUSION: Exposure to domestic violence among married women living in the city of Elazig is remarkably high. The authors believe that necessary training and service should be provided at individual, familial and social levels to solve this problem.

Keywords: domestic violence, women, husband

P-0818

Which are the methods for training in sexual and intimate partner violence that health professionals prefer?

M Carmen Fernandez Alonso¹, Sonia Herrero Velazquez², Susana Sanchez Ramón², Raquel Gomez Bravo³, Yolanda Valpuesta Martin⁴, Irene Repiso Gento⁵, Marta Menendez Suarez⁶, Mar De La Torre Carpenté²

¹Regional Health Service of Castilla and Leon. Valladolid. Spain

²University Hospital Rio Hortega. Valladolid.Spain

³Spanish Society of Family Medicine and Community, Spain.

⁴Health Center of Peñafiel. Valladolid. Spain

⁵Primary Care Management Valladolid East. Spain.

⁶Clinical University Hospital of Valladolid. Spain.

Objetives:

To know what are the best training methods valued by students attending to an 18 hours training workshop in sexual and intimate partner violence (IPV), with a previously established content and methodology, and their perceived usefulness for clinical practice.

Methodology

A post-training presence questionnaire evaluated the opinion of the participants about the teaching methods to raise awareness among professionals, to enable them to detect and improve their ability to care for victims of IPV. The methods that have been used, where the main variable is their perceived usefulness for clinical practice and the changes in knowledge and attitudes of these students before and after the course, were tested as well.

Study: Cross-Sectional Descriptive

Sample: 23 health professionals(residentsand staff) attending the workshop.

Results

23 students (77% women):60% nurses, 30% physicians. 77% learners. Average age 31,45 years. 87% hadn't received previously any course. The best valued method was role playing, representing dramatizations of actual cases in which learners acted as professionals in their consultation and the role of the patient was represented by a trained professional, using standardized patient. Others highly valued were the presentation and analysis of clinical cases, teachers' experiences and finally the theoretical presentations

Conclusions

We think that training in IPV is the first step in changing attitudes and training health professionals in handling this problem.The learners believe, that the most effective methods are those that place them facing the problem in a similar scenario that they will address in their practice. The role play let them express their feelings, develop questions and doubts in a playful and very helpful contexts that it doesn't make them feel as pressured or judged, as in others. Other highly valued were the presentation and analysis of clinical cases. This method provides practical tools with a realistic approach

Keywords: Intimate partner violence, Training methods

logo



P-0819

Beware Of Home Accidents: Knitting Needle And Power Socket

Seval Yaprak¹, Özden Gökdemir¹, Ülkü Bulut³, Damla Güneş², Nilgün Özçakar¹

¹DOKUZ EYLUL UNIVERSITY / MEDICAL FACULTY / FAMILY MEDICINE DEPARTMENT

²DOKUZ EYLUL UNIVERSITY / MEDICAL FACULTY / PEDIATRICS DEPARTMENT

³BALCOVA PUBLIC HEALTH CARE CENTER / IZMIR

Introduction and AIM: Home accidents are serious community-health problems. Children aged between 0-14 years and elderly individuals are at risk of home accidents because of spending most of the daily time at home. Accidents require expenses and good deal of medical support and community-health policy. At child-health emergency daily practice, the incidence of new diagnosed trauma is 15% per year. In epidemiological studies it's reported that protection is needed more as accident risk of new-borns and children who started walking. Deadly and severe accidents are seen in children under 15 years old. Most common four children-traumas are drowning, poisoning, burning and falling. WHO(World Health Organisation) recommends preventing organizations, education and emergency healthcare. Meta-analysis shows that face-to-face parent conversation is more advantageous and effective in parental security-application.

CASE: A year-old boy brought to Dokuz Eylül University Pediatrics Emergency Service had a trembling electric-shock for about a minute after knitting needle insertion in power socket. In physical inspection, ABP:105/65mmHg HR:110/min RR:25/min BT:36,5°C O2sat %:100 GCS:15, general condition was good and he was conscious. Skin temperature, colour, general system inspection and electrocardiography were normal and there was no pathology. There was a lesion in line with right hand dorsal surface electric inlet orifice. Forensic report has been edited. This was his second house-accident; he also had a car-accident.

Discussion and RESULT: House accidents can be prevented. Unsafe environmental conditions and behaviours are important; a safe house-environment decreases expenditures and accidents. First home-accident factor is human and conscious/unconscious family members. Education and avoiding accidental behaviours are important in community health.

In protecting health-services, cognitive and behavioural approaches also prevent accidents. Determining risks and learning measures and safe behaviour are important behavioural-approaches. An effort for medical behaviour in protecting health in medical family practices contributes to community health.

Keywords: home accidents, children, community health

P-0820

A Qualitative Inquiry on Domestic Violence of Working Children in the Industry Complex and Related Factors

Seyhan Hidiroglu¹, Melda Karavus¹, Ozlem Tanrioer², Turhan Salva³, Emel Lüleci¹, Bulent Herek⁴

¹Department of Public Health, Marmara University, Istanbul, Turkey

²Department of Family Medicine, Yeditepe University Faculty of Medicine, Istanbul, Turkey

³Department of Public Health, Maltepe University, Istanbul, Turkey

⁴Istanbul Public Health Directorate

OBJECTIVE: The aim of this study was to understand the factors related to domestic violence of the working children in the Industry Complex in a district of Istanbul.

METHODS:

This qualitative study was carried out with children working in the Industry Complex of Pendik. These children were working in this Complex under the guidance of Community for Helping the Working Children. Three focus group discussions were held to collect the data each composed of 10 children with one moderator and one reporter. The focus group discussions were held at the work places of these children and during their working hours.

RESULTS:

In our sample, all the children were males, aged between 14-18 years. The majority were the children of low income families who were not able to graduate from elementary school.

Almost all of the children admitted that they have been exposed to some kind of violence at home. The father was the main aggressor in most of the violence at home. Mothers were frequently victimized at home and the children could witness this. Children admitted that they became aggressive outside the home after they experienced violence at home. Some of the children believed that the reason for domestic violence was financial problems.

Conclusion

Although the children expect more understanding from their families as a solution; effective violence prevention programs including education of the families are needed to lower the rate of domestic violence. Immediate issues of economic survival for vulnerable families and children would also help.

Keywords: Domestic violence, working children, qualitative

P-0821

A multidisciplinary vision of training methods in family violence

M Carmen Fernandez Alonso¹, Sonia Herrero Velazquez², Susana Sanchez Ramon², Raquel Gomez Bravo³, Thomas Beck⁴, Marion Winterholler⁵, Victoria Poon⁶, Yolanda Valpuesta Martin⁷, Hilde Hellberdn⁵, Marta Menendez Suarez⁸, Katrin Wolf⁵, Simon Cordon⁶, Ulrike Smrekar⁴

¹Regional Health Service of Castilla and Leon. Valladolid. Spain

²University Hospital Rio Hortega. Valladolid.Spain

³Spanish Society of Family Medicine and Community, Spain.

⁴Univ.-Klinik für Medizinische Psychologie. Innsbruck. Austria

⁵Signal.Berlin. Germany

⁶Haven,s Center. London.U.K

⁷Health Center of Peñafiel. Valladolid. Spain

⁸Clinical University Hospital of Valladolid. Spain.

OBJECTIVES:

To know what are the best training methods valued by professionals attending training in Intimate Partner Violence (IPV), and their perceived usefulness for clinical practice.

METHODOLOGY:

A questionnaire conducted by email or telephone evaluated the opinion of the participants about the teaching methods to raise awareness among professionals, to enable them to detect and improve their ability to care for victims and their perceived usefulness for clinical practice

Study: Cross-Sectional Descriptive

Sample: 42 professionals staff (doctors, nurses, social workwes, midwives, others) trained in IPV from different countries (13 U.K, 12 Germany, 10 Spain and 7 Austria). Most were female doctors from 26 to 60 years.

RESULTS: The most useful training method was role play (18). Working in small groups for analysis and discussion of cases, (10) sessions and case presentations (8), movie debate scenes, facts and figures, documentation and materials are the most useful aspects of the formation.

Suggestions: More discussion of cases (12) and practical tools, more training and in how to seek help. Improving communication skills. Working materials. Support for the management of emotions and supervision for complex cases

CONCLUSIONS: We believe that training in IPV is the first step in changing attitudes and qualifying health professionals in handling this problem. Learners want to learn about IPV to improve their competences and assist victims better and they consider more effective those methods that place them facing it in a similar scenario, like role play, letting them express feelings, develop questions and concerns, in a playful and helpful context without feeling pressured or judged. It also facilitates learning communication skills, awareness of one's ability to cope with this problem in their practice, and same in the analysis of real cases in small group.

We believe that it is necessary to have support groups or the possibility of supervision.

Keywords: Training intimate partner violence. Methods. Skills.

LOGOS



P-0822**reliability and validity of turkish version of sexual experiences survey- victimization version**

Canan Tuz, Mehmet Ergun Öksüz

Başkent University

Intimate partner violence is a major public health problem, reflected by both its prevalence and negative consequences. This survey is an assesment tool designed to measure victimization from and perpatrator of intimate partner violence in Center of Diseases Control and Prevention Center(CDC).

The purpose of this study is to validity and reliability of Sexual Experiences Survey- Victimization Version (SES) in Turkish population. SES is part of Measuring Intimate Partner Violence Victimization and Perpetration which is demonstrated by Koss, Gidycz&Wisniewski in 1987.

170 female college students were included in the study in which SES was examined for construct validity and reliability. This study was conducted during March-April 2015 in Başkent University.

Factor analysis was performed to assess the underlying domain structure of the questionnaire and to evaluate validity,the degree to which each item is related to the hypothesized domain with which it is associated. The reliability was calculated by using Cronbach's alpha formula.

Based on clinical interpretations of a principal-components analysis,2-domain structure was identified which included of Principle Component Analysis and Varimax rotation (Eigen Value ≥ 0.7).Scale with this two domains expained variance was %68. Item loadings were found between 0.443-0.884. The value of the scale was in level high reliability (Cronbach: 0.738).

SES is an 10-item scale that measures four types of sexual victimization, instrument for assessing the severity of violence against women. The Turkish version of SES is psychometrically realiable and valid.

Keywords: women,sexual,violence,adolescence,victimization

P-0823**Health workers under threat of violence in Türkiye**

Fatih Özcan¹, Erdiñç Yavuz²

¹Kuruçeşme Family Healthcare Center, İzmit, Kocaeli, Türkiye

²1st Family Healthcare Center, Rize, Türkiye

Background& AIM: In this study, we aimed to draw attention to an important issue of our country's health care environment, verbal and physical violence against medical personnel by patients or their relatives, to examine the causes of these incidents and discuss solutions to prevent this violence.

METHOD: However, we evaluated the problem based on scarce studies performed by researchers, reports issued by Turkish Medical Association and other health professional organizations, television and newspaper interviews, articles and our own observation

RESULTS: Health media in Turkey claimed that TV series occasionally encouraged violence against healthcare personnel. Another issue we have encountered was TV-newspaper news blaming healthcare providers because of clinical complications. No actions were taken against these unfounded allegations. We also witnessed some politicians accusing doctors in front of large audiences. We observed that "113- White code" application launched to help violence victims of healtcare workers by Ministry of Health became nothing more than a free legal support. Eventually, this application did not help to prevent violence against health workers. In addition, existing legislation of the Ministry of Health does not contain any health administrative sanctions to those who use violence. A total of 23,120 cases of violence against health personnel have been reported for the last two years. The murder of two chest surgeons while working in their hospitals in the last 3 years and the murder of a medical school professor of thoracic surgery by the relatives of his patient in his university ten years ago were extremely dramatic.

CONCLUSIONS: Currently, the existence of violence against medical personnel in our country have an extremely negative impact on health workers. In fact the methods of preventing violence are well-known by both health workers and administrators. The only missing ingredient is the "will" of politicians and health managers to apply these methods.

Keywords: safety of health service environment, violence, inhibiting of violence

P-0824

Workplace Bullying - the role of family doctors

Luís Miguel Azeredo Lopes De Moura Paixão¹, Pedro Cardoso Ferreira², Ana Marta Garcia¹, Diogo Abreu¹, Maria João Trindade¹, Ângelo Costa³

¹UCSP Fernão de Magalhães, ACES Baixo Mondego, Coimbra, Portugal

²USF Dunas, ULS Matosinhos, Porto, Portugal

³USF Al-Gharb, ACES Central, Faro, Portugal

BACKGROUND & AIM:

Cases of workplace bullying are more and more frequent nowadays. In recent studies, approximately 5% of all workers have already been exposed. This exposure is linked to the development of several physical and psychological symptoms.

The aim of this review is to address the main clinical aspects of this situation and its proper orientation.

METHOD:

Bibliographic research of review articles and systematic review articles published in English, French and Portuguese, in the last 5 years, in the Medline / Pubmed database, using the MeSH term "Bullying", with the term "Workplace". 14 articles were found and 9 were selected for this review. We also selected a Portuguese PhD thesis on the subject.

RESULTS:

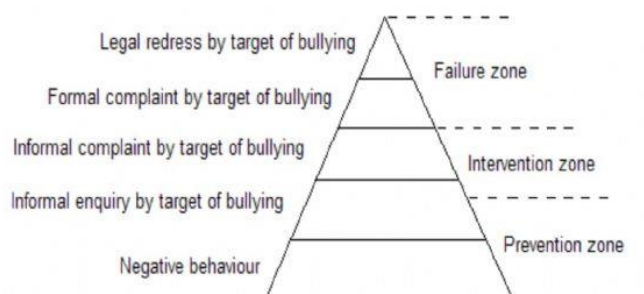
Workplace bullying refers to the situation where a person is submitted to physical or psychological violence, by one or several co-workers, repeatedly through time, not being able to defend itself. Various studies have linked this situation to the deterioration of mental health, increased levels of stress, various psychosomatic conditions, lessened self-confidence and increased sick-leave. As a family doctor, besides dealing with the physical and psychological symptoms, it is important to evaluate the affection of the family life, and the work-family imbalance, identifying possible victims of workplace bullying and giving the right legal and psychological support. One of the best methods found to control and stop workplace bullying involves cognitive rehearsal of responses to common bullying behaviors. Improved leadership (with anti-bullying policies) is also pointed as able to decrease the risk of bullying.

CONCLUSIONS:

This review pinpoints the physical and psychological repercussion that this situation may have in the health of the patient and its family, and reinforces the role that family doctors can have in this situation, providing a proper medical and legal support for these patients.

Keywords: Workplace, Bullying, Mobbing, Family doctor

Picture 1



Workplace Bullying event pyramid

P-0825

Assesment Of Violence With MVQ Scale In Patients Admitted To Hospitals

Serap Yurdagül Arslan¹, P. Gamze Erten Bucaktepe¹, Vasfiye Demir¹, Tahsin Çelepkolu¹, Hamza Aslanhan¹, Necmi Arslan¹, Yeşim Cengiz Balyen²

¹Dicle Universty Medical Fakulty Department of Family Medicine,Diyarbakır

²Mardin State Hospital District Ömerli, Mardin

INTRODUCTION: Violence is any act or exercise of power (i.e. physical, verbal, emotional, economic, sexual) performed by an individual or community to exert power over other individuals or communities and to cause physical or psychological damage to them. Violence remains a serious and common social problem both for Turkey and the whole world. The aim of this study was to investigate the perceptions of patients admitted to hospital and their relatives into violence, which is a serious public health problem for all the communities in the whole world ranging between the most democratic communities and traditional societies.

MATERIALS-METHODS: The descriptive cross-sectional study was performed on the patients who were admitted to Dicle University Medical Faculty Hospitals between August 1, 2014 and February 1, 2015 and their relatives.. The questionnaire comprised included the Maudsley Violence Questionnaire (MVQ), which was used for assessing the tendency of the participants to violence.Data were analyzed using IBM SPSS 18.0 for Windows.

RESULTS: The 531 participants included 180 (33.9%) women and 351 (66.1%) men with a mean age of 32.5±9.6 years. Of the participants, 147 (27.7%) had eye-witnessed violence and (55.4%) 294 had been exposed to violence. Median tendency to violence was 7.74 (range, 0-32) and median approval of violence was 4.53 (range, 0-14). The men had higher scores in approval of violence and tendency to violence ($p<0.001$ for both). A significant correlation was found between exposure to physical violence and approval of violence ($p>0.036$). Low level of education ($p>0.001$), rural origin ($p>0.038$), and male gender established a significant correlation with tendency to violence and approval of violence

CONCLUSION: The rates of exposure to violence and eye-witnessing violence were remarkably high. A significant correlation was found between low level of education, rural origin, and male gender and tendency to violence and approval of violence.

Keywords: violence,approval of violence,tendency to violence

P-0826

A regional learning collaborative to address the pubic health, public policy and primary care problem of chronic pain and opiate prescribing whilst providing enhanced learning oppourtunites for resident and attending physicians

Patrick S Mcfarlane

Family Medicine Center and Residency Program Eastern Maine Medical Center

In the New England Region of the United States opiate prescribing for issues of chronic pain have become a leading cause of morbidity and mortality after pharmaceutical industry driven initiatives to address pain as a fifth vital sign through national accreditation organizations requiring 1-10 perception of pain scales and the like. Opiate prescribing became a legendary problem in primary care practices as without regard to functionality, patients came to expect opiates to be prescribed ad infinitum, with pharmaceutical manufacturers promoting that there was no upper morophine equivalent limits and that addiction was not a comcomitant problem.

To address this a multimodal mulitdisciplinary effort in Maine was begun to address this problem and this talk is about a Professional Learning Community (PLC) model of addressing a public policy, public health and primary care driven problem with significant community impact.

The talk with highlight the Maine Chronic Pain Learning Collaborative (MCPLC) and effort of professional organizations in our region and a moderate sized residency program in Family Medicine that reduced long term opiate prescribing from a range

of 17-22% of patient panels to approximately 2%, and improved physician assessment of function, impact of medications, and provided early addiction intervention. We will briefly highlight suboxone and subutex treatment programs, and a multidisciplinary integrated approach to opiate prescribing, addiction and chronic pain.

Keywords: Addiction, Chronic pain, Opiates, multidisciplinary treatment

P-0827

The influence of social and demographic factors on patient satisfaction with primary care

Rima Gaidamovic¹, Vytautas Kasiulevicius¹, Virginijus Sapoka¹, Ausra Deksnyte², Ramunas Aranauskas²

¹Clinic of internal medicine, oncology and family medicine, Vilnius University, Vilnius, Lithuania

²Psychiatric clinic, Vilnius University, Vilnius, Lithuania

Background & Aim. Patient's characteristics affect formation of his view on satisfaction and expectations of primary health care (PHC) services. One of the most important modern health care strategic objectives is to activate individuals, groups and organizations in the implementation of various health improvement programs, and to promote dialogue between health care providers and patients. The aim of our study was to identify and analyse the factors, that influence patient's satisfaction with PHC and find out whether it is possible to predict the patients' satisfaction with PHC in accordance with the basic socio-demographic factors and assess the tendencies of this impact.

Methods. The study surveyed 444 patients using self-addressed Patient satisfaction Questionnaire Short-Form (PSQ-18). Cronbach's alpha statistics were used for the validation of the questionnaire. The patients' data included age, gender, nationality, education and place of residence as well as the registration with the certain PHC service.

Results. The place of living, patient's age and PHC centre's reputation had significant influence on the patient's satisfaction with PHC. Patients from cities assessed almost all aspects of the service better, than the patients from regional centres and villages. Patients with basic and tertiary education level assessed PHC significantly better than patients with lower or upper secondary education. We founded only a tendency, that women evaluated PHC better than men. The oldest patients were satisfied with their PHC most, and the middle age patients were satisfied at least. Also patients, who attend more prestigious PHC centres, were satisfied with their health care more.

Conclusions. The patients' satisfaction was more dependent on the social (registration with the prestigious family health care centre, education) rather than on the demographic factors (gender and age). Further studies should include more PHC centres from different regions of country, also to include more factors characterizing patient's social status.

Keywords: Social and demographic factors, patient satisfaction, primary health care

Picture No 1. The results of PSQ-18 evaluation

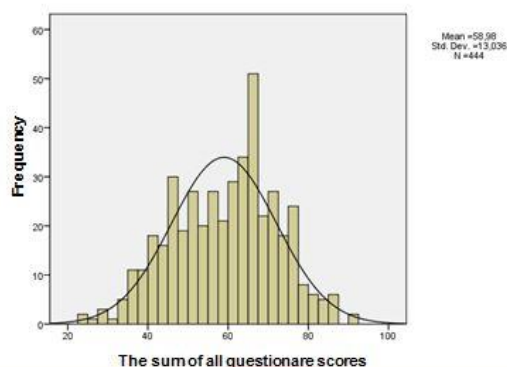


Table No 1. Scale correlations with social and demographic factors.

Social and demographic factors	Corelation coefficient	
	r	p
Gender: male, female	0,086	0,07
Nationality: lithuanian, russian, polish, other	0,04	0,937
Age (by years)	0,033	0,487
Age (divided into groups: 18-38, 39-59, 60-80 years old)	0,027	0,567
Education: primary and lower secondary, upper secondary, post-secondary non-tertiary and tertiary education	0,095	0,044
Place of residence: city, region center and village	-0,238	<0,001
PHC centers: Santariškių, other PHC centers in Vilnius, PHC centers in Trakų ir Telšių regions	-0,477	<0,001

Table No 2. Factor associated with better evaluation of PHC

Predicted factor	Predicted factors	Value	Wald coefficient	P
Better evaluation of PHC - R2 (Nagelkerke coefficient) 0,281	Attendance to Santariškių family medicine center	3,492	73,367	<0,001
	Attendance to other family medicine center in Vilnius	1,924	40,147	<0,001
	Primary and lower secondary education	0,862	24,636	0,031
	Place of residence (city, region center and village)	0,377	2,090	0,148
	Gender	0,079	0,137	0,711

P-0828

Patients with type 2 diabetes (MD) complications and specialist consultations frequency of general practitioner

Mindaugas Paulius¹, Indrė Baužienė¹, Indrė Ličytė¹, Kazys Simanauskas¹, Eglė Simanauskienė²

¹Faculty of Medicine, Vilnius University, Lithuania

²Children's Hospital, Affiliate of Vilnius University Hospital Santariskiu Klinikos

Objective. Family physicians have increasingly faced with rapidly progressive complications of type 2 diabetes, so the question is, how often it should be promptly and how often our patient should be consulted a specialist. The aim - to assess how much a year occur with type 2 diabetes complications and how often professional advice for further treatment is needed.

Materials and Methods. A retrospective analysis of 46 Vilnius University Hospital Family Medicine Centre patients with type 2 diabetes was carried out. There were assessed the incidence of complications of this disease and how frequent the specialist was asked for consultation. A statistical analysis was done and the significance assessed by a X-square test. The statistical difference was considered spreads across if the p value was below 0.05.

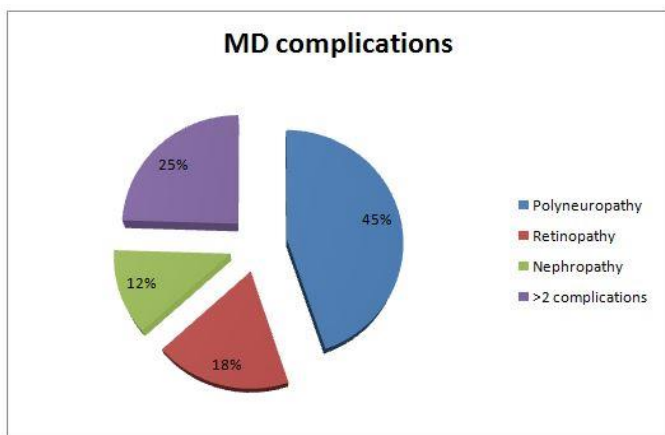
Results. The most common complication of the disease - polyneuropathy – was diagnosed almost half of patients, retinopathy and nephropathy diagnosed with the rest of the test subjects. Almost one-third of the patients had two or more complications. HbA1c was a significant difference (p <0.05) in this index were higher in patients with polyneuropathy compared with non. Hunger glycemic index (p <0.05) higher in the group of patients with polyneuropathy. Because of the small subjects and the number of studies there were not able to compare indicators and non-diabetic patients with retinopathy or nephropathy groups. The patient should be referred to a

specialist (doctor endocrinologist), to assess the occurrence of diabetic complications, their progression and provided care plan once a year. Only 56.5% of the patients had been consulted a doctor endocrinologist, nephrologist consulted 6.5 % and ophthalmologist – 37 % of all patients per year, and a similar situation was during next year.

Conclusions. Complications of the disease is very common, however, the number of consultations should be higher.

Keywords: type 2 MD, complications, consultations

1 picture. Complications of MD rate



1 table. Consultations frequency per year

Frequency	Endocrinologist		Nephrologist		Ophthalmologist	
	n	%	n	%	n	%
0	20	43,5	43	93,5	29	63,0
1	14	30,4	3	6,5	13	28,3
2	9	19,6	-	-	2	4,3
3	3	6,5	-	-	2	4,3

P-0829

Improving performance indicators in primary health care commissioning in Portugal

António Pereira¹, Sílvia Machaqueiro², Luís Velez Lapão³, Paulo Nogueira⁴, Matilde Rosa⁴, André Biscaia⁵

¹Unidade de Saúde Familiar Prelada, ACES Porto Ocidental

²Associação para a Cooperação e Desenvolvimento Garcia de Orta (AGO)

³Instituto de Higiene e Medicina Tropical – Universidade Nova de Lisboa

⁴Direcção-Geral da Saúde

⁵Unidade de Saúde Familiar Marginal, ACES Cascais

Background and aim

Portuguese primary health care commissioning (PHCC) aims at improving performance results through targets for selected indicators and an incentive scheme. Transparent negotiation and evidence-based selection of indicators are critical.

Despite annual reviews, there is room for improvement concerning the definition and validation of performance indicators and targets.

This work aims at introducing a rationale for selecting relevant and adequate performance indicators in PHCC, in response to current challenges and shortcomings undermining practices' performance assessment.

Method

An international literature review was conducted on criteria and methods for indicator selection and validation. All commissioning indicators for Portuguese PHC practices were analysed and trends were observed for 2009-2015.

A workshop with political, clinical and academic stakeholders was held on challenges, solutions and technical evidence on current indicators. Conclusions were analysed and drafted as policy recommendations for 2015 PHCC.

Results

Some issues pervaded Portuguese PHCC performance indicators: lack of scientific evidence-base and specification detailing (in order to avoid inaccurate records). The whole process is still poorly linked to practices' context and to national, regional and local health priorities.

Performance has been predominantly measured by process indicators and some of the priority health conditions (e.g. heart failure) and patient-reported outcome indicators have been neglected. Nevertheless, there is an increasing focus on results, on indicators' scientific validity and at improving the negotiation process.

Conclusions

Although performance indicators are selected for three years in Portugal, it is important to reconcile stability and flexibility goals in performance assessment. Annual commissioning reviews should encompass improvement to the indicators themselves, whenever relevant.

A multi-step performance indicator appraisal and validation process is recommended. Indicators should link to existing health priorities, be widely discussed among stakeholders and arise from consensus on the indicators' value: clinical relevance; scientific validity; link to the care process; potential for improvement; simple appraisal.

Keywords: indicator, performance measurement, primary health care, evidence, validation

1 - Commissioning

e-mail: antoniopereira@gmail.com



Commissioning

Process of evaluation of a population's health needs, and planning, implementation and monitoring of services in order to meet those needs, according to availability of resources.

Commissioning

3 - Limitations – some national findings



Limitations – some national findings

Shortcomings of current indicator-setting processes:

- Lack of scientific evidence to support some performance indicators
- Insufficient detail in indicator specifications for measurement
- Indicator development & implementation still poorly linked to:
 - National health priorities
 - Practices' context characteristics
- Impact on practice and performance measurement:
- Inaccuracies & errors in clinical records
- Lower reliability of indicators' final results
- Consistently higher performance targets regardless of context specificities

4 - Improvement proposed approaches



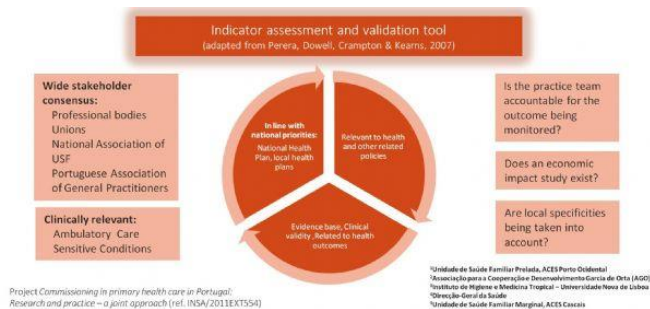
Improvement proposed approaches

Widen the scope of national-priority health conditions' indicators (respiratory and mental health areas)

Better overall indicator validation process:

- Identification of performance outcomes according to national, regional and local health priorities
- Definition of multi-disciplinary commission for ensuring indicator utility and usability
- Use of indicator validation tool for testing indicator usefulness

CONCLUSIONS



CONCLUSIONS

Project Commissioning in primary health care in Portugal:
Research and practice – a joint approach (ref. INSA/2011EXT554)

2 - Key principles



Key principles

- Evaluation of practices against performance targets
- Technical and scientific rationale for selecting indicators
- Performance targets negotiated with practices for a set of outcomes/indicators
- Financial incentives linked to achievement of performance goals

Key principles

P-0830

Want to change your doctor.....but why?

Adela Ioana Uta¹, Claudia Elena Uta¹, Carlos Isanta Pomar¹, Lia Anguelova Valentinova²

¹Department of Primary Care, Health, Zaragoza, Spain

²Department of Endocrinology, Valencia Agency of Health, Castellon de la Plana, Spain

OBJECTIVES:

The relationship between a doctor and a patient is a very important concept in health care, as it is associated with a greater adherence to the treatment, more satisfaction of the patient and a better prognosis.

The satisfaction as well as the quality of assistance received is the determining factor in the voluntarily change of doctors by the patients.

Determining the most common reasons for the voluntarily change of doctors is one of the objectives of our study.

METHODS-MATERIALS:

It's an exploratory study carried out between 15 of May and 16 of July 2014 in a Healthcare Centre in Zaragoza, Spain with a total of 15 doctors and 15.185 patients.

For the study we created a questionnaire with a closed question system about the motives of their wish for change and only one open question where there could detail their reason, collecting the data from the patients anonymously. We also included demographic data of age and sex.

RESULTS:

The total number of patients that changed their doctor in the two month study was 35 with a mean of 1.5 patients per doctor per month.

Regarding the reasons 16 patients listed as a motive inconvenient working hours, 17 patients listed a bad relation and 2 patients wished to change their doctor because they were consulted every time they needed attention by a different doctor in the last year.

CONCLUSIONS:

The main reason for wanting to change their personal doctor is the dissatisfaction of the patient with his doctor. The rate of patients changing doctors in the Healthcare Centre is elevated, but similar to another study carried out in another Healthcare Centre in the same city.

We conclude that there are 2 categories of doctors: ones that receive patients and others that tend lose them.

Keywords: family physician, patients care, effects of physician communication, practice management

Questionary given to the patients

COMO PARTE DE UN PROYECTO DE MEJORA DE LA CALIDAD ASISTENCIAL DEL CENTRO DE SALUD SE VA A REALIZAR UN ESTUDIO CON LA FINALIDAD DE DETECTAR PROBLEMAS RELACIONADOS CON LA SATISFACCION DE LOS USUARIOS Y SUSCEPTIBLES DE MEJORAR. POR ELLO LE INVITAMOS A PARTICIPAR EN ESTE ESTUDIO QUE SE REALIZA DE FORMA ANONIMA.

SE TRATA DE RESPONDER AL MOTIVO POR EL QUE HA DECIDIDO CAMBIAR DE MEDICO:

- ME INTERESA OTRO HORARIO DIFERENTE AL DEL MEDICO ACTUAL
- SIEMPRE HAY QUE ESPERAR MUCHO PARA ENTRAR EN LA CONSULTA
- NO ESTOY CONTENTO/A CON LA RELACION QUE TENEMOS
- SIEMPRE HAY OTROS MEDICOS O ESTUDIANTES EN LA CONSULTA
- PREFIERO UN MEDICO DE DIFERENTE SEXO

Si quiere ampliar algunos detalles sobre el motivo del cambio puede escribirlo a continuación:

MEDICO INICIAL MEDICO FINAL.....

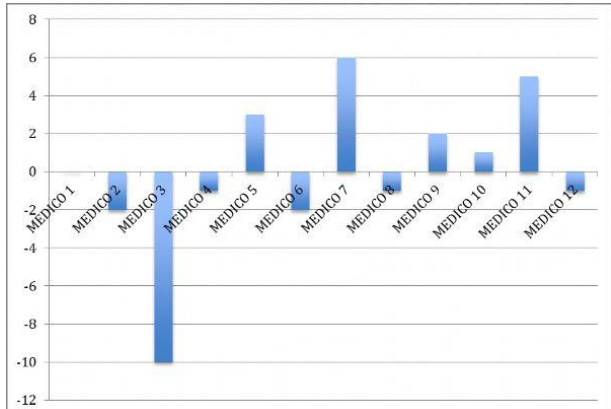
EDAD SEXO

RELIGION DEL PACIENTE (Respuesta voluntaria).....

The distribution on wins and losses of patients

	PATIENTS THAT LEFT	PATIENTS WIN	BALANCE
DOCTOR 1	4 (11,43)	4 (11,43)	0
DOCTOR 2	2 (5,71)	0	-2
DOCTOR 3	11 (31,43)	1 (2,86)	-10
DOCTOR 4	4 (11,43)	3 (8,58)	-1
DOCTOR 5	3 (8,57)	6 (17,14)	3
DOCTOR 6	4 (11,43)	2 (5,71)	-2
DOCTOR 7	0	6 (17,14)	6
DOCTOR 8	1 (2,86)	0	-1
DOCTOR 9	1 (2,86)	3 (8,57)	2
DOCTOR 10	1 (2,86)	2 (5,71)	1
DOCTOR 11	0	5 (14,28)	5
DOCTOR 12	4 (11,43)	3 (8,57)	-1

GRAFFIC DISTRIBUTION OF DOCTORS WIN-LOSS PATIENTS



REASONES TO CHANGE THE DOCTOR

	DIFFERENT SCHEDULEL	WAITTING TIME	BAD RELATION DR-PATIENT	OTHERS DRS	DIFFERENT SEX	TOTAL
DOCTOR1	4					4
DOCTOR2			2			2
DOCTOR 3	3 (27%)		8 (73%)			11
DOCTOR 4	2		2			4
DOCTOR 5	2		1			3
DOCTOR 6	1		1	2		4
DOCTOR 8	1					1
DOCTOR 9	1					1
DOCTOR 10	1					1
DOCTOR 11						0
DOCTOR 12	1 (25%)		3 (75%)			4
TOTAL	16 (46%)		17 (48%)	2 (16%)		35 (100%)

P-0831

Frailty in older people; a common European challenge that deserves a joint response from national health and care systems

Ines Garcia Sanchez, Ana Carta, Jorge Pinto Antunez
 DG SANTE European Commission. Health and Innovation Unit

BACKGROUND-AIM:

Europeans are living longer, but often with one or more long-term medical condition. Moreover, for r many citizens aging brings disability, frailty and/or chronic diseases. Although commonly used interchangeably to identify vulnerable older adults, those are distinct clinical entities causally related, often associated although not exchangeable. Their correct use will improve our understanding of the problems affecting older patients and lead to improved strategies and actions, affecting both the clinical setting and the management of care and social areas.

The European Innovation Partnership on Active and Healthy Ageing is a European Commission's answer to the demographic challenge Europe is facing. Aiming to improve the quality of life of older people and enable them to stay active and healthy for longer. During its implementation plan it has taken forward frailty prevention through different channels such as an Action Group, Frailty Annual Conferences (2012, 2013) and funding instruments supporting related projects.

METHOD:

A 2 years Joint Action on frailty prevention, funded under the EU Health Programme 2015, supporting cooperation between Member States to establish frailty prevention as a priority of European health and care systems and unveil suitable solutions.

RESULT:

This Joint Action will improve our understanding of long-term care medical conditions affecting older patients and develop improved strategies for screening, assessment and intervening against frailty, disability and multi-morbidity. It will contribute to a more effective response to the needs of older people and reduce inefficiency in

care delivery through innovative organisational approaches and better combinations of professional and informal care.

CONCLUSION:

Frailty prevention is a global common challenge. Addressing it collectively will help progressing at national and European level. Active involvement in this Joint Action gives Member States the possibility to find solutions to unsolved problems and develop common frameworks and guidelines to tackle frailty through integrated care strategies.

Keywords: Frailty, ageing, EU policy, prevention

P-0832

Co-management Shared Care Unit between Family Medicine and Internal Medicine

Jaime Barrio¹, Kristina García¹, Jaime Rodríguez¹, Pablo Gómez¹, Miriam Uzuriaga¹, Arancha Barranco¹, Miguel Martínez¹, Mar Contreras¹, María Teresa Beca², Carmen Suárez¹

¹Hospital Universitario de La Princesa. Madrid. España

²Hospital General Universitario Gregorio Marañón. Madrid. España

o Background & AIM:

The Co-management Shared Care Unit between Family Medicine (FM) and Internal Medicine (IM) from Hospital La Princesa was created in 2011 to deliver more efficient care to complex patients through an IM doctor who coordinates the healthcare. This shared healthcare is done in person or through phone/email. The groups of patients referred to the unit by the FM doctor include:

- A. Multiple Chronic Conditions Patients (MCCP) who are followed by FM.
- B. MCCP who visit their FM doctor after discharge from IM hospitalization.
- C. Priority care patients for malignancy suspicion.
- D. Patients who need immediate follow-up.
- E. Patients with common diseases who require consultant expertise.
- F. Patients with abnormal labs/diagnosis/treatment doubts who require consultant expertise.
- G. Patients with complicated social conditions.

o METHOD:

A descriptive retrospective study from January 2013-April 2014 was done. We collected socio-demographic, clinical, functional, and utilization data of 302 patients belonging to the 4 health centers which participate within the unit.

o RESULTS:

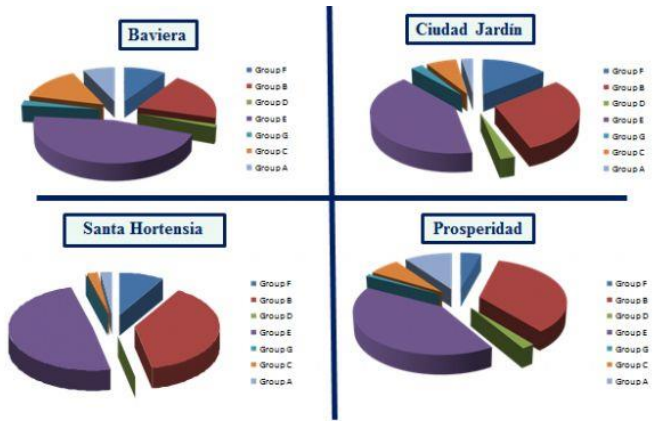
The average age was 70.9 and 59% were women. The patient breakdown was 44% group_E, 29.8% group_B, 8.9% group_F, 8.2% group_C, 5.9% group_A, 1.6% group_D and 1.6% group_G. 753 visits, 89 telephone consults, 146 ER visits, 90 hospitalizations and 96 daycare visits were performed. 52% of patients were discharged, 39% remained in the unit and 4.6% were deceased. Within the MCCP group, the average age was 80.5, average number of drugs used per day was 8.7, average ER visits was 0.7, average number of hospitalizations was 0.5 and the average Barthel Index was 75.1.

o CONCLUSIONS:

Patients in the MCCP group were older, used more drugs and resources and had more severe functional impairment. There was no difference in reason for referral between the health centers. Telephone was an important way to communicate with the patients.

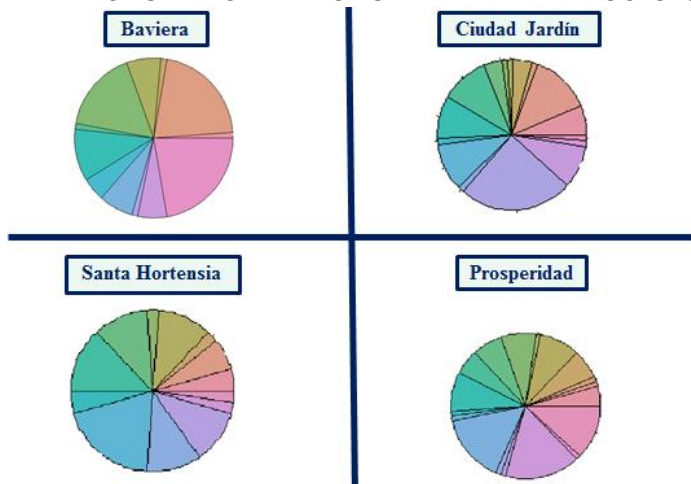
Keywords: Care Management, Efficiency, Family Practice, Internal Medicine

REASONS FOR REFERRAL AMONG THE HEALTH CENTERS



Pie charts of the reasons for referral among the four health centers

REFERRALS TO THE UNIT AMONG THE DIFFERENT DOCTORS



Pie charts of the referrals to the unit among the different doctors of the 4 health centers

P-0833

Praksis Plus: Three Years of a National Support Network for Establishing GPs (2012-2014) - the Danish Case

Ulrik Bak Kirk, Eva Schandorf, Jonas Hessler, Jon Zwisler, Dorte Navntoft, Rikke Pilegaard
Danish College of General Practitioners (DSAM), Copenhagen, Denmark

Background

In 2012, the Danish College of General Practitioners (DSAM) – the Scientific National Representative Body for all GPs in Denmark – recognized and articulated the need for a Support Network for Establishing GPs. GP trainees, Establishing GPs and the College (DSAM) identified more specific needs: More targeted support was demanded and requested. From this Praksis Plus was developed.

Methods

The concept Praksis Plus combines an interactive PDF with workshops for Establishing GPs in order to maintain and update the electronic handbook. Notifications about updates were made by using the Praksis Plus website together with social media.

In 2013, the full Praksis Plus Support Package was launched at DSAM's Annual Meeting. Furthermore, a National Executive Board was established, which comprised of 5 Newly Established GPs and 3 GP trainees. The Praksis Plus Executive Board functions as the Praksis Plus steering committee.

In 2014, DSAM allocated further funding for the national Praksis Plus Support Package, while the development of the regional Praksis Plus Zealand concept took place. Praksis Plus Zealand will introduce a welcome package containing a meeting for Established GPs, a regionally specific interactive PDF together with an e-learning module.

Results

Within its first three years (2012-2014), the Praksis Plus Support Package has achieved a great deal:

- The Praksis Plus interactive PDF and dedicated webpage.
- Representation at Annual DSAM Meetings.
- Workshops at Lægedage (biggest CPD conference, +2.500 GPs).
- 100 % free courses and conferences.
- Semi-structured national Praksis Plus Executive Board.
- Praksis Plus Zealand concept package for newly established GPs regionally.

Conclusions

Much has already been accomplished, but it is the intention to:

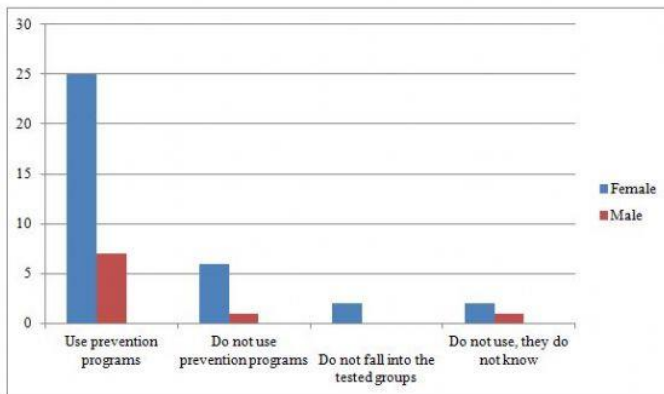
- Extend the Praksis Plus organizational framework
- Growing the network of Newly Established GPs and GP trainees
- Getting structured enhanced involvement of Denmark and Praksis Plus in the WONCA networks

Keywords: Establishing GP, Transition Support, Practice, Career Development,

Praksis Plus: Three Years of a National Support Network for Establishing GPs (2012-2014) - the Danish Case

Keywords: information about FC, the patient's motivation

1 picture. Patients with familial cancer use of prophylactic programs (in absolute terms).

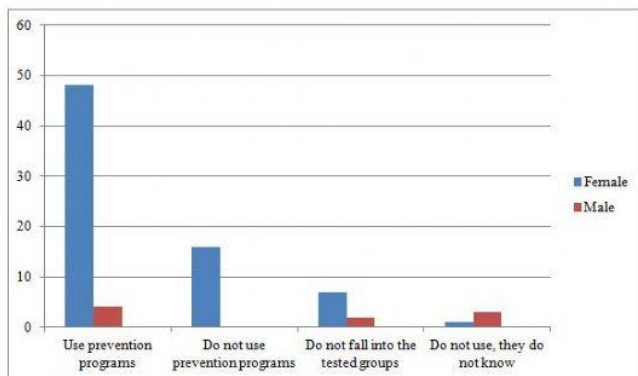


($p > 0,05$)

1 table. The number of positive oncological anamnesis by gender

Gender	Respondents	Positive oncological anamnesis
Female	107 (85,6%)	35 (33%)
Male	18 (14,4%)	9 (50%)

2 picture. Patients without familial cancer use of prophylactic programs (in absolute terms).



($p > 0,05$)

2 table. Respondents information

Gender	Healthy respondent	Sick respondent	Informed	Uninformed	Lack of knowledge about information
Female	72 (67%)	35 (33%)	3 (8,6%)	32 (91,4%)	0
Male	9 (50%)	9 (50%)	1 (11,1%)	7 (77,8%)	1 (11,1%)

P-0835

The role of non-financial incentives on Family Doctors/General Practitioners

Maria Luisa M Pettigrew¹, Stephanie Kumpunen², Nick Mays¹

¹Department of Health Services Research and Policy, London School of Hygiene and Tropical Medicine, UK

²Nuffield Trust, London, UK

Background & Aim

There is substantial literature examining mechanisms which motivate and modify the behaviour of healthcare providers, in particular, systematic reviews on the impacts of financial incentives on family doctors' behaviours. However the literature exploring the role of non-financial incentives on family doctors is more disparate and has not been systematically conceptualised or appraised. This poster aims to present a conceptual framework regarding the role of non-financial incentives on family doctors' behaviours.

Method & Results

The development of this framework will be informed by a scoping review of the literature on motivation and behaviour change in healthcare providers. The framework will be used to guide a systematic review and realist review on the evidence of the role of non-financial incentives on the behaviour of family doctors as the next stage of the project.

A systematic review aims to identify, evaluate and summarise the findings of relevant studies in order to make the available evidence more accessible to decision makers. However in cases when the evidence-base is heterogeneous and the 'intervention' (in this case a non-financial incentive) may be complex and subject to multiple contextual variables a realist review aims to explore in more depth what may work where, when and how by developing 'programme theory' of why it may work.

Conclusion

A conceptual framework will help understand what non-financial incentives can potentially be utilised in primary care and how they aim to lever the intrinsic to extrinsic spectrum of motivation. The framework will later be refined based on their findings of the systematic and realist reviews.

Keywords: primary care, family doctor, general practice, incentive, motivation, behaviour

P-0836

Study on effectiveness of care provided by the Mobile Emergency Care Service - SAMU / DF during 2013

Ubirajara José Picanço De De Miranda Junior¹, Vinicius Neves Bezerra¹, Leonardo Dos Santos Ferreira¹, Olga Messias Alves De Oliveira², Rafael Olinto²

¹Escola Superior de Ciências da Saúde - ESCS - Federal District - Brazil

²Mobile Emergency Care Service - SAMU

Background and AIM: Emergency Ambulance Service of the Federal District (SAMU / DF) performs urgent care / emergency and through phone calls prioritizes use the type of care, with or without medical staff (basic or advanced), in each case evaluated. This study described the effectiveness of the services performed by the SAMU / DF in 2013. METHOD: An exploratory study, cross over the telephone solicitations made to the Regulation Center of SAMU / DF in 2013, describing: total and type of connections made; first and second decision; increased demand for places; the estimated response time; sent resources; canceled missions; and use of advanced ambulance. RESULTS: In 2013 854.160 calls were recorded, and only 28.3% were covered by doctors. The links interrupted, hoaxes and mistakes, amounted to 67.7%. In the first medical decision, only 34.8% of regulations were defined as "necessary and possible intervention." In the second decision, 65.2% were classified as "necessary and possible removal." The regions with higher demand for care were the most densely populated and social vulnerability. Of the total resources used, 88.7% were basic ambulances and 11.3% unit advanced support. The average total time of SAMU response was 17.3 minutes, displaying inconsistency, 13.0 minutes in the first half and 21.6 minutes in the second half. 12303 were canceled missions, 15.1% of the total sent resources. The

main cancellation reasons were: removal by another institution, the central regulation cancellations, occurring already answered, patient refuses care, patient is not in place and death (6.02%). CONCLUSION: The SAMU / DF cannot fully do its job because the medical regulation is covered with little more than a quarter of the total demand demanded the Central regulation. Further research, especially tracking, supporting an improvement in the management of pre-hospital care in the capital of Brazil.

Keywords: Effectiveness; Medical Regulation; Emergency Ambulance Service

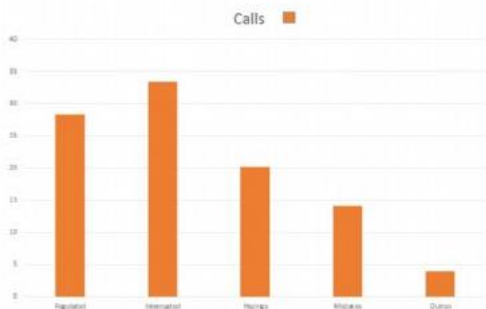
Emergency Service

Emergency Ambulance Service of the Federal District (SAMU - DF 192)



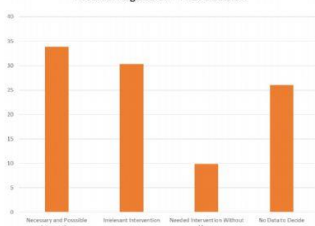
Total Calls

Number of Calls Made to the Central Setting in 2013: 854.160



Medical Decision

Medical Regulation - First Decision



P-0837

Women's Health Monitoring in suburban area of the Capital of Brazil

Fernando Ferreira Nata

Escola Superior de Ciências da Saúde - ESCS - Federal District - Brazil

Background and AIM: The region studied is a suburban neighborhood inhabited by popular urban working classes of central Brazil called Ceilândia, characterized by areas with regular urban infrastructure combined with large pockets of poverty and precarious socioeconomic status. To survey health monitoring indicators related to women issues linked to prenatal, postpartum and reproductive planning in 11 basic health units located in Ceilândia. METHODS: Cross-sectional study in 2013 in a population of 147.405 women of childbearing age in a total of 414.531 inhabitants in a suburb of the Brazilian Federal Capital. The data collection was executed during the assistance provided by the health workers in the local community. RESULTS: At first, the indicators assessed the extent to which services provided to the community in 2013 reached the results recommended by regulators of primary health care in Brazil. In its second stage, the study proposed the analysis of the indicators done by Ceilândia health workers themselves, so that from these data, there could be proposals to solve the identified problems. CONCLUSIONS: The result is a series of regulations adopted since 2014 by health facilities in order to enhance the work related to the primary health care of women. Among them, there is the need to conduct training and in-service training for professionals to better meet the prenatal component; as well as the necessity to perform networking activities between Ceilândia Regional Hospital and basic health units to ensure appointments in early postpartum period by the 10th day after birth; hold meetings to better guide the planning within the reproductive health unit, but also in schools to reach the teen audience.

Keywords: Health Indicators; Prenatal; Puerperium; Reproductive Planning

Ceilandia Air View



Ceilandia Down Town



P-0838**Health expenditure of chronic widespread pain in primary care**

Enma Marianela Morales Espinoza¹, Belchim Adriyanov Kostov¹, Daniel Cararach Salami¹, Pilar Brito Zerón², Manuel Ramos Casals², Antoni Sisó Almirall¹

¹Consorci d'Atenció Primària de Salut Eixample (CAPSE). Transversal Group for Research in Primary Care. Institut d'Investigacions Biomèdiques August Pi i Sunyer, (IDIBAPS). University of Barcelona. Spain

²Clinic Institute of Internal Medicine and Dermatology (ICMiD). Departament of Autoimmune Diseases. Hospital Clinic of Barcelona. Spain

OBJECTIVE: Impact on health expenditure in patients with Chronic Widespread Pain (CWP) in Primary Health Care.

METHOD: Multicenter case-control study (age-gender matched) was carried out. A representative sample of 3048 patients was recruited during 2011-2012. American College of Rheumatology classification criteria was considered for CWP diagnosis. Health care resource utilisation were evaluated. Direct costs (primary healthcare visits, laboratory and diagnostic tests, prescription medications, emergency room visits, hospital admissions and major/minor surgery) and indirect costs (lost productivity) were measured.

RESULTS: 168 patients met criteria for CWP (prevalence 5.5%; 95%CI:[4.75%–6.38%]). One hundred and thirty consented to participate, 120 (92.3%) were women; mean age 61.7±11.7. Related painful syndromes: fibromyalgia in 65(50%), osteoarthritis in 53(40.8%) and autoimmune or rheumatic diseases in 11(8.4%); Subjects with CWP were reported to visit more time to Primary health care physicians (11.8 vs 8.4; p>0.001), hospital specialist physicians (3.9 vs 2.4, p=0.002) and more laboratory test (1.8 vs 1.3; p<0.001). CWP cases received more prescription than control group (818€ vs 311€; p<0.001): drug expenditure represents 41.31% of direct health expenditure. Mean total direct costs in CWP-patients were 1980 ± 1811€ while in control group were 1003 ± 826€ (p<0.001). Mean indirect costs in CWP-patients were 1474 ± 5361€, while in control group were 328 ± 2255€ (p=0.013). Global costs in CWP-patients were 3454 ± 5604€, and 1331 ± 2416€ in control group (p<0.001).

CONCLUSION: Patients with CWP have a very high health care costs, both direct medical costs (specially drug expenditure) and indirect costs (lost productivity due to sick leave).

Keywords: Health Care Costs, chronic pain, Primary Health Care

P-0839**First aid notions for public and private school communities of Federal District, Brazil**

Mônica Beatriz Ortolan Libardi¹, Júlia Maria De Oliveira Duarte¹, Olga Messias Alves De Oliveira¹, Ubirajara José Picanço De Miranda Junior²

¹Mobile Emergency Care Service - SAMU 192 - Federal District - Brazil

²Superior School of Health Sciences - ESCS - Federal District - Brazil

Background and AIM: The Public Education Network of the Federal District has 664 public schools and 432 private schools registered in the Secretary of Education and distributed in the 31 administrative regions, which are attended by more than 400 thousand students. With the implementation of the Emergency Ambulance Service (SAMU 192/DF), which provides health care to the population, and is operated by the Regulation Center, there was the need to instruct schoolchildren on how to properly use the pre-hospital treatment and how to start first aid care until the health workers arrive on the scene. In 2007, was launched the Samuzinho® Project in order to bring to the community knowledge the SAMU 192-DF service and the "Samu in Schools" program was created, in order to clarify when and how to call the pre-hospital treatment (APH) and to teach notions of first aid care to the school community. **METHOD:** The project has been running for 8 years, involving teachers, monitors, directors, janitors, secretaries, engineers, educators, and using the active construction methodology of basic life support for lay people, that is, those who are not health professionals, until the arrivals of the SAMU/DF team. **RESULTS:** The implementation of the Project provided a change of behavior in the school community, comprising the

acceptance, commitment and assimilation of the importance of the use of the Service, as well as starting the basic care needed to attempt the citizen survival. By March 2015, over 13,000 people were involved in this construction of knowledge. CONCLUSIONS: The continuing educational process has facilitated awareness of first aid notions among teachers and students of public and private network of the Federal District.

Keywords: Mobile Emergency Care Service - SAMU; First aid notions; Education Network

Children trained



First aid notions



Public and private school training



P-0840

Reduction in prank calls to prehospital emergency care services -“Samuzinho Project”®

Mônica Beatriz Ortolan Libardi¹, Júlia Maria De Oliveira Duarte¹, Rodrigo Belém Caselli¹, Ubirajara José Picanço De Miranda Junior²

¹Mobile Emergency Care Service - SAMU 192 - Federal District - Brazil

²Superior School of Health Sciences - ESCS - Federal District - Brazil

BACKGROUND AND AIM: The Ambulance Service of the Federal District of Brazil - SAMU 192-DF, under the Ministry of Health, is a prehospital care service accessed through telephone call to a Central Medical Regulation. The high prevalence of undue calls is a problem that occurs in this service. This problem is responsible for the overload on the system, professional burnout and even dislocation of ambulances to unnecessary places, leaving unattended victims who really need help. The majority of these calls were prank calls, made by schoolchildren and also by adults, representing about 60% of the undue calls. In 2007, the Samuzinho® Project was launched in order to bring to the community knowledge the SAMU 192-DF service, developing their spirit of solidarity, citizenship and service to others. Thus, this project aims to highlight the importance about the correct use of telephone to call for a prehospital care service.**METHODOLOGY:** Realization of first aid notions training course for schoolchildren and adults. It were used story creation ludic methods, scrapbook and collage, clay handling, and the real presentation of ambulances and teams, moto-ambulance and even helicopter. It was given a certification of completion for the participants.**RESULTS:** By March 2015, a total of 13,055 people were trained. Among them there were children, teenagers, primary school, high school and college's professionals, charity companies and institutions, kindergartens and the community in general, elderlies and prison system's employees. As a result, there were a reduction of 51% on undue calls, remaining a rate of 9% of misuse of telephone to call the service.**CONCLUSIONS:** This training programme has demonstrated the importance of community awareness about the correct use of a help communication tool and, as a result, the improvement on the prehospital emergency care service.**KEY-WORDS:** Prehospital; ambulance service; SAMU 192-DF.

Keywords: Mobile Emergency Care Service - SAMU; Samuzinho Project; Reduction in prank calls

certificate



Training course for schollar students



SAMUZINHO PROJECT



P-0841

Quality of life in Mobile Emergency Care Service of the Federal District - SAMU 192/DF-Brazil

João Ricardo Simczak Prates¹, Rodrigo Belem Caselli¹, Olga Messias Alves De Oliveira¹, Ubirajara José Picanço De Miranda Junior², Luciana Stoimenoff Brito³

¹Mobile Emergency Care Service - SAMU 192 - Federal District - Brazil

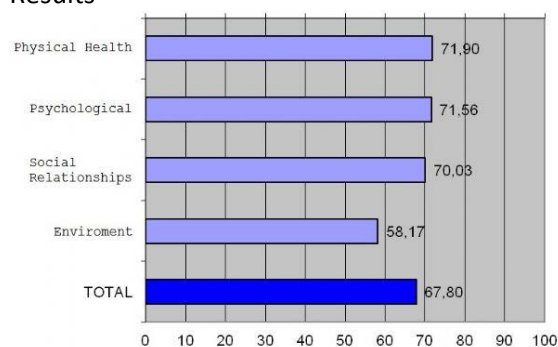
²Superior School of Health Sciences - ESCS - Federal District - Brazil

³University of Brasilia - Brasil

Background and AIM: When performing a job, the individual inserted in a context and the social representation of this activity impacts both in their life and in their welfare, requiring attention to their quality of life. This project took into consideration the stressful nature of working in emergencies and other peculiarities of this service and the objective was to analyze quality of life of workers of the Emergency Service of the Federal District - SAMU/DF. METHOD: Application of the test WHOQOL-BREF in 425 workers of various professional categories, representing between 40% and 45% of the total workforce. RESULTS: We found similar results between the different groups of work, with some differences among those who work directly in the field service and the others, showing good scores. The physical domain had good scores (71.9%), but the facet "sleep and rest" (58.93%) appeared quite below average. The psychological domain also presented a good score (71.56), with the "self-esteem" facet (84.8), representing the highest rate in the test, although, "positive feelings" (61.25), appearing in the same domain, presented lower score. Environment was the domain (56.77) that presented lower scores in general, and health and social care: availability and quality (45.76), participation in opportunities for recreation / leisure (45.81) and physical environment (pollution / noise / traffic / climate) the lowest and unique indexes to presented scores below 50. The Social Relations domain presented averaging high scores, with the facet "social support" (66.29) the negative highlight, although has reasonable score. CONCLUSIONS: The application of the WHOQOL-Bref in SAMU/DF presented that there is, overall, a uniform assessment by the workers, whose groups have very similar self-assessments. Further studies are needed to evaluate the possible correlation of these factors with low levels of quality of sleep and rest as well as leisure activities.

Keywords: Quality of life; WHOQOL-BREF; SAMU/DF

Results



P-0842

Latest communication interactions with patients outside the Primary Health Care Centre

Anna Forcada Arcarons, Engracia Costa Atienza, Silvia Altimiras Rovira, Laura Almendros Plana, [Alícia Díaz Pilco](#)
institut català de la salut

BACKGROUND & AIM

Overload in Primary Health Care has triggered the creation of new forms of communication with users.

In order to relieve the visits in the centre, we have developed new forms of communication with patients.

These are telephone visits (TV), home visits (HV) and virtual visit (VV).

Thereby, we attempt to improve the utilization of healthcare resources efficiently, increase patient access to the best possible resources and promote self-care and prevention of patient.

METHODOLGY

TV, HV and VV (2013) have been evaluated by our computer system (ECAP) and they have been compared with the center visits (CV) of the professionals who work in the center (Doctors, Nurses, Pediatrics).

Then we have compared data on VV 2012 and 2013 as it has been the last type of visit established in the center.

Data are included by doctors, paediatricians and nurses (adults and paediatrics):

- CV 2013: 48199 Doctors (82.1%) visits; Paediatricians 11291 (90.6%) visits; 26347 nurses (78%) visits.

- TV 2013: 4319 Doctors (7.3%) visits; Paediatricians 710 (5.7%) visits; nurses in 2130 (6.3%) visits.

- HV 2013: 1408 Doctors (2.4%) visits; Paediatricians 1 (0.00008%) visit; Nurses in 2819 (8.3%) visits.

- VV 2013: 4817 Doctors (8.2%) visits; Paediatricians 465 (3.7%) visits; Nurses in 2502 (7.4%) visits.

Progression of virtual visits since its establishment in the centre:

- VV 2012 3530 visits (57% Doctors, Nurses 40.1%, 2.9% Paediatricians).

- VV 2013 7791 visits (62% Doctors, Nurses 32.1%, 5.9% Paediatricians).

CONCLUSIONS

Trend persists in the visits in the centre, while gradually increasing the TV and VV in the years studied. The extension of contact channels patient - healthcare professional is an opportunity to increase the quality of services provided and relieve healthcare centres.

Keywords: KEYWORDS Patient communication; health outside professional relationship; new ways.

P-0843

Evolution of the non-contact visits in our Primary Health Care Centre since its introduction

Anna Forcada Arcarons, Engracia Costa Atienza, Silvia Altimiras Rovira, Laura Almendros Plana, [Alícia Díaz Pilco](#)
institut català de la salut

BACKGROUND

The overloading in primary healthcare has led the need to find other non-contact ways of communication to relieve the service.

It was established a non-contact visit in the centre (virtual visit-VV).

Its PURPOSE: to serve the needs of patient who not require a visit in the centre.

Define subcategories: healthcare data (INT_ACTIVA), Editorial clinical report (INF_CLINIC), Medical Record Review (REV_HC), Review prescription (REV_PPF), Patient transport (TRANSPORT), Review Temporary disability (REV_IT), Return of laboratory results (RESULT_LAB), Return orders clinics (RESULT_OC), Other (OTHER).

AIM

To improve the utilization of health care resources efficiently and increase patient access to the most appropriate resources.

METHODOLOGY

Evaluation of the VV since its inception in 2012 until 2014 by our computer system (ECAP) of the professionals who work in the centre (doctors, nurses, Paediatricians).

Quantify visits according to subcategories.

RESULTS

There are 11 doctors and 11 nurses for adults and 4 doctors and 4 nurses for paediatric in the centre.

Data are included by doctors, paediatricians and nurses (adults and paediatrics):

- VV 2012: Doctors 2009 (57%); Paediatricians 101 (2.9%); Nurses 1420 (40.1%) visits.
- VV 2013: Doctors 4829 (62%); Paediatricians 465 (5.9%); Nurses 2502 (32.1%) visits.
- VV 2014: Doctors 6391 (68.6%); Paediatricians 532 (5.7%); Nurses 2396 (25.7%) visits.

Evolution of the VV in this period:

- VV 2012: 3530 visits (34% REV_HC, REV_IT 31%, OTHER 26.7%).
- VV 2013: 7791 visits (30% REV_HC, 26.5% INT_ACTIVIA, OTHER 20.1%, REV_IT 18%).
- VV 2014: 9319 visits (37.8% INT_ACTIVIA, 32% REV_HC, 12.8% REV_IT, OTHER 10.7%).

CONCLUSIONS

It's doubled the use of this type of visit established in the centre.

It's included a variety of items that help to detail the type of work that healthcare professionals perform.

It's an opportunity to increase the quality of services provided and relieve in health care centres.

Keywords: Patient communication; Outside health professional relationship; new ways.

P-0844

The role of family doctor in anxiety problems among students due to tsunami risk in Padang City West Sumatra

Rima Semiarty Kamardi¹, Hardisman Dasman²

¹Departement of Public Health, Faculty of Medicine Andalas University, Indonesia

²International Public Health Studies Faculty of Medicine and Health Sciences Flinders University Bedford Park, Adelaide Australia

Padang is one of the city in Indonesia that have a high risk to earthquakes and tsunami disaster. After Aceh Tsunami in 2006 and big earthquake in 2009 in Padang, there were area that consider red zone which are closed to danger area (near the beach) and green zone that relatively far from danger area.

For those who survived from tsunami attack, will face mental trauma that still remain such as anxiety.

.This study examined the correlation of the tsunami risk to the anxiety level on children in the red and green zone of Padang after conducted simulated on earth quake and tsunami for elementary school.

This research is an observational analytic study using cross sectional design with total sample of 117 responden were selected by stratified random sampling. from elementary school located in red and green zone.

The data were collected by using a HRS -A questionnaire analyzed by chisquare test.

The results of this study indicate the level of anxiety in children in red zone higher then in green zone..

After intervention from group of family doctor, colaborated with medical students in public health clerkship, the level of anxiety decrease significantly.

Keywords: tsunami risk, anxiety, children, simulation

P-0845

Improving Primary Care Commissioning Process: the importance of considering the units' socio-demographic context

Matilde Rosa¹, António Pereira², André Biscaia³, Sílvia Machaqueiro⁴, Luís Velez Lapão⁵, Paulo Nogueira¹

¹Direcção-Geral da Saúde, Lisboa, Portugal

²Unidade de Saúde Familiar Prelada, ACES Porto Ocidental, Porto, Portugal

³Unidade de Saúde Familiar Marginal, ACES Cascais; Associação para a Cooperação e Desenvolvimento (AGO), Lisboa, Portugal

⁴Associação para a Cooperação e Desenvolvimento Garcia de Orta (AGO), Lisboa, Portugal

⁵Associação para a Cooperação e Desenvolvimento Garcia de Orta (AGO); Instituto de Higiene e Medicina Tropical – Universidade Nova de Lisboa, Lisboa, Portugal

In the UK, the 75th percentile of the results achieved in the last two years for each indicator is considered the reference value for setting targets for primary health care (PHC) commissioning for the following year (Brilleman et al., 2013).

This methodology was proposed by the authors of this study and it was welcomed by the Portuguese responsible entities that defined the 80th percentile instead as a reference and upper threshold for setting targets for the Portuguese PHC commissioning in 2015.

This research focus on the targets of the PHC units' indicators and the importance of considering the units' socio-demographic context.

Eleven national indicators related to healthcare access, performance, satisfaction and efficiency were analysed for 2013 and 2014 and all PHC units of Portugal were assessed.

Firstly, the 75th percentiles of the indicators' results from 2013 were calculated for 1) total of units, per organisational model; 2) units clustered by its organizational model, age (years since starting) and size. Then, indicators' results from 2014 were analysed, in accordance with how many of them were upper than the percentiles calculated for the indicators' results of 2013 in the two situations and the difference was tested using t-test.

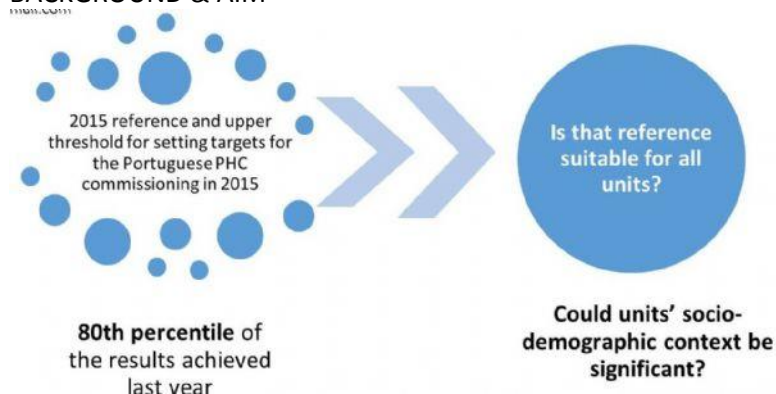
For 2014, there were more units overcoming the 75th percentile when the percentile was calculated for units clustered by organizational model, age and size (2019 units) than when the percentile was calculated for the total of units per organisational model (1840 units) ($p < 0,001$).

It was shown that the evaluation of the units when the target setting consider PHC unit's organizational model, age and the size was more appropriate than the one taking into account only the organizational model, which reinforce the importance of introducing the context when defining targets.

Further studies should consider more context variables.

Keywords: primary health care; commissioning; setting targets

BACKGROUND & AIM



Poster



Improving Primary Care Commissioning Process: the importance of considering the units' socio-demographic context

Martim Roco¹, António Pereira², André Boccali³, Sílvia Machado⁴, Luís Veloso Lopes⁵, Pádua Nogueira⁶
e-mail: antonio.pereira@gnral.com

Context

In the UK, the 75th percentile of the results achieved in the last two years for each indicator is considered the reference value for setting targets for primary health care commissioning for the following year.
This methodology was proposed by the authors of this study and it was welcomed by the Portuguese responsible entities that defined the 80th percentile instead as a reference and upper threshold for setting targets for the Portuguese PHC commissioning in 2015.



Method

Eleven national indicators related to healthcare access, performance, satisfaction and efficiency were analysed for 2013 and 2014 and all PHC units of Portugal were assessed.

75th percentiles of the indicators' results from 2013 were calculated for:
1) total of units, per organisational model
2) units clustered by its organizational model, age (years since starting) and size.

USF (Family Health Units) - PHC Reform 2005

- Voluntary enrolment
- Small, public, multi-professional, stable and self-organised teams
- Organisational, functional and technical autonomy
- Mixed payment system linked to performance

Variables

- Age (years since starting)
- 0-2 Years
 - More than 2 years
- Size (number of family doctors)
- 0-4 family doctors
 - 5-9 family doctors
 - More than 9 family doctors
- Organisational model
- UCSP → traditional model
 - USF-A → Family Health Unit Model A
 - USF-B → Family Health Unit Model B

Results

There were more units overcoming the 75th percentile when the percentile was calculated for units clustered by organizational model, age and size (2019 units) than when the percentile was calculated for the total of units per organisational model (1840 units) ($p < 0,001$).

	UCSP-M	USF-A	USF-B
Organisational Model	$p < 0,001$	$p < 0,001$	$p < 0,001$
Age	Not significant	$p < 0,001$	Not significant
Size	$p < 0,001$	Not significant	Not significant

Conclusions

It was shown that the evaluation of the units when the target setting consider PHC unit's organizational model, age and the size was more appropriate than the one taking into account only the organizational model, which reinforce the importance of introducing the context when defining targets.

Project Commissioning in primary health care in Portugal: Research and practice – a joint approach (ref. INSA/2011EX1554)

¹Unidade de Saúde Familiar, Portugal
²Unidade de Saúde Familiar, Portugal
³Unidade de Saúde Familiar, Portugal
⁴Unidade de Saúde Familiar, Portugal
⁵Unidade de Saúde Familiar, Portugal
⁶Unidade de Saúde Familiar, Portugal

Variables

Variables

- Age (years since starting)
- 0-2 Years
 - More than 2 years
- Size (number of family doctors)
- 0-4 family doctors
 - 5-9 family doctors
 - More than 9 family doctors
- Organisational model
- UCSP → traditional model
 - USF-A → Family Health Unit Model A
 - USF-B → Family Health Unit Model B
- USF (Family Health Units) - PHC Reform 2005
- Voluntary enrolment
 - Small, public, multi-professional, stable and self-organised teams
 - Organisational, functional and technical autonomy
 - Mixed payment system linked to performance

Significance between Organisational Model, Age and Size of PHC

	UCSP	USF-A	USF-B
Organisational Model	$p < 0,001$	$p < 0,001$	$p < 0,001$
Age	Not significant	$p < 0,001$	Not significant
Size	$p < 0,001$	Not significant	Not significant

Organisational Model is a significant variable. Age is just significant for USF-A Size is just significant for UCSP

Role of Public Health Promotion in prevention of Road Traffic Accident

Menkher Manjas¹, Abdiana Ana², Rima Semiarty Kamardi³

¹Departement Of Surgery, M Jamil Hospital, Medical Faculty, Andalas University, Indonesia

²Department of Public Health, Medical faculty Andalas University Indonesia

³Department of Public Health, Medical faculty Andalas University, Indonesia

Estimated that 1.2 million are killed a year among 50 million injured people in Road Traffic Injuries (RTIs). RTIs are a huge major endemic public health problem, which annually increasing globally

The most cause increased of traffic accident are driver, passenger, Lack of transportation facility,

Keywords: Road traffic accident, socialisation

Prof. Menkher Manjas, Sp.B, Sp.OT, FICS

Background:

- Road Traffic Injuries (RTIs) are a huge major public health problem which annually increasing globally. Estimated that 1.2 million people were killed a year by RTIs among 50 million injured people. Its become the 3rd cause death around 10-40 year old. In the world, at least one case died every 26.3 seconds. In Indonesia the incidence more high where one people died every 17 minutes. During year 2014 at Padang West Sumatera, 64% of all deaths caused by RTIs. The Global cost of management increase year by year and in total minimally 2% of GDP.

Method:

The study was conducted by gathering 120 students from 3 different schools in Padang from January to March 2015. All of the students were given written test before, which consist of questions about traffic rules, regulations and casualties caused by traffic accidents. After the first test, they were given a counseling session for 2 hours each day in 7 days by the public health lecturers and the police officers. After that, the second test were hold 3 months later to see the impact of the counseling.

Result:

Figure 1: Before the counseling

Category	Correct	Wrong
High School	~15	~25
High School	~10	~20
High School	~12	~22

Figure 2: After the counseling

Category	Correct	Wrong
High School	~35	~10
High School	~30	~15
High School	~32	~12

Discussion:

Through counseling, the Public Health department and the Police Department could increase the knowledge, attitude and skills of the students in traffic regulations and casualties. We hope that the knowledge could be spread to others and traffic accidents in the future could be decreased.

Conclusion:

- RTI are a huge national problem
- Road traffic crashes are predictable and can be preventable.
- Public Health participate mainly in Health Education in traffic way
- Road safety is a shared responsibility
- The adoption of "system approach" in road safety hope an sharp reduction in crashes and casualty

References:

- Polun M et al, World report on road traffic injury prevention: summary, World Health Organization : 2004
- Hayley F, Traffic Accident, Problem and Solution Annual Meeting of Indonesia FIT (KAB), Semarang: 2003
- Prevention of Road Accidents and Injuries for the Safety of Employees, SOCSO Accident Prevention Seminar, Kuala Lumpur: 2002

Presented in 2015 World Organization of Family Doctors/ WONCA Europe Conference October 22-25, 2015 Istanbul - Turkey

Role of Public Health Promotion in Prevention of Road Traffic Accident

P-0847

Demand and use of health care services - exploring the level of health in a rural area of Crete

Theodoros Vasilopoulos¹, Georgia Arseni², Nikolaos Kontarakis¹, Crysanthi Tatsi¹

¹Health center of Ag.Barbara, Herakleio,Crete, Greece

²Venizeleio Gen. Hospital, Herakleio,Crete,Greece

INTRODUCTION: The demand for health care services, expresses the desire to consume health care services, which turns into active search for such care and is defined by objectively assessed needs, but depends on many factors such as demographic, social and economic characteristics of individuals, the health care system, the price of health services, the level of health etc. For primary care, the use of health services is expressed through indicators of the visits to GPs and other primary care organizations and through the frequency of prescription, and depend largely on the age and gender.

The purpose of this study is to investigate the characteristics of the users of health services in a General Medicine clinic of a rural area of Crete.

METHODS: 638 respondents consisted the study population, and refers to all users of health services who came to a specific general medical clinic at the health center of Santa Barbara Heraklion, with any justification for use of health services on a regular daily basis. Our study was conducted based on a structured questionnaire consisting of qualitative and quantitative questions.

RESULTS: The importance not only of age, gender, educational level and occupational employment and income but also that of the self-reported physical and mental health as perceived by users, is emerging, referring on the demand and use of health care services.

CONCLUSIONS: A new operating model for Primary Health Care is needed to improve the health status of the population, through the prevention of causes of morbidity and mortality, the health promotion and the awareness of users of health services. Basic premise is the education and training of primary health care practitioners to ensure better and more efficient provision of comprehensive health care, including the development and implementation of guidelines, and the application of diagnostic and therapeutic protocols, and clinical audit processes.

Keywords: demand for health services, use of health services, self-reported health, primary health care.

P-0848

Centers of Coexistence and Culture: a new perspective on mental health

Lara Louise Guimaraes Silveira, Rickella Aparecida Alves Moreira

Univerdidade Federal de Goiás, Goiânia, Brasil

Background & Aim

The Centers of Coexistence and Culture are part of the mental health network that arose after the Brazilian Psychiatric Reform, which aims to deinstitutionalization of mental health patients. All this reform seeks to withdraw the patient of mental hospitals and reinsert them in society. These centers carry with it various cultural and socialization activities, empowering them to regain a place in society.

This model has been consolidated as an innovative device playing a significant role in social inclusion of people with mental disorders. Due to its characteristics they are usually implemented in municipalities that have been able to build an effective network of care and assistance to severe and persistent mental disorders. And are justified only in those places where the replacement network of mental health has adequate coverage, especially CAPS.

Method

We observed the operation method of Convivencia Center "Cuca Fresca", which is the only Center of Coexistence and Culture in Goiania - GO.

Results

We observed that patients participating in the project uses this service as a place to connect with others in a healthy way, without prejudice and stigma that exists around mental health patient. The most diverse diseases

are seen at this center and they all perform various theater workshops, painting, computer, music - have a battery - etc.

Conclusions

The Centers of Coexistence and Culture are a great rehabilitation tool for mental health patients in society. In it we don't found only health professionals actually are mostly professionals focused in art and culture (are artists, artisans, "workshop instructors", etc.). So it's needed the support of all network of mental health (especially CAPS and its outpatient visits) in maintaining the mental health of patients.

Keywords: Mental health, Brazilian Psychiatric Reform

P-0849

Primary Health Care Unit: family medicine at the hospital, is it possible?

Leonor Roa Santervas, Bjørn Sletvold, Tanja Tomasevic, Baker Shukri, Samuel Mc Manus

Kommunal Akutt Døgnenhet. Oslo Kommune Helseetaten

Background & AIM:

In 2012 norwegian coordination reform legislation obliged the municipalities to provide inpatient health care within January 2016. They should ensure treatment and care for patients who needed acute help with two conditions, all established services should be better or just as well as alternative offered at the hospitals and should contribute to reduce the number of acute admissions in specialist service.

METHOD:

A multiorganizational project group established the principles of the Primary Health Care Unit (PHCU) in advanced to the opening. There were set admission criteria: the diagnosis in itself will not determine whether the patient can be admitted: expertise, staffing level and therapeutic options will decide. Every patient should be discussed with one staff physician before admission. Maximum admission time are three days.

Results

Oslo's PHCU was openend in Aker sykehus, nowadays there are 52 beds in use. Physicians are family medicine specialist or equivalent qualifications. There is access to x-ray, CT and laboratory services. GPs, emergency doctors and outpatient departments in hospitals can include patients after consulting with PHCU responsible physician by phone. PHCU physician is responsible for diagnostic assessment of patients, treatment plan and monitoring, as well as reports.

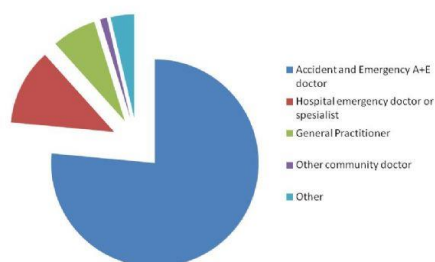
Conclusions

Oslo's PHCU provides services following the principles of family medicine. Our goal is to achieve first-class primary health service, not a second class hospital in order to facilitate comprehensive assessment, treatment and follow-up and to avoid overdiagnosis and overtreatment. Shared municipal organization facilitates better communication and cooperation with the different health institutions and provides a seamless and smooth transfer between health care levels.

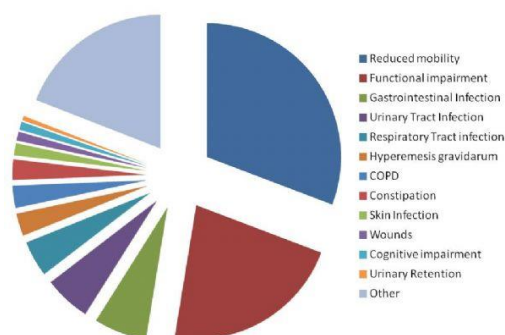
There is a long way to go and many things can be improved, but we strongly believe at this way of treating patients, which mostly are old people, makes them feel better and less sick.

Keywords: primary health care, acute care, municipalities, communication, health services

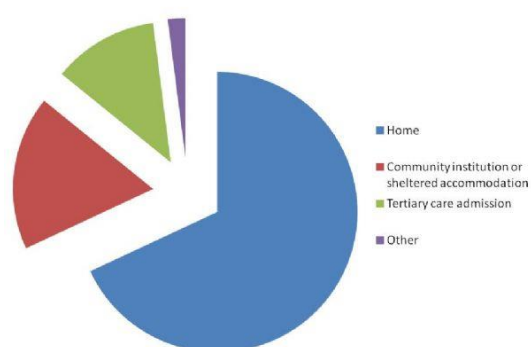
Patients referred by



Admission diagnoses



Patients discharged to



P-0850

Sleep medicine and referrals savings in Portuguese Primary Health Care

Maria Isabel Climaco, Maria Do Castelo Gouveia

ISCAC, Quinta Agrícola - Bencanta 3040-316 Coimbra, Portugal

Insomnia is one of the most common sleep disturbances in older adults, being even the most prevalent. Up to 40% - 50% of individuals over age 60 report disturbed sleep. The number of elderly that address General Practitioners (GP) in Primary Health Care (PHC) due to sleep problems has been increasing. GP play a key role in the diagnosis of sleep disturbances such as insomnia. As the GP is the first physician to attend patients who have complaints about poor sleep quality, they must be prepared so that a proper diagnosis can be made and treatment of sleep problems can be prescribed adequately. A GP within a health unit is responsible for the clinical decision whether to refer or not a patient to the hospital, for the type of initial referral (e.g. inpatient or outpatient treatment) and for selecting the medical specialty that would be appropriate for the referral. Referral costs depend crucially on these decisions, and costs for sleep medicine are a potential factor influencing savings on referral. For this purpose, a Data Envelopment Analysis model was developed to identify benchmark practices in PHC units, which offer the lowest aggregate referral and sleep medicine costs controlling for the number and age of the patients registered. For the remaining non-benchmark practices, the potential for savings on referral and sleep medicine costs can be obtained by identifying inefficiency sources and gaps relatively to the best practices, thus leading to shaping the changes needed to improve performance.

Keywords: Sleep disturbances, Data Envelopment Analysis, efficiency evaluation

P-0851

Organization of Family Medicine in Canton Sarajevo, Bosnia and Herzegovina

Fuad Husic¹, Zaim Jatic¹, Dzenana Tanovic¹, Nedžad Mulabegovic²

¹Public Institution Health Centre of Sarajevo Canton

²Faculty of Medicine University of Sarajevo

Backgrounds & Aim

There are two hundred medical doctors working in the family medicine ward in Canton Sarajevo. They are all employees in the Public Institution Health Centre of Sarajevo Canton.

Aim was to find some characteristics of work organization of family physicians.

Methods

Cross-sectional study based on self-administered questionnaire was distributed to physicians (n=60) working in family medicine ward in Canton Sarajevo.

Results

Total n=41 out of the sixty physicians answered questionnaire. Women were n=33 (81%). Average age was 44 years ($\pm 9,95$). Family physicians in Canton Sarajevo have had in the average 49,6 ($\pm 12,02$) patients per day. Of these n=20 patients were unscheduled through an appointment system. Most of the physicians n=24,8 (50%) scheduled patients in ten minutes slots. There were in the average 5 emergency patients daily per family physician. Family physicians n=37 (93%) performed home visits. Fifteen physicians (37%) often were changing the location of their offices.

Conclusion

Family physician are burdened to receive the high number of patients per day. Also, they are faced with a significant daily number of emergency cases. They are often forced to changing workplace. Despite that fact the vast majority of them perform house calls.

Keywords: family medicine, primary health care, health organization, patients

P-0852

The readability of currently used consent forms and relationship between legibility with the procedure risk

Andrea Nicolás Carrillo¹, Prof. Aurelio Luna Maldonado²

¹Medicina familiar y comunitaria, Unidad docente Costa de Ponent, Barcelona, Spain

²Department of Forensic medicine, University of Murcia, Spain

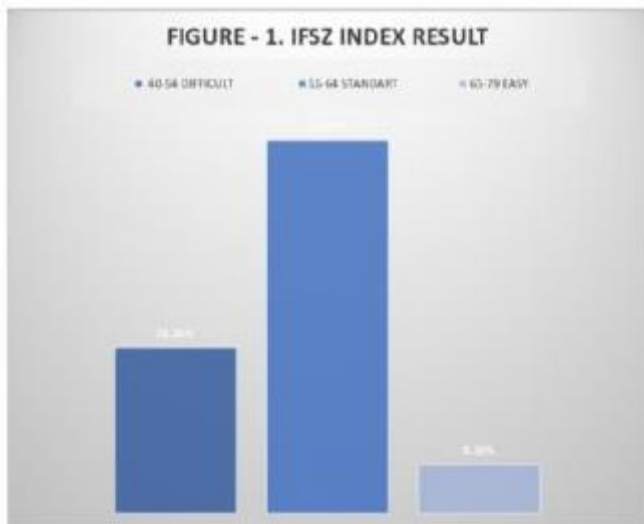
In Spanish hospitals it is not normal to write informed consent documents paying attention to legibility. We are using legibility indices in this study in order to analyze the 156 documents we collected from eight different surgical departments. Our aim is to know how well documented and how useful informed consents documents are for surgical patients from Virgen de la Arrixaca Hospital (HUVA). We also studied if there is a relation between the risks of surgical procedures in relation to the legibility of the consent document.

In order to study the surgical risk associated with surgical procedure we created a table to evaluate three surgical risk parameters.

To determine the relation between surgical procedure risk and informed consent legibility we made a bivariate analysis that shows that when risk increases legibility decreases. As we are working with non-parametric data we made use of Kruskal-Wallis test. Results show that there is an inverse relation between surgical procedural risk and informed consent legibility. This inverse relation is higher for departments which involve a greater risk.

Keywords: legibility, readability, informed consent, document, risk,

IFSZ index result



28,2% has a difficult readability for Flesch-Szigriszt Index (IFSZ). 63,5% of all documents belongs to 55-65 border and it is related to a normal readability. 8,3% from those analyzed documents are easily understood; they are related to a score >65 for IFSZ scale.

Bivariate analysis

	IFSZ	Surgical Risk Score	Fernández- Huerta Index
IFSZ	1		
Pearson correlation		-,210**	,719**
Sig. (bilateral)		,009	,000
N	156	156	156
Surgical Risk score		1	
Pearson correlation	-,210**		-,161*
Sig. (bilateral)	,009		,044
N	156	156	156
Fernández-Huerta Index			1
Pearson correlation	,719**	-,161*	
Sig. (bilateral)	,000	,044	
N	156	156	156

To study the relation between risk index and readability we make a bivariate analysis (table 1). This shows statistically significant results for relation between Flesch-Szigriszt Index (Spearman $r=-0,21$; $P< 0,01$), Fernández-Huerta Index and risk index (Spearman $r=-0,161$; $p<0,05$).

Fernandez Huerta Index Result



35,9% are easy to understand. 55% are related to a normal readability by belonging to 60-70 border Fernández-Huerta Index. 9,1% are difficult to understand.

Contrast statistics

	IFSZ	FH Index	Risk index
Chi-squared	93,536	90,833	93,119
Degrees of freedom	7	7	7
Asymptomatic sig	,000	,000	,000

As we are working with non-parametric data we analyze 156 informed consents by using Kruskal-Wallis test. (table 2) We pretend to study if we can establish a relation between the departments from HUVA and the relation to Flesch-Szigriszt index, Fernández-Huerta index and risk index. We found statistic signification for Kruskal Wallis test with degree freedom 7 for 0,0001

P-0853

Combat Obesity: Affects of Obesity to Fighting Manpower and Military Personnel

Aslan Ozden¹, Unal Demirtas², Yusuf Akyüz³

¹Department of Public Health, Gulhane Military Medical Academy, Ankara TURKEY

²Department of Military Health Services, Gulhane Military Medical Academy, Ankara TURKEY

³Department of Family Medicine, Gulhane Military Medical Academy, Ankara TURKEY

AIM: Worldwide, 2.8 million people die each year as a result of being overweight (including obesity) and an estimated 35.8 million (2.3%) of global disability- adjusted life years (DALYs) are caused by overweight or obesity. Overweight and obesity lead to adverse metabolic effects on blood pressure, cholesterol, triglycerides and insulin resistance. Risks of coronary heart disease, ischemic stroke and type 2 diabetes mellitus increase steadily with increasing body mass index (BMI), a measure of weight relative to height.

METHOD: We made a literature review about "obesity in armed forces."

RESULTS: The rate of BKI>25 in armed forces; Turkey 22%, USA 47%, UK %45, Nigeria %40 and Saudi Arabia 69%. At least nine million 17- to 24-year-olds in the United States are too fat to serve in the military. That is 27 percent of all young adults. Prevalence of overweight and obesity, age 20 and above, male in Turkey is 61% and 24%. This is shown that overweight and obesity is a big problem for armed forces too. Obesity diagnosis of senior officer and sergeant major is more frequency than the young military officer and sergeant. Because of this, senior officer and sergeant major work desk position usually.

CONCLUSIONS: Obesity has negative impact on fighting manpower and manpower planning. Preventive medicine measurements and health promotion must be performed in order to reduce the frequency of obesity and hyperlipidemia which is the main medical disability reason for military personnel.

Keywords: armed forces, obesity, manpower

P-0854

Performance of Hospital Capacity Usage

Esat Veli Karakoç¹, Erdiñ Ünal², Onur Bayazıt³, Bektaş Murat Yalçın⁴

¹Esat Veli Karakoç: Department of Family Medicine, Izmir University, Izmir, Turkey

²Erdiñ Ünal: Department of Economics and Administrative Sciences, Okan University, Istanbul, Turkey

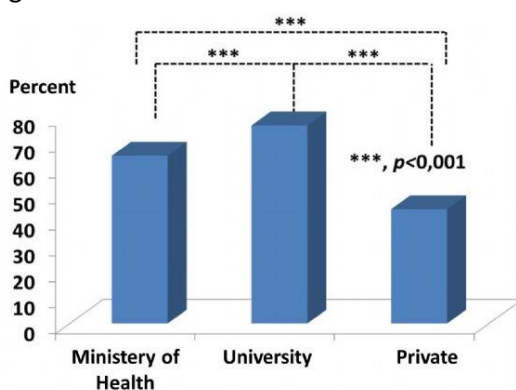
³Onur Bayazıt: Department of Biophysics, Izmir University, Izmir, Turkey

⁴Bektaş Murat Yalçın: Department of Family Medicine, Ondokuzmayıs University, Samsun, Turkey

BACKGROUND and AIM: It is aimed to compare the hospitals which are differentiated according to their ownerships (Ministry of Health, University and Private hospitals) in terms of bed occupancy rate, bed turnover interval, approximate length of stay of in-patients and bed turnover rate, which are indicators of facility usage. **METHOD:** By using the datas of ten years (2002-2011) in the 2012 Health Statistics yearbook, statistical evaluation was performed. Bed occupancy rate, bed turnover interval and bed turnover rate were compared by using Kruskal Wallis test and Mann Whitney U test and approximate length of stay of in-patients was compared by using Kolmogorov Smirnov test. **RESULTS:** Bed occupancy rate of university hospitals is statistically significantly higher than the Ministry of Health and private hospitals ($p < 0,001$). In the comparison of other two hospitals, bed occupancy rate of Ministry of Health hospitals is statistically significantly higher than the private hospitals ($p < 0,001$). There was not statistically significant difference between the three group hospitals in the comparison of bed turnover interval. In the comparison of approximate length of stay of in-patients; it is statistically significantly higher in university hospitals than the Ministry of Health and private hospitals ($p < 0,001$). In the comparison of the bed turnover rates of three groups of hospitals, there was statistically significant difference ($p < 0,01$). The bed turnover rate of Ministry of Health hospitals is higher than university hospitals ($p < 0,05$), the bed turnover rate of Ministry of Health hospitals are similar to private hospitals and the bed turnover rate of university hospitals is lower than private hospitals ($p < 0,01$). **CONCLUSIONS:** It was believed that university hospitals are dealing with different and more complicated type of patients, because of that reason; approximate length of stay of in-patients and bed occupancy rates are higher in university hospitals than the other two groups of hospitals.

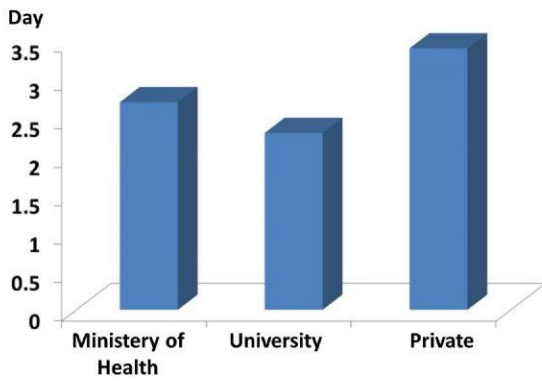
Keywords: Hospital, performance indicators, capacity usage

Figure 1



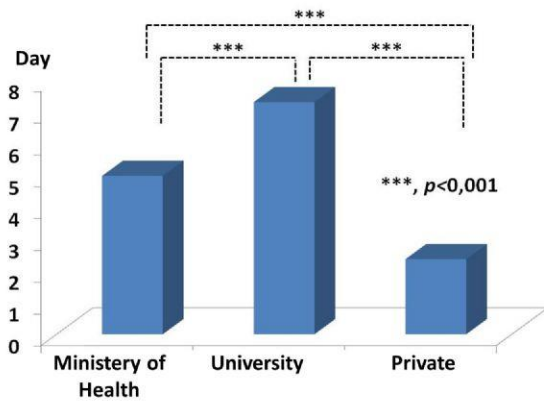
Comparison of bed occupancy rate (%) of Ministry of Health, university and private hospitals between 2002-2011 years (***, $p < 0,001$).

Figure 2



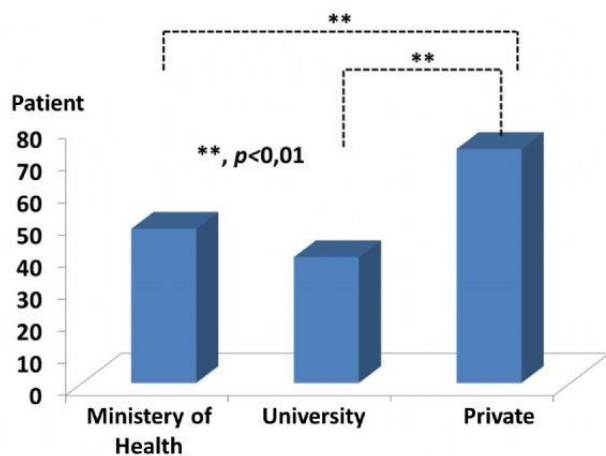
Comparison of bed turnover interval of Ministry of Health, university and private hospitals between 2002-2011 years

Figure 3



Comparison of approximate length of stay of in-patients of Ministry of Health, university and private hospitals between 2002-2011 years (***, $p < 0,001$).

Figure 4



Comparison of bed turnover rate of Ministry of Health, university and private hospitals between 2002-2011 years (**, $p < 0,001$).

P-0855**The impact of teleconsultation in the access of primary care Nephrology services**

Milena Rodrigues Agostinho, Michele Paula Pretto, Rudi Roman, Natan Katz, Erno Harzheim
Telehealth Network of Federal University of Rio Grande do Sul

Background & AIMS: One of the main issues in the Brazilian National Health System are the long waiting lists for specialist services. This can be partially explained by the lack of offer of medical consultations in some specialties. However, the weakness in management and clinical services in Primary Care (PC) play a role in this context. Telehealth is a tool with a great potential to enhance PC resoluteness and to help the referral of ambulatory consultations. These study aims to analyze the effectiveness of teleconsultations in ambulatory referrals to Nephrologists in the city of Porto Alegre.

METHODOLOGY: After analyze the main motives to referral to Nephrologists, we created guidelines to organize the ambulatory referral. The physicians at Referral Complex State (RCS) used the guideline to stablish priority criteria to the appointments and also determined teleconsultations for those motives that could not be referred according to the guidelines. A team of teleconsultant physicians from Telehealth Network of Rio Grande do Sul State (TelessaúdeRS/UFRGS) called PC providers to enquire about the real need of each referral, to support clinical practice and to guide patient's following-up in PC.

RESULTS: Between July 2014 and April 2015, 723 people referred to nephrologists had their referral resolved through teleconsultations. In those teleconsultations, 33.1% of the referrals were maintained with high priority, and 45,3% were cancelled with the agreement of PC providers. The three main motives of teleconsultations were: Chronic kidney disease (55,9%), Renal Cysts (16,3%) e Kidney stone (17,2%).

CONCLUSION: Teleconsultation is a great tool to support the organization of the referral ambulatory system. It also improves the care of people who have to wait for a specialist appointment and enhances the quality of care that should be managed in PC services. The results obtained call for a further analysis of its impact in other contexts.

Keywords: teleconsultation, referral, nephrology

P-0856**Referral guidelines and the organization of the ambulatory referral system**

Milena Rodrigues Agostinho, Josué Basso, Rudi Roman, Natan Katz, Erno Harzheim
Telehealth Network of Federal University of Rio Grande do Sul

Backgrounds & aims. There exist serious issues with the access of specialist treatments in the state of Rio Grande do Sul (RS). Over 164203 patients in the country side of the state are currently waiting for an appointment with a specialist in Porto Alegre, but the system can only offer 10296 appointments per month. The referral system is worsened by the lack of information in the referral process and by the lack of criteria access to specialized service. The Telehealth Network of RS (TelessaúdeRS) is helping to organize the waiting lists of physician specialists in Porto Alegre. **METHODOLOGY:** We have created referral guidelines to organize Primary Care (PC) referrals to specialist services in Endocrinology and Pneumology. The guidelines explain the clinical situations that should be referred to specialists and the minimum information required for ambulatory referrals. The physicians from the Referral Complex State used the guidelines to stablish priority criteria in these two specialties. They also determined teleconsultations for the motives that should not be referred according to the guidelines. **RESULTS:** From 8243 cases in the endocrinology waiting list, 5043 (61,2%) were referred to teleconsultation. The remaining cases were either accepted (presented the necessary referral criteria) or pending (lack of information). The distribution in relation to the guidelines was the following: hypothyroidism (4.9%), diabetes (28.3%), nodule of Thyroid (29.4%) and obesity (10.2%). From 2983 referred cases in Pneumology, 2273 (76.2%) were referred to teleconsultation, with the following distribution: COPD (29.8%), asthma (19.7%), change in laboratory tests (12.8%), chronic cough and dyspnea (18.8%), sleep apnea (17.1%) and smoking (1.7%). **CONCLUSIONS:** Referring protocols are a great tool to improve the quality of information and optimize the work of the ambulatory referral system. When associated with teleconsultation, they can improve access to care and create a lifelong learning environment for PC teams.

Keywords: guidelines; ambulatory referral; teleconsultation.

P-0857

Cluster Management for Primary Care Centers

Neus Parellada Esquiús, Amparo Romaguera Lliso, Carme Aragó Vidal, Maria Jesus Garcia Jordan, Lluïsa Rodríguez Latre, Dolores Ramirez Tarruella, Jordi Torradabella Fabrega

INSTITUT CATALÀ DE LA SALUT; ATENCIÓ PRIMÀRIA COSTA DE PONENT, CATALONIA, SPAIN

AIM: To analyze the distribution or classification into homogeneous groups of Primary Care Health Centers (PCHC), depending on indicators of structure and activity.

METHOD: Descriptive classification into groups of 53 PCHC from Primary Care Costa de Ponent (ICS), Catalonia, Spain, with an assigned population of 1,261,888 inhabitants (December 2014).

Variables used:

-Welfare indicators: (December 2014): EQA (Synthetic indicator of quality of care, used as a clinical management standard in primary care for adult and pediatric population. Data from electronic medical records); EQPF (Synthetic indicator of quality of drug prescription, used as standard in primary care); Chronic diseases (% Clinical Risk Groups 6-7 (GRG)).

-Structure Indicators: MEDEA (deprivation index by census tract in PCHC); Population per health professionals; % of immigrant population ratio; calculated population ratio > 75 years of age.

-Activity Indicators: Visitations at the primary care center and at home per patient/year

Analysis: Descriptive and correlations analysis were performed. Many Cluster analysis with no correlated variables have been studied (Ward method with square Euclidean distance).

SPSS version 21.

Results

We used three statistically significant variables for the cluster analysis (EQA, MEDEA and patients/health professional). Finally, we get five groups, with 13, 13, 16, 6 and 5 PCHC respectively. The first group shows a high mean value of EQA, close to the mean value of patient/professional relationship and close to the mean value of MEDEA result. Group three has a good EQA level, a low patient/professional ratio and a high level of deprivation. Group five has low EQA, more patients per professional and a low level of deprivation.

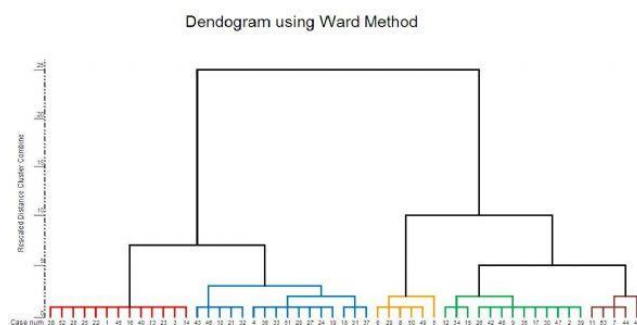
Conclusions

The PCHC are distributed into five groups according to different characteristics in the studied variables. This classification may be used for the management of the PCHC.

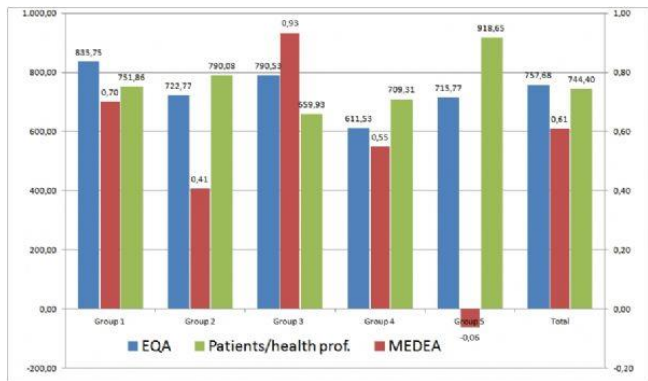
Keywords: Health care quality indicators; Primary care; Cluster Analysis



Dendrogram using Ward Method



Means of the three statistically significant variables for the cluster analysis (EQA, MEDEA and patients/health professional)



P-0858

Evaluation of Causes Application on Medical Board

Ali Ramazan Benli¹, Senay Demir Yazıcı², Onur Yazıcı³, Mustafa Cortuk⁴, Habibe Inci⁵, Neriman Cetin Benli⁶

¹Department of Family Medicine, Medical Faculty, Karabuk University, Karabuk, Turkey

²Department of Physical Therapy and Rehabilitation, KBU Karabuk Education and Research Hospital, Karabuk, Turkey

³Department of Chest Disease, KBU Karabuk Education and Research Hospital, Karabuk, Turkey

⁴Department of Chest Disease, Medical Faculty, Karabuk University, Karabuk, Turkey

⁵Department of Family Medicine, KBU Karabuk Educational and Research Hospital, Karabuk, Turkey

⁶Baglar Family Practice Center, Safranbolu, Karabuk, Turkey

Background & AIM: Disabled patients are admitted to the medical board to determine the disability rate in order to use the occupational, health and social rights in Turkey. According to the law, over 40% of individuals with disabilities, based on the severity of their disability and illness rate, have different rights. We aimed to contribute to epidemiological data on people with disabilities in our country.

METHOD: Between January 2014-December 2014 the records of patients were admitted to the medical board of Training and Research Hospital, and they were analyzed retrospectively.

RESULTS: In the medical board in January 2014-December 2014, 2637 cases were evaluated. 1554 of these patients were male (59%), 1083 women (41%). With the increase of age, the frequency of application increased, too. Maximum application was in the group who are above 65 years of age. The number of cases by over 40% points are 1834 people (69%). 1055 of them were men (40%), 779 were women (29%). Average age is 45. When the cases were evaluated according to the distribution of branches, 975 cases (37%) in musculoskeletal system were identified. The least disability was in Obstetrics and Gynecology with 8 cases (0.3%).

CONCLUSIONS: Quality of life of the disabled population and the quality of services which are offered to them are closely related to the level of development of the society. In order to improve the life quality of disabled people, regional and country wide datas of these people are needed.

Keywords: Disability, Medical Board, Epidemiology

Table 1. Cause and Frequently of Application on Medical Board

Causes	n	%
Disability	2045	77.5%
Pirivate education	276	10.5%
Guardianship	201	7.6%
Retirement due to Disability	73	2,8%
Assigantion	27	1.0%
Driving License for H class	15	0.6%
TOTAL	2637	100%

P-0859

Assessment of the Relationship between Benign Perianal Region Diseases and Smoking Status

Nisa Çetin Kargin¹, Süleyman Kargin², Kamile Marakoğlu³

¹Department of Family Medicine, Tuzlukçu State Hospital, Konya, Turkey

²Department of General Surgery, Nusaybin State Hospital, Mardin, Turkey

³Department of Family Medicine, Selcuk University Medical Faculty, Konya, Turkey

OBJECTIVES: This study is a cross sectional study, and is aimed to evaluate the association between benign perianal diseases and smoking status.

METHOD: The study included 110 patients with benign perianal disease who were smokers, nonsmokers and quit smoking, and demanded to be treated admitted to General Surgery Clinic of Nusaybin State Hospital between April 1st, 2015 and May 1st, 2015. Health questionnaire and physical examination of the patients were performed, and a 16-item questionnaire including VAS (Visual Analogue Pain Score) scores on the first day following the operation, sociodemographic characteristics, smoking habits, comorbidities, number of operations was applied. All the data collected were evaluated by SPSS 16.0 statistics package program.

RESULTS: Of the patients admitted 78.2% were men (n=86), 21.8% (n=24) were female. 13.6% of patients (n=15) were operated from hemorrhoids, 36.4% (n=40) anal fissure, 24.5% (n=27) anal fistula, 6.4% (n=7) the anal abscess, 36.4% (n=40) anal fissure, 19.1% (n=21) were operated from pinoidal sinuses. 37.3% of patients (n=41) never smoked, 62.7% (n=69) were involved in smoking (smokers (n=45), 40.9% stopped smoking (n=24), 21.8%), respectively. The mean VAS score of the patients who never smoked was statistically significantly lower than the mean scores of the patients who were involved in smoking (smoking+quit smoking) (p=0.006). The frequency of recurrence of benign perianal disease in patients operated who were never-smokers was statistically significantly lower than of the patients involved in smoking (smoking+quit smoking) (p=0.026)

CONCLUSIONS: As a result of our study, smoking seems to have an important etiology in benign perianal diseases as in the etiology of many known diseases such as lung diseases, cardiovascular diseases and skin aging. The patients admitted to both family medicine and internal or, surgical clinics should be emphasized that smoking negatively affects the course of the disease and smoking cessation will be beneficial in the healing process.

Keywords: Benign Perianal Diseases, Smoking, Visual Analogue Score

P-0860**Evaluation of Socio-demographic and Smoking Characteristics of Patients Thinking of Quitting Smoking**

Nisa Çetin Kargin¹, Kamile Marakoğlu²

¹Department of Family Medicine, Tuzlukçu State Hospital, Konya, Turkey

²Department of Family Medicine, Selcuk University Medical Faculty, Konya, Turkey

OBJECTIVES: This study is a retrospective type of research, and aimed to evaluate socio-demographic characteristics and thoughts about smoking of the patients who applied to receive smoking cessation therapy.

METHOD: The study included 467 subjects who did not want to get medical treatment but wanted to try quitting smoking by only receiving behavioral changes therapy out of 1778 patients, who applied Smoking Cessation Clinic of Family Medicine, Selcuk University Faculty of Medicine to quit smoking between March 25, 2011- May 1, 2012. The patients were asked their health story and examined. Fagerstrom Test for Nicotine Dependence (FTND), sociodemographic characteristics, smoking related thoughts and CO (carbon monoxide) levels and Beck Depression Inventory scores were assessed. All the data collected were evaluated by SPSS 16.0 statistics package program.

RESULTS: Of the patients admitted (n=467), 84.2% were male (n=393), 15.8% (n=74) female. The mean age was 40.74 ± 11.91 (min=17, max =76), respectively. 81.4% of patients (n=380) were married. FTND average of patients was 6.26 ± 2.13 (min=0, max = 10). 22.6% of patients (BDI 17 and over) had depression symptomatology. 61.2% of patients stated that they smoked in any condition, 20.3% when nervous and demoralized. 15.0 % tried to quit smoking four or more times. 84.8% indicated that they wanted to quit because of health problems. 55.7% of the patients expressed that social environment and friend groups had influence to start smoking.

CONCLUSIONS: The success prevalence of quitting smoking with behavior modification therapy ranges between 2-5%, and this rate rises to 10-80% with medical therapy. The patients who failed with behavior modification therapy were advised to get medical treatment, and the cases with depressive symptoms were advised to receive depression therapy and their follow-up still continues. If the medical treatment costs can be met by SSI, we believe that we can be more helpful to our patients.

Keywords: Smoking, Behavioral Changes Therapy, Medical Therapy

P-0861**Organizational Citizenship Behavior in Health Professionals of Cukurova University Faculty of Medicine**

Zeliha Akman Usguloglu¹, Esra Saatci¹, Efe Efeoglu²

¹Department of Family Medicine, Cukurova University, Adana, Turkey

²Department of Business Administration, Science and Technology University, Adana, Turkey

BACKGROUND and AIM: Organizational citizenship behaviors include voluntary behaviors of employees without any official pressure. The aim of this study is to examine the level of organizational citizenship behavior and related socio-demographic factors in health professionals of Cukurova University Faculty of Medicine.

METHODS: A socio-demographic questionnaire with 13 items and Organizational Citizenship Behavior Scale with 20 items were completed by 180 health professionals. Data was installed and analyzed using SPSS statistical pocket program version 16.

RESULTS: Of participants, 64.5% (n=100) were female and 35.5% (n=55) were male. There was a significant relationship between number of children and courtesy (p=0.0001), conscientiousness (p=0.004), altruism (p=0.005), civic virtue (p=0.0001), and sportsmanship (p=0.032). Marital status was significantly related to civic virtue (p=0.033). Occupation was significantly related to altruism (p=0.006), sportsmanship (p=0.013), courtesy (p=0.011) and civic virtue (p=0.0001). Working hours (day or night) were significantly related to altruism (p=0.002) and sportsmanship (p=0.002). The highest score was in courtesy and the lowest was in civic virtue.

CONCLUSION: Organizational citizenship behavior subscales were related to socio-demographic details of health professionals.

Keywords: Organizational, citizenship, behavior, altruism

P-0862

Knowledge, Attitude and Behavior of Health Care Employees about Their Family Doctors

Fikret Merter Alanyalı, Berk Geroğlu, Yasemin Kılıç Öztürk, Yusuf Adnan Güçlü

Tepecik Education and Research Hospital, Clinic of Family Medicine, Izmir, Turkey

OBJECTIVE: Family medicine is a unique scientific discipline and a primary care oriented clinical specialty that has its own educational content, researches, evidence based and clinical practices. There are family medicine specialists(FMS) and general practitioners(GP) working at the primary care, in Turkey. In this study, health care employees' knowledge, attitude and behavior about their family doctors(FD) is intended to identify.

METHODOLOGY: The study was cross-sectional. Health care employees working at a tertiary hospital were asked to fill up a questionnaire created by researchers in November 2014. After sampling, randomisation and confirmation the questionnaire was applied face to face.

RESULTS: Two hundred and twenty-eight participants were included in the study and 72.8% (n: 166) were women, 32.5% (n: 74) were doctor, 35.5% (n: 81) were nurse and 32.0% (n: 73) were other health care employees. Participants stated that 73.2% (n: 167) know their FDs in person and 26.8% (n: 61) of them did not know. Other data about health care employees' responses and knowledge about their FDs shown in Table 1.

"Do you think that you have enough admission to your FD?" questioned and 71.9% (n:164) replied that they don't admit enough. According to answers, participants' faithfulness to their FDs about solving health problems was 54.4% (n:124) and %72.8 (n:166) participants were not going to their FDs at first if they have a health problem. As compared that if they have a GP or FM specialist, there was a significant difference ($p<0.05$) about Health care employees' attitude and behavior about their FDs has shown in Table 2.

CONCLUSION: Clinical ability and doctor-patient communication are some of the targets of family medicine specialization program. Family medicine specialization must be one of the primary goal for health policies to improve health care employees faith, knowledge, attitude and behaviour about FDs.

Keywords: Family medicine, specialization, education, residency, general practitioner

Table 1: Health care employees' knowledge about their FDs.

		n	%
Family doctor assigned by	Participants choice	58	25,4
	Health system	170	74,6
Is your family doctor GP or FM specialist?	GP	51	22,3
	FM	72	31,6
	No opinion	105	46,1
Did you ever admit to your family doctor?	Yes	151	66,2
	No	74	32,5
	I don't remember	3	1,3
Do you live in the same city with family doctor?	Yes	177	77,6
	No	23	10,1
	I don't know	28	12,3

Table 2: Health care employees' attitude and behavior about their GPs or FM specialists

	FM Specialist		GP		Unknown		Total		p
	n	%	n	%	n	%	n	%	

Do you have admission to your FD in the last year?	Yes	33	64,7	36	50	28	26,7	97	42,5 57,5	0,0001
	No	18	35,3	36	50	77	73,3	131		
Do you feel faithful to your FD about solving health problems?	Yes	40	78,4	34	47,2	50	47,6	124	54,4	
	No	5	9,8	22	30,6	19	18,1	46	20,2	0,0001
	I don't know	6	11,8	16	22,2	36	34,3	58	25,4	
Do you go to your FD at first if you have a health problem?	Yes	20	39,2	13	18,1	29	27,6	62	27,2	0,03
	No	31	60,8	59	81,9	76	72,4	166	72,8	
Do you talk with your FD comfortably?	Yes	39	76,5	41	56,9	54	51,4	134	58,8	0,001
	No	12	23,5	31	43,1	51	48,6	94	41,2	
Did you choose your FD yourself?	Yes	19	37,3	23	31,9	16	15,2	58	25,4	0,04
	No	32	62,7	49	68,1	89	84,8	170	74,6	

European Definition of Family Medicine



P-0863

Learning from Europe – Would an alternative healthcare model benefit general practice in the UK?

Clare Wilson

Severn Deanery UK

Background

The healthcare system in the United Kingdom is based on the 'Beveridge' model of tax funding providing 'free at the point of delivery' care, delivered by the National Health Service (NHS). Alternate methods in use across Europe include the 'Bismark' model of compulsory national insurance, and other private voluntary insurance schemes (1).

The ongoing funding of healthcare in the UK is currently a subject of significant debate (2), with focus on the future of General Practice(3). This has caused concern amongst healthcare workers, who often feel a lack of representation (4).

This study aimed to identify the views of General Practice doctors (GPs) on the future of UK healthcare and possible alternate funding methods used elsewhere in Europe.

Method

An anonymous online survey was distributed via email to GPs & Doctors in training working in Bristol, and received 75 responses. This asked participants to rate 20 statements on a 5-point Likert scale from 'Strongly Disagree' to 'Strongly Agree'.

Results

There was a significant positive response ($p < 0.01$) for maintaining a 'free at the point of delivery' service based on taxation (49%), a need for change in the NHS (87%), deeming the current service cost effective (59%), and introducing fines for missed GP appointments (67%).

There was a significant ($p < 0.01$) negative response for introducing fees for GP appointments (56%), paying for healthcare up front (75%), introduction of compulsory health insurance (37%), introduction of voluntary private insurance (71%), and healthcare as a party political issue (51%).

Conclusions

This survey demonstrates a belief amongst GPs that significant change is needed in the UK healthcare system. There is support for financial penalties for missed appointments, however the majority were in favour of a taxation based, and 'free at the point of delivery' system, with significant opposition to an insurance model.

SEE END FOR REFERENCES

Keywords: "General Practice", "Public Opinion", "European Union"

Figure 1

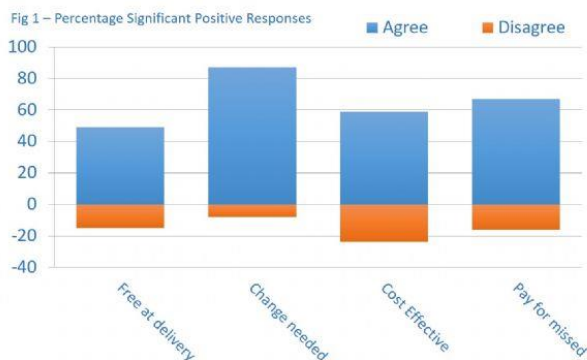
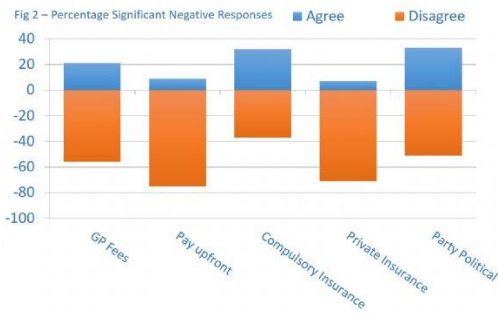


Figure 2



P-0864

The Satisfaction Levels of Patients in Dumlupınar University Hospital

Yasemin Korkut, Ferhat Yiğit

Department of Family Medicine, Dumlupınar University, Kutahya, Turkey

AIM:

The aim of this study was to determine various aspects of both satisfaction levels and related socio-demographical variables of patients.

MATERIALS-METHODS:

This study has been done to evaluate the patients acknowledgement levels of the service and their expectations. 100 individuals accepting participate in this study have been interviewed.

In this evaluation, 100 patients were questioned with 14 different questions. We also determined some imperfection of our hospital related to maintenance services, nursing and physician-patient interactions.

RESULTS:

56% of patients were female, 44% of them were male and average age was 38,1. While 37% of the patients were waiting to take their turns, 23% of them were waiting for analysis and examination. 48% of the patients were pleased with the hospital service, 44% of them were pleased with the nurses and the other hospital personnels' behaviors and 60% were pleased with the doctors behaviours. 58 of the patients implied that the doctors gave enough information about their illnesses. This showed a meaningful relation between the satisfaction with the doctor's behaviour and the information about the illness given by the doctor. 48% of the patient group thought that satisfactorily attention was given to the patient privacy by the hospital. 40% of the patients were pleased with the sanitation and tidiness at the hospital, 42% of the patients believed that doctors did their best to diagnose their illnesses. 55% of the patients stated that they were pleased with the hospital services, 56% of them were pleased with the nurses and the other hospital personnels' behaviours, 66% of them were satisfied with the doctors' behaviours.

CONCLUSION: Patients are generally accepted as an indicator of service quality. For that reason, it is essential to take it into consideration. There is a linear relationship between Socio-economic status and patient satisfaction.

Keywords: Patient, patient satisfaction, quality, hospital

P-0865

Population potentially excluded from health coverage since the Royal Decree 16/2012 and its health impact in Catalonia

Dolors Comet, Joan Pau Millet, Dolores Alamo, Lluïsa Ortega, Núria Sala, Josep Vidal
EAP Plaça Catalunya. Gerència Territorial Catalunya Central. Institut Català de la Salut. Manresa (Spain)

BACKGROUND: in order to reduce costs to the National Health System (NHS), Royal Decree -Law 16/2012 has restricted the right to health care of the immigrant population in Spain. Unauthorized foreigners or not registered as legal residents, will only receive not emergency care only if they are under 18 or pregnant women.

AIM: To determine the proportion of the population of Catalonia potentially excluded from health coverage since the Royal Decree 16/2012 (RD), to describe the use of health services, the distribution of disease and health and drug expenditures in Catalonia (2011-2013).

Design: a population based retrospective cohort study at primary care (PC).

Setting: primary care in Catalonia

Subjects: Catalonia residents assigned to the PC Catalan Institute of Health (ICS).

Variables: Sociodemographic, chronic and infectious disease, use of health services and medical expenditures variables will be studied and compiled from the Information System for the Development of Research in Primary Care (SIDIAP).

Statistical analysis: descriptive data, χ^2 test with significance level of <0.05 . Survival analysis, Kaplan- Meier curves compared by Log-rank test will be performed. At multivariate level, Cox regression and Hazard ratio with 95% CI will be calculated.

Expected RESULTS: the excluded population by the RD, has less chronic disease, are less visited in PC and emergency, they has fewer drug expenditures but increased incidence of infectious diseases.

Limitations: Even if only ICS population is included, data from SIDIAP is a good approximation of the entire population. It does not include people with incomes $>100,000$ euros/year or who have never been in contact with the health system.

Keywords: Immigrant population, Health policies, Catalonia Spain

Previous study central Catalonia 2012



Original

Población potencialmente excluida de cobertura sanitaria con el Real Decreto 16/2012 y sus repercusiones sanitarias: la experiencia desde la Cataluña Central

Potentially excluded population from health coverage and health impact since Royal Decree 16/2012: The Central Catalonia experience

Dolores Álamo-Junquera^{a,b}, Núria Sala^{a,b}, Joan-Pau Millet^{a,b,c},    , Lluïsa Ortega-Gutiérrez^b, Albert Planas-Giner^b, Carol Rovira^b, Dolors Comet^d

P-0866

The GPs' role for encouraging blood donation based on donors' information seeking preferences

Foivos Evangelos Kakavitsas¹, Petros Kostagiolas², Anestis Chanos³, Dimitrios Niakas³

¹Health Center of Aghios Athanasios, Kerkyra - Greece

²Ionian University Kerkyra - Greece

³Hellenic Open University, Patras - Greece

Background & Aim

Blood donation (BD) is essential for every healthcare scheme; while the demand for blood increases. BD policies aim at reducing uncertainties and misconceptions regarding the alleged risks of BD. This essentially includes utilization of various channels of information for informing the communities for BD. Although internet plays a significant role people still heavily trust their physicians for health information. GPs are closely related to their patients' communities and their rather unique placement in the primary care makes them build long term relationships with their patients. This paper aims at the GPs' role for awareness and encouragement towards blood donation. This endeavor is grounded on the information seeking preferences and information needs of blood donors.

Method

The survey took place in 2014 through a questionnaire informed by Wilson's macro-model for Information Seeking Behaviour (ISB) to investigate the importance of BDs' information needs, utilization of information resources, and importance of obstacles during information seeking. A total of 352 individuals participated in this survey and the statistical analysis performed includes descriptive and inferential statistics for the group categories and associations of different categories. The questionnaire had a good internal consistency with Cronbach alpha 0.914.

Results

The results outlined the fact that the main needs for information are related to BD process; preferred information resources are GPs and the internet; while the abundance of information in the internet is the main barrier. Furthermore, certain demographic factors such as age are indicated as significant with respect to BDs' information seeking behavior preferences.

Conclusions

The research concludes that the donors' ISB facet is important and can inform policies for BD. We argue that GPs involvement is an essential condition for awareness enhancement towards BD and that GPs can guide the communities by presenting a range of online and offline trusted information resources for BD encouragement.

Keywords: information behavior, information seeking behavior, information sources, information needs, transfusion center, blood donor, internet.

P-0867

The Ottoman's Family Physicians: "Memleket Hekimleri" at 1871

Tarık Eren Yılmaz¹, Tuğba Yılmaz², Rabia Kahveci², Adem Özkara²

¹Department of Family Medicine, Centre of Mamak public health, Ankara, Turkey; Department of History of Medicine and Medical Ethics, Hacettepe University, Ankara, Turkey

²Department of Family Medicine, Ankara Numune Training and Research Hospital, Ankara, Turkey

Background and Aim

Family medicine is a modern discipline that provide prevention and treatment of disease. Public health also is in their subject. Early recognition of any epidemic outbreak and continuing medical care must be done with this discipline. Immunization is also another topic in their practice. Initial assessment to the management of all health problems. Family physician also must have comprehensive and holistic approach to all these situations. Family physician is primarily responsible for health services administration in their local area. In brief a total health care responsibility from the first contact to the social and environment health report must be well- managed by family physician at where they appointed.

All these definition and job descriptions were also made by Ottoman Empire at 1871 by a regulation called "İdare-i Umumiye-i Tıbbiye Nizamnamesi". At this general administration of medical regulation there was a type of provincial doctor called "Memleket Hekimi" which was very similar job description of this century's family physicians.

So we aimed to find similarity between modern family medicine practice and Ottoman's provincial physicians' approach by comparing the job definition in their official regulation.

Method

Definition and management of primary care will be compared each other in their regulations. By this we can look how the Ottoman Empire establish their primary health institutions during the 19th century.

Results and Conclusion

The study is still running and the findings are expected to be presented during the conference. The findings would be expected to give us an idea about how civilian health services were established to the Ottoman provinces and rural areas after the opening of the Civilian School of Medicine in İstanbul, how new graduates who were appointed from the center were offered compulsory service to the local region and how the policy of primary care were done.

Keywords: Provincial physicians, Ottoman health services, Regulations of primary care, History of family medicine

P-0868

Family medicine for universal health coverage: The case of the health transformation programme in Turkey

Ana Belen Espinosa

Centre for Global Health, Trinity College Dublin, Ireland

Background & AIM:

This study aims to recognize the improvements and difficulties in the Primary Care (PC) service encountered by Family Physicians (FP) and academicians after the implementation of the Family Medicine Programme (FMP) in Turkey. The FMP embraced changes in the organization of the PC service as well as modifications in the training of PC physicians.

METHOD:

This is a qualitative study based on semi-structured interviews analysed through thematic methodology. The purposive sample consisted of 7 family physicians working in family medicine service and 8 academicians involved in family medicine training or undergraduate education at medical schools.

RESULTS:

The themes were classified following the framework of structure, process and outcomes to approach the primary care system. In the structure level, family physicians and academicians maintained that better public recognition

of the status of the FP specialist, increased FP income, and the systematic establishment of FP functions were the positive aspects of the FMP. However, both FPs and academicians regretted that family medicine stakeholders were not invited in the whole design and implementation of the programme and that their feedback were not appropriately taken into account to overcome the difficulties encountered after the implementation. The high workload of FPs and the negative performance-based payment system were also a motive of concern. In the process level, almost all interviewees agreed that the accessibility and continuity of healthcare have improved. They highlighted the importance of the establishment of a referral chain to increase the efficiency of the service.

CONCLUSIONS:

The FMP improved the accessibility and continuity of PC in Turkey, which are essential attributes in a strong PC service. This can be enhanced by involving family medicine stakeholders in the health policy-making process and improving integration and coordination of PC in the health system to allow the implementation of gatekeeping function.

Keywords: family medicine, health transformation programme, Turkey

Figure B1. Health system pyramid

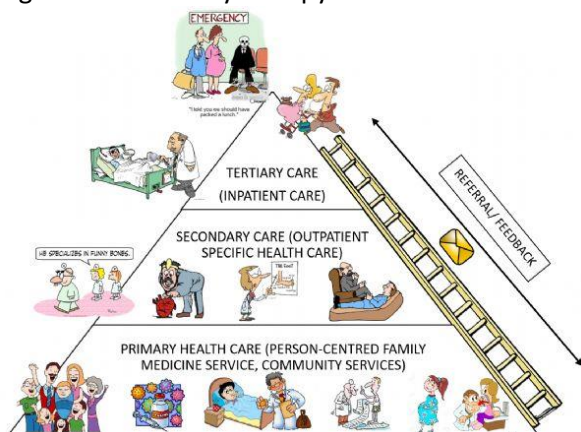


Figure R1. Qualitative analysis results

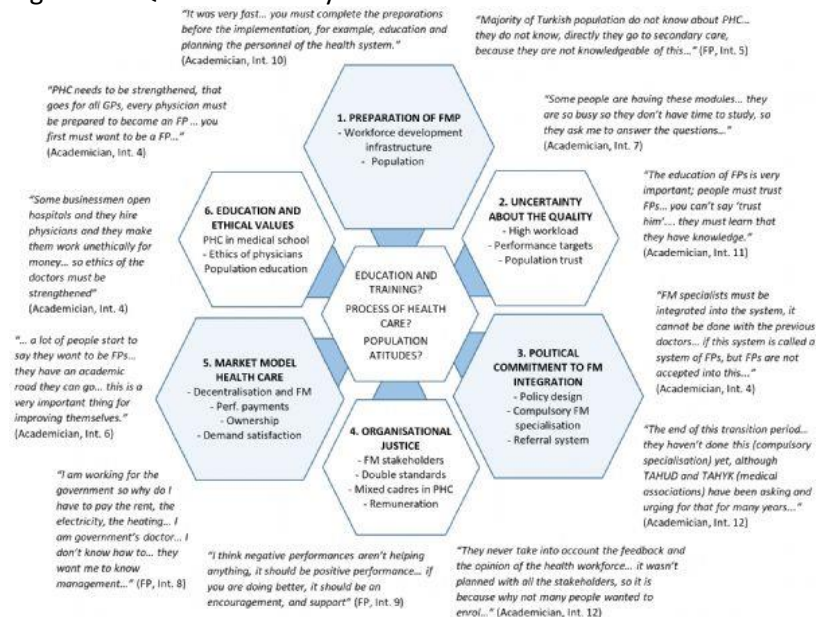


Table M1. Summary of semi-structured interview questions

1 What are the main subjects in the FPs adaptation programme/FM specialisation programme?

- 2 Have the FPs skills and clinical practice improved after the FMP?
- 3 What are the main contributions to FPs high workload?
- 4 What do you think about the referral system? What are the limitations for its implementation?
- 5 What are the population's attitudes towards the PHC service after the FMP?
- 6 What are the most positive points of the FMP (for FPs and population)?
- 7 What are the most negative points of the FMP (for FPs and population)?
- 8 What interventions would you have implemented in order to improve the PHC in Turkey?

Table R1. HMR 2010

Model	R	R square	Adjusted R square	R square change	F change	Sig. F change	ANOVA F	ANOVA sig.
1	0.811	0.657	0.581	0.657	8.633	0.008	8.633	0.008
2	0.918	0.843	0.784	0.186	9.452	0.015	14.310	0.001

Predicted variable: Per capita hospital visits
 Predictor variables: Model 1: Gini coefficient, Over 65 year old population
 Model 2: Gini coefficient, Over 65 year old population, Per capita PHC visits

Figure B2. PHC evolution timeline

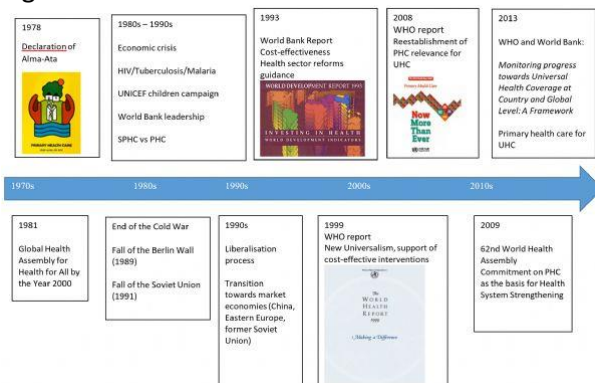


Table R2. HMR 2010 coefficients

Model		Unstandardized	Standardized		Sig.	Correlations			Collinearity		
		Coeff.	Coeff.	Beta		Zero-order	Partial	Part	Tolerance	VIF	
		B	Std. Error								
1	(Constant)	3.121	2.060		0.164						
	Gini coeff.	-0.83	4.586	-0.005	0.986	-0.614	-0.06	-	0.430	2.323	
	Over 65 year old	0.151	0.056	0.807	0.024	0.811	0.671	0.529	0.430	2.323	
2	(Constant)	3.448	1.483		0.049						
	Gini coeff.	0.398	3.297	0.026	0.907	-0.614	0.043	0.017	0.429	2.328	
	Over 65 year old	0.223	0.046	1.193	0.001	0.811	0.862	0.675	0.320	3.126	
	Per capita visits to PHC facilities	-0.404	0.131	-0.563	0.015	0.192	-0,736	-	0,431	0.585	1.710

Figure B3. FMP interventions

	State-owned health centres (sağlık ocağı)	Non-specialised general practitioners ("pratisyen doktor"), midwives and health assistants	Community Health Centres (CHC): family planning, immunizations	State-Salaried health care workforce	Community-based health care	Demographic and epidemiological indicators collected by CHCs in their corresponding coverage area
PRIOR TO FMP						
AFTER FMP	FMP physician's ownership. Management of health facility/staff 	FMP specialised physician responsible for FMP units: Adaptation programme ("pratisyen doktor" and other branches) 	CHC: supervision of performance and facility indicators of FMP units 	Contract: basic capitation payment + performance variation 	Person-centred health care: patient assignment list. 	Family Medicine Information System (FMIS): record of performance indicators collected by FPs 

P-0869

Employee Satisfaction in Hospitals with Afilyasyo; Sample of Training and Research Hospital of University of Muğla Sıtkı Koçman

Nazlı Ülger¹, Ercan Baldemir², Betül Battaloğlu Inanç³

¹Muğla Sıtkı Koçman University, Faculty of Science

²Muğla Sıtkı Koçman University, Faculty of Medicine, Biostatistic Department

³Muğla Sıtkı Koçman University, Faculty of Medicine, Family Medicine Department

OBJECTIVE: To determine the factors of which affect the employee satisfaction and has a an important role in giving qualified and efficient servise in Muğla Sıtkı Koçman University Training and Research Hospital where affiliation is applied.

METHODS: Questionnaire form was made to Muğla Sıtkı Koçman University Training and Research Hospital employees. The data in the research taken from the questionnaires were transferred to SPSS for analysis. As statistical analysis; reliability analysis and comparative analy-sis of the average one way analysis of variance (ANOVA) analysis was per-formed. **RESULTS:** According to results, verbal, mobbing and physical every kind of effect on burn out dimensions and unsatisfied, emotional exhaus-tion and depersonalization. Additionally, these conditions, has directly effect on job satisfaction and working cooperation.

CONCLUSIONS: There is burn out syndrome between health employees' different dimensions and levels. As a result, contribute directly to beter patient services will be, it is suggested pay attention to improve working conditions and welfare of health employees, highlight the importance the employees in terms of institutions and com-munity and development of social status of employees.

Keywords: Afilyasyo; Health Businesses; Employee Satisfaction; Muğla Sıtkı Koçman Uni-versity

P-0870

Existing Problems of Family Medicine Practice in Turkey

Müslüm Aslan

KARAHÖYÜK FAMILY HEALTH CENTER

From the date of the pilot study of family medicine, till the transition to the implementation over Turkey, adequate solutions couldn't found to the problems by the 13th December 2010. New problems were added to the old ones and many problems remain unresolved or current has continued with insufficient solution. I have observed in Family Health Center I worked actively over the last 2 years, and other family physicians and family health workers actively try to identify the personnel of voiced my problems. This is what the family medicine practice more sustainable issues, it is difficult to predict.

Detected problems

1. Precarious work, not to organize in favor of personal rights and pensions
2. With the excess workload, which is a non-criminal punishment in other occupational groups / warnings to be of points
3. Reservations due to the increased potential malpractice in the professional practice of physicians
4. Annual leave issues, the inability to use annual leave without the mandate, the attorney fee when used as cut
5. There is no administrative staff physician in the family health center to be demolished in the administration, to the work of the officer physicians
6. No borders for responsibility and mission: judicial duties, duty of family health centers, commissioning, training
10. Social Security Institution payments treatment limitations, unpaid drugs, restrictions on the branches of some drugs
90. Lossing the existing rights of family medicine specialists and education assistants

Opinion: The specified as soon as possible long-term solutions must be found for the problems. Developed in consultation with existing applications and provide quality services to workers in the field project should be carried out. The application must be made to provide better quality of service should be beyond daily politics and daily politicians. Field vision should be investigated and assessed periodically.

Keywords: family medicine, turkey, problems

P-0871

IKCU Atatürk Training and Research Hospital One Year Outpatient Clinic Profile

Utku Eser¹, Doğukan Doğan², Ecem Pars², Yunus Utkan², Bektaş Yılmaz², Murat Tozman², Kurtuluş Öngel³

¹IKCU Atatürk Training and Research Hospital Directorate

²Izmir Katip Çelebi University, Faculty of Medicine

³Izmir Katip Çelebi Üniversitesi, Faculty of Medicine, Department of Family Medicine

AIM: In this study, it was aimed to reveal the outpatient population and clinical profile of Izmir Atatürk Education and Research Hospital for 2014 year.

MATERIAL-METHOD: Study was performed by medical students of Izmir Katip Celebi University between March-May 2015. It was designed as a retrospective data analysis. The study population consisted of 1415770 patients who were admitted to hospital in 2014. The data were provided from the statistics unit of the hospital after the approval of the directorate. Data were analyzed by MS Excel programme by the study group.

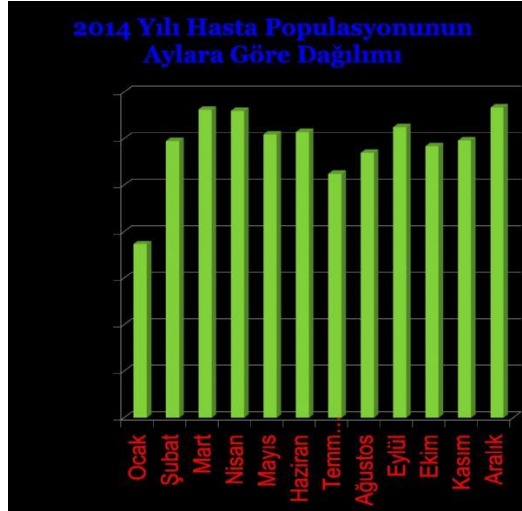
FINDINGS: Number of the patients in the scope of the study was 141577 million and 563170 people (40%) were male, 852600 (60%) were female. Maximum patient number was in december (133306) and minomum patient number was in January (74560). Applications were mostly made to the emergency medicine, internal medicine, dermatology, neurology, ear-nose-throat, physical therapy and rehabilitation clinics. Mostly encountered diagnosis were malaise-fatigue, essential (primary) hypertension, extremity pain, non-insulin dependent diabetes mellitus and pregnancy. Total 726 doctors (25 professor, 87 associate professor, 307 specialist, 307 research assistant) served health service for these patients. Mostly crowded unit was internal diseases with 60 physicians.

DISCUSSION: It can be said that Izmir Ataturk Training and Research Hospital is one of the largest hospitals according to the annual total number of inspections (n:141577 million). When we analyzed the data of 2014 patients with 60% women and 40% men; it was considered worthy of study. December was the most intensive

month related with the seasonal changes. As an expectal condition; most of the references were to the emergency department. However, the high numbers of emergency patients brings ming the abuse by non-urgent patients. Mostly encountered diagnosis were malaise-fatigue. This situation is the same in different studies so we must be alert with this diagnosis.

Keywords: Analyze, patient, doctor, statistics.

2014 yılı hasta popülasyonu



P-0872

Latest Two-Year Analysis of Patients Applied to Prisoners Policlinic

Utku Eser¹, Merter Alanyalı², Kurtuluş Öngel³

¹İKÇÜ Atatürk Education and Research Hospital Directorate

²İzmir Tepecik Education and Research Hospital, Clinic of Family Medicine

³İzmir Katip Çelebi University, Department of Family Medicine

AIM: Related with the opinion that most of the prisoner patients in a third step hospital can be diagnosed and treated with primary care doctors; this study was designed to detect the situation and investigate the factors that vary between years.

METHOD: This retrospective study, aimed to determine the diagnosis of patients admitted to the prisoner department, was performed with 34130 patients who were admitted to Izmir Katip Celebi University Atatürk Education and Research Hospital within 2014 and the first 7 months of 2015.

FINDINGS: When the diagnoses were examined; 11403 (33.4%) were of interest to primary care patients and the most common diagnosis was [7845 (68.7%)] pain (muscles, joints, etc.). Other diagnoses in order of frequency were; porter inspection, hemorrhoids, gastritis, malaise-fatigue, seasonal allergies, cystitis, dizziness, anemia, acne vulgaris, cough, constipation and respiratory tract infections. In 2014 year, 21897 patients and in the first 7 months of 2015 12233 patients; about 100 patients per day were inspected. When diseases related with primary care were investigated; monthly rankings were not variable but according to years porter examination in 2015 was 271 (4.2%) patients, while it was 608 (12.1%) for 2014, nearly three-fold increase.

RESULTS: Prisoners clinics were places, established for the convenience of the enforcement personnel and medical personnel protection. However, around 100 patients per day has been shown to be examined. These patients, if it continued, can not be evaluated under appropriate conditions. However, many patients may be treated in the first step (prison family physician). We anticipate that such patients can be directed to family physicians and health care burden can be reduced in order to provide tertiary health services in appropriate conditions.

Keywords: prisoners, porter, examination

P-0873

An Innovative Interprofessional Education Course at Eastern Virginia Medical School

Jeffrey Allen Johnson

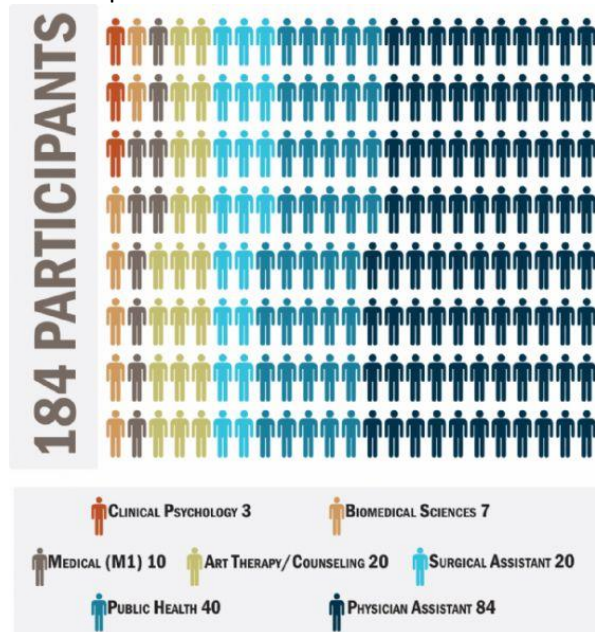
Eastern Virginia Medical School

Eastern Virginia Medical School (EVMS) is an academic health center dedicated to achieving excellence in medical and health professions education, research and patient care. EVMS enrolls ~1300 students in 13 degree programs based within our School of Medicine and School of Health Professions. During this academic year we are implementing a 1-credit interprofessional education (IPE) course involving 200 students from 8 diverse disciplines including medicine, physician assistant, surgical assisting, art therapy, clinical psychology, public health, and biomedical sciences. Students convene for six 2-hour sessions using didactic and case-based learning combined with breakout sessions for 20 groups of 10 students each. Each session has learning objectives and assigned readings that correspond with four major competency domains: values/ethics, professional roles, communication, and teamwork. Case topics include an overview of TeamSTEPPS, diabetes, cancer, Alzheimer’s Disease, sexually transmitted diseases, and epidemics.

Each session is guided by an expert presenter, and the topics are explored from a research, patient care, and population health perspective. Faculty members from multiple backgrounds facilitate the small groups. Formative and summative evaluation protocols are used to assess student and faculty perceptions of each session and the overall value of the course. Students will also complete a pre- and post-test documenting their knowledge and views about IPE. Next year we will add 150 first-year medical students to the course, and possibly students from other schools in the future. Our goal is to ensure that students have exposure to and meaningful engagement with their peers in other programs/disciplines. If successful we may attempt to expand the course to a regional model that will include multiple universities that offer graduate level health professions education, and possibly to the region's primary community college.

Keywords: Interprofessional education, interdisciplinary education, interprofessional collaborative practice, multidisciplinary education

A Participants



B Course Topics

2015-2016 COURSE TOPICS



C Course Competencies

COURSE COMPETENCIES

VALUES & ETHICS

Work with individuals of other professions to maintain a climate of mutual respect and shared values.

ROLES & RESPONSIBILITIES

Use the knowledge of one's own role and those of other professions to appropriately assess and address the healthcare needs of the patients and populations served.

COMMUNICATION

Communicate with patients, families, communities, and other health professionals in a responsive and responsible manner that supports a team approach to the maintenance of health and the treatment of disease.

TEAMS & TEAMWORK

Apply relationship-building values and the principles of team dynamics to perform effectively in different team roles to plan and deliver patient/population-centered care that is safe, timely, efficient, effective and equitable.

Digital Poster

School of Health Professions
Interprofessional Collaborative Education (ICE)

DEFINITION
Interprofessional education (IPE) is the process by which students from two or more professions learn about, from, and with each other to enable collaborative practice to improve or develop health care for the population.

BACKGROUND
The School of Health Professions at Eastern Virginia Medical School is committed to interprofessional education and collaborative practice. This program is designed to provide students with a collaborative and interdisciplinary approach to learning.

2015-2016 COURSE TOPICS

- UNCONSCIOUS BIAS & CULTURAL COMPETENCIES
- VALUES & ETHICS
- COMMUNICATION
- PERSONALITIES, TEAMS & LEADERSHIP
- PATIENT SAFETY & ADVOCACY

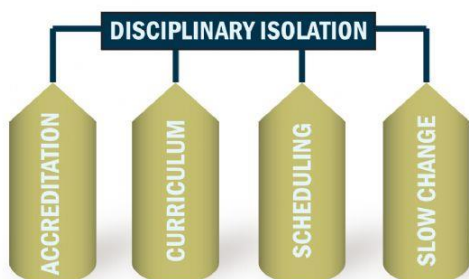
COURSE COMPETENCIES

- VALUES & ETHICS**: Work with individuals of other professions to maintain a climate of mutual respect and shared values.
- ROLES & RESPONSIBILITIES**: Use the knowledge of one's own role and those of other professions to appropriately assess and address the healthcare needs of the patients and populations served.
- COMMUNICATION**: Communicate with patients, families, communities, and other health professionals in a responsive and responsible manner that supports a team approach to the maintenance of health and the treatment of disease.
- TEAMS & TEAMWORK**: Apply relationship-building values and the principles of team dynamics to perform effectively in different team roles to plan and deliver patient/population-centered care that is safe, timely, efficient, effective and equitable.

STRUCTURE & FORMAT

- Students will receive 1 credit hour.
- Each year will have different learning objectives and topics, and be delivered in various formats.
- Students will receive 1 credit hour of CEU credit for this program.

Disciplinary Isolation



P-0874

Medical students' knowledge and concerns regarding sports doping: An observational study

Lana El Osta, Hassan Tarhini, Nazek Saadallah, Nada El Osta

Department of Public Health, School of Medicine, Saint-Joseph University, Beirut, Lebanon

BACKGROUND AND AIM: Doping in sport is a large and dangerous phenomenon. It is often undetected by physicians, and its complications ignored by young people. This study aimed to explore the level of knowledge of Lebanese medical students regarding sports doping.

METHODS: An observational cross-sectional study was conducted at a major Lebanese medical school in 2013. Data were collected through an anonymous structured self-administered questionnaire distributed to all medical students (n=579). This questionnaire assessed participants' knowledge in 5 areas of sports doping: its definition, magnitude and negative effects, as well as prohibited performance-enhancing substances and types of population affected by doping.

RESULTS: A total of 505 valid responses were obtained generating a response rate of 87.2%. Only 5.5% were absolutely unaware of doping. The overall level of knowledge on doping was relatively modest: the mean score of all respondents was 20.23 ± 7.51 ; while 56.9% had a global score more than 20 over 40. According to the multiple regression analyses, factors significantly associated with a higher score were: higher medical classes (-p-value<0.0001), participation in national competitions (-p-value=0.022), participation in competitions of sport clubs (-p-value=0.040), and having been asked to provide information on doping (-p-value=0.044). Moreover, most medical students (89.3%) did not know the meaning of WADA (World Anti-Doping Agency); 85.7%, 88.9% and 93.9% considered respectively that vitamins, energy drinks and proteins are prohibited performance-enhancing substances. Anabolic steroids and stimulants were the most recognized illicit drugs. Only 25.2% of participants were satisfied with their knowledge, while 61.2% were concerned about sport doping prevention. The majority (90.1%) considered that primary care physicians are actors in the field of anti-doping activity.

CONCLUSIONS: Our study revealed a deficient knowledge regarding sports doping among Lebanese medical students who are interested in anti-doping counselling. Thus, professional training strategies to increase their awareness and knowledge are required.

Keywords: Sports Doping, Performance-Enhancing Substances, Medical Students, Knowledge

Medical students' knowledge regarding sports doping (N = 505 participants)

1. Definition of sports doping (7 items)	Percentage of correct answers
- Is the use of certain chemical substances or of methods	84.6%
- Improves athletic performance	76.8%
- Is used to prepare the athletes to win	63.6%
- Is dangerous to the athletes' mental health	66.9%
- Is dangerous to the athletes' physical health	83.2%
- Is unethical and immoral	77.4%
- Is prohibited	69.1%
2. Magnitude of sports doping (4 items)	
- Is a large and universal phenomenon	68.7%
- Is a public health problem	60.8%
- Most record-breaking performances are achieved through doping	24.8%
- Doping affects all type of sports	53.1%
3. Prohibited performance-enhancing substances (15 items)	

- Anti-estrogenic substances	34.7%
- Alcohol consumption	50.9%
- Beta-2 agonists	29.1%
- Beta-blockers	14.3%
- Energy drinks	11.1%
- Caffeine	15.6%
- Diuretics	12.7%
- Hormones (EPO, GH, corticosteroids,..)	62.4%
- Narcotics such as morphine	24.8%
- Manipulation of blood or blood components	21.0%
- Proteins	6.1%
- Anabolic androgenic steroids	74.5%
- Stimulants (Adrenaline, amphetamine,..)	73.3%
- Red meat	28.1%
- Vitamins	14.3%

4. The negative effects of sports doping (6 items)

- Addiction	79.0%
- Excessive aggression	62.0%
- Osteo-articular injuries	50.1%
- Cardiovascular complications	83.8%
- Depression	62.2%
- Death	69.3%

5. Population affected by sports doping (8 items)

- Champions/professionals	85.3%
- Amateurs	57.2%
- Adults	57.4%
- Adolescents	74.3%
- Children	6.5%
- Disabled people	10.1%
- Men	82.4%
- Women	42.0%

P-0875

Securing antibiotics for the future – exploring the attitudes of trainees in family practice

Anthea Dallas¹, Mieke van Driel², Thea van de Mortel³, Parker Magin⁴

¹School of Medicine, University of Notre Dame, Sydney, Australia

²Discipline of General Practice, University of Queensland, Brisbane, Australia

³School of Nursing and Midwifery, Griffith University, Meadowbrook, Australia

⁴Discipline of General Practice, University of Newcastle, Callaghan, Australia

BACKGROUND: Antibiotic resistance is a public health concern worldwide. A high proportion of antibiotics are prescribed in primary care, often for conditions where there is no evidence of benefit. Without a change in these prescribing patterns, resistance will persist as a significant problem. Educational interventions have had limited effect. Targeting early-career doctors while their habits are developing may be a more effective strategy. Many studies have investigated the antibiotic prescribing habits of established family doctors, but little is known about how trainees perceive and develop their prescribing.

AIM: To explore the attitudes of trainees in family practice towards antibiotic use and resistance, and the perceived influences on their prescribing.

METHOD: A qualitative study employing semi-structured interviews and a focus group. Seventeen trainees in family practice were purposively sampled from rural and urban locations in Australia, aiming for maximum variation of participants. Topics of discussion included awareness of antibiotic resistance, use of evidence-based guidelines and perceived influences on prescribing decisions. Sampling continued until thematic saturation was achieved. Data collection and analysis were concurrent and cumulative, using a process of iterative thematic analysis.

RESULTS: Trainees were aware of the importance of evidence-based antibiotic prescribing and the potential impact of their decisions on antibiotic resistance. They held generally positive attitudes towards the use of guidelines. The context of prescribing influenced their decisions, including patient and system factors, diagnostic uncertainty, transitioning from hospital medicine to primary care, and the habits of, and relationship with, their supervisor.

CONCLUSIONS: Understanding why trainees prescribe antibiotics and how their habits develop will be of utility to those involved in the training of family doctors. Our results are informing the development of an innovative educational intervention promoting rational prescribing, addressing the important issue of antibiotic resistance by targeting a new generation of prescribers.

Keywords: antibacterial agents, drug resistance microbial, graduate medical education, physician prescribing patterns.

Antibiotic resistance is a public health concern worldwide

Australia




Interview quotes: trainee prescribing

I just don't want to be contributing to the over-prescribing of antibiotics for viral URIs that will clear on their own.
I just don't want to perpetuate it, but I do.

Why do trainees prescribe antibiotics for self-limiting respiratory tract infections?

Patient and System Factors
 Demographics
 Access to care
 Local disease patterns
 Perceived patient pressure

Transition to Primary Care
The majority of people [with respiratory infections] who are in hospital end up on antibiotics...when I first started I was a little bit more likely to give antibiotics coming out of that situation.




Diagnostic Uncertainty
I think early on I was really hesitant about it and thought "I probably shouldn't be giving antibiotics here but they look sick and they always get them." Whereas now I think I'm a lot more confident to say, "No, you don't need antibiotics."

Interview quotes: supervisor influence

How do supervisors influence evidence-based prescribing?

Providing a good precedent
 Education
 Role-modelling
 Trust and respect

The supervisor has been practising for at least 30 years and is very experienced. So when he tells me something I usually believe it.



Patient expectations
 Overt pressure

My supervisor will give his patients antibiotics even for something that sounds very viral, and therefore when I see his patients, I feel I'm expected to do that as well...I'm definitely more likely to give his patients antibiotics even when I don't think it's justified.

P-0876

The Fundamental Teaching Activities Framework for Teachers in Family Medicine: a new tool for teachers and programs

Allyn Elizabeth Walsh

College of Family Physicians of Canada

Background and Aim

The College of Family Physicians of Canada recognized the importance of supporting teachers as new competency-based curricula were adopted nationally. Teachers need both a clear understanding of the expectations and opportunities within their roles and faculty development to guide their professional growth. Educational institutions need direction in developing and organizing curricula and resources to support this professional development.

Method

A fundamental teaching activity is defined as a holistic description of what a teacher actually does, and includes a number of different competencies. A framework articulating the fundamental teaching activities of teachers in family medicine settings was developed based on the concept of Entrustable Professional Activities (EPAs). Beginning with a literature review, and moving through an iterative process including teachers, faculty developers, program leads, residents, and medical students, three domains were described: Clinical Preceptor; Teacher Outside the Clinical Setting; and Educational Leader. Within each domain, several tasks were identified, each broken down into several fundamental activities. A developmental trajectory consistent with the Euract Framework for CEDin GP was described for each activity, permitting teachers to identify next steps in their professional development.

Results

The Framework was well received by the reviewing groups of teachers, program leaders and faculty developers.

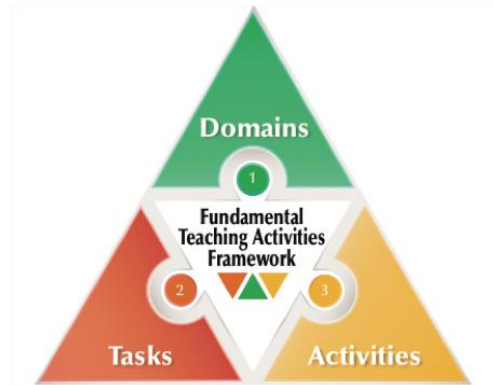
Teachers were able to quickly identify with the Fundamental Teaching Activities. Departments/Programs in Canada have begun to use the Framework in faculty development.

Conclusion

A framework of teaching activities, based on the concept of EPAs for learners, is being launched by the College of Family Physicians of Canada. The concept of Fundamental Teaching Activities (FTAs) is intuitive for teachers and useful in understanding teacher development and in planning faculty development activities.

Keywords: Teachers, continuing educational development, EPAs for teachers

FTA Diamond



CFPC SOT



FTA Taxonomy

CLINICAL PRECEPTOR	
TASKS	
Clinical Coach A supervisor in day-to-day practice	Competency Coach An educational advisor along the course of learner training
ACTIVITIES	
<ul style="list-style-type: none"> Explicitly embodies the roles, attitudes, and competencies of a family physician in clinical work Promotes and stimulates clinical reasoning and problem solving Gives timely, learner-centred, and constructive feedback Uses program assessment tools to document observed learner performance according to level of training Employs reflective processes to refine clinical supervision 	<ul style="list-style-type: none"> Helps learner design and update his or her individual learning plan Guides a comprehensive periodic progress review informed by the learner's self-analysis Assists learner in his or her professional development Adjusts teaching interventions to support a learner facing progression challenges
TEACHER OUTSIDE THE CLINICAL SETTING	
TASKS	
Teacher – Design and delivery of teaching sessions outside the clinical setting	
ACTIVITIES	
<ul style="list-style-type: none"> Prepares teaching session (before) Facilitates teaching session (during) Reflects on teaching session (after) 	
EDUCATIONAL LEADER	
TASKS	
Educational Programmer – Design and development of educational programming	Educational Administrator – Leadership roles in teaching sites and educational programs
ACTIVITIES	
<ul style="list-style-type: none"> Develops curriculum Develops strategies for teachers working with learners experiencing progression challenges 	<ul style="list-style-type: none"> Evaluates programs Applies and develops standards Engages stakeholders Utilizes and develops resources

The organizational structure of the FTA Framework (taxonomy)

2 FTAs

Domain: CLINICAL PRECEPTOR		Applies basic educational principles to each teaching activity	Applies basic and advanced educational principles to each teaching activity	Demonstrates leadership and scholarship in teaching activities
Task 1: Clinical Coach – A clinical supervisor in day-to-day practice, employing clinical work for opportunistic teaching and learning				
Helps learning through reflection in action	Explicitly embodies the roles, attitudes, and competencies of a family physician in clinical work	<ul style="list-style-type: none"> ▲ Verbalizes clinical reasoning processes for learners (including challenges, reactions, and ethical dilemmas) ▲ Displays enthusiasm for family medicine patient care ▲ Provides a safe learning environment for patients and learners 	<ul style="list-style-type: none"> ▲ Utilizes appropriate educational framework to explicitly articulate decisions and actions ▲ Expresses family medicine values and principles within day-to-day clinical practice 	<ul style="list-style-type: none"> ▲ Supports other faculty to be aware of their positions as role models and to enhance their role-modeling skills
	Promotes and stimulates clinical reasoning and problem solving	<ul style="list-style-type: none"> ▲ Uses specific strategies to facilitate/ assess clinical reasoning ▲ Adapts to learner's reasoning process ▲ Guides learner in the refinement of clinical reasoning 	<ul style="list-style-type: none"> ▲ Discusses clinical reasoning processes with learners who are at different levels ▲ Provides opportunity for learner to discuss and reflect on his or her own work 	<ul style="list-style-type: none"> ▲ Makes educational strategies explicit and guides other teachers to reflect on and use them

An example of two Fundamental Teaching Activities, with their developmental trajectory

P-0877

Elderly Fall Prevention: risk factors and health promotion identification

Ana Rosa Murad Szpilman, Danilo Dos Santos Pianca, Carla Thiebaut Jussim Kalil Silva
Department of Public Health, Vila Velha University, Vila Velha, Brazil

BACKGROUND & AIM

Falls are a really common and devastating event for elderly people. It can indicate a beginning of an illness or signalize a weakness, besides increasing the health system costs. It is hard to prevent because it can present a variety of predisposing factors. However, simple measures can corroborate to falls prevention and health promotion. The aim of this study is to present elderly falls main risk factors and preventive measures, and to promote necessary adjustments in their homes for better quality of life.

METHOD

The Vila Velha University Medical students performed an educational Speech for 20 elderly people in a Public Health Unity, in Brazil, providing information about the main falls risk factors, as well as, physiological changes related to senility and how to handle them. Preventive measures Illustrations and explanations were presented and afterwards a checklist was used to identify the risk factors on the participants' residences.

RESULTS

50% of the elderly people presented at the speech have already suffered some kind of injury caused by avoidable falls. Among the main causes of falls, 40% were related to postural hypotension, 30% to use of inappropriate shoes, 20% to fall during taking a shower and 10 % to associated comorbidity, such as labyrinthitis. Notice that 90% did not practice any physical activity.

CONCLUSIONS

The elderly population in Brazil has been increasing each year, impacting the assistance offered by the public health system services. The elderly population life expectancy has been growing along their active participation in society. A fall can be decisive in a senior autonomy rupture, intervening directly to his quality of life and dependency level. The risk factors identification using the checklist facilitated the performance of the Community Health Workers in the process of environmental adaptation, ensuring the elderly people more security and life quality.

Keywords: Health Education, Public Health, Old Age Assistance.

Elderly Fall Prevention: Educational Speech



This picture also shows the Educational Speech performed by the medical school students with the elderly community in Brazil.

Elderly Fall Prevention: Educational Speech



This picture shows the Educational Speech performed by the medical school students with the elderly community in Brazil.

P-0878

Teaching-Service experience: Medical students from Federal University of Grande Dourados, family health teams of Dourados city and Telehealth Brazil Program

Crhistine Cavalheiro Maymone Gonçalves¹, Adélia Delfina Da Motta Silva Correia², Leonardo Cançado Monteiro Savassi³

¹Faculty of Health Sciences, Medicine, Federal University of Grande Dourados

²Faculty of Medicine, Federal University of Mato Grosso do Sul

³Faculty of Medicine, Federal University of Minas Gerais and Federal University of Ouro Preto

Background & AIM: This is a teaching-service-community experience with 40 medical students and 11 family health teams of Health Department of Dourados city and its partnership with the Scientific-Technical Core of Telehealth Brazil Networks Program in Mato Grosso do Sul (MS), linked by the State Department of Health (SES-MS).

METHOD: During the first half of 2014, by discipline of Community Health, students and teams experienced the work of applying the Family Risk Scale of Coelho-Savassi (ERF-CS), a brazilian instrument of family stratification risk, that takes into account vulnerability, based in sentinels of risk collected by family health team while visiting families. Datas were collected and recorded on a form called Record A, part of Primary Care Information System (SIAB). The experience was aimed at learning, research and assistance to implement actions to families. The knowledge of the reality of territory, identify the watchmen of risk and support the planning of home visits were targets. There were field research activities, interspersed with web conferencing and Virtual Environment Moodle Learning via Telehealth, important educational vehicle distance, which made the communication between the teams and teachers who supported the experience.

RESULTS: The differential of this deployment was the movement of integration of teams and students that enabled the identification of the vulnerable situation of 11,812 families ascribed to units. It is essential establish mechanisms to strenghten relationship between health teams and health students. It is necessary improve digital inclusion.

CONCLUSIONS: It was an innovative experience, considered satisfactory with essential results to boost new experiences in medical education through teleducation, aimed at integrating teaching and service-community and, consequently, increasing supply and access to teleassistance actions and teleducation, strengthening primary health care-APS as the coordinator of care and the Health Care Network. This experience is also being registered in two books in press.

Keywords: Primary Health Care, Medical Education, Telemedicine

Universidades Parceiras neste trabalho



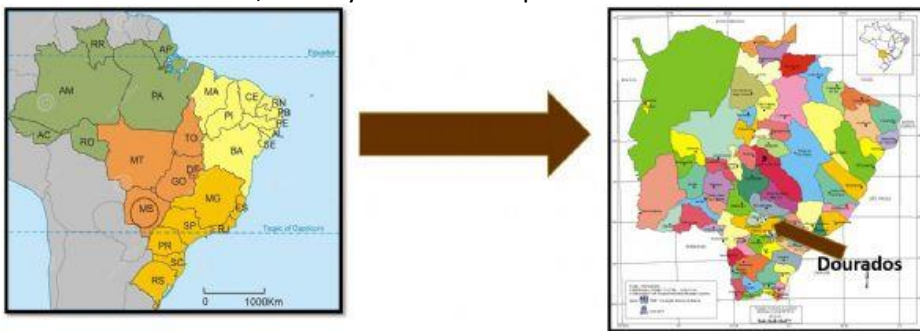
Family Risk Scale of Coelho-Savassi (ERF-CS)

Data from Card A (primary care information system)	SCORE
Bedridden	3
Physical disability	3
Mental disability	3
Low sanitary conditions	3
Malnutrition (severe)	3
Drug addiction	2
Unemployment	2
Illiteracy	1
Less than six months old	1
Over seventy years old	1
Systemic arterial hypertension	1
Diabetes	1
Resident / room relationship	if bigger than 1: 3 if equal to 1: 2 if lower than 1: 0

- Score 5 or 6= R1 – lower risk
- Score 7 or 8= R2 – medium risk
- Score bigger than 9= R3 – maximum risk

Sentinels risk score for calculating the Family Risk Scale of Coelho-Savassi (ERF-CS) SOURCE: COELHO, F. L. G.; SAVASSI, L. C. M. AplicaÃ§Ã£o de Escala de Risco Familiar como instrumento de priorizaÃ§Ã£o das Visitas Domiciliares. Revista Brasileira de Medicina de FamÃ­lia e Comunidade [online], v.1, n. 2, p. 19-26, 2004.

Location of Dourados, the city where the experiment was conducted.



This is a map to help locating the space of this experience.

Some moments of the experience



Some moments of the experience: the students with a nurse, member of one of the visited teams; the organization of agenda's team; a territory map of one of the teams; the card A; a family health unit, Card A files.

Our virtual learning environment - Moodle



This is a printscreen from the virtual learning environment - Moodle - created to develop this work,

Figures of webconferencs held



This are images from the webconferencs held, that are available in: <https://youtu.be/e8DYVligLIY>
<https://youtu.be/e8DYVligLIY>

P-0879

Nutrition and Medical Students' educational activity: hypertensive and diabetic patients' improvement on interest and adherence to lifestyle changes

Ana Rosa Murad Szpilman, Tayná De Souza Melo

Department of Public Health, Vila Velha University, Vila Velha, Brazil

BACKGROUND & AIM

The Vila Velha University medical students participate in a curricular internship in the public health unities. Since the beginning, the students attend the Federal Government HiperDia Program, which monitors the hypertensive and diabetic patients assisted by the Health Unity. The meetings occur once a month, with awareness, blood pressure and glucose follow-up. The medical students insist on persuading patients to lifestyle changes. After one year and a half, participating in these meetings, discussing the same subjects over and over again, despite the methodology changes, some students bothered with the monotonous and not persuasive way of trying to create patients' awareness. Therefore, they decided to invite the nutrition students to show, in a dynamic and contextualized way, the nutritional interference on hypertension and diabetes.

METHOD

The nutrition and medical students with their teachers organized a health nutrition workshop in the community church, in which they showed the 30 hypertensives and diabetics presented, the quantity of salt and sugar found in some common foods, using known measures like spoons, glasses and recipients.

RESULTS

It was visible in the patients facial expressions the impact caused by the quantity of salt and sugar shown in the variety of foods presented. Distinctly from the usual reactions with the lectures and speeches performed by the students before, the patients demonstrated enthusiasm on trying to experience some lifestyle changes related to nutrition health.

CONCLUSIONS

Lifestyle changes are a real challenge for health professionals on treating their patients. This workshop shows that working in a team facilitates achieving success on improving patients' quality of life. Different approaches may bring better results when the objective is to work with health education and preventive assistance. Putting in place educational activities with students from different health graduation courses may increase the results in lifestyle changes achievements.

Keywords: Undergraduate Medical Education, Public Health, Delivery of Health Care.
Hypertensive and Diabetic Health Nutrition Workshop



This picture shows some medical students checking the hypertensive blood pressure and the diabetic glucose level during the health nutrition workshop.

Hypertensive and Diabetic Health Nutrition Workshop



This picture shows some of the participants in the health nutrition workshop performed by the nutrition and medical school students with the elderly hypertensive and diabetic community in Brazil.

P-0880

Men's Health Care Educational Activity: prevention and self-care awareness

Ana Rosa Murad Szpilman, Tayná De Souza Melo

Department of Public Health, Vila Velha University, Vila Velha, Brazil

BACKGROUND & AIM

The Vila Velha University medical students participate in a curricular internship in the public health unities, putting in practice a variety of activities, creating a favorable environment to put in action all the theoretical content they are studying in the university, benefitting the professionals and the assisted community. It is well known the invulnerability myth attributed to male figure, which ends up damaging their self-care, harming serious illness early diagnosis. In order to sensitize men assisted by the Health Unity, the students promoted a meeting called "an afternoon chat with men" to create a self-care awareness on the assisted men by the public Health Unity.

METHOD

During the meeting "an afternoon chat with men", the students discussed several themes: the risks of routine appointments indifference, prostate cancer, body hygiene, condom correct use, and other subjects suggested by the participants. The female students prepared a health snack, received the participants, and checked their blood pressure and glucose level. The male directly participated in the meeting.

RESULTS:

The participants exposed themselves in an unexpected way, asked a lot of questions, cleared their doubts, and committed on taking better care of their health, seeking for help in the health unity whenever they feel sick or in need of help. The male invulnerability myth was demystified to avoid self-care obstacle. After the meeting, the students noticed an increase on male search for professionals' assistance in the Health Unity.

CONCLUSIONS:

The students attitude on creating this space for men to talk about their health and masculinity was acknowledge by the health unity professionals and the assisted community as a health promotion space, helping the professionals with their daily work in the unity. The idea is to transform this one meeting "an afternoon chat with men" into a continuous project in the unity.

Keywords: Public Health, Men's Health, Delivery of Health Care.

Men's Health Care Educational Activity



This picture shows some of the participants in the Men's Health Care Educational Activity performed by the medical school students with the men assisted by the Public Health Unity in Brazil.

P-0881

Young Doctor Movement at WONCA World Rural Health Conference 2015 – Involvement and Outcomes

Veronika Rasic¹, Ivana Babic¹, Kyle Hoedebecke², Victor Ng²

¹Vasco da Gama Movement

²Polaris, WONCA YDM

BACKGROUND: The WONCA World Rural Health Conference will be held in Dubrovnik, Croatia in April of 2015. The organizing committees decided to include the involvement of junior doctors and students to help promote rural practice and present it as an attractive career choice. The WONCA young doctor movements rose to the challenge and will be presenting a number of workshops and papers at the conference. We would like to share with you the outcomes of our activities. Subjects that will be covered include: leadership in healthcare, quality improvement in practice, obstacles to recruitment and retention of junior doctors in rural practice, differences in rural practice around the world, student involvement in rural health, the image of rural healthcare and many more.

METHODS: Information will be gathered from the participants of the workshops and presenters/facilitators.

RESULTS: Promoting rural practice in the junior doctor and medical student community. Providing a platform where they can ask questions and share their opinions.

CONCLUSION: The goal is to promote rural practice as a career choice among medical students and young doctors and attempt to address issues that are presently making this a challenge. We hope that the outcomes of our contribution at this conference will help to include junior doctors and students in rural practice and provide a platform that encourages contributing to possible solutions to obstacles. The poster will give a summary of the outcomes of the conference.

Keywords: rural practice, young doctor movement, education, healthcare, career

P-0882

Empathy Levels and Affecting Socio-Demographic Characteristics Of Medical Students

Mustafa Gökhan Şen, Mehtap Kartal, Nilgün Özçakar

Department of Family Medicine, Dokuz Eylul University, Izmir, Turkey

Background & AIM:

Empathy in general, "put oneself instead of someone else", when a little more clarification "a mental process including appropriate understanding another person's emotional state and perspectives" is defined. Physician candidates should have the talent not only to carry out the medical part but also the medico-social part of the patient-physician relationship.

METHOD:

This study was completed by 688 Medical Faculty (1st year: 315, 3rd year: 256, 4th year: 258, 6th year: 162) students of Dokuz Eylul University in 2012-2013 academic year. A questionnaire containing socio-demographic characteristics of the students and statements concerning the patient-physician communication with The "Jefferson Scale of Physician Empathy" (JSPE) student version was used. JSPE consists of three subscales called perspective taking, to act with compassion, wearing patient's shoes. Its score ranges between 20-140 and high scores indicate high empathy. Student's t test, ANOVA, Pearson's chi-square tests were used and $p < 0.05$ was considered as statistically significant.

RESULTS:

Of the participants 54% were male and the mean age was 21.1 ± 2.1 . The total mean score of JSPE was 101.5 ± 15.3 and mean for subscale of perspective taking 51.9 ± 9.7 , for subscale act compassionately 37.8 ± 7.8 and subscale wearing patient's shoes were found 8.3 ± 2.7 . The 6th year students' scale and subscale scores were low compared to other years. Female students had higher levels of empathy except the wearing patient's shoes subscale. The

level of empathy for students living at dorms was significantly higher than the other groups, except the subscales act compassionately and the wearing patient's shoes. Students of middle-income level had high levels of empathy except the wearing patient's shoes subscale.

CONCLUSIONS:

Medical education in addition to medical knowledge has to cover the medico-social dimension of human relations that affects the patient-physician relationship positively. Increased awareness of empathy, adequate share in the curriculum will enlighten the future physicians' perspectives.

Keywords: Medical students, empathy, patients

Table 1. Socio-demographic characteristics of participating students

Socio-demographic characteristics		N	%
Grade	1	225	32.7
	3	179	26.0
	4	184	26.7
	6	100	14.5
Gender	Female	320	46.5
	Male	368	53.5
Age	<20	169	24.5
	20-21	218	31.6
	>21	301	43.7
Place of residence	At home with family	122	17.7
	Dorm	232	33.7
	At home with friends	284	41.3
	Home alone	50	7.3
Economical status	Low	24	3.5
	Middle	614	89.2
	High	50	7.3
Choose willingly medical faculty	Yes	585	85.0
	No	103	15.0

Table 2. Comparison of students socio-demographic characteristics based on the total scale and subscale scores

Socio-demographic characteristics		Total score		Perspective taking		Compassionate care		Standing in the patient's shoes	
		Mean	SD	Mean	SD	Mean	SD	Mean	SD
Grade	1	104.8	15.2	54.7	9.3	38.8	8.2	7.8	2.6
	3	101.8	14.2	52.3	9.4	38.1	6.8	8.0	2.9
	4	101.6	14.1	50.6	9.3	38.9	6.9	8.7	2.5
	6	98.1	18.0	50.3	10.9	35.6	9.3	8.7	3.0
	p	0.01		0.01		0.01		0.01	
Gender	Male	99.6	15.7	51.5	10.2	36.7	8.1	8.0	2.8
	Female	105.1	14.2	53.5	9.0	39.8	6.9	8.4	2.7
	p	0.01		0.01		0.01		0.07	
Age	<20	105.6	15.7	55.0	9.8	39.1	8.2	7.9	2.6
	20-21	102.9	14.3	53.2	9.2	38.5	6.9	8.1	2.7
	>21	99.8	15.3	50.5	9.8	37.4	8.0	8.5	2.8
	p	0.01		0.01		0.05		0.07	
Place of residence	At home with family	102.4	14.5	52.7	9.3	38.5	7.4	8.2	2.7
	Dorm	104.8	15.2	54.2	9.4	38.7	7.7	8.3	2.8
	At home with friends	100.6	15.6	51.3	10.2	37.7	8.0	8.2	2.7
	Other	99.0	14.0	50.6	8.8	37.5	7.0	8.1	2.7
	p	0.01		0.01		0.43		0.98	
Economical status	Low	93.1	17.9	47.0	13.0	33.9	8.4	8.8	2.2
	Middle	102.5	14.8	52.7	9.4	38.3	7.6	8.2	2.8
	High	102.2	18.1	51.7	11.2	37.2	8.8	8.7	2.8
	p	0.01		0.01		0.03		0.22	
Choose willingly medical faculty	Yes	102.7	15.1	52.7	9.5	38.4	7.6	8.3	2.7
	No	99.5	16.2	51.0	10.8	36.9	8.3	8.1	2.9
	p	0.05		0.10		0.09		0.50	

P-0883

Medical Education And Advanced Technology Applications

Adem Parlak¹, Nehir Parlak²

¹Department of Family Medicine, President Guard Regiment, Ankara, Turkey

²Department of Dermatology, Etimesgut Public Hospital, Ankara, Turkey

INTRODUCTION: Because medical education is a long-term, difficulty of the curriculum and different perception levels of student, revision has been brought up for medical education. In this presentation, we aimed to increase awareness of academic members about application of advanced technology and medical education..

DISCUSSION: By the time problem-based, patient-centered, community-oriented training programs has emerged besides traditional education. After medical curriculum and technology had developed, medical education got through a new period. Thus, the students are adjusted to the health care system easier and faster. As patients become increasingly concerned that students and residents are practicing on them, clinical medicine is becoming focused more on patient safety and quality than on bedside teaching and education. Educators have faced these challenges by restructuring curricula, developing small-group sessions, and increasing self-directed learning and independent research. Nevertheless, a disconnect still exists between the classroom and the clinical environment. Many students feel that they are inadequately trained in history taking, physical examination, diagnosis, and management. Medical technologies have been proposed as a technique to bridge this educational gap.

CONCLUSION: a major challenge for medical undergraduates is the application of theoretical knowledge to the management of acutely ill patients. Students must learn to be systematic in their approach to a problem, and develop skills appropriate to working with a clinical team. However, opportunities for students to develop these attributes are limited in undergraduate training. Advanced technology applications can help them achieve these goals.

Keywords: medical education, advanced technology, applications

P-0884

Knowledge and attitudes toward Family Medicine at the second year of the degree and election of specialty

Maria Candelaria Ayuso¹, Francisco Escobar¹, Jesús López Torres¹, Julio Montoya¹, Juan Manuel Téllez², Arancha Romero³, Juan Miguel Armero⁴

¹Albacete Area IV Health Centre, Health Care Service of Castilla-La Mancha, C/Seminario 4, 02006 Albacete, Spain.

²Albacete Area V Health Centre, Health Care Service of Castilla-La Mancha, C/, Profesor Macedonio Jinénez s/n, 02006 Albacete, Spain.

³Villarrobledo General Hospital, Health Care Service of Castilla-La Mancha C/ Miguel de Cervantes s/n, 02600 Villarrobledo (Albacete), Spain.

⁴Balazote Health Centre, Health Care Service of Castilla-La Mancha, C/Cervantes 1, 02320 Albacete, Spain.

Background & Aim

A cold climate towards primary care (PC) in the medical academia would constitute a barrier to choosing Family Medicine (FM) as a career option. This study was designed to determine medical students' knowledge of and attitudes towards FM at the second year of the degree predicts the election of FM as career.

Method

This is a cohort study. Before taking a course in PC in 2007-2008 and 2008-2009 academic years, 159 2th students were asked to respond to the brief CAMF (Spanish acronym for "Knowledge and Attitudes towards Family Medicine"), a questionnaire with 21 closed response items (5 options on a Likert scale). All of them were investigated about the election of specialty in 2013 and 2014, based on the information provided by the Ministry of Health in its web.

Statistical analysis was performed with SPSS 17.0: comparison of proportions (chi square) and means (Student t test).

Results

The mean age was 19.2 years (SD:0.88), ranging from 18 to 28 years;78.0% were women. The specialty chosen was known in 139 students:17 (12.2%) chose FM,17 pediatrics,11 internal medicine,10 gynecology, 35 internal medicine specialties, 31 other surgical specialties and 18 others.

Before starting the PC course 30.8% of students said they would like to become a family doctor in the future;58.8% for those who chose FM, significantly ($p=0.01$) bigger than 25.4% for the others. But only 4.3% considered it to be their first career choice (no statistical differences between both groups).

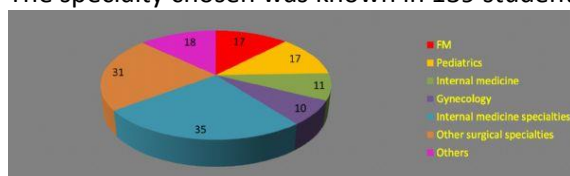
The brief CAMF score range was -3 to 31 (mean:16.4; SD:6.2). Graduates who chose MF had mean 19.2 (SD:6.1), significantly higher than the 15.8 (SD:6.1) of the others ($p=0.037$).

CONCLUSIONS:

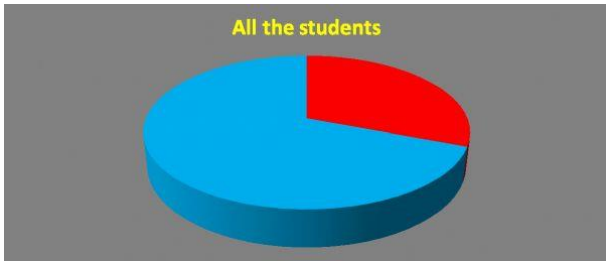
Family Medicine is a minority option as specialty. Those who choose MF score higher in the CAMF, so this could be a predictor of choice of specialty.

Keywords: Family Practice; Health Knowledge, Attitudes, Practice; Students, Medical

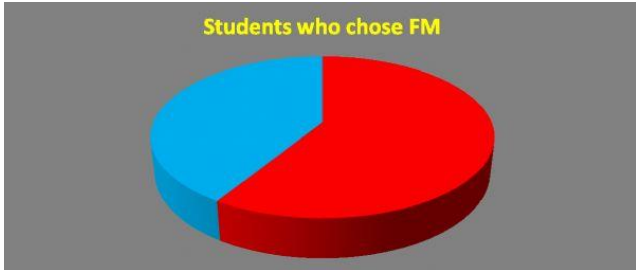
The specialty chosen was known in 139 students:



Students saying "I would like to become a family doctor in the future", before starting the course:

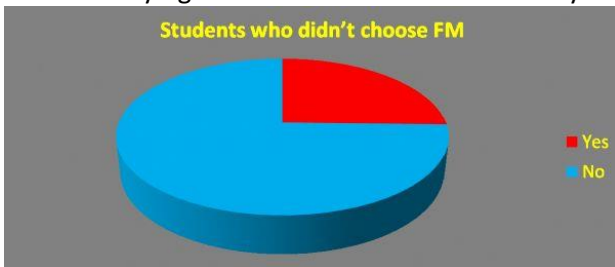


Students saying "I would like to become a family doctor in the future", before starting the course:

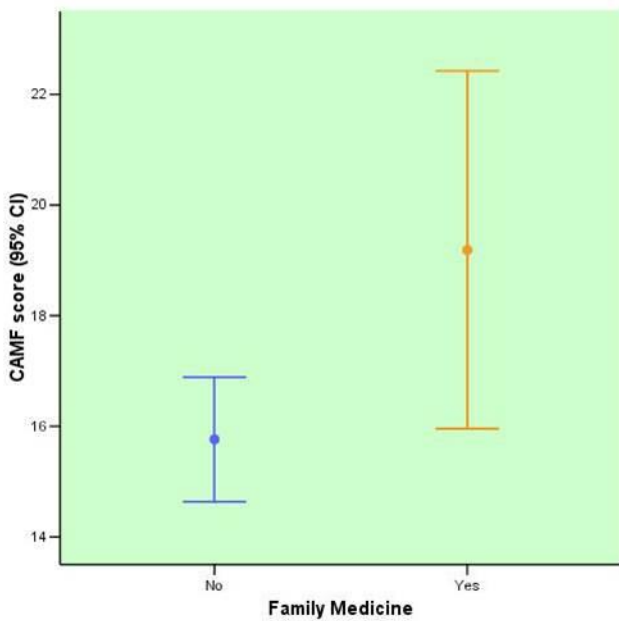


p=0.01

Students saying "I would like to become a family doctor in the future", before starting the course:



Only 4.3% considered it to be their first career choice; no statistical differences between both groups.



The brief CAMF score range was -3 to 31 (mean: 16.4; SD: 6.2). Graduates who chose MF scored significantly higher than the others (p=0.037).

P-0885

Women's Delivery of care Project: breastfeeding, self-care and newborn attention intervention experience in a maternity in Brazil

Ana Rosa Murad Szpilman, Elaine Caliman Vergna, Karem Cristina Martins Pires, Mônica Barros De Pontes, Patrícia Caldeira Penna Giesbrecht, Trícia Guerra E Oliveira
Department of Public Health, Vila Velha University, Vila Velha, Brazil

BACKGROUND & AIM

Breastfeeding is a process of deep mother and child involvement, capable of improving the baby's nutritional state, developing many benefits for both mother and child. In Brazil, the Health Ministry preconizes the exclusive breastfeeding until the baby completes six months of life, and complementary up to two years old or more. The aim of this experience was to stimulate breastfeeding and helping the mothers through this difficult time, teaching them to breast feed, and how to take care of themselves and their newborn.

METHOD

The medical students through the Health Attention Network/Stork Network PET-Health, developed by the Health Ministry, in the Pro-matre Maternity in Vitoria, Brazil, developed an intervention experience to stimulate breastfeeding and helping mothers to go through this moment with calm and tranquility. The intervention took place from August to December 2014. The methodology was based on structured observation, medical records analysis and participation on the multiprofessional health workers team activities, before performing the intervention with the women.

RESULTS:

When the students with the health professionals visit the women who have recently given birth and were breastfeeding in their rooms, after explaining what procedure would be done, they were very receptive to the orientations on breastfeeding, self-care and newborn special cares. After the intervention, the mothers were a lot more comfortable with breastfeeding, and taking care of their babies. It was notorious the improvement of breastfeeding knowledge and mother's confidence, showing that patients and health professionals trustful bond can be effective on delivering quality health care.

CONCLUSIONS:

This experience showed the students that they have an important role in the patient's life, contributing to a Medical formation that emphasizes the patient-professional bond, humanized delivery of care, responsibility to the patient's quality of life, and commitment to a responsible, professional, ethical and humanizing practicing of medicine.

Keywords: Public Health, Delivery of Health Care, Humanizing Delivery, Breast Feeding, Maternal-Child Nursing.

The PróMatre Maternity in Brazil



This picture shows the PróMatre Maternity, which is a habitual risk delivery maternity in Brazil.

P-0886

How familiar with the new inhalers is our Primary Health Care staff?

Laia Gené Huguet, Amparo Hervás Docón, María Ortega Carmona, Cristina Blánquez Moreno, Nora Selvi Miralles, Núria Sánchez Ruano

CAPSBE Borrell, Barcelona, Spain

AIM

To evaluate health care professionals' familiarity with new inhalers available, ability to demonstrate them to patients and knowledge of adverse effects.

MATERIALS AND METHODS

Descriptive study in an urban primary health center with 32 professional staff (19 doctors (59.4%) and 13 nurses (40.6%)). Questionnaire distributed to all staff. Variables: sex, age, professional level, knowledge of inhaler types and their names (before 2004: pressurized cartridges (ICP), chamber, turbuhaler, accuhaler, handihaler, easyhaler; after: breezhaler, respimat, genuair and nexthaler), and their prescription. Other variables: demonstration methods (written instructions, instructional video, practical demonstration by staff), information given regarding administration order if using more than one medication, knowledge of adverse effects.

RESULTS

Median age: 42.6 ± 10.9 SD, 87.5%female. Most familiar and prescribed inhaler types: ICP and chamber (100%), accuhaler 30(93.8%), turbuhaler and handihaler 29(90.6%). Staff recognizing ICP and chamber, only 20 (62.5%) and 30 (93.8%) respectively, associating the name. Lesser recognition of breezhaler 12(37.5%), respimat 11(34.4%), nexthaler 6(18.8%) and easyhaler 8(5.15%); furthermore easyhaler was not recognized by nursing staff. 79.6% of nurses provided written information, compared to 15.8% of doctors. 92.3% of nurses demonstrated techniques, against 36.8% of doctors. The most prescribed inhalers among non-elderly patients: ICP 8(42.1%) and turbuhaler 7(36.8%), and elderly: ICP with chamber 11(57.9%). Over half (53.1%) the staff didn't know the administration order of the different nebulized medications. Those who did recommended them correctly (40.6%). The most known adverse effects were oropharyngeal candidiasis from corticoids(78.9%), mouth dryness from anticholinergics(42.1%) and tachycardia from beta-adrenergics(84.2%); more familiar to doctors than nurses.

CONCLUSIONS

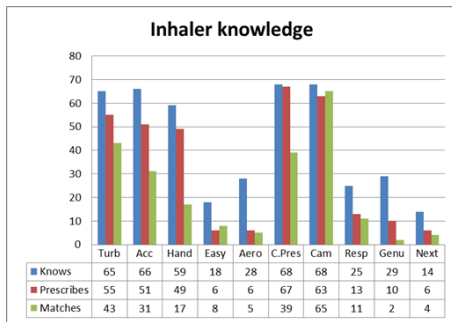
Unfamiliarity of newer inhalers was evident. Practical use of inhalers was more widely explained by nurses and adverse effects were more known by doctors. In order to increase knowledge, prescription, appropriate demonstration and awareness of secondary effects we need to educate the professional staff via workshops.

Keywords: inhalers, knowledge, public health profesional

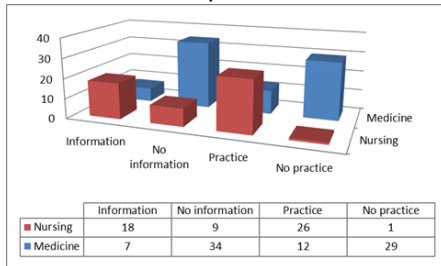
Inhalers



Inhaler knowledge



Information and practice



P-0887

Bridging the research-practice gap: The success of the Veterans' MATES program in improving medication use in veterans with musculoskeletal pain

Amanda Barnard¹, Lisa Kalisch Ellett², Mhairi Kerr², Marie Iannos², Kerrie Westaway², Elizabeth Roughead²

¹Medical School, Australian National University, Canberra, Australia

²Quality Use of Medicines and Pharmacy Research Centre, Sansom Institute, School of Pharmacy and Medical Sciences, University of South Australia, Adelaide, Australia

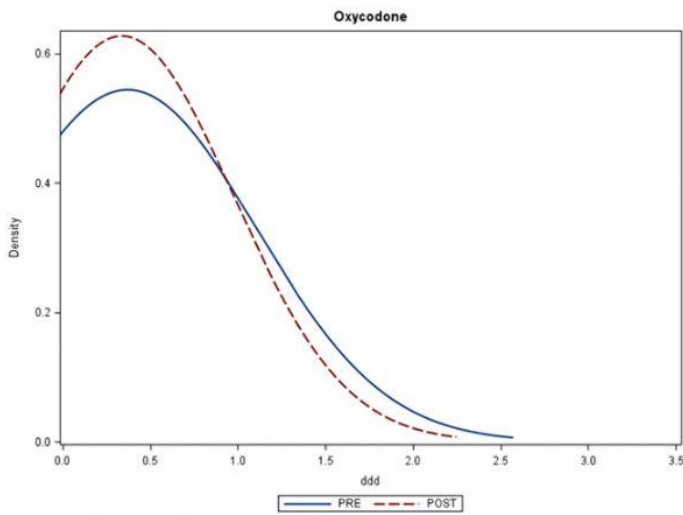
Background & AIM: The Veterans' Medicines Advice and Therapeutics Education Services (MATES) program engages General Practitioners to improve medicine use for veterans. The Australian Government Department of Veterans' Affairs administrative claims data are used to provide patient-based prescriber feedback to GPs. This is supported with evidence-based, peer-reviewed educational material developed by a clinical panel and overseen by a nationally representative editorial committee. This study evaluated the impact of the intervention that aimed to improve the management of chronic musculoskeletal pain by reducing the use of long-term opioid analgesics. **METHOD:** Educational materials included each patient's recent use of pain medicine use, with requests to review the need for medicines and non-pharmacological therapies, as well as education for self-management. Targeted veterans with chronic musculoskeletal pain received an educational brochure on the benefits of a multi-modal approach to management. Change in use of pain medicines as a result of the intervention were assessed using a Wilcoxon signed rank test.

RESULTS: Tailored educational materials were mailed to 5,341 GPs and 8,440 veterans. Fifty-seven percent of doctors reported the prescriber feedback would assist them to review patients, and 82% reported they would utilise the "Six A's" of pain management when assessing patients. More targeted veterans were on lower doses of tramadol and oxycodone after the intervention. Tramadol use decreased by a median of 0.03 defined daily doses per person per day (IQR:0.00-0.22)($p < 0.0001$). Oxycodone use decreased by a median of 0.01 (IQR:0.00-0.07)($p < 0.0001$).

CONCLUSIONS: The intervention was successful in reducing the amount of opioid analgesics used by targeted veterans. The significance of this work lies in its ability to bridge the research-practice gap in the general practice setting.

Keywords: Education; quality use of medicines

Figure 1a: Targeted veterans: Average oxycodone DDD per veteran per day



Results for oxycodone: The median of the differences in post and pre DDDs was -0.01 (IQR: -0.06 to 0.02, $p < 0.0001$), suggesting a significant decrease in DDD in targeted veterans after the intervention. This indicates that more targeted veterans were dispensed lower doses of oxycodone in the post intervention period compared to the pre-intervention period (see Figure 1a). By comparison, there was no significant change in post and pre oxycodone DDDs for the historical group (see Figure 1b).

Figure 1b: Historical comparisons: Average oxycodone DDD per veteran per day

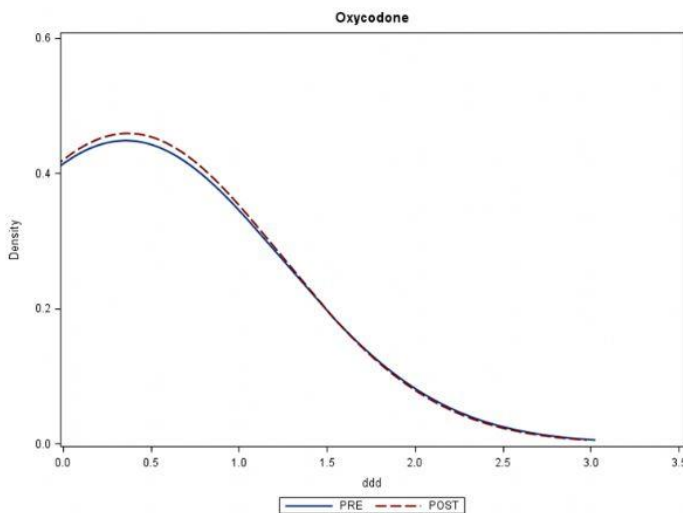
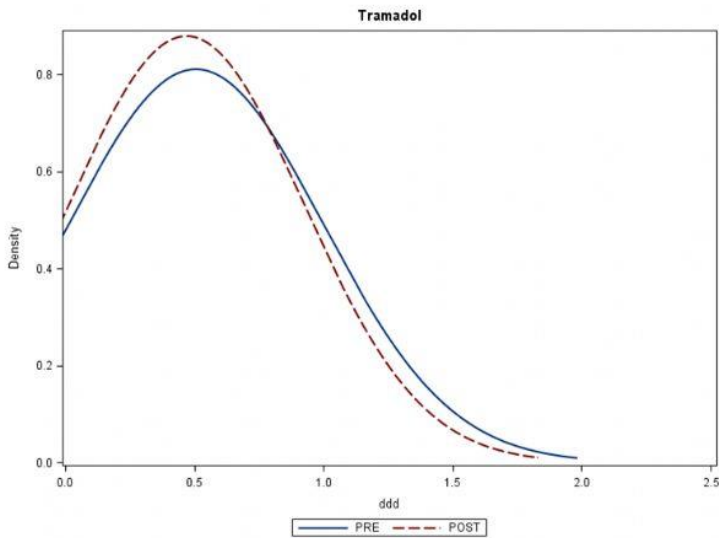
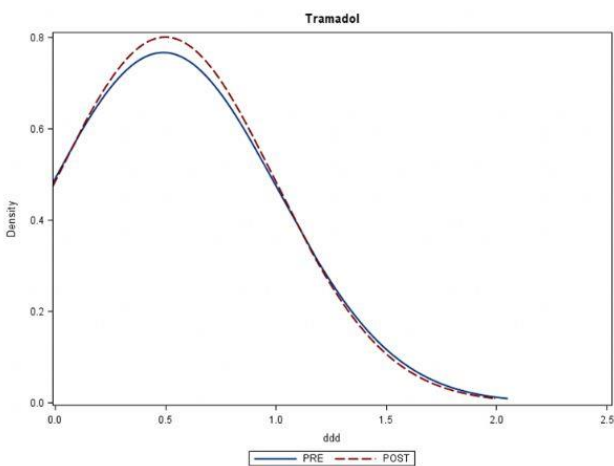


Figure 2a: Targeted veterans: Average tramadol DDD per veteran per day



Results for tramadol: The median of the differences in post and pre DDDs was -0.03 (IQR: -0.17 to 0.01, $p < 0.0001$), suggesting a significant decrease in DDD in targeted veterans after the intervention. This indicates that more targeted veterans were dispensed lower doses of tramadol in the post intervention period compared to the pre-intervention period (see Figure 2a). By comparison, there was no significant change in post and pre tramadol DDDs for the historical comparison group (see Figure 2b).

Figure 2b: Historical comparisons: Average tramadol DDD per veteran per day



This study was supported with funding from the Australian Government, Department of Veterans' Affairs, for the establishment of Veterans' MATES, www.veteransmates.net.au



Veterans' MATES Program



Developing a Forum for Young General Practitioners (FYAM): Helping other Countries learn by the Danish Experience

Ulrik Bak Kirk, Mads Dannesbo, Christina Svanholm, Gazelle Maghsoudi, Karolina Lewandowska
Forum for Young General Practitioners (FYAM), Denmark

Background

Since 1983, under the auspices of the Danish College of General Practitioners (DSAM), Denmark has had a formal structure for Young GPs, the Forum for Young General Practitioners (FYAM).

From the very beginning, DSAM provided both administrative aid and economic efforts. A key feature in this process was that FYAM was an exact organizational reflexion of DSAM; FYAM had its own executive board. However, the engagement of members of FYAM had several characteristics shared with that of a club of pioneers or an interest group: Individual initiative was greatly celebrated and matured, but when primus motors signed out and/or graduated, the organizational knowledge, the commitment and their network vanished with them.

Methods

From 2011, when the former chairman of FYAM was elected, a new approach in engaging and attracting members was launched: Concept campaigns. The adoption of this very different approach towards professionalizing FYAM had three characteristics:

- 1) Stronger organisation. The introduction of an annual FYAM board 2 days workshop, combined with a dedicated budget to the planning and the running of a yearly campaign.
- 2) Member engagement. The members of FYAM working together as a group and use of individual resources and skills towards achieving a common goal.
- 3) Innovative communication. The campaigns of FYAM were evaluated by their impact and level of dissemination, which is why communication and use of different media was a key feature in the entire process.

Results

The concept campaigns proved effective and efficient in engaging current interest and attracting new members to the Forum for Young General Practitioners in Denmark.

The combination of gadgets and online communication contributed in a positive way to the dissemination and reach of the campaigns' messages.

Conclusions

Organizational support when developing a formal structure for Young GPs is essential.

A cross-media communication strategy proves very valuable.

Keywords: Motivation, Engagement, Campaigns, Network, Developing a Forum for Young General Practitioners(FYAM)

The infographic is a vertical document with a green and white color scheme. It features a logo for 'fyam' at the top left. The main title is 'Developing a Forum for Young General Practitioners(FYAM): - Helping other Countries learn by the Danish Experience'. The content is organized into four numbered sections: 1. Presenting authors (Ulrik M Dannesbo, C Svanholm, C Maghsoudi, K Lewandowska), 2. Background (Since 1983, under the auspices of the Danish College of General Practitioners (DSAM), Denmark has had a formal structure for Young GPs, the Forum for Young General Practitioners (FYAM). From the very beginning, DSAM provided both administrative aid (present and communication) and economic efforts. A key feature in this process was that FYAM was an exact organizational reflexion of DSAM; FYAM had its own executive board. However, the engagement of members of FYAM had several characteristics shared with that of a club of pioneers or an interest group: Individual initiative was greatly celebrated and matured, but when primus motors signed out and/or graduated, the organizational knowledge, the commitment and their network vanished with them.), 3. Methods (From 2011, when the former chairman of FYAM was elected, a new approach in engaging and attracting new members was launched: Concept campaigns. The adoption of this very different approach towards professionalizing FYAM had three characteristics: 1) Stronger organisation: The introduction of an annual FYAM board 2 days workshop, combined with a dedicated budget to the planning and the running of a yearly campaign. 2) Member engagement: The members of FYAM working together as a group and use of individual resources and skills towards achieving a common goal. 3) Innovative communication: The campaigns of FYAM were evaluated by their impact and level of dissemination, which is why communication and use of different media was a key feature in the entire process. Gadgets, movies, post cards, social media, gadgets etc. were introduced to promote the messages.), 4. Results (The concept campaigns proved very effective and efficient in engaging current interest and attracting new members to the Forum for Young General Practitioners (FYAM) in Denmark. The combination of gadgets and online communication contributed in a very positive way to the dissemination and reach of the campaigns' main messages.), 5. Conclusions (1) Organizational support when developing a formal structure for Young GPs is essential. 2) A cross-media communication strategy proves very valuable.) At the bottom right, there is a photograph of a group of people, likely the FYAM members, posing together.

P-0889

Use of Campaign Activity made a difference, it made GP training better - A case report from Denmark

Ulrik Bak Kirk, Mads Dannesbo, Christina Svanholm, Gazelle Maghsoudi, Karolina Lewandowska
Forum for Young General Practitioners (FYAM), Denmark

Background

In 2012, the Forum for Young General Practitioners (FYAM) in Denmark introduced the first member-oriented campaign.

The campaign was designed with the purpose to strengthen the learning outcome of GP trainees, focusing on daily based supervision.

Methods

The campaign was introduced and launched using a video presentation at the Danish College of General Practitioners' annual

meeting in 2012. The campaign slogan was "rp. Supervision, ds. 30 min. daily + pn." written on a prescription block.

- We used different platforms to secure the impact of the campaign. We used self produced silent movie clips, gadgets (coffee-cups) etc.

- We made internet based material with examples on different tools for quality improvement of supervision. Newsletters were published during the campaign year, each time including a new silent movie clip.

- We also introduced an award given to a GP supervisor, who had contributed to high quality supervision for GP trainees. The GP supervisor was honored at the Danish College of General Practitioners' annual meeting in 2013.

Results

After the campaign, the Danish College of General Practitioners (DSAM) recommended GP supervisors approx. 30 minutes of daily supervision of their GP trainees, creating precedent for increased supervision of GP trainees.

Conclusions

The campaign coffee cup was placed at every GP trainees desk in every part of Denmark that year. Even the Danish Minister of Health took a sip of the cup. This was the very first campaign introduced by FYAM.

The impact of the campaign was greater than expected. The level of supervision before the campaign was given in arbitrary doses with great variation among GP supervisors.

After the campaign, the GP trainee can now refer to the recommendations given by DSAM.

The campaign was received well from both GP trainees and GP supervisors.

Keywords: Member-oriented Campaigns, Learning, Supervision, Impact,

Use of Campaign Activity made a difference, it made GP training better - A case report from Denmark

fyam
Forum for Young General Practitioners

Use of Campaign Activity made a difference, it made GP training better

- A case report from Denmark

A Presenting authors
Ulrik Bak Kirk, Mads Dannesbo, Christina Svanholm, Gazelle Maghsoudi, Karolina Lewandowska
FYAM Forum for Young General Practitioners, Denmark

1 Background
In 2012, the Forum for Young General Practitioners (FYAM) in Denmark introduced the first member-oriented campaign.
The campaign was designed with the purpose to strengthen the learning outcome of GP trainees, focusing on daily based supervision.

2 Methods
The campaign was introduced and launched using a video presentation at the Danish College of General Practitioners' annual meeting in 2012.
The campaign slogan was "rp. Supervision, ds. 30 min. daily + pn." written on a prescription block.
We used different platforms to secure the impact of the campaign. We used self produced silent movie clips, gadgets (coffee-cups) etc.
We made internet based material with examples on different tools for quality improvement of supervision.
Newsletters were published during the campaign year, each time including a new silent movie clip. We also introduced an award given to a GP supervisor, who had contributed to high quality supervision for GP trainees. The GP supervisor was honored at the Danish College of General Practitioners' annual meeting in 2013.

3 Results
After the campaign, the Danish College of General Practitioners (DSAM) recommended GP supervisors approx. 30 minutes of daily supervision of their GP trainees, creating precedent for increased supervision of GP trainees.

4 Conclusions
The campaign coffee cup was placed at every GP trainees desk in every part of Denmark that year. Even the Danish Minister of Health took a sip of the cup. This was the very first campaign introduced by FYAM.
The impact of the campaign was greater than expected. The level of supervision before the campaign was given in arbitrary doses with great variation among GP supervisors.
After the campaign, the GP trainee can now refer to the recommendations given by DSAM. The campaign was received well from both GP trainees and GP supervisors.
Due to the success, FYAM have produced annual campaigns for the last 5 years.

P-0890

Humanized Waiting Room: optimizing time and offering health knowledge to the community assisted in a Public Health Unity in Brazil

Ana Rosa Murad Szpilman, Amanda Passini Fraga Falcão, Thaís Viana Ribeiro, Luiza Costa Cysne Dos Santos
Department of Public Health, Vila Velha University, Vila Velha, Brazil

BACKGROUND & AIM

The waiting rooms in the Public Health Unities in Brazil are most part of the time inert, where patients have only one GOAL: wait to be called for their medical appointments. Based on this fact, the medical students proposed to implant the Humanized Waiting Room in a Public Health Unity where their internship takes place, converting the inertia in health knowledge for the patients.

METHODS

The idea was presented to the health unity coordinator. After approval, the group met with the doctors and discussed about the community assisted, defining topics for each week of internship. Dynamic techniques and special tools were used to make this educational activity interesting. The first themes were: Quality of Life and all its determinants; Sexually transmitted diseases. Through a slide presentation, the students “played” with patients about Myths and Truths, asked questions to stimulate participation and used group discussion and debate.

RESULTS

In the beginning, the patients presented resistance to participate, and concern of delaying their medical appointments. It was explained that the objective was to use only the waiting time to discuss some important health subjects. After overstepping the initial opposition, the participation was effective. The patients, after the appointment, joined the group again to continue participating. The doctors approved the project because the patient was more satisfied and not complaining about waiting for the appointment.

CONCLUSIONS

The health educational activities must be realized in an interactive way with the population, exposing themes of daily utilities using simple vocabulary, to instruct and offer knowledge to the patients, avoiding relating educational activities to adjectives like monotonous, inopportune, useless, and boring for most part of the population. The idea is to continue with the project choosing different topics, with the unity health professionals and the population.

Keywords: Public Health, Health Education, Delivery of Health Care.

03/04/15 Humanized Waiting Room: Theme: Sexually transmitted diseases



This picture shows some of the participants in the Humanized Waiting Room: (Theme: Sexually transmitted diseases) performed by the medical school students with the community assisted by the Public Health Unity in Brazil while they were waiting for their doctor's appointment.

Picture 1: 02/25/15 Humanized Waiting Room: Theme: Quality of life and its determinants.



This picture shows some of the participants in the Humanized Waiting Room: (Theme: Quality of life) performed by the medical school students with the community assisted by the Public Health Unity in Brazil while they were waiting for their doctor's appointment.

Picture 2: 02/25/15 Humanized Waiting Room: Theme: Quality of life and its determinants.



This picture shows some of the participants in the Humanized Waiting Room: (Theme: Quality of life) performed by the medical school students with the community assisted by the Public Health Unity in Brazil while they were waiting for their doctor's appointment.

P-0891

The Importance of “Voices of the Street” Project in Health Promotion and Training of Humanized Professional

Luiza Breuel Luz, Daniel Rosa Amaral, Eduardo Mikio Sasaki, Carolina Alice De Camargo Valente, Bárbara Breda Stella, Ângela Eugênio Rizzato, Marco Aurélio Janaudis, Suzana Guimarães Moraes
Voices of the Street, Jundiaí Medical School, Jundiaí, Brazil

Background & AIM: The Voices of the Street Project, led by students from Jundiaí Medical School, Brazil, conducts prevention and health promotion in poor areas of the city of Jundiaí, stimulating contact with the student and population. Thus, search the formation of a humanized professional addition to strengthening the principle of least curative health and more focused on primary care. **METHOD:** The events take place in public schools, through workshops, created and performed by the students themselves, aimed at specific age groups on topics such as prevention of breast cancer and alcohol consumption, and health joint efforts in public squares that develop through circuits with the collection of data such as blood pressure, glucose, and anthropometric measures. **RESULTS:** The Project aims to put the student in contact with the population, which receives help and promote the humanization of medicine along these students. The importance of PVR is the students' opportunity regarding a relationship "student / patient" more humane since the early years of education. Allied to this, the project allows the realization of prevention and health promotion in poor communities, promoting a mutual benefit for the population and for the volunteers. The workshops allow people receive information about care and prevention, improving the quality of life of that group. Furthermore, the active principle from the student learns the importance of health promotion as well as to communicate, making it a more human professional.

Keywords: Health promotion, quality of life, humanization, primary care

Man`s health



The humanization of a medical student



the Students



The students coordinate and create all the workshops.

Vision Test



Washing Hands



Women's health



P-0892

Integration of Education-Service in far communities: experience of medical students from Federal University of Mato Grosso do Sul, Brazil, 2010-2014

Milca Lopes De Oliveira¹, André Vinicius Batista De Assis², Crhistinne Cavalheiro Maymone Gonçalves³

¹Faculty of Medicine, Federal University of Mato Grosso do Sul

²Department of Health Secretary of Mato Grosso do Sul and Master student of Instituto Sirio Libanes de Ensino e Pesquisa

³Faculty of Health Sciences, Medicine, Federal University of Grande Dourados

Background & AIM: There are difficulties to manage health services because there are not human resources, such as doctors to establish in far municipalities. Mato Grosso do Sul, a state in midwestern Brazil, is developing a special partnership with Faculty of Medicine – from Federal University of Mato Grosso do Sul, State Department of Health (SES-MS) and two Municipalities Department of Health. The objective is stimulate that students may create alliances and to see future possibilities to establish in similar communities.

METHOD: During 2010-2014, medical students of end year go to the communities, during five weeks, accomplish and realize of practice family's activities with municipalities's tutor in Health Units of Health Primary Care. To evaluate experience results were collected perceptions during this period from medical students and municipalities's tutor and Faculty of Medicine's tutor.

RESULTS: The experience was aimed at learning and assistance to implement actions to families. The differential of this experience was assigned from 'students' as: autonomy, knowledge of users and community, integrality, knowledge exchange, greater knowledge of Health System; 'municipalities tutor's': academic help in solving cases, leadership in educational activities, population approval, importance of teamwork and intersectoral; 'tutor Faculty's': awakening to the family health strategy, teamwork, elimination of (pre) conceptions of Health System. The perceptions signalled that is necessary create more opportunities to discuss cases and management between health team and students.

CONCLUSIONS: The partnership is important to strenghten alliances between students and communities, with prospectives results for them, as new opportunities. It is essential to boost new experiences in medical education, aimed at integrating teaching and service-community.

Keywords: Primary Health Care, Medical Education, Family Practice

UFMS1



UFMS2



IMAGEM LOGO



P-0893

The importance of communication - the wand of a Family Doctor

Pedro Caetano¹, Carolina Martins Moreira², Celia Pinho³

¹USF Nova Via - CHVNG, Porto, Portugal

²CHP - Serviço de Fisiatria, Porto, Portugal

³University of Porto, Porto, Portugal

BACKGROUND:

Communication is probably the most powerful weapon that family doctors have to convince and impress the patient to do what is best for himself.

Clinical knowledge, as well as good technique are very important skills, nonetheless, communication provides the vehicle and establish the connection to provide quality patient care. Doctor-patient communication has been well researched. Less is known about the educational background of communication skills and intercultural training.

Due to migration, doctors treat patients from different ethnic backgrounds. This causes communication challenges. To develop training programs for doctors in intercultural communication (ICC), it's important to know which barriers determine the quality of ICC.

This research aimed to provide an overview of the literature in ICC and lived experience from a Family Medicine trainee in a refugee-camp.

METHODS:

Bibliography research, collected data and lived experience from the author in MaeLa Refugee-Camp Thai-Myanmar border.

RESULTS:

Due to the author be a foreigner and did not speak the native-language, plus the obstacle of Thai nurses, spoke Burmese, to Karen people, verbal-communication was an issue. It was noticed that patients perceive non-verbal communication, as facial expressions, to be more compassionate, comprehensive, caring and likely to understand better. These were associated with improved medication compliance and patient outcomes.

Non-verbal communication is an important component of the physician-patient interaction. Migrants and refugees patients face specific emotional and psychological issues requiring additional physician emotional support.

The longer the period in which the author was living there and the better the knowledge of culture and beliefs, better was the acceptance by patients.

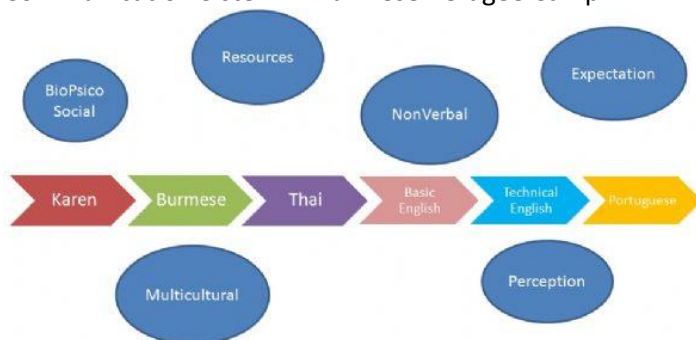
CONCLUSION:

When an educational continuum is realized and attention for doctor-patient communication and intercultural background is embedded in the working context of doctors in training, benefits will be strong.

Training for improving ICC can be developed as an extension of existing training for patient-centered communication.

Keywords: communication, intercultural, language, training skills, medical communication, humanitarian

Communication Sistem in Burmese Refugee Camp



The difficulties of communication between a Karen Burmese speaking patient thru Thai nurse/medic to foreing (Portuguese) doctor and it's diversity

MaeLa - Burmese Refugee Camp Clinic - SMRU



MaeLa Refugee Camp Clinic



P-0894

Hippokrates and FM360°: European and International Exchange Programmes for General Practitioners

Rosa Avino¹, Ana Barata², Sara Rigon¹, Patrick Reichel³, Per Kallestrup⁴

¹General practice, Italy

²General practice, Portugal

³General practice, Austria

⁴Center for Global Health at Aarhus University, Aarhus, Denmark

BACKGROUND & AIM: Exchange Programmes for young and junior GPs are initiatives that have been increasing in popularity over the past years as they provide the unique opportunity for many enthusiastic young GPs to exit their comfort zone and observe different practices. The Hippokrates Exchange programme was launched 15 years ago in Europe and more recently the global Family Medicine 360° (FM360°) that, despite its young age, is being welcomed by many colleagues around the world.

The aim is to present the strengths and the opportunities of such programmes and to present the latest trending data of both, Hippokrates as well as FM360°.

METHODS: The poster will include a description of the exchange programmes and a step by step guide on how to take part into them. There will be also an overview of the activities that many European participating countries have organised nationally (conference exchanges).

RESULTS: Exchange programmes promoted by the Vasco da Gama Movement (VdGM) have grown considerably over the past years. There has been both an increase of the number of participating countries, as well as of the number of colleagues who wish to expand their horizons in the process of globalisation of Primary Care.

CONCLUSIONS: With this poster, viewers should be able to appreciate and understand the potential value of exchange programmes being motivated to participate in such an initiative. By having an overview of the practical

framework of the exchange programmes, they can understand how they may take part in them. Exchanges have shown to be beneficial for both visitors as hosts as they promote participants to get out of their comfort zone and to rethink how they may improve Primary Care provision for the population they work with.

Keywords: Exchange, Hippokrates, FM360°, mobility

An easy 3-steps to join the programmes



Completed exchanges

Years	Hippokrates Programme	FM360°
2012	50	-
2013	84	5
2014	67	5
2015 (until August)	39	23

Logos



FM360° inquiries

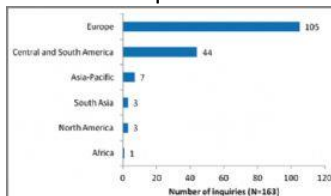


Figure 2: Distribution of received inquiries for the FM360° program, by region

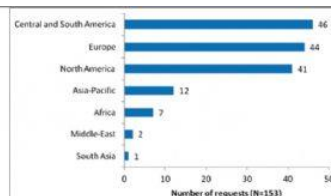
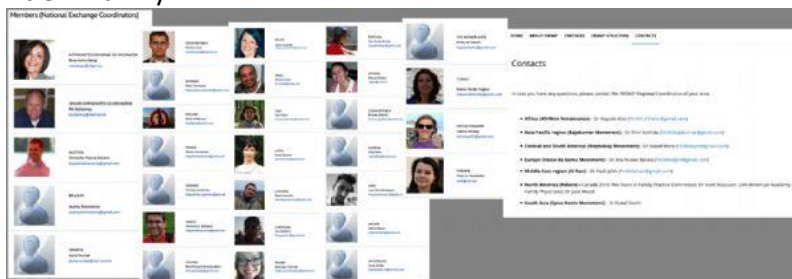


Figure 3: Distribution of requested regions for exchanges through the FM360° program

VdGM Family



P-0895

Preventive culture: First aid for children 11 years old

Ana Cristina Menendez Lopez¹, Lázaro De Castro Peral², Javier Arnés Acevedo¹, Juana Jiménez Martínez³, Francisca María Aceituno Villalba¹, Alvaro Ruiz Risueño Montoya¹, María Dolores Bosque Mata¹, Sonia Falla Jurado¹, Alicia Sánchez Martínez¹

¹San Javier Health Centre

²San Pedro del Pinatar Health Centre

³Torre Pacheco Health Centre

BLACKGROUNDS AND AIMS:

Based on the Resolution of the Ministry of Education, September 7, 1994 (BOE of 09/23/94), which introduces in basic education the "cross-cutting themes" including health education, and in Article 5.2 of the Law on Prevention of Occupational Risks, which include as an aid in the prevention culture: family, teachers and health professionals, we went to school to teach a short course on first aid for children in 6th grade. They answered a questionnaire to confirm the knowledge acquired, also asking for their health vocation. We aim to teach basic and useful concepts in prevention and make them feel interested as well as giving importance to our profession.

METHOD:

It is a cross-sectional study carried out on the total students in sixth grade (95). Using a questionnaire of 12 items previously validated. Statistical Analysis T-student, G-STAT 2.0 software, considered to be significant at $P < 0.05$.

RESULTS:

Women 42.48 %, 51.58 % men, they want to be a doctor when they are older 33.68 % (51.60 % women, 48.40 % men). As for first aid, 78.95 % learned the first thing to be done when dealing with an injured person, within the treatment of bleeding 85.26 % answered correctly. Correct answers regarding the syncope 63.68 %, higher number of failures in hypoglycem (50.53 %). In the Heimlich maneuver almost 90 % both in theory and practice. The 83.51 % answered adequately about burns. The overall result was enormously satisfying, as only 3.16 % had a mark less than 5, with an average rating of 8.01. Finally, we do not find statistically significant difference between the number of correct answers, preference for being a doctor and sex.

CONCLUSIONS:

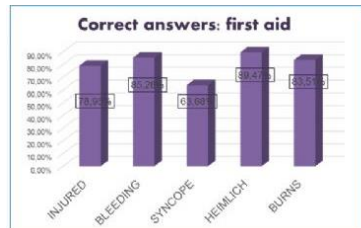
- 1-. Need for health education (family and school). Concept of prevention.
- 2.-To stand out the children's ability to discover and learn

Keywords: First aid, accident prevention, health education

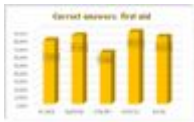
Average score



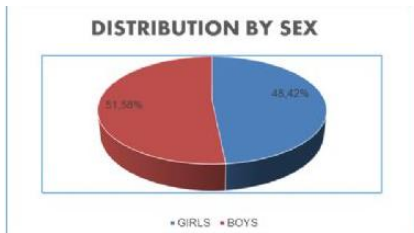
CORRECT ANSWERS FIRST AID



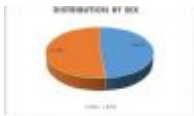
Correct answers first aid



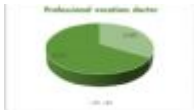
DISTRIBUTION BY SEX



Distribution by sex



Professional vocation doctors



AVERAGE SCORE



PROFESSIONAL VOCATION DOCTORS



P-0896

Evolution of the quality of working life for family and community medicine residents in Spain: preliminary results

Jose Maria Tenias¹, Vicente Gonzalez Roma², Ana Arbaizar¹, Marta Álvarez¹, Jesus Yeves², Ana Hernandez Baeza², Luminita Patras², Francisca Gil Latorre¹, Carmen Fernandez Casalderrey¹, Lina Canet¹

¹Teaching Unit of Family and Community Care, Valencian School for Health Studies (EVES), Valencia, Spain

²Social Psychology Department, University of Valencia, Spain

Background and Aim. To assess the evolution of a set of quality of working life (burnout) indicators and their possible causes in family and community medicine residents during their first year of residency.

Method. A cohort study with repeated measures design. The study population consisted of 63 residents who began their residencies in May, 2013, in the city of Valencia, Spain. Data were collected three times with a self-reporting questionnaire administered at six-month intervals (T1: June 2013, T2: December 2013, T3: June 2014). The response rate was 60.3%, 81%, and 38.1%, respectively. The three dimensions of burnout (emotional exhaustion, cynicism, and self-efficacy) were measured along with three of their determinants (informal support, institutional support, and pressure at work). A descriptive analysis (means and standard deviations) and comparisons between the three sets of responses are presented.

Results. The means obtained for informal support (T1=4.71±0.71, T2=4.3±1.04, T3=3.81±1.10; range of the response scale: 1-6) and institutional support (T1=4.49±1.13, T2=3.99±1.07, T3=3.16±1.18; range: 1- 6) indicate a decrease in the level of support as perceived by residents. The mean observed for pressure at work (T1=4.43±1.02, T2=4.74±0.98, T3=4.81±1.24; range: 1-6) shows an increase over time. Means for emotional exhaustion (T1=3.54±1.21, T2=4.12±1.44, T3=4.60±1.38; range: 1-7) and cynicism (T1=2.11±1.10 T2=2.25±1.04, T3=2.41±1.08; range: 1-7) increased, whereas the means for personal efficacy exhibited a U-shaped pattern (T1=5.14±1.07, T2=4.84±1.02, T3=5.33±0.85; range: 1-7).

Conclusions. The results show that the quality of working life indicators for the family medicine residents under study tended to worsen over the first year of residency.

Keywords: Quality of working life; Psychosocial environment; family and community medicine residents

Figure 1 - Support

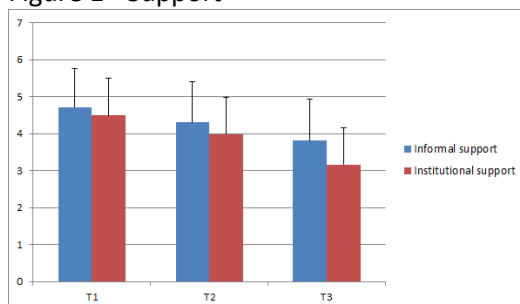


Figure 2 - Cynism and efficacy

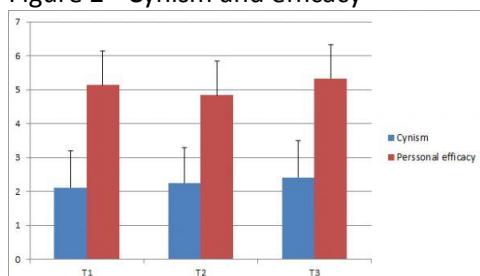
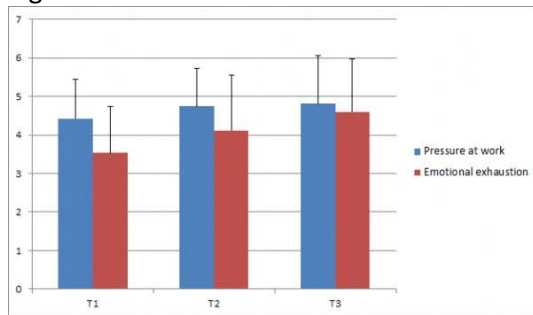


Figure 3 - Pressure and emotional exhaustion



P-0897

Changes in knowledge of and attitudes towards Family Medicine along the degree of Spanish medical students from two different curricula

Maria Candelaria Ayuso¹, Francisco Escobar¹, Jesús López Torres¹, Julio Montoya¹, Juan Manuel Téllez², Francisco Campa³

¹Albacete Area IV Health Centre, Health Care Service of Castilla-La Mancha, C/Seminario 4, 02006 Albacete, Spain.

²Albacete Area V Health Centre, Health Care Service of Castilla-La Mancha, C/, Profesor Macedonio Jinénez s/n, 02006 Albacete, Spain

³Sevilla Faculty of Medicine, Health Care Service of Andalucía, Av. Sánchez Pizjuán, 41009 Sevilla, Spain

Background & Aim

A course in Family Medicine (FM) could dispel possible negative stereotyping about the specialty. When it is preferable, at the beginning or at the end of the degree?

To determine changes in the knowledge of and attitudes towards FM between 2nd-6th year of medical students who completed a course in primary care (PC).

Method

Cohort study. Students from two medical schools (A: course in PC in 2nd year; B: course in PC in 6th year) were asked to respond a questionnaire including the brief CAMF and socio-demographic and academic items. In A they were requested to respond before the PC course beginning, and the day of the final exam; 2nd year students from B at the end of first trimester. All of them were invited to respond at the end of their 6th year.

Statistical analysis was performed with SPSS 17.0: Chi square, Student t/non parametric tests.

Results

In A, at the 2nd and 6th year, 88 and 64 students responded, respectively; 50 and 98 at B.

In 6th year the mean age was 23 in A, 24 in B (p=0.003); 53.1% and 71.0% were women (p=0.008).

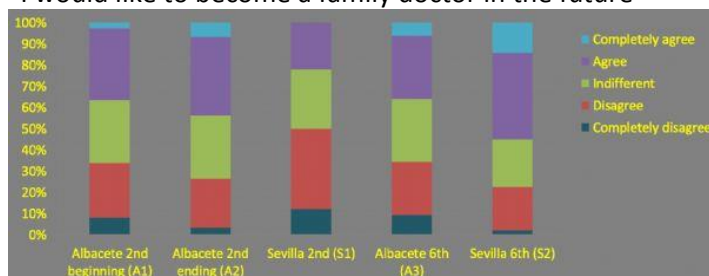
A: after completing the PC course 43.7% students said they would like to become a family doctor in the future (vs 36.5% before the PC course, p=0.028); 22% in B (p=0.01 vs A at the end of 2nd year). At the end of the degree were 35.9% and 55.1%, respectively in A and B (p=0.02).

A: the mean CAMF scores were 15.4 (SD:7.0), 22.7 (SD:7.1), 21.8 (SD:7.1) before and after the PC course and at the end of the degree. B: 13.9 (SD:6.4), significantly lower than A after PC course (p<0.0001), 23.5 (SD:5.7), no significant differences respect to A.

CONCLUSIONS: Student interest by FM showed at their 2nd year decreases at the end of the degree. Although there were no significant differences on CAMF scores, students from B showed

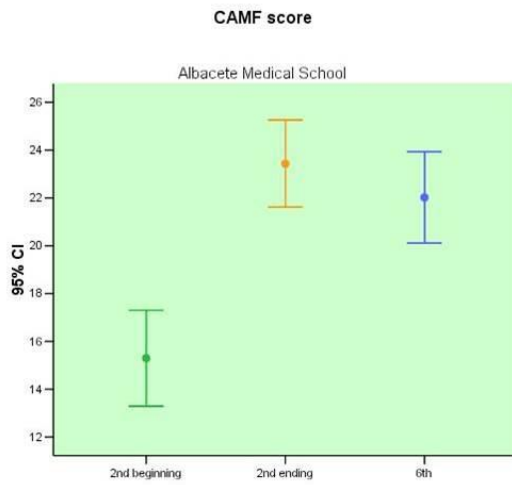
Keywords: Family Practice; Health Knowledge, Attitudes, Practice; Primary Health Care; Questionnaires; Students, Medical

"I would like to become a family doctor in the future"



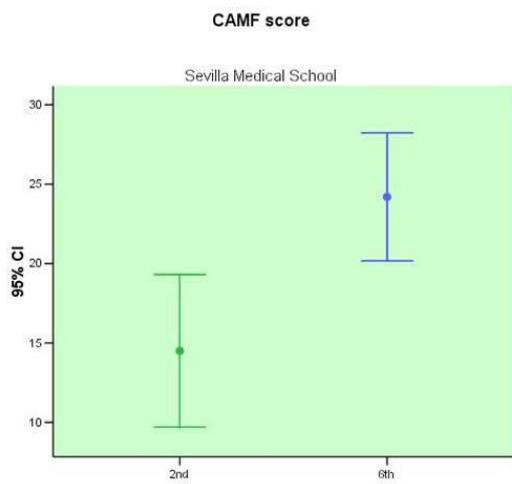
A2 vs A1: p=0.028 S1 vs A2: p=0.01 S2 vs A3: p=0.02

A1 A2 A3



A2 vs S1: $p < 0.0001$

S1 S2



A3 vs S2: no statistically significant differences

P-0898

Last Year Medical Students' Perceptions And Attitudes About The Family Medicine- A Qualitative Study From Ondokuz Mayıs University, Samsun – Turkey

Aysenur Alper Gurz, Fusun Artiran Igde

Department of Family Medicine, Ondokuz Mayıs University, Samsun, Turkey

Background& AIM: Over the last ten years medical students have shown little interest in family practice as a career. In this study, we aimed to investigate medical students' attitudes and perceptions towards the family medicine.

METHODS: In this qualitative study we ran five focus groups involving 40 final year medical students and analyzed factors influencing participants' interest in working in general practice. A trained interviewer recorded, transcribed and subjected to content analysis from December 2011 to February 2013.

RESULTS: Forty students (female 22, male 19) participated with an age range of 22-16 years, described their opinions about the primary healthcare services, attitudes and perceptions towards general practice as a career choice.

Answers on main domains are summarized:

1. Students couldn't answer clearly to the question 'What do you think about being a family physician?'. Most of them said that the flexible working hours, lifestyle and low risk of malpractice make the family medicine attractive but lower prestige, holistic care, uncertain future of the family medicine in Turkey, long term care responsibility were negative effect.
2. Students believe that there is lack of information about the family medicine by public and by health professionals.
3. Students believe that faculty staff introduce the primary care as a punishment place.
4. Most of the students think that family medicine clerkship program change their attitude toward the primary care.

CONCLUSION: In general, although some students find family medicine attractive, it is generally considered as a career of low interest and prestige. Understanding the factors influencing medical students' choice about the family medicine is crucial. In order to increase the interest in primary care, family medicine clerkship program should take place in every medical faculty curriculum.

Keywords: Family Practice; Education, Medical; Undergraduate; Career Choice

P-0899

Health 2.0: Training intervention on health searches on the Internet

Gemma Rovira Marcelino, Beatriz Jimenez Muñoz, Gastón Ezequiel Vázquez Pirillo, Jordi Joseph Vilaplana, Helena Ferrer May, Rodrigo Gonzalo Perla San Martin

EAP Sardenya, Barcelona, Spain

INTRODUCTION:

The population attending primary care services are increasingly turning to the Internet for guidance on health.

OBJECTIVE:

Analyze and define the patient profile and searches performed by health patients through Internet before and after an educational intervention.

MATERIAL-METHODS:

Before-after intervention study with no control group. Non randomly selected participants attending workshops given by previously trained medical personal on web resources and appropriate health media for patients between May and November 2014. Each participant completed a self-administered questionnaire before the workshop and another by telephone 2-3 weeks later. The results before and after training were compared using the McNemar test for dependent samples.

RESULTS:

A total of 63 individuals were included with a mean age of 64 years, 51% were women. The main source of

information was the doctor in 63% of cases comparing with 13% of Internet. Before the workshop, 71% of attendants made Internet searches for health, rising up to 86% after (p 0.02). After the workshop increased the web searches from public institutions, medical journals and patient groups, reducing the use of private and advertising websites. Reliance on the information increased from 30% to 84% after the workshop (p <0.01) and the understanding of it from 37% to 95% (p <0.01). 72% of respondents admitted having no knowledge needed to search the Internet going this result down to 33% after training (p <0.01).

CONCLUSIONS:

Many of our patients uses Internet for making health searchers, being in some cases the main source of health information. A training intervention in health centers could improve knowledge and access to trusted health information online sources for patients.

Keywords: health 2.0, Internet, intervention, workshop

Figure 1: Web searches

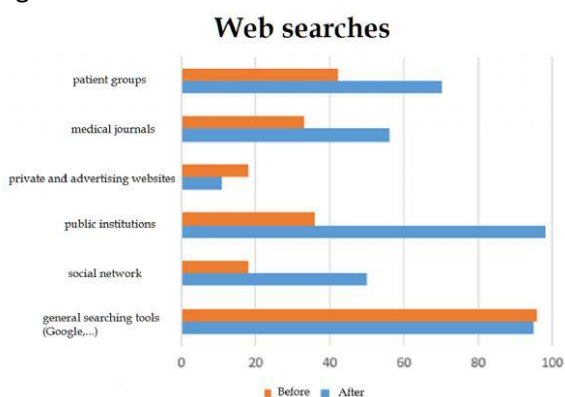


Figure 2: Internet searches for health (%)

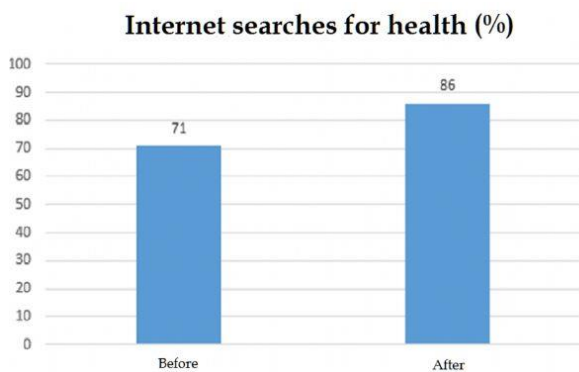


Figure 3: Evolution of obtained information

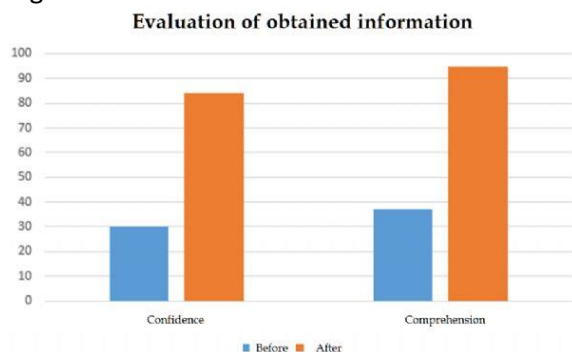
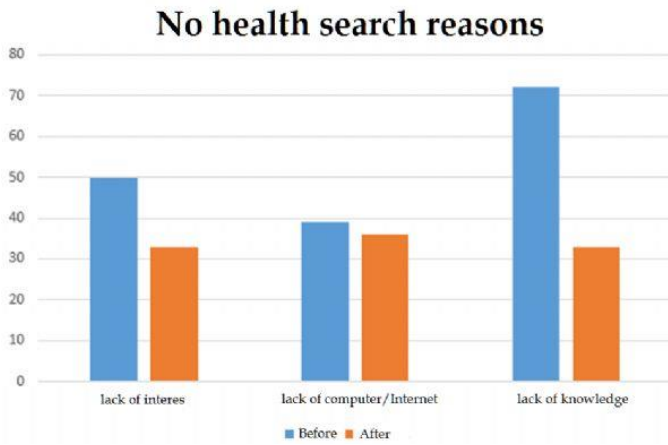


Figure 4: No health searches reasons



P-0900

Simulation-based Family Physicians' Education

Adem Parlak¹, Nehir Parlak²

¹Department of Family Medicine, President Guard Regiment, Ankara, Turkey

²Department of Dermatology, Etimesgut Public Hospital, Ankara, Turkey

INTRODUCTION: A major challenge for medical undergraduates is the application of theoretical knowledge to the management of acutely ill patients. Students must learn to be systematic in their approach to a problem, and develop skills appropriate to working with a clinical team. However, opportunities for students to develop these attributes are limited in undergraduate training. Simulation can help academic members to achieve these aims.

DISCUSSION: Medical education technology shapes and channels medical education policy as research advancements inform new ways to educate and evaluate doctors. Educational technology and policy coalesce with emphases on effectiveness, efficiency, and trainee and teacher morale as new models of medical teaching and testing are introduced. Simulation based education is one of the popular and effective methods of continuing medical education. In health care education, simulation has become increasingly popular in the past few decades, particularly as a method to improve experiential learning environments, and developing simulation as a health care education tool. Support for improved patient safety is one of the primary motivators behind the promotion of simulation in health care. Recently, a number of health care businesses and government bodies also expressed their interest in the support of simulation programs. As a result of this interest, simulation in health care education is growing exponentially across the globe, with health care institutions, organizations, businesses, governments, and licensing and accreditation bodies accepting simulation as a method of learning.

CONCLUSION: Experiential learning, deliberate practice and the ability to provide immediate feedback are the primary advantages of simulation-based medical education. It is an effective way to develop new skills, identify knowledge gaps, reduce medical errors, and maintain infrequently used clinical skills even among experienced clinical teams, with the overall goal of improving patient care.

Keywords: Simulation, family physician, education

P-0901

Necessity for continuing medical education in management and organization at general practice for GPs from Bulgaria-a pilot study

Sevdalina Alekova Todorova

Department of Family Medicine and Ophthalmology, Faculty of medicine, Trakia University, Stara Zagora, Bulgaria

INTRODUCTION:

Organization of primary care is subject to the needs of the patient and the delivery of health services and medical care must meet the following basic principles- accessibility; equity; continuity; quality and efficiency. For the proper and successful management of practices for primary health care is required a good knowledge of health management, marketing and planning, which is necessary to develop and maintain a general practitioner.

GOAL:

The aim of the study was to be determinate the need for family physicians to include in continuing medical education in health management and organization of primary health care, which would be to support and enhance the quality and effectiveness of their activities.

MATERIALS-METHODS:

Our team conducted an extensive survey of general practitioners in Stara Zagora Region, Bulgaria, during the period from January to May 2014. It was applied direct individual questionnaire in strict compliance with the principles of anonymity and voluntariness.

DISCUSSION and RESULTS:

A significant majority of respondents feel the need to enhance and develop their knowledge in the field of health management. The family doctors are willing to engage and participate in specialized courses in management and organization of general practice and to be informed about new, current concepts, strategies and guidelines.

CONCLUSION:

As a manager and organizer of his practice, family doctor daily deal with a range of responsibilities, urgent obligations and short-term tasks. Development of knowledge and enhancement of competence in the field of management, in the acquisition of skills in the application of modern and innovative approaches for efficient, accurate and quality functioning of ambulatory for primary health care will support a prompt resolution and overcome emerging challenges in the activities of the GP.

Keywords: continuing medical education, management, GPs

P-0902

Hypertensive and Diabetics Patients' delivery of care: importance of patients' self-care and life habits choice

Ana Rosa Murad Szpilman, Letícia Batista Nóbrega, Matheus Maia De Souza Mello, José Lucas Carvalho, Rafael Sampaio

Department of Public Health, Vila Velha University, Vila Velha, Brazil

BACKGROUND & AIM

The Arterial Systemic Hypertension and the Diabetes Mellitus are diseases associated to increase of cardiovascular morbidity and mortality. It is important for patients the doctor's appointment, but the medication isolated is not capable of maintaining acceptable glycemic and blood pressure levels. The self-care and the adequate life habits choice are key elements to control these diseases. Objective, through home visits, evaluate the hypertensive and diabetic patients health condition, comparing the life habits and the treatment adherence, stimulating the co-responsibility and health self-care.

METHODS

The medical students with the public unity health professionals performed home visits to a hypertensive and diabetic couple. During the home visits, the medications information and the life habits, like food and exercising, were investigated. The blood pressure and the capillary glycaemia post-prandial were checked. The medical handbooks from previous home visits, group participation, and routine doctor's appointment were analyzed.

RESULTS

Based on the data collected, the woman takes her medications correctly, practices physical activities, eats balanced and preserves her physical and mental faculties. In all home visits, her blood pressure and glycaemia levels were satisfactory. On the other hand, her husband, living under the same conditions, in some home visits presented unsatisfactory levels, probably related to his lack of discipline with his medications, physical activities and eating habits, collected during interviews, by examining his medical handbook and his group participation and number of absences to his medical appointments.

CONCLUSIONS

Medications, doctor's appointment and group participation are essential for hypertensive and diabetic patients' blood pressure and glycaemia levels controlling. However, it was clear that self-care and adequate life habits choices are the only path to actually achieve treatment success, promoting a better quality of life, avoiding unnecessary hospitalizations and extending their life expectancy.

Keywords: Hypertension, Diabetes Insipidus, Quality of life, Public Health, Delivery of Health Care.

P-0903

Genogram: a family therapy wider view based on graphical representation

Ana Rosa Murad Szpilman, Elaine Caliman Vergna, Amanda Ferreira De Paula, Igor Almeida Cunha, Marcela Ramos Pereira, Thompson Dias Viana, Denise Galvêas Terra

Department of Public Health, Vila Velha University, Vila Velha, Brazil

BACKGROUND & AIM

Genogram is a graphical representation of a family, showing its history and familiar pattern, identifying basic structure, functioning and the relationships established among the family members, constituting a patient familiar relational map. The aims of this study were to comprehend the affective relationships among the family members and to identify the stress factors and their influence in the health-disease process of all members.

METHOD

The family genogram was built based on the information collected on home visits and interviews with the health community agent, from august to October 2014.

RESULTS

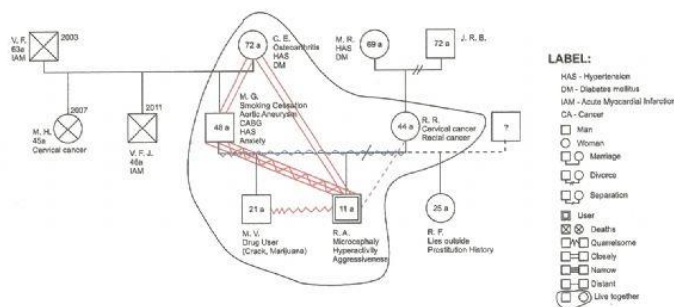
The medical students' choice to build a genogram was based on the difficulties found to define a therapeutics conduct, which would be able to embrace all the family context complexity. Based on this graphical representation, it was possible to identify the patient who needed the most health care, and on the other hand how his needs reflect on his family, generating frustration and anxiety, because his aggressiveness was not been controlled by the medicamentous therapy. In many opportunities, it was possible to observe the mother absence to his son's cares and the overloaded father who had an enormous difficulty to deal with the family's problems. Therefore, the genogram was an important tool to elaborate a therapeutic plan for the entire family, including the psychological children and parents follow-up.

CONCLUSIONS

This family genogram made possible for the medical students and the health unity professionals identify the factors interfering in the entire family health-disease process, showing possible paths to overcome the difficulties on treating this family needs, extrapolating the health needs. It was essential to include the social and relational factors, which without dealing with them, it would not be possible to achieve success on improving this family quality of life, and, therefore, their health conditions.

Keywords: Undergraduate Medical Education, Public Health, Delivery of Health Care.

Family Genogram



Family Genogram performed by the students during their internship to help the delivery of health care to all family members.

Group of Students Picture



The students' group who performed the family approach and studied their genogram.

P-0904

Organizational Identity Interpretations of a Health Higher Education Institution that Prioritizes the Primary Care

Wilton Paulo De Freitas Martins Vieira, Henrique Batista Araujo Santos, Hugo De Souza Motta Moreira, Anny Priscila Gutemberg Pinto, Pedro Thiago Hideyuki Takagi, Ubirajara José Picanço De Miranda Júnior ESCOLA SUPERIOR DE CIÊNCIAS DA SAÚDE (ESCS), BRASÍLIA-DF, BRAZIL.

BACKGROUND AND AIM: The organizational identity is the collective understanding of an institution main characteristics. The identity formation process is linked to the organizational identification, which refers to members' level of involvement inside the organization. This identification is the key to the maintenance of success, and has a strong impact on the construction of a mature and solid image. It was considered that the organizational identity of Escola Superior de Ciências da Saúde (ESCS) – an institution that uses a new methodology to graduate health professionals, prioritizing family health strategy – is inconsistent and not well defined across its members. Consequently, this work aims to analyze members' organizational interpretations of their institution. **METHOD:** It was an analytic, descriptive, transversal, quali-quantitative study, which used data collected from two focal groups and the application of a Likert scale test. All the research subjects were professors and students from the first and last years of the medical and nursery courses, management and administrative boards from ESCS. **RESULTS:** The study indicates that members of the institution confuse the health school with the Health State Office, and think that all courses have similar challenges. The nursery school does not agree that the separation of the health school in two different campuses has an impact on identification. Among all professors and students in the study, only the 6th year medical students agree that the methodology adopted was effectively incorporated. In addition, the fact that ESCS is a young and not well-known institution contributes to the generation of a yet fragile image. **CONCLUSIONS:** Different interpretations of organizational identity were found. The work demonstrates the lack of identification as a result of the low understanding and incongruence of the organizational identity. The development of new studies and strategies are necessary to increase the identification level in the institution.

Keywords: Primary care, organizational identity; organizational image

P-0905

Do we know the inhalation technique in Primary Care?

Maria Ortega, Nuria Sánchez, Laia Gené, Cristina Blaquez, Nora Selvi, Amparo Hervás Consorci d'Atenció Primària de Salut de Barcelona Esquerra, Barcelona, Spain

AIM:

To describe the degree of knowledge of health professionals in Primary Care (PC) about inhalation technique with different devices and more common mistakes

METHODS:

Descriptive study in an urban Primary Care Center, with 32 professional staff, 19 physicians (59.4%), 13 nurses (40.6%). In individual survey, professionals were requested to explain in detail the inhalation technique with 10 different inhalers. The steps to take in the inhalation technique were recorded, considering mistake the omission of indications (according to the SEMFYC's guide of health education in asthma). Variables: Age, sex, professional category, degree of knowledge measured in percentage of correct answers.

RESULTS:

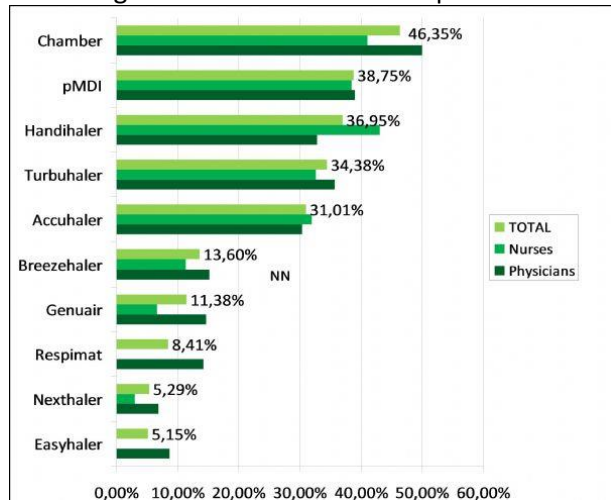
Median age: 42.6 ± 10.9 SD, 87.5%female. Health professionals showed a higher level of knowledge in the use of spacer Chamber (46.35%), Pressurised metered-dose Inhaler (pMDI) (38.75%), Handihaler (36.95%), Turbuhaler (34.38%) and Accuhaler (31.01%). Lower level of knowledge were presented in the use of the following inhalers: Breezehaler (13.6%), Genuair (11.38%), Nexthaler (5.29%) Respimat (8.41) y Easyhaler (5.15%), noting that the last two devices, no nurse referred to know them. In >95% of the surveys, most common mistakes were not to indicate: to bend the head back, not to interpose the tongue, not to blow by the mouthpiece and information for maintaining the device.

CONCLUSIONS:

The degree of knowledge about inhalation technique showed by health professionals, physicians and nurses, in our Primary care Center is low generally, according to others studies. We consider convenient to realized theoretical and practical workshops to update inhalation technique knowledge in both groups

Keywords: inhalers, inhalation technique, Primary Health Care, health personnel

Knowledge of the inhalation technique



Common mistakes

More common indications not pointed out during teaching the inhalation technique (>95% of the surveys)
To bend the head back
Not to interpose the tongue
Not to blow by the mouthpiece
Device maintenance

P-0906

Use of Electronic Health Record (EHR) in the consultation: the impact of a training intervention on physician-patient interactions

Cédric Lanier¹, Melissa Dominicé Dao¹, Patricia Hudelson¹, Bernard Cerutti², Noëlle Junod Perron¹

¹Division of primary care, Geneva University Hospitals, Geneva, Switzerland

²Geneva Faculty of Medicine, Geneva, Switzerland

INTRODUCTION:

Electronic health records (EHR) are now widely used in outpatient medical settings. Although the first minutes of the consultation are considered essential to establish a good physician-patient relationship, little is known about how doctors use EHR while initiating the consultation. The aim of the study was first to evaluate EHR use in terms of physician-patient interaction and second to assess the impact of training on how to use computer/EHR during clinical encounters during the first 10 minutes of the consultation.

METHODS:

A pre-post study was conducted at the Division of primary care of the Geneva University Hospitals. 24 residents were invited to take part in a 3-month training program focusing on how to use computer/EHR during clinical encounters. The intervention included two group training sessions and 2-4 individual supervisions based on residents' own videotaped encounters. Residents were asked to videotape 3-4 encounters before and after the intervention. Outcomes measures were objective analysis of computer use in relationship with the content of the interaction (using the Roter interaction analysis system).

RESULTS:

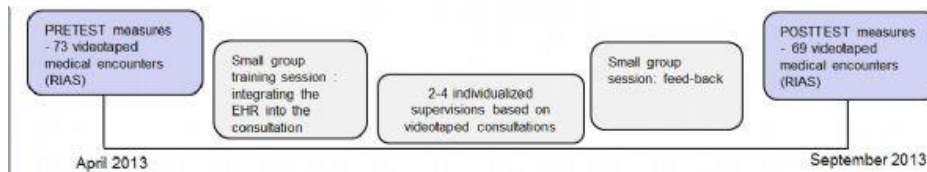
17 residents took part in the study. Pre-intervention, the first 10 minutes of the physician-patient interaction included the following contents: 29% emotional, 17% medical, 11% therapeutic and 6.6% psychosocial. The time spent using EHR during each type of discourse was: 29.8% medical, 26.6% therapeutic, 24.5% psychosocial and 21.1% emotional. Post-intervention, the overall proportion of time using EHRs decreased significantly (53.2 vs 49.8% $p < 0.0001$) and more specifically during psychosocial discourse (24.5% vs 9.76% $p < 0.0001$).

CONCLUSION:

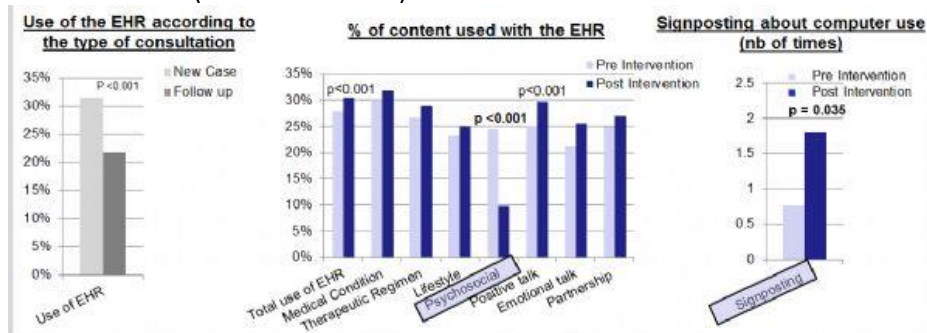
Residents use the EHR 30% of the time during the first 10 minutes of consultation. The intervention had a positive impact on physician-patient relationship since it reduced residents' use of EHR during sensitive issues such as psychosocial discourse.

Keywords: Electronic health records (EHR), physician-patient relationship, education

Measures and intervention



Use of the EHR (first ten minutes)



Comparing the Patient-Centered Approach Levels of the Family Physicians, Psychiatrists and Residents

Sukriye Bayrak Ozdin, Fusun Artiran Igde

Department of Family Medicine, Ondokuz Mayıs University, Samsun, Turkey

Background&AIM: Biopsychosocial model is an integrated approach that includes the assessment of the interactions among an individual’s life story, living conditions and state of health within the biological-psychological and social conditions. Biopsychosocial model reflects to the clinical practice by means of patient-centered clinical method. The importance of patient-centered medical advisory reveals especially in primary care and psychiatry. In this study, it is aimed to assess the patient-centered approach levels of the family physicians, psychiatrists and psychiatry residents.

MATERIALS-METHODS: This descriptive, cross-sectional type study carried out multicenter between March-November 2014, was conducted across the country in the form of electronically attendance by means of the e-mails and in the form of manual application. Patient Practitioner Orientation Scale and a survey involving questions to determine sociodemographic characteristics were carried out to the 405 physicians, including 222 family practitioners and 183 psychiatrists/psychiatry residents. Data was assessed with the SPSS 21.0 package software, statistical significance was considered as $p < 0.05$.

RESULTS: 222 of the participants are family physicians (54,8%) and 183 of them are psychiatrists and residents (45,2%). Participated in the study, 245 physicians are women (60,5%) and 158 physicians are men (39%). The average of family physicians’ total PPOS scores is calculated as $2,93 \pm 0,41$; and the same average is $3,31 \pm 0,39$ for the psychiatrists. The averages of PPOS scores are considered too low for both areas of expertise. The patient-centered approaches of the family physicians are significantly lower than those of the psychiatrists ($p: 0,00$).

CONCLUSION: In this study it is concluded that physicians do not practice the patient-centered clinical method sufficiently, especially the biopsychosocial approaches of primary care physicians’ are more inadequate. Raising the consciousness of physicians and focusing on this issue in education would be effective in the physicians’ perspectives and their clinical practices.

Keywords: Patient-centered care, models psychological, family practice, psychiatry

Comparing of subgroups of PPOS and areas of expertise

PPOS	Speciality	n	M	SD	p*
"Sharing"	Family Medicine	222	2.93	0.44	0.00
	Psychiatry	183	3.29	0.40	
"Caring"	Family Medicine	222	2.88	0.51	0.00
	Psychiatry	183	3.32	0.49	
Total	Family Medicine	222	2.93	0.41	0.00
	Psychiatry	183	3.31	0.39	

*Independent-samples T-test; n: number, M: average of PPOS score, SD: standard deviation

P-0908

Exchanging verbal and no verbal language

Anna Maria Pedro Pijoan¹, Gemma Rovira Marcelino², David Botaro Parra¹, Berk Geroglu xx³, Joana Neto xx⁴, Christopher Patrick Reichel xx⁵, Demet Merder Coskun⁶, Ivana Babic xx⁷

¹Consorti Sanitari Integral, Barcelona, Spain

²Eap Sardenya, ACEBA, Barcelona, Spain

³Izmir Tepecik Training and Research, family Medicine Clinic, Turkey

⁴Unidade de saúde familiar Corino de Andrade, Oporto, Portugal.

⁵University clinic St Poelten, Karl Landsteiner University for Health Science, Viena, Austria

⁶Marmara University medical faculty, department of family medicine, Turkey

⁷Family medicine practice Ivana Babic, Sveti Martin na Muri, family medicine, Croatia

Objective exchange experience: Provide an opportunity for residents and young physicians family medicine in various European countries, to exchange ideas and projects in order to improve skills in primary care. The frequent aim it is to observe differences of health systems, but also important to learn communication skills in primary care.

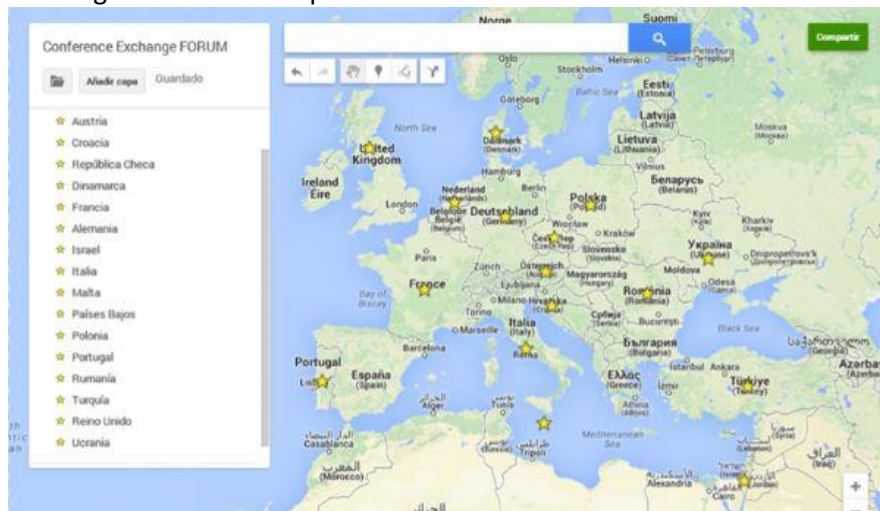
Description: occurs in the organization of the first forum of Vasco Da Gama movement in 2014, an exchange experience for physicians from various countries in Europe during two days before. Committee was formed to establish a program. Several teaching units were contacted to receive GP trainees and young GP to participate. Tutors with basic english or other foreigner language were interested in hosting in their clinics. Two days they saw how was a center and its patients. They participated centers in both urban and rural primary care, emergency care centers and primary care research units. But committee had understood the situation of our GP visitors, so for help decided to write a dictionary (spanish-catalan-english) of the main important words to continue a conversation in appointment and also technical words. Nevertheless, without leaving the importance of no verbal language needed when you don't understand the language.

RESULTS: More than 30 young doctors from 16 European countries participated. They collaborate in translating the important words to their own language so all would share and increase our knowlegde. We received the translations in italy, french, turkish, german, polish, dutch, portuguese, czech.

CONCLUSIONS: Applicability With such exchanges can achieve cultural exchange and open mind family medicine, learn essential skills in the consultation. We can learn from experiences of other colleagues, but our more precious tool in Primary care is the communication, verbal and non verbal. Many more experiences we needed to measure the impact on training and practice of primary care physicians.

Keywords: exchange, primary health care, verbal language,

exchange Forum BCN Map



exchange table

Age	Sex	Marital Status	Education	Specialty	Work Experience	Income	City	State	Country	Year	Sample Size
24-35	Female	Married	High School	Family Medicine	1-5	10000	Samsun	Samsun	Turkey	2014	215
24-35	Male	Married	High School	Family Medicine	1-5	10000	Samsun	Samsun	Turkey	2014	118
24-35	Total										403
24-35	Unspecified										2
24-35	Total										405

P-0909

Comparing the Empathy Levels of the Family Physicians, Psychiatrists and Residents

Sukriye Bayrak Ozdin, Fusun Artiran Igde

Department of Family Medicine, Ondokuz Mayıs University, Samsun, Turkey

Background&AIM: The importance of patient-centered medical advisory and empathy reveals especially in the primary care and psychiatry. In this study, it is aimed to assess the empathy levels of the family physicians, psychiatrists and psychiatry residents.

MATERIALS-METHODS: This descriptive, cross-sectional study carried out multicenter between March-November 2014, was conducted across the country in the form of electronically attendance by means of the e-mails and in the form of manual application. The Jefferson Scale of Physician Empathy and a survey involving questions to demonstrate sociodemographic characteristics were carried out to the 405 physicians, including 222 family practitioners and 183 psychiatrists/psychiatry residents. Data was assessed with the SPSS 21.0 package software and statistical significance was considered as $p < 0.05$.

RESULTS: 222 of the participants are family physicians (54,8%) and 183 of them are psychiatrists and psychiatry residents (45,2%). The majority of the participants were between 24-35 years old physician (n:289, %71,4), and the average age was calculated as 33,84 (SD: 8,63). The average of family physicians' total JSPE scores is calculated as $78,79 \pm 11,45$, and the same average is $81,78 \pm 8,33$ for the psychiatrists. The average of psychiatrists' total empathy scores is found significantly higher than that of family physicians ($p: 0,003$).

CONCLUSION: It is concluded that especially the primary care physicians' empathy level is more inadequate and physicians generally do not adopt the patient-centered clinical methods. It can be thought that this situation is related to the imperfect knowledge of physicians, their inability to allow enough time for their patients due to the busy schedules and their lack of motivation due to the changing health policies. Thus, it would be guiding for physicians to raise the consciousness of them, discuss the subject efficiently in medical education and in-service training and to make more researches and studies.

Keywords: Patient-centered care, models psychological, empathy, family practice, psychiatry

Table. The demographic data of the participants

Gender	n	%	The Percentage of Specified
Female	215	60.5	60.8
Male	118	39.0	39.2
Total	403	99.5	100.0
Unspecified	2	0.5	
Total	405	100.0	
Age Groups	n	%	The Percentage of Specified
24-35 years old	289	71.4	72.3
36-45 years old	58	14.3	14.5
46-55 years old	36	8.9	9.0
56-65 years old	17	4.2	4.3
Total	400	98.8	100.0
Unspecified	5	1.2	
Total	405	100.0	
Marital Status	n	%	The Percentage of Specified
Single	147	31.2	31.4
Married	236	58.3	58.6
Total	403	99.5	100.0
Unspecified	2	0.5	
Total	405	100.0	

n: number, %: percent

P-0910

Arterial Hypertension treatment adherence: essential for blood pressure control

Ana Rosa Murad Szpilman, Adilson Segades Leite, Moysés Ost Damm Martins, Bruno Fianco, Luiz Felipe Cunha Nascimento, Gustavo Oliveira Pacheco

Department of Public Health, Vila Velha University, Vila Velha, Brazil

BACKGROUND & AIM

The Systemic Arterial Hypertension is one of the most prevalent diseases in the world, demanding special attention from the public health systems, dedication from the health professionals, and specific approach in the medical graduation process. In Brazil, the hypertension prevalence in adult population ranges between 15 to 20%. It is well known that effective treatment can control blood pressure and reduce its impacts in the population health, also decreasing the health systems costs. This study aimed to evaluate the relation between treatment adherence and hypertension control.

METHODS

The Vila Velha University Medical Students with the Public Health Unity team analyzed the hypertensive medical handbooks, their group participation, the data collected through home visits and their attendance to doctor's appointment. The data was collected from March 2013 to March 2015. The raised information were based on the World Health Organization parameters, such as blood pressure, abdominal circumference and the Body Mass Index.

RESULTS

The Public Health System in Brazil organizes the Primary Health Care through Family Health Strategy, which works with territorial basis; interdisciplinary attention with a health professionals' team. The area that this group of students performs their internship has four Community Health Agents who take care of four micro areas. The total amount of Hypertensive patients registered in this area were 637. After data analyzes, 89% of the patients presented improvement in their blood pressure control, showing that the hypertensive groups, the doctor's appointment and the home visits are achieving their GOAL: improve life quality for those who suffer from a chronic disease that can be controlled, by stimulating the patient treatment adherence.

CONCLUSIONS

Treatment Adherence incentive programs can contribute to better blood pressure control, granting better quality of life and life expectancy, besides possible decreasing in avoidable hospitalizations and complications consequence of this condition.

Keywords: Hypertension, Quality of life, Public Health, Delivery of Health Care.

HiperDia Group Meeting – Hypertensive and Diabetic Patients



The students participating in one HiperDia Group Meeting with the unity health team. It can be noticed the blood pressure checking in the back, the weight and high checking in the front on the right and the students taking notes on the medical handbooks in the front on the left.

P-0911

Actualization of continuing medical education of general practitioners concerning hereditary pathology

Sevdalina Alekova Todorova¹, Borislav Nikolov Popov², Veselina Petrova Tacheva³

¹Department of Family Medicine and Ophthalmology, Faculty of Medicine, Trakia university, Stara Zagora, Bulgaria

²Department of Molecular Biology, Immunology and Medical Genetics, Faculty of Medicine, Trakia University, Stara Zagora, Bulgaria

³Department of Molecular Biology, Immunology and Medical Genetics, Faculty of Medicine, Trakia University, Stara Zagora, Bulgaria

INTRODUCTION:

In his practice the GPs is often faced with patients with hereditary diseases and predispositions / patients with monogenic diseases, congenital anomalies, socially important multifactorial diseases, etc./. There of is often required to speak competently and clearly reasoned opinion for the genetic analysis, optionally interpret obtained results, provide an accessible way for the patient information on a hereditary disease and to point him to the appropriate specialist.

GOALS:

1. To examine the knowledge of GPs on clinical manifestations and existing opportunities in Bulgaria for early diagnosis, prevention and treatment of their patients with hereditary pathologies.
2. To investigate the motivation and engagement of GPs in organized thematic courses, informing them about innovations in the field of medical genetics and genetic research.

MATERIALS-METHODS:

It was conducted extensive sociological survey among general practitioners in Stara Zagora region for the period December 2013 - March 2014.

DISCUSSION and RESULTS:

74% of respondents indicate that they have in their practice for primary care patients with hereditary pathology. 91% of respondents have studied the discipline "Medical Genetics" during their training for the acquisition of higher medical education.

However, vast majority of GPs consider that they are not enough familiar with the clinical picture of genetic diseases / 79 %/, with contemporary methods for diagnosis of genetic diseases / 93 %/ and with the main approaches to treatment and prevention of hereditary pathology / 88%/. 97% of family doctors need additional information about opportunities in the country for the early diagnosis of hereditary pathology, current approaches to follow-up and treatment.

CONCLUSION:

GP has a key role in the prevention of hereditary pathology. To achieve this goal structured and thematic continuing training courses are necessary, which will inform GP of the current aspects and developments in the field of genetics

Keywords: GPs, Medical Genetics, Continuing medical education

P-0912

Tuberculosis data analyzes: an accurate portrayal of Vila Velha Municipality tuberculosis reality, in Brazil

Ana Rosa Murad Szpilman, Ludimilia Henrique De Souza, Erivelto Pires Martins

Department of Public Health, Vila Velha University, Vila Velha, Brazil

BACKGROUND & AIM

In Brazil, tuberculosis is a priority among the promoted Health Ministry politics, establishing the Tuberculosis Controlling National Plan, in all Brazilian municipalities. This study emerged from the medical students observations during their internship in a public health unity in Vila Velha, Brazil. The students with the unity professionals aimed to be familiar with the accurate portrayal of Vila Velha Municipality tuberculosis reality, in order to comprehend the assisted territory and community, improving the delivery of health care quality.

METHODS

The first step was tuberculosis data analyzes, in the diagnosed patients' medical handbooks in the public health unity where the internship takes place, and in the Disease Notification System. Afterwards, in order to complement the data, the students interviewed the responsible for Vila Velha Tuberculosis Controlling Program. After verifying the municipality data, the students started new cases diagnosed observation and notification in the public health unity, during their internship, trying to conquer accurate unity data analyzes.

RESULTS

Based on the interview, in 2014, in Vila Velha municipality, there were 145 new cases of tuberculosis notified, 3 deaths, 7 cases of withdrawal treatment and 21 cases of cure. It was difficult to raise the unity data, due to some reasons acknowledge by the research, such as lack of professionals' team mobilization and participation; lack of professionals' autonomy in the patient evolution follow-up, decreasing their role and involvement; lack of medical handbooks' correct filling up; lack of data basis correct feeding; difficulty to ensure patients return, because of work absence and lack of accurate information given by the professionals; lastly, there was not a government incentive to correct data registering.

CONCLUSIONS

Accurate tuberculosis data analyzes provide the professionals the possibility to recognize the assisted community reality, organizing the work process and improving the delivery of health care quality.

Keywords: Epidemiology, Tuberculosis, Public Health, Delivery of Health Care.

P-0913

Systemic Arterial Hypertension: is it possible to be hypertensive and have a quality of life?

Ana Rosa Murad Szpilman, Antônio Freitas Netto, Diogo Pena Dos Anjos, Manoella Garcia Carrera, Gustavo Oliveira Pacheco, Hele Nice Faria Santos Alves Haddad

Department of Public Health, Vila Velha University, Vila Velha, Brazil

BACKGROUND & AIM

The Vila Velha University Medical students, with the public health unity professionals, promote preventive actions and health promotion activities to the assisted population. The major focus is in hypertensive delivery of health care, due to its prevalence. The Systemic Arterial Hypertension risk and aggravating factors can be divided into changeable and unchangeable. The changeable factors include social habits, such as feeding, physical activities, medication use frequency, alcoholic beverage ingestion, narcotic and toxic substances use and socio-economic factors. The aim of this study is to analyze the aggravating factors interference on hypertensive quality of life, assisted in a public health unity inserted in Brazilian Primary Health Care.

METHODS

The medical students, in a public health unity, collected data from hypertensive group meetings, home visits, interviews with the unity professionals about the hypertensive habits and clinical history, medical handbooks evaluation, doctor's appointment follow-up, formulary used to questioning the hypertensive about their habits, besides the clinical examinations results, the blood pressures measurements, the weight and high measurements and body mass index, and the abdominal circumference.

RESULTS

This student group has been attending the internship in the same unity and community for one year and a half. They created a bond with the hypertensive patients assisted and participate in all their activities, described above in the methodology. The patients who attend the meetings and the doctor's appointment, who control their feeding habits, who practice some physical activity, do not drink or use narcotic substances, take their medication regularly, and control their body weight, are more likely to control their blood pressure.

CONCLUSIONS

The hypertensive patient can modify the changeable factors, being the most effective path for improving the hypertensive quality of life. The health professionals are not able to succeed by themselves. It is essential to increase their autonomy and co-responsibility.

Keywords: Hypertension, Quality of life, Public Health, Delivery of Health Care.

Group Meeting – Hypertensive Patients



The students participating in hypertensive patients' Group Meeting with the unity health team. It can be noticed the blood pressure measurements in the back, the weight and high measurements in the front on the right and the students taking notes on the medical handbooks in the front on the left.

P-0914

TEEN SAFE SEX project. The general practitioner meets students of high schools

Massimiliano Lucarelli¹, Tecla Mastronuzzi², Angela Stufano¹, Ivo Vulpi²

¹Interdisciplinary Scientific Association of both Family and Community Medicine - ASSIMEFAC

²ASL Bari, Italy

Background

Sexually transmitted diseases (STD) are infective diseases spreading all over the world which weigh heavily on public health and health care cost. The more effective intervention with the best costs/benefits ratio is prevention.

Aim

- to inform students of high schools about risks related to STDs, about prevention and early diagnosis by general practitioners (GPs).
- to improve relationship based on trust between GPs and teenagers.

Design

The project was carried out with the patronage of the city administration council and the general medical council of Bari. In 2013 and 2014 GPs gave presentations about STDs to classes of students. 2342 students took part in interactive lessons that included a pre-meeting questionnaire to assess the pre-existing knowledge, a power point presentation, a discussion, a post-meeting questionnaire to assess the acquired knowledge. At the end of the meeting students also filled in a satisfaction questionnaire.

Results

The number of right answers in the post-meeting questionnaire increased significantly, compared with the results of the pre-meeting questionnaire.

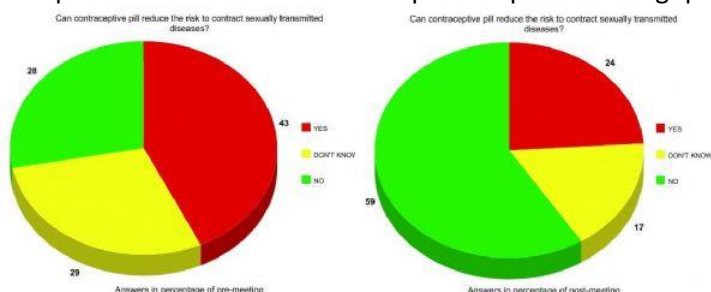
Students showed high level of satisfaction concerning the educational project.

Conclusion

Increasing awareness on STDs can be an important contribution to prevent them among teenagers. The relationship between GPs and teenagers can be enhanced by an educational initiative.

Keywords: "sexually transmitted diseases" "teenagers" "prevention" "school health" "general practitioners" "general practice physicians"

Comparison of the answers to the pre and post-meeting questions (expressed in percentage)



The pie charts illustrate the results about the question: "Can contraceptive pill reduce the risk to contract sexually transmitted diseases?". The right answers (in green) increased significantly after the meeting.

P-0915

Teaching Ethics and Law for Freshmen Medical Students: lesson learnt from a brand new school in eastern Indonesia

Harry Allan Papendang¹, Trevino Aristarkus Pakasi²

¹Faculty of Medicine Universitas Papua

²Division of Family Medicine, Department of Community Medicine, Faculty of medicine Universitas Indonesia Background. Law and ethics are important in medical practice, and every doctor needs to know the issue locally and globally. It is therefore, since the first year, students were taught school. In the Universitas Papua, the teaching was done in semester 2, and this study was aimed to describe the result.

Method. The second semester students were given the ethics and law for two weeks in a block module. The teaching method was adult learning, student centered and achieving competencies as written in the curriculum. The evaluation was cross sectional, students filled questionnaire related with the topics, teachers, method using Likert scale; and was crosschecked with the result of the written assessment and discussion in the small group. There was also a questionnaire that they could write complain and suggestion.

Results. Overall, students were enthusiastic in this module as most of them agreed and strongly agreed for the topics and learnt much in the module. Most of them passed the written exam (88%), with some notes. i.e. the question related with malpractice was not properly answered as more than 90% were not correct. In the discussion, students had little ideas about the situation in the practice that made them difficult to understand malpractice. There was also problem for students to determine prima facie. This was the ethical topics were debatable and students had no exposure to clinical situations prior to the module.

Conclusion. Teaching ethics and law were important for students, as early as possible. However it is worth to note that, early exposure to clinical situation was important to understand many of the ethical issues. It is recommended that ethics and law should be repeated and inserted in the discussions during studying other modules.

Keywords: ethics, medical law, teaching, clinical exposure

P-0916

Effectiveness in training on patient-centred care in general practice

Radost Spiridonova Asenova, Levena Kireva, Zornitsa Ambareva, Daniela Mileva, Maria Semerdjieva, Gergana Foreva

Dept of General Practice, Medical University Plovdiv

BACKGROUND:

Person-centred care (PCC) is an area of competence for general practitioners relating to the context of patient as a person, about how they understand the patient and their ability to work in partnership with patients. Its implementation in Bulgarian primary care is relatively new and there are few researches in the field.

Research question:

To study the basic knowledge of GPs about patient-centred care and to assess the effectiveness of training on the topic.

METHODOLOGY:

Training, divided in three modules, has been performed with 54 GPs - 20 males (37.0%) and 34 females (63.0%). The duration of modules was 1.30h each, led by two moderators. A pre- and post-test among the GPs has been done, using an original questionnaire.

The results have been processed by SPSS 17.0 version, using descriptive statistics and nonparametric test (Chi-square).

RESULTS:

The questionnaire studies the GPs' perspectives and understanding about patient-centred care in general practice.

We found that the most unclear for GPs is how to implement so broadly defined area in their daily practice. Only 37.0% of GPs have been agreed with the importance of health care that meet patients' needs and preferences and 35,2% have pointed out the aspect - continuity of care. The positive aspect is the fact that GPs have accepted PCC as their main competence. There was a significant difference comparing the results from the pre- and post test, $P < 0.001$.

CONCLUSIONS:

The recognition and the practice implementation of the patient-centred care approach is of a great importance and requires further education of GPs in Bulgaria, it is related to the relatively new health care system organization in order to strengthen GPs' position.

The research is supported by the intra-university grand № HO - 15/2014 Poly-pharmacy and multimorbidity among geriatric patients in general practice – implementation of patient-centred approach.

Keywords: general practice, patient-centred care, education

Patient-centered care domains

Domains	Test %	Re-test %	P; χ^2 ; r
Adoption of a person-centred approach in dealing with patients and their problems, in the context of their circumstances	44,4	79,6	$P < 0,001$ ($\chi^2=14,19$) $r=0,36$
Use the general practice consultation to bring about an effective doctor–patient relationship, with respect for patient's autonomy	63,0	92,6	$P < 0,001$ ($\chi^2=14,19$) $r=0,36$
Communicate, set priorities and act in partnership	68,5	94,4	$P < 0,001$ ($\chi^2=12,03$) $r=0,33$
Provide long-term continuity of care as determined by the needs of patient, referring to continuing and co-ordinated care management	35,2	74,1	$P < 0,001$ ($\chi^2=16,48$) $r=0,39$

P-0917**Effectiveness of health education in waiting room of pensioners bank in improving elderly health perspective, behavior and morbidity**

Aria Kekalih¹, Fithriyyah Shalihati², Idqan Fahmi²

¹Community Medicine Department, Faculty of Medicine Universitas Indonesia, Jakarta-Indonesia

²Graduate Program of Management and Business – Bogor Agricultural University (IPB), Bogor-Indonesia

INTRODUCTION:

Elderly has high risk for typical age-related diseases like degenerative disease, syndrome metabolic and also infectious disease. Elderly need intensive exposure of health education to recognize and prevent the diseases. Pension bank is a place where elderly has chance to gather and spend significant time waiting to withdraw pension money every first week of the month. This condition initiated bank cooperated with trained primary physician to perform specific health education program to elderly in the waiting room. This study investigates how health education and consultation program in pension bank would be effective to change elderly health perspective, behavior and morbidity.

METHOD:

We investigated 436 elderly in 14 cities of bank branches in Indonesia and divided them in two groups: those who participated (n=342) and never had health education in waiting room (n=94) to compare their health perspective, behavior and morbidity.

RESULT:

Participated group had significant increase of health perspectives, especially about importance of regular health checking and maintaining healthy diet (p<0.05). They also had fewer case of chronic illnesses (p=0.01, OR 0.51 CI95% 0.30-0.89). Their active lifestyle was also increase but not significant (p=0.164)

DISCUSSION:

Health education in the waiting room of pension bank was proven effective to improve health perspective and decrease long term illnesses in elderly. With standardized education module and cooperation with trained health educator, this approach of optimizing queuing time in waiting room of pension bank can be applied to intensify access to health education for elderly.

Keywords: Health education, elderly, morbidity, Primary physician

P-0918**Community Health Agent -subject of action in the work completion of the Foundation Degree - their role in health team**

Renata Pekelman¹, Marielly De Moraes²

¹Health Technological Education and Research Center/ GHC School-Hospitar Conceição's Group, Porto Alegre, Brazil

²Education Department, Rio Grande do Sul University, Porto Alegre, Brazil

INTRODUCTION: Community Health Agent (CHA) is the professional in primary care that has held its training at work. 10 years ago it was decided on their training, a Technical Degree (1200 hours), yet not mandatory. This study is an analysis of the conclusion's papers, whose theme was the Community Health Agent as the subject of his action and identify how the ACS describes and defines his work through their writing; the paper was a condition to get their technical degree in CHA / GHC School / RS-Brazil. **METHODOLOGY:** It is a qualitative research, document database. Data analysis was made through content analysis method with four empirical categories: work and identity; mobilization and achievement; teamwork and the ACS's clinics. **RESULTS:** work and identity shows the territory as a contradictory space for the ACS because he should take on more of a role while he is team and community, the experience of the territory also provides an opportunity an enlarged understanding of health, building a vision completeness for health interventions; in category mobilization and achievement, identifies an individual and collective self constitution process, the record of the history reveals itself a sense of empowerment, recognition of courage for social fightings, the sense of leadership; teamwork appears as the essence of the ACS work himself, although point to a nuclear knowledge to be shared with the

team. Alterity as the essence for the development of staff; the ACS clinics, practices both in homes and in other areas of the territory can be consider a clinical practice: health care, a watchful eye to the risks and vulnerabilities, an intimate clinic with secrets, listening and welcomig. CONCLUSION: The great potential of CTACS is in power conceptualize the empirical knowledge, learn and master the technical language, create opportunities for reflection on the work.

Keywords: Health education, Communit Health Worker, health team

P-0919

Problem-based learning as a way to improve the postgraduate education of general practitioners in diabetes management

Victoria I Tkachenko

Shupyk National Medical Academy of Postgraduate Education

Background. Problem-based learning proved positive results at undergraduate education and only a few works (Paul B Smdits, 2003) showed its application at postgraduate education. Department of Family Medicine and Diabetology Department at NMAPE developed together 2-week postgraduate course in type 2 diabetes management at primary care with using methods of distance-learning and problem-based learning.

The aim is to analyze results of implementation of postgraduate course with distance-learning and problem-based learning during continuing professional development of general practitioners (GPs) in diabetes management.

Materials and methods. We conducted a survey of 10 GPs after postgraduate course in diabetes management to assess the implementation of the new methodology. Statistical analysis was performed using Exsell 2007, SPSS.

Results. Problem-based learning was estimated by GPs as more interesting course, than traditional one. GPs showed greater interest, noticed an unusual approach in studying material and better assimilation because of standardized simulation cases. Long-term effects at 1 year after study showed better involvement of GPs to diabetes management, better results of implementation of diabetes management guideline in general practice and preserve knowledge for a long time, that demonstrated the effectiveness and novelty of this method in Ukraine. In addition, the basic principles of patients' education according to a structured training program, recommended by WHO and IDF, and new method of using 4 interactive gaming maps, developed by IDF (2008), were presented to GPs, that allow better motivate patients to self-management of diabetes.

Conclusion. The developed 2-week postgraduate course in type 2 diabetes management at primary care improves the quality of diabetes primary care and can be use widely as part of continuing professional development. The use of problem-based learning proved the higher interest of GPs and better assimilation of the material during postgraduate education, as well as improvement of the quality of diabetes primary care in general.

Keywords: problem-based learning, postgraduate education, diabetes management

P-0920

FAMILY DOCTORS ACROSS EUROPE (FDAE):enhancement in education and long life learning for Italian GPs with EU funding

Laura Viotto, Claudia Felici, Ernesto Mola, Massimiliano Lucarelli

Interdisciplinary Scientific Association of both Family and Community Medicine - ASSIMEFAC,Italy
Background

The post-graduate education in general practice in Italy is not a University specialization but a triennial vocational training referred to the 21 Italian Regions. This fact has excluded the Italian trainees and trainers from european exchange, like Erasmus, and the Italian school from european research.

Aim

FDAE wants to fund european exchange among trainees of the vocational training in general practice of Italy in Finland and Spain.

FDAE wants to promote exchange also among trainers of the three countries to foster european cooperation in education and research.

Methods

The project last two years. Subjects involved in the project are: trainees and trainers of the Italian vocational training in general practice and the board of the Italian scientific association ASSIMEFAC.

Three areas have been indicated in the exchange project:

a) Area of continuing education in partnership with Galicia – Spain - and Finland: trainees will be involved in the job training concerning organization and management of primary care structures while trainers will be involved in the job shadowing

b) Area of internationalization in partnership with EU Commission - Bruxelles: trainees and trainers will be trained in development and management of project funding by European Union

c) Linguistic area in partnership with English schools of Malta: reserved only to trainers, it consists in language courses of medical English.

Budget requested: 60.000 €

Results

This project has been submitted in March 4th,2015,and we are waiting for the outcome

Conclusion

Expected results are enhancing educational levels for young and professionals GP fostering free circulation of family doctors in Europe encouraging cooperation in education and research in general practice.

Keywords: Eu funding,trainee&trainer GP exchange program,GP education

P-0921

Métis project – Education for Health

Paulo Santos, Carlos Martins, Luísa Sá, Luciana Couto, Alberto Pinto Hespanhol

General & Family Medicine Unit - Department of Social Sciences and Health, Faculty of Medicine of University of Oporto, Portugal

BACKGROUND: Patient’s literacy is a key to achieve best health outcomes. The quality of information available in web based supports isn’t always very high.

AIM: To provide a tool that can improve the information available to the public

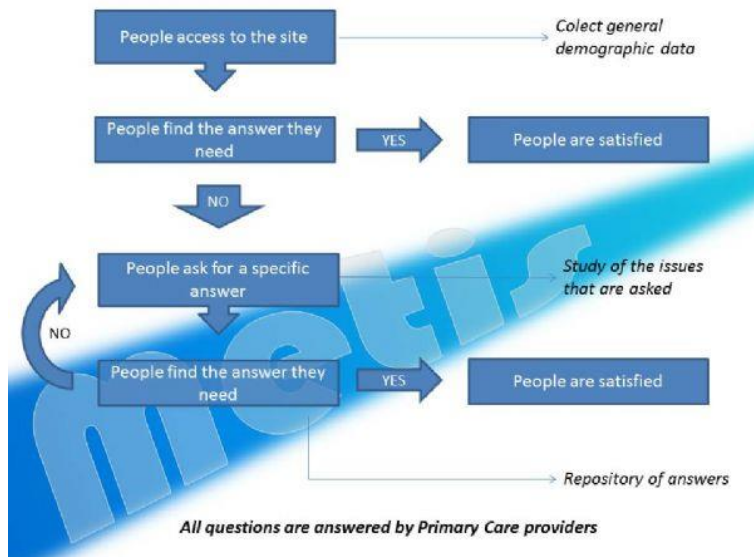
METHODS: Metis project is a web based support that offers an archive of information about health education, covering the main topics in this area, using a wiki like structure. It also allows the participant put his own question to be answered by a primary care professional, thus increasing his knowledge. These answers are added to the archive allowing others with identical doubt to benefit from it. From the academic point of view, we intend to characterize the profile of the users of this service.

RESULTS: Metis project is in the implementation phase. At this point we have about 300 texts ever built and we wait for the formal authorization of the National Authorities to open the access to the general public. The main topics are the primordial prevention, cardiovascular prevention, respiratory diseases, sexual transmission infections, stress and mental disorders, accidents, and elderly health.

CONCLUSIONS: Information is the basis for the empowerment of people. In Metis project we intend to improve literacy by providing scientifically validated information, in a clear and accessible language, that enables the citizen to make their own choices, thus improving their level of health.

Keywords: Health Education; Health Literacy; Patient Education

Metis project



P-0922

Sexual knowledge and behavior of young people in Poland

Paulina Pachniak, Maria Malarska, Michał Matyjaszczyk, Przemysław Kardas, Michał Podgórski
Medical University of Lodz

There are a lot of differences between young people's sexual behaviors. They act differently in group, home or even at school. The level of their basic knowledge about sex, contraception and sexually transmitted diseases are often very low.

We wanted to check what they actually know and what are they most common behaviors. We have prepared a survey that contained simple questions which they could answer without thinking. They were about their relationships, sex life, contraception, HPV or even how they feel about their lives.

Our aim was to get most reliable answers as we can. We have placed our questionnaire in the Internet, but we have also asked personally students of middle and high schools to fill it. We received more than two thousand replays.

The number of responses gave us a full view to the situation. For example the most common contraception among young people is a condom. Other methods like pills, IUD and others make up a small percentage. The research revealed that they did not do the self-examination, they did not know how to do it and what is more they did not know that it can help them to avoid the cancer. Most shocking answer was that only few percent of girls had been vaccinated to HPV. Comparing to other European countries it is so alarming.

Due to our research results we are deeply convinced that there is a need for change here, particularly in the education program.

Keywords: sexual education, hpv, contraception, sexual knowledge, sexual behaviour, gynecology

P-0923

Devising a curriculum for young UK military doctors

Rich Withnall

Defence Professor of General Practice, Royal Centre for Defence Medicine, ICT Centre, Birmingham Research Park, Vincent Drive, Edgbaston, Birmingham, B15 2SQ, UK

Background & Aim

The work of young doctors in the UK military differs from that of civilian doctors within the UK's National Health Service. Young UK military doctors spend up to three years at the start of their careers as General Duties Medical Officers (GDMOs). During this time, they develop military competencies whilst working in family medicine before starting their higher vocational training. These young doctors are clinically supervised, but GDMO time is not recognised as higher medical training by the UK's General Medical Council (GMC). Nevertheless, GDMOs deliver important family medicine services to patients within the UK and overseas. Until now, there has been no curriculum for young UK military doctors.

Method

A GDMO syllabus has been devised to standardise the learning objectives for all young doctors in the Royal Navy, Army and Royal Air Force working within family medicine. A bespoke GDMO Supervisors course and a new Introduction to Medical Education Course have been developed for the Associate Trainers who support the GDMOs. An electronic Portfolio has been created for recording the young doctors' developmental activities to enable an assessment of their progress against agreed educational objectives.

Results

The GDMO curriculum has linked a syllabus with new training and assessment tools. It defines young doctors' educational processes and intended outcomes whilst they work in family medicine, and enables consistent academic support from their Associate Trainers. This enhances organisational governance and assurance of the young doctors' clinical outputs, supporting high quality patient care.

Conclusions

A GDMO curriculum has been devised for young doctors working in family medicine in the UK military before they start higher vocational training. It advances clinical supervision, standardises educational activities and provides a consistent means of recording young doctors' developmental activities. This enhances organisational governance

and assurance and supports high quality patient care.

Keywords: curriculum, training, military

P-0924

Turkey-Croatian Exchange Program

Renata Pavlov¹, Özden Gökdemir², Ülkü Bulut³, Olgu Aygün⁴, Dilek Güldal², Mladenka Vrcic Keglevic⁵, Okay Başak⁶

¹Family Practice “Dr. Renata Pavlov”, Zagreb, Croatia

²Dokuz Eylul University, Faculty of Medicine, Department of Family Medicine, Izmir, Turkey

³Public Health Center, İzmir, Turkey

⁴Family Health Care Center, Izmir, Turkey

⁵Foundation for the Development of Family Medicine in Croatia, Zagreb, Croatia

⁶Adnan Menderes University School of Medicine, Aydın, Turkish Association of Family Physicians, Turkey

Background & aims

It's becoming more and more obvious that Vasco da Gama exchanges are achieving extraordinary results. But, for more experienced GPs, some similar programs still don't exist in Europe. Therefore, Turkish Association of Family Physicians and Foundation for the Development of Family Medicine in Croatia have started discussion about project of mutual collaboration including exchange programme aimed to the experienced GP. Aims of Turkey-Croatian Exchange were defined as giving opportunities to working GPs to visit and observe each others daily works and to discuss strengths and weaknesses of GP/FM in both countries, as well as making opportunities for future collaboration.

Method

The Program is planned to be achieved as individual or group exchange, depending of interests and possibilities of both countries. Preliminary content was planned and tested during Zagreb exchange.

Results

Six Turkey's GPs, including two academics, spent four days (10-13.12.2014) in Zagreb. The first day was orientation day, discussion about similarities and differences of health care systems, organisation and functioning of GP/FM, medical education, especially those related to GP/FM (undergraduate and speciality training) and quality improvement in both countries. Turkish colleagues spent two days observing daily work of Croatian GPs in city and rural practices. They participated at the Foundation's Day, mini symposium, giving presentations of the present state and future challenges of GP/FM in Turkey. They also took part in discussion about Croatian's presentations of their research work. City of Zagreb with its cultural heritage as well as accompanying and making friendship was very important part of exchange.

Conclusions

It was exiting experience of meeting, discussing and making friendships with colleagues. Several small projects, including this presentation were planned for future collaboration.

Keywords: Exchange program, Family medicine, Croatia, Turkey

Gathering and discussion on differences of the health care systems at the Andrija Stampar School of Public Health



Visit to GP practice



Foundation's days - mini symposium



Presentation of young GPs



Certification ceremony



Accompanying and making friendship



P-0925

Types and Content of CME Events in Primary Health Care in Federation of Bosnia and Herzegovina

Zaim Jatic¹, Dragana Niksic², Dzanana Jatic³, Olivera Batic Mujanovic⁴, Bakir Mehic⁵

¹Faculty of Medicine University of Sarajevo, Family Medicine Department

²Faculty of Medicine University of Sarajevo, Social Medicine Department

³Public Institution Health Centre of Sarajevo Canton, Ward Family Medicine

⁴Faculty of Medicine University of Tuzla, Family Medicine Department

⁵Faculty of Medicine University of Sarajevo, Internal Medicine Department

Background & Aim

Continuing medical education (CME) is ethical obligation of doctors that significantly affect the quality of provided health care.

Analysis of most common type of CME activities in primary health care (PHC) in Federation of Bosnia and Herzegovina. Comparison of the degree of satisfaction with the CME events between family doctors and other primary care physicians

Methods

A cross sectional study with self-administered questionnaire (n=500) was send to randomly chosen primary health physicians from n=42 municipalities in Federation of Bosnia and Herzegovina.

Results

Total of n = 371 physicians answered questionnaire. Family physicians were n=253 (68%). Content of CME is mostly related to theoretical knowledge (88%), which was often presented in the form of lectures for large groups. Clinical skills were the least represented in the content of CME (47%). A high percentage (90%) of physicians stated that the presence of the CME led to their comprehensive improvements. Family doctors statistically significantly had more training in teamwork (69%), communication skills (79%) and management skills (68%) compared to other PCH doctors. Family physicians were significantly more satisfied with the CME topics [p = 0.006]

Conclusion

Lectures for a large group are the most common form of CME with mainly theoretical content. Family physicians had more CME events with teamwork, communication skills and managerial skills content. They are also more satisfied with CME topics. Clinical skills were the least represented content on CME events.

Keywords: continuing medical education, continuous professional development, primary health care, family medicine, learning contract, teaching methods, satisfaction

P-0926

Systemic Arterial Hypertension combat: a daily fight

Ana Rosa Murad Szpilman, Bethânia Peccini Barros, Camila Pedruze Machado, Daphne Rios Viana, Lais Silva Neves Santos, Rafaela De Paula Souza, Rayza Montovani Siloti
Department of Public Health, Vila Velha University, Vila Velha, Brazil

BACKGROUND & AIM

The information spread on life quality and prevention measures improvement, contribute to decrease the Hypertension incidence and complications. Vila Velha University Medical students with the Brazilian Society of Endocrinology and Metabolism performed an educational campaign on promotion of health for hypertensive patients. The aim of this activity was knowledge acquisition, through a variety of situations, granting professional and personal growth, besides allowing the public to acknowledge this clinical condition with high prevalence as a possible controlled disease.

METHODS

The campaign, performed by the students, took place in a Sunday on Vila Velha beach boardwalk, in Brazil. The students were enabled to carry out arterial blood pressure measurements, capillary blood glycaemia and anthropometrics measurements, activities targeted to adult population, in order to orient the ones with decompensated measurements. The participants answered a form elaborated by the project coordinators to test the population knowledge on hypertension. A pamphlet distribution with simple information was used to inform the population about Hypertension and its consequences. In addition, there was a stretching class for the participants and students.

RESULTS

Around 200 people participated in these activities, and were alerted about the cardiovascular diseases risks and informed about the importance of life habits changes. During the morning, 30 people also participate on the stretching class performed by the Physical Education teacher. There was a great project acceptance by the population, and for the involved group performing the activity, it was possible to achieve the expected feedback.

CONCLUSIONS

The campaign was important to alert the population about the importance of healthy life habits, which besides preventing diseases, also improve the life quality. Therefore, to improve Systemic Arterial Hypertension control, it is essential to be aware of the risks and be motivated to perform a life style change.

Keywords: Hypertension, Quality of life, Public Health, Delivery of Health Care.

Blood Pressure Measurements



The students are measuring the population blood pressure during the campaign.

Form Application



The students are asking questions to the population in order to fill in the information required by the Campaign form.

Medical Students



The Vila Velha Medical Students who performed the Systemic Arterial Hypertension Campaign supported by the Brazilian Society of Endocrinology and Metabolism.

Stretching Class



The participants during the stretching class performed by the Physical Education teacher in the morning.

P-0927

Increase in residency scholarly activity as a result of resident-led initiative

Kyle Hoedebecke

Department of Family Medicine, Womack Army Medical Center, Ft. Bragg, USA

BACKGROUND AND OBJECTIVES: Scholarly activity (SA) is a fundamental component of family medicine residency training. Despite the variety of SA options, the output of resident presentations and publications remains disappointingly low, and many residents voice frustration with fulfilling the research requirements. A resident-driven process improvement project was undertaken with the goal of achieving a 100% increase of peer-reviewed publications and scholarly presentations by residents with secondary goals of doubling the involvement of staff, residents, and visiting medical or physician assistant students.

METHODS: This project involves (1) increasing awareness of conferences for scholarly submission, (2) assignment of residents in a resident research team to lead efforts, (3) pairing of interns/students with senior mentors with similar interests, (4) faculty to include one resident on all projects, and (5) monthly SA meetings to track research progress, share ideas, and troubleshoot areas of difficulty. Scholarly totals were compared between the 2011--2012 and 2012--2013 academic years.

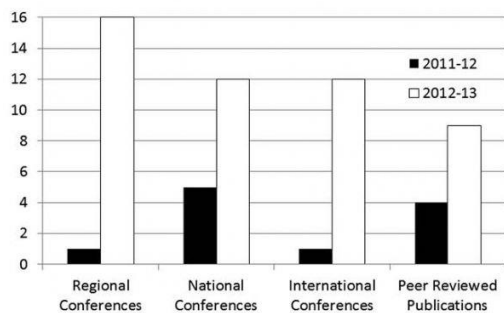
RESULTS: The SA goals were achieved on all fronts. The number of resident presentations increased from three to 28 (seven regional, 10 national, and 11 international presentations), and resident peer-reviewed publications increased from two to six when compared to the previous year. Scholarly participation doubled at all levels.

CONCLUSIONS: The authors recommend that other residencies consider promoting increased resident-to-resident scholarly mentorship, early planning with scheduled timeline, and increasing awareness of SA opportunities yearly.

Keywords: residents, medical education, scholarly activity, research

Resident Scholarly Submission Totals

Figure 1: Resident Scholarly Submission Totals



The 2012–2013 SA goals were achieved on all fronts. Overall resident scholarly submissions greatly increased as shown in Figure 1. Of the 28 accepted presentations, there were seven regional, 10 national, and 11 international events. Additionally, resident peer-reviewed publication totals increased from two to six, including three case reports, two review articles, and an original research project.

P-0928

Medical Students Knowledge and Perception regarding Complementary and Alternative Medicine

Firdous Jahan¹, Mustafa Manhal Al Ward¹, Muhammad A Siddiqui², Maryam Abdul Jabar¹

¹Oman medical college, Oman

²Queen Margaret University, Edinburgh, UK

Introduction

The purpose of the study was to assess the knowledge and perception of medical students regarding complementary and alternative medicine therapy (CAM). CAM therapies have the potential to increase well-being and thus influence pain. They are often employed in addition to conventional treatments. Patients presents in primary health care usually do self medication with herbs and other CAM so, there is a great need for continuing education on these alternative options in medical curricula.

Methods

A cross sectional survey based study carried out on 6th and 7th year medical students(clinical years). Data was collected on self-filled questionnaire. Statistical analysis was performed using SPSS (IBM SPSS Statistics 20.0). Data were expressed in frequencies, mean and percentages.

Results

Response rate was 76%. Majority of the students (80.5%) were Omani 45% (n-53) of study participants were below 25 years in age and 85.6% (n-101) were female. No difference was observed between 6th and 7th year students (p-0.516, 95% CI -1.74-3.31), significant difference (p-0.009, 95% CI 1.25-8.44). Significant difference was observed (p-0.009, 95% CI -7.45-1.08) between Omani and non-Omani participants. Students have adequate knowledge about CAM and positive approach in clinical practice but over all they have poor knowledge about herb as pain killer.

CONCLUSION: Medical students demonstrated limited self-reported knowledge of CAM and its practices.

Keywords: Complementary and alternative medicine, Medical students, Knowledge and perception

Demography

	Frequency	Percent
Age		
>25	65	55.1
<25	53	44.9
Gender		
Male	17	14.4
Female	101	85.6
Study Year		
6 th Year	65	55.1
7 th Year	53	44.9
Nationality		
Omani	95	80.5
Non Omani	23	19.5

Knowledge perception CAM

	Strongly Agree	Agree	Neutral	Disagree	Strongly Disagree	Don't Know
Herbs are safe and cost effective	1(0.8)	28(23.7)	57(48.3)	29(24.6)	3(2.5)	0.0
Homeopathy is a form of alternative medicine in which practitioners use highly diluted preparations	5(4.2)	19(16.1)	81(68.6)	10(8.5)	3(2.5)	0.0
The use of CAM should be asked about during a regular history taking	48(40.7)	52(44.1)	15(12.7)	2(1.7)	1(0.8)	0.0
A patient user CAM in conjunction with conventional medicine should be encouraged	1(0.8)	25(21.2)	47(39.8)	36(30.5)	9(7.6)	0.0
It is important to have CAM practices available to patients	7(5.9)	39(33.1)	52(44.1)	20(16.9)	0.0	0.0
Patients should inform/consult their doctors about their use of CAM	63(53.4)	42(35.6)	11(9.3)	1(0.8)	1(0.8)	0.0
My spiritual/religious beliefs influence my attitudes toward CAM	9(7.6)	52(44.1)	36(30.5)	14(11.9)	7(5.9)	0.0
Acupuncture can be used to relieve pain.	13(11)	43(36.4)	55(46.6)	7(5.9)	0.0	0.0
Chiropractic specializes in spinal manipulation and is used to treat lower back pain.	7(5.9)	21(17.8)	84(71.2)	6(5.1)	0.0	0.0

Knowledge perception CAM

Continued

	Strongly Agree	Agree	Neutral	Disagree	Strongly Disagree	Don't Know
CAM includes ideas and methods from which conventional medicine can benefit.	8(6.8)	66(55.9)	30(25.4)	14(11.9)	0.0	0.0
CAM therapies not tested in a scientific manner should be discouraged	38(32.2)	41(34.7)	29(24.6)	8(6.8)	2(1.7)	0.0
Clinical care should integrate the best of conventional and CAM practices	20(16.9)	42(35.6)	48(40.7)	7(5.9)	1(0.8)	0.0
Health care professionals should be able to advise their patients about commonly used CAM methods.	20(16.9)	58(49.2)	25(21.2)	15(12.7)	0.0	0.0
A formal training or mandatory CAM course should be included in medical undergraduate curriculum	20(16.9)	38(32.2)	38(32.2)	18(15.3)	4(3.4)	0.0
Hijama is a popular method used in Oman	37(31.4)	50(42.4)	22(18.6)	8(6.8)	1(0.8)	0.0
Relaxation techniques increase wellbeing and thus may contribute to controlling pain	31(26.3)	64(54.2)	19(16.1)	4(3.4)	0.0	0.0
Reflexology refers to massage therapy that is focused mainly on the feet	12(10.2)	17(14.4)	81(68.6)	7(5.9)	1(0.8)	0.0
Reiki and aroma therapies using smell to create an environment that is more soothing and relaxing	11(9.3)	33(28)	64(54.2)	9(7.6)	1(0.8)	0.0

Knowledge perception Herbs as pain killer

Knowledge regarding Herbs used as Pain Killer – n (%)

	Strongly Agree	Agree	Neutral	Disagree	Strongly Disagree	Don't Know
Capsaicin relieves arthritis pain(T)	16(13.6)	47(39.8)	0	6(5.1)	1(0.8)	48(40.7)
Capsaicin cannot be used topically(F)	3(2.5)	16(13.6)	2(1.7)	37(31.4)	16(13.6)	44(37.3)
Devil claw is a root used as analgesic(T)	0	12(10.2)	0	6(5.1)	6(5.1)	94(79.7)
Ginger cannot be used as analgesic(F)	1(0.8)	19(16.1)	0	19(16.1)	4(3.4)	75(63.6)
Krill oil has anti acid property(F)	2(1.7)	7(5.9)	0	6(5.1)	2(1.7)	101(85.6)
White willow bark has Aspirin like property(T)	4(3.4)	21(17.8)	0	3(2.5)	0	90(76.3)
Baswellia has an anti-inflammatory property(T)	1(0.8)	8(6.8)	1(0.8)	2(1.7)	0	106(89.8)
Curcumin found in turmeric(T)	9(7.6)	15(12.7)	0	5(4.2)	1(0.8)	88(74.6)
Bromelain is an extract from pine apple(T)	2(1.7)	7(5.9)	0	6(5.1)	1(0.8)	102(86.4)
Ginger has Omega 3 fatty acid(F)	2(1.7)	10(8.5)	17(14.4)	5(4.2)	5(4.2)	84(71.2)
Burdock Root increases blood pressure(F)	1(0.8)	5(4.2)	0	9(7.6)	1(0.8)	102(86.4)

Knowledge perception Herbs as pain killer

Continued

	Strongly Agree	Agree	Neutral	Disagree	Strongly Disagree	Don't Know
Nettles good for low back pain(T)	1(0.8)	4(3.4)	0	5(4.2)	3(2.5)	105(89)
Licorice increases blood pressure(T)	0	5(4.2)	0	9(7.6)	8(6.8)	96(81.4)
Skull cap is a Chinese herb(T)	1(0.8)	13(11)	0	3(2.5)	3(2.5)	98(83.1)
Alovera juice is not good for acidity(F)	0	7(5.9)	1(0.8)	1(0.8)	1(0.8)	99(83.9)
St. Johns' worth effective in arthritis pain(T)	2(1.7)	23(19.5)	0	15(12.7)	1(0.8)	77(65.3)
Valerian root acts as tranquilizer(T)	0	11(9.3)	0	2(1.7)	1(0.8)	104(88.1)
Fever few is used in migraine(T)	3(2.5)	7(5.9)	0	6(5.1)	2(1.7)	100(84.7)
Eucommia found in Garlic(F)	0	6(5.1)	0	4(3.4)	1(0.8)	107(90.7)
Solanum Incanum used to treat joint pain(F)	0	8(6.8)	0	3(2.5)	1(0.8)	106(89.8)
Juniper tree leaves soaked in oil used to treat earache(F)	0	5(4.2)	0	4(3.4)	2(1.7)	107(90.7)

P-0929

GP Training in the United Kingdom: Reflective practice and use of ePortfolio from a trainee perspective

Cemal Kavasogullari¹, Isabella Roiatti²

¹NHS Education Scotland

²NHS Lanarkshire

Background and Aim

ePortfolio is one of the three main constituents of the Royal College of General Practitioners (RCGP) Training Curriculum for general practice. ePortfolio can facilitate reflective learning and enable trainees to develop as mature self learners (1). Authors present their personal experiences of using ePortfolio providing examples of reflective learning entries and how these are utilized in developing reflective practice. Up to date information on the current GP training tools used in the United Kingdom is discussed.

Method

Explanatory guidance on ePortfolio entry and assessments has been obtained.

GP curriculum and information on reflective practice obtained from RCGP Training curriculum.

Excerpts from authors' ePortfolio entries from the first and the last 6 months of training in hospital posts have been analyzed in order to identify changes in practice.

Entries from different reflective learning tools have been compared to identify objective markers of learning and progress in education. Pathways and links between entries have been mapped to demonstrate how reflective practice augments curriculum coverage.

Results and CONCLUSIONS:

As a foreign medical graduates from Hacettepe University Faculty of Medicine, Turkey and Università degli Studi di Verona, Italy respectively, authors report initial difficulties in adapting to ePortfolio and its tools. Reflective practice has been challenging to incorporate into clinical practice at first but authors demonstrated continued progress during comparison of early and late entries. Experienced trainers' roles in facilitating the learning process is found to be essential in the adaptation process.

Albeit there certainly is further scope for improvement particularly with respect to the user interface of ePortfolio, it is recognized as an effective tool for assessment and record of learning. Use of ePortfolio and reflective learning empowers the trainee as a self-directed learner by giving ownership very much back to the learner.

Keywords: GP Training, ePortfolio, General Practice Training in the UK, General Practice Education

P-0930

Patient Education in Home Care Services

Kenan Topal¹, Çiğdem Gereklioğlu², Tuba Dilek Ateş¹

¹Adana Numune Training and Research Hospital, Department of Family Medicine, Adana/Turkey

²Başkent University Medical Faculty, Department of Family Medicine, Ankara/Turkey

BACKGROUND: Home care primarily targets to meet the health and social needs of people in their own homes. This concept defines a care system which provides the maintenance of preventive, curative and rehabilitative care and support the current health services. Therefore primary care physicians should be aware of home care. Education is defined as "the process which makes intentional changes in the behaviors of an individual through his/her own living". Education of the patient, family and caregivers is of great importance for maintenance of care.

MATERIAL-METHOD: The most important feature of health education is participation of the subject in his/her health applications willingly. Patient education is based on patient-centered approach. Not only the physical disorders but also social, psychological and cultural characteristics are addressed as a whole. The patient is evaluated with living conditions, problems, family, physical environment and psychological problems. A well-structured patient education helps them to manage and take responsibility for their treatment and makes it easier to overcome their health problems.

RESULTS: The educations aiming at enhancing knowledge and skills about home care after hospital discharge is important for reducing the anxiety of the patient and the relatives who are far from the safety of professional care at the hospital. The educations should be tailored for the patient. Assessment of the learning needs is a priority. The subjects should be effectively involved in the learning process and learning by doing should be the main principle.

CONCLUSION: Improving the knowledge and skills of the physicians and the nurses, the regulations for education and support programs for the families and the other caregivers would significantly contribute to the improvement of home care.

Keywords: Primary care physicians, home care, education of patients.

P-0931

New Way To Correct Contextual Errors: Making Family Tree

Sultan Oksuz Zortul, Esra Pektas, [Ozlem Ozer](#)

Department of Family medicine, Ataturk University, Erzurum, Turkey

The cornerstones of primary health care are access, equity, essentiality, appropriate technology, multisectoral collaboration, community participation and empowerment. Family medicine deals with people and their problems in the context of their life circumstances, not with impersonal pathology or “cases”. The starting point of the process is the patient. The common denominator is the person with their beliefs, fears, expectations and needs so it deals with health problems in their physical, psychological, social, cultural and existential dimensions in the aspect of community and between disciplines. The discipline has to recognise all these dimensions simultaneously, and to give appropriate weight to each. Physicians' lack of attention to patient's contextual information, such as transportation needs, finances, literacy, or caregiving, can lead to contextual errors complicating medical care. In contrast to biomedical errors, which are not patient-specific, contextual errors represent a failure to individualize care. To exclude the contextual errors, it is important to know patient's environment or behavior that are essential to planning appropriate care. Also it is a component of continuity of health care, longitudinal care and holistic approach. Thus records have key importance from past to now. A good way for recording, making family tree. Family tree is used by genetic counselors and other medical professionals to assess families and try to spot patterns or indications which may be helpful in diagnosing or managing individual's health. The family tree includes some knowledge as family members, whether individuals are living or deceased, date of death, cause of death, medical conditions. smoked, diet or exercise habits, origin of family, if known, should be indicated below the symbol. Families with inherited diseases are widely used in Mendelian/complex disease studies. Family genome analysis, including determination of parental origin of the variants, detection of de novo mutations, identification of potential recombination events.

Keywords: Contextual errors, contextual care, family tree,

P-0932

Innovation in Postgraduate Training for Primary Care of the Future: A Singaporean Perspective

[Julia Hui Li Ong](#), Grace Huiting Lum, Boon Yeow Tan

Division of Family Medicine, Department of Medicine, National University Health System, Singapore

Much like many developed countries, Singapore's primary care system is anticipating a silver tsunami with a rapidly ageing population. Moreover, her small size with hospitals within 5-15 minute access of each household results in many with chronic disease having multiple specialist appointments with reduced transfer of care back to family physicians. This has resulted in fragmentation of the healthcare system with reduced ownership of care.

The Family Medicine Residency Programme introduced in 2011 has given primary care a new stake in postgraduate training and aims to train family physicians to suit Singapore's needs. We share current innovation in our Residency training and envision possibilities for the future.

Innovative measures include the use of Information Technology (IT) to tag patients to residents. Patient admissions are flagged up to residents electronically, providing opportunities to contribute to inpatient care and support care after discharge, reducing the need for numerous specialist appointments. Family Medicine Residents also go on call allowing patients to get in touch with a primary care physician round the clock. Residents also work across many settings including inpatient, specialist outpatient clinics, community hospitals, nursing homes and home visits, attempting to attain a comprehensive grasp of the kind of care patients might typically go through.

As residents who have experienced how IT has helped reform our contribution to care, we look to the future of primary care and envision possibilities. These include increasing the autonomy of personal electronic health record which patients can access at all times, teleconferencing with inpatient teams and having instant messaging

capabilities that can improve bidirectional communication. The goal is to allow patients to understand their care better and bring back the ownership of each patient by a family physician.

Keywords: Residency, Information Technology, Primary Care

All Cases

Benefits	Number of Residents who reported this benefit	Quote from residents' answers
To build rapport with my patients	4	"Having visited patients in hospital brings a deeper element to doctor - patient trust."
To anticipate follow up steps after discharge (e.g. home visit)	2	"I would be able to arrange for follow up/home visit if I note issues during admission that I think needs to be sorted on discharge"
To improve communication with Specialists	1	

Unexpected admissions

Benefits include:	Number of Residents who reported this benefit	Quotation of residents' answers:
To reflect about the consultation process	8	"It allowed me to follow up on patients and realise if I missed any red flags or differentials"
To learn inpatient management of the issues	5	"Enabled me to learn from specialist management"
To understand potential problems patients face	2	"It allowed me to better appreciate how my patients' clinical conditions and social circumstances evolved after the clinic consultation. Their admissions were usually due to an acute exacerbation of a chronic disease, or in some cases, caregiver stress and breakdown of social support.""
To understand the importance of preventive medicine	1	

Expected Admissions

Benefits include:	Number of Residents who reported this benefit	Quotation of residents' answers:
To learn whether the referral was warranted	2	"For patients that we suspected something was wrong and acted on it, we can review and see if our suspicion was correct"
To check if patient defaulted	1	

P-0933

Concept identification and context analysis of the Wonca Europe 2015 book by instance-based categorization of general practice activities

Marc Jamouille¹, [Carl Steylaert](#)²

¹Dep. of General Practice, University of Liege & Wonca International Classification Committee

²WONCA Europe Hon Treasurer

Context:

Family physicians are large producers of knowledge. The site of Wonca Europe provides access to almost 20,000 abstracts produced by family physicians since 1995 (from Europe) and 1998 (from World Conferences). On the occasion of 20 years of Wonca Europe, an editorial committee selected 100 of the best abstracts and has asked each author (or a substitute) to make a chapter for the Wonca Book published in 2015 at the Wonca Europe congress.

The content analysis of medical texts is generally achieved by the use of MeSH. To fill gaps in MeSH, a specific family medicine classification has been developed under the name Core Content Classification of General Practice / Family Medicine (3CGP). A combination of ICPC + Q-Codes (new tool for non-clinical items) provides just fewer than 900 concepts for analyzing the contents of specific texts to family medicine.

METHOD:

The 100 chapters of the Wonca Book 2015 were analyzed using 3CGP by a single observer not involved in the editorial committee of the book. Every text has been carefully read and a maximum of two concepts by chapter were reported in an Excel spreadsheet.

RESULT:

150 codes were used of which 143 from the classification of non-clinical items Q-codes and 7 coming from ICPC. Among the topics discussed by authors and identified by Q-codes, 35 relate to knowledge management which includes family medicine education, 29 codes concern research and development, 29 doctor's specific area, 24 patients' issues, 11 relate to the structure and 8 deal with ethics.

DISCUSSION:

Despite limitations (unique observer – not validated tools) the study reveals striking facts. The editorial board has favored themes that affect the structure and organization of knowledge of the profession. Clinical items or affecting directly the patients are very poorly represented. More about 3CGP on <http://docpatient.net/3CGP>

Keywords: Family practice, Documentation, Vocabulary, Controlled, Indexing and Abstracting

P-0934

Medical Student Assessments' of Patient and Doctor Perspective

Serkan Yavuz, Nilgun Ozcakar

Department of Family Medicine, Dokuz Eylul University, Izmir, Turkey

Background & Aim

Doctor-patient interview is the basis of medical practice. Purpose of interview is to understand patient's problem and resolve in light of physician's medical knowledge. In an effective interview, doctor should be able to evaluate patient perspective in addition to his own for better communication. Disease influence on individual's life, relationships and their expectations must be learned.

Methods

In this study 3th year medical students observed physician-patient interviews at outpatient clinics. They filled physician perspective forms evaluating communication, history and physical examination, patient perspective forms accompanied by patient as long as they were in clinic. Totally 237 forms were analyzed by content analysis.

Results

Students assessed physician perspective "simple language used(70/128)", "communication fine(22)". Oriented main complaint while taking history(29), answered patients' questions(11), given explanatory answers, 9 didn't give answers. Some(13) had never done physical examination, 49 was intended for complaints.

Patient perspective forms(109) evaluation determined patients were in three different situations:

Conditions presented as "intense anxiety" described by "Patients have intense anxiety starting one day before the appointment described as 'If something goes bad'.

"He says not been given enough information about treatment. When problems occurred not know when to stop drugs" as "negative",

And as "positive" as "Family happy with the hospital, doctors give enough time to each question of mother, indicate that giving interest and clear answers create these feelings".

Discussion & Conclusion

In doctor-patient interview while issues doctor decide prior to know, patient has a different agenda including social conditions, health perceptions. The difference effectuates dysfunctional exposes while diagnosis, treatment and follow-up are negatively affected.

For lasting relationship aiming medical disciplines such as family medicine understand patient is important as understand the disease and diagnose. Developing applications for behavior and attitudes of physicians at patient interviews should take place in curriculum of medical schools.

Keywords: Patient Perspective, Doctor Perspective, Medical Students Assessments'

Patient Perspective



P-0935

A mixed methods study of psychiatry trainees investigating the factors in their undergraduate medical training which may have contributed to their decision to train in psychiatry

Amber Appleton, Marta Buszewicz

University College London, Department of Primary Care and Population Health

Background and AIMS:

For years psychiatry has been undersubscribed as a career choice. Undergraduate psychiatry teaching is likely to impact on this. Some medical schools have integrated psychiatry with other specialities to reduce separation in future doctor's minds between mental and physical health. The optimal undergraduate psychiatry curriculum needs to be established.

Aims:

- (i) To improve understanding of how the psychiatry curriculum impacts recruitment in this speciality by examining the trainees' perspective
- (ii) To make recommendations for a universal undergraduate psychiatry curriculum to enhance positive attitudes towards mental health.

METHOD:

A mixed methods qualitative study with two parts:

- i) Web-based survey of all psychiatry trainees (in London initially then nationally) to ascertain the trainees' perspective on undergraduate teaching. We will ask which medical schools they trained at, and this will be triangulated with a complementary study documenting the psychiatry curriculum at different medical schools
- ii) In-depth interviews with purposively sampled trainees to explore their views on their undergraduate mental health teaching

RESULTS:

From London, we have had 172 trainee responses (29% response rate), from a range of 26 UK medical schools. Provisional results show that 85% of trainees were taught psychiatry in blocks at medical school; however 68% thought psychiatry teaching should be integrated throughout the curriculum. 69% said their attitudes towards psychiatry changed after being taught psychiatry at medical school. 80% decided on a career in psychiatry during or after medical school, and 50% said the teaching they received at medical school influenced their career choice in psychiatry. This highlights the importance of developing an optimal psychiatry curriculum to capture the interest of medical students in this speciality.

Conclusions

Data collection is still in progress with the survey being sent nationally and interviews about to commence. This will be all completed by August 2015 and final results presented.

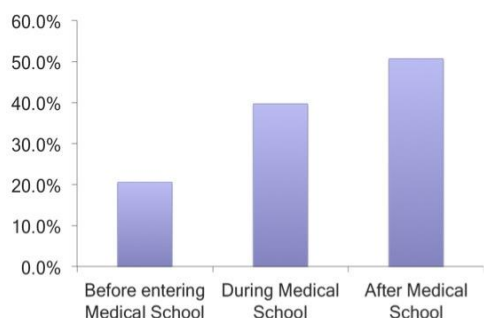
Keywords: Education, Curriculum, Psychiatry

Figure 1: Do you think psychiatry teaching should be integrated throughout the Medical School curriculum?



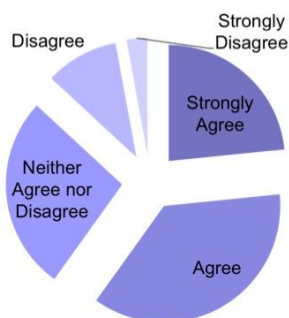
85% of trainees were taught psychiatry in a block. However 68% strongly agreed or agreed that it should have been integrated throughout the undergraduate curriculum.

Figure 2: When did you decide on choosing psychiatry as a career?



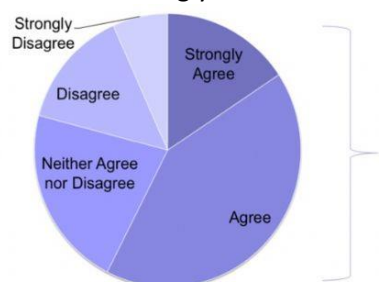
80% decided during or after medical school; highlighting an important group to target at medical school by optimizing teaching of psychiatry.

Figure 3: Did your attitudes change after being taught psychiatry?



69% of the trainees said they noticed their own attitudes towards mental health changed after being taught psychiatry.

Figure 4: Did the teaching you received influence your decision to choose a career in psychiatry?



56% agreed or strongly agreed highlighting the importance of optimizing the teaching of psychiatry at medical school

Figure 5: Was there an individual at Medical School who influenced your decision to choose psychiatry?

39% said there was an individual at medical school who influenced their decision to choose psychiatry as a career

Figure 6: Suggestions from trainees for improving psychiatry teaching at medical school

“More integrated”
“More of it”
“Mentoring”
“More emphasis on liaison/organic psychiatry”
“Dynamic teachers”
“Balint groups”

The trainees were asked what they suggested would help improve teaching of psychiatry at medical school and some of the key suggestions have been summarized in this figure.

Figure 7: Suggestions for improving recruitment to psychiatry

Improving psychiatry services
Overcoming stigma (in media and among colleagues)
Highlighting that psychiatric treatment is evidence-based
Emphasize breadth of psychiatry
More engaging medical school placements
Improving relationship with other specialties

The trainees were asked for their ideas for improving recruitment into psychiatry as a career and these have been summarized in this figure.

P-0936

The Immunization Working Group - SIG of the Romanian National Society of Family Medicine (SNMF)- activity and future projects

Sandra Adalgiza Alexiu, Gindrovel Dumitra, Daniela Ștefănescu, Cristina Vasilica Barbu, Dorica Sănduțu, Maria Lup, Dana Ștefana Popescu, Mădălina Vesa, Anca Deleanu

Immunization Working Group, National Society of Family Medicine, Romania

In Romania GPs are the main vaccinators. The Immunization Working Group was born as a consequence of the desire of GPs to be aware of the latest news in the field and to help increase vaccination coverage. The group consists of GPs certified as trainers, experienced in setting up and conducting CME programs for GPs and specialized in vaccinating infants, children and adults.

Established in 2012, the group structured programs for various categories of patients, media, GPs. Partnerships with the organizers of the most important medical events that address issues related to vaccination have made possible many activities of the group in the 3 years since. Today, members of the group are asked to contribute to future projects regarding vaccination, training programmes for implementing new vaccines in the National Immunization Schedule and a new vaccination national law. Currently SNMF believes that the appearance and evolution of this Special Interest Group had a beneficial effect on quality of care in family medicine and aims to promote the development of other SIGs.

We want to share the experience of our group with our colleagues in Wonca through a breakdown of the activities carried out by the group (workshops, symposia, debates, media/social media campaigns for patients&GPs, World Immunization Week in partnership with the WHO Country Office, attending ESPID and WONCA-Europe conferences, translation and adaptation of guidelines for improving protection through immunization).

Our future projects include new CME projects for our Romanian colleagues, working with other countries on the issue of immunization as part of primary prevention, building an international Wonca network for GPs on immunization subjects.

We invite GPs from other countries where they are the main vaccinators to work with us in joint CME projects or campaigns for professionals and the general public.

Keywords: vaccination/immunization, family doctors, activity, future projects, GPs

Immunization Working Group LOGO



P-0937

"{"Do the last year students of the faculty of medicine feel themselves enough about obstetric and gynecologic diseases frequently seen in primary care practice "}" ?

Muhterem Ipek¹, Murat Ünalacak², İlhami Ünlüoğlu³

¹The Clinic of Family Medicine, Ankara Training and Research Hospital, Ankara

²Department of Family Medicine, Faculty of Medicine, Hacettepe University, Ankara

³Department of Family Medicine, Faculty of Medicine, Eskişehir Osmangazi University, Eskişehir

""AIM: to determine if the final year students of the faculty of medicine of Eskişehir Osmangazi University (ESOGU) feel themselves enough about obstetric and gynecologic diseases that they are going to frequently face during primary care practice.

MATERIALS-METHOD: This survey was applied to the last year students of the faculty of medicine of ESOGU within 2011-2012 and 2012-2013 academic years. The study was performed just one month before their graduation. Survey included questions about adequacies about diagnosis, treatment and the referral criteria of obstetric and gynecologic diseases. They were asked yes/no questions.

RESULTS: A total of 203 students answered the questionnaire. Of them, 50,7 % were female, 49,3% were male. Results are given in the table below.

Frequently Seen Obstetrics and Gynecologic Diseases in Primary Care Can diagnose, Can treat/ Can perform intervention, Knowledge about referral criteria

Sexually transmitted disease 70,0 53,2 42,9

Normal pregnancy 94,6 54,2 60,6

Hyperemesis gravidarum 78,3 49,8 45,8

Postpartum hemorrhage 79,8 36,0 43,8

Urinary tract infection 97,5 97,5 70,4

Pelvic inflammatory disease 44,3 29,6 32,0

Vulvovaginal candidiasis 69,0 63,1 39,4

Eclampsia 60,1 27,1 36,0

Pre-eclampsia 62,6 27,6 36,0

Iron deficiency anemia 97,0 94,1 71,9

Dysmenorrhea 95,1 87,2 58,1

Breastfeeding problems 54,2 43,8 36,0

It was observed that the students feel themselves most adequate in the management of urinary tract infection.

CONCLUSION: Obstetric and Gynecologic diseases are among the mostly encountered diseases in primary health care practice. Primary care physicians should recognize, should be able to treat and should be able refer if necessary. If not, consequences such as serious disabilities, leading also to increase in the cost of treatment, may occur. Education in this field should be revised, and some opportunities should be given to the students to have more practice on the topics in which they feel themselves inadequate"".

Keywords: Medical students, Obstetrics and Gynecology, Qualification

Frequently Seen Obstetrics and Gynecologic Diseases in Primary Care

Frequently Seen Obstetrics and Gynecologic Diseases in Primary Care	Can diagnose	Can treat/ Can perform intervention	Knowledge about referral criteria
Sexually transmitted disease	70,0 %	53,2 %	42,9 %
Normal pregnancy	94,6 %	54,2 %	60,6 %
Hyperemesis gravidarum	78,3 %	49,8 %	45,8 %
Postpartum hemorrhage	79,8 %	36,0 %	43,8 %
Urinary tract infection	97,5 %	97,5 %	70,4 %
Pelvic inflammatory disease	44,3 %	29,6 %	32,0 %

Vulvovaginal candidiasis	69,0 %	63,1 %	39,4 %
Eclampsia	60,1 %	27,1 %	36,0 %
Pre-eclampsia	62,6 %	27,6 %	36,0 %
Iron deficiency anemia	97,0 %	94,1 %	71,9 %
Dysmenorrhea	95,1 %	87,2 %	58,1 %
Breastfeeding problems	54,2 %	43,8 %	36,0 %

It was observed that the students feel themselves most adequate in the management of urinary tract infection.

P-0938

Greek general practice residents' perceptions on their educational environment, using the Postgraduate Hospital Education Environment Measure (PHEEM): comparison with other specialties

Vasileios Trifon Karathanos¹, Vasileios Nikolaos Kiosses¹, Persa Koutsogiannou², Eleni Jelastopulu², Ioannis Dimoliatis¹

¹Department of Hygiene and Epidemiology, Medical Education Unit, University of Ioannina, Medical School, Greece

²Department of Public Health, Department of Public Health, Patras, Greece

BACKGROUND:

To record general practitioners' (GP) perceptions on educational environment in Greece and to compare with other specialties.

Summary of work:

Residents from all over Greece answered the PHEEM questionnaire. Mean total score was calculated for all participants and for specialties, and compared using t-test. Scores are given in the standard 0–100% scale. An educationally minimum important difference (EMID) of 5% was accepted.

Summary of RESULTS:

Out of 731 residents, 27% were general practitioners (GPs), 34% internists, 22% surgeons, 12% lab specialty (labs) and 5% other. The total PHEEM mean score for all participants was 41.1, for GPs 37.6, for internists 41.5 ($p=0.003$ versus GPs), for surgeons 42.7 ($p<0.001$), and for labs 45.1 ($p<0.001$). Mean differences were 3.9 (internists-GPs), 5.1 (surgeons-GPs), and 7.5 (labs-GPs), i.e., less than one, one, and one and a half EMID, respectively. Compared to all other residents, GPs were less satisfied with specialty exams (24.6 vs. 36.7, $p<0.001$) and their expectations when entering the medical school less fulfilled (32.4 vs. 35.1, $p=0.016$).

CONCLUSIONS:

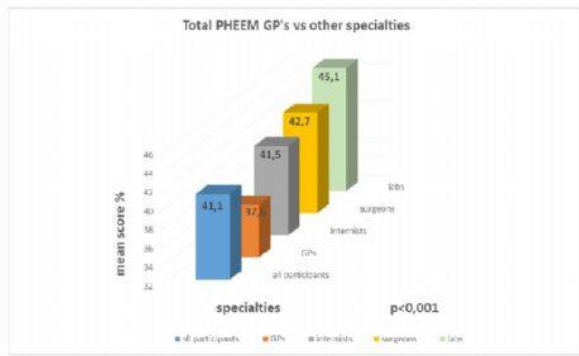
Residents aren't satisfied with their post and education, only about 40%, a perception perhaps confounded by country's current negative socioeconomic conditions. Although mean scores for all specialties lie within one EMID around total mean score for all participants ($41\pm 5=36-46$), GPs perceive their educational environment as poor (within the 25-39.9% interpretation zone) while the other three specialties as rather poor (within 40-49.9%).

Take-home message:

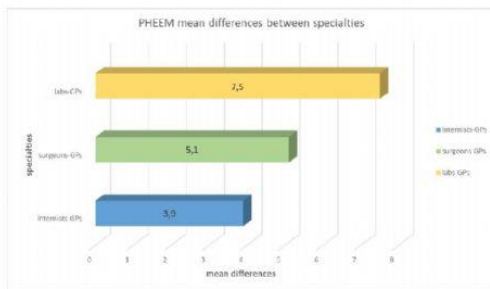
There is an urgent need for drastic redesign of the residency programs in Greece to improve the educational environment and increase the quality of and satisfaction with the training, especially for GPs.

Keywords: medical education, PHEEM, residents, general practitioner

Total PHEEM GP's vs other specialties



PHEEM mean differences between specialties



P-0939

The First Turkish Vasco da Gama Movement Conference Exchange Programme Experience

Halil Volkan Tekayak¹, Sezen Ingilok¹, Ayşe Melike Eraslan¹, Elif Can Halıcı¹, Demet Merder Coşkun², Canan Tuz³, Candan Kendir Çopurlar⁴, Fikret Merter Alanyalı⁵, Berk Geroğlu⁵, Fethi Sada Zekey⁶

¹Cukurova University Medical Faculty Department of Family Medicine, Adana, Turkey

²Haydarpaşa Numune Education and Training Hospital Family Medicine Clinic, İstanbul, Turkey

³Ankara University Medical Faculty Department of Family Medicine, Ankara, Turkey

⁴Dokuz Eylül University Medical Faculty Department of Family Medicine, İzmir, Turkey

⁵Tepecik Education and Training Hospital Family Medicine Clinic, İzmir, Turkey

⁶Umraniye Education and Training Hospital Family Medicine Clinic, İstanbul, Turkey

BACKGROUND and AIM:

Vasco da Gama Movement (VdGM) Exchange group is a sub-working group of VdGM arranges exchange programmes between young General Practitioners (GP) from European countries. VdGM Conference Exchange Programmes are frequently organized in most of the participating countries but it has not been organized in Turkey before.

Our aim was to introduce Turkish primary health care system and to develop socio-cultural relations between young GPs by organizing the First Turkish Conference Exchange Programme.

METHOD:

VdGM Turkish Team organized the exchange programme in May 2015 before the 14. Eastern Mediterranean Family Medicine Symposium in Adana by the collaboration with the host organizing committee of the symposium. Five participants from four countries were accepted to the programme (Marieke Leemrize from Denmark, Phillippe Eren from France, Ines Gonzalez Bolanos from Spain, Alexandro Pinho and Raquel Salgado Sousa from Portugal) During the exchange programme, Cukurova University Hospital Family Medicine Department, Balcalı Education and Training Hospital, Cukurova Mehmet Ali Kirac Urban Health Care Centre, Sarıcam Mehmet Akif Ersoy Rural Health Care Centre, Sarıcam Maternal and Child Health Care Centre, Adana Nursery Home, Tarsus American Colledge School Health Care Centre were visited to observe Turkish primary care and family medicine. May 19th World Family Doctor Day was celebrated by Turkish GPs and exchange participants with a special boat tour on Adnan Menderes Dam Lake.

VdGM Workshop titled "Young Side of Family Medicine" was held in the symposium with the participation of WONCA Europe President, Turkish Association of Family Physicians President, academics, GPs and GP trainees. Presentations introducing primary healthcare systems of different countries were made and all participants shared their experiences during this workshop.

RESULT:

The First Turkish VdGM Conference exchange had a goal of providing a better understanding in different primary health care systems and cultures among young GPs and GP trainees.

Keywords: Vasco da Gama Movement, Family Medicine, Exchange

Figure 1.



The First Turkish Conference Exchange Participants and Turkish Exchange Team in an Urban Primary Health Care Center

Figure 2.



The First Turkish Conference Exchange Participants and Turkish Exchange Team in a Rural Primary Health Care Center

Figure 3.



The First Turkish Conference Exchange Participants and Turkish Exchange Team in a School Health Clinic

Figure 4.



The First Turkish Conference Exchange Participants and Turkish Exchange Team in a Meeting with WONCA Europe President

Figure 5.



The First Turkish Conference Exchange Participants and Turkish GPs Celebrating the World Family Doctor Day

Figure 6.



The First Turkish Conference Exchange Participants and Turkish Exchange Team in 14th Eastern Mediterranean Family Medicine Symposium in Adana

P-0940

Establishing the Family Medicine Training Programme in Palestine

Nawal Abusarhan¹, Walid Tarda¹, Israa Alassa², Lubna Alsaudi¹, Charilaos Lygidakis³, Paul Wallace⁴

¹Faculty of Medicine and Health Sciences, An-Najah University, Nablus, Palestine

²Primary Healthcare Beitlehem, Beitlehem, Palestine

³Vasco da Gama Movement

⁴University College London, UK

Background & Aim

The development and implementation of Family Medicine (FM) in the Palestinian West Bank has faced significant obstacles due to isolation and the consequences of military conflict. The first trials for introducing the concept of FM date back in 1993, while in the past there were attempts to provide short training by the Medical Aid for Palestinians (MAP-UK) and WHO.

Led by Dr Samar Musmar, the first postgraduate FM training programme in West Bank was launched in the An-Najah University in Nablus 2010. The objective of this presentation is to illustrate its organisation and explore its next steps.

Method

The curriculum includes various rotations such as in paediatrics, emergencies and psychiatry. Although a 15-month rotation in FM is mandatory, due to the lack of Family Doctors, the residents work in clinics, staffed by untrained Generalists and other specialists. Support to the programme has been provided by the International Development of Family Medicine in Palestine (IDFMP) initiative, which is a collaboration between academic General Practitioners and is endorsed by WONCA EMR and WONCA Europe.

Results

The first cohort of residents undergoing a comprehensive four-year training consisted of 24 physicians, all at different stages of career –from recently qualified to long established; 8 of them graduated in December 2014. The Ministry of Health has supported the establishment of 3 pilot Family Medicine Clinics in Hebron, where the FM graduates have permanent place of work, while it plans to operate specific clinics with tutors in FM. Finally, the IDFMP initiative is becoming embedded as an international academic programme, aiming at offering international exchanges, mentorship and personal/online support.

Conclusions

Although the launch of the FM training programme was carried out under extremely challenging circumstances, it still represents a significant step for the improvement of the Primary Care services in Palestine.

Keywords: Medical Education, Specialization, Policy, International Educational Exchange, Internationality

P-0941

A survey to evaluate our physicians' clinical experience regarding the bisphosphonate-related osteonecrosis of the jaw

Lana El Osta, Sara Lakiss, Reine Tannous, Maria El Gemayel, Nada El Osta

Department of Public Health, School of Medicine, Saint-Joseph University, Beirut, Lebanon

BACKGROUND AND AIM: Clinical trials have demonstrated the efficacy of bisphosphonates for the treatment of metabolic and oncologic bone disorders. Various safety issues that were not noted in these trials have, however, now emerged with post-marketing surveillance and increasing clinical experience, such as the bisphosphonate-related osteonecrosis of the jaw (ONJ).

This study aims to evaluate the clinical experience of our physicians with regard to this rare complication.

METHODS: We conducted an observational cross-sectional survey at our hospital in 2014. Data were collected through an anonymous, structured and self-administered questionnaire distributed to 190 eligible physicians in the departments involved in prescribing bisphosphonates and in managing the ONJ.

RESULTS: One hundred thirty six valid responses were obtained (response rate: 71.6%). More than half of the participants (63.2%) were treating patients with bisphosphonates: the most prescribed form being the weekly oral bisphosphonates for osteoporosis followed by the zoledronate several times yearly for malignant bone diseases. Only 35 (25.7%) physicians had the opportunity to examine a necrotic bone of the jaw, and 21 (15.4%) to treat and/or participate in the treatment of a necrotic bone of the jaw during their careers and/or their medical studies; ear nose and throat surgeons and oncologists rather than other specialists (p-value <0.0001). Eighty-five participants (62.5%) were aware of bisphosphonate-related ONJ, and 65 (47.8%) fear this complication. There were statistically significant associations between the awareness/fear and physicians' specialty, whether or not they prescribe a bisphosphonate, whether or not they have observed and treated exposed necrotic bone of the jaw among patients (-p-value<0.05).

CONCLUSIONS: Given the large and growing number of patients receiving a bisphosphonate, it is likely that physicians may encounter some patients with bisphosphonate-related ONJ, which has been shown by our study. Further studies assessing the application of ONJ preventive measures on patients treated with bisphosphonate are required.

Keywords: Osteonecrosis of the jaw, Emerging complication, Clinical experience

P-0942

Measuring deprivation in final-year medical students in a Greek University

Emmanouil Smyrnakis, Evaggelia Tsiga, Magda Gavana, Stathis Giannakopoulos, Alexis Benos
Laboratory of Hygiene, Department of Primary Health Care and General Practice, Medical School, Aristotle University of Thessaloniki

Background - AIM:

Economic crisis in Greece lead to considerable cuts in universities' funding. As a consequence the Department of Primary Health Care (PHC) and General Practice (GP) of the Aristotle University of Thessaloniki (AUTH) Medical School was forced to stop transportation and accommodation reimbursement for final year medical students that had to attend PHC and GP attachment in rural health centers. The aim of this study was to evaluate students' deprivation status in order to understand if they can stand this additional financial burden. The research questions are: How economic crisis affects material, social and health deprivation in final-year medical students? Is there a difference in deprivation status between two sequential academic years?

METHOD:

A cross-sectional study was conducted using the 'Deprivation in Primary Care Questionnaire' (DiP-Care-Q). All final-year AUTH medical students were asked to complete the Dip-Care-Q at the first day of their PHC and GP attachment during two sequential academic years. Material, social, health and overall health deprivation indexes were calculated.

RESULTS:

487 final-year medical students participated in the study (41.9% and 58.1% from the academic years' 2012-13 and 2013-14 respectively). The mean scores were: material deprivation index (M=2.13, SD=1.37), social deprivation index (M=0.75, SD=0.85), health deprivation index (M=0.25, SD=0.55) and overall deprivation index (M=1.2, SD=0.52). Statistical significant differences were observed between the two academic years for material deprivation (p=0.001) and overall deprivation index (p=0.013), with highest deprivation occurring at 2012-13 cohort.

CONCLUSIONS: According to the results of this study, economic crisis affects material deprivation in medical students of AUTH Medical School. Even though deprivation indexes (material and overall) seem to become better through the two academic years, it's extremely crucial to restore universities funding in order to ensure the continuity of education in PHC and GP which is the base a sound public health care system.

Keywords: economic crisis, undergraduate medical education, deprivation

Table 1. DipCare-Q Questionnaire

We would like you to answer the following questions dealing with your personal finances, social environment and general health. Please mark with an X (☒) the answer that best applies to your own situation.

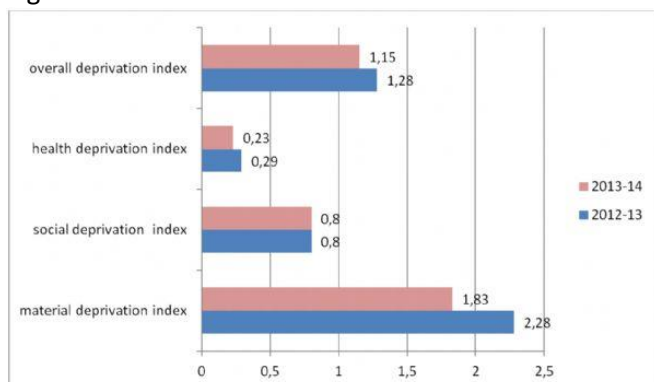
1. During the last 12 months, have you had trouble paying your household bills (taxes, insurance, telephone, electricity, credit cards, etc.)? Yes No
2. During the last 12 months, have you had to ask your immediate family for money to cover your basic day-to-day needs? Yes No
3. During the last 12 months, has a member of your household not sought treatment (dentist, doctor, buying medication) because you didn't have enough money? Yes No
4. During the last 12 months, have you feared being evicted from or losing your home? Yes No
5. During the last 12 months, have you not bought clothes even though you or a member of your household needed them? Yes No
6. During the last 12 months, have you not bought furniture or household goods even though you or a member of your household needed them? Yes No
7. During the last 12 months, have you gone on holiday? Yes No
8. During the last 3 months, have you spent an evening in the company of close family members or friends? Yes No
9. During the last 3 months, have you been to the cinema, the theatre, a concert or a sports event? Yes No
10. During the last month, has there been an occasion when your household did not have enough to eat? Yes No
11. During the last month, have you been able to access the internet (at home, at work, at a library, at an internet café, etc.)? Yes No
12. If you're in difficulty, is there someone outside your household to whom you can turn for material help (money, food, accommodation)? Yes No
13. Are you currently finding it very difficult to pay back money (to the bank, family, friend etc.)? Yes No
14. Do you currently suffer from a physical disability that has a major impact on your day-to-day life? Yes No
15. Do you currently suffer from mental health issues or problems that have a major impact on your day-to-day life? Yes No
16. Do you currently have problems linked to alcohol consumption, drug-taking, gambling etc.? Yes No

Table 3

	cohort	N	mean	SD	p-value
material deprivation index*	2012-13	202	2.28	1.48	0.001
	2013-14	275	1.83	1.45	
social deprivation index	2012-13	201	0.80	0.94	0.990
	2013-14	278	0.80	0.98	
health deprivation index	2012-13	203	0.29	0.60	0.261
	2013-14	281	0.23	0.53	
overall deprivation index*	2012-13	190	1.28	0.55	0.013
	2013-14	239	1.15	0.49	

Deprivation scores - comparison between the two cohorts

Figure 2



Deprivation scores - comparison between the two cohorts

Table 2

Instructions for calculating DiPCare-Q indexes

- a) Code all 16 questions (D1 to D16) "1" for "Yes" and "0" for "No".
- b) Recode questions D7, D8, D9, D11, and D12 "1" to "0" and "0" to "1" for all positive items to be related to deprivation.
- c) Generate the following indexes:
 - Material deprivation index: $D1+D2+D3+D4+D5+D6+D10+D13$
 - Social deprivation index: $D7+D8+D9+D11+D12$
 - Health deprivation index: $D14+D15+D16$
- d) Calculating overall deprivation index: DiPCare-Q index
 1. Generate categories of deprivation from the corresponding index:
 - Material deprivation categories: generate the following categories from the material deprivation index: 1 to 2 = 1, 3 to 6 = 2, 7 to 8 = 3
 - Social deprivation categories = social deprivation index
 - Health deprivation categories: generate the following categories from the health deprivation index 0 to 1 = 0, 2 to 3 = 1
 2. Using these variables, compute the overall deprivation index using the following equation for each participant:

$$\text{index} = 0.810 \cdot \text{mat_cat} + 0.455 \cdot \text{soc_cat} + 0.711 \cdot \text{health_cat}$$
 3. Round result to the closest unit ending with an index of 5 levels of deprivation.

Figure 1. DiPCare-Q index

		Health deprivation index (0) 0 to 1 point				Health deprivation index (1) 2 to 3 points				
Social index	0 point (0)	0	1	2	2	0 point (0)	1	2	2	3
	1 point (1)	0	1	2	3	1 point (1)	1	2	3	4
	2 points (2)	1	2	3	3	2 points (2)	2	2	3	4
	3 points (2)	1	2	3	4	3 points (2)	2	3	4	5
	4 points (2)	2	3	3	4	4 points (2)	3	3	4	5
	5 points (3)	2	3	4	5	5 points (3)	3	4	5	5
		0 points (0)	1 to 2 points (1)	3 to 6 points (2)	7 to 8 points (3)	0 points (0)	1 to 2 points (1)	3 to 6 points (2)	7 to 8 points (3)	
		Material index				Material index				
$\text{Overall index} = [\text{material deprivation}] \times 0.810 + [\text{social deprivation}] \times 0.455 + [\text{health deprivation}] \times 0.711$										

Calculation table for the DiPCare-Q index ranging from 0 to 5 using subindexes corresponding to material, social and health deprivation.

P-0943

Teaching medical students in private clinics: can Malaysian General Practitioners deliver?

Norlehan Abdul Samad, Yong Rafidah Abdul Rahman
Cyberjaya University College of Medical Sciences, Malaysia

Background and Aim

Community based training is practiced all over the world in undergraduate medical education. The Malaysian public facilities are stretched to its limit to cater to the increasing number of medical students training and meeting patients' needs. Selected privately operated health clinics are increasingly utilized as teaching place for primary care students. The capability of these private entities to provide effective student teaching is evaluated.

Method

Undergraduate medical students spend a week at private general practitioner's (GP) clinic as part of their 8-week family medicine clerkship. Participating GPs are requested to complete a 5 -point likert-scale questionnaire form at the end of the rotation.

Results

60 forms were returned (73% rate). Most GPs are confident of their ability to teach (85%) but express need for better teaching skills. Teaching medical students improves GPs morale and facilitates reflection on their work (89%). Many GPs (38%) do not wish remuneration but larger proportion (41%) considers it important. Student's presence does not always improve service to clinic and patients.

Conclusions

Private GPs are confident of their ability to provide teaching for undergraduate medical student despite possible setbacks on their practice and patients. Appropriate recognition and support from other stakeholders are necessary for effective implementation. Our finding echoes similar trend in previous GP teaching experiences in other parts of the world. Successful practices from established family medicine training programs can be emulated and adopted.

Keywords: education, primary care, general practice, community based training

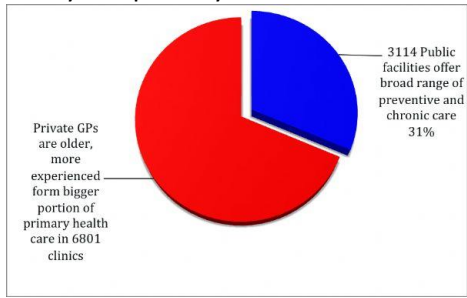
A GP teacher with his students



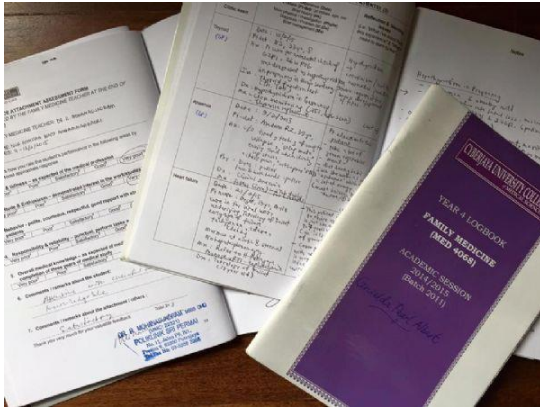
Demographic profile of GP teachers

Item		numbers
Gender	Female	37
	Male	23
Average general practice years of experience		16 (5-40)
Qualifications	Family Medicine Specialist	12 (13%)
	Other postgraduate certifications	45 (75%)
Practice types	solo	27
	partnership	24
	group	9

malaysian primary care 2014



Students' logbook



Students with GP teacher



Better GPs, great teachers, good doctors.

Academy of Family Physician of Malaysia



GP responses

Statement	Strongly agree	Agree	Not sure	Disagree	Totally disagree
I have enough support and guidance to teach students	9(15)	42(70)	6(10)	3(5)	0
I need more skill to teach effectively	7(12)	30(50)	9(15)	12(20)	2(3)
Remuneration I get for teaching students is very important.	2(3)	23(38)	11(18)	15(25)	8(13)
My professional status is enhanced with the presence of students	9(15)	29(48)	14(23)	8(13)	0
My clinic service is improved due to presence of students.	8(13)	18(30)	6(10)	18(30)	1(1.6)
GP training is essential for present undergraduate medical training.	18(30)	30(50)	1(1.6)	1(1.6)	0
Student's presence motivates me to perform better.	13(22)	30(50)	8(13)	7(12)	2(3)
Teaching facilitates me to reflect on my daily work.	13(22)	40(67)	5(8)	2(3)	0

P-0944

The Preferences of the Intern Doctors for Medical Specialization, The Features of Their Perspective Towards Family Health Care Stage

Ahmet Yilmaz, Necmi Arslan, Hamza Aslanhan, Gamze Bucaktepe, Erkan Kıbrıslı

Dicle University Medicine Faculty Department of Family Medicine

OBJECTIVE:

In this present study, the variables which influence the specialization preferences, the perspective towards family health care rotation and branch choices of the 6th grade students who attend Family Health Care Department of Dicle University Medical Faculty are tried to be analysed.

METHODS:

80 medical students participated in this cross sectional study. One being for the beginning and one for the ending, assessment forms were applied to the intern doctors when they started and finished their rotations. question form in the observation of a lecturer from a family health care department about their branch choices, socio-demographic features and possible reasons for choosing the preferred departments.

RESULTS:

Average age was found $24,83 \pm 1,5$. 95 % (n=76) wanted to specialise in any area of medicine and 76,1 % (n=61) were actively studying for the medicine specialty exam. 79,3 % (n=46) of these students were male and 68,2 % (n=15) were female (p=0,296). It was reported that 27,6 % (n=16) of the males and 4.5 % (n=1) of the females extended the school for 8-16 weeks while 31 % (n=18) of the males and 9.1 % (n=2) of the females extended the school for 16-24 weeks (p=0.043). It was seen that before the training, 70 % of the intern students (n=56) had the knowledge about the family health care practices and this knowledge came from the lecturers in the rate of 40 % (n=24), from family health care practitioner-good medicine practices in the rate of 26.7 (n=16), from media-and friends in the rate of 25 % (n=20).

Before family health care rotation, the most preferred branches were internal medicine in the rate of 13,7 % (n=10), cardiology in the rate of 12,3 % (n=9), emergency medicine in the rate of 9,6 % (n=7), dermatology in the rate of 6,8 % (n=5), whereas after the rotation internal medicine was 16,7 % (n=13), emergency medicine was 14,1 % (n=11), dermatology was 11,5 % (n=9), cardiology was 9 % (n=7). The least preferred ones were respectively pathology, neurology and radiology. While radiology was in the rate of 1,3 % (n=1) beforehand, it remained the same afterwards. The preference of family health care was in the rate of 4,1 % (n=3) before the training whereas it became 5,1 % (n=5) after the training. When the students were asked the reasons which influenced their choices, it was seen that allocating time to family and private life was 82,5 % (n=66), risk and responsibility was 52,5 % (n=42), compatibility regarding stress was 68,75 % (n=55).

CONCLUSIONS:

It was seen that male students were at the forefront regarding specialization when compared to female students.

In the process of choosing a branch, allocating time to family and private life and enabling a good social life are dominant factors. We believe that our training practices, which is only at its 8th month, should be promotive and practice-theory applications should go on increasingly

Keywords: family health

P-0945

The VdGM Hippokrates Programme: how senior General Practitioners can be involved in apart from being hosts?

Rosa Avino, Katrina Whalley, Sara Rigon, Jasna Vucak, Solveig Carmienke, Juan Maria Rodriguez, Dinky De Haseth, Ana Barata, Anna Pawelec, Sheila Loughman, Christofer Patrick Reichel, Elodie Hernandez

Vasco da Gama Movement Exchange group

Background & AIM:

The Hippokrates Exchange Programme has been created for trainees and junior GPs within 5 years from the end of their vocational training. What about involving senior GPs and hosts to actively participate in an international exchange? Are they keen to exit their comfort zone and observe different practices as well as their young colleagues?

The aim of this poster is to present results of a pilot phase of a new informal exchange network amongst Hippokrates host GPs, exploring the feasibility of host-to-host exchanges.

METHODS:

VdGM National Exchange Coordinators (NECs) of participating countries each invited at least 2 Hippokrates host GPs to participate. Hosts were asked to complete a short online questionnaire stating their previous experiences, reasons why interested in host-to-host exchanges, and expectations of the experience.

RESULTS:

Ongoing. First results are expected in the further months.

CONCLUSIONS:

We aim to collect data exploring why senior GP hosts are themselves interested in taking part in international exchange experiences; this is a key step in assessing the demand and feasibility of establishing a host-to-host exchange network.

Keywords: Exchange, Hippokrates, mobility

VdGM and Wonca



P-0946

Perceived Stress and State and Trait Anxiety Levels of Intern Medical Students

Fatma Goksin Cihan, Merve Karademirci, Ruhusen Kutlu

NE University Meram Medical Faculty, FM Department, Konya, Turkey

Background and AIM: During their medical education, students may have to deal with many uneasy situations. The aim of this study was to evaluate the concerns about the post-graduation level besides the current concerns of last year medical students.

METHODS: This descriptive study was conducted by the final year students (n=155) of Necmettin Erbakan University Meram Medical Faculty. Besides sociodemographic questionnaire, the Perceived Stress Scale (PSS-8) and the State – Trait Anxiety Inventory (STAI) was performed by face to face interview technique. The results were analyzed using SPSS 20.0 software for statistical analysis, and minimum, maximum and mean values were calculated, frequency and chi-square tests were used.

RESULTS: Forty nine point six percent of respondents were male. While 61.8% of respondents preferred the medical faculty voluntarily, 19.9% by the encouragement of family, 13% preferred because of job guarantee, 5.3% for prestige. Anxiety levels were high in 45.8% of students. Males (60%) had significantly higher anxiety than the females (40%) ($p < 0.05$). Case presentations, service visits and the lack of practical training were causes of statistically higher perceived stress levels and state and trait anxiety levels ($p < 0.01$). Within students with higher anxiety levels, 42.7% were thinking to drop out of medical school. Of participants with high anxiety levels, 32.8% had indicated that they experienced high levels of anxiety mostly during practical trainings ($p < 0.05$).

CONCLUSIONS: Nearly half of the students had high anxiety levels. Both their anxiety and perceived stress levels were increasing with practical applications on patients. This result underlines the importance of practical undergraduate training methods like role playing, applications on models and simulations. Students should spend more time with patients to overcome their anxiety and feel adequate as a physician.

Keywords: Medical students, anxiety, undergraduate training

PSS and STAI scores of the participants

Mean \pm SD

Perceived Stress Score 13.52 \pm 4.14

State Anxiety Score 41.63 \pm 4.85

Trait Anxiety Score 38.42 \pm 10.62

P-0947

UK GP Rural Track Training: Out of Programme Experience (General Practice in New Zealand)

Christopher Mulholland¹, Kate Dixon²

¹GP Registrar, Group Practice Stornoway, NES GP Rural track programme, Western Isles, Scotland.

²GP Registrar, Langabhat Medical Practice, Isle of Lewis, NES GP Rural track programme, Western Isles, Scotland

Background

We had a unique opportunity within our UK rural GP training scheme (based in the Western Isles) to have an integrated 6 month out of programme experience (OOPE) in our 3rd year. Having completed our hospital part of training we wanted to experience General practice in a different rural setting; to gain more clinical experience and understand the differences in delivering rural health care between Scotland and New Zealand (NZ).

Content

We will describe our planning experience and give advice to others on how to plan a clinical OOPE. Explore our journey to East Otago Health, including our experience with the fantastic multi-disciplinary team and community. Learn about the Maori population, who experience gross inequalities in health: Higher rates of CHD, diabetes, obesity, mortality. Discover more behind their health beliefs, exploring Māori culture and values.

Impact/Relevance

General practice in New Zealand faces similar challenges to the UK, particularly in terms of delivery of rural health care services, recruitment and sustainability of the workforce.

Key differences between the healthcare systems in the UK vs. NZ include: Private GP healthcare provision, allowing longer consultation times but at the patient cost. Accident Claims Compensation Scheme (ACC), a national scheme whereby healthcare following an accident is subsidised, ACC co-ordinates the rehabilitation.

Outcomes

Our OOPE has increased our confidence in working independently, further developed our leadership and team working skills. We gained a better understanding of rural healthcare delivery from a different perspective.

Keywords: GP training, OOPE, Rural General Practice

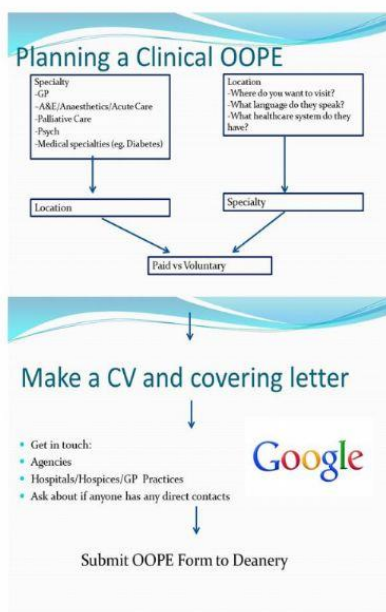
Partnership with Southlink Health



Postcard from NZ



Figure 1-Clinical OOPE Planning



OOPE

GP Rural Track Training: Out of Programme Experience (New Zealand)

Dr Christopher Mulholland, Dr Kate Dixon

Background
The new GP training in the rural GP track programme based in the Western Isles, Scotland, in August 2014 is now completed. The hospital part of our training, and embedded in our Out of Programme Experience (OPE) prior to the remaining GP based training.

The aim of the OPE in the rural track programme is to enable GP trainees to extend their training and enhance their skills and competencies in areas that are difficult to achieve within the standard three-year programme.

This OPE is a month (On our rural track training programme) during our 3rd year of a 4 year programme.

Exit OPE Health
East Dunbartonshire based in Polmont, Otago, South Island, New Zealand. Led by Practice Manager-Cathryn Mackay & Professor of General Practice- Prof. Campbell Murdoch.

Practice Demographics
Approx 3000 (rural) +80% Over 55s, 20% Under 16, Farming, Being, Gold mining.

Our Role
To work as GP Registrar under supervision of Prof. Murdoch between Polmont and Walkabout practices. 8 clinical sessions per week.

Rural Healthcare Challenges
- Important to appreciate the differences of rural vs urban General Practice
- NZ also have similar recruitment and retention problems, particularly rural.
- Geographical issues - distance to secondary care, patient access to GP sites etc.
- Service provision - implications on specialty services locally eg radiology, mental health etc.

Work/Life Balance
From our location in Polmont, we were able to explore the central Otago, Dunedin, Wanaka, Mount Cook, Cairnui all within a 2 hour drive. Good pace of life. Longer appointment times. Fantastic team attitude.

Differences between New Zealand and UK General Practice

UK	NZ
Consultation	Consultation cost between \$30-40 (free for under 5s)
10 minute appointments	15 minute appointments
Free Prescriptions (Scotland +Wales)	Script cost \$5 (at pharmacist)
Free A&E/Casualty care	Accident Claims Compensation scheme -Reduced initial consultation -Free accident/injury related further appts -Case manager to link with employer/physio/private specialist/care services for rehabilitation
Free Secondary Care	Free Secondary Care
Free Older Persons Health/Chronic Disease care	Care Plus scheme-permits 4 free consultations/year (GP/Practice selected)
Free Palliative Care	Free Palliative Care

Maori Health
Maori are the indigenous population of New Zealand and make up about 15% of the population. Yet there are inequalities of health in Maori populations. They have the poorest health of any New Zealand group, higher rates of CVD, diabetes, obesity, mortality than non-Maori. Most are often linked to historical social economic factors. There is ongoing research into health disparities for Maori in New Zealand. Maori are entitled to free cardiovascular screening checks after age of 35. This is a great opportunity for responsible health promotion such as celebrating Māori being about healthy Maori, bringing up smoking cessation, identifying patients, about prostate checks etc.

What did we learn?
Fulfilled our passion for rural General Practice. Truly enhanced our clinical knowledge. Improved our confidence in working independently. Developed our leadership skills with a practice team, undertaking educational sessions and multidisciplinary team working. For the future sustainability of the workforce, we feel it is important to promote rural health and allow flow of professionals between countries.

Table 2: Differences between NZ and UK General Practice

UK	NZ
Free Consultations	Consultation cost between \$30-40 (free for under 5s)
10 minute appointments	15 minute appointments
Free Prescriptions (Scotland +Wales)	Script cost \$5 (at pharmacist)
Free A&E/Casualty care	Accident Claims Compensation scheme -Reduced initial consultation -Free accident/injury related further appts -Case manager to link with employer/physio/private specialist/care services for rehabilitation
Free Secondary Care	Free Secondary Care
Free Older Persons Health/Chronic Disease care	Care Plus scheme-permits 4 free consultations/year (GP/Practice selected)
Free Palliative Care	Free Palliative Care

P-0948

Academic Leadership Development (ALD) Program at College of Medicine- Jeddah; King Saud bin Abdulaziz University for Health Sciences

Saad Abdulrahman Alghamdi, Wesam Abuznahdah, Almoutaz Alkhier Ahmed
National Guard Health Affairs / WR - Saudi Arabia

INTRODUCTION:

The new Medical College in Jeddah (COM-J) – a branch of King Saud bin Abdulaziz University for Health Sciences – is currently confronting many challenges, accelerating the need for effective academic leaders. Unfortunately, little is known about how the competency of academic leaders underpins effective performance or how leaders might be aided in acquiring competency. This environment has driven authorities at COM-J to be proactive in the establishment of the Academic Leadership Development (ALD) program for current and potential future academic leaders.

OBJECTIVES:

To assess the perception of academic leaders on the importance of capability, different approaches and criterion for judging effective performance

METHODOLOGY:

A cross-sectional online survey was conducted with 47 academic leaders at COM-J. In addition to demographic data, information on academic leaders' perception of the importance of three datasets (capabilities, approaches and judging criteria) was collected using a five-point Likert scale (1 – low to 5 – high). The project team and experts in the field of leadership development assessed the face validity of the survey instrument. The reliability of the survey instrument was calculated; Cronbach's coefficient alpha was 0.97 (a high value).

Program Model:

We have adopted a model of academic leadership development that has already been tested in several large-scale studies of effective leadership in higher education.

Results

The response rate was 100% (47), and the academic leaders perceived that a combination of emotional intelligence (both personal and interpersonal), cognitive capabilities and a set of relevant skills and knowledge are necessary for effective performance as an academic leader at COM-J.

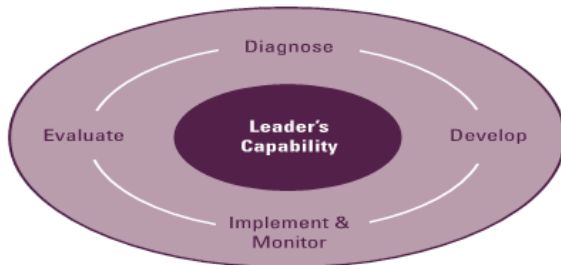
CONCLUSION:

We produced a model for an ALD program at COM-J with the following attributes:

- A set of capabilities and competencies for effective leadership
- A set of quality checkpoints (criterion for judging effective performance)

Keywords: Education, leadership

Figure 1: Model of Academic Leadership Development



Model of Academic Leadership Development

P-0949

Emotional Intelligence in Medical Education

Fusun Artiran Igde, M. Kursat Sahin

Department of Family Medicine, Ondokuz Mayıs University, Samsun Turkey

Background&AIM: Emotional intelligence involves the perception, processing, regulation and management of emotions. In this study we aimed to examine emotional intelligence levels according to the gender, different class of faculty among students at Ondokuz Mayıs University Faculty of Medicine in Samsun-Turkey.

MATERIALS-METHODS: This cross-sectional study carried out in first three years students of medicine between September 2014- May 2015. Turkish adapted form of the revised Schutte emotional intelligence scale and sociodemographic questionnaire was used and data was assessed with the SPSS program.

RESULTS: 532 students (52.5% female, 47.5% male), from first three years of medical faculty participated in the study. 237 (44.5%) students were from the first class, while 144 (27.1%) and 151 (28.4%) of them were class 2 and 3 respectively. The mean age was 20.63 ± 2.73 years. The majority (50%) of the group were in the age range 20–21 years with the remaining 26% being in the age range 18–19 years. Total emotional intelligence test scores were significantly different according to gender; 124.85 ± 6.45 for females and 126.68 ± 8.35 for males ($p: 0.005$) surprisingly females had lower scores than males. Analysis of difference by groups using analysis of variance showed no differences among three classes for emotional intelligence. ($F=2.69$, $p=0.69$)

CONCLUSION: Medicine is an emotionally demanding practice and medical education aims to develop doctors with a wide-ranging of skills including emotionally responsive. Medical schools should update their curriculum promoting emotional intelligence capability.

Keywords: Schutte Emotional Intelligence Scale, Emotional Intelligence, Medical Student, Gender

P-0950

Changes in Empathy during Medical Education

Fusun Artiran Igde, M. Kursat Sahin

Department of Family Medicine, Ondokuz Mayıs University, Samsun Turkey

Background&AIM: Empathy is a key element of patient– physician communication; it is relevant to and positively influences patients' health.

In this study we aimed to investigate changes in students' empathy levels during medical school at Ondokuz Mayıs University Faculty of Medicine in Samsun-Turkey.

MATERIALS-METHODS: This cross-sectional study carried out in first three years students of medicine during September 2014 to May 2015. Turkish adapted form of the student version of Jefferson empathy scale and sociodemographic questionnaire was used and data was assessed with the SPSS program.

RESULTS: 532 students (52.5% female, 47.5% male), from first three years of medical faculty participated in the study. 237 (44.5%) students were from the first class, while 144 (27.1%) and 151 (28.4%) of them were class 2 and 3 respectively. The mean age was 20.63 years, standard deviation 2.73 years. Significant differences in the empathy scores were observed among first three years in medical school (Table) but not between genders.

CONCLUSION: Empathy is crucial for physicians' professionalism and most studies on the patient-physician relationship express that this attitude has a key role in improving clinical outcomes but unfortunately the decrease in empathy during medical education is obvious.

Keywords: Empathy, Medical students, JSE

ANOVA results

		Sum of Squares	df	Mean Square	F	Sig.
	Between Groups	8407,942	2	4203,971	241,537	,000
Jeffpersptaking	Within Groups	8719,931	501	17,405		
	Total	17127,873	503			
	Between Groups	4881,218	2	2440,609	249,896	,000
Jeffcompascare	Within Groups	4980,923	510	9,767		
	Total	9862,140	512			
	Between Groups	1658,907	2	829,454	356,913	,000
Jeffstanpatshoes	Within Groups	1215,435	523	2,324		
	Total	2874,342	525			
	Between Groups	1417,146	2	708,573	39,238	,000
Jefftotal	Within Groups	8830,584	489	18,058		
	Total	10247,730	491			

P-0951

Family medicine residents' and family doctors' perspective regarding implementation of part time vocational training scheme

Mehmet Akman¹, Ç. Batuhan Taşcı², Goncagül Arslan², Ayşegül Özyurt², Merve Karaoğlu²

¹Department of Family Medicine, Marmara University, Istanbul, Turkey

²Medical student, Marmara University, Istanbul Turkey

Background & AIM: Less than 10% of current primary care doctors in Turkey finished vocational training (VT). In order to increase this percent, Ministry of Health implemented a part time VT scheme for family doctors (FDs). However this scheme in its current form considered to be unacceptable and unfair among family medicine specialists and residents. This research aims to explore perspectives of FDs' and family medicine residents' regarding this implementation.

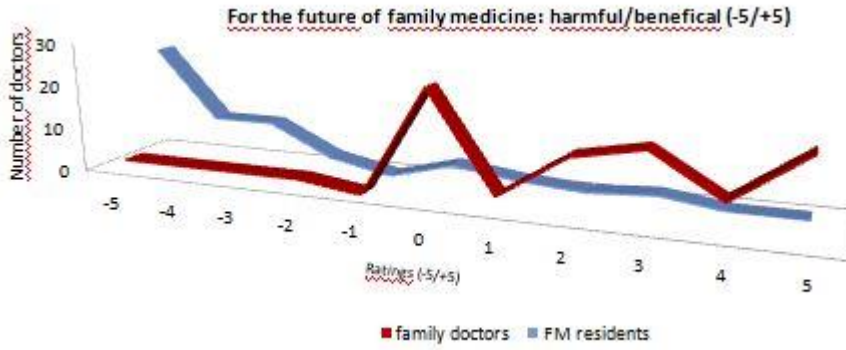
METHOD: A pre-prepared questionnaires were filled by FDs (22 questions) and family medicine residents (15 questions). The data collection was carried out in primary care centres of Üsküdar district, and three teaching hospitals on Asian side of Istanbul. In total 90 FDs and 58 residents gave consent to participate.

RESULTS: 94.1% of family doctors do not think that part time VT would be beneficial for primary care. 92.2% of FDs think that their absence from their current work place will cause serious problems if ever they go for training in a teaching hospital. 71.4% of them believe that their patient list will be affected negatively. 56.7% of FDs under median age (41) thinking about participating half time training, whereas same percent is 26,3% among the family doctors above the median age (41) ($p < 0,05$). 98,3% of the residents concerned about inequalities related to compulsory service after completion of VT. 94.8% of the residents believe that this implementation is unfair and 82.8% of the residents believe that there will be a difference in quality between full time and part time training models.

CONCLUSION: FDs and family medicine residents believe that part time part time VT will not improve the quality of primary care services. According to participants it is not feasible to participate VT while serving for assigned patient list simultaneously. Several opportunities for promoting part time VT cause a perception of injustice among residents.

Keywords: vocational training, family medicine, education, primary care

figure 1



P-0952

Primary Care Family Physicians 1st Stage Orientation Training

Özlem Aynaoglu¹, Çağla Arslan¹, Mustafa Kaya¹, Özlem Yiğitbaşıoğlu¹, Alev Yücel¹, Sevinç Boz², Selahattin Taşoğlu¹

¹Public Health Institution, Ankara, Turkey

²Istanbul Provincial Directorate of Health

AIM: "Primary Care Family Physician 1st Stage Orientation Trainings" are organized for 6 days in order to raise awareness and provide a standardization for the physicians that work at first step primary health care services either during their whole professional career or at a certain period. In this way, it is aimed to equip the physicians who will work at first step primary care health services with the necessary knowledge, attitude and skills required for this specialty.

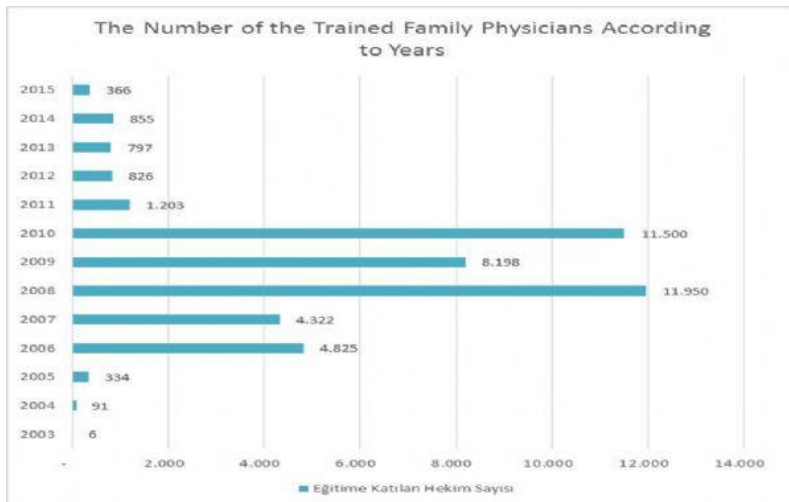
METHOD: Orientation Trainings comprised of 1st stage and 2nd stage trainings. 1st stage Orientation trainings last 6 days. There are 3 or 5 trainers and they co-ordinate the training of a group of 18-25 trainees. Training content consists of interactive methods such as case study based learning, role-playing and reflection and skill guidelines. The content of the training was revised in September 2014 and the duration was updated to 6 days which was 10 days before. Updates will continue towards the needs. Before start of the course an assessment test is held. At the end of each day a questionnaire with five point Likert scale is given. At the end of the course together with a questionnaire that evaluates the whole course period, a final exam is held. The second stage is given by a way of distant learning.

RESULTS: The Number of the family physicians who took 1st Stage Orientation Trainings up to May 2015 is 45.273. The Number of the Family Physicians who are waiting for 1st Stage Orientation Trainings up to May 2015 is 441.

CONCLUSION: Together with the primary care family physician practice individual-centered care approach has emerged and the job-description of physicians is determined as protection, diagnosis, treatment, rehabilitation and consultancy. Standardization and awareness has been set with the support of these adaptation and orientation trainings.

Keywords: Primary care, Family Physicians, 1st stage Orientation Training

Figure 1: The Number of the Family Physicians Who Took 1st Stage Orientation Trainings According to Years



The Number of the Family Physicians Who Took 1st Stage Orientation Trainings According to Years; the total number is 45.273 by May.

Figure 2: The Number of the Family Physicians Who Took 1st Stage Orientation Trainings According to Provinces.

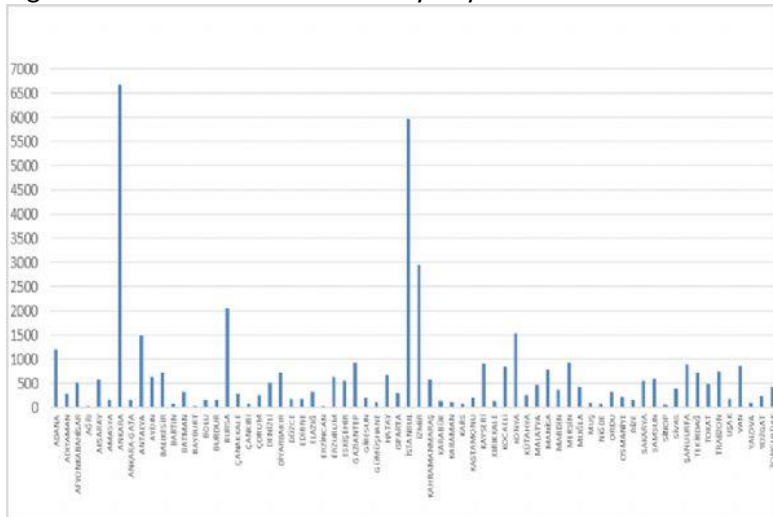


Table 1: Training Topics of Primary Care Family Physician 1st Stage Orientation Training.

1. The definition, the history and the basic principles of the family Medicine.
2. Organization and Finance and payment models in family medicine.
3. Record and registration keeping in first step primary care, electronical medical recording and coding in family Medicine.
4. Basic principles in communication, patient-physician interviews.
5. Biopsychosocial approach to the patient.
6. Approach to the nonrecognised patient.
7. Periodical health examination.
8. Identification of training needs-How we learn-Patient training.
9. Research in primary care practice, research topics, basic epidemiological and statistical terms.
- 10 How to read an article.

Training Topics

P-0953

Vitamin D:the updates,primary health care aproach

Dusan Popovic, Kenan Katana

Primary Health Center Podgorica, Montenegro

THE AIM: For a long time the importance to measure the level of vitamin D in the serum was ignored. The fact is that vitamin D deficiency in 50-70% cases is unrecognized by doctors at all levels of health care. The deficit of vitamin D and its associated disease is not a rare occurrence, like many serious problems of the modern era. The aim of this review is to remind us all a little on the current knowledge, to be aware of the news in the treatment of diseases and what is most important-preventing Vitamin D deficiency-dependent diseases in primary-level health. The emphasis is on the need for better recognition of the symptoms and risk groups, for detecting the risk of disease before its occurrence by a doctor in PHC.

METHOD: This study represents a sublimates of the latest researches and prevention measures, the physiology of vitamin D with emphasis on high-risk groups and lifestyles that can lead to serious disease. This type of review will be a good reminder for the daily work in clinics. The principle consists in identifying people of high-risk groups, and to measure the concentration of vitamin D serum, depending on the value the protocol will be given based on the amount of the supplement which is necessary for prophylactic and therapeutic treatments.

CONCLUSION: According to knowledge, the adequate intake of vitamin D is very important during the childbearing age (rickets), osteoporosis, also in children who have problems with the bronchi, multiple sclerosis, while some authors claim that this is important even in cancer prevention, based directly on the immune system. The cooperation with PHC laboratories is very important for providing this type of screening in PHC level and to improve the health system.

KEYWORDS: vitamin D, prevention, osteoporosis, rickets.

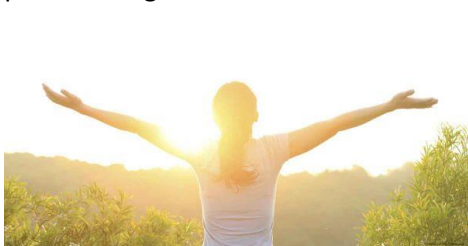
Keywords: vitamin D, prevention, osteoporosis, rickets.

conclusion



last slide

poster background



background

results

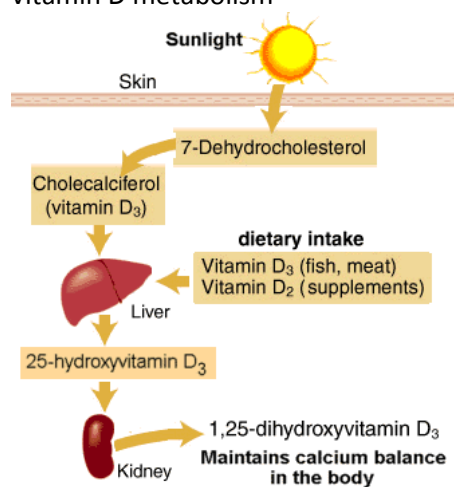
10 Reasons You Need Vitamin D ALL YEAR ROUND

1. Improves Muscle Function
2. It Blunts Your Appetite
3. Protects Lung Function
4. Can Help You Shed Weight
5. Lowers Blood Pressure
6. Shuts Down Cancer Cells
7. Lowers Risk of Mortality
8. Reduces Alzheimer's Risk
9. Affects Hundreds of Genes in Disease Preventing Potential
10. Reduces Risk of Osteoporosis



reasons for vit D intake

vitamin D metabolism



about sources and metabolism of vitamin D

treatment and diagnosis

Serum 25-hydroxyvitamin D concentrations

status and management

<10 mcg/L (<25 nmol/l)

Deficiency:

High dose treatment initially (3200 iu daily for 8-12 weeks), then long term maintenance treatment required (1600 iu/d).

10-20 mcg/L (25-50 nmol/l)

Insufficiency:

long term maintenance treatment (1600 iu/d)

20 – 30 mcg/L (50-75 nmol/l)

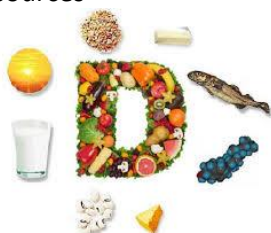
Healthy, give lifestyle advice

>30 mcg/L(>75 nmol/l)

Optimal

supplementation level

sources



more info

P-0954

Primary School Teachers' Knowledge On Dyslexia, In Turkey

Hamit Sırrı Keten¹, Oğuz Işık², Hakan Öney³, Özgür Ersoy⁴, Yaşar Koşar², Soner Ölmez⁵, Mustafa Çelik²

¹Department of Family Medicine, Kurtul Family Health Center, Kahramanmaraş, Turkey

²Department of Family Medicine, Medical Faculty, Kahramanmaraş Sutcu Imam University, Kahramanmaraş, Turkey

³Faculty of Arts and Humanities, Arts, Sciences & Technology University in Lebanon, Beirut, Lebanon

⁴Department of Public Health, Medical Faculty, Cukurova University, Adana, Turkey

⁵Department of Family Medicine, Samsat Family Health Center, Adıyaman, Turkey

BACKGROUND: This study aims to determine primary school teachers' knowledge about dyslexia among Turkish students.

METHOD: This survey study conducted in 64 primary schools in Kahramanmaraş, Turkey between 01.02.2015 and 01.04.2015. A total of 617 primary school teachers participated in the study. A questionnaire comprising questions regarding socio-demographic and professional features, their knowledge about dyslexia were applied to teacher through a face to face interview. The level of knowledge was assessed by 20 questions and 20 points for each.

RESULTS: Out of 617 participants 330 (53.5%) were male and 287 (46.5%) were female, while the mean age was 40.81±9.76 (min=22, max=63) years. Regarding answers to "Have you ever heard the term dyslexia?" 412 (66.2%) participants answered yes, while interestingly 205 (33.2%) participants answered no. Only 52 teachers (8.4%) had received special training in dyslexia, while 565 (91.6%) not. The average knowledge score of participants was 6.58±3.70 (min = 0, max = 15) point. A majority of participants (n:456, 73.9%) were agreed on definition of dyslexia as "specific learning disorder". Of participants 272 (44.1%) agreed the wrong statement of "The use of colorful objects and colored covers might be helpful in dyslexia", while 315 (51.1%) stated that they had no idea about this suggestion. Almost half of participants (n:289, 46.8%) agreed the wrong statement of "Making eye-tracking exercise is effective in treating challenges of Dyslexia", while 295 (47.8%) had no idea about this suggestion.

CONCLUSION: Obtained findings suggest that primary school teachers seriously suffer from lack of knowledge and misinformation about dyslexia. This possibly caused by low number of teachers trained about dyslexia. Joint projects by Ministry of Education and Ministry of Health, and efficient use of media will be helpful in fight against dyslexia.

Keywords: Dyslexia, Reading disorder, Learning disorder, Teachers, Primary school

P-0955

Social Problem Solving and Coping Skills of Medical Students

Emel Yigit¹, Sevgi Ozcan¹, Gulsah Seydaoglu²

¹Department of Family Medicine, Çukurova University, Adana, Turkey

²Department of Medical Education and Biostatistics, Çukurova University, Adana, Turkey

AIM: Social problem solving has been defined as the set of instrumental, cognitive-behavioural skills necessary for adaptation in everyday life. The aim of this study is to determine medical students' social problem solving and coping skills.

METHODS: In this correlational descriptive study, data were gathered from 457 medical students (206 female and 251 male), selected through 1 (n=214), 4(n=142), and 6 (n= 101) grade. Social Problem Solving Inventory (SPSI) and Social Problem Coping Behaviours Inventory (SPCB) were used.

RESULTS: Data analyses showed that social problem solving and coping skills of medical students were around the average level. The most frequent problem solving approaches were positive and rational styles. The most frequent activities when they face a social problem were meeting with friends (87.1%), meeting with special person (85.4 %), sleeping (82.6%), meeting with family members (81.6%), and eating (79.8%). Those whose mother education is high, whose family income is high, who have chronic illness, who have lost year, and men have a significantly high score of addictive coping behaviours (such as playing chance games, smoking, using alcohol and drug). There was a positive relationship between total scores of SPSI and SPCB ($r= 0.40$, $p< 0.05$). Immature social problem solving ability has increased the risk of unfavourable behaviours by 3.1 fold (OR: 3.1, 95 % CI: 2.2 -4.7, $p= 0.0001$).

CONCLUSIONS: The results of our study demonstrate that social problem solving ability is significantly correlated with coping behaviours and may predict it. Medical students who are the doctors and the role models of the future need to develop their social problem solving skills in addition to clinical problem solving skills.

Keywords: medical students, social problem solving, coping behaviours

P-0956

Attitudes, Behaviors and Knowledge of Family Physicians Regarding Rational Drug Use

Hande Perk Gürün, Dilşad Save, Seyhan Hıdıroğlu, Belma Çalışkan

Department of Public Health, Marmara University, İstanbul, Turkey

Background&AIM: WHO has described rational drug use in 1985 in Nairobi. Irrational drug use is still a problem for developing countries like Turkey. The aim of this study is to evaluate attitudes, knowledge and behaviors of family physicians regarding rational drug use. METHOD: The study was conducted among family physicians who agreed to attend study, between May and June 2015, in İstanbul. RESULTS: In our study 75 of the physicians was general practitioner and 14 was professional family physicians. The mean of daily patient exam was 55. %80.7 was attend an after graduate education and %51.1 was attend a rational drug use education. To apply a guideline rate was %94.4. Results: In our study 75 of the physicians was general practitioner and 14 was professional family physicians. %80.7 was attend an after graduate education and %51.1 was attend a rational drug use education. To apply a guideline rate was %94.4. The most frequent applying guide is Vademecum (%64). Drug using knowledge is medium and higher among all physicians (indications, pharmacological properties, contraindication and etc.). Physicians frequently ask drug allergy, liver and kidney disease, chronic disease, pregnancy and age for history but they ask gender rarely. According to %48 of the family physicians (43), giving information about drugs not enough for patients. Physicians rarely say efficacy mechanism(%6.7), price(%3.4), interactions with food and drug(%8) to patients. %40.4 of physicians control if patients understand how they use the drug. Using a prescription guide is statistical significant among physicians attend and not attend a rational drug use education($p<0.02$). Reporting side effect is statistical significant among physicians attend and not attend a rational drug use education($p<0.001$).

CONCLUSION: it was shown that family physicians do not fully apply the principles of rational drug use while

managing their patients. This problem might be solved partly by continuous education of the physicians about this issue.

Keywords: rational drug use, family physician, knowledge

Table 1 Physicians' declarations about 'characteristics of patients' influencing their choice of treatment' and on 'providing information to patients on their treatments' (n:89)

Physicians' declarations	Detailed information requested	Physicians(%)
Taking patients' medical history into consideration in drug choice	Previously used drugs	94.3
	Chronic disease	92.0
	Age	98.9
	Pregnancy	94.4
	Renal disease	73.9
	Hepatic disease	74.2
	Gender	71.6
	Drug allergy	85.4
Providing sufficient information to the patient about treatment	Monitor the therapeutic outcome	50.6
	Ensuring everything to make patient understand about the treatment	40.4
	Non-pharmacological recommendations	36.8

Table 2 Information provided by physicians on the prescribed medicine (n:89)

Information provided on prescribed medicine	Physicians(%)
Name	56.3
Application form	91
Dose	91
Treatment period	92
Mechanism of action	15.7
Possible side effects	48.3
Price of drug	8.0
Drug-food interactions	35.2
Activities to avoid	39.1
When to give up treatment	88.8
Other warnings	50

Table 3 Physicians' declarations about 'benefit from reference sources' and 'main factors contributing to prescribing pattern' (n:89)

Questions referring to reference sources and prescribing behaviour	Factors	Physicians (%)
Reference sources	National drug guideline	19.5
	Clinical guideline	50.6
	Vademecum	65.5
	Pharmacology textbooks	21.8
	Drug info softwares	13.8
	Pharmaceutical company advertisement	19.5
	Colleague	29.9
	Internet	72.4
Factors contributing prescribing pattern	Post-graduation self-study	41.3
	Post-graduation in-service training	20.3
	Discussing with Colleague	6.3
	Pharmacology lessons	26.3
	Pharmaceutical company advertisement	5.1

Table 4 The distribution of physicians' declarations on their general knowledge of medicines (n:89)

Knowledge of medicine	Good(%)	Average(%)	Poor(%)
Indication	89.9	10.1	0
Application form	84.3	13.5	2.2
Pharmacological characteristics	44.9	48.3	6.7
Contraindications	54.5	44.3	1.1
Adverse effects	49.4	47.2	3.4
Drug interactions	33.3	52.3	14.8
Warnings	50.6	44.9	4.5
Private conditions	71.9	25.8	2.2
Bioequivalence	51.1	38.6	10.2

P-0957

A Community Based “Primary Care Internship Program”

Senem Buğdaycı¹, Pemra Ünalın¹, Işıl Maral², Serap Çifçili¹

¹Department of Family Medicine, Marmara University, Istanbul, Turkey

²Department of Public Health, Marmara University, Istanbul, Turkey

Background&AIM:

In this study we aimed to share the principles, goals and education methods used in the “Toplum Sağlığı Bloğu”. That module which was ran for the first time in the 2014-2015 school year for the Marmara University School of Medicine(MUSM) interns who will end their internship with a board-like exam for medical specialties(TUS). In addition, feedbacks given by the module attendants and teachers will be shared.

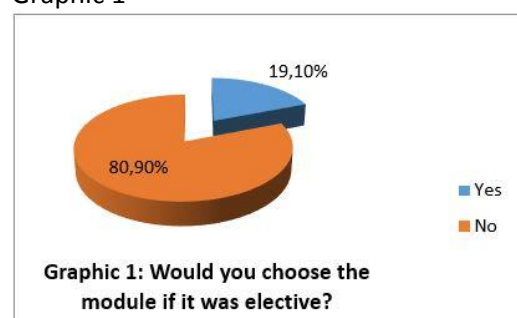
METHODS: A 17-week “Community Health” module was implemented to the curriculum of MUSM in 2014. After a multi-departmental planning, the block started with the essentials of public health, family medicine, and an introduction to research in primary care. The researches were planned and carried out in the community with supervisors. Public health lectures and practices, ambulatory discussions about most common clinical problems in family medicine, lectures in forensic medicine and obstetrics, including family planning and counselling in reproductive health were given. The module motivated self-directed learning with free study times. The expectations and the feedback were surveyed. Deep interviews were conducted with faculty members and GPs who took place in this program. Thematic analysis was performed.

RESULTS: Of the 110 participants 57 were male, 17 were positive about working in primary care and only 21 would choose the module if it was elective. Attendants rating the module higher, would participate if the module were elective ($p=0,000$; $t=5,367$). Attendance would also increase if there were no TUS examination ($n=47$; $p=0,000$; $t=3,609$). Studying for TUS was the most remarkable one common among the expectations.

CONCLUSION: It was seen that interns are not familiar with the concept of community oriented health care and their main concern was to have more study time for TUS. So a shorter but more effective and student centered program should be planned.

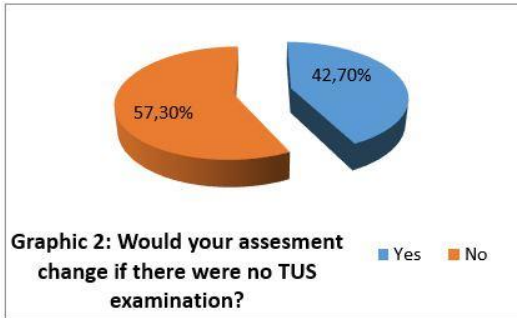
Keywords: Community Health, Community Based, Family Medicine, Public Health, Multi-Departmental Planning

Graphic 1



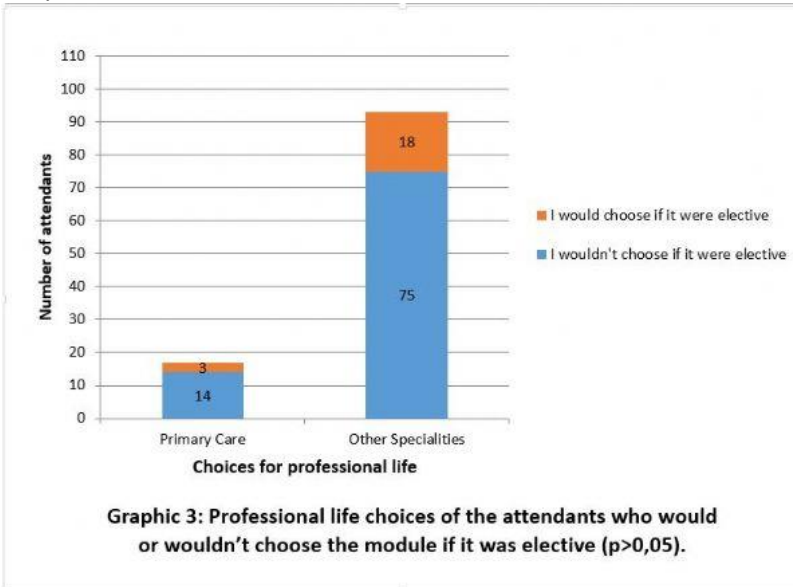
Number of attendants who would choose the module if it were elective.

Graphic 2



47 attendants, who said that they would choose the "Toplum Sagligi Blogu" module if there were no TUS examination gave an average of 5,53 out of 10 points to the module. Attendants, who wouldn't choose the module (n=63) gave the module 4,11 out of 10 points on average. The difference was statistically significant (Student's t-test: p=0,000; t=3,609).

Graphic 3



Professional life choices of the attendants who would or wouldn't choose the module if it was elective (p>0,05).

Table 1

Elements of the Module	Public Health	Family Medicine	Psychiatry	Forensic Medicine	Gynecology & Obstetrics	Research
Organisation	4.94	4.86	5.45	7.09	3.56	5.66
Time	5.37	5.19	5.01	5.89	4.74	5.66
Competence of the trainer	5.40	5.20	6.26	7.39	4.00	5.87
Convenience of the content for 6th grade	3.88	4.05	4.98	6.50	3.92	4.63
Free study time	3.98	3.84	4.91	5.67	4.44	4.75
Communication with the consultant	4.87	4.32	5.21	6.46	3.37	5.44
Contribution for the exam 'TUS'	2.43	2.46	3.23	3.71	2.58	2.46

Average points given to different aspects in the module "Toplum Sagligi Blogu" on a 10 point scale.

P-0958

Family Physicians Continuing Professional Development Training (AHUZEM)

Çağla Arslan, Özlem Aynaoglu, Özlem Yiğitbaşıoğlu, Selahattin Taşoğlu, Mustafa Kaya, Alev Yücel, Irfan Şencan
Public Health Institution of Turkey

AIM: Family Medicine Continuing Professional Development Training is given to Physicians working in primary care to improve and update their professional knowledge.

METHOD: Family Medicine Continuing Professional Development Trainings was started on 01.12.2012 as a way of distance learning. Training is provided by the Distance Education Platform continuously updated modules. There are a total of 166 courses located in 15 modules in the system. Training material has been prepared by academics who specialize in the field of educational research in universities and hospitals. Academic personnel make their course presentations towards specified content with video recordings in Distance Learning Platform, measurements and assessments are carried out via implementing pre-tests and final tests before and after courses. To successfully complete the training, trainees must get at least 50% of the final test correct. Duration of training is planned to be at least 1 year.

RESULTS: A total number of 21.686 physicians have attended to the AHUZEM. 19.885 of these are Family Physicians, 971 are Family Medicine specialists and the 830 of these are Public Health Directorate Physicians..

CONCLUSION: At the end of 2010 in Turkey, the implementation of family medicine was completed and with transition to family medicine practice, transitional period trainings have begun in Turkey. Transitional period trainings in our country are divided into two main phases. Under Public Health Institution of Turkey, trainings have begun with 2nd Phase Trainings via Distance Learning Platform at the end of 2012 and constitute an important place among e-Learning applications. To ensure the improvement of service quality standards, family practitioners are obliged to attend at least 80% of the first and second stages of education and other training, determined by the Public Health Institution of Turkey.

Keywords: AHUZEM, Family Physicians Training, 2nd phase trainings.

Figure 1: The Login Screen of Distance Learning Platform

Table 1: AHUZEM Module Titles

Modul Number	Module Name
1.	Approach to symptoms Module
2.	Adult Health and Diseases Module
3.	Module of Child and Adolescent Health and Medicine
4.	Muscle and Joint Disease Module

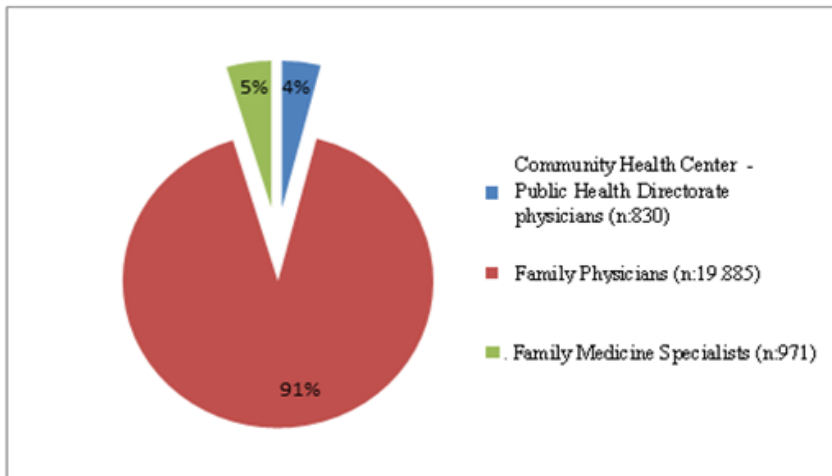
5. Elderly Health Module
6. ASM Management, Operation and Regulatory Module
7. Patient-Physician Communication Module
8. Improving the Health and Periodic Inspections
9. Module Mental Health and Diseases
10. Occupational Health and Safety Module
11. Rational Drug Use Module
12. Reproductive Health and Women's Health Module.
13. Common Emergencies in Primary Care and Conditions Requiring Multidisciplinary Approaches Module
14. Surgical Module
15. Infectious Diseases Module

Figure 2: A Screen of Distance Learning Platform



AHUZEM examples of course content.

Figure 3: The Distribution of the Participants According to Title.



P-0959

vasco da gamma movement session feedback a national survey from turkey

Fethi Sada Zekey¹, Berk Geroğlu², Demet Merder Coşkun³, Canan Tuz⁴, Fikret Merter Alanyalı²

¹department of family medicine, ümraniye eğitim araştırma hastanesi, istanbul, Turkey

²department of family medicine, tepecik eğitim araştırma hastanesi, izmir, turkey

³department of family medicine, marmara university, istanbul, Turkey

⁴department of family medicine, başkent university, ankara, turkey

Vasco da Gamma Movement (VdGM) is a working group for young general practitioners (GP). "Young" term includes GP trainees and specialist GPs in their five years. Turkish VdGM team organised a session in a national congress in September'14 in Antalya and conducted a national survey to identify the perspective of its participants.

During a one hour session, team explained the aim of VdGM and its activities. In the end participants were asked to be volunteer to fill the feedback forms about that session.

The feedback forms were consisted of seven 1 to 5 Likert scaled item (1 was "I totally disagree" and 5 was "I certainly agree.") and an open ended item in which participants could give their opinions and suggestions briefly. Mean points for all questiones were calculated and answers for the last item was identified.

All of 32 participants filled the forms. The highest mean point was given to item questioning the content and the lowest mean point was given to questioning the impact of this session to the future career.

The last item was filled by nine participants. Three participants thanked to VdGM team for organising that session. One participant applied for a membership and two participant for the next VdGM exchange programme. One participant complained about the membership criteria which was to be "young" and one participant suggested to add a new criteria which allows not specialist GPs to become a member. One participant criticized the session not to have a formal language and evidence based background.

Session was found to be paralel to to the topic and its content. Language of VdGM sessions among Europe might not be familiar to some Turkish participants. Turkish team could offer to VdGM executive group to discuss about membership criteria.

Keywords: vasco da gamma movement, feedback, executive group, session

P-0960

Started as an aching neck

María Del Mar Solís Aguilera¹, Ruth Muñoz Maya², Elvira García Martín³, Carmen María Jiménez Herrera¹, Ángel Hurtado De Mendoza Medina⁴, Diana Dominguez Jiménez⁵, Ana Belén Bárcena Atalaya⁶, José Gómez Rubio⁷

¹CS Nuestra Señora de la Oliva, Alcalá de Guadaíra. AGS Sevilla-Sur, Andalussia, Spain.

²CS Don Paulino García Donas, Alcalá de Guadaíra. AGS Sevilla-Sur, Andalussia, Spain.

³CS Utrera Sur, Utrera. AGS Sevilla-Sur, Andalussia, Spain

⁴CS Doña Mercedes, Dos Hermanas. AGS Sevilla-Sur, Andalussia, Spain.

⁵CS Estepa, Estepa. AGS Osuna, Andalussia, Spain

⁶Emergency Department, Valme University Hospital, Sevilla. AGS Sevilla-Sur, Andalussia, Spain

⁷Internal Medicina Department, Valme University Hospital, Sevilla. AGS Sevilla-Sur, Andalucia, Spain

Male aged 20 years old, no relevant medical history. Consults of painful swelling in left side of the neck two days ago. It appeared while doing workout at the gym. No other symptoms then nor now.

Exploration: Acceptable general condition. Well hydrated and perfused. Normocoloured. Eupneic. Afebrile.

Normal ENT area. Cardiopulmonary auscultation and abdominal palpation without findings. In his neck he has left supraclavicular gummy indurated tumor that seems to be adhered to deeper tissue. Size 1x2cm. Aches at palpation. Normal cervical movement, painful muscle palpation. No palpable adenopathies.

Clinical judgement: Left cervical protuberance: Adenopathy vs Muscle tear with hematoma.

Initial treatment: Ibuprofen 600mg/8h. Review in one week if no improvement.

Evolution: a week later, the mass has grown, so we decide to perform an ultrasonography at our office: we see a rounded image measured 3.8x2.9cm, heterogeneous and hypoecogenic. We then request general blood test including Cytomegalovirus and Epstein-Baar serology and a chest Xray that appear to be normal. Our patient is referred to the Internal Medicine Department, where a new ultrasonography reveals left supraclavicular and jugular adenopathic conglomerates. The biopsy of the adenopathies show a pattern consistent with Non-Hodgkin lymphoma (nodular sclerosis).

Finally he is referred to Hematology to finish extension study and treatment.

Final Diagnosis: Non-Hodgkin Lymphoma.

Conclusion (and contribution to family doctors): The challenge of Family Medicine is identifying that need to be referred to a second assistance level due to a malignant suspicion. Ultrasonography becomes a new diagnostic eye and ease diagnostic and therapeutic approach, so we can refer a patient sooner and more properly to a certain specialist. We so consider education in ultrasonography very important for new specialists.

Keywords: Adenopathy, swelling, ultrasonography, Non Hodgkin Lymphoma

Adenopathy 1



Tumor ultrasonography. Measure.

Chest XRay



Postero-Anterior display.

P-0961

Evaluation of Family Medicine Residents' Competency in Ophthalmology Patient Care at Primary Health Care Settings

Hilal Biten¹, Rabia Kahveci², Dilek Çalışkan Özçelik², Esra Meltem Koç³, İrfan Şencan², İsmail Kasım², Adem Özkara²

¹Ankara Numune Training and Research Hospital, Ankara, Turkey

²Department of Family Medicine, Ankara Numune Training and Research Hospital, Ankara, Turkey

³General Directorate of Health Researchs, Ministry of Health, Turkey

OBJECTIVES: The aim of this study is to obtain the thoughts, knowledge levels and training needs' of the family medicine residents in Ankara about ophthalmology in Ankara. Also with this study we aimed to raise awareness on this issue and guide the studies that aimed to promote standart care for ophthalmology patients.

METHOD: Between 01/04/2015-01/05/2015 we applied a questionnaire, developed by researchers to the family medicine residents who were working at a training and research/ university hospital in Ankara. We reached to the 200 family medicine residents to join to the survey but 196 of them completed the questionnaire. Data analysis was performed with SPSS 21.0 for Windows application.

RESULTS: Only 12,8% of the residents think that the ophthalmology training given in the medicine faculty is enough, but 54,1% of them disagree and 33,2% of them partially agree. It's found that the most common cause of inadequate training in medical faculty is lack of practice. 9,5% of the family physicians agree that the ophthalmology training given during the family medicine specialization training is enough but 67,5 % of them disagree and 20,5 % of them partially agree. Residents think that ophthalmology education in family medicine training is not sufficient because Ophthalmology rotation is optional in the curriculum.

CONCLUSION: It has been advised that current curriculum of family medicine training should be revised according to the needs of primary health care profile. The curriculum should involve topics oriented for common symptoms and signs of eye disorders and aid to raise knowledge and skills in primary health care settings.

Keywords: Family medicine, training requirements, ophthalmology

P-0962

Knowledge of Tuberculosis Among Health Higher School Students'

Vasfiye Bayram Değer¹, Betül Battaloğlu Inanç², Sema Çifçi¹

¹Mardin Artuklu University, Health Higher School, Mardin.

²Muğla Sıtkı Koçman University, Faculty of Medicine, Family Medicine Department

AIM: Aimed to determine students' tuberculosis (tbc) knowledge level and effectiveness of education. **MATERIAL-METHOD:** A questionnaire form which consisting of 10 questions was applied to Mardin Artuklu University Health School students in 18-19 April 2013 to determine their level of knowledge before and after a two-day training for tuberculosis.

RESULTS: 196 students' data were included. After training, most common right answers rate were initially 22.4% whose vaccinated necessary, 13.7% whose control after tbc patient close contact and 13.3% what was the tbc illness agent were learned

by students. After training, the way of diagnosis to patient was remained basically same, right answers rate decreased 1.5% which organs influence with tbc, 0.5% increased right answer rate for risk of spread tbc but remained lowest among the other right answers. Tbc disease agent is a bacteria, smudge with airway is agreed by the students' ($p=0.0001$). Whose risk of developing tbc and how was treat patients was learned increasingly by students after training ($p=0.0001$). Before training, awareness of the spread of tbc to lung, lymph node and brain membrane was known and was found significantly ($p=0.0001$). After training, vaccination of infants ($p<0.001$), and most common symptom of pulmonary tuberculosis ($p=0.0001$) is shown statistically significant. After training was thought to diagnosed tbc with skin test was statistically significant ($p <0.001$). Training was not change student's knowledge and approach this two points; whose control was necessary with tbc close contact persons' ($p=0.065$) and what was the directly observed treatment ($p=0.058$).

DISCUSSION: Although, our students' knowledge about tuberculosis is enough but continuing education programs, and updating of information must provide.

Keywords: Tuberculosis; Nursing Students; Midwifery Students; Knowledge Level

P-0963

Sights of family medicine residents about training in practise

Sezin Yılmaz, Mehmet Karacagil, Dilek Güldal, Tolga Günvar
Dokuz Eylül University, Family Medicine, İzmir

BACKGROUND and OBJECTIVE: Training in practice is indispensable part of specialization training and must be performed in primary care under the supervision of the family medicine trainers. Although specialization training is given in our country for more than 30 years, the legal regulations related to training in practise is the product of the last two years. In our study, it is aimed to investigate how this new form of training is perceived by the family medicine trainees.

METHOD: A cross-sectional study is conducted among the residents of family medicine. A questionnaire is distributed to trainees through family physicians mail groups. Data were entered into SPSS 15.0 programme and the chi-square and t tests were performed besides the descriptive analysis.

RESULTS: The average age of the participants was 29.3 and 69% of these were women. 90.2% of the participants reported that training in practice was necessary, however only 67.8% of the participants stated that there should be 6-12 months training period in family practice, 78.6% that the practice should be within walking distance or 30 minutes away by public transport to the hospitals and 74.1% that the patient lists should include people from different socioeconomic levels. The ratio of participants reported that the faculty members and trainers should be in the training practice as consultants were 65.2% and 73.2% in order. 44.6% of the participants thought that trainees and all trainers should be responsible in chain if a malpractice exists. 69.6% of the participants stated that the number and variety of patients should be considered for evaluation of the trainees. While 46.4% of the trainees thought the number of patients in their lists should be between 1001 to 2000.

CONCLUSION: Residents know the importance of training in practice, but there is different between their expectations and official regulations.

Keywords: resident, training in practice, education

P-0964

Determination Of The Effect Of Thalassemia Training Programs On Educational Level Of Thalassemia Traits

Hamit Sırrı Ketten¹, Medine Çitil², Yeşim Can Çelik³, Oğuz Işık⁴

¹Department of Family Medicine, Kurtul Family Health Center, Kahramanmaraş, Turkey

²Department of Family Medicine, Public Health Center, Kahramanmaraş, Turkey

³Department of Biochemistry, Public Health Laboratory, Kahramanmaraş, Turkey

⁴Department of Family Medicine, Medical Faculty, Kahramanmaraş Sutcu Imam University, Kahramanmaraş, Turkey

BACKGROUND: The aim of this study is to determine the effect of thalassemia training programs on educational level of thalassemia traits.

METHOD: In this study, 67 individuals that have been diagnosed as thalassemia traits in their premarital hemoglobinopathy screening between July 2014 and February 2015 in Kahramanmaraş Mother and Child Care and Family Planning Center, were enrolled. Ten knowledge questions about thalassemia were addressed to participants prior to the training. Each question was scored with one point and the educational level was evaluated on 10 points. Then individuals were given a training program of 15 minutes, and the items were requestioned.

RESULTS: Forty two (62.7%) of participants were male, 25 (37.3%) were female, and the mean age was 26.01±5.80 (min=18, max=50). Thirty four (50.7%) participants stated that they had heard about thalassemia disease before, while 33 (49.3%) participants stated they did not. Mean score of the survey before the training program was 3.52±3.23, and the mean score of the test after training was 8.80±1.52. We found that educational level of participants increased significantly after the training (p=0000). In our study, mean score of women before the training was 3.32±3.00, and the score of men was 3.64±3.39. Educational levels of men and women were

similar ($p=0.696$). We found that the mean score of individuals that were high school graduates or below was 3.26 ± 3.44 , and the mean score of individuals that were university graduates or above was 3.15 ± 3.04 . Educational levels of high school graduates or below and university graduates or above were similar ($p=0.912$).

CONCLUSION: We determined that thalassemia traits seriously lacked information about thalassemia. Furthermore, we detected that the training program about thalassemia increased their educational level significantly.

Keywords: Thalassemia; thalassemia trait; training

P-0965

« Being young, getting old » the role of family physicians throughout the years

Monique Aubart Schuller

SSLMG- Société Scientifique Luxembourgeoise de Médecine Générale

1. Background and AIM:

Trying to stay young is a very popular aim in our society, whereas age, illness and disability often are avoided in public discussions. While life expectancy constantly grows, our fear of ageing, getting dependent and dying grows too.

What's the role of the GP in our ageing society? Do we need special skills to counsel our ageing patients (while we're getting older with them)? How do we GPs face anti-ageing medicine?

2. METHOD:

literature research and statements of patients

3. RESULTS:

A great variety of anti-ageing products already exists and is largely sold i.e. vitamins, resveratrol, omega acids etc. Other methods like stem cell therapy, nanotechnology or cloning promise life extension, sometimes with the hope of overcoming death.

Talking to our elderly patients their opinion often contrasts anti-ageing movement.

4. CONCLUSIONS:

Flexibility is one of the keys for well-ageing, accepting changes in life, adapting to different phases of development are elementary if we want to pass different stages in our lives without bigger problems. The role of GPs gets more and more important, the number of older patients grows throughout our careers. Good skills in communication, geriatrics, and palliative care are beneficial while sometimes simply listening to our elderly patients and spending enough time with them can be the best for them and very enriching for us.

Keywords: ageing, flexibility, longevity

P-0966

Resident Physician's Empathy Levels and Related Factors

Ceren Karaman Kenesari¹, Nilgün Özçakar², Mehtap Kartal³, Zafer Şişli⁴

¹ceren KARAMAN KENESARI, Dokuz Eylül Üniversitesi, İzmir, Türkiye

²Nilgin ÖZÇAKAR, Dokuz Eylül Üniversitesi, İzmir, Türkiye

³Mehtap Kartal, Dokuz Eylül Üniversitesi, İzmir, Türkiye

⁴Zafer Şişli, Dokuz Eylül Üniversitesi, İzmir, Türkiye

Background & AIM:

Empathy is reflecting one's inner feelings to an object or event, and the ability to experience one's feelings and thoughts matching another person's. Physicians, while treating the diseases, have to remember their patients are human beings and create empathy with them. Empathy of the physician increases patients' satisfaction and has a positive impact on the patient's health status and leads physicians to show more ethical approach and more effective and accurate diagnosis. It's aimed to investigate empathy levels of residents and related factors.

METHOD:

The study was completed by 306 residents in Internal and Surgical Sciences Departments of Dokuz Eylul University Medical Faculty. Questionnaires including sociodemographic characteristics and Jefferson Scale of Physician Empathy (JSPE) and Swedish Demand Control Support Questionnaire were administered. Student's t test, ANOVA were used and $p < 0.05$ was considered as statistically significant.

RESULTS:

The response rate was 60.5%, 52.9% were female. Mean age was 28.9 ± 2.9 , 63.4% ($n=194$) were in Internal Sciences Departments and 82.7% ($n=253$) were in specialties they wished. Total mean score of JSPE was 67.1 ± 9.8 (43-100). Swedish Demand Control Support Questionnaire total mean score was 67.3 ± 7.6 (42-85). Subscale mean scores were for workload 14.9 ± 2.5 (7-20), job control 18.8 ± 2.9 (8-26) and social support 17.3 ± 3.8 (6-24).

There was no difference in empathy scores by gender, women defined their workloads lower ($p=0.002$). Empathy levels decreases with seniority but not significant ($p=0.335$). Empathy scores of internal science residents, is higher, but not significant ($p=0.822$). Surgical resident's workload scores (16.1 ± 1.5) was higher than internal medicine (14.2 ± 2.6) ($p < 0.001$).

CONCLUSIONS:

Monotonousness, job stress and burnout can occur due to working conditions of residents'. Eventually they can start seeing patient as an object related to job and forget the patient is a human being with feelings. No matter what residency they work, residents have to be aware of empathy and its power.

Keywords: Assistant, Empathy, Related Factors

P-0967

Problem with care of the patients with special needs

Nevenka Strahinja Radosavljevic

Prim dr Nevenka Radosavljevic

Background & Aim

Overview of challenges and problems with care patients with special needs of cardio vascular diseases - A case report

Method

Through the specific case report

PATIENT M.L. birth 1949 born without abnormalities as a child of 7 months had chickenpox, as a complication got encephalitis that left permanent consequences.

His sister takes care of him and he is not placed in institutions.

He is feeding himself, but he is suspicious of an unknown person and then he becomes aggressive and agitated.

He had been treated from hypertension fully 20 years.

In December 2010 the doctor was invited on a home visit because patient had difficulty breathing, rapid, shallow breathing, coughing, had a stomach ache followed by general weakness and sweating.

FINDINGS: Pale, afraid and very sweaty.

PULMO; small respiratory noises, bilaterally weakened diffusely respiration

Cor: Cardiac function rhythmic, tone quieter, there is no noise

EKG: sinus rhythm, QS in V2- V5, abridged T in D1, biphasic in AVL, V2, V3 shallow negative in V 4-V6

DG AIM ANTEROLATERALIS

Oedema pulmonum

Retardatio Mentalis

And send to hospital for P.C.I.

The Patient needed hospitalization, but patient was very upset, not able to stay because there were no possibilities for the family members to stay with him.

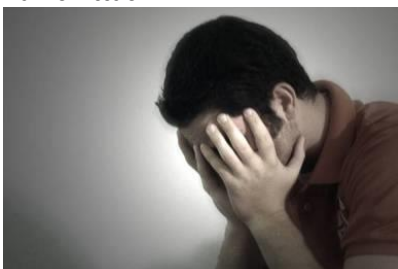
Institution has no conditions for treatment of patients with special needs so the patient was sent home with oral treatment – medication (Monizol, Aspirin, Plavix, Lasix, Ramipril, Amlopin) Patient is well-tolerated therapy in a home environment and his condition is stable with occasional medical control at home.

Conclusion

For treatment of patients with special needs it is necessary to prepare special part of the Cardiology Hospital department with a multidisciplinary approach Psychiatric and family members.

Keywords: nursing, patients with special needs

Panic Attack



Heart Attack



P-0968

Recording the reasons the immigrants attend the health center in a rural area of Crete

Theodoros Vasilopoulos¹, Georgia Arseni², Nikolaos Kontarakis¹, Ioannis Poulorinakis¹, Evangelia Giannopoulou¹, Aikaterini Chourdaki¹, Eirini Tsimplostefanaki¹

¹Health center of Ag.Barbara, Herakleio,Crete, Greece

²Venizeleio Gen. Hospital, Herakleio,Crete,Greece

BACKGROUND-AIM: According to the results of the population Census in 2011, the settlers in our country the year before, who had not greek nationality were 45.803 (57.6%),concerning mainly economic migrants.

The purpose of this study is to document the most common causes and symptoms with which foreign migrants present in primary health care in a rural area of Heraklion, Crete.

METHODS: The data was retrospectively drawn from the attendance records of the first quarter of 2014, where 95 foreign visits were recorded. Of these, 43 (45.26%) were male and 52 (54.74%) female. The nationalities were 46 (48.42%) Albanian, 29 (30.35%), Bulgarian, 11 (11.58%) Romanian, 7 (7.37%) Pakistani and two Indian.

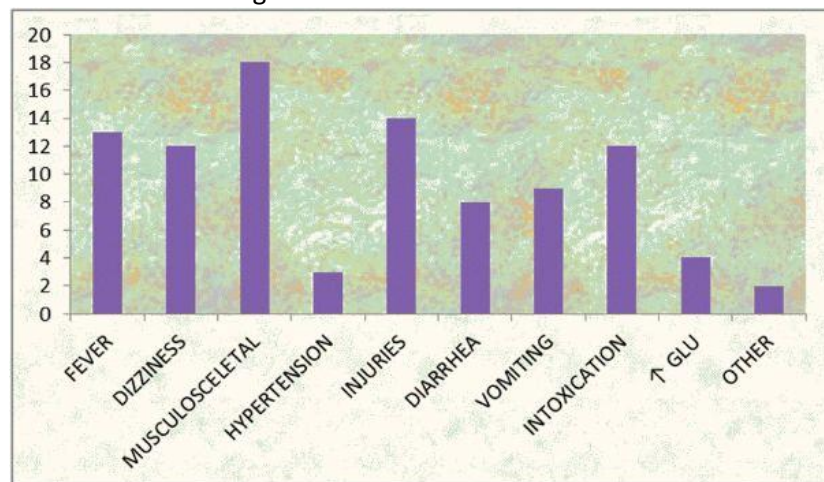
Concerning the age: 10 foreigners (1-10 y.o), 13 (11-20 y.o), 7 (21-30 y.o), 5 (31-40 y.o), 31 (41-50 y.o), 29 (51-60 y.o). Only 21 had personal health book. The rest (77.89%) either did not have health booklet or they used others' booklets, such as their employers, which questions the history of the disease and chronic medication of patients.

RESULTS: The results concerning the reasons of the immigrants attendance (Figure1)

CONCLUSIONS: The majority of immigrants (93.6%) are employed in agriculture and animal husbandry, accounting for musculoskeletal injuries and trauma. Symptoms such as dizziness and headache are justified by their long exposure to the weather, the nature of work itself (hard manual labor) and the irregular sometimes food and water habits (for example due to religious particularities). Special mention should be made about the living conditions, since their financial malaise deprives them from a good standard of living. Immigrants are considered a vulnerable population group. Therefore, it is necessary to record their profile and medical history, providing them with a more comprehensive medical approach on behalf of the general practitioners, in cooperation with other social and state structures, with respect to their cultural particularities.

Keywords: immigrants, primary health care, no insurance

Reasons of the immigrants attendance



P-0969

Adolescent pregnancy: a bump into culture or culturally accepted?

Joana Oliveira Baptista¹, Rute Nascimento Marques², Sara Conceição Cunha³

¹Health Unit Santa Joana, Aveiro, Portugal

²Health Unit S. Miguel, Vila Nova Gaia, Portugal

³Health Unit Oceanos, Matosinhos, Portugal

Background & AIM: Teen pregnancy is considered to be a health problem and it is known that adolescent parents and their children represent high-risk populations. Nowadays, physicians are increasingly confronted with patients from various ethnic backgrounds. In addition to language proficiency, cultural differences of minority groups play an important role in interethnic encounters, changing the definition of “normality” and expected behaviours. In contact with patients from different cultures, the physician’s reference cultural background is missing and differences in views can be magnified, leading to increased communication difficulties.

METHODS: A case report based on patient interview and electronic clinical records. A bibliographical research was conducted for clinical review.

RESULTS: Sixteen year old gypsy adolescent. Personal history of menarche at 11 years old, and married at 12. In October 2012, with 13 years of age, consults the family doctor for 3 months amenorrhea and a vaginal ultrasound revealed “single foetus with 10 weeks of evolution” - an unplanned pregnancy but desired by the couple. The second trimester obstetric ultrasound detected a congenital malformation of the foetus that led to a medical interruption of pregnancy.

In an attempt to prevent another unplanned pregnancy, it was proposed in a family planning consultation a subcutaneous implant that she refused due to the desire to be pregnant again.

In September 2013 she comes to a medical appointment with a twin pregnancy of 13 weeks of evolution. The twin female new-borns were born by eutocic delivery in February 2014.

CONCLUSION: Behaviours and attitudes towards pregnancy are highly influenced by culture. While maternal age tends to increase in most cultures, the gypsy culture supports teen pregnancy. Although physicians do perceive cultural differences they should try to adapt their communication accordingly. However it is hard to deal with all the challenges posed to doctors during the medical consultation.

Keywords: Ethnic Groups, Pregnancy in adolescence, Physician-Patient Relations, Cultural Diversity

Twelve Communication Barriers and Family Medicine Applications

Nurdan Kırımlıoğlu¹, İlhami Ünlüoğlu²

¹Eskisehir Osmangazi University Faculty of Medicine Dep of History of Medicine and Medical Ethics Eskisehir /Turkey

²Eskisehir Osmangazi University Faculty of Medicine Dep of of Family Medicine Eskisehir /Turkey

Family Medicine, one of the important requirements in the field of public health is important for physician-patient communication.

Physician-patient communication is a interaction process of both sides. Impressions gained during interviews in this process are the basis for important and clinical applications in terms of definition and solution of the problem. Therefore, verbal and nonverbal communication environments where patient can make case must be created entirely.

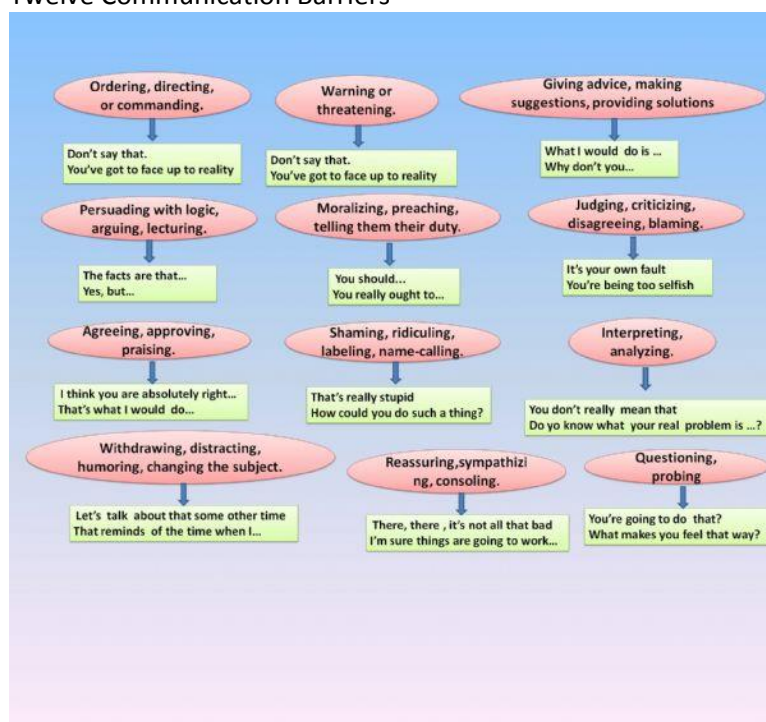
It is known that clear and effective communication cannot take place between the doctor and patient and that there are some problems. Communication action may not always be in the format as desired by the doctor. The expectations or thoughts on communication with their doctor of patients having different ideas about how they would be affected by health problems may also vary. A part of communication problems in doctor-patient or patient-other health care professional relationship can be said as resulting from the language of patient and doctor, and different use of language.

The language barriers influencing negatively the effective participation of patients in communication with doctors and other health care professionals and defined as "twelve communication barriers" in the literature and their reflection on family medicine practice will be presented in this study.

The communication between the patient and the family physician should be strong and free of obstacles in order to protect and develop the health in first step health care services and to present the intended holistic approach. Problems which possible to arise when the Patient and physician-induced barriers are supported by a empathic approach including many communication skills such as speaking, using the body language, listening will be minimized.

Keywords: Communication, Family Medicine, Ethics

Twelve Communication Barriers



P-0971

Spirometric Measurements on World COPD Day

Özlem Şengören Dikiş¹, Seyhan Us Dülger¹, Hakan Demirci²

¹Department of Pulmonary Medicine, Sevket Yilmaz Training and Research Hospital, Bursa, Turkey

²Department of Family Medicine, Sevket Yilmaz Training and Research Hospital, Bursa, Turkey

AIM: We organized a 'World Chronic Obstructive Pulmonary Disease (COPD) Day' event to raise awareness in society of the disease and we evaluated the results of the activity.

MATERIALS-METHODS: Volunteers (n = 79) consisted of persons shopping in a famous shopping center in Bursa. A short past history of COPD from the volunteers was requested. Pulmonary Function Tests were performed by spirometry and a Fagerstrom test for dependence was filled out by the volunteers. In cases where airway obstruction was detected, physicians performed a reversibility test with the patients.

RESULTS: Of the 79 volunteers who participated in the study, 39 cases were detected to have airway obstruction. Of these, 15 patients had been previously diagnosed as having COPD but 24 patients were diagnosed with COPD for the first time. There was no newly diagnosed COPD patient among nonsmokers. The prevalence of COPD was 49.36% and the awareness rate was only 38.46%.

CONCLUSIONS: In the present study, we determined the COPD prevalence to be 49.36%, which is quite high compared to previous studies published in Turkey. In such a cross sectional study, volunteers would probably be composed of persons who would have the disease at higher rates. We observed that there was a low awareness of COPD among smokers. Events aiming to increase social awareness to such a particularly prevalent disease should be encouraged.

Keywords: COPD, awareness, smoking, reversibility

P-0972

Do we count sheep properly? A study on insomnia at a Primary Health Center

Maria Jose Agueros Fernandez¹, Patricia Noemi Aguilera Samaniego², Alvaro Perez Martin², Montserrat Gago Bustamante², Jose Ramon Lopez Lanza², Victor Ovejero Gomez⁴, Alfredo Avellaneda Fernandez³, Cecilia Traspuesto Pascual², Isabel Muñoz Franco², Maria Antonia Gandara Revuelta¹, Begoña Bermejo Garcia¹, Antonio Alonso Gonzalez²

¹Primary Health Center Zapaton. Torrelavega. Spain

²Primary Health Center Centro. Santander. Spain

³Primary Health Center Los Carmenes. Madrid. Spain

⁴Sierrallana Hospital. Torrelavega. Spain

Background & AIM: To study the characteristics of the treatment of insomnia carried out in an urban Primary Health Center.

METHOD: A transversal descriptive study of all the cases of insomnia in an urban medical centre in Santander, with a population of 19,540 inhabitants, over 2013. For quantitative variables, the study used the average and the typical deviation (in the case of normal distribution). For qualitative variables, percentages are used.

RESULTS: 161 subjects were studied. The average age was 64.34 years old (SD±17.48), predominantly female (70.4%). 97.5% received pharmacological treatment after the first consultation, mainly zolpidem (36.2%), lorazepam (22.2%), lormetazepam (16.9%), brotizolam (7.7%), bromazepam (3.9%), ketazolam (3.4%), trazodone (2.9%). The treatment was considered to be effective in 75.2% of the cases, and in 2.5% of the cases, side effects were observed, meaning the drug was withdrawn. The information sheet on advice on insomnia was given to 8% of the cases.

CONCLUSIONS: The typical profile is that of a woman of around 65 years of age. This problem often results in the prescribing of medicines, however, the information sheet, which could be useful, was given out to only a few. Zolpidem and lorazepam are the most prescribed active ingredients. There are very few side effects which mean the drug has to be withdrawn

Keywords: Insomnia, Primary Health Center, Drug

P-0973

Screening test for prevention of osteoporosis

Enisa Ramic¹, Esad Alibasic², Amila Bajraktarevic¹, Enisa Karic¹, Olivera Batic Mujanovic¹, Izudin Zahirovic³

¹Primary Health Care Center Tuzla

²Primary Health Care Center kalesija

³Primary Health Care Center Srebrenik

INTRODUCTION: Loss of bone mass occurs slowly and quietly, often with no symptoms until the first fracture. Osteoporosis is a systemic skeletal disease, characterized by low bone mass and structural deterioration of bone tissue, which increases the brittleness of the bones, which leads to an increased likelihood of fractures of the hip, spine and forearm.

OBJECTIVE: To present percentage of osteopenia and osteoporosis in people who are treated in the outpatient clinic Simin Han.

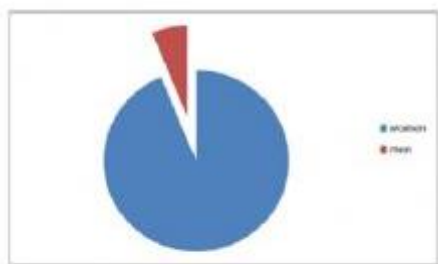
METHOD: Bone density screening by ultrasound measurement of the heel bone of respondents who live in the suburb area. The result of the T-score up to -1 is interpreted as normal value, the T-score between -1 and -2.5 as osteopenia and T-score above -2.5 as osteoporosis.

RESULTS: Total of 128 persons aged over twenty-five were in the scope of screening test. Out of the total number, there were 120 (93.5%) women and eight (6.5%) men. The average age of patients was 56. Total of 26 patients (20.31%) had normal finding (T - value up to -1). 66 (51.56%) patients had Osteopenia and T-score between -1 and -2.5. Osteoporosis and T-value equal to -2.5 or below was found in 36 (28.12%) persons, in 2 (1.56%) male and 34 (26.56%) female patients.

CONCLUSION: Obtained results show us that we have to start the prevention of osteoporosis as early as possible. In the treatment of osteoporosis, primary and most rational therapeutic principle is its prevention, ie. stopping the loss of bone mass and preventing the occurrence of any undesired complications or fractures. Proper nutrition is the most important in every stage of prevention and treatment of osteoporosis. This primarily refers to the consumption of calcium and vitamin D. It is also necessary to advocate the increase of level of physical activity at all ages.

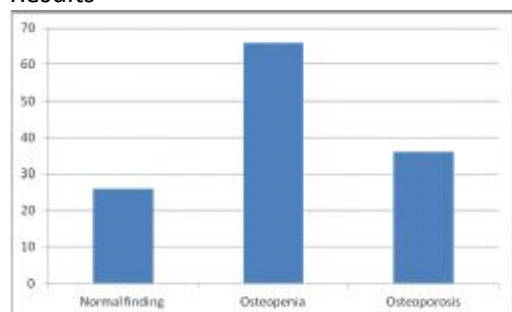
Keywords: osteopenia, osteoporosis, screening test, prevention

women&men



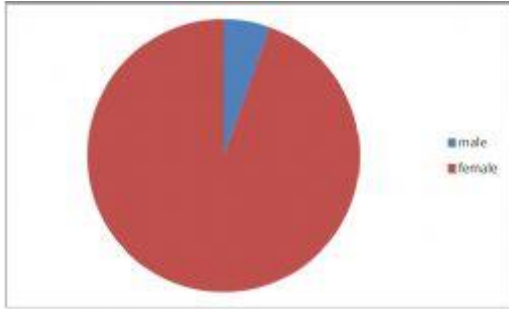
128 persons aged over twenty-five were in the scope of screening test. Out 93.5% women and 6.5% men. The average age of patients was 56.

Results



Normal finding T - value up to -1 Osteopenia and T-score between -1 and -2.5. Osteoporosis and T-value equal to -2.5 or below

Osteoporosis



Osteoporosis 1.56% male and 26.56% female patients.

P-0974

The sexual dysfunction among the patients with colostomy and its relation with self-esteem

Onur Öztürk¹, Bektas Murat Yalçın², Mustafa Ünal², Kadir Yıldırım³, Nuraydın Özlem³

¹Atakum Community Health Center, Samsun, Turkey

²Department of Family Practice, Ondokuz Mayıs University Medical Faculty, Samsun, Turkey

³Department of General Surgery, Samsun Education and Research Hospital, Samsun, Turkey

OBJECTIVE: In this study, the sexual problems which might be faced in patients of different genders with temporary or permanent colostomy and the relationship between these problems and self-esteem.

MATERIALS-METHOD: 42 participants with temporary and permanent colostomy (study group) in Samsun Education and Research Hospital and 42 participants working as auxiliary staff in the same hospital (control group) were included in the study. All participants were applied a questionnaire containing the socio-demographical qualities, Rosenberg Self-Esteem Scale, female participants were given The Female Sexual Function Index and male participants were given The International Index of Erectile Function by sealed envelope method. After a week the data collected from the questionnaires were evaluated among groups.

FINDINGS: In the study group, 17 of 42 cases (40%) had permanent and 25 had temporary colostomy. Self-esteem of the cases in study group were lower ($1,01 \pm 1,13$) than the control group ($0,5 \pm 0,44$) ($p=0,021$). There was a meaningful relationship between the IIEF score of male patients and self-esteem scale ($r=0,123$, $p=0,013$). In the study group, male cases ($45,00 \pm 23,71$ points) had lower scores ($59,0 \pm 21,31$ points) than the control group in IIEF test ($p=0,026$). Females with colostomy had a significantly lower score than the control group only in "arousal" sub group ($p=0,045$). Males with colostomy has a higher score than the permanent group in IIEF score and all sub groups and females had higher scores in the arousal, satisfaction and pain sub scales.

CONCLUSION: Cases with permanent colostomy have more serious sexual problems than those with temporary colostomy. More detailed studies are needed on sexual problems faced by patients with colostomy.

Keywords: Colostomy, Sexual dysfunction, Permanent stoma, Temporary stoma, Self-Esteem

Table-1

Sociodemographical Variables	Study group	Control group	P values
sex			0,827
Female	20	21	
Male	22	21	
Age			0,001 (F =11,007)
18-24	0	4	
25-44	19	29	

45-64	19	7	
>64	4	2	
Marital Status			0,786
Married	33	34	
Single	1	8	
Widow	8	0	
Education level			0,002
≤ 8 years	27	12	
> 8 years	15	30	
Occupation			0,049
Working	15	25	
Not Working	27	17	

Sociodemographical qualities of cases attending the study

Table-2

Scales	Permanent	Temporary	P Value
IIEF# Score	5.0 ± 18.60	58.0 ± 17.38	0,001
IIEF Erectile func.	2.0± 7.95	26.0 ± 8.70	0,001
IIEF Orgasmic func.	0.0 ± 3.28	8.0 ± 3.25	0,002
IIEF Sexual desire	1.0± 2.18	7.0 ± 2.06	0,003
IIEF Sexual satisfaction	0.0 ± 5.11	11.0 ± 3.30	0,004
IIEF General content	2.0± 2.23	8.0 ± 2.78	0,006
FSFI‡ score	3.6 ± 5.30	16.1 ± 9.86	0,075
FSFI Sexual desire	1.2 ± 1.11	2.4 ± 1.09	0,084
FSFI arousal	0.60 ± 0.68	2.25 ± 1.47	0,020
FSFI lubrication	0.15± 1.52	2.70 ± 1.93	0,097
FSFI orgasm	0.00 ± 0.97	2.20 ± 1.85	0,066
FSFI Sexual satisfaction	0.00 ± 1.27	2.80 ± 1.91	0,042
FSFI pain	0.00± 1.53	3.60 ± 2.18	0,038
RSE† total	1.74 ± 1.24	0.5 ± 0.94	0,044

Comparing scale scores among permanent and temporary colostomy groups

P-0975

Mood And Behavioral Changes Associated With Montelukast Usage In Pediatric Cases

Banu Gulcan Öksüz¹, Mahir İğde¹, Onur Öztürk²

¹Department of Pediatrics, Samsun Education and Research Hospital, Samsun, Turkey

²Atakum community health center, Samsun, TURKEY

AIM: As leukotriene antagonists are known to be safe in pediatric cases, their side effects should be considered. The purpose of this study is to evaluate the mood and behavioral changes arised with montelukast treatment in pediatric cases.

Patients and METHODS: A retrospective study was enrolled with the records of totally 172 patients, 97 of whom were considered as the study group and had the diagnoses of allergic diseases like asthma, allergic rhinitis, etc. and were given montelukast treatments, 75 of whom were considered as the control group and had the diagnoses of allergic and non allergic diseases and were not given montelukast treatments. All patients' demographical datas, mood and behavioral situations of the all allergic and non allergic patients at the beginning of the study, mood and behavioral changes in the allergic study group patients before montelukast treatments (group A), during montelukast treatments (group B) and after montelukast treatments (group C) were evaluated. RESULTS: Mean of age was 6.11 in the study, 8.12 in the control group (p=0.798). All of the asthmatic patients and all of the non asthmatic patients did not differ from each other in mood and behavioral disorders existed at the beginning of the study (p>0.05). Sleep disturbance (p=0.021), irritation (p=0.000), aggressiveness (p=0.004) and hallucination (p=0.031) were observed more in group B when compared with the patients in group A. Mood and behavioral changes seen in group C did not differ from group A (p>0.05).

CONCLUSIONS: Patients who are mentally stable before montelukast treatments may have some disturbances in mood and behaviors during treatments so attention should be paid for such reactions. Clinicians should suspect if the patient has unexpected reactions after montelukast. And further studies are needed to evaluate these datas.

Keywords: Asthma, Hallucination, Montelukast, Pediatric

Table-1

	Group A		Group B		p value
	n	%	n	%	
Sleep disturbance	10	10.3	18	18.6	0.021
Sleep abnormality	3	3.1	9	9.3	0.070
Sleepwalking	1	1	2	2.1	1
Irritation	16	16.5	31	32	0.000
Anxiety	14	14.4	19	19.6	0.125
Hallucination	1	1	7	7.2	0.031
Aggressiveness	21	21.6	33	34	0.004
Thought disorders	1	1	1	1	1

Comparison of mood and behavioral changes observed in group A and group B in the study group

P-0976

A study of the referrals made from Primary Medical Care to Dermatology. Is there agreement in the diagnosis?

Maria Jose Agueros Fernandez¹, Mirna Lizzeth Centeno Cabrera¹, Carlos Fernandez Galanche¹, Alvaro Perez Martin², Jose Ramon Lopez Lanza³, Patricia Noemi Aguilera Samaniego¹, Montserrat Gago Bustamante⁴, Cecilia Traspuesto Pascual², Isabel Muñoz Franco², Maria Antonia Gandara Revuelta¹, Maria Angeles Pereda Garcia¹, Luis Rioja Zarrabeitia⁵

¹Primary Health Center Zapaton. Torrelavega. Spain

²Primary Health Center Centro. Santander. Spain

³Primary Health Center Alisal. Santander. Spain

⁴Primary Health Center Los Carmenes. Madrid.

⁵Primary Health Gerencia. Santander

Background & AIM: To study the level of diagnosis agreement and clinical actions taken with regards to referrals to Dermatology from Primary Medical Care.

METHOD: Analysis of all the patients referred to Dermatology from an urban primary medical centre, over the period January – June 2013, comparing clinical actions, completion of the referral note and diagnosis made at each level.

RESULTS: 354 subjects were referred, with an average age of 43.97 (SD 25.4), and predominantly female. The main motives were dermatitis, (12.1%), skin lesions (11.3%), melanocytic naevi (8.2%). The average time for referral was 51.03 days, 11.6% being referred at the time of the first consultation. 1.7% had some sort of diagnostic test (100% blood test), and 25.4% were prescribed a treatment before attending the specialist consultation (topical corticoides 33.3%). Once in Dermatology, 8.2% had some kind of test (82.8% biopsy), 33.6% were treated (removal 29.4 %). With regards to the completion of the referral note, at primary care level, it was correctly completed in 61.3% of the cases, and the response was noted in the medical records in 29.9% of cases (there was no report in 55.4% of cases). The Kappa index of diagnosis agreement between levels was 0.13, which is considered low.

CONCLUSIONS: There is a low level of diagnosis agreement between levels, which supposes there is little knowledge of the pathologies, although there is also a lack of documented response. The poor description of the pathology on the referral note is noticeable, as is the lack of later entering the response onto the medical records. There are few immediate referrals and use of diagnostic tests and treatments at primary medical care level. Strategies should be found to improve the registering of the information at both levels.

Keywords: Dermatology, concordance, primary health

P-0977

Ultrasound Guided-Fine Needle Aspiration Biopsy of Thyroid Nodules: 18 Months Retrospective Review of One Center Experience

Gülşah Elbüken¹, Bahadır Yazıcıoğlu², Onur Ozturk³, Recep Aktimur⁴, Ömer Alıcı⁵, Aysu Başak Özbacı⁶, Nilüfer Bıçakçı⁷, Mehmet Derya Demirag⁸

¹Department of Endocrinology and Metabolism, Samsun Training and Research Hospital, Samsun, Turkey

²Department of Family Medicine, Ondokuz Mayıs University Medical Faculty, Samsun, Turkey

³Department of Family Medicine, Atakum Community Health Center, Samsun, Turkey

⁴Department of General Surgery, Samsun Training and Research Hospital, Samsun, Turkey

⁵Department of Pathology, Samsun Training and Research Hospital, Samsun, Turkey

⁶Department of Radiology, Samsun Training and Research Hospital, Samsun, Turkey

⁷Department of Nuclear Medicine, Samsun Training and Research Hospital, Samsun, Turkey

⁸Department of Internal Medicine, Samsun Training and Research Hospital, Samsun, Turkey

The objective of this study is to elucidate the use of ultrasonography guided fine-needle aspiration biopsies (UG-FNAB) in the evaluation of thyroid nodules. The study population consisted of 790 UG-FNAB in 719 patients whom were admitted to the our endocrinology clinic. The cytological results were classified as benign, follicular lesion or suspicious for malignancy,

malignant and non-diagnostic. The results of 790 UG-FNAB of 719 patients were as follows: 567 (71.77%) benign, 97 (12.28%) non-diagnostic cytology, 43 (5.44%) atypia with undetermined significance, 81 (10.25%) follicular lesion or suspicious for malignancy, 2 (0.25%) malignant. In our study, thyroid carcinoma rate was found to be lower than current literature. Of the malignant nodules which were reported as papillary thyroid carcinoma by UGFNAB cytology, both were female, euthyroid and have single nodule in their thyroid gland. One of the patient (39 years old) had a micro nodule (< 1 cm in diameter) that it had an isoechoic pattern with regular margin on thyroid ultrasonography; whereas the other one (79 years old) had macro nodule (>1 cm diameter) that it had, hypoechoic pattern with irregular margin. None of them have calcifications in their nodules. Multidisciplinary approach including endocrinologists, radiologists and pathologists is essential for the management of patients with thyroid nodules to avoid misestimation of the risk of thyroid cancer.

Keywords: Thyroid nodules, ultrasound, fine needle aspiration biopsy, histopathology

P-0978

The Role of Drinking Alcohol, Coffee and Tea Habits in Smoking Cessation Success

Izzet Fidancı, Ismail Arslan, Oğuz Tekin, Enes Gümüş, Şükrü Ümit Eren, Mustafa Ülkü Uçkan
Department of Family Medicine, Ankara Training and Research Hospital, Ankara, Turkey

INTRODUCTION: The smoking cessation are one element of the biopsychosocial approach to family medicine. We aimed to evaluate the role of drinking alcohol, coffee and tea habits in smoking cessation success.

MATERIALS-METHODS: In our study, we applied a questionnaire and Fagerström Test for Nicotine Dependence to 128 participants consulting Family Medicine Smoking Cessation Outpatient Clinic of Ankara Training and Research Hospital. Among participants, 67 of them were people quitted smoking while the other 61 did not. With questionnaire, we investigated factors possibly affecting smoking cessation success like drinking alcohol, coffee and tea habits and also marital status and occupations of participants. By adding Fagerström Test for Nicotine Dependence to questionnaire we defined the dependence status of participants.

RESULTS: Study comprised of 128 participants, 50 of them being female and 78 being male. Mean age of participants was 34.01 (± 12.24) in patients quitted smoking and 32.82 (± 13.45) in patients still smoking. Tea and alcohol drinking habits were found to be higher in smoking group and difference was statistically significant ($p < 0,05$). When examining smoking cessation success according to occupational groups, civil servants and unemployed people were more successful than other occupational groups, but there was no statistically significant difference. People having coffee drinking habits quitted smoking in a significantly higher rate ($p < 0,05$). Among given treatments, although statistically insignificant, the most effective one was varenicline.

CONCLUSION: According to our results, smoking cessation success is lower among people having tea and alcohol drinking habits. In smokers, we should investigate the relationship with additional substance usage and aim to decrease these additional substance usage habits for increasing smoking cessation success.

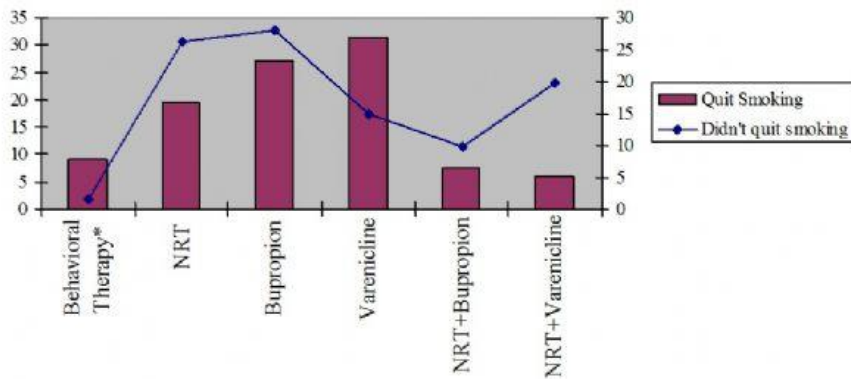
Keywords: Smoking cessation, Tea, Coffee, Alcohol Drinking

Table-1. Comparison of factors affecting smoking cessation success.

	Quit Smoking n(%)	Didn't Quit Smoking n(%)	n	p
Gender				
Men	40(51,3)	38(48,7)	78	0,764
Women	27(54,0)	23(46,0)	50	
Marital Status				
Single	29(45,3)	35(54,7)	64	0,111
Married	38(59,6)	26(40,6)	64	
Tea				
Present	53(48,6)	56(51,4)	109	0,044*
Not present	14(73,7)	5(26,3)	19	
Coffee				
Present	47(47,0)	53(53,0)	100	0,022*
Not present	20(71,4)	8(28,6)	28	
Alcohol				
Present	15(31,2)	33(68,8)	48	<0,000**
Not present	52(65,0)	28(35,0)	80	
Daily Cigarette No				
<20	11(44,0)	14(56,0)	25	0,352
≥20	56(54,4)	47(45,6)	103	
Fear of Gaining Weight				
Present	13(39,4)	20(60,6)	33	0,084
Not present	54(56,8)	41(43,2)	95	
Total	67	61	128	

*Significant **Very significant

Figure-1. Percentages of the therapy methods applied to patients.



NRT: Nicotine replacement therapy * The group who were applied behavioral therapy only

P-0979

Are guides to diabetes good for anything other than gathering dust?

Maria Jose Agueros Fernandez¹, Alvaro Perez Martin², Jose Ramon Lopez Lanza³, Montserrat Gago Bustamante¹, Patricia Noemi Aguilera Samaniego², Maria Angeles Pereda Garcia¹, Javier San Juan Minchero², Cecilia Traspuesto Pascual², Isabel Muñoz Franco², Maria Antonia Gandara Revuelta¹, Antonio Alonso Gonzalez², Maria Teresa Garcia Gutierrez²

¹Primary Health Center Zapaton. Torrelavega. Spain

²Primary Health Center Centro. Santander. Spain

³Primary Health Center Alisal. Santander. Spain

Background & AIMS: The analysis of the characteristics of diabetic patients, the degree to which recommendations appearing in guides are followed, and the attitude of the doctors towards these.

METHOD: A descriptive transversal study of diabetic patients attended to in one urban primary health center. To calculate the correct control, the values recommended by the ADA 2015 were used (blood pressure (BP) <140mmHg and <90 mmHg, LDL <100mg/dl). To assess renal failure, a <60 filtration rate was used. The average was used for quantitative values and percentages were used for qualitative variables..

RESULTS: 60 subjects were selected (96.7% type 2 diabetes), with an average age of 70.48 (SD ± 12.8) and mainly male (50.8%). The average values encountered were HbA1c 7.4(DE1.72) %, glycemia 146.8 (SD 62.1), LDL 100.54 (SD 30.9) mm/dl, systolic blood pressure (SBP) 142.52 (SD 17.08) mmHg and diastolic blood pressure (DBP) 75.83 (DE 9.9) mmHg. 16.4% fulfilled the BP control figures, 59% the LDL control figures, 20.3% presented renal failure. With regards to treatment, 41.3% used monotherapy for high blood pressure, mainly diuretics (51.7%). Of those who did not fulfill the medical objectives, the doctor did not carry out further treatment in 85.7% of those with high BP (change of pharmaceutical medicine in 82.9% of cases, increased dosage in 14.5%) and in 93.1% in the cases of high LDL (adding a hypolipidemic drug in 78.4% of cases).

CONCLUSIONS: The degree of control of risk factors (hypertension and cholesterol) in diabetic patients is very deficient, as it does not fulfill the recommendations given by the main guides. There is a great deal of therapeutic inertia among the doctors, which means that treatment to lower cardiovascular risk should be reviewed and intensified.

Keywords: Diabetes mellitus, risk factor, Primary Health center

P-0980

Delivery Preferences of Women and Influencing Factors

Gülsüm Özçelik¹, Merve Gülbahar¹, Emine Karahan¹, Ziya Mirzaev¹, Nahida Velihanova¹, Abdulkadir Kaya²

¹Ataturk University Medical Faculty

²Ataturk University Medical Faculty Department of Family Medicine

AIM: In this study, we aimed to investigate preferences of women in routes of delivery and influencing factors.

METHOD: This study was performed at Atatürk University Hospital during September 2013. Fifty concomitant pregnant women applying for delivery were included in the study. A questionnaire with 16 questions querying the delivery preferences of women was applied to all participants. Results were analyzed using the SPSS software.

RESULTS: Almost all participants were married (n=48, %96). Mean age was 36.7 ± 7.1 years. Mean number of children was 2.7 ± 1.2. Mean age at first delivery was 22.2 ± 3.6. Fifty eight percent (n=29) of the participants delivered their first baby with cesarean section. 23 of the deliveries (46%) were by normal vaginal route while 27 (54%) were via cesarean section. Mothers preferring cesarean section mentioned their own health and baby's health as the first most common reasons (each n=9; 33.3%). Other reasons mentioned were indication given by the doctor (n=7; 25.9%), being afraid of normal delivery (n=1; 3.7%), and the comfort of cesarean section (n=1; 3.7%).

DISCUSSION: This showed that the most important reason of women preferring cesarean section is their concerns regarding the own and baby's health. We concluded that the high proportion of cesarean deliveries may be due to the sample coming from a tertiary hospital. The fact that women have a misconception that cesarean delivery

will be good for their own health and baby's health raises the importance of educating and informing pregnant women for the benefits/risks of delivery types.

Keywords: Delivery preferences of women, Cesarean section, Normal delivery

P-0981

Medical Specialization Exams Between 2007 and 2013: A Trend Analysis

Abdulkadir Kaya, Zekeriya Aktürk, Yasemin Çayır, Kenan Taştan
Ataturk University Medical Faculty Department of Family Medicine
Background and design

Since 1987 Turkish medical doctors have to enter the specialization exam, TUS which is done twice a year in order to be placed to a residency training program. There is a recent change in the preferences of residency candidates with probable effects of factors such as the Health Transformation Project, full-time employment act (#5947), and increased numbers of malpractice lawsuits.

The aim of this study was to investigate TUS quota and scores between the years 2007 and 2013 and analyze changes in the trends with regard to specialty preferences.

Materials and methods

Data for the 13 TUS exams between April 2007 and April 2013 were analyzed by downloading relevant booklets from the web page of the examining organization Center for Measurement, Selection, and Placement (<http://www.osym.gov.tr/>). The main outcome measure was mean minimum scores of the TUS exam. Statistical analysis was done with the SPSS 18.0 software.

Results

While there was an increase in the mean scores for Medical Biochemistry and Medical Microbiology, there was a drop in the scores for Gynecology and Obstetrics, General Surgery, and Pediatrics residencies. Mean scores for residency programs of the Ministry of Health were 62.3 ± 2.6 compared with 61.8 ± 2.0 for residency programs run by universities, without any statistically significant difference ($t=1,18$; $p=0,241$).

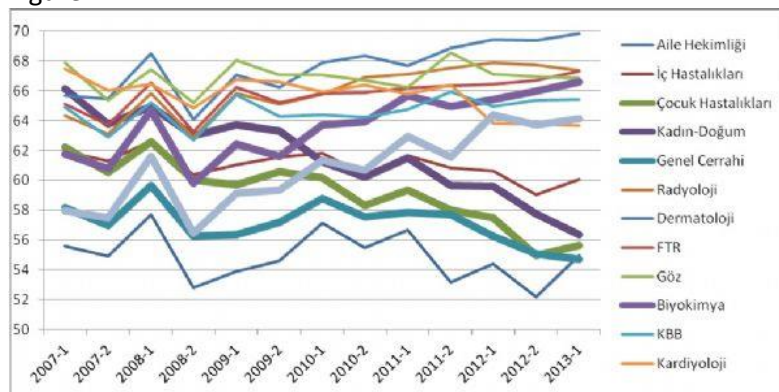
Surgical disciplines being more prominent, there was a drop in the scores in disciplines with inpatient services compared to those without inpatient service. This difference was statistically significant in the year 2007 ($F=4.691$; $p=0.02$) but became non-significant thereafter ($p>0,05$).

Conclusion

The trend in residency preferences of medical doctors in Turkey is changing. This trend should be taken into consideration when planning quota for residency positions in order to prevent imbalances in the specialist doctor workforces.

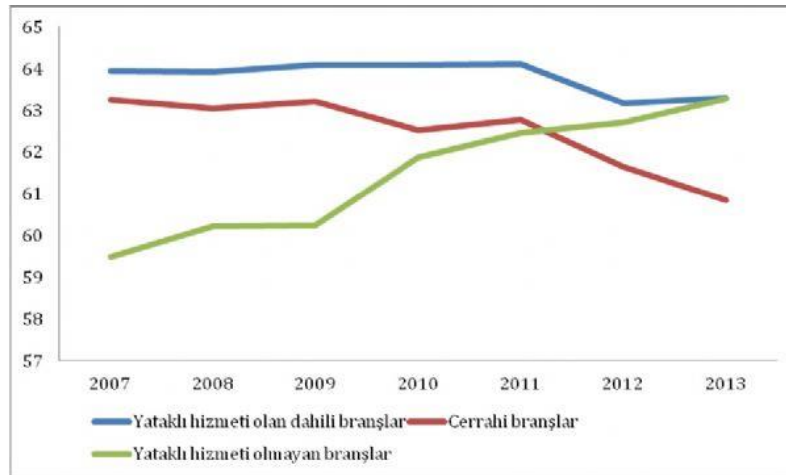
Keywords: Medical Specialization Examination, doctor workforce need, specialization in medicine

Figure 1



TUS points changes in the base year of the investigated branches.

Figure 2



TUS points changes in the base year according to Branch type

P-0982

Effect of peganum harmala L. on Lipid metabolism and changes Cyp7a1 Enzyme in Male Wistar Rat

Ali Mohammad Eini¹, Majid Moharrami Fard², Mehdi Ahmadi Far³

¹Ali Mohammad Eini

²Majid Moharrami fard

³Mehdi Ahmadi far

AIMS:

Concentration of cholesterol and other lipids in human diet has been considered as an issue of public health. In the present study the Effects of peganum harmala (P. harmala) on lipid metabolism were investigated in a 28-days feeding trial.

METHODS:

Total of 64 rats (200 ± 15) were divided into six groups: (G1) control, (G2) control plus 100mg/kg, (G3) control plus 200mg/kg, (G4) control plus 400mg/kg., experimental was 8 weeks period. the blood and liver tissue samples for serum lipid profile were collected and Cyp7a1 Enzyme determined.

RESULTS:

Plasma glucose was changed by dietary treatments. Peganum harmala (P. Harmala) decreased low density lipoprotein LDL in (200,400) mg/kg of the Extract groups and increased high density lipoprotein cholesterol in (100) mg/kg of the Extract groups significant difference ($P < 0.05$), but decreased plasma triglycerides only in 100 mg/kg of the diet group.

The results show that with increasing extract dose, CYP7A1 gene expression is increased significant difference ($P < 0.05$)

Conclusions

It is concluded that methanolic extract of P. harmala could be effectively used in rat to optimize serum lipid profile. These results demonstrate that P. harmala increases the effect of excretion cholesterol and Cyp7a1 enzyme.

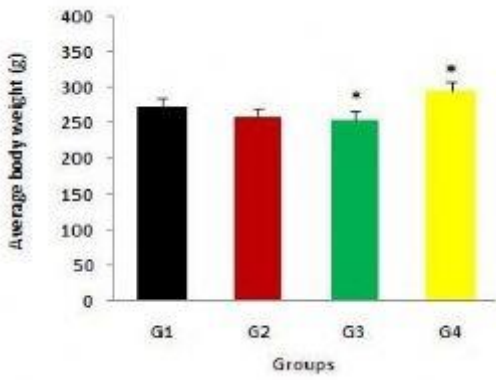
Keywords: Peganum harmala L, Lipid metabolism, cholesterol, lipoprotein, Cyp7a1 enzyme



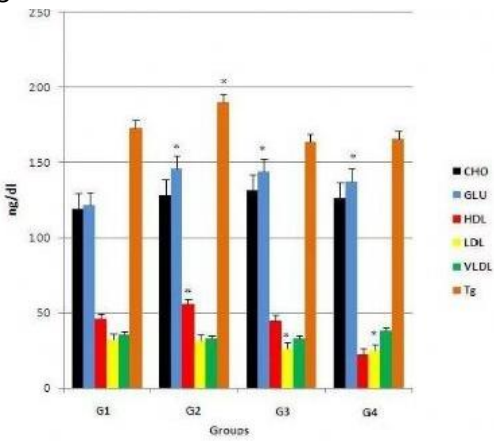
1



2



3



4

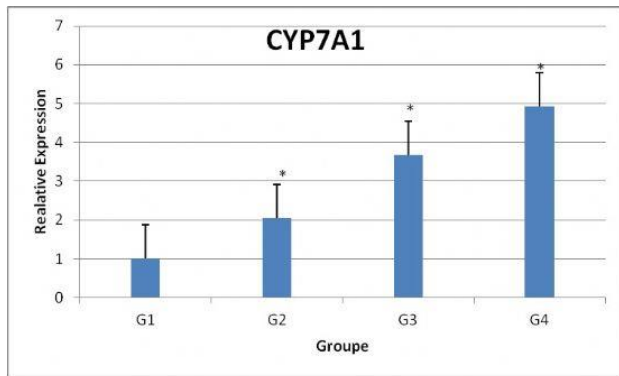


Table1.effect of P.harmala on hypercholesteromia and control rat

Parameter/group	control	Control plus 100mg/kg	Control plus 200mg/kg	Control plus 400mg/kg
Plasma triglyciride	173±17	190±13	164±16a	165.5±8
Plasma glucose	121±14	146±19	144±8	137±2
Plasma cholesterol	119±35	128±13	131±6	126±5
VLDL cholesterol	35.75±4	33±6	33±3	38.37±2
HDL cholesterol	46±3	55±6	45±2	22±5
LDL cholesterol	32.25±2	31.62±2	26.12±6	25.12±2
Body weight after 8weeks(g)	272±8	258±6	253±14a	296±7

P-0983

The Associations of 'Fatness', 'Fitness' and Physical Activity With All-Cause Mortality in the Elderly: A Systematic Review Of Observational Studies

Dharani Yerrakalva, Ricky Mullis, Jonathan Mant

Cambridge University

BACKGROUND: In older adults, unlike the general adult population, increasing adiposity is associated with better health outcomes. This is the so-called 'obesity paradox'.

AIM: This review sought to explore whether the obesity paradox in older adults might be explained by confounding or effect modification by cardiorespiratory fitness or physical activity.

METHODS: Systematic searches were carried out to identify observational studies that examined the association of adiposity markers (body mass index, waist circumference and waist-hip ratio) with all-cause mortality in older adults (aged ≥ 60) and took into account cardiorespiratory fitness or physical activity. Studies were eligible if they included at least one adiposity measure, and reported all-cause mortality that was either adjusted or stratified for either cardiorespiratory fitness or physical activity measures. Data from each included study was analysed to produce a graphical representation of the relationship of adiposity markers with all-cause mortality.

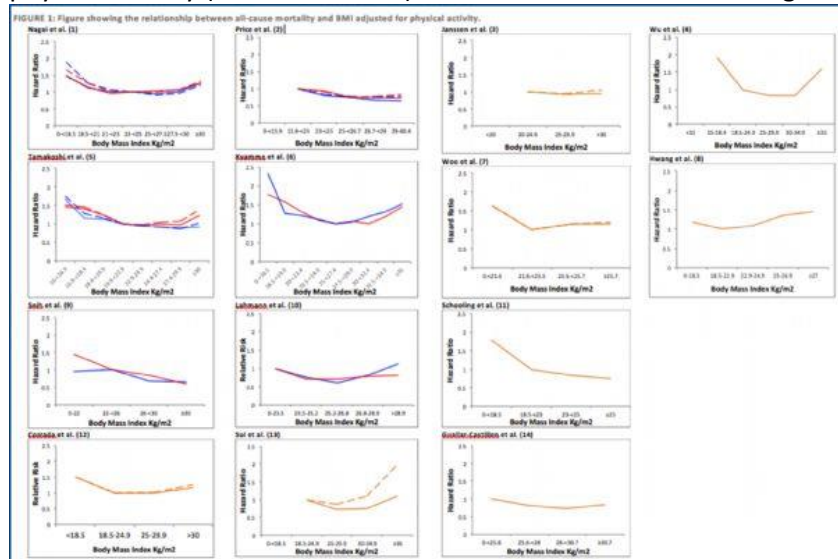
RESULTS: 15 observational studies were identified. 14 of these studies found that increasing BMI had a non-positive association with all-cause mortality, with persistence of the obesity paradox despite adjustment for physical activity or cardiorespiratory fitness. Two studies found that low fitness was associated with mortality risk regardless of BMI while fit and overweight individuals had similar mortality risk as their normal weight counterparts. Few studies utilised central adiposity measures and no consistent pattern emerged with regard to their association with all-cause mortality.

CONCLUSIONS: The limited available evidence suggests that physical activity or cardiorespiratory fitness are not confounding the relationship between adiposity markers and mortality, but cardiorespiratory fitness may be acting as an effect modifier. The risk of death associated with being overweight or obese may differ depending on fitness but this is based on only two studies which used stratification as opposed to post-hoc adjustment. More

work is needed in this area.

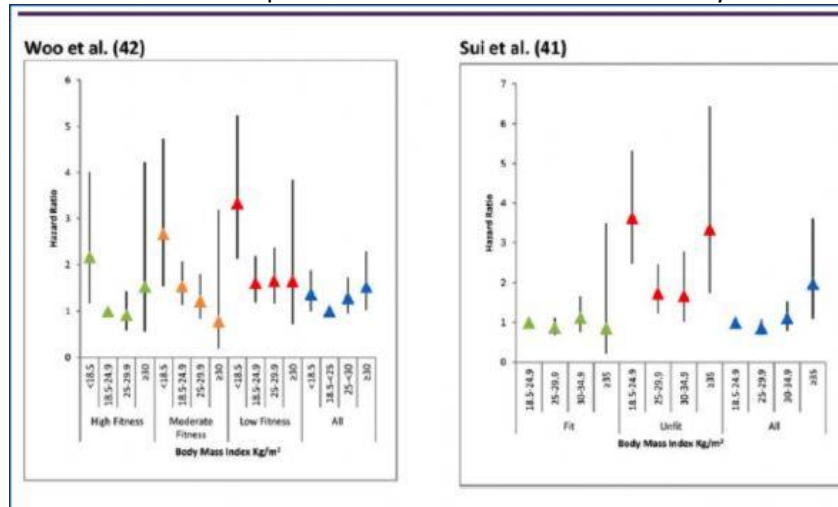
Keywords: Obesity, Fitness, Physical Activity, Mortality, Elderly

FIGURE 1: Relationship between BMI and all-cause mortality after adjustment for cardiorespiratory fitness or physical activity (all other studies) for included studies with enough extractable data.



Relationship lines in orange denote both sexes, in red denote females, and in blue denote males. Dashed relationship lines denote pre-adjustment, and solid lines denote post-adjustment. Some studies did not provide combined sex data or pre-adjustment data.

FIGURE 2: Relationship between BMI and all-cause mortality with stratification for fitness.



. This figure is a graphical representation of the findings of the only two studies that stratified for cardiorespiratory fitness. The first graph shows data from Sui et al. (13) cohort from the Aerobics center Longitudinal Study. Hazard ratios for fit groups are in green and unfit groups in red with vertical lines representing 95% confidence intervals. The second graph is data from Woo et al. (7), a Hong Kong community cohort using 6 metre walking speed as a cardiorespiratory fitness surrogate measure. Hazard ratios for high fitness groups are in green, moderate fitness in yellow, and low fitness in red with vertical lines representing 95% confidence interval.

Quality of life in patients with type 2 diabetes mellitus and patients with osteoarthritisMarinela Đaković¹, Kosana Stanetić²¹Primary Health Center Laktaši, BiH²Primary Health Center Banja Luka, BiH

Background and AIM: Diabetes mellitus type 2 and osteoarthritis are diseases which significantly impact patients' quality of life. The aim of the study was to evaluate and compare the quality of life in patients with type 2 DM and patients with osteoarthritis.

METHODS: Interview-based study was conducted among patients with type 2 DM and patients with osteoarthritis. SF-36 questionnaire for assessing quality of life and a questionnaire with socio-demographic data were used as surveying instruments. The entry criteria included the following: patients aged 45 to 75 years, Group 1 - patients with type 2 DM and Group 2 - patients with osteoarthritis, both without comorbidities that may significantly affect the quality of life.

RESULTS: A total of 60 patients were included in the study, of whom 30 (50%) with type 2 DM and 30 (50%) with osteoarthritis, 27 (45%) male and 33 (55%) female patients. Statistically significant differences between two groups of examinees were found in the following areas of functioning: physical functioning ($p = 0.000$), activity limitations due to physical problems ($p = 0.001$), activity limitations due to emotional problems ($p = 0.015$), energy / fatigue ($p = 0.005$) and pain ($p = 0.000$). Group of patients with osteoarthritis had worse results regarding all mentioned areas of functioning. Summary results of physical functioning ($p = 0.000$) and summary results of mental functioning ($p = 0.017$) showed that the group of patients with osteoarthritis had significantly worse functional outcome than the group of patients with type 2 DM.

CONCLUSION: Although DM type 2 is more serious disease than osteoarthritis, the quality of life of the patients with osteoarthritis was significantly worse than in patients with type 2 DM.

Keywords: quality of life, diabetes mellitus, osteoarthritis

Results of quality of life by areas of functioning in both groups of patients(DM type 2 and osteoarthritis)

		N	M	SD	p
Physical functioning	Patients with DM type2	30	77,35	24,53	0,000
	Patients with osteoarthritis	30	53,67	19,74	
Role functioning/physical	Patients with DM type2	30	75,62	23,97	0,001
	Patients with osteoarthritis	30	52,50	25,14	
Role functioning/emotional	Patients with DM type2	30	76,39	25,63	0,015
	Patients with osteoarthritis	30	60,28	24,44	
Energy/fatigue	Patients with DM type2	30	60,62	24,52	0,005
	Patients with osteoarthritis	30	42,50	25,63	
Emotional well being	Patients with DM type2	30	66,50	25,63	0,078
	Patients with osteoarthritis	30	55,21	23,01	
Social functioning	Patients with DM type2	30	74,17	24,55	0,186
	Patients with osteoarthritis	30	65,00	28,32	
Pain	Patients with DM type2	30	77,25	25,92	0,000
	Patients with osteoarthritis	30	42,67	20,21	
General health	Patients with DM type2	30	52,64	18,68	0,232
	Patients with osteoarthritis	30	47,50	13,91	

Group of patients with osteoarthritis had worse results regarding all mentioned areas of functioning.

Summary results of physical functioning in both groups of patients (DM type 2 and osteoarthritis)

		N	M	SD	p
Summary results of physical functioning(physical functioning,role functioning/physical, pain,general health)	Patients with DM type 2	30	70,72	20,39	0,000
		30	49,09	17,15	

Patients with
osteoarthritis

The group of patients with osteoarthritis had significantly worse functional outcome than the group of patients with type 2 DM.

Summary results of mental functioning in both groups of patients (DM type 2 and osteoarthritis)

Summary results of mental functioning(role functioning/emotional,energy/fatigue,emotional well-being,social functioning)	Patients with DM				
	type 2	30	69,42	21,68	0,017
	Patients with osteoarthritis	30	55,75	21,45	

The group of patients with osteoarthritis had significantly worse functional outcome than the group of patients with type 2 DM

P-0985

Advance care planning in primary care, only for severely ill patients? A structured review

Jolien J. Glaudemans, Eric P. Moll Van Charante, Dick L. Willems

Department of General Practice, Section of Medical Ethics, Academic Medical Center – University of Amsterdam, Amsterdam, the Netherlands.

Background and AIM: Increasing medical possibilities, ageing of the population and the growing number of people with chronic illness appear to make advance care planning (ACP) inevitable. However, to what extent and how primary care providers (PCPs) provide ACP in daily practice is largely unknown. The aim of this review is to provide a literature overview of the actual practice of ACP in primary care.

METHOD: We searched MEDLINE, EMBASE, CINAHL, PsycINFO and the Cochrane Library for empirical studies that described the practice of ACP with patients in primary health care. Studies focussing on non-adult patients, and hospital or nursing home settings were excluded.

RESULTS: Ten articles met the inclusion criteria. The content of the ACP varied from discussing to refrain from cardiopulmonary resuscitation to existential issues. The prevalence ranged from 21% of PCPs having ACP discussions with the general elderly population to 69% having ACP discussions with terminal patients and 81% with patients with mild to moderate Alzheimer's disease. ACP was more common among cancer patients than among patients with non-cancer patients. Whether health care professionals or patients initiated ACP varied greatly. Advance directives and the Gold Standard Framework were perceived as helpful to guide ACP.

CONCLUSIONS: ACP does not seem to have a systematic place in the care for all community-dwelling older people. Rather, it is used for specific groups, like patients with terminal disease, cancer and Alzheimer's Disease. Whether ACP might have beneficial effects for a broader primary care population, in terms of future care planning, is yet to be investigated.

Keywords: Advance care planning, elderly, general practice, primary care

ACP in primary care



ADVANCE CARE PLANNING IN PRIMARY CARE

AMC logo



Academisch Medisch Centrum

Universiteit van Amsterdam

With names/title

Quotes

After an elderly woman switched to the practice of GP18 the GP and the woman talked about her wish to donate her body to science; 'Thereafter we talked about how she was living on her own, that she had less and less family left and about her blindness. She often needed help but said 'life is still is nice, but I don't want everything anymore.'

GP 11 talked with the family of an elderly woman with heart failure and dementia; 'if your mother would get a pneumonia and I think she could die from it, what would you think in such situation? Would you want her to be treated in the hospital, or should I treat her here with antibiotics and see if she'll make it or not?'

GP 3 counselled an elderly man with a history of CVA on anti-hypertensive treatment; 'He said that if refraining from medication would lead to a new, non-fatal stroke with decreased quality of life, he would rather use the medication. Yet he would not mind dying of another stroke. Quality was all that mattered to him.'

P-0986

Prevalence of mental disorders in family medicine practice

Olivera Batic Mujanovic¹, Jasminka Becirovic², Larisa Gavran³, Esad Alibašić⁴, Munevera Becarevic⁵

¹Family Medicine Teaching Center of Health Center Tuzla; Department of Family Medicine, Medical Faculty of Tuzla University, Tuzla, Bosnia and Herzegovina

²Health Center Srebrenik, Srebrenik, Bosnia and Herzegovina

³Family Medicine Teaching Center of Health Center Zenica, Zenica, Bosnia and Herzegovina

⁴Health Center Kalesija, Kalesija, Bosnia and Herzegovina

⁵Health Center Banovici, Banovici, Bosnia and Herzegovina

BACKGROUND & AIM: Over one-quarter of all adults attending primary care centers in Bosnia and Herzegovina has at least one type of mental disorder. The aim of this study was to determine the prevalence of mental disorders in family medicine practice related to age, gender, and diagnosis of mental disorders in adults over the age of 18 who attended primary care center in Tuzla, B&H.

METHODS: Trial was conducted in Family Medicine Teaching Center Tuzla and included 155 patients (108 women and 47 men) registered in family medicine team. Data were collected according to the age, gender, and diagnosis of mental disorders.

RESULTS: Prevalence of mental disorders was 9,69% (155/1445). Statistically more women had diagnosis of mental disorders than men (69,68% vs. 30,32%; $p < 0,0001$). Mean age of patients were $55,22 \pm 13,55$ years, without significant difference between women and men ($55,22 \pm 12,92$ vs. $51,58 \pm 15,87$; $p = 0,29$). Majority of patients belonged to the age group 20-64 years (75,48%), while 24,25% of patients were older than 65 years. The leading mental disorders were neurotic, stress-related and somatoform disorders (F40-F48) presented in 46,45% of patients. Mood disorders (F30-F39) had 43,23% of patients. Schizophrenia, schizotypal and delusional disorders (F20-F29) had 7,1%, and other mental disorders (F04-F09, F50-F69, F80-F99) had 1,29% of patients. Alcohol abused 1,29% of patients (F10). Overall 60 (38,71%) patients were treated by family physician, while 95 (61,21%) attended mental health center. Psychotherapy was performed in 25% of patients. Majority of patients used pharmacological therapy over two years (74,19%). The most prescribing drugs were SSRI antidepressants (63,23%), while benzodiazepines used 49,68% of patients.

CONCLUSION: Mental disorders are still quite prevalent among the adults attending primary care centers in Bosnia and Herzegovina. It suggests the need for an integrated approach to general medical and mental health treatment in order to provide mental health care with confidence.

Keywords: mental disorders, family medicine

Figure 1. Distribution of patients related to gender

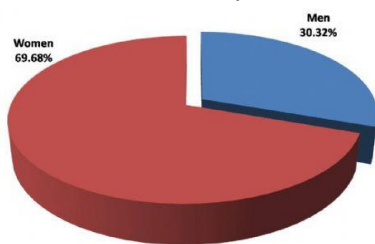


Figure 2. Distribution of patients related to type of mental disorders

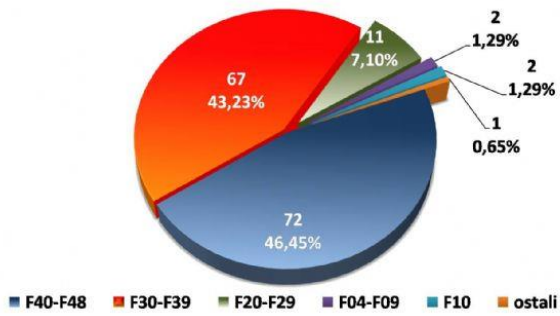
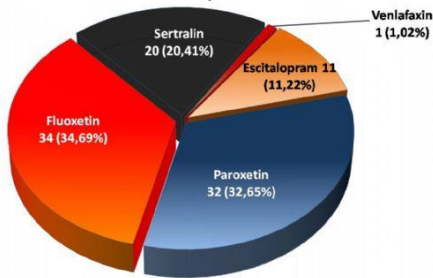


Figure 3. Distribution of patients related to the most prescribed antidepressive drugs



P-0987

Could it be colorectal cancer? General Practitioners' use of Faecal Occult Blood Tests and decision-making - a qualitative study

Cecilia Högberg¹, Mikael Lilja¹, Eva Samuelsson¹, Eva Fhärm²

¹Department of Public Health and Clinical Medicine, Unit of Clinical Research Centre - Östersund, Umeå University, Umeå, Sweden

²Department of Public Health and Clinical Medicine, Family Medicine, Umeå University, Umeå, Sweden

Background & Aim

Abdominal complaints are common reasons to contact General Practitioners (GPs), and selecting the patients with suspected colorectal cancer (crc) to refer for further investigation can be a challenge. Faecal Occult Blood Test (FOBT) is commonly used as a diagnostic aid. It is however uncertain how FOBT results are interpreted. Studies have shown that negative tests are associated with a risk of delayed diagnosis, and that some patients with positive tests are not investigated further. The aim was to explore what makes GPs suspect crc, their practice concerning investigation and decision-making, and the use of FOBT.

Method

Semi-structured individual interviews were made with eleven GPs in Region Jämtland Härjedalen, Sweden, and analysed with qualitative content analysis.

Results

Five categories were identified:

Careful listening to the patient's history required: To listen attentively was described as essential, but with a risk of being misled by the patient's own explanations.

Laboratory tests can be of help - FOBTs can help or complicate: Anaemia was considered an important factor. All used FOBTs to different extents, but interpretation of the results and actions taken varied.

To refer or not to refer - safety margins necessary: Uncertainty was described as a part of everyday work.

Common vague symptoms could be crc and justified referral with safety margins.

Growing more confident - yet humble: With increasing experience the GPs described becoming more confident in decisions but also more humble and less prestigious.

The patient's advocate: The GPs strived to keep the patient's best in focus in a changing reality.

Conclusions

In deciding which patients to refer careful listening to the patient's history was found essential. FOBTs were frequently used as support, with a considerable variation in handling of the test results. The diagnostic process can be described as navigating uncertain waters with safety margins.

Keywords: Colorectal Neoplasms, Occult blood, Decision Making, Qualitative Research

Quotes from the interviews

1. Careful listening – with awareness of the pitfalls

"It's the patient that knows how things were. ... If something brings the patient to me because he or she feels that something is different, then there is in fact a change." (GP2)

"Sometimes, patients have their own explanations, which may act as a kind of smoke screen. ... The explanation they come up with can ultimately delay things." (GP3)

2. Tests can help – the iFOBT can also complicate the diagnosis

"Yes, they're of huge help, yes. ... They're of crucial importance." (GP6)

"Yes, they serve as an indication." (GP8)

"In reality, they're not so useful. ... They don't help me very much, I'm hesitant to the usefulness of faecal occult blood tests." (GP5)

3. To refer or not to refer – safety margins are necessary

"The level of investigation must have a safety margin ... Otherwise, we're too restricted in our investigations." (GP6)

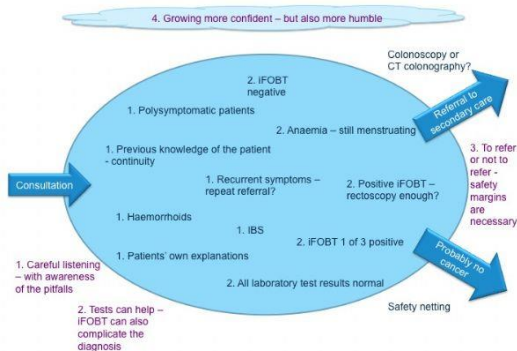
"Most of what we investigate turns out to be nothing. ... You have to draw the line somewhere and keep a cool head and wait a while." (GP7)

4. Growing more confident – but also more humble

"I almost feel like I can be more generous with my referrals for bowel imaging now than I was previously, because with time you see how difficult it is. Suddenly, someone you didn't think had a malignancy actually has one." (GP6)

"I've worked for quite a few years ... there's no work prestige involved. ... I don't really care if there is someone at the other end that laughs at my referral ... it's not my problem." (GP9)

The GP's way to decision on referral



The patient and the doctor together enter the sea of consultation. The doctor has to navigate past the shoals belonging to category 1 and category 2. The doctor and the patient together arrive at the decision to refer to secondary care or not, category 3. All the way the cloud of experience is a companion, category 4.

P-0988

Development of a simple tool for identifying alcohol use disorder in Korean female drinkers from previous questionnaires

Yuri Seo

Department of Family Medicine, Research Institute for Medical Sciences, Chungnam National University School of Medicine, Korea

BACKGROUND: This study aimed to develop a simple tool for identifying alcohol use disorders in Korean female drinkers from previous questionnaires.

METHODS: This research was conducted with 400 women who had a drink during the past month, visiting the Chungnam National University Hospital from June 2013 to May 2014. Drinking habits and alcohol use disorders were assessed by structured interviews using the DSM-5 diagnostic criteria. At the same time, the subjects were asked to answer the AUDIT, AUDIT-C, CAGE, TWEAK, TACE and NET questionnaires. The AUROC of each question of the questionnaires on alcohol use disorders was assessed. After combining two questions with the largest AUROC, it was compared to other previous questionnaires.

RESULTS: Among the 400 persons, 58 (14.5%) were identified as those with alcohol use disorders. Two questions with the largest AUROC were Question No. 7 in AUDIT, "How often during the last year have you had a feeling of guilt or remorse after drinking?" and Question No. 5 in AUDIT, "How often during the past year have you failed to do what was normally expected from you because of drinking?" with an AUROC (95% CI) of 0.886 (0.850 - 0.915) and 0.862 (0.824 - 0.894). The AUROC (95% CI) of the combination of the two questions was 0.958 (0.934 - 0.976) with no significant difference as compared to the existing AUDIT with the largest AUROC.

CONCLUSION: The above results suggest that the simple tool consisting of Questions No. 5 and No. 7 in AUDIT is useful in identifying alcohol use disorders in Korean female drinkers.

Keywords: Alcohol, Drinking, Female, Questionnaires

Demographic characteristics of participants.

Characteristics	Mean±SD or n (%)
Age, y	42.2±12.8
Age of alcohol contact	22.5±6.30
Living state	
Housemate	330 (82.5)
Alone	70 (17.5)
Smoking	
Non-smokers	374 (93.5)
Ex-smokers	19 (4.8)
Current-smokers	7 (1.8)
Education level	
Elementary school	9 (2.3)
Middle school	38 (9.5)
High school	122 (30.5)
University/college	211 (52.8)
> University/college	20 (5.0)

Frequency of drinking per week	0.5±0.7
Usual drinking amounts on an occasion	1.6±1.6
Maximal drinks on an occasion	2.4±1.2
Score of screening questionnaires	
AUDIT	3.9±4.7
AUDIT-C	2.7±2.4
CAGE	0.4±0.8
TACE	0.4±0.9
TWEAK	0.9±1.4
NET	0.2±0.5
At-risk drinking	144 (36.0)
Heavy drinking	35 (8.8)
Binge drinking	144 (36.0)
Alcohol use disorder	58 (14.5)

Area under receiver operating characteristic (AUROC) of ten items with the largest AUROC in identifying alcohol use disorder.

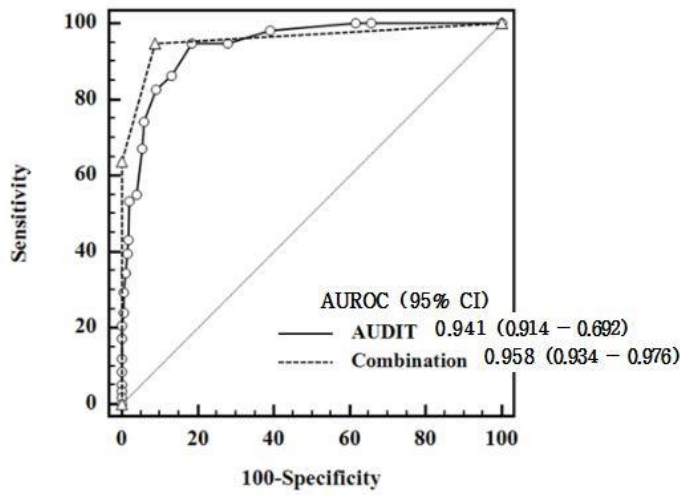
	AUROC	95% CI
AUDIT-7	0.886	0.850 - 0.915
AUDIT-5	0.862	0.824 - 0.894
Guilty from CAGE	0.859	0.821 - 0.891
AUDIT-2	0.832	0.792 - 0.867
AUDIT-3	0.829	0.789 - 0.865
AUDIT-4	0.817	0.741 - 0.893
AUDIT-1	0.809	0.759 - 0.859
AUDIT-8	0.793	0.716 - 0.871
Cut down from CAGE, TACE	0.762	0.683- 0.841
Tolerance from TWEAK, TACE	0.734	0.659 - 0.809

Comparison of AUROC for screening questionnaires.

	AUROC (95% CI)	AUDIT-C	CAGE	TWEAK	TACE	NET	Combination (AUDIT-7&AUDIT-5)
AUDIT	0.941* (0.914 - 0.969)	P<0.001	P=0.014	P<0.01	P<0.001	P<0.001	P=0.18
AUDIT-C	0.887 (0.852 - 0.917)		P=0.88	P=0.47	P=0.012	P<0.001	P=0.003
CAGE	0.883 (0.848 - 0.913)			P=0.62	P=0.002	P<0.001	P=0.028
TWEAK	0.871 (0.834 - 0.902)				P=0.013	P<0.001	P=0.004

TACE	0.807 (0.765 - 0.844)	P<0.01	P<0.001
NET	0.718 (0.671 - 0.761)		P<0.001
Combination (AUDIT-7&AUDIT-5)	0.958 (0.934 - 0.976)		

Comparison of receiver operating characteristic curves of the combination (AUDIT-5 and AUDIT-7) with the AUDIT in identifying alcohol use disorder.



P-0989

The prevalence and related factors of restless leg syndrome in the community-dwelling elderly; in Kayseri, Turkey: a cross-sectional study

Elif Deniz Safak¹, Semsinur Gocer², Salime Mucuk³, Ahmet Ozturk⁴, Sibel Akin⁵, Sibel Arguvanli⁶, Mumtaz Mustafa Mazicioglu¹

¹Elif Deniz Safak, (M.D.), Asst. Prof, Department of Family Medicine, Erciyes University School of Medicine, Kayseri, Turkey

²Semsinur Gocer, Nurse, Hacilar Public Health Center, Kayseri, Turkey

³Salime Mucuk, (Ph.D.), Asst. Prof, Department of Nursing, Erciyes University School of Health Science, Kayseri, Turkey

⁴Ahmet Ozturk, (Ph.D.), Assoc. Prof, Department of Biostatistics, Erciyes University School of Medicine, Kayseri, Turkey

⁵Sibel Akin, (M.D.), Asst. Prof, Department of Internal Medicine, Division of Geriatrics, Erciyes University School of Medicine, Kayseri, Turkey

⁶Sibel Arguvanli, (Ph.D.), Asst. Prof, Department of Nursing, Meliksah University School of Health Science, Kayseri, Turkey

⁷Mumtaz M. Mazicioglu, (M.D.), Prof, Department of Family Medicine, Erciyes University School of Medicine, Kayseri, Turkey

PURPOSE: The aim of this study is to determine the prevalence and related factors of restless leg syndrome (RLS) in the community-dwelling elderly living in Kayseri.

METHODS: This is a cross-sectional population based study in 960 community-dwelling elderly living in an urban area. We sampled 1/100 of elderly people aged 60 years and older. The diagnosis of RLS was made according to the criteria of the International RLS Study Group (IRLSSG). The demographic data were collected by face-to-face interviews. Additionally, the Mini-Mental State Examination (MMSE), Geriatric Depression Scale (GDS) and anthropometric measurements were used. Logistic regression analyses were performed to define risk factors for RLS.

RESULTS: We excluded elderly people with cognitive impairment (295). One hundred and five (15.8%) of the remaining 665 elderly subjects met the criteria to diagnose RLS. There was female predominance (3/1). Gender, length of education, employment status, smoking, hypertension (HT), diabetes mellitus (DM), depressive mood, high body mass index (BMI), and high waist circumferences (WC), sleep quality, sleep duration, and difficulty in falling asleep in the first 30 minutes were all detected as risk factors for RLS. However in logistic regression analysis, being a housewife, sleeping less than 6 hours a day, and having diabetes were found as significantly related risk factors for RLS.

CONCLUSION: This is the first epidemiologic study of RLS conducted in the Turkish community-dwelling elderly in an urban area. RLS is a common but underestimated disease in the elderly. Although RLS is prevalent we found very few risk factors for RLS.

Keywords: Restless leg syndrome; elderly; community-dwelling; sleep disorder; sleep quality.

Table 1: The diagnostic criteria of the International RLS Study Group

1. Desire to move the limbs usually associated with uncomfortable and unpleasant sensations, motor restlessness
2. Worsening of symptoms during periods of rest or inactivity such as lying or sitting
3. The urge to move or unpleasant sensations are relieved by movement with at least partial and temporary relief by activity
4. Worsening of symptoms in the evening or night or only occur in the evening or night

Table 2: Logistic regression to determine risk factors in RLS (+) the community-dwelling elderly

Variables	OR	(Model backward stepwise wald) %95.0 CI
-----------	----	--

Current employment status		
Retired	1	2.482-7.058
Housewife	4.19	
Weekdays sleep duration		
6 h/day \leq	1	0.289-0.766
6 h/day	0.47	
DM		
No	1	
Yes	2.68	1.612-4.454

P-0990

Working Conditions and Health Status in Taxi and Bus Drivers at Çanakkale, Turkey; Community Based Study

Aysegul Uludag¹, Sibel Cevizci², Murat Tekin¹, Yusuf Haydar Ertekin¹, Sezgin Sevim², Ulken Babaoğlu³, Coşkun Bakar²

¹Department of Family Medicine, Canakkale Onsekiz Mart University, Canakkale, Turkey

²Department of Public Health, Canakkale Onsekiz Mart University, Canakkale, Turkey

³Health College, Ahi Evran University, Kırşehir, Turkey

BACKGROUND: The growing taxi and bus driver workforce is at risk for poor health status, obesity, hypertension, metabolic syndrome and with increased risk for cardiovascular disease.

AIM: to determine the relationship between working conditions and health status in taxi and bus drivers.

METHOD: This study is a descriptive study. The population of the study was taxi and bus drivers in central of Canakkale. There were 164 taxi drivers and 150 bus drivers who registered in The Chamber of Canakkale Drivers and Vehicle. We reached the 70 (42.7%) taxi drivers and 93 (62.0%) bus drivers in the study.

The participants were visited at their workplace. We performed the questionnaire that include the socio-demographic features, habits, disease history, the working conditions. We evaluated the blood pressure in both arms, waist-hip measurements and capillary blood glucose at any time.

RESULTS: There were 70 (42.9%) taxi drivers and 93 (57.1%) bus drivers. All of them were men. The socio-demographic and descriptive features are shown at Table 1.

Nine (12.9%) taxi drivers and 6 (6.5%) bus drivers were hipertensive, and 1 taxi driver and 2 bus driver with random capillary blood glucose levels higher than 200 mg. In this study, based on the ATP III criteria, the prevalence of Metabolic Syndrom was found 9.6%. Of the 8 (11.4%) taxi drivers and 8 (8.6%) bus drivers were met the criteria of ATP III.

There was statistical significant between HT and income level ($u=709.5$; $p=0.008$). Metabolic Syndrome and working hours was statistical significant ($u=750$; $p=0.015$). There was statistical significant between obesity and age and history of chronic disease ($u=2720$; $p=0.028$ and $u=2637$; $p=0.031$).

CONCLUSION: Drivers' working condition is related with Metabolic Syndrome, obesity and hypertension. All of them are the risk factors of cardiyovascular disease (CVD). These results may direct us to take precautions about their health status.

Keywords: drivers, working conditions, health status

Table 2: The relationship with socio-demographic and measuring variables

Blood glucose level	r*	p
Waist circumference	0.151	0.005
Weight	0.137	0.011
Waist circumference (cm)		
Blood glucose level	0.151	0.005
Weight	0.444	0.000
Kilometers (km/day)	0.122	0.029

Table 2: The relationship with socio-demographic and measuring variables

Table 3. The relation between the capillary blood glucose level in the Multivariable Linear Regression Backward Model

	Blood Glucose Level			
	β	p*	Lower Bound	Upper Bound
Constant	-89,032	.129	-206,283	28.220
Age	2,899	.008	0,892	4,966
Marital status 1=single 2=married	24,624	.011	-6.197	43,051
Duration as driver (year)	0,014	.080	-0.002	0.029
Driven old car 1=yes 2=no	19,364	.035	-1.548	37,180
Driver 1=Taxi driver 2=Bus driver	-15,413	.213	-40.399	9.593

Table 3. The relation between the capillary blood glucose level in the Multivariable Linear Regression Backward Model

Table1. Socio-Demographic Features and Working Conditions of Drivers

	Taxi Drivers	Bus Drivers	Statistical	p
	mean±SD	mean±SD	test	
Age	41.2±11.7 [24-68]	42.4±9.6 [24-61]	X ² =64.284	<0.05
Education				
Primary school	23(32.9%)	65(69.9%)	X ² =23,762	<0.05
High school	34 (48.6%)	24 (25.8%)		
University	13(18.6%)	4(4.3%)		
Marital status				
Single	19 (27.2%)	20 (21.5%)	u=3139.5	>0.05
Married	51 (72.8%)	73 (78.5%)		
Smoking				
smoking	30 (42.9%)	63 (67.7%)	X ² =10,170	<0.05
Non-smoking	40 (47.1%)	30 (33.3%)		
Alcohol				
Yes	47(67.1%)	64(68.8%)	X ² =2.247	<0.05
No	23(32.9%)	29(31.2%)		
Driver year	16.5±10.4 [2-43]	17.8±8.9 [2-42]	X ² =34.266	>0.05
History of Chronic Disease	32 (45.7%)	35 (37.6%)	X ² =1.077	>0.05
Hour of working as driver (hour/day)	10.5±2.5 [3-15]	9.1±2.5 [2-15]	X ² =27,547	<0.05
Hour of driving	5.8 ±2.9 [1-12]	6.8±2.8 [1-14]	X ² =107,162	<0.05

Table1. Socio-Demographic Features and Working Conditions of Drivers

P-0991

Does work-family conflict cause anxiety and depression in medical residents?

Özge Berfu Gürbüz, Vildan Mevsim

Department of Family medicine, Dokuz Eylül University, İzmir, Turkey

Background & Aim

Work family conflict leads to a higher rate of depression and anxiety in medical residents, and there wasn't enough data about the effect of it on anxiety and depression in Turkey.

The aim of the research is to evaluate the effect of work-family conflict on anxiety and depression in medical residents.

Method

This research was conducted as a thesis project and is at preliminary result stage. This was a cross sectional study carried among medical residents working at Dokuz Eylül University, during september to december 2014. By using simple randomized sampling, 215 residents were chosen to participate and fill a self administered questionnaire entailing data about sociodemographic characteristics, hospital anxiety depression scale, work-family conflict scale. As statistical analysis descriptive analysis, Chi-square test, student T test were applied.

Results

The study included 209 residents, %49,8 were female and % 50,2 male. Average age of participants was $28,28 \pm 3,09$. Average working condition score was $22,15 \pm 4,88$. %23,4 of the participants had anxiety and %30,6 had depression. %51,2 had work-family conflict and % 9,1 had family-work conflict. %57 of the participants who had work-family conflict, had depression and %43,9 of the patients with work-family conflict had anxiety. %10,5 of the participants with family-work conflict had depression and %5,3 had anxiety. The rate of anxiety and depression was higher in participants who had work-family conflict, compared to the ones who had work-family balance. Participants with family-work conflict also had a slightly increased anxiety and depression rate.

Work family conflict has a greater influence on anxiety and depression compared to family-work conflict.

Conclusion

Working conditions causes more conflict in residents' family life, where as family life causes less conflict on working life. Work-family conflict increases the rate of anxiety and depression in medical residents.

Keywords: work-family conflict, anxiety, depression, medical residents

Table1

Table-1: Demographic characteristics of participants.		
	N	%
Age groups		
<25	33	15,8
26-27	63	30,1
28-29	55	26,3
>30	58	27,8
Gender		
Female	104	49,8
Male	105	50,2
Marital status		
Married	111	53,1
Single	95	45,5
Widow/Divorced	3	1,4
Number of Children		
None	188	90
1	12	5,7
2	8	3,8
3	1	0,5
Specialty		
Basic Science	3	1,4
Physicians	156	74,6
Surgeons	50	23,9
Night Shifts (per month)		
0-4	84	40,2
5-8	75	35,9
9-20	50	23,9
Years of residency		
1-2	147	70,3
2-3	54	25,8
4-5	8	3,8
TOTAL	209	100

Table2

Work-Family Conflict Status	Non-Depressed % (n)	Depressed % (n)	Total % (n)	p
Balanced	98,8 (82)	1,2 (1)	100,0 (83)	0,00
Work-Family Conflict	43,0 (46)	57,0 (61)	100,0 (107)	
Family-Work Conflict	89,5 (17)	10,5 (2)	100,0 (19)	
Total	69,4 (145)	30,6 (64)	100,0 (209)	

table 3

Work-Family Conflict Status	Non-Anxious % (n)	Anxious % (n)	Total % (n)	p
Balanced	98,8 (82)	1,2 (1)	100,0 (83)	0,00
Work-Family Conflict	56,1 (60)	43,9 (47)	100,0 (107)	
Family-Work Conflict	94,7 (18)	5,3 (1)	100,0 (19)	
Total	76,6 (160)	23,4 (49)	100,0 (209)	

P-0992

Metabolic syndrome and type 2 diabetes

Enisa Ramic¹, Esad Alibasic², Olivera Batic Mujanovic¹, Renata Smajlovic¹

¹Primary Health Care Center Tuzla

²Primary Health Care Center Kalesija

INTRODUCTION: Metabolic syndrome is a set of high-risk factors that lead to the development of coronary heart disease and type 2 diabetes. These factors are as follows: hypertension, glucose intolerance and elevated levels of plasma triglycerides while concentration of HDL-cholesterol is reduced. The two most important risk factors for the development of the metabolic syndrome are a large amount of weight around the abdomen (visceral obesity) and resistance of peripheral tissues cells to the effects of insulin.

OBJECTIVE: To determine the prevalence of metabolic syndrome in people with type 2 diabetes.

METHODS: The study included 120 patients with diagnosis of diabetes mellitus, who reported for medical examination in the time frame from September to December of 2014. Criteria for diagnosis of metabolic syndrome were any three of the five parameters: increased waist circumference (≥ 102 cm -in male; > 88 cm -in female), blood pressure $> 130/85$ mmHg, dyslipidemia (triglycerides ≥ 1.7 mmol/L, HDL-c < 1.0 mmol/L -male; < 1.3 mmol/L -female), fasting plasma glucose ≥ 6.1 mmol/L.

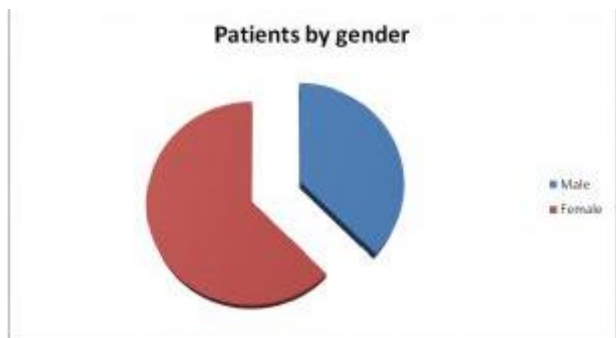
RESULTS: The study included 45 men (37.5%) and 75 women (62.5%). The average age was 67.18 ± 10.3 years. 51.66% patients had three or more parameters of the metabolic syndrome. In the subgroup of diabetic patients with metabolic syndrome, the increased waist circumference was present in 90.32% patients, blood pressure $> 130/85$ mmHg was present in 79%, and 74.19% patients had increased triglyceride levels.

Out of the total number of patients, 43.33% had preferred physical activity (≥ 30 min per day) and 56.66% patients had insufficient physical activity

CONCLUSION: The prevalence of metabolic parameters that make up the metabolic syndrome could be reduced by changing life style. Focused and continuous patient care allows us to make an influence on patients in a way of changing their habits, which is a basic and very effective measure for treating metabolic syndrome.

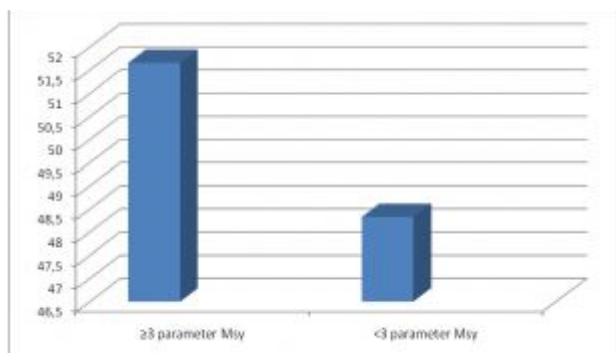
Keywords: metabolic syndrome, type 2 diabetes, parameters, life style

rezultat 1



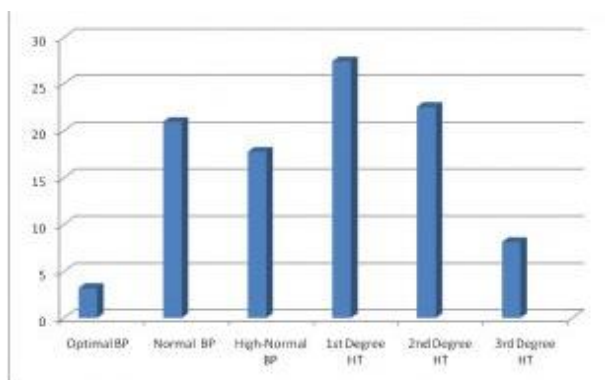
The study included 45 men (37.5%) and 75 women (62.5%). The average age was 67.18 ± 10.3 years.

rezultat 2

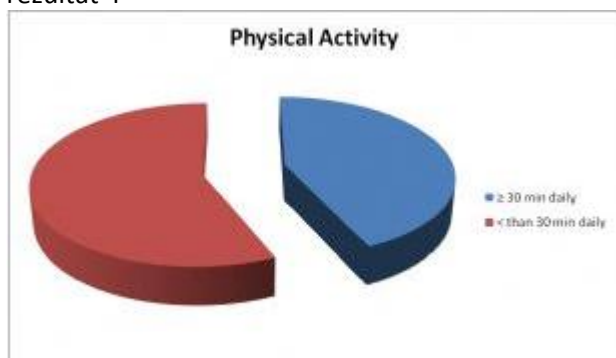


51.66% patients had three or more parameters of the metabolic syndrome

rezultat 3



rezultat 4



56.66% patients had insufficient physical activity

P-0993

Screening of chronic diabetes complications among primary health care patients in Bosnia and Herzegovina

Natasa Damjanac¹, Valentina Kilibarda¹, Maja Racic²

¹Primary Care Health Centre Trebinje

²University of East Sarajevo

INTRODUCTION: Diabetes mellitus is a common chronic illness, which is associated with many chronic complications.

Objectives. In the present study, the audit of medical files of patients with diabetes followed in Family Medicine Teaching Centre Foca, Bosnia and Herzegovina (BiH), was carried out in order to investigate the frequency of the use of screening tests for early diagnosis of diabetes complications.

Methods. The audit was conducted among 192 patients with diabetes. Screening tests assessed are selected according to the ADA guidelines and included: blood pressure, body mass index (BMI), urine protein analysis, serum creatinine, dilated eye examination, foot examination, neurological examination and ankle-brachial index (ABI). The study was carried out in course of one-year period (March 2011 to March 2012).

Results. Frequency of the individual screening test varied between 92%, found for at least one blood pressure measurement, and 0.5% for ABI measurement. When the frequency of optimal use of screening was analyzed, only 0.3 % of patients received all recommended screening tests. The factors associated to low screening rate were male gender, diagnosis of type 1 diabetes and having more than 100 diabetes patients, registered with the practice. The physicians with completed vocational training in family medicine, belonging to the age group of 36 to 40 years and with the years of experience in the range between 11 and 15 were more likely to provide larger number of screening test for their patients compared to the other group.

Conclusion. The frequency of the use of screening tests for chronic diabetes complications was found to be low in Primary Health Care Centre Foca. There is a need for an improved screening awareness among primary care providers and a focus on enhancing screening practices among males and persons with other cardiovascular factors present.

Keywords: quality of care, diabetes mellitus, screening, chronic complications

P-0994

"Burnout and Related Factors in Healthcare Workers"

Dilek Kusaslan Avci, Huseyin Avni Sahin

Department of Family Medicine, Medical Faculty of Yuzuncu Yil University, Van, TURKEY

AIM:

The aim of the study is to determine the prevalence of Burnout and related factors among Healthcare Workers in a university hospital.

METHODS:

A total of 179 health workers were included in the study working in a university hospital in Van. Research data were collected with a questionnaire consisting of two parts. In the first section questions regarding socio demographic information, smoking, drinking alcohol, hobbies and methods of coping with stress were included. The second section includes the results of Maslach Burnout Scale (MBI). MBI scale is composed of three dimensions; emotional exhaustion, depersonalization and personal accomplishment.

RESULT:

The study population consisted of 81 female (44.5 %) and 99 male (55.5 %). Participants were physicians (31.1%), nurses (47.8 %) and other employees (21.1 %). According to study 12.3 % of the females' and 22.4 % of the males' emotional exhaustion scores and 7.4 % of the females' and 12.2 % of the males' depersonalization scores were high. According to study, 26.1 % of the physicians', 8.5 % of the nurses' and none of other employees' depersonalization scores were high (p: 0.006). Furthermore, 55.9 % of the physicians, 21.3 % of the nurses and 6.2 % of other employees' emotional exhaustion scores were high (p: 0.271). All of the physicians', all of the other

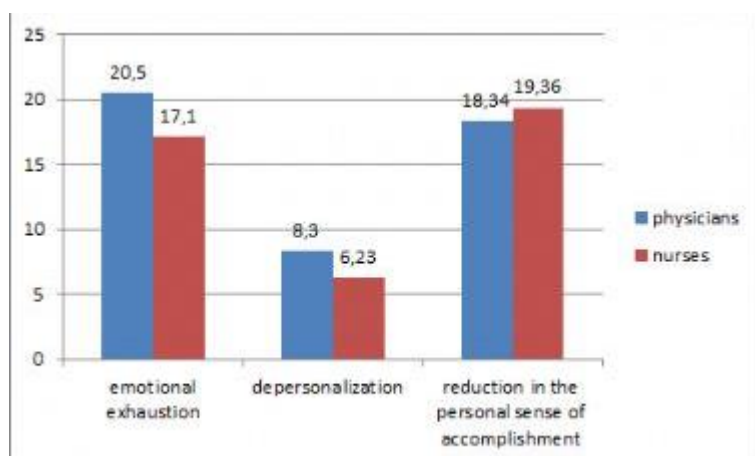
employees' and 97.9 % of the nurses had reduced sense of personal accomplishment (p: 0.000). Smokers had high-level of emotional exhaustion (30.8%) compared to non-smokers (11.6 %) (p: 0.024).

CONCLUSION:

The study showed that burnout rate among health care workers was very high. There was a significant relationship between the rate of burnout and smoking. Further attention and studies are necessary to reduce the burnout of health care workers.

Keywords: Burnout, personal achievement, emotional exhaustion, depersonalization, physician, healthcare workers

Graph 1: The Mean Score in Physicians and Nurses



P-0995

Complementary and Alternative Medicine in Patients with Diabetes Mellitus who Referred to University Hospital

Dilek Kusaslan Avcı, Huseyin Avni Sahin, Ercan Oner

Department of Family Physicians, Yüzüncü Yıl University, Van, Turkey

AIM: Complementary and alternative therapies are used widely in the treatment of Diabetes Mellitus (DM) in combination with or instead of standard medical care. This study was carried out as a descriptive study in order to examine the use of complementary and alternative medicine (CAM) in Diabetes Mellitus patients.

METHODS: Patients admitted to outpatient endocrinology clinics were given questionnaires involving age, gender, education, occupation, chronic illness, medication, use of herbal and nutritional complementary products, information resources and benefit of using herbs and nutritional complementary products. Data were evaluated by using SPSS computer software version 16.

RESULTS:

117 DM patients included in the study (63.2% women, 36.8% men). The overall use of CAM was 41.2 % among DM patients. Of the CAM used patients, 56.2% was women and 43.8 % was men. The most commonly used method was plants and herbal teas with a rate of 77.08 %. Patients stated that use of CAM are suggested by relatives (71.8), other diabetes mellitus patients (15.5 %), doctors (3.5 %), TV programs (2.6 %), herbalists (2.6 %), internet resources (1.8 %) and books (1.7 %). 29.9% of the patients share their CAM experience with their doctors and 4.3% of the patients' doctors asked to stop CAM. 12.8% of the patients stated that CAM therapies are beneficial, on the contrary 11.3% mentioned that CAM therapies are harmful to them. Even though all the patients excepting the use of CAM therapies by their doctors, only 1.3 % of the patients aware of doctors may

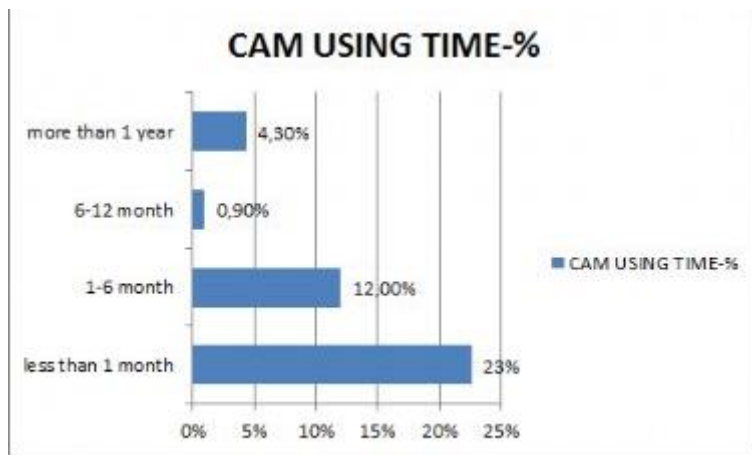
prescribe alternative and complementary therapies in Turkey.

CONCLUSION:

Use of alternative and complementary products were common in Diabetes Mellitus patients admitted to outpatient endocrinology clinics. Healthcare professionals should be aware of complementary and alternative therapies and should keep in mind that they have the responsibility of informing their patients about these therapies during daily practice.

Keywords: complementary and alternative treatment; diabetes mellitus; patient.

Complementary and Alternative Therapies Used in Time



P-0996

Comparison of feeling of depression and loneliness in elderly individuals living alone, living with family or being nursed

Ege Özince¹, Mehmet Ziya Gencer¹, Seçil Arıca¹, Ender Kaya²

¹Department of family medicine, Okmeydanı research hospital, İstanbul, Turkey

²Department of psychiatry, Okmeydanı research hospital, İstanbul, Turkey

Background&AIM: Depression and loneliness feelings are mostly unnoticed conditions that affect people's quality of life if untreated. Working at the trend level of loneliness and depression of the way of life in the elderly, thus evaluating their effects on social life, we aimed to investigate the relationship between sociodemographic characteristics.

METHOD: The study was performed on elderly people being nursed, living alone at home, and living with his family at home (with his wife, his children and children with his wife, or both), and 65 years and older individuals were selected. The nursery section of the study was selected from the elderly in 'İstanbul Darülaceze Kurumu' on voluntary basis. The ones living alone were selected from the people applied to the polyclinics in Okmeydanı Eğitim Araştırma Hastanesi. Data was obtained as the result of the survey done with Geriatric Depression Scale, UCLA-S Loneliness Inventory.

RESULTS: Rate of depression in elderly people is higher than the depression level in entire society. In correlation with depression, the same is true for the sense of loneliness. The sense of loneliness becomes more fierce, as depression becomes stronger. The elderly people living alone are more exposed to depression compared to the ones living with family or being nursed, and sense of loneliness becomes a more important problem for such people. The ones having a habit, liking to communicate with other people, enjoying family and friend visits, spending time with grandchildren (if any), in a nutshell the ones being easily socialized suffer less from the sense of loneliness.

CONCLUSION: To include the quality of life in geriatric population; we should know the affects of lifestyle and

their environment to their state of mind and loneliness feelings, as a family physician it is required to give health care for troubleshooting the negative affects of these.

Keywords: depression, loneliness feelings, geriatric depression scale, UCLA-LS loneliness Inventory

P-0997

Are there any differences in the trends of home visits between rural and urban regions in Croatia: 1995-2013

Hida Javoric

Family Practice "Dr. Hida Javorić, Foundation for the Development of Family Medicine in Croatia

Background and aims

Similar to other countries, home visits in Croatia are within the scope of family practice (FP). A study aimed to determine the overall trends in home visiting in Croatian FM demonstrated that the annual number of home visits is relatively small, whether it is viewed per patient (0.1) or per doctor (160) with a decreased trend. The aim of this study was to investigate if there are any differences in the trends of home visiting between Croatian rural and urban regions.

Method

The study is observational, population and longitudinal, from 1995 to 2013. A data sources were Croatian Health Service Yearbooks. The numbers of family doctors and the number of home visits were collected for each study year and in relations to rural/urban regions. According to the Strategy of Rural Development, Croatia is divided on three regions: rural, semi-rural and urban, containing almost the similar number of inhabitants.

Results

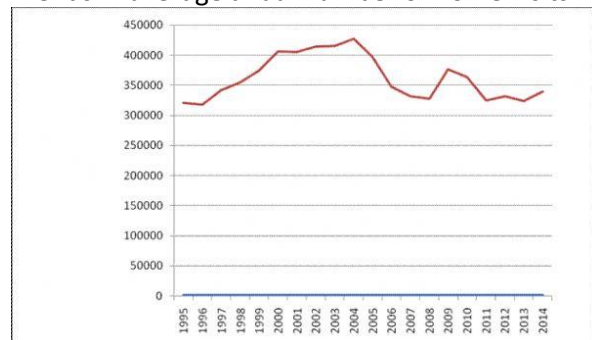
The results indicate that there are differences in the number of home visits in relations to urban and rural regions. The biggest number of them was found in rural regions, then in semi-rural and in urban regions. For instance in 2000 when the number of home visits was higher; it was performed 0.16 home visits per patient in rural, 0.14 in semi-rural and 0.10 home visits per patients in urban regions. In the same year, each family doctor working in rural areas performed 189 home visits, in comparison to 174 in semi-rural and 122 in urban regions. The differences in the trends were not found, the number of home visits increased until 2000 and then decreased in all regions.

Conclusions

A higher number of home visits was found in Croatian rural then in semi-rural and urban regions, with decreased trends in all regions.

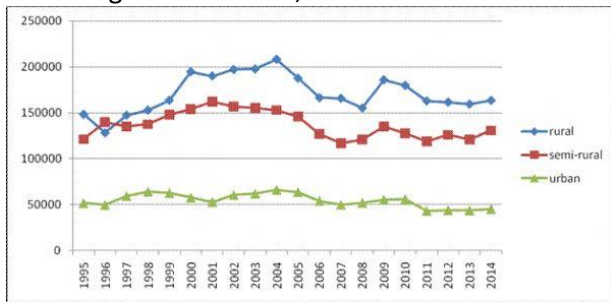
Keywords: visits, family practice, rural/urban differences, Croatia

Trends in average anual number of home visits in Croatian Family Practice, 1995-2014



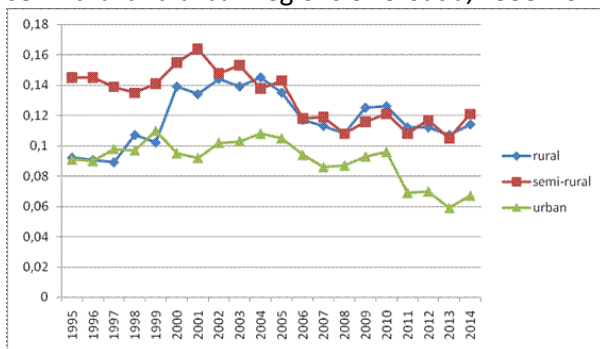
A great number of home visits are found in rural regions, then in semi-rural and in urban regions. The differences in the trends are not found (Fig 2).

Trends in average annual numbers of home visits performed in Family Practice regarding the rural, semirural and urban regions of Croatia, 1995-2014



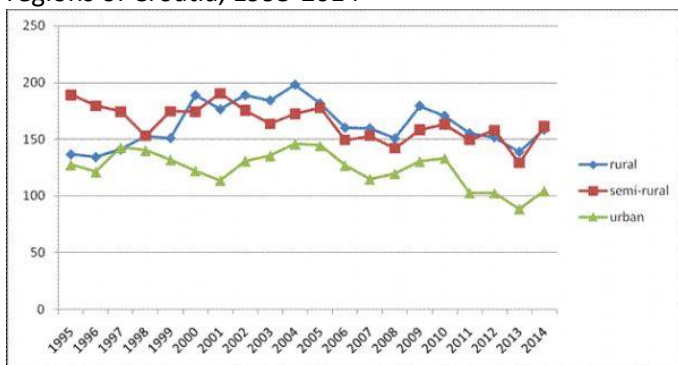
In 2000, it was performed 0.16 home visits per patient in semi-rural, 0.14 in rural and 0.10 home visits per patients in urban regions. In 2014 it was performed 0.11 home visits per patient in rural, 0.12 in semi-rural and 0.06 home visits per patient in urban regions.

Trends in average numbers of home visits per one patients performed in Family Practice regarding the rural, semirural and urban regions of Croatia, 1995-2014



In 2000, each family doctor working in rural areas performed 189 home visits, in comparison to 178 in semi-rural and 120 in urban regions. In 2014 it was performed 159 home visits per one family doctor in rural regions, 162 in semi-rural and 105 in urban regions.

Trends in average annual numbers of home visits per one family doctor regarding the rural, semirural and urban regions of Croatia, 1995-2014



P-0998

Relationship between Prevalence of Depression and Family Function in Primary Care

Seung Hyun Yoo¹, Jung Ah Lee¹, Sung Sunwoo¹, Young Sik Kim¹, Byung Su Kim², Han Jin Oh³, Chul Min Kim⁴, Hee Jeong Cho⁵, Hee Jin Hwang⁶, Sun Wha Ok⁷

¹Department of Family Medicine, Asan Medical Center, University of Ulsan College of Medicine, Seoul, Korea

²Department of Psychiatry, Asan Medical Center, University of Ulsan College of Medicine, Seoul, Korea

³Department of Family Medicine, Vievis Namuh Hospital, Seoul, Korea

⁴Department of Family Medicine, Seoul St. Mary's Hospital, The Catholic University of Korea School of Medicine, Seoul, Korea

⁵Department of Family Medicine, Eulji University School of Medicine, Daejeon, Korea

⁶Department of Family Medicine, Catholic Kwandong University International St. Mary's Hospital, Catholic Kwandong University College of Medicine, Seoul, Korea

⁷Department of Child Development and Family Studies, Institute of Human Ecology, Seoul National University, Seoul, Korea

Background

Appropriate Family function is important to maintain a sound health in individuals. Depression is one of representative disease known to be affected by family function. But, in Korea, among the parameters evaluating family function, family communication has received little attention in the depression studies. In this study, we aimed to examine whether family function, which was evaluated by two distinct parameters – family type, and family communication, is related with depressive symptoms in an individual.

Methods

From April 2009 to June 2011, 520 couples (1,040 patients) were investigated with Family Cohort Questionnaire; 697 subjects who fulfilled all of questionnaire for family function, and CES-D for depressive symptoms were included in the analysis. For family function, Circumplex model in FACE-III (family type) and FCS in FACE-IV (family communication) were used.

Results

Among the subjects, 309 (44.3%) reported depressive symptoms. In multivariate logistic regression analysis for the risk factors of depressive symptoms, which adjusted with age and other significant factors in univariate logistic regression analysis (income and AUDIT-K score for men, none for women), family-type did not reveal any significant association with depressive symptoms, whereas high-level of family communication was associated with low incidence of depressive symptoms for both men and women (OR 0.312, 95% CI 0.158-0.618 in men, OR 0.361, 95% CI 0.214-0.609 in women).

Conclusion

Low-level of family communication may be a risk factor for depressive symptoms of an individual. Evaluating family communication can be useful in assessing the depression risk.

Keywords: Depression, Circumplex model, Communication

Table 1. Basic characteristics of study subjects

Characteristics	Men (n=334)	Women (n=363)	P value
	Mean ± SD or n (%)	Mean ± SD or n (%)	
Age (y)	58.14 ± 9.949	58.66 ± 9.931	0.495
<50	59(19.1)	69(17.8)	0.874
50-59	96(31.1)	119(30.7)	
≥60	154(49.8)	200(51.5)	
BMI	24.42 ± 3.598	25.16 ± 2.801	0.063
Normal	33(30.0)	27(18.1)	0.076
Overweight	33(30.0)	49(32.9)	
Obesity	44(40.0)	73(49.0)	
Education (y)			0.208
<12	93(30.2)	96(25.0)	
12	95(30.8)	139(36.2)	
>12	120(39.0)	149(38.8)	
Monthly income (10,000 won/month)			0.018
>600	88(30.0)	77(20.4)	
400 - 600	91(31.1)	115(30.5)	
200 - 400	49(16.7)	79(21.0)	
<200	65(22.2)	106(28.1)	
Smoking			0.001
Ex-smoker/never-smoker	245(86.3)	309(86.8)	
Current smoker	39(13.7)	47(13.2)	
Alcohol	7.38 ± 7.835	6.65 ± 6.773	0.285
Normal	126(64.6)	177(68.1)	0.372
Risky	42(21.5)	58(22.3)	
Dependency	27(13.8)	25(9.6)	
Diabetes Mellitus			0.801
No	240(79.7)	300(78.9)	
Yes	61(20.3)	80(21.1)	
Hypertension			0.041
No	181(59.9)	198(52.1)	
Yes	121(40.1)	182(47.9)	
CAD			0.977
No	291(96.4)	366(96.3)	
Yes	11(3.6)	14(3.7)	
Hyperlipidemia			0.107
No	207(68.5)	238(62.6)	
Yes	95(31.5)	142(37.4)	
Stroke			0.317
No	288(95.7)	369(97.1)	
Yes	13(4.3)	11(2.9)	

Table 2. Comparison of familial function factors and health characteristics according to depressed mood

Characteristics	Male		P value	Female		P value
	Subjects with depression (n= 129)	Subjects without depression (n= 205)		Subjects with depression (n=180)	Subjects without depression (n= 183)	
Adaptability						
Rigid	30(26.3)	48(26.5)	0.930	32(21.9)	35(21.5)	0.789
Structured	35(30.7)	61(33.7)		41(28.1)	54(33.1)	
Flexible	28(24.6)	43(23.8)		35(24.0)	37(22.7)	
Chaotic	21(18.4)	29(16.0)		38(26.0)	37(22.7)	
Cohesion						
Disengaged	68(54.8)	93(47.9)	0.086	80(48.5)	75(45.7)	0.929
Separated	41(33.1)	55(28.4)		48(29.1)	48(29.3)	
Connected	11(8.9)	33(17.0)		25(15.2)	29(17.7)	
Enmeshed	4(3.2)	13(6.7)		12(7.3)	12(7.3)	
Circumplex Model						
Balanced	23(20.9)	42(23.7)	0.723	30(21.3)	40(26.7)	0.561
Mid-ranged	60(54.5)	98(55.4)		78(55.3)	77(51.3)	
Extreme	27(24.5)	37(20.9)		33(23.4)	33(22.0)	
Communication						
Low	43(35.2)	40(20.1)	0.001	55(32.9)	31(17.7)	0.001
Moderate	41(33.6)	48(24.1)		54(32.3)	46(26.3)	
High	38(31.1)	111(55.8)		58(34.7)	98(56.0)	

Table 3. Univariate logistic regression analysis of factors according to depression using CES-D score

	Male		Female	
	Crude OR OR (95% CI)	p-value	Crude OR OR (95% CI)	p-value
Age (y)				
<50	1		1	
50-59	0.668(0.332-1.343)	0.257	1.134(0.640-2.011)	0.666
≥60	0.772(0.424-1.407)	0.399	1.118(0.639-1.955)	0.697
BMI				
Normal	1		1	
Overweight	0.533(0.169-1.684)	0.284	0.561(0.242-1.301)	0.178
Obesity	0.374(0.130-1.079)	0.069	0.699(0.304-1.606)	0.399
Education (y)				
<12	1		1	
12	0.796(0.427-1.485)	0.474	0.664(0.404-1.093)	0.107
>12	0.946(0.539-1.661)	0.846	0.906(0.536-1.532)	0.713
Monthly Income(10,000 won/m)				
<200	1		1	
200-400	0.833(0.460-1.508)	0.547	0.595(0.335-1.058)	0.077
400-600	0.397(0.189-0.833)	0.015	0.654(0.349-1.225)	0.185
>600	0.510(0.270-0.962)	0.038	0.585(0.319-1.072)	0.114
Smoking				
Ex-smoker/never-smoker	1		1	
Current smoker	1.346(0.806-2.248)	0.257	1.987(0.359-11.008)	0.432
Alcohol				
Normal	1		1	
Risky	1.230(0.699-2.165)	0.472	1.081(0.442-2.642)	0.864
Dependency	2.195(1.059-4.550)	0.035	0.946(0.327-2.737)	0.918
Diabetes Mellitus				
No	1		1	
Yes	1.298(0.797-2.115)	0.294	0.787(0.424-1.459)	0.446
Hypertension				
No	1		1	
Yes	0.774(0.495-1.210)	0.262	0.784(0.508-1.209)	0.271
CAD				
No	1		1	
Yes	1.412(0.463-4.301)	0.544	0.706(0.220-2.268)	0.559
Hyperlipidemia				
No	1		1	
Yes	0.889(0.563-1.405)	0.615	0.726(0.461-1.143)	0.167
Stroke				
No	1		1	
Yes	2.951(0.846-10.295)	0.090	0.857(0.282-2.603)	0.786

Table 4. Multivariate logistic regression analysis of factors according to depression using CES-D score

Men	Crude OR OR (95% CI)	p-value	Adjusted OR ¹ OR (95% CI)	p-value
Circumplex Model				
Balanced	1		1	
Mid-ranged	0.967(0.846-10.295)	0.908	0.693(0.357-1.347)	0.279
Extreme	1.268(0.663-2.426)	0.473	0.935(0.434-2.014)	0.865
Communication				
Low	1		1	
moderate	0.736(0.411-1.318)	0.302	0.761(0.392-1.477)	0.419
High	0.296(0.169-0.517)	<0.001	0.311(0.160-0.605)	0.001
Women	Crude OR ² OR (95% CI)	p-value	Adjusted OR ² OR (95% CI)	p-value
Circumplex Model				
Balanced	1		1	
Mid-ranged	1.314(0.780-2.215)	0.305	1.299(0.770-2.192)	0.326
Extreme	1.350(0.753-2.420)	0.314	1.321(0.735-2.375)	0.353
Communication				
low	1		1	
moderate	0.701(0.399-1.231)	0.201	0.713(0.405-1.255)	0.241
high	0.361(0.214-0.609)	<0.001	0.362(0.215-0.611)	0.001

¹ Age, income, and alcohol adjusted

² Age adjusted

P-0999

The prevalence of internet addiction in eight-grade students in Canakkale, Turkey

Yusuf Haydar Ertekin¹, Aysegul Uludag¹, Murat Tekin¹, Sibel Cevizci², Erkan Melih Sahin¹

¹Department of Family Medicine, Canakkale Onsekiz Mart University, Canakkale, Turkey

²Department of Public Health, Canakkale Onsekiz Mart University, Turkey

AIM

We aimed to investigate the prevalence of internet addiction in last grade students in secondary schools.

METHOD

Three of the secondary school located in the center of Çanakkale were selected by cluster sampling method. The study was carried out with all last grade secondary school students in the sample. Turkish version of Young's Internet Addiction Scale(YAS) was administered to students. Addiction levels was classified as "non-addiction", "possible addiction" and "addiction".

RESULTS are in Table 1.

CONCLUSION

Internet addiction of students in the eighth grade is not as high as expected. We suspect that internet addiction was to be shifted to smartphone addiction which can access to the internet.

Keywords: Internet Addiction, Prevalence, Adolescent

Table 1. Internet addiction prevalence

	Male (n= 137)	Female (n= 120)	Total (n=257)	p
Average age	13 ± 1	13 ± 1	13 ± 1	
YAS score	29.3 ± 20	26.5 ± 17	28 ± 19	0.255
ADDICTION LEVEL				
.....1. Non-addiction	82% (n=113)	91% (n=109)	86% (n=222)	0.068
.....2. Possible addiction	17% (n=23)	8% (n=10)	13% (n=33)	0.061
.....3. Addiction	1% (n=1)	1% (n=1)	1% (n=2)	

P-1000

pain management and follow in primary care: do we resolve?

Izaskun Odriozola, Junec Gonzalez, Nerea De Sousa, Flor Insua, Pedro Iturrioz, Enrique Perez De Ayala
Basque Health Service

Background & AIM:

- Know characteristics of pain and its management in Primary Care (PC).
- Assess treatment and the degree of resolution of pain in this area.

Design: Cross sectional study with follow-up.

Setting: Patients attending consultations with pain in 3 health centers PC for a month in the Gipuzkoa province (Basque Country): Irun Centre, Irun Dumboa and Beraún.

METHOD: We used convenience sampling. Inclusion criteria were being ≥ 14 years and presenting acute or chronic pain (≥ 3 months). Exclusion criteria were patients who refused to cooperate, or who had cancer pain moderate-severe cognitive impairment with communication difficulties.

Information was collected on demographics (name, age, sex and employment activity), clinical data (reason for consultation, duration, type, location, etiology and pain intensity (measured by Oral Scale Analog Pain (OSAP)), therapeutic data (type of treatment, type of pharmacological treatment prescribed pain scale according to WHO and whether or not the bypass) and monitoring data (resolution of pain with VAS, side effects and overall patient satisfaction).

Monitoring is conducted through a telephone interview at 15 days of inclusion in the study. Were considered missing follow-up study of patients who have not responded to 3 phone calls.

RESULTS: Initially 87 patients, of whom 68 were followed (78.2%) were included.

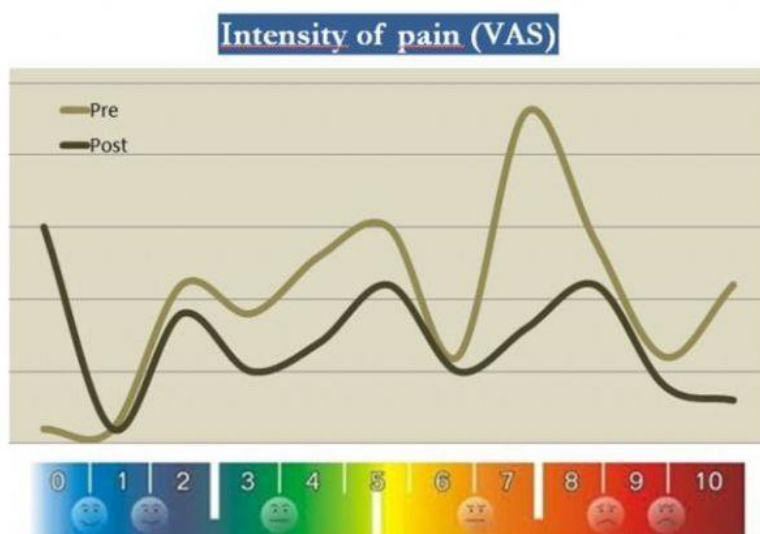
- The average age was 57 years, most women (63-/72%) and inactive occupationally (54/62%).
- The pain was assessed with OSAP ≥ 7 (46/87,49%). After 15 days of treatment, remained in that range OSAP (22/68,32%). The impact of the intervention has reduced pain intensity by 17% and resolved 20.5%.
- Side effects were presented (11/68,16%), usually digestive.
- Overall satisfaction is positive in (62/68,91%), being excellent in (17/68,25%).

CONCLUSIONS:

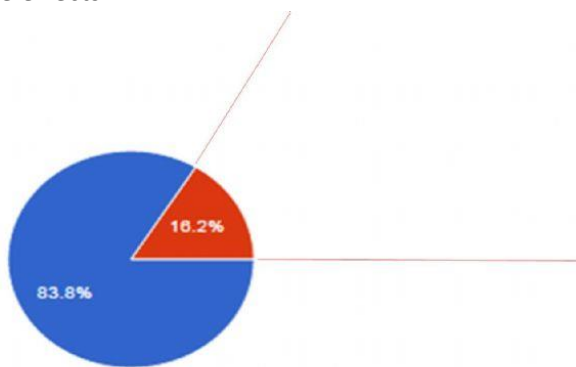
- The majority of patients who started treatment has positive results with few side effects.
- The PC is operative in pain management.

Keywords: pain, management, primary care, follow-up

Intensity of pain (VAS)

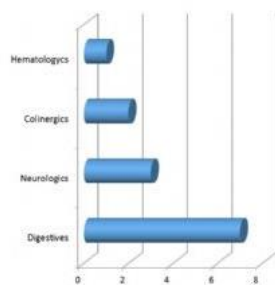


Side effects



Side effects

Side effects



Satisfaction with the treatment



P-1001

Colorektalcancer patients pathway from symptoms to diagnosis in northern Sweden

Catharina Ingvarsson, Mikael Lilja

Department of public health and clinical medicine, family medicine Umeå university

BACKGROUND: Colorectal cancer (CRC) is the third most common cancer in Sweden. Primary care is often the first instance for patients with onset of cancer. A delayed diagnosis may affect disease prognosis. Few studies describe delay of cancer diagnosis linked to rural living or psychosocial situation.

AIM: To describe delay in the diagnosis of CRC.

Questions: Is time from the first visit in primary care to diagnosis affected by rural living, the patient's age, gender, or co-morbidity, in the year ahead of diagnosis?

METHODS: Two years retrospective analysis of medical records for all patients (n = 498) with CRC 2012 in three sparsely populated counties in northern Sweden, (together 600,000 inhabitants and 7 hospital at an area equal to Greece). The patients distance to the nearest hospital (≤ 30 km, 31-100 km, > 100 km) calculated with Google maps was used as a proxy for rural living. Patients were age grouped (≤ 60 , 61-70, 71-80 and > 80 years), and ASA groups were used to describe co-morbidity, comparing ASA 1 (healthy) to ASA 2-5. Median analyzes was used for the statistics.

RESULTS: 75% of all patients with CRC first attended primary healthcare. 81% of those were referred to hospital after one or two visits with a median time of 15 days. The median time from first visit in primary care to clinical diagnosis was for men and women 43 and 61 days respectively ($p = 0.005$). For ASA groups, age groups or for rural living, no difference in time to clinical diagnosis was seen.

CONCLUSION: Our results show that female sex, but not rural living is linked to a delayed CRC diagnosis. Further analysis of the collected data is ongoing.

Keywords: delayed diagnosis, rural health, colorectal neoplasms

P-1002

Prevalence and predictors of poor compliance among hypertensive patients attending government primary health care centre in Sarawak, Malaysia

Sally Suriani Ahip¹, Rawa Bau², Juslina Omar³, Maila Mustapha⁴, Lenny Martini Hamden⁵, Jennet Michael⁶, Maurice Steve Utap⁷, Ziti Akhtar⁸, Norhasimah Ismail⁹, Sie Zin Kong¹⁰, Mohd Irfan Yasin¹¹, Yeow Siong Lee¹²

¹Kota Sentosa Health Clinic, Kuching, Sarawak, Malaysia

²Bintulu Health Clinic, Bintulu, Sarawak, Malaysia

³Petrajaya Health Clinic, Kuching, Sarawak, Malaysia

⁴Jalan Masjid Health Clinic, Kuching, Sarawak, Malaysia

⁵Batu Kawa Health Clinic, Kuching, Sarawak, Malaysia

⁶Tanah Puteh Health Clinic, Kuching, Sarawak, Malaysia

⁷Tudan Health Clinic, Miri, Sarawak

⁸Miri City Health Clinic, Miri, Sarawak

⁹Lawas Health Clinic, Sarawak

¹⁰Sarikei Health Clinic, Sarikei, Sarawak

¹¹Kota Samarahan Health Clinic, Samarahan, Sarawak

¹²Sri Aman health clinic, Sri Aman, Sarawak

Background. Compliance to medications is an important issue when managing chronic illnesses. Patient noncompliance may contribute to poor blood pressure control

OBJECTIVES: To determine the prevalence of compliance among treated hypertensive patients in Sarawak, and its association with their sociodemographic and medical characteristics.

METHODS: This is a cross sectional study done in government primary health care clinics in Sarawak involving 25 Health Clinics with doctors and 10 Outpatient Departments in the district hospitals. Systematic random sampling was used. Hypertensive patients' socio demographics, medical data and physical examination findings were recorded. Their compliance to medication was assessed using Morisky Medications Adherence Scale Bahasa Melayu Version (MMAS-BM).

RESULTS: 2289 respondents were involved with mean age of 56.2±11.3 years.

Majority were females (65.9%), predominantly Iban ethnicity (43.1%). and completed secondary education (42.2%). Almost half were housewives (40%) and majority had household income below RM2000 (76.3%). Half respondents stayed in the rural areas, 79.2% come to clinic using their own transportation taking less than 20 minutes to reach (60%) and spent less than RM 10 for the journey. More than half of the respondents do not exercise (56.2%), 15% are smokers and 14.7% consume alcohol at least once a month. Forty-two percent had hypertension ≤5 years, 1/3 had diabetes, 55.4% had dyslipidaemia and 4.1% has IHD.

Difficult transportations to clinics, smokers, alcohol consumption and dependence on supervised medication intake were predictors of poor compliance. Presence of other concomitant diseases including diabetes, and regular exercise are predictors of good compliance.

CONCLUSION: Prevalence of poor compliance among treated hypertensive outpatient in Sarawak is 29.3%. Predictors for poor compliance were difficult transportation, smokers, alcohol consumption and dependence on others for supervised medication, while predictors for good compliance are presence of other concomitant diseases, suffering from more diseases and regular exercise.

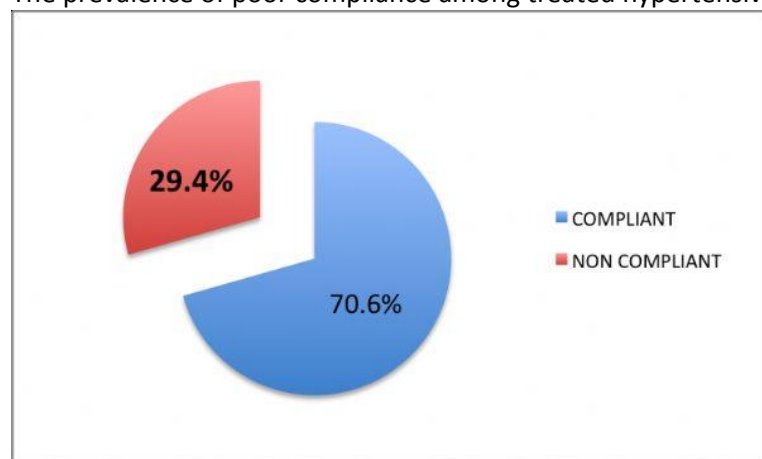
Keywords: hypertension sarawak malaysia, compliance to medication, compliance to primary healthcare

Study sites throughout Sarawak state, Malaysia



Location of 35 government primary health care clinics involved in this study

The prevalence of poor compliance among treated hypertensive patients



The prevalence of poor compliance among treated hypertensive patients in the primary health care clinics was 29.4%.

Univariable analysis of factors related to non-compliance

Variables	Odds ratio	95% CI	p-value
BMI	1		
Normal	1.29	1.00-1.67	0.05
Overweight/obesity			
Age			
18-39			0.07
≥ 40- 59			
≥ 60			
Gender	1		
Male	1.22	1.02-1.47	0.03
Female			
Occupation	1		
Government	0.88	0.66-1.16	0.36
Non-government	0.77	0.60-0.99	0.04
Unemployed			
Education			0.18
No formal education			

Primary				
Secondary				
Teritiary				
Income	1			
<400				
≥ 400-999	1.39	1.01- 1.90	0.04	
≥1000- 1999				
Transportation				
Own				0.12
Bicycle/ walking				
Boats				
Smoking	1			
No	1.63	1.20-2.23	0.00	
Yes				
Alcohol	1			
No	1.57	1.14-2.17	0.01	
≤ 1 month	2.69	1.69- 4.26	0.00	
≥ 2/ month				
Exercise	1			
No exercise	0.66	0.54-0.81	0.00	
≥ 30 mins				
Duration of hypertension				
≤ 10 years				0.50
11-20 years				
Antihypertensives				
Calcium channel blocker	1.22	1.10- 1.47	0.04	
alpha blocker	2.75	1.14 - 5.63	0.02	

High BMI, female gender, higher income, smoking, alcohol consumption and treatment with calcium channel blockers and alpha blockers were found significantly associated with poor compliance. Exercise, longer duration of hypertension, and unemployment were factors significantly associated with good compliance.

Multivariable regression analysis for factors affecting non-compliance

Variable	Odd's Ratio	95% CI	p-value
Alcohol	1		
Nil	1.52	1.07-2.16	0.01
≤ 1/month	2.28	1.30-4.00	0.04
≥ 2/month			
Exercise	1		
Nil	0.79	0.62-1.00	0.05
>30 minutes			
Duration of HPT	1		
<10 years	0.61	0.39-0.96	0.03
≥10-20 years	0.46	0.25-0.86	0.01
≥ 20 years			
Transport	1		
Own	2.1	1.13-3.95	0.02
Boats			

Multivariable analysis found that alcohol consumption, and difficult transportation were significant independent predictors of poor compliance to treatment while exercise and longer duration of hypertension were significant independent factors of good compliance among treated hypertensives in Sarawak.

P-1003

Skin disorders in Croatian Primary Health Care: a longitudinal study, 1995-2013

Vesna Tabak¹, Branka Zivkovic Duvnjak², Damir Tabak³

¹Vesna Tabak, Family Practice „Dr. Vesna Tabak“, Zagreb, Croatia

²Branka Zivkovic, Family Practice „Dr. Branka Zivkovic-Duvnjak“, Silba, Zadar, Croatia

³Damir Tabak, University of Zagreb, School of Medicine, Zagreb, Croatia

Background & aims

The evidence usually showed that around 50% of people reported a skin problem in the preceding 12 months and with around a quarter of them considered worthy of medical care. In Croatia, there are almost no studies investigating the skin problems seen in primary health care (PHC), especially no longitudinal studies. The main aim of this study was to investigate nineteen-years trends in skin disorders registered in Croatian PHC.

Methods

The study is observational and retrospective, based on routinely collected data from PHC, yearly published in the Croatian Health Service Yearbooks, 1995 - 2013. The morbidity data were registered based on the International Disease Classification, version X, for skin disorders labelled as L00-L99. Recorded diagnoses are shown in the leading categories of diseases and only some are shown separately. Morbidity is registered according to the patient's age group: 0-6 years, 7-19 years, 20-64 years and 65+ years.

Results

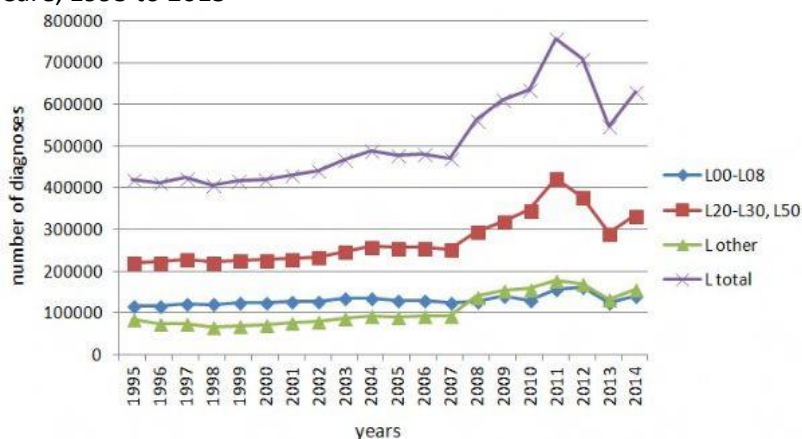
During the observed period, skin diagnoses registered in PHC increased in two-folds, from 420.293 diagnoses in 1995 to 757.832 diagnoses registered in 2011 when it was the highest. The skin disorders increased mostly among elderly people. The increase is especially sharp after 2008 when e-medical records and registration was introduced. The less increase is observed in skin infections, even decreased among pre-school children is found, than diagnoses of dermatitis, increase is found again mostly among elderly. The disorders labelled as others increased mostly, and among elderly for a more than three times. At the same time, the number of dermatological consultations (need referrals) increased in 2.3 times.

Conclusions

The skin disorders registered in Croatian FP show increased trend, but the number of the dermatological consultations increased even more. The question is whether the PHC doctors are educated and equipped to face a problem of skin disorders.

Keywords: Skin disorders, Primary Health Care, longitudinal study, Croatia

Fig. 1. Morbidity trends of skin disorders (total and disease categories) registered in Croatian primary Health Care, 1995 to 2013



Legend: L00-L08: skin infections; L20-L30, L50: dermatitis, urticaria; L: others; L: TOTAL

Fig. 2. Morbidity trends of skin disorders registered in Croatian primary Health Care in relations to the patients age, 1995 to 2013

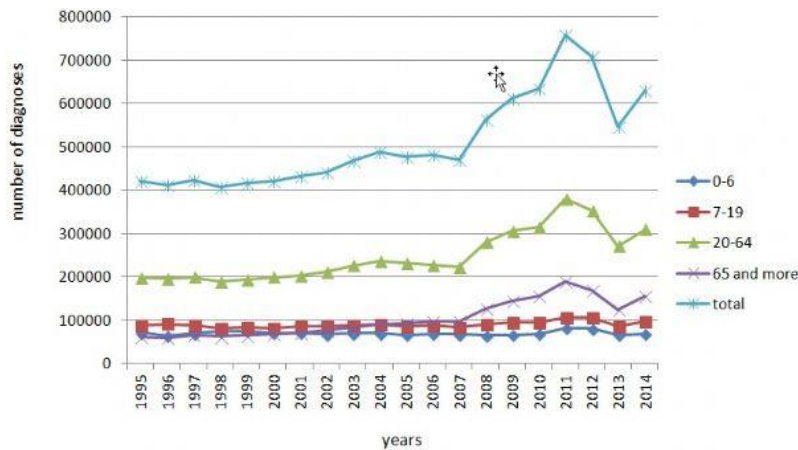
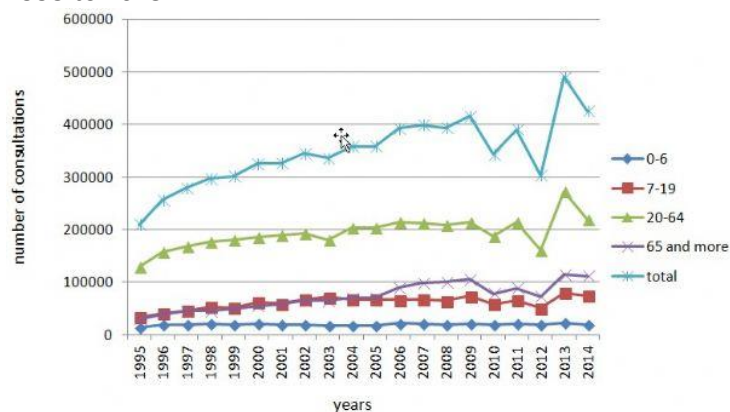


Fig. 3. Trends in the number of consultations by the dermatologists in relationship to the patients age in Croatia, 1995 to 2013



P-1004

Randomized, Placebo-Controlled, Double-Blind, Multi-Center, Clinical Study to Evaluate the Efficacy of Zerex in

Female Young Adult with Fatigue

Whan Seok Choi, Na Eun Choi, Sang Ah Youn, Sun Myeong Ock, Jun Seung Rho, Churl Min Kim

Department of Familymedicine, The Catholic University of Korea

BACKGROUND: The purpose of this study was to evaluate the effect and the safety of Zerex(was mainly composed Seanol) treatment for 4 weeks on fatigue in female young adults.

METHODS: This was a 4-week parallel-group, double-blind, randomized, placebo-controlled trial. This was a 4-week trial consisting of 3 visits. A total of 87 participants were randomized to either Zerex (n=58) group or the placebo group (n=29). Subjects were administered with 3 capsules of Zerex or placebo 3 times a day. FSS(fatigue severity scale), concentration scale (reading and listening) were measured at baseline (visit 2) and at 4-week (visit 3).

RESULT: In Zerex group, mean change of FSS at the end of 4 week compared to baseline period decreased by 1.05 ± 1.10 , in placebo group, whose mean change decreased by 1.17 ± 0.98 . No statistically significant difference was observed between Zerex group and placebo group. In secondary efficacy variable, concentration scale (reading and listening), significant reduction was observed. In Zerex group, mean change of concentration scale at the end of 4 week compared to baseline period decreased by 0.48 ± 0.67 , in placebo group, whose mean change decreased by 0.16 ± 0.60 .(Wilcoxon rank sum test; $p=0.0141$) No adverse event was reported in either group.

CONCLUSION: In female young adults, 4-week treatment with Zerex 9 capsules a day was associated with the improvement of concentration (based on increase in concentration scale). Zerex demonstrated an acceptable safety profile and was generally well tolerated.

Keywords: Seanol, Ecllonia cava, Fatigue, Fatigue severity scale

P-1005

The Effect of Relaxation Training Program on Autonomic Nervous System

Whan Seok Choi, Kyoung Rak Kim, Sang Ah Youn, Churl Min Kim
Department of Family Medicine, The Catholic University of Korea

BACKGROUND: In modern society, stress is one of the most significant problems affecting physical as well as mental health. Long-term exposure to severe stress results in an imbalance of autonomic nervous system and develops various mental and physical diseases. In recent, various stress managements have been identified and they are commonly including relaxation components. The purpose of this study was to investigate the effect of relaxation training program invented by authors on autonomic nervous system.

METHODS: We investigated 21 adult patients with decreased autonomic function (RMSSD value under 20ms). Subjects were randomized into two groups, Receiving (1) Relaxation training program or (2) Relaxation training program except relaxation component (control); twice a day for two weeks. The values of Heart rate variability, Perceived Stress Scale, Beck Depression Inventory, Blood pressure were assessed before, at the end of the two-week training. Data were analyzed using t-test for subject homogeneity verification and paired t-test to examine the hypotheses.

RESULTS: After training, the experimental group had significantly higher values for SDNN ($P=0.036$), RMSSD ($P=0.031$), TP ($P=0.042$), and HF ($P=0.048$) compared to the control group. Both training group and control group showed decrease after 2 week training in Perceived Stress Scale, Beck Depression Inventory which was not significant. Both training group and control group showed decrease after 2 week training in Blood pressure, only systolic blood pressure ($P=0.047$) was significant.

CONCLUSIONS: We found the relaxation training program improved overall autonomic function and induced sympathovagal balance towards parasympathetic activity. Therefore we suggest the relaxation training program invented by authors is useful tool for stress management.

Keywords: Stress, Relaxation training program, Autonomic nervous system, Heart rate variability, HRV

P-1006

Labour productivity loss because of Irritable Bowel Syndrome complaints

Carla E Flik¹, Wijnand Laan¹, André Pm Smout², Niek J De Wit¹

¹Julius Centre for Health Sciences and Primary Care, University Medical Centre, Utrecht, the Netherlands

²Department of Gastroenterology and Hepatology, Academic Medical Centre, Amsterdam, the Netherlands

Introduction

When calculating indirect costs for IBS most researchers only take the costs for loss of labour days into account.

Aim

To report the combined number of sick leave days and the loss of efficiency during the days IBS patients did work.

Method

207 adult IBS- patients, meeting Rome III criteria were selected. The impact of IBS on absenteeism from work < two weeks and > than two weeks, if one was hindered by IBS complaints when working in the past two weeks and how efficient one has worked, was measured.

Results

Of the 140 working IBS patients, 19 (18.2%) of 104 female were absent from work because of IBS complaints, 10 (9.6%) < two weeks, 9 (8.7%) > two weeks; of the 36 male IBS patients 5 (13.9%) were absent from work because of IBS complaints, 3 (8.3%) < two weeks, 2 (5.6%) > two weeks. In 20% of the female and 7% of the male patients, IBS complaints had no impact on their labour productivity, respectively 64% and 23% were hindered to some extent and 16% of women and 23% of men were hindered very much; 33.3% of women and 52.8% of men worked

less efficient than normal because of their IBS complaints.

Conclusions

IBS complaints do not only result in substantial absenteeism from work, but also in severe loss of efficiency among those IBS patients who do not report sick, but continue working. When quantifying disease-related loss of labour productivity both aspects should be taken into account.

Keywords: Irritable Bowel Syndrome, Labour productivity, Costs

Table 1. Work absenteeism for women and men with IBS per IBS severity score

IBS-severity score	Women				Men			
	No absenteeism	Absent < two weeks	Absent > two weeks	Total	No absenteeism	Absent < two weeks	Absent > two weeks	Total
Remission	1 (1%)	0 (0%)	0 (0%)	1 (1%)	0 (0%)	0 (0%)	0 (0%)	0 (0%)
Mild	4 (5%)	0 (0%)	0 (0%)	4 (4%)	2 (7%)	0 (0%)	0 (0%)	2 (6%)
Moderate	41 (48%)	7 (70%)	4 (44%)	52 (50%)	21 (68%)	1 (33%)	0 (0%)	22 (61%)
Severe	39 (46%)	3 (30%)	5 (56%)	47 (45%)	8 (26%)	2 (67%)	2 (100%)	12 (33%)
Total	85 (100%)	10 (100%)	9 (100%)	104 (100%)	31 (100%)	3 (100%)	2 (100%)	36 (100%)

Table 2. Work absenteeism for women and men per different types of IBS

IBS-type	Women				Men			
	No absenteeism	Absent < two weeks	Absent > two weeks	Total	No absenteeism	Absent < two weeks	Absent > two weeks	Total
Constipation	17 (21%)	2 (22%)	0 (0%)	19 (19%)	2 (8%)	0 (0%)	0 (0%)	2 (6%)
Diarrhea	21 (26%)	2 (22%)	1 (12%)	24 (24%)	7 (27%)	1 (25%)	1 (50%)	9 (28%)
Mixed	44 (54%)	5 (56%)	7 (88%)	56 (57%)	17 (65%)	3 (75%)	1 (50%)	21 (66%)
Total	82 (100%)	9 (100%)	8 (100%)	99 (100%)	26 (100%)	4 (100%)	2 (100%)	32 (100%)

Table 3. Impact on labour productivity of women and men with IBS

Impact	Women	Men	Total
No, not at all	20 (20%)	7 (19%)	27 (20%)
Yes, somewhat	64 (64%)	23 (62%)	87 (64%)
Yes, considerably	16 (16%)	7 (19%)	23 (17%)
Total	100 (100%)	37 (100%)	137 (100%)

P-1007

Severity of symptoms and psychological factors as predictors of quality of life of patients with Irritable Bowel Syndrome

Carla E Flik¹, Wijnand Laan¹, André Pm Smout², Niek J De Wit¹

¹Julius Centre, Health Sciences and Primary Care, University Medical Centre, Utrecht, the Netherlands

²Department of Gastroenterology and Hepatology, Academic Medical Centre, Amsterdam, the Netherlands

Introduction

The relative impact of psychological distress and severity of abdominal symptoms on health related quality of life (HRQOL) and their interaction is important to focus IBS treatment.

Aim

To investigate the impact of symptom severity and the psychological variables anxiety, depression and somatization on HRQOL in patients with IBS.

Methods

A total of 207 adult patients, meeting Rome III criteria for IBS, recruited in primary and secondary care, were analyzed. Severity of symptoms (IBS-SSS), anxiety, depression, somatization and overall psychoneuroticism (Symptom Checklist (SCL-90)) and health related quality of life (IBS-Qol, ranging from 0-100) were measured and analyzed using linear regression models.

Results

Results of 193 (93%) patients were available for analysis. Symptom severity accounted for 20% of the Qol overall score; 38% of the variation in IBS-Qol was explained by the SCL-90 overall score. The higher the scores, the higher the impact. For the subscales anxiety, depression and somatization these figures were 26%, 30% and 22%, respectively. Combined they accounted for 50% of the variance in IBS-Qol.

Conclusions

Patients with more severe IBS symptoms experience more impact on their quality of life. The same applies to increasing psychological problems, with the highest impact of depression. The overall impact of psychological factors on HRQOL is stronger than that of symptom severity.

As both symptom severity and psychological variables are independent contributors to quality of life in IBS, both factors should be addressed in treatment.

Keywords: Irritable Bowel Syndrome, Quality of life, Severity of symptoms, Predictors

P-1008

The association of blood lead level and high-density lipoprotein is modified by Metallothionein 2A polymorphisms, rs10636 GC and rs28366003 AA genetic combination

Chen Cheng Yang¹, Chen Cheng Yang², Chen Cheng Yang³, Hung Yi Chuang³, Hung Yi Chuang⁴

¹Department of Family Medicine, Kaohsiung Municipal Cijin Hospital, Kaohsiung, Taiwan

²Community Health Promotion Center, Kaohsiung Municipal Cijin Hospital, Kaohsiung, Taiwan

³Department of Family Medicine, Kaohsiung Medical University Hospital, Kaohsiung, Taiwan

⁴Department of Public Health, Kaohsiung Medical University, Kaohsiung, Taiwan

Background and Aim

Lead is broadly concerned issue in worldwide. It causes damages of multiple organs and has certain influence on lipid metabolism. Metallothioneins(MTs) are low molecular weight, cysteine rich, metal binding proteins, which play important role on metal detoxification. MT2A gene, one of common expressive MTs gene, has effect on lead metabolism, but rare studies about the associations between MT2A polymorphisms and lipid metabolism in occupational lead exposure. Therefore, our purpose is to investigate the association of blood lead level and lipid profile in chronic lead exposed participants, and whether the association is influenced by the polymorphisms of MT2A gene.

Methods

We recruited 677 participants after informed consents were obtained. All the samples were collected and analyzed for lipid biomarkers, blood lead levels, genotyping of MT2A polymorphisms and liver function tests, including alanine aminotransferase (ALT) and aspartate aminotransferase (AST). Moreover, a short questionnaire inquiring about medical history, alcohol drinking and cigarette consumption of the subjects was part of the examination. The data was dealt with IBM-SPSS version 19 statistical software for descriptive analyses and linear regression model.

Results

The investigation revealed lead toxicity had effects on Low-Density Lipoprotein (LDL) increasing and High-Density Lipoprotein (HDL) decreasing by general linear model, predicted by blood lead, MT2A combination and other potential factors. Meanwhile, the rs10636 GC * rs28366003 AA genetic combination had a protective influence on HDL, even under lead exposure.

Conclusion

In conclusion, the association of blood lead level and HDL is modified by Metallothionein 2A genetic combination. That is rs10636 GC and rs28366003 AA genetic combination in MT2A SNPs play a protective role on HDL, although lead toxicity has a harmful effect on HDL in human being.

Keywords: Metallothionein, lead, lipid biomarker

P-1009

Differences in omentin levels between healthy overweight people with and without signs of fatty liver

Vija Silina¹, Mesfin Kassaye Tessma³, Peteris Tretjakovs⁴, Gita Krievina⁵, Julija Snaidere², Guntis Bahs⁶

¹Riga Stradins University, Department of Family Medicine, Riga, Latvia

²Family physician's private practice, Riga, Latvia

³Department of Learning, Informatics, Management and Ethics, Stocholm, Sweden

⁴Riga Stradins University, Department of Human Physiology and Biochemistry, Riga, Latvia

⁵Latvia University, Institute of Experimental and Clinical Medicine, Riga, Latvia

⁶Riga Stradins University, Department of Internal Diseases, Riga, Latvia

BACKGROUND: It is essential for a family physician to select people who would need immediate lifestyle changes to prevent a disease. There is evidence that fatty liver and omentin is related to cardiovascular diseases risks, however, there is still a gap of knowledge regarding omentin as an early marker of increased risk of hepatic steatosis and cardiovascular disease.

AIM: To find out if there is a difference between omentin levels in people with and without hepatic steatosis

METHODS: A trans-sectional study in Riga, Latvia included 92 clinically healthy individuals having body mass index (BMI) above 25 m²/kg and below 40 m²/kg and in age group 30-45 that visited primary care physician. Individuals underwent CT scan for signs of hepatic steatosis and were divided in two groups: individuals with and without any signs of fatty liver. All individuals were tested for omentin levels using enzyme-linked immunosorbent assay (ELISA) test. Independent samples t test was employed to compare the means of the two groups.

RESULTS: We observed that individuals with no signs of fatty liver had higher omentin levels (124,6±74,5 ng/ml; n=56) than those having signs of fatty liver (99,3±51,9 ng/ml; n=36). This difference (25,4±13,2 ng/ml, 95% CI [0,085, 51,62] was not significant t(89,3)=1,92; p=0,058.

CONCLUSIONS: For individuals residing in Riga, Latvia presence of omentin level alone cannot be considered as an indicator of fatty liver and its related cardiovascular diseases risk. More research has to be done to find out more precise indicators.

""The grant 2014.10-4/VPP-5/16 BIOMEDICINE of the framework of the Latvian National Program""

Keywords: omentin, fatty liver, overweight

P-1010

Palliative & End of Life Care

Iva Lopes¹, Filipa Faria², Ana Catarina Pires³, Ana Luisa Pires³, Joana Leça⁴

¹UCSP de Macedo de Cavaleiros

²UCSP de Mirandela II

³UCSP Santa Maria II - Bragança

⁴USF Terras do Ave

BACKGROUND & AIM: The aging population and the provision of end of life care is being a challenge for the family physicians. The purpose of this research is to understand the reality of referrals to a Palliative Care Unit in the north of Portugal, to evaluate the ability to receive patients and their families and also assess the use of ambulatory structures to help patients in palliative phase.

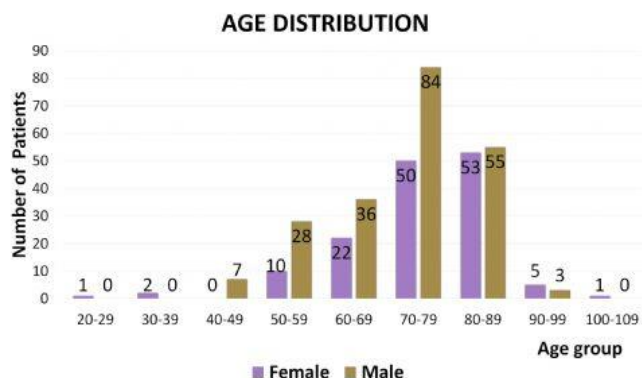
METHOD: Observational, descriptive and retrospective study involving a sample of patients of a Palliative Care Unit, admitted between January 2010 and June 2014. Data collection was conducted in August 2014 by SClinico[®] and treating data carried via Microsoft Excel 2013[®].

RESULTS: 357 patients were included, 60% of whom were male. The average age was 73 years, and the average hospitalisation time was 32 days. It was found that 97% of the diagnoses were oncological, and the most common cancers were lung and gastric. On admission, the majority of patients had a Palliative Performance Scale of 30%. The majority of the referrals (87%) were made by a hospital service. Although half of the patients referred through the Primary Health Care, had had prior home clinical assistance by teams of palliative care. The vast majority (89%) of admissions resulted in hospital death, but in the other cases (11%) it was possible to discharge patients. From these, 48% were able to return home, and the rest were sent to nursing homes and other types of institutions.

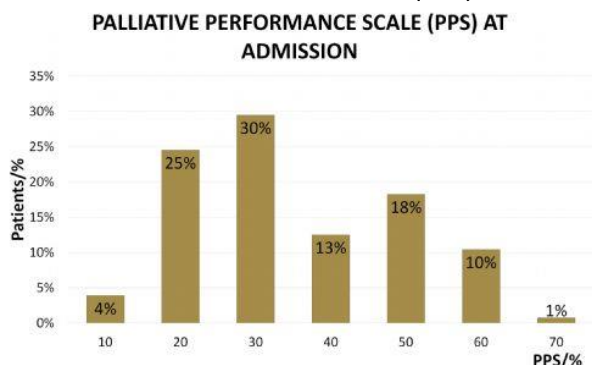
CONCLUSIONS: There is solid evidence that the involvement of family doctors in palliative care is an important factor to allow death at home, the preferred location for most Europeans.. It becomes imperative to invest in medical training and provide resources for the family physicians to be able to offer quality care at the end of life to their patients.

Keywords: Palliative Care, Primary Palliative Care, Death

AGE DISTRIBUTION



PALLIATIVE PERFORMANCE SCALE (PPS) AT ADMISSION



P-1011

"Contraceptive methods used by 40 years and older women who applied Haseki Training and Research Hospital, Family Planning Unit"

Nazmiye Mehtap Hatunkız, Seçil Arıca

Department of Family Medicine, Haseki Training and Research Hospital, Istanbul, Turkey

Background & AIM: 40 years and older women's pregnancy rates decreased on with age. But these women fertilities continue. For this they need to use contraceptive methods. We try to detect usage frequency and continuing rate of several contraceptive methods chosen by 40 years and older women.

METHOD: A total of 398 40 years and older women who applied to family planning unit of our hospital for contraception in between January 2014 and December 2014 were analyzed retrospectively. We scanned that these women's age, education level, number of pregnancies, abortions, how the results the last pregnancy, recent pregnancy intervals those performed on an outpatient admission.

RESULTS: Mean age of the women was $44,1 \pm 3,4$. Women's age was maximum 53. The most common used contraceptive methods were copper IUD (%53,8) and condom (%14,8). Koitus interruptus was %13, Depo medroxyprogesterone acetate (DMPA) was %12,5. The highest continuation rate was for DMPA. Five of women didn't use any contraceptive methods. The average duration of last used method was $4,5 \pm 3,9$ years. The most common cause of outpatient visits were control of IUD (41.3 %) Maximum continuous DMPA (87.8 %) and the IUD (78.7 %), respectively.

CONCLUSION: To be protected from unwanted pregnancies of women 40 years and older period is a period in which they need to appropriate and effective contraceptive method. Women in this particular period, should receive counseling help from a health professional can assess the benefits and risks associated with that method when selecting available contraceptive methods.

Barrier contraception and IUD are suggested method for 40 years and older women %79,4 of these women applying family planning unit of our hospital had chosen these methods. There is needed to further studies investigating the factors influence on the preparation of contraceptive methods of 40 years and older women.

Keywords: 40 years and older women, contraception

The demographic and reproductive characteristics of women and contraceptive methods used by the women

Age Avg. \pm SD (min-max)		44,1 \pm 3,4 (40-53)
Education level	No	50 (%12,6)
	Primary	270 (%67,8)
	Secondary	54 (%13,6)
	Universities-Master	24 (%6,0)
Total number of pregnancies Avg. \pm SD (min-max)		4,3 \pm 2,0 (1-13)
Number of births Avg. \pm SD (min-max)		3,1 \pm 1, (0-116)
Number of living children Avg. \pm SD (min-max)		2,9 \pm 1,5 (0-10)
Last pregnancy interval (years) Avg. \pm SD (min-max)	0	284 (%71,7)
	1	70 (%17,7)
	2	26 (%6,6)
	3	13 (%3,3)
	4 +	3 (%0,8)
	Abortion Avg. \pm SD (min-max)	
Curettage	0	226 (%57,1)
	1	94 (%23,7)
	2	40 (%10,1)
	3	25 (%6,3)
	4 +	11 (%2,8)
How had resulted last pregnancy	Natural Birth	215 (%54,8)
	Caesarean section	54 (%13,8)

	Curettage	99 (%25,3)
	Abortion	24 (%6,1)
The contraceptive method last used	copper IUD	211(%53,8)
	condom	58(%14,8)
	coitus interruptus	51(%13)
	DMPA	49(12,5)
	combined oral contraceptives	8(%2)
	levonergestrel IUD	7(%1,8)
	no	5(%1,3)
	tubal ligation	1(%0,3)
	monthly injections	1(%0,3)
	spermisid	1(%0,3)

P-1012

Level of Knowledge Regarding Insulin Therapy and Factors that Hinder Insulin Usage in Diabetic Patients

Ahmet Yilmaz¹, Faruk Kılınc², Abdullah Cim³, Muharrem Ak⁴

¹Dicle University Medicine Faculty Departments of Family Medicine

²Dicle University Medicine Faculty Departments of Endocrinology

³Dicle University Medicine Faculty Department of Genetics

⁴Zirve University Medicine Faculty Departments of Family Medicine

Diabetes Mellitus (DM) is a metabolic disorder characterized by insulin insensitivity and insulin resistance resulting in ineffectiveness and inefficiency of insulin in tissues. At this stage, the patients, whose HbA1C level is above 7.4, need to use insulin to achieve the blood glucose level indicated by American Diabetes Association. However, some patients may express reluctance or resistance to use insulin, and the treatment may be interrupted. We aimed to determine the factors that hinder the use of insulin in diabetic patients. A survey, consist of two sections, was performed based on theoretical knowledge about DM and insulin treatment. Totally 94 patients were participated to this survey whose HbA1c level was $\geq 7.4\%$. The sociodemographic features including age, gender, occupation, address and education level were registered. The data were analysed and frequencies were calculated using SPSS 18.0 Chi square and Spearman correlation tests were used, and P values and 95% confidence interval were calculated. $P < 0.05$ was accepted statistically significant. The mean age of the patients was $50,41 \pm 11,42$. The ratio of patients who believe the insulin usage worsen the disease was 19.2%, and who do not believe this idea was 33%. The 59.6% of the patients expressed that their religious beliefs were not against the use of insulin, and these patients also thought that it was a useful drug for DM treatment. Discussion It was observed that the patients, who do not use insulin (although they have to use it), did not have sufficient information on the effects of drugs. When we consider the mortality and morbidity of the DM, patients and their relatives must be provided sufficient information and guidance on the treatment of the disease by the health centre workers or the associated higher administrative authorities. If necessary, the use of insulin must be emphasized and the patients' blood glucose must be regulated

Keywords: insulin, therapy, patient barriers

Patients' responses to questions regarding insulin treatment

	n	%	n	%	n	%	p
1-Insulin prevents the complications of diabetes	37	28.7	46	48.9	21	22.3	0.004
2-Insulin injection is a painful process	31	23.6	37	38.4	26	27.7	0.179
3-Insulin is usually prescribed as a last option in the treatment	54	37.4	31	32.8	8	8.5	<0.001
4-Insulin worsens the diabetes	18	13.7	35	37.1	31	32.6	0.003
5-The dose of insulin has to be increased once you begin to use it	17	12.7	58	59.8	21	22.3	<0.0001
6-I do not use insulin due to my religious belief	3	2.2	35	37.2	56	59.6	<0.0001
7-The self-injection of insulin is difficult	37	28.6	34	36.2	33	35.1	0.623
8-If you start to use insulin you have to continue to use it	29	21.8	46	48.9	19	20.2	0.003
9-I do not have any relatives to inject insulin whenever I need to use it	34	27.6	21	22.3	47	50.6	0.002
10-Insulin leads to gain weight	18	13.7	58	61.2	27	28.6	<0.0001
11-Insulin lowers the blood glucose level too much	32	24.1	48	51.1	14	14.9	<0.0001
12-Doctors did not convince me of the necessity for using insulin	15	11.3	30	31.9	45	47.6	<0.001

table

Sociodemographic Features	N	%
Gender		
Male	40	42.6
Female	54	57.4
Education Status		
Illiterate	28	29.8
Primary	25	26.6
Secondary	12	12.8
High	14	14.9
University	15	16.0
Marital Status		
Married	82	87.2
Single	6	6.4
Divorced	6	6
Localization		
Center of City	71	75.5
Country	16	17
Village	7	7.4
Occupation		
official	18	17
Retired	15	13.8
Housewife	9	7.4
Unemployed	52	57.1

P-1013

Improving access to primary care services for marginalised groups; Participatory research in action!

Patrick Odonnell¹, Edel Tierney¹, Austin Ocarroll², Ray Oconnor³, Caitriona Oriordan³, Negin Reyhani³, Christina Mcdonnell³, Anne Macfarlane¹

¹University of Limerick Graduate Entry Medical School

²North Dublin City General Practice Training Scheme

³Mid-West Specialist Training Scheme in General Practice

INTRODUCTION:

According to WHO primary care should be accessible, acceptable and available to all people equally. There are policy imperatives to include patients in the planning of primary healthcare initiatives. However, some groups have more difficulty in accessing primary healthcare than others and their voice is absent from planning processes. The aim of this study was to consult with marginalised groups to explore their experiences of accessing primary healthcare and identify their priorities for the delivery of care.

METHODS:

This qualitative study used participatory learning and action (PLA) methods. Using purposeful sampling we recruited members of marginalised groups in an urban area who were known to have difficulty accessing primary healthcare (n=11). We ran two focus groups with each marginalised group; initially to brainstorm experiences of accessing primary healthcare, and then to concentrate on ranking solutions in order of priority for attention by service planners. Data were co-analysed by researchers and participants following principles of inductive thematic analysis. Data from all six focus groups were examined by the research team for overarching themes.

RESULTS:

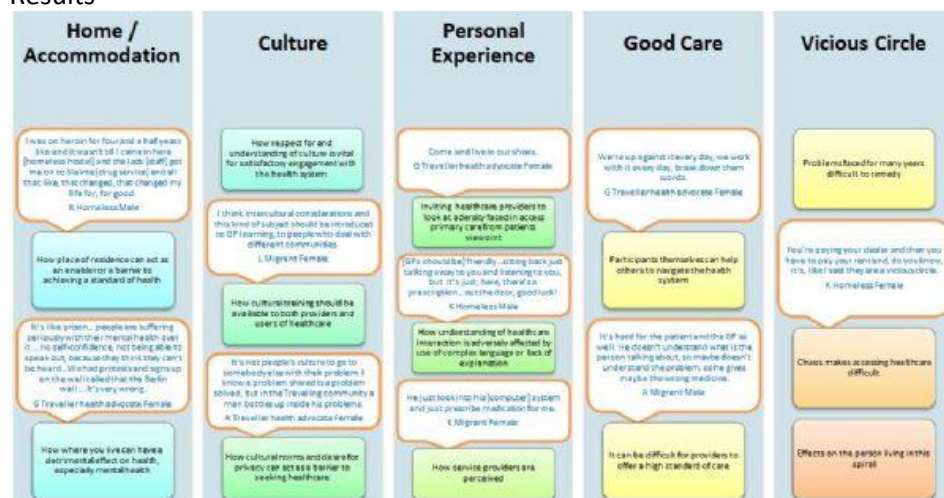
Five overarching themes were documented: (i) home/accommodation, (ii) culture, (iii) personal experience, (iv) good care and (v) vicious circle. Many of these themes describe issues around the social determinants of health including how personal mental health and societal discrimination can be barriers to healthcare. The importance of communication and building trust with healthcare providers was discussed, as negative experiences can deter seeking care. The concept of a vicious circle of ill health, personal chaos and barriers to access was also uncovered.

CONCLUSIONS:

PLA is a valuable method for supporting participants whose voices are absent from planning healthcare to identify priorities for their healthcare. Findings indicate the need for solutions to complex personal and structural problems that create barriers to healthcare for those who need it most.

Keywords: access, primary healthcare, marginalised groups, participatory

Results





P-1014

Chronic Obstructive Pulmonary Disease – A View on a Medical Center

Maria Miguel Sá, Adriana Relvas, Ana Margarida Pinho, Ana Palhares Delgado, Ana Sofia Azenha, Celia Silva, Jacinta Vaz, Mara Silva, Nádia Correia, Sara Almeida, Tânia Dias
USF Famílias, ACeS Entre Douro e Vouga, Santa Maria da Feira, Portugal

Background & Aim

Chronic obstructive pulmonary disease (COPD) is an important cause of mortality and morbidity and in Portugal, most recent studies show a prevalence of 14.2%.

According with Global Initiative for Chronic Obstructive Lung Disease (GOLD) the diagnosis should be considered in individuals with symptoms and risk factors. The diagnostic confirmation is obtained with lung function tests. The proper guidance of these patients is a constant challenge in primary care services.

The goal of this study is to determine prevalence of COPD in the population of a Clinical Center called Unidade de Saúde Familiar (USF) Famílias. The objective also includes the characterization of those patients identified: diagnosis and therapeutical profile, disease duration, severity and risk of exacerbations.

Method

Descriptive transversal study involving a population of patients 40 years of age and over with the diagnosis of COPD (at December 31st 2013) in the referred Clinical Center. The data was collected from the electronic medical database. Variables selected were: gender, age, age at diagnosis, diagnosis criteria, airflow obstruction severity, risk of exacerbation, disease duration, suitable treatment and vigilance on primary care services.

Results

The prevalence of COPD in our Clinical Center was 4.3%, 68% of which were of male gender. In 93% of the patients the disease has duration under 10 years, and only 18% have the three major diagnosis criteria. The majority are at low risk for exacerbations.

As of what concerns to treatment, the long-duration bronchodilators and inhalators corticosteroids were most used.

Conclusions

The prevalence of COPD in USF Famílias is lower than the prevalence of this disease at a national level (4.3% versus 14.2%).

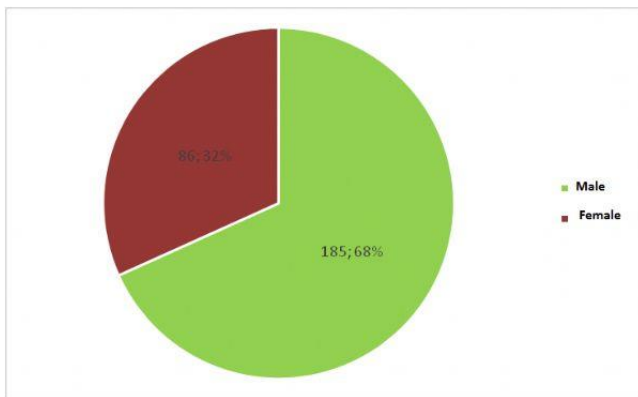
This analysis has helped to identify a problem related to an insufficient registering of data respecting symptom description, risk exposure, lung function test results and treatment.

Keywords: Chonic Obstructive Pulmonary Disease, early intervention, prevalence

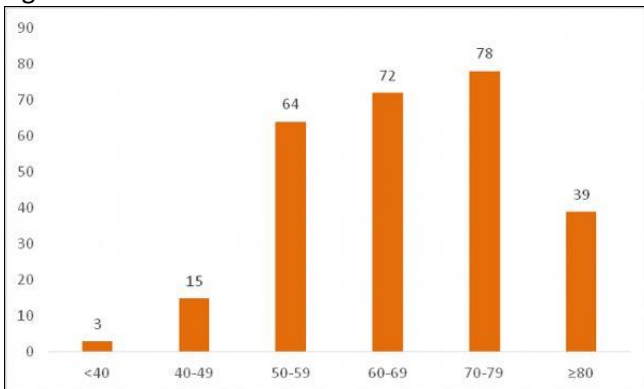
GOLD

RISK GOLD Classification	3-4	C High Risk, Less Symptoms	D High Risk, More Symptoms	≥2	RISK Exacerbation History
	1-2	A Low Risk, Less Symptoms	B Low Risk, More Symptoms	0-1	
		mMRC 0-1 CAT <10		mMRC ≥2 CAT ≥10	

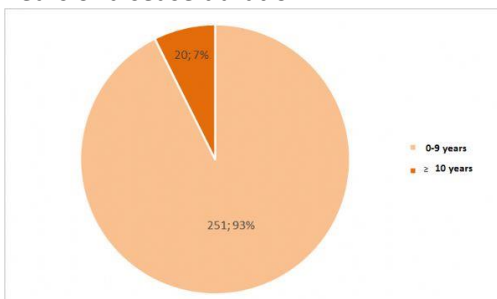
Gender distribution



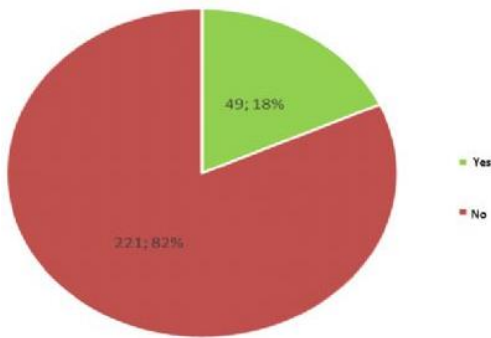
Age distribution



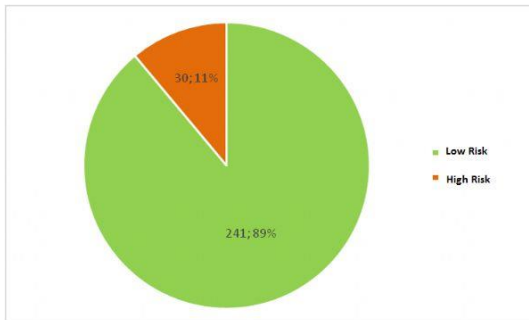
Years of disease duration



Presence of the 3 major criteria



Exacerbation risk



P-1015

Hypertension in adolescents

Albina Softic¹, Azijada Beganlic², Nadira Hodzic¹, Emina Hodzic¹, Sevko Sulejmanovic¹

¹Public Health Center Gracanica, Gracanica, Bosnia and Herzegovina

²Public Health Scientific Institution Tuzla and Educational Family Medicine Center Tuzla, Tuzla, Bosnia and Herzegovina

INTRODUCTION: Essential hypertension occurs in younger children, and with asthma takes is most common chronic disease of childhood. One of the factors that contributes to increase in blood pressure is a global epidemic of obesity in children and adults. This is a growing problem world wide.

OBJECTIVE: The aim of this study was to determine the prevalence of hypertension and prehypertension in young adulthood in adolescents aged 15-17 years in the area of Tuzla Canton.

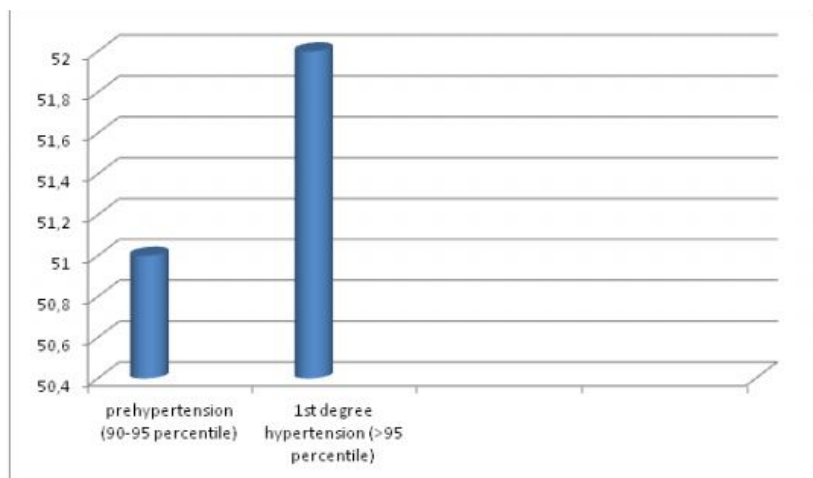
METHODS: We conducted a prospective clinical study to evaluate the prevalence of prehypertension and hypertension in a causal relationship with overweight and obesity in adolescents, students of first, second and third grades of high school. Hypertension in adolescents exists if the value of blood pressure above the 95 th percentile for age and height of an individual and prehypertension on the value of blood pressure, which is located between 90 th and 95 th percentile. All patients were performed by measuring blood pressure three times, not in the same day, in a sitting position, the first time on both upper arms, after at least 15 minutes. Respondents were determined BMI also.

RESULTS: A total of 103 802 (13%) of respondents have elevated blood pressure, 51 (6.4%) belong to the category of prehypertension in young adulthood and 52 (6.5%) first degree of hypertension category. Prehypertension more adolescents suffer with excessive BMI and obesity, 13% suffers prehypertension and hypertension 34% first degree in the categories of excessive BMI and obesity. Prehypertension among respondents with an ideal weight suffers 35 of 583 (6%), and hypertension and the level 17 of the remaining 548 (3%).

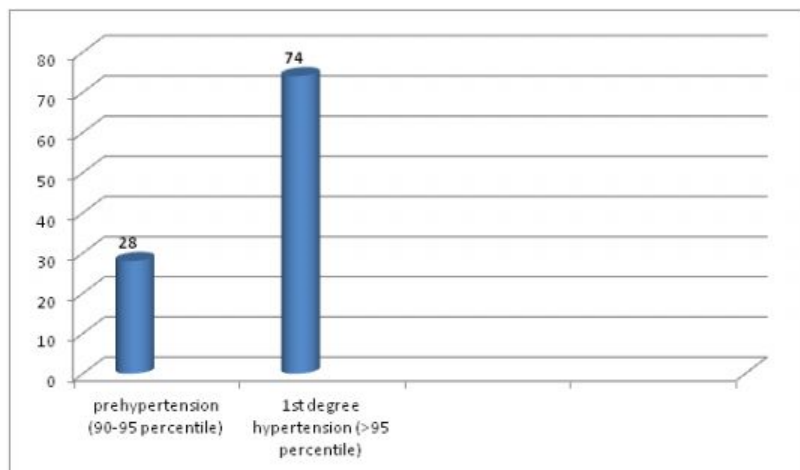
CONCLUSION: The prevalence of prehypertension and hypertension among adolescents in Tuzla Canton is very high. Overweight and obesity are risk factors for hypertension in adolescents.

Keywords: adolescents, hypertension, obesity

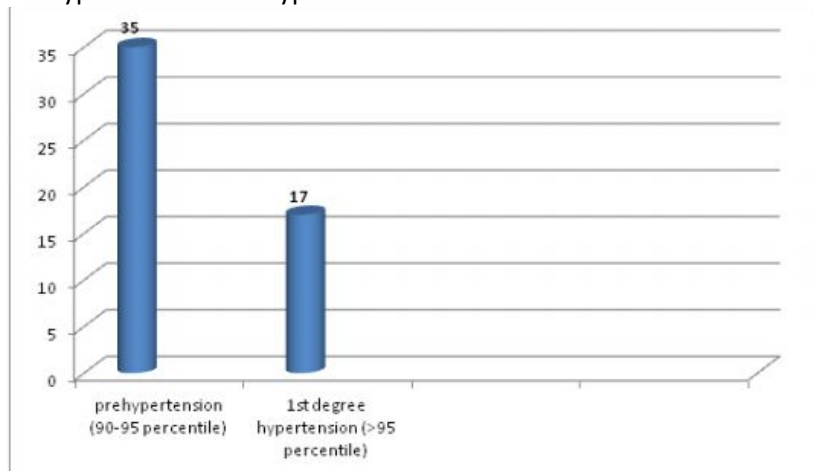
Prehypertension and hypertension in adolescents



Prehypertension and hypertension in adolescents with excessive BMI and obesity (n=219)



Prehypertension and hypertension in adolescents with normal BMI (n=583)



P-1016

Complications of diabetes mellitus type 2

Albina Softic¹, Azijada Beganlic², Nurka Pranjic³

¹Public Health Center Gracanica, Gracanica, Bosnia and Herzegovina

²Public Health Scientific Institution Tuzla and Educational Family Medicine Center Tuzla, Tuzla, Bosnia and Herzegovina

³University of Tuzla Medical Faculty, Tuzla, Bosnia and Herzegovina

BACKGROUND: Diabetes mellitus type 2 is one of the leading causes of morbidity and mortality in the world.

During the last decades diabetes mellitus typ 2 increasingly affects younger people, and it is a serious health's risk factor worldwide. Due to the complications of diabetes, it requires constant care for these patients.

OBJECTIVE: The aim of this study was to determine the frequency of complications of type 2 diabetes mellitus among patients who were treating in Family Medicine Department, Public Health Center Gracanica.

METHOD: A retrospective cross-sectional study was conducted on patients suffering from type 2 diabetes mellitus for more than five years. The following parameters, taken from their medical records were: age, sex, duration of disease, smoking status, BMI and complications: nephropathy, retinopathy, CAD (coronary arthery disease) and polyneuropathy.

RESULTS: Average age was 59.8 years. Average disease duration was 12.3 years. Of the total number of 50 respondents, number of respondents females were 45% and 55% males. Smokers were 37.5%, former smokers were 25% and non-smokers were 37%. Obese subjects were 47.5%, 32.5% overweight and normal body weight subjects 20%. Nephropathy had 62.5% of respondents, retinopathy had 82.5%, CAD 45% and 72.5% polyneuropathy.

CONCLUSIONS: Complications of type 2 diabetes mellitus in patients are highly frequent. Due to the average age of the patients can be concluded that these patients will have a significantly reduced quality of life in the future and be a huge burden to the health system. Significant efforts are needed in the primary prevention of type 2 diabetes mellitus for future generations, and prevention complications in patients with new diagnosis of diabetes.

Keywords: diabetes mellitus, complications, nephropathy, polyneuropathy, retinopathy, CAD

P-1017

Conversations of Exclusion

Austin O Carroll, David Wainwright, Derval Howley

Department of Health, University of Bath

Background & AIM: Homeless People have very poor morbidity and mortality profiles. We know that their usage of health service differs from that of the housed population and seems inappropriate and ineffective for caring for their health. This research sought to understand the Health Service Usage Behaviour of Homeless People in Dublin. This presentation relates to a barrier identified in that research which is a new concept called Conversations of Exclusion.

METHOD: A critical realist ethnographic approach was adopted and conducted in four sites frequented by homeless people in Dublin. This was supplemented by 37 semi-structured interviews with homeless people and 2 focus groups between homeless people and hospital doctors.

RESULTS: One of the factors identified in the research as contributing to the HSU pattern of homeless people were recurrent interactions between health professionals and patients whereby patients were either excluded or discouraged from attending the health service or self-excluded themselves from that or other such services. These interactions were described as Conversations of Exclusion. Four such conversations were described, the Benzodiazepine Conversation (where a patient asks for addictive medication); the Distrustful Conversation (where the doctor distrusts the patient); the Blaming Conversation (where the patient is blamed for their condition); and the Assertive Conversation (where the patients has not learnt to assert themselves in a manner that is not perceived as aggressive by the health provider).

CONCLUSIONS: These Conversations result in patients who are among the most unhealthy in society being excluded from health services. A technique for converting the Benzo Conversation into one of Inclusion will be presented. Conversations of Exclusion are one of the many barriers that exist for homeless people accessing such services.

Keywords: Homeless Persons

P-1018

Perceived benefits of mutual VdGM and Foundation for the Development of Family Medicine Exchange in Zagreb, Croatia?

Renata Pavlov¹, Süheyla Atalay²

¹Family Practice "Dr. Renata Pavlov", Zagreb, Croatia

²Department of Family Medicine, İstanbul Medeniyet University Göztepe Training and Research Hospital, İstanbul, Turkey

Background & Aims

In December 2014, Foundation for the Development of Family Medicine in Croatia and Vasco da Gama Movement organized 4-days exchange in Zagreb. 15 young doctors from 6 European countries took part. The program was divided in three parts. First, Croatian health care systems, family medicine (FM), medical education and quality improvement in FM were presented, followed by discussion on similarities and differences among countries. Two days were spent observing daily work of Croatian GPs in city and rural practices. Then, mini symposium was organised, Foundation's Days, where Croatians presented research works and colleagues system of FM in their respected countries. The aim of this survey was to evaluate effectiveness of Zagreb exchange program and to find out perceived benefits.

Methods

In this qualitative research, we asked participants to describe, in narrative way, benefits from the exchange program. 13 of 15 participants answered. Free-texts were analysed using thematic analysis method, first independently by three experts and than triangulated.

Results

Seven themes emerged from codes: 1. "My situation in relation to others", codes: same FM system; different types of FM residency; 2. "Organizational issues", codes: working in the shifts; e-recipes; 3. "Handling daily practice", codes: dealing with economic burden; combination of public and social health; 4. "Learning professionalism", codes: people who have faith and eager nothing is impossible; 5. "Personal growth", codes: I am not alone and I have a big family, 6. "Motivation for future work", codes: motivated me to start my own scientific project; 7. "Cultural issues", codes: hosts were so kind and sincere; home cuisine; unforgettable experience.

Conclusion

Results indicate that the exchange was effective and beneficial for participants, mostly because of getting broader view on FM and contributing to professional and personal growth.

Keywords: evaluation, exchange program, family medicine, VdGM, Croatia

Theme 1. My situation in relation to others - comparing and contrasting health care and GP/FM systems

Participants quotes – codes typical for the theme:

... “the same family medicine system...” “we share the same problems.....” all of us use similar practices and insights” ... “our GPs are very similar” “unlike the UK General Practice, in Croatia they use e-prescriptions.... “...not a big difference between Croatia and Turkey”..... “...patients have similar expectations”..... “We do not have anything like this” “different type of family medicine residency program“.... “Seeing different systems – I began to see our problems in a different window”.... “what exist out of my country”..

Theme 2. Organizational issues

Participants quotes – codes typical for the theme:

... “working in shifts can be beneficial for both sides, doctor and patients”.... “sharing same room by two doctors good”.... “good communication between primary care and secondary or tertiary hospitals”... “software used by Croatian GPs were more detailed for prescriptions, for example costs are included”... “such a PC system ...that you can see what has happened to your patient recently”.... “we also should change the method of payment for GPs, like in Croatia”.... “nurses who work just for home care were different than Turkey”.... “Croatia comprises private and state systems - often side by side...”

Theme 3. Handling daily practice

Participants quotes – codes typical for the theme:

.. “I’ve seen a skillful Croatian doctors in handling patients’ problems.... “recognized patient’s unique needs, such as posttraumatic-stress syndrome and demographic changes”... “I was impressed by the desire to combine such forward thinking in public and social health with daily practice” “I saw that patients had similar expectations” “how Family Physicians in Croatia deal with the economic burden”... “home visiting with Miro was interesting experience..”

Theme 4. Learning professionalism

Participants quotes – codes typical for the theme:

.. “I saw that for people who have faith and eager nothing is impossible”. “I was impressed by the motivation of GPs in Croatia to improve the recognition and academic credibility of GP as specialty”.... “how Family Physicians in Croatia deal with the getting their economic/social rights”.... “nothing to be achieved passively but needs investment in time, motivation and commitment by as family doctors”... “GP in Croatia are getting better position”... “the meeting with young GPs from other countries gives the opportunity to enlarge the net of our professional links”

Theme 5. Personal growth

Participants quotes – codes typical for the theme:

.. „I am not alone and I have a big FAMILY” “I’ve seen that retirement is not an end” ...
“exchange supported my enthusiasm””great experience to present my work life in English,
.....”this exchange help me to confirm the direction I want for my future”..

Theme 6. Motivation for future work

Participants quotes – codes typical for the theme:

.. “possibility to collaborate with colleagues with multi-centric research and/or professional projects” ... “working together, it is possible”.. “presentation of the research motivated me to start my own scientific project”... “presentation of the Foundation was really inspiring for my future”... “each exchange I took something or made me think, what could we change”.. “we got some inspiration from you”.....

Theme 7. Cultural issues

Participants quotes – codes typical for the theme:

... “people here are very kind, polite, friendly and always helpful” “home cuisine was unforgettable experience” “I’ve seen the banks open till late hours” “I thought long working hours could effect the employees' lives”..

P-1019

Evaluation of the Predictive Index for osteoporosis as a clinical tool to identify at risk of osteoporosis in Korean men

Ji Hyun Moon, Lee Oh Kim, Hyeon Ju Kim, Mi Hee Kong

Department of Family Medicine, Jeju National University & Hospital, Jeju, South of Korea

Background & Aim

Indications for the bone mineral density (BMD) test to find osteoporosis in men less than 70 years has not yet been clarified. In a previous report, we proposed a Predictive Index for Osteoporosis (PIO) as a new index for identifying men who need to measure BMD. PIO was as useful as the osteoporosis self-assessment tool for Asian (OSTA) to identify candidates for the dual energy X-ray absorptiometry (DXA). But previous study had limitations about a single-center and small sample sized study. In this study, we evaluated usefulness of PIO using the nationally representative data of Korea National Health and Nutrition Examination Survey.

Methods

Participants measured BMD with DXA and calculated PIO with OSTA. Receiver operating characteristic analysis was used to obtain optimal cut-off points for PIO with OSTA and compare the predictability of osteoporosis between the two indexes.

Results

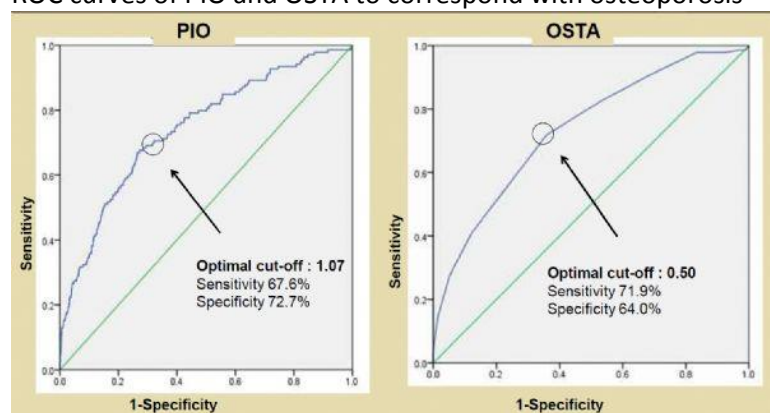
Both PIO and OSTA were useful clinical tools to identify a risk of osteoporosis in Korean men. The optimal cut-off value for PIO was 1.07, for which the sensitivity was 67.6%, the specificity was 72.7%, and the area under the curve (AUC) was 0.743. In the case of OSTA, using a cut-off point of 0.5, the sensitivity and specificity were 71.9% and 64.0%, respectively, and the AUC was 0.737.

Conclusions

The PIO was as useful as OSTA for screening index to identify candidates for the DXA in men aged 50-69 year.

Keywords: Osteoporosis, Predictive Index, Self-Assessment Tool

ROC curves of PIO and OSTA to correspond with osteoporosis



PIO predictive index for osteoporosis, OSTA osteoporosis self-assessment tool for Asian, ROC receiver operating characteristic

General characteristics of the study subjects.

	Study subjects (N=2,519)
Age (years)	59.1 ± 5.83
Height (cm)	167.33 ± 5.71
Weight (kg)	67.41 ± 9.24
Body mass index (kg/m ²)	24.05 ± 2.85
Lumbar spine total T score	-0.61 ± 1.23
Femoral neck T score	0.06 ± 0.89
Femoral total T score	-0.62 ± 0.92
PIO	0.99 ± 0.20
OSTA	1.42 ± 2.08
Current smoker	1546 (61.4)
Heavy alcohol consumption	528 (21.0)
Regular exercise	452 (19.6)

The data were analyzed by independent T-test and chi-square test. Values are presented as mean ± standard deviation or N (%). Heavy alcohol consumption defined as drinking alcohol more than 4 times a week. Regular exercise defined as moderate physical activity on 3 or more days of a week. PIO predictive index for osteoporosis, OSTA osteoporosis self-assessment tool for Asian

General characteristics of study subjects according to bone mineral density status.

	Normal and osteopenia (N=2,380)	Osteoporosis (N=139)	P value
Age (years)	59.00 ± 5.82	60.96 ± 5.70	0.497
Height (cm)	167.46 ± 5.67	165.06 ± 5.87	0.998
Weight (kg)	67.88 ± 8.99	59.32 ± 9.67	0.299

Body mass index (kg/m ²)	24.18 ± 2.78	21.74 ± 3.17	0.177
Lumbar spine total T score	-0.48 ± 1.13	-2.82 ± 0.49	< 0.001
Femoral neck T score	-0.55 ± 0.87	-1.91 ± 0.70	0.003
Femoral total T score	0.13 ± 0.84	-0.122 ± 0.68	0.001
PIO	0.98 ± 0.19	1.18 ± 0.26	< 0.001
OSTA	1.52 ± 2.03	-0.29 ± 2.14	0.536
Current smoker	1447 (60.8)	99 (71.2)	0.014
Heavy alcohol consumption	493 (20.7)	35 (25.4)	0.195
Regular exercise	433 (19.8)	19 (15.3)	0.222

The data were analyzed by independent T-test and chi-square test. Values are presented as mean ± standard deviation or N (%). Heavy alcohol consumption defined as drinking alcohol more than 4 times a week. Regular exercise defined as moderate physical activity on 3 or more days of a week. PIO predictive index for osteoporosis, OSTA osteoporosis self-assessment tool for Asian

P-1020

Should we wear a white coat in our practice? A cross-sectional study

Dagmar M Haller¹, Paul Sebo², François Herrmann³

¹Primary Care Unit, Faculty of Medicine, University of Geneva, Switzerland & Department of Community, Primary Care and Emergency Medicine & Department of Pediatrics, Geneva University Hospitals, Geneva, Switzerland

²Primary Care Unit, Faculty of Medicine, University of Geneva, Switzerland

³Geriatrics Division, Department of Internal Medicine, Rehabilitation and Geriatrics, Geneva University Hospitals, Geneva, Switzerland

Background and AIM: Previous studies show that patients prefer specialists and hospital-based physicians to wear white coats, but evidence from family practice is lacking. Our aim was to assess patients' preference for their family doctor to wear white coats.

METHODS: This cross-sectional study was conducted in Geneva, Switzerland. A random sample of 75 family doctors was contacted by post and 23 agreed to participate. In each practice, 50 to 100 consecutive patients coming to the practice for a scheduled consultation were invited to complete a survey about their expectations from the family doctor, including whether they preferred their doctor to wear a white coat or not. We examined the parameters associated with a preference for doctors wearing a white coat.

RESULTS: 1637 patients agreed to participate (participation rate: 97%, women: 63%, mean age: 64 years). Only 34% considered wearing a white coat as important. In multivariate analyses, older patients, those of Italian background (as opposed to Swiss origin), and patients consulting uncertified doctors and/or doctors wearing a white coat were more likely to consider white coats as being important.

CONCLUSIONS: These findings suggest that white coats are no longer considered a powerful symbol for a majority of patients in family practice. However, family doctors may wish to adjust their attire to meet the expectations of particular groups of patients.

Keywords: Patient expectations, White coat, Family practice, Health services research

Characteristics associated with preference for doctors wearing a white coat

Characteristic	Adjusted OR	95%CI	Adjusted p-value
Gender			NS
Age group (ref:<25years)			
25-65 years	1.71	1.02-2.87	0.04
>65 years	2.22	1.26-3.92	0.01
Marital status			
Widowed	0.53	0.36-0.77	0.001
Nationality			
Italian	2.06	1.36-3.12	0.001
Level of education			NS
Professional status			NS
Family doctor's gender			NS
Family doctor's age			NS
Urban location of practice			NS
Number of doctors in the practice			NS
Number of years since doctor's certification			NS
Doctor wears white coat	5.67	2.69-11.91	<0.001

Characteristics potentially associated with preference for doctors wearing a white coat, with adjusted OR, 95%CI and p-value for statistically significant associations in multivariate analysis adjusting for all listed patient and doctor variables (NS= no significant association)

P-1021

Sleep Quality in Asthmatic Children

Bahadır Yazicioglu¹, Burcu Sezer¹, Sema Cetin Ayhan¹, Banu Gülcan Oksuz², Mahir Igde², Fusun Artiran Igde¹

¹Department of Family Medicine, Ondokuz Mayıs University, Samsun, Turkey

²Pediatric Clinic, Samsun Education and Research Hospital, Samsun, Turkey

AIM: Asthma is characterized with cough and dyspnea, especially rising at the late night hours. So asthmatic children mostly have low sleep quality and sleep disorders. We aimed to evaluate correlation between asthma and sleep quality.

METHODS: A cross-sectional study, was conducted between 15 February to 15 March 2014 at the Samsun Education and Research Hospital. 25 asthmatic children admitted to the pediatric allergy clinic and 25 children with non-asthma admitted to the general outpatient pediatric clinic selected with randomization for the study. Data are collected by pediatric sleep questionnaire (PSQ) which has developed by Dr. Ronald D. Chervin, and made Turkish validity and reliability by Pinar Oner et al. Pediatric Sleep Questionnaire consists of questions in two sub-groups to understand in night or sleep time behaviors and day time behaviors or potential problems. SPSS 16.0 package program calculated using the scores given level of significance was evaluated with chi-square test.

RESULTS: The study were a total of 50 children between the ages of 1 and 17 (7.9 ± 4.93) and 24 boys (%48), 26 girls (%52). Asthmatic children's scores in the subgroup with night and sleep time behaviors indicates a statistically significant difference compared to non-asthmatic children. According to behavior and potential problems of the day time sub-scale, the differences were not statistically significant.

CONCLUSION: Sleep is important for quality of life at all ages. Results show that, according to night behaviors and sleep quality sub-scale, asthmatic children sleep quality is affected. This low sleep quality may adversely affect the development of children. Emphasis to the asthmatic children's sleep quality may contribute to the development of these children and their quality of life.

Keywords: Asthma, Child, Quality of Sleep

P-1022

The prevalence of Lithuanian population of familial cancer anamnesis (FCA)

Indrė Baužienė, Valerijus Morozovas

Faculty of Medicine, Vilnius University, Lithuania

Objective. Worldwide FC widespread about 10 %. We aimed to determine the frequency of FCA between the sexes and different age groups in Lithuania. Find out the most common localizations. Verify whether there is a statistically significant relationship between age and cancer localization in positive FCA group.

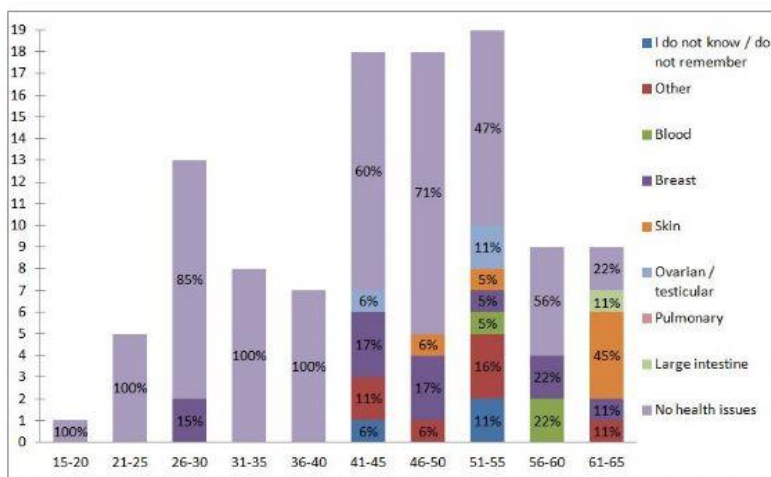
Materials and Methods. One time study was carried out in 2012-2014 years. We created self designed questionnaire about FC prevalence. 1200 respondents interviewed online. A statistical analysis was done and the Significance Assessed by a X-square test. The statistical Difference was Considered spreads across if the p value was below 0,05.

Results. FCA positive group accounts for 10,4 % (125): men accounted for 14.4 % (18), women - 85.6 % (107). 65.42 % (70) women were younger than 50 years old, male - 27.7 % (5). After 51 yers -34.58 % (37) women and 72.2 % (13) men. Statistically significant (p=0.002) women often have a positive FCA in 41-45 age group. Statistically significant (p=0.0001) positive FCA is the most common between 51-65 years men. 64,8% (81) of 125 respondents didn't have oncology, bet they matched positive FCA. In FCA -positive group breast cancer formed 8%, skin 5,6%, ovarian / testicular and prostate by 4,0%, blood 3,2%, large intestine 1,6%, lung cancer 0,8%, other locations 5,6 % and cancer localization wasn't known 2,4 %.

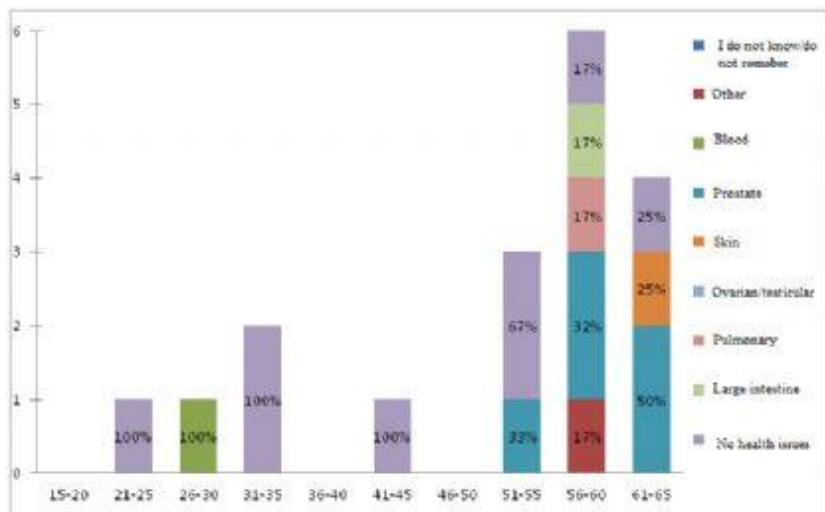
Conclusions. FC prevalence is similar in other countries. Women make up the majority of positive FCA. Increased incidence or the positive FCA observed in younger women and older men. In general, the biggest part of FCA group consists of 41-45 years group. Depending on the results, FCA history with people and their relatives should be intensively investigated in order to reduce this risk.

Keywords: prevalence of familial cancer (FC), anamnesis.

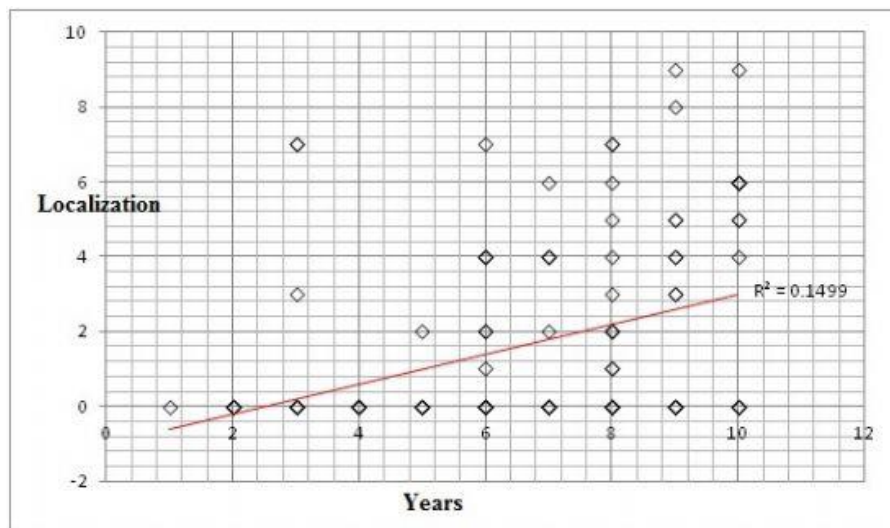
1 picture. Women's group, which meets the criteria of family cancer (by age group and localizations)



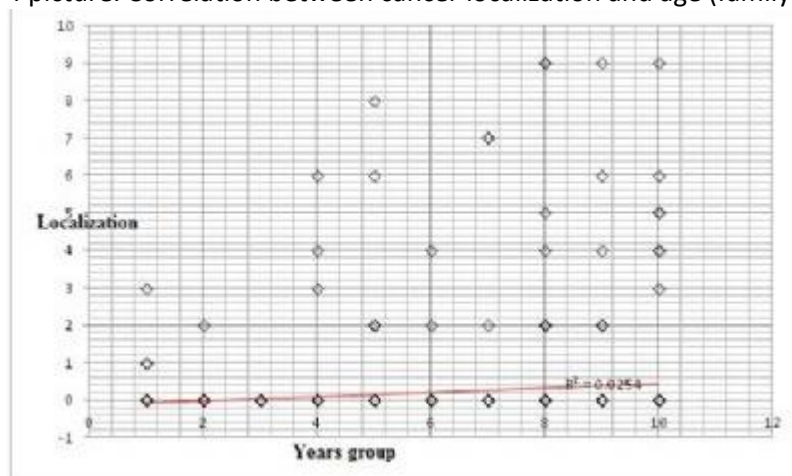
2 picture. Men's group, which meets the criteria of family cancer (by age group and localizations)



3 picture. Correlation between cancer localization and age (family cancer eligible respondents)



4 picture. Correlation between cancer localization and age (family cancer ineligible respondents)



P-1023

"Rating subjective feelings of pain, mood and general activity in patients with poly morbidity"

Zlata Mustafa Frasto, Amra Mustafa Lasic, Neda Mladen Ferizovic, Fuad Abit Husic, Lejla Mahmut Kurtalic
Public Health Center Sarajevo Canton, Bosnia and Herzegovina

INTRODUCTION: The structure of patients in the Public Health Centre Sarajevo is mostly with polymorbidity. Patients expect from health workers to improve the quality of their life and make it worth living.

OBJECTIVE: To examine whether the number of chronic diseases that the patient has influence his subjective experience of pain, mood, as well as general activity.

METHOD: The study is conducted by interviewing patients and examining medical records. Period: September-December 2014 in three family medicine teams of Public Health Center Sarajevo. Patients with two or more chronic diagnosis were tested. Examined variables: age, gender, number of diagnosis, numerical pain score during rest and descriptive assessment on quality of life: mood and general activity. Patients classified into three categories: small number (2-3), mean (4-6) and large number of diagnoses (7-10).

RESULTS: Total number of patients 120, average 61.9, SD 39.9 (55 patients up to 65 years and 65 over 65), M37 (30.8%) F83 (60.2%). 58 test subjects belong to category with small number of diseases, 53 to category with mean number of diseases, 9 to category with large number of diseases. There is no statistically significant difference in the subjective feeling of pain at rest among the three categories. $t=8306; p=0.081 > 0.05$. Subjective assessment of the quality of life—mood segment is descriptive: poor quality, neither good nor poor quality, good quality. There is no statistically significant difference in the subjective feeling of quality of life/mood, among the three categories. $t=8215; p=0.084 > 0.05$. Subjective assessment of general activities is also descriptive: poor quality, neither good nor poor quality, good quality. There is a statistically significant difference in the subjective evaluation of general activity among the three categories. $t=14\ 359; p=0.006 < 0.005$.

CONCLUSION: These findings should influence the guidelines which should be used to improve the tested segments of life for patients with polymorbidity.

Keywords: polymorbidity, pain, mood, general activity

Polimorbiditet and subjective experience of pain and quality of life

		rest pain in three categories			Total
		mid pain	mean pain	severe pain	
number of test subjects	a small number of diseases	18	21	19	58
	mean number of diseases	12	22	19	53
	a large number of diseases	0	2	7	9
Total		30	45	45	120

No statistically significant differences in the subjective feeling of pain at rest among the three categories of diseases. $t = 8,306, p = 0,081$

		subjective assessment of quality of life mood in 3 categories			Total
		low-grade	neither quality nor substandard	high-quality	
the total number of cases in three categories	a small number of diseases	17	14	27	58
	mean number of diseases	29	11	13	53
	a large number of diseases	4	2	3	9
Total		50	27	43	120

No statistically significant differences in the subjective feeling of quality of life- mood, among the three categories of diseases. $t = 8,215; p = 0,084 > 0,05$

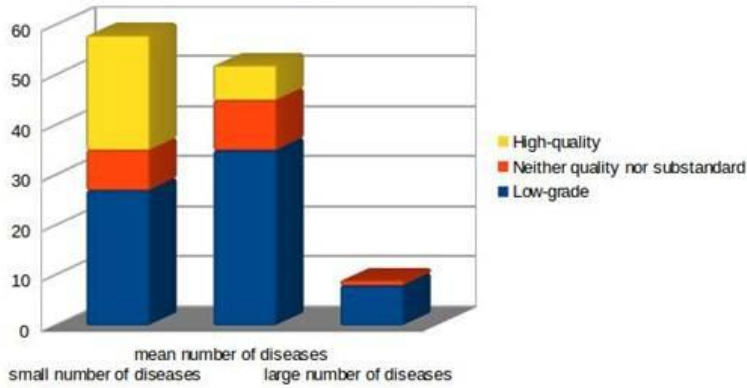
		subjective assessment of the quality of life of the general activity in three categories			Total
		low-grade	neither quality nor substandard	high-quality	
the total number of cases in three categories	a small number of diseases	27	8	23	58
	mean number of diseases	30	10	7	53
	a large number of diseases	8	1	0	9
Total		71	19	30	120

There is a statistically significant difference in the subjective assessment of quality of life- General activity $t = 14\ 359, p = 0,006 < 0,05$

The structure of patients in the Community Health Centre Sarajevo is mostly with polymorbidity. Patients expect from health workers to improve the quality of their life and make it worth living, and it's becoming increasingly difficult to do so.

rest pain in three categories

Subjective assessment of the life quality of the general activity in three categories



No statistically significant differences in the subjective feeling of pain at rest among the three categories of diseases. $t = 8.306$, $p = 0.081 < 0.05$

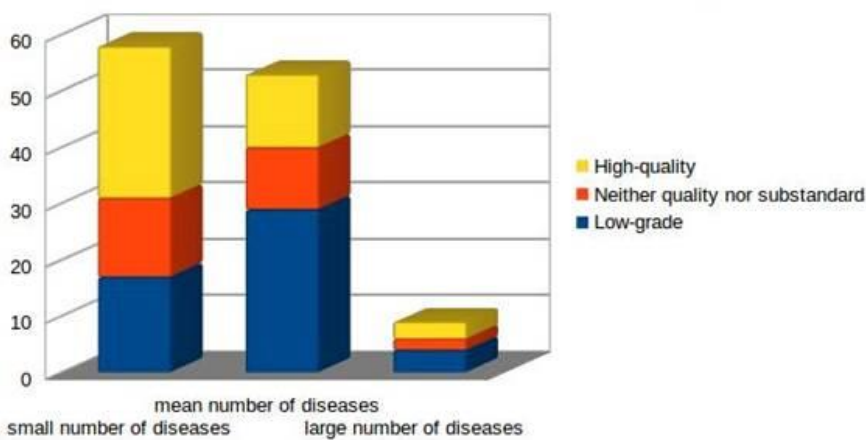
rest pain in three categories

	mild pain	main pain	severe pain	Total
a small number of diseases	18	21	19	58
mean number of diseases	12	22	19	53
a large number of diseases	0	2	7	9
Total	30	45	45	12

the total number of cases in three categories

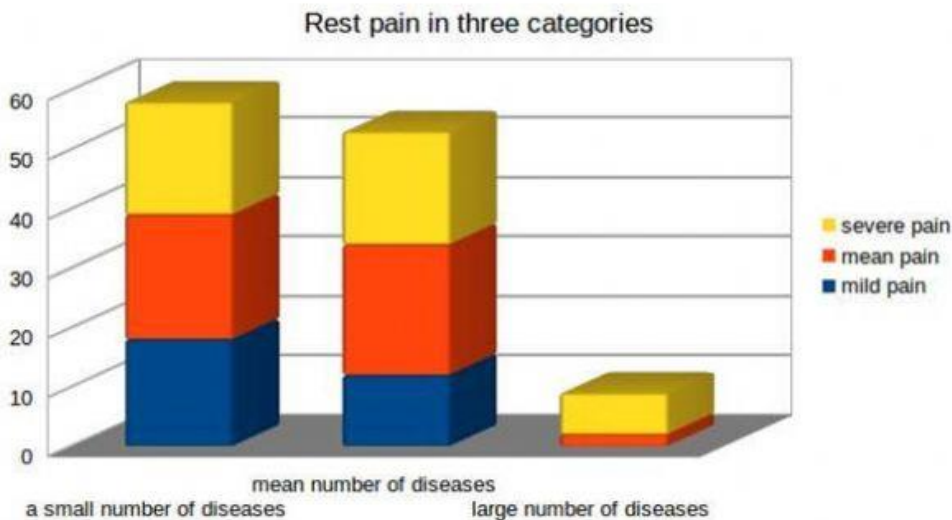
subjective assessment of quality of life mood in 3

Subjective assessment of quality of life mood in 3 categories



No statistically significant differences in the subjective feeling of quality of life- mood, among the three categories of diseases. $t = 8.215$; $p = 0.084 < 0.05$

subjective assessment of the quality of life of the general activity in three categories



There is a statistically significant difference in the subjective assessment of quality of life -General activity T = 14.359, $p = 0.006 < 0.05$

P-1024

A new means to promote organ donation: General Practitioners' views on discussing organ donation in the primary care setting - A qualitative study

Jennifer Nicola Maeve Rea, Richard Meakin

Primary Care and Population Health Department, University College London, London, United Kingdom

Background & AIM:

Organ shortages limit transplantation as a treatment for end-organ failure. Whilst England operates an opt-in system for donation, there is reliance on public proactivity and altruism for successful donor recruitment. At present, $<1/3$ of the UK population are registered as donors - more people need to be encouraged to donate. Previous work by this author revealed public expectation to find donation information in General Practice, suggesting an educational opportunity within primary care. Currently surgeries passively promote donation at registration or via posters/pamphlets in surgeries, there is no routine discussion with patients. Little research is available about active donation promotion in primary care or how GPs would respond to taking on this role.

METHOD:

A qualitative study design using semi-structured interviews with a purposive sample of 15 London GPs. Fram

RESULTS:

Participant GPs were conscious of the need to increase donor registration, but had limited education on donation or experience discussing it. Primary Care was acknowledged to be an ideal setting for donor recruitment and GPs were willing to increase their involvement in promotion. GPs accepted that discussion could provide meaningful donation education, but expressed concern that conversations could be time consuming and/or inappropriate for many patients. Optional discussions that were patient-led rather than doctor-led, were considered most suitable.

CONCLUSIONS:

Organ shortages in the UK are set to rise by 8% each year. With an opt-in system in place, we need to be more creative in our approach to donor recruitment. This study suggests that GPs promotional role could be expanded as part of a wider public drive to increase donation, and that discussion may have a place in promotion if offered selectively for patients who are hitherto undecided and wish to discuss further with a healthcare professional.

Keywords: 'Organ donation', Donation, Promotion, 'General Practice', Discussion, 'Primary Care'

P-1025

Pathological Internet use, cyber-bullying and mobile phone use in adolescence: a multicenter, school-based, cross-sectional study in Greece

Zoi Tsimtsiou¹, Anna Bettina Haidich², Anastasios Drontsos¹, Fotini Dantsi¹, Zafiria Sekeri³, Evangelos Drosos⁴, Nikolaos Trikilis⁵, Theodoros Dardavesis², Panagiotis Nanos⁶, Malamatenia Arvanitidou²

¹Urban Health Center of Evosmos, Thessaloniki, Greece

²Department of Hygiene, School of Medicine, Aristotle University of Thessaloniki, Thessaloniki, Greece

³Health Center of Litochoro, Litochoro, Greece

⁴Health Center of Siatista, Siatista, Greece

⁵Health Center of Chalastra, Chalastra, Greece

⁶3rd Health Authority of Macedonia, Thessaloniki, Greece

Background & Aim Although Internet is a very useful means of information retrieval, social networking and entertainment, potential hazards have been recognized in the vulnerable group of adolescents. We aimed in investigating the prevalence of Internet addiction (IA) and cyber-bullying behaviors in adolescents, their possible association and identify associated factors among socio-demographics, Internet habits and the use of mobile phones with Internet access.

Method In this cross-sectional, school-based study, 8053 students of 30 middle and 21 high schools (12 to 18 years old) in North Greece were invited to participate, based on a multistage stratified random sampling technique. Internet Addiction Test (IAT) was used along with experience of cyber-bullying (victim or/and perpetrator), socio-demographics, Internet activities and use of mobile phone with Internet access.

Results 5590 students participated (response rate 69.4%). We found that 30.1% had mild, 9.6% moderate and 0.4% severe IA, while 7.3% were cyber-bullying victims and 6.6% perpetrators during the last 12 months.

Ownership of mobile phones with Internet access was 65.2%. Younger age, hours online during a school day and surfing from mobile phones, visits in Internet cafes, use of pornographic sites, chatrooms and being a victim or perpetrator of cyber-bullying were associated with IA, while the use of athletic sites was inversely related. Hours of Internet surfing from mobile phones and IAT score were associated with both cyber-bullying profiles. Cyber-bullying victims were more likely to be female, use Facebook and chatrooms, while perpetrators to be male, use Internet longer and prefer pornographic sites. A perpetrator was 5.5 times more likely to have also been victim.

Conclusions Cyber-bullying behaviors are associated with IA and the longer hours of mobile phones use for Internet access were found associated with both conditions.

Keywords: Internet, addiction, adolescents

P-1026

Reasons for consultation of gastric cancer in primary care in the Netherlands

Charles W Helsper¹, Kristel M Van Asselt², Roxanne Ten Bokkel², Gerline Van Den Brink¹, Niek J De Wit¹

¹Julius Centre for health and primary care, UMC Utrecht, Netherlands

²Department of Primary Care, AMC Amsterdam, Netherlands

Background and Aim

Gastric cancer is relatively rare with an incidence of 1,500 in the Netherlands. Since most patients are diagnosed in advanced stage of disease, mortality rate is high, with over 1,400 deaths each year. Moreover, gastric cancer causes a significant burden of disease. Earlier identification of gastric cancer patients is likely to reduce both mortality and disease burden.

Since symptoms and complaints are first seen in general practice, the aim of this study is to identify and quantify reasons for consultation of gastric cancer in primary care to improve early diagnosis.

Method

A case series using combined routine care data of the Julius general practitioners Network (JHN) and the GP-network-AMC (HAG-net-AMC) was performed. Files of patients diagnosed with gastric cancer between 1996 and 2014 were extracted and manually screened for recorded reasons for consultation. Screened text included coded and uncoded (free text) data.

Results

Patient files of 103 gastric cancer cases were studied. Recorded reasons for initial consultation were; abdominal pain (68.0%), anemia (39.8%), decreased appetite (36.9%), nausea (36.9%), reflux (35.9%), weight loss (33.0%), vomiting (29.1%) and constipation (23.3%). In over 70% of cases, a combination of two or more complaints was found. In 50% a combination of three or more complaints occurred.

The combination of; abdominal pain and/or decreased appetite and/or nausea and/or reflux, was found in 82.5% of patients. Abdominal pain and/or anemia occurred in 82.5%. Alarm symptoms were found in 49.5%.

Conclusion

Abdominal pain is the most frequently recorded reason for consultation in gastric cancer patients in primary care. Most GPs recorded more than one complaint. Alarm symptoms were recorded in approximately half of the patients. To determine the diagnostic value of these findings in primary care, further research is needed.

Keywords: Gastric cancer, general practice, primary care, diagnosis, symptoms

P-1027

Our One-Year Experience in a Single Center in the Home-Care Nursing Services

Bahadır Yazicioglu¹, Mahcube Cubukcu²

¹Department of Family Medicine, Faculty of Medicine, Ondokuz Mayıs University, Samsun, Turkey

²Department of Family Medicine, Samsun Education and Research Hospital, Samsun, Turkey

Aim

A person who is bedridden usually needs full-time care and attention. This means that a care team will likely be working together. Bedsores are caused by prolonged pressure against the skin. They occur most on the lower part of the body. Advanced medical care in the patient's home care is becoming more common. We aimed to evaluate given the home care nursing services by Samsun Education and Research Hospital.

Methods

As of January 2011 home care nursing services are provided by the Samsun Education and Research Hospital. Patients older than 16 years are visited by going to their homes. Patients were examined, taken to the list of observation and treatment, medical records are kept meticulously. Retrospective medical record scanning, our one year experience in a single center were examined.

Results

Our clinic since it opened a total of 1939 patients were visited at home. Treatment services given the current number is 914 (612 female (%67), 302 male(%33)) patients. 884 patients died, 19 patients transferred to the other home-care service unit, 66 patients fully treated, 23 patients or relatives wanted to terminate home-care service, 33 patients were excluded from the follow-up due to change of address. We have 697(%76) bedridden, 217(%24) semi-independent patients. The number of visits made to patients were 2719. The number of dressing in last year were 1067. And the most common invasive procedure were urinary foley catheter (n=586). Blood examination was made of 408 patients. 203 patients were asked to consultation from other specialist physicians.

Conclusion

Home care services are utilized by people of all ages and backgrounds. However the program is predominantly used by elderly with multiple health conditions and limited economic means. People can receive a variety of essential medical treatments in the comfort of their own homes.

Keywords: home-care, bedsore, nursing service

P-1028

Alcohol consumption among young adults in Lithuania

Mante Barzdenyte, Monika Niedvaraite, Daiva Makareviciene, Greta Salciute, Ana Chaleckaja, Ignas Barzdenis, Virginijus Sapoka, Vytautas Kasiulevicius
Vilnius University Faculty of Medicine, Lithuania

BACKGROUND AND AIM: The data about alcohol using in young adult subjects is poor in Lithuania. The aim of our survey was to evaluate alcohol consumption models among young adults.

METHODS: A randomized survey was performed by carrying out anonymous 32 questions questionnaire covering the period from 2014 to 2015 years, collecting data on basic characteristics, tobacco and alcohol consumption models. A modified alcohol dependence scale (ADS) was used. Questionnaire was completed by 797 respondents, 794 were taken to the final analysis. Main selection criteria was age from 18 to 29 years. According to estimates of the ADS, respondents were divided into 5 groups: 0, 1-13, 14-21, 22-30, 31-47.

RESULTS: Among 794 participants, 70.0% were women, 95.2% - unmarried, mean age was 22.2±2.3 years. Of all, 50.1% respondents lived in the capital city Vilnius. The majority of subjects (41.3%) lived with their parents, 20.1% - together with the lover, and 17.1% lived in dormitory. According to the survey 92.6% had university education. Unemployed were 69.9% participants, 30.4% of young adults had steady jobs. Non-smokers were 61.2%, but a reasonable proportion of the respondents (38.8%) were constantly smoking or attached themselves to social smokers. Women had a significantly lower estimate of ADS than men ($p = 0.004$). Those who lived with their parents or the lover had lower ADS ($p = 0.034$). It was also noted that the unemployed participants were in a significantly larger alcohol dependence risk compared to the working population. There was no connection among age, city, social situation and the resulting estimate of ADS.

CONCLUSIONS: Our research showed that less alcohol consume in employed female, living with their parents or lover. **Keywords:** alcohol use, alcohol consumption, young adults

ADS Interpretation Guide

<u>ADS Raw Score</u>	<u>Interpretation</u>
0	No evidence of alcohol dependence was reported. However, this does not necessarily mean that the individual is free of dependence symptoms. Assess the validity of self-reports.
1-13 (1st quartile)	Low level of alcohol dependence. Symptoms are probably psychological, rather than physical. Moderation drinking strategies may be considered if there are no contradictions. Score of 9 or more is highly indicative of a current diagnosis (DSM-III) of alcohol abuse or dependence.
14-21 (2nd quartile)	Intermediate level of alcohol dependence. Psychological problems related to drinking are likely. Psychological dependence may still be characteristic, but look for signs of physical dependence and withdrawal symptoms.
22-30 (3rd quartile) Out-Patient/	Substantial level of alcohol dependence. Physical dependence is likely. Medical disorders, psychiatric symptoms and social problems related to alcohol abuse are probable. Abstinence treatment goal should be recommended. Clients are more likely to recognize that abstinence is the only way to improve.
31-47 (4th quartile)	Severe level of alcohol dependence. dependence is highly likely. Serious psychiatric symptoms and medical disorders related to drinking - such as liver disease - are likely. Abstinence is recommended. Check for seriousness of intentions to comply with treatment.

General information

Medium age of responders 22 years 2 months (range 18-29 y)

Family status
Married 38 (4,8%)
Single 748 (94,2%)

Have children 9 (1,1%)

Children number in family
1 kid – 5 (0,6%)
2 kids - 2 (0,3%)
3 kids – 1 (0,1%)

Fig. 1. Among 794 participants, 70.0% (556) were females and 30.0% (238) were males.

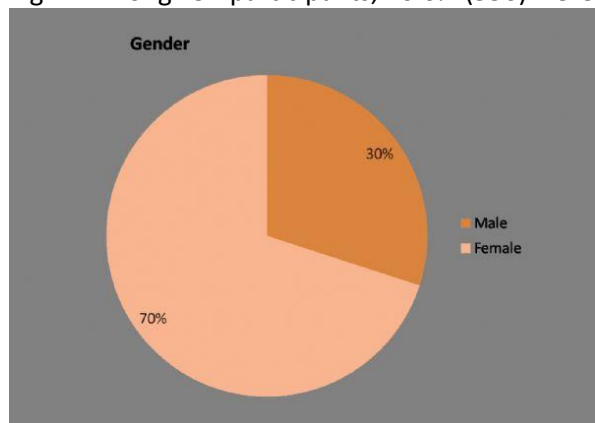


Fig. 2. 92,6% (735) of respondents had University education.

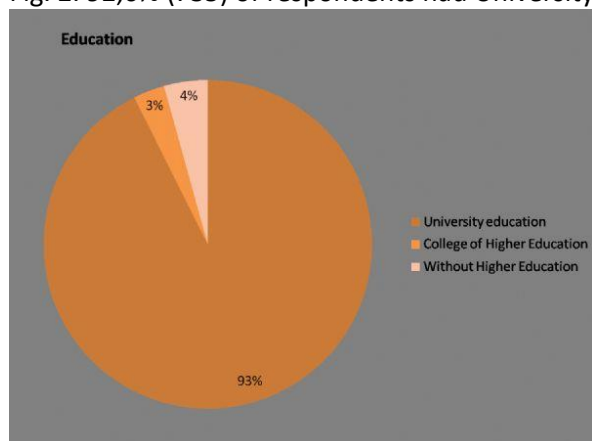


Fig. 3. 50.1% (398) of respondents lived in Capital city Vilnius.

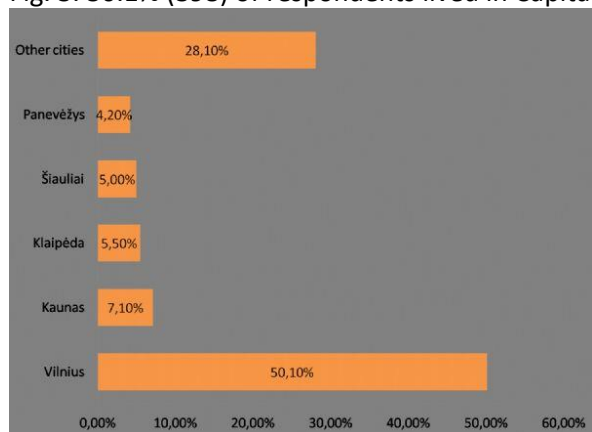


Fig. 4. Social smokers (16,8% (132) and those who smoke constantly (15% (118) have higher ADS.

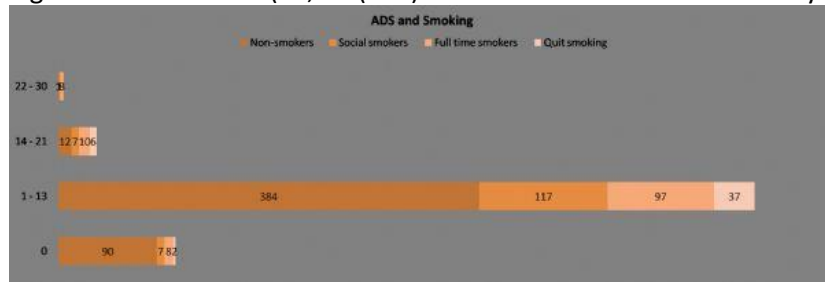


Fig. 5. 15,5% (86) of women had a significantly lower estimate of ADS than men - 11,8% (28).

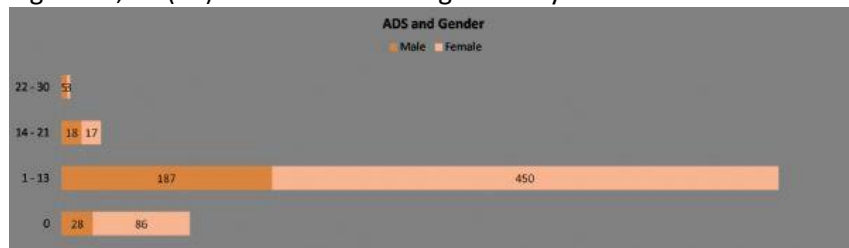


Fig. 6. The majority of subjects 41.3% (323) lived with their parents, 20.1% (157) - together with the lover.

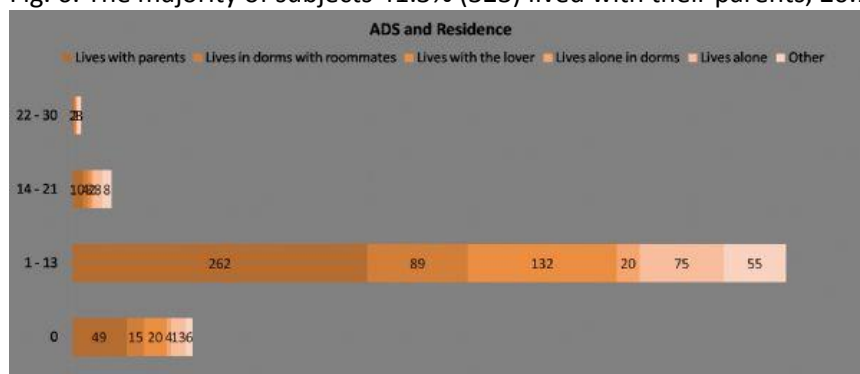
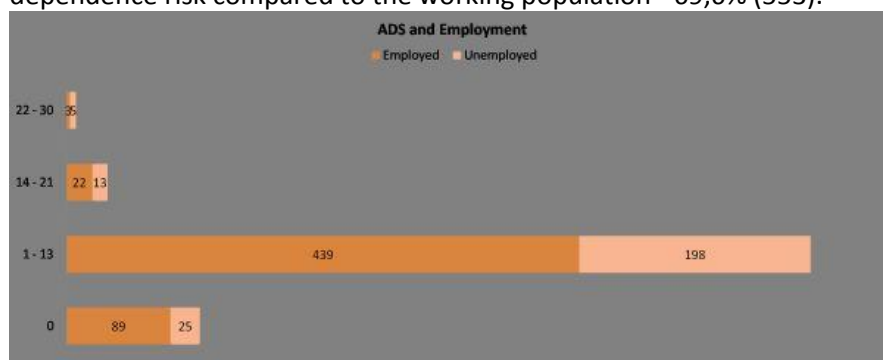


Fig. 7. Among 794 participants, 30,4% (241) were unemployed and were in a significantly larger alcohol dependence risk compared to the working population - 69,6% (553).



P-1029

Study of the impact of volatile organic compounds inside of motor vehicles on human health

Paula P Rodriguez Casal¹, Ana Belen Piñón Gamallo¹, Sandra Daponte Angueira², Enrique González De La Ballina², Iris Martinez³, Santiago Perez Cachafeiro¹, André Gameiro Mendes³

¹Department of Primary Care, Integrated Management Area Pontevedra-Salnes, Galicia, Spain.

²Department of Gastroenterology, Integrated Management Area Pontevedra-Salnes, Galicia, Spain.

³Automotive Technology Centre of Galicia, Spain

INTRODUCTION: The air pollution is one of the major impacts on public health. The OSHA (Occupational Safety and Health Administration) and the IAIAQ (Promoting actions for healthy indoor air) describe the substances involved in the poor quality of indoor air, including volatile organic compounds (VOCs) and acknowledging that these substances can produce several health effects.

OBJECTIVE: The objective of this study is to evaluate the signs and symptoms which may result from exposure to VOCs and to check if they can affect driving ability.

METHODS: We made a health questionnaire, and the study volunteers were asked about a signs and symptoms that may develop during driving. It was disseminated online in Spanish and English with the collaboration of CTAG (Automotive Technology Centre of Galicia). They were activated from August to November 2014. The data were statistically analysed.

RESULTS: 269 responses were obtained. Most respondents were women (52%) between 26-35 years old (56%). the 73% did not suffer any illness on that moment and the 74% were declared not smoker. The 98.8% of respondents regularly use a car to get around and mostly (95%) occupied the driver's seat. The most frequent symptom was fatigue or tiredness in 60.66%, appearing after more than thirty minutes of driving (49.40%), and the 38.10% said it is low intensity. The rest of symptoms occur in less than 50% of respondents.

CONCLUSIONS: Currently, although there are a lot of studies on outdoor air, research in the field of indoor air quality in vehicles is still limited. The data presented shows the need to evaluate the long-term exposure to VOCs and health risks related for drivers and passengers.

Keywords: Air Pollution, Indoor, Public Health, Motor Vehicle, Volatile Organic Compounds

Figure 1

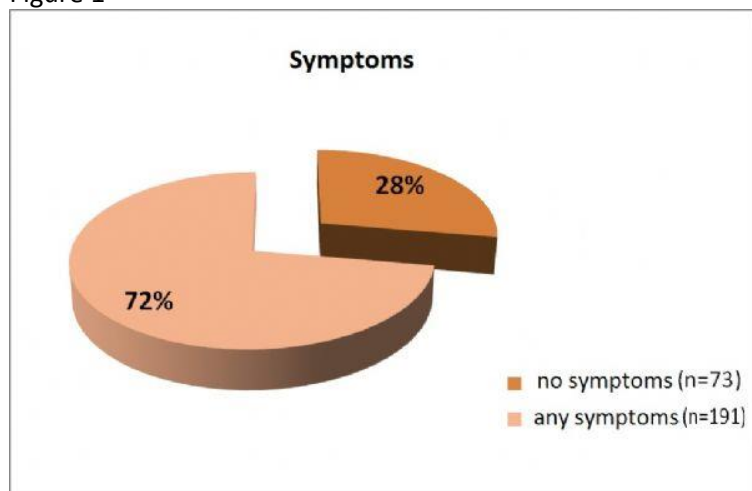


Figure 2

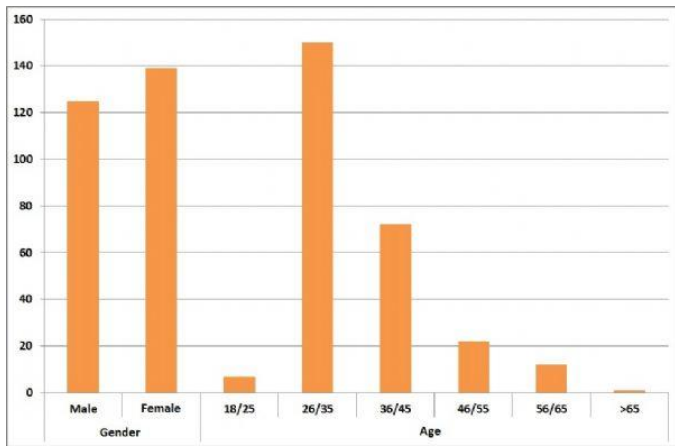
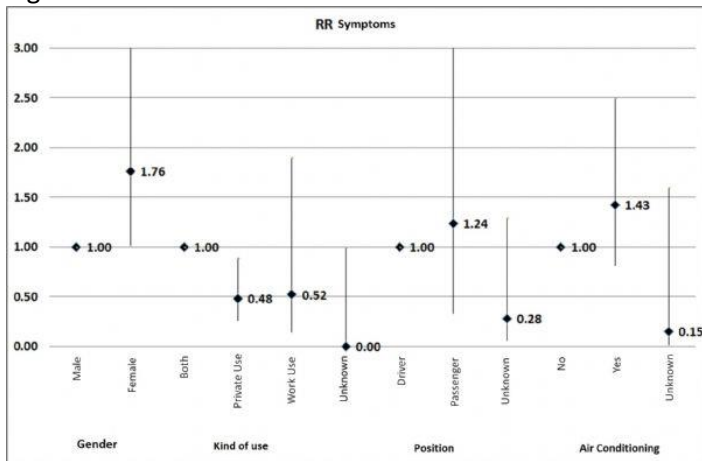


Figure 3



P-1030

Impact of Influenza Vaccination on Acute Respiratory Infections in Family Medicine

Sanda Kreitmayer Pestic, Azijada Beganlic, Olivera Batic Mujanovic
Family Medicine Department

BACKGROUND: The beginning of flu season always bring new concerns to a family medicine doctors. In this study we were interested in the relationship between influenza vaccination status and acute respiratory infections.

OBJECTIVES: To find out if there is difference among patients with chronic pulmonary diseases and chronic patients without pulmonary diseases, both vaccinated against influenza, in getting acute respiratory disease.

METHODS: This retrospective study included 138 patient records (experimental group), age 65 or more, with asthma and/or COPD who were vaccinated in 2013/2014. The controlled group was matched by age and gender, had at least one chronic disease, and were not influenza vaccinated. After reviewing 276 medical records, statistical analyses were performed. We also reviewed 70 medical records of unvaccinated patients with no chronic diseases, for additional comparison.

RESULTS: The influenza vaccinated patients with chronic respiratory diseases showed a minimal statistically insignificant difference versus the control group of influenza unvaccinated patients in catching acute respiratory infection/disease and in number of visits to their family doctor. The number of acute respiratory infections and visits to doctor was smaller in the vaccinated group compared to the unvaccinated chronic patient group. The differences were inconclusive due to small sample in the control group of patients.

CONCLUSIONS: The study showed statistically insignificant difference among both groups for acute respiratory disease and the number of visits to family doctor in the flu season.

Keywords: influenza, vaccination, COPD, chronic diseases

P-1031

Ten years profile of patients admitted to Cerrahpasa Medical Faculty, Family Medicine Outpatient Clinic

Nurver Turfaner Sipahioğlu¹, Ece Sivrel Uzun², Murat Kurul², Tuğba Durdu², Yıldız Verdi², Gamze Şenol², Selçuk Köksal³, Fikret Sipahioğlu⁴

¹Istanbul University, Cerrahpasa Medical Faculty, Department of Family Medicine M.D, PhD, Associate Professor

²Istanbul University, Cerrahpasa Medical Faculty, Department of Family Medicine M.D, Resident

³Istanbul University, Cerrahpasa Medical Faculty, Department of Public Health M.D, Assistant Professor

⁴Istanbul University, Cerrahpasa Medical Faculty, Department of Family Medicine M.D, Professor

AIM: The registered patients in family medicine department of Cerrahpasa Medical Faculty between 2004-2014 were analyzed retrospectively and the frequency of complaints and diagnoses were evaluated to create a patient profile. **MATERIAL-METHOD:** A total of 748 patients admitted to the family medicine outpatient clinic were analyzed retrospectively by student-t test and χ^2 . They were examined by either of three doctors; one resident, one senior doctor and one professor. **RESULTS:** There were 324 male patients and 424 female patients. Their mean age was 53.13 ± 15.62 for males and 55.14 ± 15.66 for females ($p > 0.05$). The referral rate was 14.4%, prescription rate was 32.9% and diagnostic tests were needed in 77.3% of patients. In the registered male patients, complaints like chest pain ($p = 0.046$) and overweight ($p = 0.02$) were more frequent than female patients. In the female patients; musculoskeletal pain ($p = 0.001$), dizziness ($p < 0.05$), dyspepsia ($p < 0.05$) and oedema ($p = 0.014$) were more commonly encountered. In male patients, hypertension ($p < 0.01$), diabetes ($p < 0.05$), hyperlipidemia ($p < 0.001$) and cardiac diseases ($p < 0.05$) were observed more than female patients whereas anemia ($p < 0.01$), thyroid diseases ($p < 0.05$), gastrointestinal system diseases ($p = 0.043$) and musculoskeletal system diseases ($p < 0.01$) were more frequent in female patients. There was no difference between referral, prescription and diagnostic tests in terms of gender. **DISCUSSION:** Hypertension, which can be diagnosed easily in primary care was the most frequent disease in this study (32.4%). This finding is in concordance with the result of the Patent 2

study conducted by Turkish Hypertension and Renal Diseases Association in 2012 in Turkey (%31.8). Hypertension was the most common disease in males (32.5%) and second most common disease in females (28.5%). Its early diagnosis is important to prevent stroke, myocardial infarction and ischemic heart disease. Malignant diseases were least encountered in the patient group. This may result from their direct admittance to related specializations. Increasing consciousness and knowledge level in screening and referral of malignant diseases in primary care is recommended.

Keywords: family medicine, outpatient, patient profile

P-1032

Assessment of retinography as a risk factor of silent brain infarcts

Rosa Forés¹, M^a Mar Domingo¹, Antonio Heras¹, M^a Teresa Alzamora¹, Judit Llussà¹, Ana M^a Altaba¹, Joaquim Fernández¹, Josep M^a Manresa², Pere Torán², Jurgi Ugarte³, Andoni Beristain⁴, Pilar Delgado⁵, Iolanda Riba Llena⁵, Anna Girona⁶, Xose Vázquez⁷

¹Institut Català de la Salut. Barcelona. Spain

²Unitat de Suport a la Recerca. Idiap Jordi Gol. Barcelona. Spain

³ULMA Innovación. Oñati. Gipuzkoa. Spain

⁴Vicomtech-IK4. San Sebastián. Spain

⁵Neurovascular Research lab. Vall d'Hebron Research Institute. Universitat Autònoma de Barcelona. Spain

⁶Hospital de Barcelona. Spain

⁷Hospital Municipal de Badalona. Spain

Background & AIM: Silent brain infarcts predict an increased risk of stroke, especially in hypertensive patients. The retinography is a useful technique that allows non-invasive visualization of the vascular tree. This study evaluates the utility of retinography with nonmydriatic fundus camera as a risk factor of silent brain infarcts in hypertensive population aged 50 to 70 years old without previous clinical stroke.

METHOD: Cross-sectional, observational, analytical study. 976 hypertensive adults aged 50 to 70 years old who underwent a Magnetic Resonance Imaging Study (MRIS) to detect silent brain infarcts in context of ISSYS project (FIS 10/00705). Case is the patient who had silent brain infarcts diagnosed by MRIS. An interview to obtain socio-demographic data, drug treatment, cardiovascular risk factors and comorbidities was performed. EKG, basic blood test and a retinography analysis by nonmydriatic fundus camera was performed in all individuals and retinal vascular abnormalities were determined. Measurement of arterio/venous ratio using semi-automatic measurement and retinal changes by Keit-Wagener classification was performed by an experienced ophthalmologist.

RESULTS: 775 participants, MRIS and retinography analysis was obtained. Silent brain infarcts prevalence was 81 (10.5%). In a multivariate logistic regression analysis a pathological arterio/venous ratio (<0.666) increases the OR: 3.85 (95% CI 2.2 to 6.8) of having silent brain infarcts and a Framingham-calibrated Registre Gironí del Cor (REGICOR risk) > 10 increases OR: 3.74 (95% 1.7 to 8.3) of having silent brain infarcts. Keit- Wagener classification grades 1-4 does not increase significantly the risk.

CONCLUSION: Pathological arterio/venous ratio and REGICOR risk charts are independent risk factors for silent brain infarcts. Arterio/venous ratio could be used as a risk factor of silent brain infarcts in order to stratify specific population into risk groups and take actions to prevent future strokes.

Keywords: Retinography, Silent brain infarcts, Risk factor

Multivariate logistic regression model, adjusted for risk Regicor to evaluate the role of the AVR Imedos as a risk factor for silent brain infarcts.

	β	OR (IC95%)	p
REGICOR RISK			
HALF	0.586	1.80 (0.9 - 3.8)	0.126
HIGH/ VERY HIGH	1.318	3.74 (1.7 - 8.3)	0.001
PATHOLOGICAL AVR	1.348	3.85 (2.2 - 6.8)	<0.001

P-1033

The Usage Level of Family Planning Method Among The Married Women Aged Between 15-49 in a Primary Health Care Region of Samsun

Mahcube Cubukcu¹, Bahadir Yazicioglu²

¹Department of Family Medicine, Samsun Education and Research Hospital, Samsun, Turkey

²Department of Family Medicine, Faculty of Medicine, Ondokuz Mayis University, Samsun, Turkey

Aim: Family planning is the planning of when to have children, and the use of birth control and other techniques to implement such plans. Other causes commonly used include sexuality education, prevention and management of sexually transmitted infections, pre-conception counseling and management, and infertility management. This study has been carried out to determine the usage level of family planning method among the married women aged between 15-49 in Vezirkopru district in Samsun.

Methods: In the district Vezirkopru of Samsun city, married women in the 15-49 age range, family physician's records about family planning methods examined retrospectively. Used or not used contraceptive methods by women were divided into groups.

Results: 937 women were included in the study age range 15-49. It was determined that 61% of the women (n=572) use a method of birth control and 39% (n=365) do not use any method. The prefer of contraceptive methods were; 146 women use traditional protection methods, 217 women had tubal ligation, 114 women's partner use condoms, 60 women have intrauterine device (IUD), 30 women take oral contraceptives, 5 women to make estrogen injections. The causes of why protection methods not used were; 44 women were breast-feeding, 110 women did not want to use any contraceptive method, 48 women wanted to get pregnant, 92 women were pregnant, 8 women were infertile, 63 women were postmenopausal.

Conclusions: Women do not know modern methods of contraception. Contraceptive methods are not used effectively. Based on these results it is recommended that patients can be informed about contraception and men be included in planned undertakings for more effective family planning services.

Keywords: Family Planning, Pregnancy, Contraception

Table 1

Protection Method	Count	Ratio
Traditional Protection	146	26%
Tubal Ligation	217	38%
Condom	114	20%
IUD	60	10%
Pill	30	5%
Estrogen Injection	5	1%
Total	572	100%

Used Contraceptive Methods

Table 2

Causes	Count	Ratio
Breast-Feeding	44	12%
Do not want to use a method	110	30%
Want to get pregnant	48	13%
Pregnant	92	25%
Infertile	8	2%
Postmenopause	63	18%
Total	365	100%

Causes of why protection method not use

Feasibility and results of abdominal ultrasound in primary care

María Cordobés Millán¹, Sílvia Crespo Blas¹, Ana Marqueño Ellacuría¹, Marc Tarín Martí¹, Angela Inés Vieira Rodríguez¹, Manel García Lareo², Yolanda Linares Sicilia¹, Diego Sebastián Yanel², José Miguel Baena Díez²

¹Resident de Medicina Familiar i Comunitària, CAP La Marina, Barcelona, Espanya

²Metge de Família, CAP La Marina, Barcelona, Espanya

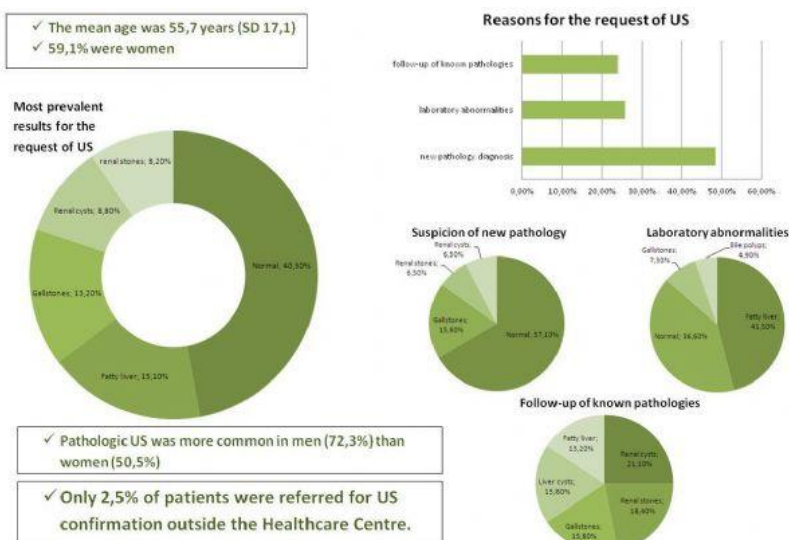
Background and aim. Abdominal ultrasound is a diagnostic tool used frequently in general practice. The aim was to study the results and feasibility of abdominal ultrasound in Primary Care.

Method. Cross-sectional study was performed in a urban health centre. 159 patients were included over a period of 14 months. Ultrasounds were performed by a general practitioner after an specific training. The protocol included the following variables: age, gender, reason for request (laboratory abnormalities, known pathologies' follow up, diagnosis of new pathology, and other reasons), and ultrasounds diagnosis. Proportions were compared using Chi-square test and the mean with t-test.

Results. The mean age was 55.7 years (SD 17.1), 59.1% were women. The most frequent reasons for the request were: diagnosis of new pathology (48.4%) laboratory abnormalities (25.8%) and known pathologies follow up (23.9%). The most prevalent results were: normal ultrasound (40.3%), fatty liver (15.1%), gallstones (13.2%), renal cysts (8.8%) and renal stones (8.2%). When new pathology was suspected the most common diagnoses were: normal ultrasound (57.1%), gallstones (15.6%), renal stones (6.5%), and renal cysts (6.5%). In the case of laboratory abnormalities the results were: fatty liver (41.5%), normal ultrasound (36.6%), gallstones (7.3%) and bile polyps (4.9%). When known pathologies were controlled: renal cysts (21.1%), renal stones (18.4%), gallstones (15.8%), liver cysts (15.8%), and fatty liver (13.2%). Pathologic ultrasound was more common in men than women (72.3% versus 50.5%, p = 0.006) and when comparing laboratory abnormality and diagnosis of new pathology (63.4% versus 42.9%, p = 0.029). Only 2.5% of patients were referred for ultrasound confirmation outside the health centre.

Conclusions. Abdominal ultrasound in Primary Care is feasible, allows the follow up of known pathologies, and permits the diagnosis of new diseases.

Keywords: ultrasound, primary care, diagnosis



P-1035

Tinnitus prevalence and effect on sleep quality

Erkan Melih Sahin, Mustafa Turan Ozdemir, Yusuf Haydar Ertekin, Aysegul Uludag
Department of Family Medicine, Canakkale Onsekiz Mart University, Canakkale, Turkey

Background & Aim

Tinnitus is a global problem effecting 278 million people and up to 15% of the population. Clinical conditions like depression and suicide are seen in about 20% of the tinnitus patients that also have serious decline in health quality mostly attributed to decline in sleep quality. The aim of this study is to determine the prevalence of tinnitus in adults living in Çanakkale, Turkey and effect of tinnitus on sleep quality.

Method

Study sample were selected from Çanakkale adult population 18 years and older who attend to primary care centers for any reason using a cluster sampling. Demographic characteristics, tinnitus symptom and medical history were questioned and Tinnitus Reaction Questionnaire (TRQ) and Tinnitus Handicap Questionnaire (THQ) were applied to detect severity of tinnitus. Subjective sleep quality was evaluated using Pittsburg Subjective Sleep Quality Index (PSQI).

Results

Tinnitus were found 36 (7.2%) of the 500 participants. Mean TRQ score was 18.8 ± 8.9 , and mean THQ score was 20.9 ± 10.3 in tinnitus patients. Mean PSQI score of the participants was 4.4 ± 2.6 and there were 171 (34.2%) people with a 5 or higher PSQI score which interpreted as worse sleep quality. PSQI score of the tinnitus patients (5.8 ± 3.1) were significantly higher than others (4.3 ± 2.5) ($U=5813$; $p=0.002$). Rate of worse sleep quality among tinnitus patients (12.3) were significantly higher than the non-tinnitus patients (4.6%) ($\chi^2=10.040$; $p=0.002$). The PSQI score did not correlate with TRQ or THQ scores.

Conclusions

The prevalence of tinnitus found lower in our region according to our results. Participants might not declare lesser symptoms that did not effect their quality of life. Our results confirmed the relation of sleep quality and tinnitus. Sleep quality should be a part of the follow-up of tinnitus patients for a proper health care.

Keywords: Tinnitus, prevalence, sleep quality

Table 1. Change of sleep quality according to the presence of tinnitus

	Mean PSQI score*	Bad sleep quality**
Tinnitus patients (n=36)	$5,8 \pm 3,1$	21 (58.3%)
No tinnitus (n=464)	4.3 ± 2.5	150 (32.3%)
Total (n=500)	4.4 ± 2.6	171 (34.2%)

* $U=5813$; $p=0.002$ ** $\chi^2=10.040$; $p=0.002$

P-1036

"The Prevalence of Internet Addiction and Related Factors among Healthcare Workers"

Dilek Kusaslan Avci, Huseyin Avni Sahin

Department of Family Medicine, Medical Faculty of Yuzuncu Yil University, Van, TURKEY

AIM:

The aim of the study was to determine the prevalence of Internet addiction and related factors among Healthcare Workers.

METHODS:

A total of 180 health workers were included in the study in a university hospital in Van. Research data were collected with a questionnaire consisting of two parts. In the first section there were 24 questions including socio demographic information, smoking and methods of coping with stress. The second section includes Turkish version of Internet Addiction Scale.

RESULT:

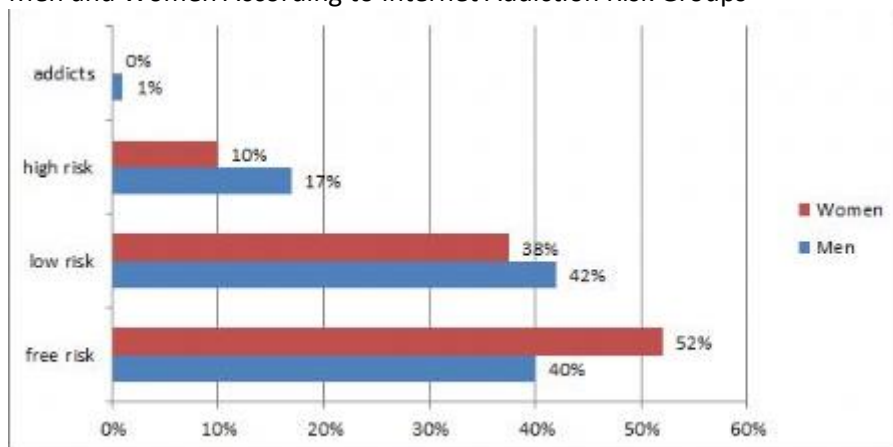
The study population consisted of 81 female (44.5 %) and 99 male (55.5 %). Participants were physicians (31.1%), nurses (47.8 %) and other employees (21.1 %). The results showed that, 57.1 % of the physicians, 53.4 % of the nurses and 31.5 % of other employees were at high-risk group. Furthermore 10 % of the females and 17 % of the males were at high risk group, 37.5 % of the females and 42 % of the males were at low risk group. The rate of chat with friends as a method of coping with stress were 61.1% in the high risk group, 40.2% in the low risk group and 22.4% in the risk-free group. The results showed that, 60.4 % of smokers and 44.3 % of non-smokers were at risk-free group.

CONCLUSIONS:

Even though Internet addiction rates were lower among participants who prefer going for a walk, reading a book, going shopping, doing housework or playing musical instruments as a method for coping with stress, were high among others. New strategies are essential in terms of gaining healthy attitudes among health workers.

Keywords: Internet, Addiction, Internet Addiction, Computer Addiction

Men and Women According to Internet Addiction Risk Groups



P-1037

Face and content validation of a symptom diary for patients with suspected urinary tract infection (UTI) in primary care

Anne Holm, Gloria Cordoba, John Brodersen

The Research Unit for General Practice and Section of General Practice, Department of Public Health, University of Copenhagen, Copenhagen, Denmark

BACKGROUND & AIM

Studies investigating UTI often include patient-reported outcomes measures (PROMs), but none of the existing PROMS were validated for complicated UTI and they had not considered that each item in a questionnaire can contribute differently to the measurement of the construct. The aim of this study was to develop and validate a condition-specific PROM on symptoms in adults with UTI in primary care divided into three domains: patient-reported symptom severity, bothersomeness and impact on daily activities.

METHOD

The study group identified symptoms and activities relating to UTI from the literature. Response categories were added to generate a first draft version of the diary. Content validity (relevance and coverage) was ensured by conducting single interviews and focus groups with women and men who had previous had at least one UTI. Participants were recruited from the university practice clinic, urological departments (men), a seniors’ activity center and the researchers’ network.

RESULTS

The first draft version of the PROM encompassed 21 items (eight symptoms and five daily activities) and response categories from 0 (none) to 3 (a lot). Two focus groups and nine single interviews resulted in 23 additional items. One item was discarded as not relevant. In the final interviews, no new items appeared, and we concluded, data saturation was reached (see table).

CONCLUSIONS

All three domains were confirmed to be relevant for patients with an UTI. The domains of symptom severity encompassed 18 items, the domain bothersomeness 18 items and the impact on daily activities domain seven items. The items included in these three domains will be psychometrically validated using the partial credit Rasch model for polytomous items.

Keywords: Urinary Tract Infections [Mesh], Symptom-diary, Patient-reported outcomes

Data collection process

	First literature search (uncomplicated UTI)	First focus group with women aged 29-63	Single interview with 1-2 women	Second focus group with women aged 70-89	Single interview with 3-6 women	Second literature search (complicated UTI)	Single interview with first man, age 64	Single interview with second man, age 72	Single interview with third man, age 60
Symptom severity	8 new items	4 new items	0 new items	1 new items	0 new items	3 new items	2 new items	0 new items	0 new items
Symptom bothersomeness	8 new items	4 new items	0 new items	1 new items	0 new items	3 new items	2 new items	0 new items	0 new items
Daily activities	5 new items	3 new items 1 discarded	0 new items	0 new items	0 new items	0 new items	0 new items	0 new items	0 new items

Item development divided into domains

Impact Of Low-Density Lipoprotein Cholesterol On Complete Blood Cell Parameters In Non Diabetic Women

Esra Durmuş, Cenk Aypak, Münevver Tulunay, Hilal Yüksel, Hülya Yıkılkan, Derya İren Akbıyık, Süleyman Görpelioğlu

Department of Family Medicine Dışkapı Yıldırım Beyazıt Research and Training Hospital, Ankara, Turkey

Background & Aim

Epidemiological and clinical studies have clearly established the link between low-density lipoprotein cholesterol (LDL-C) and atherosclerosis-related cardiovascular consequences. Whereas diabetes mellitus and obesity have been associated with leukocytosis, the relationship between serum LDL-C and other hematopoietic lineages is poorly defined. Therefore we aimed to examine the relationship between serum LDL-C and complete blood count (CBC) indices in non-diabetic Turkish women.

Methods

The study was carried out among adult women who attended routine health examination at Family Medicine outpatient clinics of Dışkapı Yıldırım Beyazıt Research and Training Hospital. Sixty, nonsmoker, non-diabetic women without hematological diseases and who were not receiving any medications known to affect blood, glucose and lipid metabolism were recruited to study. Subjects were divided into groups according to their serum LDL-C levels (group 1: LDL-C < 160 mg/dl and group 2: \geq 160 mg/dl).

Results

The mean age of the study population was years. There were no statistical differences in age, body mass index, waist circumferences, fasting blood glucose, creatinine, total cholesterol, triglycerides, high density lipoprotein-cholesterol alanine aminotransferase and white blood cell counts between two groups. LDL-C, hemoglobin, hematocrit and platelets were found to be higher in group 2. There were inverse associations among Hct, Hgb and LDL-C in group 2. ($\rho = -0.441$; $p = 0.017$ and $\rho = -0.454$; $p = 0.013$ respectively).

Conclusions

As LDL-C levels impact cardiovascular disease risk, there is a need for understanding of the underlying interactions between LDL-C and CBC components.

Keywords: Lipoproteins, LDL, hematocrit, hemoglobin, platelets, blood cell count

Clinical and laboratory characteristics	grup 1 (LDL < 160 mg/dl)	grup 2 (LDL \geq 160 mg/dl)	p
Age (years)	58.7	56	0.381
BMI (kg/m ²)	33.3	31.1	0.106
WC (cm)	103.7	100.1	0.251
LDL-C (mg/dl)	132	186.2	0.00
HDL-C (mg/dl)	46.2	53	0.053
TG (mg/dl)	148	164.9	0.330
ALT (mg/dl)	17.2	18.8	0.425
GLUCOSE (mg/dl)	87.2	89.5	0.416
WBC (10 ³ /mL)	7	7.3	0.513
RBC (10 ⁶ /mL)	4.81	4.83	0.857
HGB (g/dl)	13.2	13.7	0.031
HCT (%)	40.2	42.8	0.043
PLATELET (10 ³ /mL)	237	271.2	0.014

BMI; Body mass index, WBC; White blood cell, RBC; Red blood cell, Hgb; Haemoglobin, Hct; Haematocrit, PCT; ALT; alanine aminotransferase, TG; triglycerides, HDL-C; high density lipoprotein-cholesterol, LDL-C; low density lipoprotein-cholesterol WC; waist circumference

P-1039

Illness Perception Characteristics in Chronic Obstructive Pulmonary Disease Patients And Factors Affecting Illness Perception

Gulden Bilgin¹, Elif Cirit², Ismail Arslan², Didem Sunay³, Oguz Tekin²

¹Department of Chest Diseases, Ankara Training and Research Hospital, Ankara, Turkey

²Department of Family Medicine, Ankara Training and Research Hospital, Ankara, Turkey

³Department of Family Medicine, Kecioren Training and Research Hospital, Ankara, Turkey

Chronic obstructive pulmonary disease(COPD) is a systematic disease which is characterized with non reversible progressive airflow obstruction. In the present study, a revised form of Illness Perception Questionnaire (IPQ) was used, and the relationship between the severity of the disease and various factors of IPQ were investigated in COPD patients.

The study was carried out at the Ankara Training and Research Hospital between January and June 2014. One hundred forty-seven patients (109 males, 38 females) were included in the study. Patient selection was based on the following criteria: regular COPD treatment for a minimum of six months, age >18 years, voluntary participation, and ability to be in contact. Informed consent forms were obtained from all patients. Ethics approval was obtained from the institutional ethics committee.

The study revealed that COPD stage, age, and loss of strength had an effect on the perception of the disease as chronic. In addition, the research demonstrated a positive correlation between age and scores. We found that COPD stage, age, and pain had an effect on the perception of disease outcomes as severe. The research revealed a positive correlation between age, disease stage, and scores. The mean scores were higher in patients with pain. In conclusion, disease perception is associated with patients' experiences throughout the disease, course of disease, and coping mechanisms. The number of studies on the disease perception is limited in Turkey. We believe that our study is instructive in this field, and the investigation of different variables, which could affect disease perception, in larger study groups might contribute to the analysis of disease perception.

Keywords: Chronic Obstructive Pulmonary Disease, Illness Perception Questionnaire, Illness Perception

P-1040

Awareness of hypoglycemia symptoms in patients with type 2 diabetes mellitus

Michail Vakas¹, Kyriakoula Tsolaki², Alkmini Theochari³, Foteini Fragkoudi⁴, Sofia Kourtparasidou⁵, Nikolaos Papanas¹, Dimitrios Papazoglou¹

¹University General Hospital of Alexandroupolis, Evros, Greece

²Health Center of Sapes, Rodopi, Greece

³Health Center of Orestiada, Evros, Greece

⁴Health Center of Prosotsani, Drama, Greece

⁵Health Center of Amyntaio, Florina, Greece

INTRODUCTION: The aim of this study was to evaluate the knowledge of patients with type 2 diabetes mellitus (T2DM) on hypoglycemia in certain areas of northern Greece.

Patients and METHODS: This study included 195 diabetic patients (117 females, 78 males), who visited us in primary health care units. Of these, 77% were of rural or suburban origin. We used a questionnaire of closed-type questions.

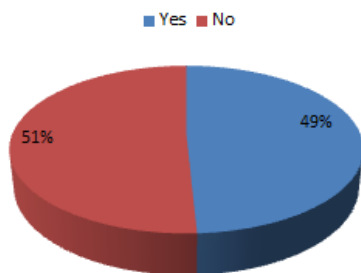
RESULTS: Overall, 195 patients, 94 (48.2%) had experienced one or more episodes of hypoglycemia from the onset of the disease, and 44 (46.8%) of those were under sulfonylurea treatment. The mean T2DM duration was 13 years. To the question "Has your physician informed you about hypoglycemia symptoms and how to cope with it?" 99 patients (50.8%) responded negatively, and to the question "Do you know what the symptoms of hypoglycemia are?" 80 patients (41%) answered that they were not aware of them.

CONCLUSIONS: A substantial proportion of our T2DM neither recognized hypoglycemia symptoms nor had been informed about them by their physician. Regrettably, almost half of primary care physicians in our region had neglected the very important task of educating patients on the symptoms and dangers of hypoglycemia.

Keywords: type 2 diabetes mellitus, hypoglycemia, symptoms

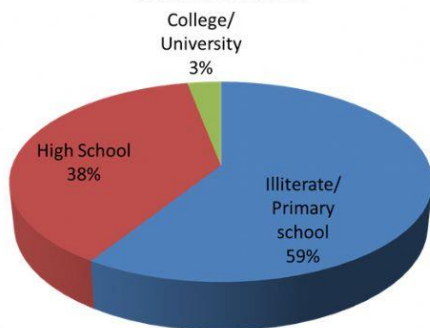
Knowledge of hypoglycemia

Has your physician informed you about hypoglycemia symptoms and how to cope with it?

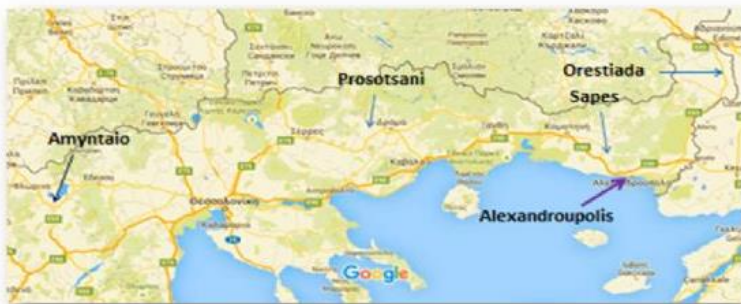


Educational level of patients

Educational level



Map of northern Greece



Symptoms of hypoglycemia as experienced by patients.

What symptoms do you have in hypoglycemia?	
sweating	other (as described by patients): dizziness, drowsiness, pain, weakness, nervousness, fatigue, tachycardia, hypotension, fainting.
hunger	
stress	
numbness	
tremors	

P-1041

Social and health problems and Family Health Strategy: a diagnosis of Vila DNOCS, a village of Brasília, capital of Brazil

Ananda Dos Santos Conde, Thiago Cavalcante Magalhães, Ubirajara José Picanço De Miranda Junior
Escola Superior de Ciência da Saúde(ESCS), Brasília, Brasil

Background & AIM: The DNOCS Village, in Federal District of Brazil, is a place with a history of migration culminating in current social and health problems character. Actually, 488 families live there and the professionals of Family Health are the only social facilities on village. These professionals are in problem, because are surrounded by violence, unemployment and lack of effective public policies, interfering in the planning of health activities in the village. **METHOD:** To understand the challenges of the local health professionals, we elaborated a social and health diagnosis from a risk scale based in the form A of the Information System for Primary Care (Ministry of Health- Brazil). This scale is based on risk sentinels and was adapted of Coelho e Savassi scales (COELHO; SAVASSI, 2011). **RESULTS:** In total were analysed 545 forms. It has been demonstrated that unemployment (in 190 families - 34.86 % of forms), Hypertension (131 families - 24.03 % of forms) and the illiteracy (105 families - 19.26% of forms), are the main problems recorded in the records. However, problems such as violence - that was experienced during the observation of the health professionals in their activities in the village - not were registered (only 1 form from 545 forms), corroborating for a misperception of the local situation. **CONCLUSION:** The results demonstrate the close relationship between health and social structure and as well the failures to registration of the health problems on the forms analysed. The systematic use of the forms can be a instrument to reorganizing the demand, but also can help not only in prioritizing home visits, as well can assist the communication between primary care and resource health managers and other social policies.

Keywords: Family Medicine; Scale Risk; Social Problems

DNOCS Village- before and actually



This is a picture of DNOCS Village: some years ago and today.

Table with the points of the Risk Scale

1 Point	2 Points	3 Points
Criteria of Scale		Occurrences
Bedridden		0
Sanitation Conditions		22
Physical Disability		4
Mental disabilities		4
Malnutrition		0
Alcoholism and Drug		10
Unemployment		190
Neurological and Psychiatric Problems		12
Family Violence		1
Diabetes mellitus		105
Illiteracy		31
Chagas Disease		7
Pregnant		16
Leprosy		1
Hypertension		131
More than 70 years		12
Less than 1 year		18
Tabagism		37
Tuberculosis		0

P-1042

"{" Vitamin D levels and related factors in patients with Hashimoto's Thyroiditis "}"

Melike Kurtoğlu Yakıcı¹, Irem Cantürk¹, Zuhale Aydan Sağlam¹, Celal Ulaşoğlu²

¹Istanbul Medeniyet University Göztepe Training and Research Hospital; Department of Family Medicine

²Istanbul Medeniyet University Göztepe Training and Research Hospital; Department of Gastroenterology

" AIM: To assess the 25-OH vitamin D(VitD) levels in patients with Hashimoto's thyroiditis(HT) and assess the relationship with some related factors.

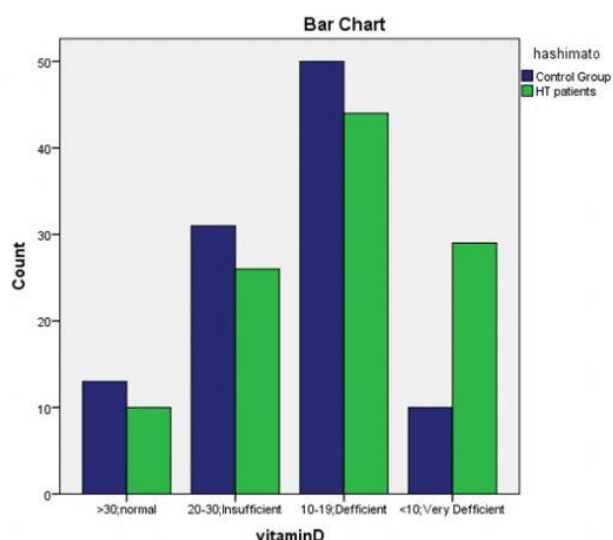
MATERIALS-METHODS: Serum VitD levels were assessed in 109 HT patients (M/F:11/98; age:53.8±14.7years) and 104 healthy euthyroid controls (M/F:24/80;age:52.4±14.7years). VitD status was defined as normal (≥30ng/ml), insufficient (20-29ng/ml), deficient (10-19ng/ml) and very deficient (<10ng/ml).The groups were analysed accordingly with related factors (age, gender, sufficiency of exposure to sunlight, TSH, B12 and being under medication of L-thyroxine).

RESULTS: Mean VitD level was lower in HT patients than controls(p=0.006) which was 17.3±9.5ng/ml and 21.1±6.8ng/ml for males, and 18.1±13.5ng/ml and 19.3±8.5ng/ml for females in HT and controls(p=0.84 vs p=0.25;resp).Defining VitD levels as normal, insufficient, deficient and very deficient revealed an increase in ratio of HT/control cases as 0.77, 0.84, 0.88 and 2.9 respectively(p=0.04)*.The geometric mean of Vit D level was 1.25±0.18 and 1.17±0.24 for HT and controls, respectively(p=0.006).Vit D levels of young, middle and old age groups in HT and control group were similar(p=0.77;p=0.10 resp.).Insufficient solar ultraviolet B exposure indicated significantly lower vit D levels in HT patients as expected(p=0.01). Age, gender, B12 level, TSH levels and receiving L-thyroxine had no significant influence on VitD levels.In median test, there was no difference between age groups of HT cases, while in young healthy group predominantly females had lower VitD levels(p=0.046).VitD was highly correlated with HT and the HT/control case ratio increased as the vitamin level decreased.Very deficient VitD group revealed a three-fold increase in the risk of HT. VitD levels were significantly influenced by exposure to solar UV-B in all groups.

Discussion and CONCLUSION: Low VitD levels seem to be related with Hashimoto's thyroiditis and appropriate sunlight exposure may be helpful for these patients. Large scaled randomised studies are necessary to clarify the role and possible benefits of VitD replacement in managing HT. "

Keywords: Hashimoto's Thyroiditis, 25-OH Vitamin D Deficiency, Low Vit D Levels

*



Vitamin D Levels of Hashimoto's Thyroiditis and Control Group

P-1043

Observational study of home visits for the Prehospital Emergency Care

Ana Isabel Beiro Piñeiro, Paula Pilar Rodriguez Casal, Elisa Romero Garcia, Carmen Arca Pichel, Santiago Perez Cachafeiro

Department of Primary Care, Integrated Management Area Pontevedra-Salnes, Galicia, Spain.

INTRODUCTION:

Prehospital Emergency Care (PEC) performs attention to patients out-of-hours health centres services and not accessible places by hospital services. There are multiple studies that investigate the demand for the PEC, but there are few publications which have described the special features of the urgent home care.

OBJECTIVE:

Our aim is to describe the features and types of urgent home care in the PEC.

METHODS:

A cross sectional study was designed. Socio-demographic and clinical data of patients seeking home health care for 6 months (September 2014 to February 2015) were collected. Different parameters of affiliation, dating, diagnosis and treatment were included. The data were treated statistically.

RESULTS:

A total of 162 visits were observed. Most (65.4%) patients were older than 76 years and they were women (64.2%). More than half of health care (56.2%) were in the afternoon, in an urban area (63%). the 48.1% of home visits were made by taxi whose were being alerted by the call centre (061) in 71% of them. About half (51.2%) remained at their home. The diseases most frequently requested were respiratory infection (24.7%), neurological disorders (21%) and certification of death (17.3%).

CONCLUSIONS:

The home visits were 2% of the total number of patients seen in these 6 months. Two parts of three were persons over 75 years. People's life expectancy is increasing, so it would be reasonable to expect in the near future more

home visits in elderly people or people confined to bed or with serious mobility limitations. This study is important in order to being prepared to what we could more frequently find in a situation with just us and our doctor's bag.

Keywords: Home Visits, Primary Health Care, Prehospital Emergency Care, Outpatient Health Service, Urgent Care

Figure 1

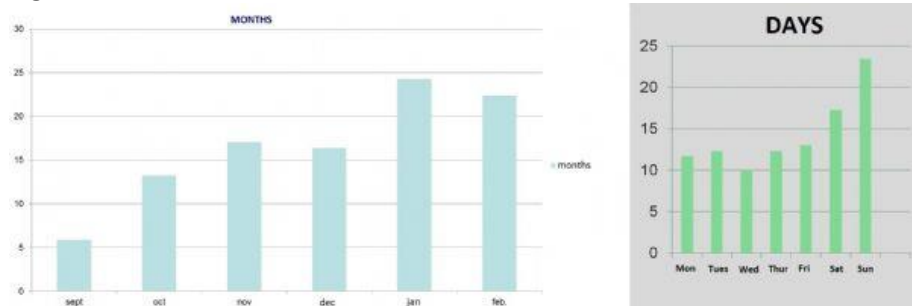
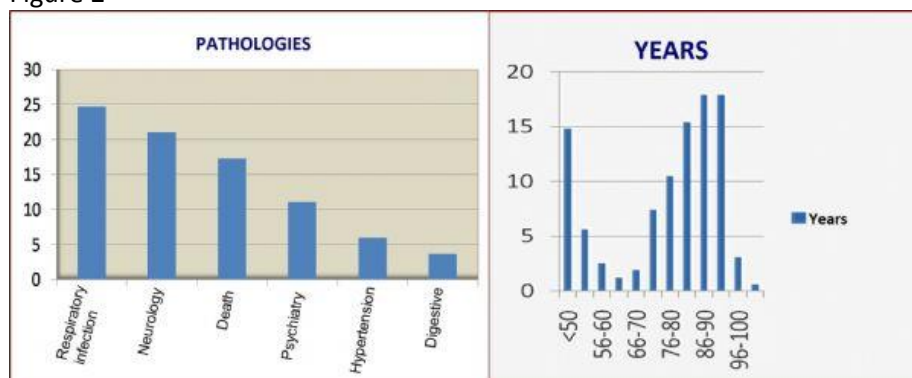


Figure 2



P-1044

Study of the impact assessment of exergames in BMI percentile range of children aged 7-14

Ana Belen Piñon Gamallo¹, Paula Pilar Rodriguez Casal¹, Santiago Perez Cachafeiro¹, Margarita Boullosa Estevez¹

¹Department of Primary Care, Integrated Management Area Pontevedra-Salnes, Galicia, Spain.

²Department of Pediatrics, Integrated Management Area Pontevedra-Salnes, Galicia, Spain.

INTRODUCTION:

Overweight and obesity on children is one of most serious problems of the public health in the century XXI. While practicing physical activity (PA) is essential for growth and health in childhood, over the last decades children sedentary has been increased. The appearance of videogames on the market which involve PA, called exergames, it creates the opportunity for children to employ more energy than is used on classic games, representing a new alternative for maintaining an active lifestyle.

OBJECTIVE:

To evaluate the association between BMI percentile range and the use of active videogames on children of 7-14 years.

METHODS:

A cross-sectional descriptive study was performed. The data was collected for 12 weeks, under parental consent. It was made with volunteer children who attended at the consultation of paediatrics in Marín (Pontevedra).

RESULTS

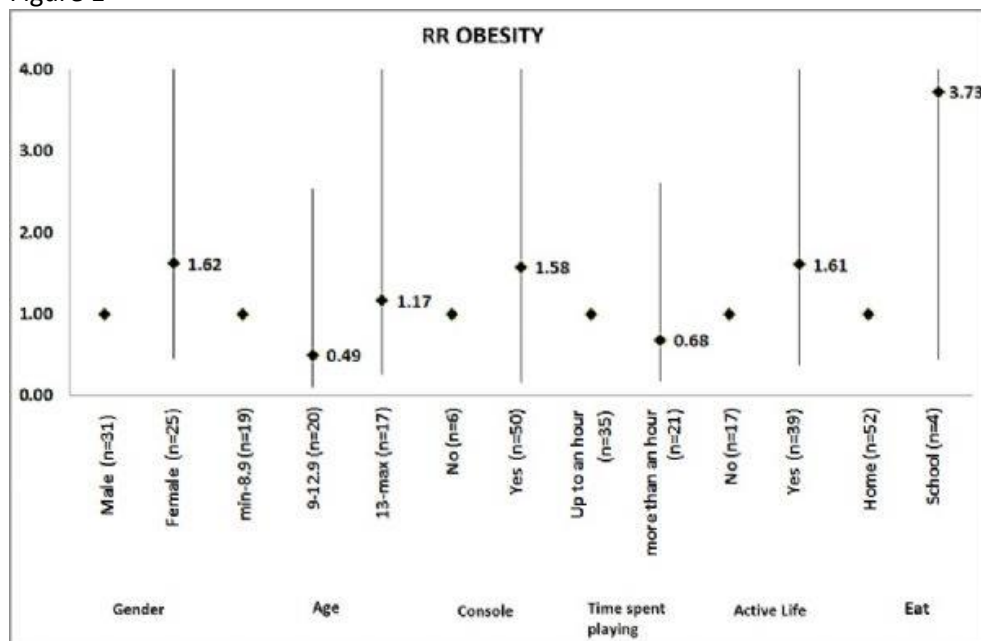
The survey of 56 children, 31 males (55.36%) and 25 women (44.64%) with a mean age of 11.10 years was performed. Approximately a quarter (23.21%) were above the 95th percentile of weight. The 89.29% have a home console, the most frequent is the Wii (51.79%) and the PlayStation (42.86%). The 69.64% of them have exergames. Only 6% of those with console are overweight, compared to 16.67% of those without. The time spent on active consoles is 1.86 hours a week, while employing 4,56hours in other aerobic activities.

CONCLUSIONS

The exergames represent a new alternative of PA which if practiced regularly it could reach the daily minimum recommended PA. However, we have to keep in mind that not all active videogames require the same intensity of PA. So we think it is necessary more research in this field.

Keywords: Exergames, Video Game, Children, Physical Activity, Exercise, Body Mass Index

Figure 1



P-1045

Drug Usage Habits of Admitted Patients to Department of Family Medicine Outpatient Clinic

Bahadır Yazıcıoğlu, Fusun Yaris, Mustafa Fevzi Dikici

Department of Family Medicine, Faculty of Medicine, Ondokuz Mayıs University, Samsun, Turkey

Introduction&Aim

Rational drug usage has been defined as "in accordance with the patients' clinical symptoms and individual characteristics in sufficient duration and dose of medication the lowest price and easily providing".

There are some criterias of it just like true indication, correct drug, appropriate dose and duration, patient informed adequately, observing the usage medication process and evaluation. Left-over drug is one of them. It is aimed to investigate the drug usage habits of admitted patients at our clinic and measure the prevalence of "left-over drugs" at home and the affecting factors.

Methods

Research was performed by 51 voluntary patients who admitted to Ondokuzmayis University Faculty of Medicine Department of Family Medicine Outpatient Clinic between 01-25 July 2014 that selected randomly. Drug usage questionnaire prepared by reviewing literature and applied to patients participating in the research. Results were analyzed with descriptive statistical tests by SPSS 16.0 packet programme.

Results

In our study, 19 men (37.3%) and 32 women (62.7%) participated. The average age of participants were 39.8 year (± 12.14). The percentage of those keep left-over drug at home was found 70.6% (n = 36). The 45.1% of patients (n = 23) apply a physician firstly, 41.2% (n = 21) begin treatment with drugs in the home and 13.7% (n = 7) await the healing of the disease without doing anything when get sick. The 78.4% of patients (n = 40) has left full or part of the prescribed medications before end of the treatment.

Conclusion

Most of participants have left-over drug at home. Approximately, half of our patients are trying to treat themselves when they are sick. It is concluded that patients use drugs irrationally, Further studies on drug usage habits and rational drug usage in society can be beneficial for the promotion of rational drug usage.

Keywords: Rational Drug Use, Leftover Drug, Drug Usage Habits

Table 1

Left-over Drug	Frequency	Percent
Yes	36	70.6%
No	15	29.4%
Total	51	100%

Keeping left-over drug at home

P-1046

Intervention for smokers through new communication technologies: What perceptions do patients and healthcare professionals have? A qualitative study

Jose Manuel Trujillo Gómez¹, Laura Díaz Gete², Carlos Martín Cantera³, Raquel Burón Leandro⁴, Elisa Puigdomenech¹, Beatriz García Rueda⁵

¹Institut Universitari d'Investigació en Atenció Primària Jordi Gol (IDIAP Jordi Gol), Barcelona, Spain

²Primary Healthcare Centre, La Sagrera, ICS, Barcelona, Spain;

³Primary Healthcare Centre, Passeig de Sant Joan, ICS, Barcelona, Spain

⁴Primary Healthcare Centre, Turo, ICS, Barcelona, Spain

⁵Primary Healthcare Centre, Navarclés, ICS, Barcelona, Spain

Background and AIMS: The use of information and communication technologies (ICTs) in the health service is increasing. In spite of limitations such as lack of time and experience, the deployment of ICTs in the healthcare system has advantages and utility for patients and health professionals. ICTs may be helpful as either interventions on their own or as complementary tools to help patients stop smoking. The aims were to gather opinions from medical professionals and smokers about an email-based application designed by our research group (TABATIC) to help smoking cessation and identify the advantages and disadvantages associated with interventions based on the utilization of ICTs for this purpose.

METHODS: A qualitative, descriptive–interpretative study with a phenomenological perspective was performed to identify and interpret the discourses of the participating smokers and primary healthcare professionals. A theoretical sample was designed for the selection of participants. Data were obtained through two techniques: semi-structured individual interviews and discussion groups, which were recorded and later systematically and literally transcribed together with the interviewer's notes. Data were analyzed with the ATLAS TI 6.0.

RESULTS: Seven individual interviews and four focal groups were conducted. The advantages of the application based on the email intervention designed by our research group (TABATIC) were said to be the saving of time in consultations and ease of access for patients who found work timetables and following a program for smoking cessation incompatible. The disadvantages were thought to be a lack of personal contact with the healthcare professional, and the possibility of cheating/ self-deception and a greater probability of relapse on the part of the smokers.

CONCLUSIONS: Patients and healthcare professionals viewed the email-based application to help patients stop smoking as a complementary aid to face-to-face consultations. Nevertheless, ICTs could not substitute personal contact in the smoking cessation program.

Keywords: Smoking cessation, Information and communication technologies, Primary health care, E-mail

P-1047

Sitting time, activities and willingness to change in primary health care patients with overweight and obesity

Elena Martínez Ramos¹, Carme Martín Borràs², Jose Manuel Trujillo Gómez³, Carlos Martín Cantera⁴, Angela María Beltrán⁵, Carme Claramunt Romero⁶, Ivette Fabián Bontempelli⁷, Laura Ruiperez Guijarro⁸, Epifania Rodrigo De Pablo⁹, Oriol Gallart Soteras¹⁰

¹Primary Healthcare Centre, Vilanova, Institut Català de la Salut (ICS), Barcelona, Spain;

²Department of Physical Activity and Sport Sciences, FPCEE Blanquerna, Universitat Ramon Llull, Barcelona, Spain

³Primary Healthcare Centre, Cuevas del Almanzora, North Almeria Region, Spain;

⁴Department of Medicine, Universitat Autònoma de Barcelona, Bellaterra (Cerdanyola del Vallès), Barcelona, Spain;

⁵Lifestyles Study Group, RedIAPP, Institut Universitari d'Investigació en Atenció Primària Jordi Gol (IDIAP Jordi Gol), Barcelona, Spain;

⁶Primary Healthcare Centre, Sant Pere de Ribes, ICS, Barcelona, Spain

⁷Primary Healthcare Centre, Lluís Millet, ICS, Barcelona, Spain

⁸Primary Healthcare Centre, Viladecans, ICS, Barcelona, Spain;

⁹Primary Healthcare Centre, Passeig Sant Joan, ICS, Barcelona, Spain

¹⁰Primary Healthcare Centre, Calella, ICS, Barcelona, Spain

Background and AIMS: Obesity and physical inactivity are associated with chronic diseases and mortality. Sedentary behavior is increasingly common in primary care consultations. The aim of the study is to determine the magnitude of this behavior in overweight and obese patients, their relationship with chronic diseases, activities that are performed sitting and their willingness to diminish them.

METHODS: Descriptive observational study. 464 mild obese and overweight patients (41.6% male, 51.9±10.10 years, 54% of them had a job) from 25 Primary Health Centres (PHC) were selected. The study variables were: age, gender, chronic diseases, prolonged sitting time and sitting activities in working and nonworking days (Marshall Sitting Questionnaire, MSQ) and willingness to diminish them (stages of change).

RESULTS: The overall median was 6.2 hours/day of sitting time on working days and 6.0 hours of non working days. 49.6% were sedentary (≥6 hours a day sitting). The most frequent pathologies were: hypertension (44.4%) and dyslipidemia (41.2%). The main sitting activities were: a) working day: work or academic activities 34.4% sitting (2.1 hours) and watching TV 33.3% (2 hours); b) non-working day: the most frequent activity was watching TV 49.9% (3 hours). Regarding to willingness to reduce the sitting time, 47.6% had not considered to change this behavior (precontemplation phase).

CONCLUSION: The present findings show that about half of patients with overweight and obesity are sedentary and therefore a high-risk group to target for reducing prolonged sitting time. Knowing that activities performed in sitting position and willingness to change will help us design interventions in primary care to reduce this behavior. The study is partially funded by Instituto de Salud Carlos III (PI11/01082).

Keywords: Overweight, Obesity, Sedentary behaviour, Sitting time, Primary healthcare

Baseline Characteristics (N=464)

Variable	N	%
Male	193	41.6
Female	271	58.4
Age (Years)		
25-35	43	9.3
36-45	71	15.3
46-55	138	29.7
56-65	212	45.7
Married	353	76.1

Singled/Widowed/Divorced 111 23.9

Baseline Characteristics 2

Variabe	N	%
Medical conditions		
High Blood Pressure	206	44.4
Dyslipidemia	191	41.2
Endocrine disease	85	18.3
Osteoarticular	67	14.4
Depression	51	11.0
Stage of Change		
Precontemplation	221	47.6
Contemplation	85	18.3
Determination	45	9.7

Description of ST (minutes/day) depending on variabes analyzed

Variable	Weekdays			Weekend days		
	Median	SD	p-value	Median	DT	p-value
Total (n= 464)	373.9	191.0		357.4	170.4	
Male	414.5	189.7	<.001	389.4	177.2	<.001
Female	345.0	186.6		334.7	161.9	
Age (yers)						
25-35	465.1	226.2	<.001	388.6	194.5	<.001
36-45	409.3	192.0		377.6	192.2	
46-55	384.3	206.1		365.3	161.9	
56-65	336.7	162.2		339.3	161.9	
Employment status						
Housewife	315.5	165.0	<.001	328	149.2	<.001
Unemployed	342.0	154.2		363.8	158.3	
Employed	413.5	210.3		359.8	181.8	
Educational Level						
Primary or Lower studies	315.5	165.0	<.001	328.4	149.2	<.001
Secondary or higher studies	435.4	197.1		388.0	185.7	
Medical conditions						
High Blood Pressure	367.4	182.2	.540	369.8	163.9	.540
Dyslipidemia	324.9	176.5	.190	340.1	154.9	.600
Endocrine disease	365.3	179.2	.390	362.5	176.5	0.10
Osteoarticular	349.9	155.5	.260	357.2	181.4	.990
Depression	347.6	169.2	.290	350.5	155.8	.750

P-1048

Is It Possible No Psychotropic In Jail?

Suat Sincan¹, Zekeriya Aktürk², Abdulkadir Kaya², Kenan Taştan²

¹Atatürk University Student Health Center

²Ataturk University Medical Faculty Department of Family Medicine

Introduction

It's usually difficult to work in a jail, as a family physician. Usually, drugs have been given for the relaxation of prisoners but unfortunately, the prisoners who have used these drugs are bleeding wounds of prison and are responsible for the majority of criminal cases in these institutions.

Method

The number of prisoners using psychotropic drugs were determined in an E type closed prison in Erzurum. Solutions and alternative treatment plans were created in a meeting with specialist physicians on Psychiatry, Neurology and Physical Therapy. Drugs that have been used by convicts who were referred to hospital, have been replaced with non-psychotropic drugs suitable for the alternative treatment. Unless medical necessity, the green prescription and psychotropic drugs were not suggested for the prisoners.

Results

164 of 550 prisoners (29.8%) were using green prescription medication, and 46 of 550 prisoners (8.3%) were using psychotropic drugs. Because of the taking these drugs high and uncontrolled doses, it was seen that 728 prisoners harming to himself and someone else in the form of cut were happening per year. Six months later, the number of prisoners using green prescription drug decreased to 0 (0%) and the number of prisoners using gabapentin, etc. 11 (2%). After the first year, a total of 8/ year, at the end of the second year 4 / year were encountered with a cut in the form of self-mutilation incident, depending on the dose of drug intake inappropriately.

Discussion

Prisons are places that are difficult for physician because of incompatible prisoners and the drugs they use. These drugs are given to prisoners to pacify them, may cause greater legal and illegal problems. Therefore, if there in no indication, such drugs avoid prescribed, can significantly reduce criminal incidents that may arise in prison.

Keywords: Green prescription, Prison, Harming to himself

P-1049

Results Of Fecal Occult Blood Screening Among Prisoners

Suat Sincan¹, Zekeriya Aktürk², Abdulkadir Kaya², Kenan Taştan²

¹Atatürk University Student Health Center

²Ataturk University Medical Faculty Department of Family Medicine

Introduction

Given to the prison health services, the Ministry of Justice, the Ministry of Internal Affairs and the Ministry of Health's signed together the 'Triple Protocol' which was implemented after the Health Transformation project in Turkey. Thus, according to the regulations and provisions of all tasks assigned to the tripartite protocol, family physicians should be employed in prisons. One of these tasks is fecal occult blood screening in between 50-70 years old people.

Methods

In this study, we examined convicts and arrested people who stayed in Campus of Erzurum Prison and all males from 50 - 70 years were enrolled in this study. The study protocol has explained, those who accepted to participate in the study, filled the informed consent form. A questionnaire for demographic data were obtained. Results positive, has been consulted by the relevant departments to treatment and follow-up program in Erzurum Regional Training and Research Hospital and colonoscopy was applied.

Results

Out of 1452 prisoners 189 (13%) were identified between the ages of 50-70. 161 prisoners (11%) who participated in the study from 189, fecal occult blood test were applied. Out of 24 positive (1,6%), 22 patients (1,5%) underwent colonoscopy in Erzurum Regional Training and Research Hospital. 2 convict did not want to make colonoscopy. In 8 (0,5%) identified hemorrhoids while in 2 (0,1%) hyperplastic polyps, in 1 (0,05%) tubular adenomas, in 1 (0,05%) colon cancer is detected. In 10 (0,6%) were found to be normal colonoscopic findings.

discussion

Therefore, family physicians working in prisons, do precisely defined tasks in family medicine and triple protocol provisions of regulations while avoiding unnecessary referrals to allow granting effective health care; will protect the doctor from legal point of view. In prisons, it is necessary to do the screening tests for early diagnosis and treatment of major diseases.

Keywords: Health Law, Family Medicine, Health in Prison

P-1050

Assessment of anxiety, problem solving and personality traits of the patients who were admitted to smoking cessation clinic

Özlem Büyükçiçek¹, Yarkin Özenli², Kenan Topal¹, Nurgül Bozkurt³, Önder Tuğal², Çiğdem Gereklioğlu⁴

¹Adana Numune Training and Research Hospital, Department of Family Medicine, Adana/Turkey

²Adana Numune Training and Research Hospital, Department of Psychiatry, Adana/Turkey

³Denizli State Hospital Chest Diseases Clinic, Denizli, Turkey

⁴Baskent University Medical Faculty, Department of Family Medicine, Ankara/Turkey

BACKGROUND: Smoking is among the major causes of fatal diseases. The difficulty of smoking cessation is assumed to arise from genetic and environmental factors beside the psychopharmacologic effects of nicotine. Socioeconomic status and personality traits have not been investigated intensively. We aimed to investigate anxiety, problem solving ability, personality traits and their relationship with nicotine addiction level in smokers.

MATERIAL-METHOD: This cross-sectional case-control study was conducted with 132 patients and 126 volunteers. State-Trait Anxiety Inventory (STAI FORM TX-1, STAI FORM TX-2), Problem Solving Inventory (PSI), Eysenck Personality Inventory and Fagerström Test were used for assessments. Smokers were asked to fulfil the all tests, non-smokers did not fulfill Fagerström Test.

RESULTS: While mean age was 35.15±10.12 years for smokers, it was 36.93±11.27 for non-smokers. State anxiety scores were 43.7±4.9 and 45.1±5.3 for smokers and non-smokers, respectively (p=0.03). Trait anxiety scores were 48.9 ±6.2 and 46.3±4.7 for smokers and non-smokers, respectively (p=0.000). Mean Fagerström test score was 5.04±2.81 for smokers. Mean Problem Solving Inventory score was 113.9±26.6, and 96.1±29.8, respectively for smokers and nonsmokers (p=0.000). The mean score of neuroticism was 3.52 ± 1.80 and 2.21±1.77 for smokers and non-smokers, respectively (p=0.000). Mean score of psychoticism was higher among smokers (1.93±1.37 vs 1.48±1.29, p=0.008). There was no statistically significant difference between groups in terms of extraversion (p=0.71). Mean score of lying was 3.85±1.50 and 4.30±1.35 for smokers and non-smokers (p>0.80).

CONCLUSION: It is not a reasonable approach to focus on only the organic diseases in nicotine addiction. Psychiatric examination, psychological tests should be performed and the disorders should be treated. In this context, it is important to follow a holistic, biopsychosocial approach and provide psychiatric support. Our study reveals the need for adopting a multidisciplinary approach in treatment of nicotine addiction.

Keywords: nicotine addiction, personality, problem solving, anxiety

P-1051**Prevalence of functional dyspepsia and associated psychological factors, in the urban area of Leon Municipality, Nicaragua. A Community Based Study 2003 – 2004**Edgar Martin Peña¹, Nawi Ng², Douglas R Morgan³¹Multiprofessional Teaching Unit of Family and Community Care-Zaragoza II Sector, Zaragoza, Spain. Centre for Epidemiology and Health Research, University of Nicaragua, León.²Unit of Epidemiology and Global Health Umeå University, Sweden³Department of Medicine, Vanderbilt University, Nashville, TN, USA. Department of Medicine, UNC Chapel Hill, NC, USA.

BACKGROUND: The diagnosis and classification of Functional Dyspepsia in the general population has been a focus of researchers since the 1980s. Nonetheless, there are few community-based studies on this issue, particularly in Latin America. **AIM:** To measure the prevalence of functional dyspepsia and to analyze the psychological factors associated with functional dyspepsia, in the urban area of Leon, Nicaragua. **METHODS:** The study design is a cross-sectional survey, with household interviews. It was conducted within a demographic and health surveillance system (DHSS) of the Leon Municipality, Nicaragua. A sample of 1617 inhabitants (18 to 65 years old) was randomly selected from the DHSS. Three different instruments were used: the Rome II modular questionnaire to measure Functional Dyspepsia, Harvard-Uppsala trauma questionnaire focused on posttraumatic stress, rape and war experience; and finally conflict tactic scales to determine domestic violence. Socioeconomic Status (SES) was measured with the poverty index based on unsatisfied basic needs. **RESULTS:** The prevalence of functional dyspepsia in the community was 11.6%, affecting more females (12.6%) than males (10.2%). Domestic violence was significantly associated with Functional Dyspepsia in the logistic regression model (OR: 1.61, IC95% 1.10, 2.37). **CONCLUSIONS:** The prevalence of Functional Dyspepsia was 11.6%. Domestic violence was identified as an important independent risk factors for functional dyspepsia our final logistic regression model. **ACKNOWLEDGEMENTS:** This study was supported by a grant from the Rome Foundation (DM). The study infrastructure was provided for by the Centro de Investigación en Demografía y Salud (CIDS, Center for Epidemiology and Health) of the University of Nicaragua, León, as a member of the global INDEPTH Network

Keywords: Functional dyspepsia, Prevalence, Nicaragua, Survey, domestic violence

Functional Dyspepsia and psychologic exposures, stratified by sex and age.

Variable	Total n (%)	Women n (%)	Men n (%)	p Value	(18 - 34) n (%)	(35 - 44) n (%)	(45 - 65) n (%)	p Value
Functional dyspepsia	188 (11.6)	121 (12.6)	67 (10.2)	0.148	101 (12.4)	45 (12.8)	42 (9.3)	0.187
YES	1429 (88.4)	841 (87.4)	588 (89.8)		712 (87.6)	307 (87.2)	410 (90.7)	
NO								
Poverty	550 (34.0)	323 (33.6)	227 (34.7)	0.203	279 (34.3)	130 (36.9)	141 (31.2)	0.277
YES	1067 (66.0)	639 (66.4)	428 (65.3)		534 (65.7)	222 (63.1)	311 (68.8)	
NO								
Domestic Violence	299 (18.5)	216 (22.4)	83 (12.7)	< 0.001	134 (16.5)	87 (24.7)	78 (17.3)	0.003
YES	1318 (81.5)	746 (77.6)	572 (87.3)		679 (83.5)	265 (75.3)	374 (82.7)	
NO								
Rape	140 (8.7)	80 (8.3)	60 (9.2)	0.351	48 (5.9)	43 (12.2)	49 (10.8)	< 0.001
YES	1477 (91.3)	882 (91.7)	595 (90.8)		765 (94.1)	309 (87.8)	403 (89.2)	
NO								
War Experience	194 (12.0)	60 (6.2)	134 (20.5)	< 0.001	13 (1.6)	96 (27.3)	85 (18.8)	< 0.001
YES	1423 (88.0)	902 (93.8)	521 (79.5)		800 (98.4)	256 (72.7)	367 (81.2)	
NO								
Total	1617 (100.0)	962 (100.0)	655 (100.0)		813 (100.0)	352 (100.0)	452 (100.0)	

In statistical terms, women experienced more physical, emotional or sexual abuse (domestic violence) in comparison with men (p value < 0.001). Otherwise men have statistically significant relation with the war experience in relationship with women (p value < 0.001)

Association of functional dyspepsia with psychologic exposures, using univariate and logistic regression models of analysis.

Risk Factor	Functional dyspepsia		Univariate		LogReg Model	
	YES	NO	ORc	IC95%	ORadj	IC95%
Domestic Violence	NO	137	1181	1		1
	YES	51	248	1.72	1.18 - 2.49	1.61
Rape	NO	165	1312	1		1
	YES	23	117	1.56	0.97 - 2.51	1.52
War Experience	NO	167	1256	1		1
	YES	21	173	0.91	0.56 - 1.47	1.09
Poverty	NO	111	956	1		1
	YES	77	473	1.40	1.02 - 1.91	1.33

In our univariate model, FD was statistically associated only with domestic violence and poverty. The likelihood to have FD increased 72% with experience of domestic violence and 40% with poverty compared to without these conditions, after controlling for gender and age. We hypothesized that the self-reported experience of domestic violence, rape and war experience would be correlated with each other (multicollinearity). To know the existence of correlation influence between these variables we analyzed the applied variance inflation factor (VIF) and tolerance following for the logistic regression model. The results obtained in all variables were under 1.16 for VIF and above 0.86 for tolerance, showing little relationship between them. Therefore, we included all variables in the regression model adjusted by age and gender. The final result suggested that a person exposed to domestic violence was 61% more likely to develop FD compared to those who did not experience domestic violence, regardless of gender, age or other studied exposures.

P-1052

The Evaluation Of The Patients Who Have Complaint with Headache Sociodemographic Features and Migraine Awareness

Selin Haliloğlu¹, Sefer Günaydın², [Seçil Arıca](#)¹

¹Department of Family Medicine, Haseki Education and Research Hospital, Istanbul, Turkey

²Department of Neurology, Haseki Education and Research Hospital, Istanbul, Turkey

AIM: Headache is a very common complaint and we wanted to analyze the relationship of the differences between migraine awareness, knowledge and sociodemographic features among the unresolved patients complaining from headache.

METHOD: We established a uniform survey which was filled by the same researcher. 105 patients were enrolled to obtain information about their sociodemographic profiles (age, sex, education level, marital status, occupation, salary), alcohol consumption and smoking, concomitant chronic diseases, quality of sleep, relatives with headache complaint, headache attack features (onset and the attack periods) medications used before and

the patient knowledge about migraine. The patients who were diagnosed with migraine earlier were excluded from the survey.

RESULTS: 105 patients with headache complaints were enrolled in this research among whom 49 were males and 56 were females. The average age was 35.1 ± 11.3 . The patients claiming to have knowledge about migraine was 53.3 % (56) of the group. Among this group 21.4 % (12) claimed to get their knowledge from their family, 23.2 % (13) from friends, 26.8 % (15) by searching the web, 28.6 % (16) from their doctor. The patients who believed that neurology department was the right place to diagnose migraine and establish migraine awareness was 66.1 % (37) while 28.6 % (16) believed family medicine is the right place to do so. The most significant parameters in our survey are found to be age $p=0.026$, education level $p<0.001$ and pain period $p=0.001$ to analyse migraine awareness. The patients' knowledge level is decreased proportionally by age and in contrast increased with education level and pain period.

CONCLUSION: This research shows that migraine awareness is more common among the highly educated people with high socioeconomic positions in society. Gender does not make any difference about the awareness, however it is noticeable that there is no relation between age, sleep time and headache attack periods.

Keywords: Headache, migraine, awareness

P-1053

Results of infectious diseases screening in among prisoners

Suat Sincan¹, Zekeriya Aktürk², Abdulkadir Kaya², Kenan Taştan²

¹Atatürk University Student Health Center

²Ataturk University Medical Faculty Department of Family Medicine

Introduction

Given to the prison health services, the Ministry of Justice, the Ministry of Internal Affairs and the Ministry of Health signed together the 'Triple Protocol' which was implemented after the Health Transformation project in Turkey. Thus, according to the regulations and provisions of all tasks assigned to the tripartite protocol, family physicians should be employed in prisons. One of these tasks is screening of infectious diseases on risk groups.

Methods

We examined prisoners who stayed in Campus of Erzurum Prison. The study protocol has explained, those who accepted to participate in the study, filled the informed consent form. A questionnaire for demographic data were obtained. From the blood samples, hepatitis, syphilis, acquired immune deficiency syndrome markers were investigated in the Erzurum Public Health Laboratory. Hepatitis B vaccine was applied to those with the negative markers.

Results

We examined 1108 prisoners who stayed in Campus of Erzurum Prison. 967's (87,2%) no markers were positive. We were applied hepatitis B vaccine for those people. On 99 prisoners (8.9%), hepatitis B antibody have been identified. On 3 prisoners (0,3%) VDRL positivity was detected. On 29 prisoners (2.6%) were identified carriers of hepatitis B, on 7 prisoners (0,7%) hepatitis C positivity was detected. Hepatitis B carriers who were identified 17 cases (1.5%) were newly diagnosed. On 4 prisoners (0,4%), including two foreign nationals, acquired immunodeficiency syndrome have been identified.

Discussion

Prisoners can go to hospital only with a referral from a family physician. Therefore, family physicians working in prisons, do precisely defined tasks in family medicine and triple protocol provisions of regulations while avoiding unnecessary referrals to allow granting effective health care; will protect the doctor from legal point of view. In prisons, it is necessary to do the screening tests for early diagnosis and treatment of major diseases.

Keywords: Health Law, Family Medicine, Health in Prison

P-1054

Osteoporosis in a Primary Health Care Unit

Nuno Namora, Maria João Abreu, Maria Inês Madureira, Tiago Ribeiro, Luísa Ferraz, Fernanda Rodrigues
USF DuoVida - ACES Alto Ave, Portugal

BACKGROUND: Osteoporosis is characterized by decreased bone mass and microarchitectural deterioration of bone, leading to increased risk of fracture. Osteoporotic fractures represent a major public health problem because of its high prevalence, medical consequences, decreased in quality of life and economic and social costs. Recent studies indicate that the prevalence of osteoporosis in Portugal is 10.2%.

AIM: Determine the prevalence and characterize the osteoporosis in the population of a primary care unit.

METHODOLOGY: Observational, descriptive, analytical and transversal study in adult patients of a primary care unit with the osteoporosis code (L95) of the International Classification of Primary Care - 2nd edition. Through consultation of the electronic health records in February 2015, the following variables were gathered: gender, age, body mass index (BMI), smoking, alcohol, diabetes mellitus, hypertension, previous fracture, DEXA and therapy. Statistical analysis was performed in SPSS.

RESULTS: The prevalence of osteoporosis was 0.45% (n = 68), with a mean age of 69 years. 89.7% patients with osteoporosis were female, 91.2 % were non-smokers and 8.8% had a previous fracture. The population average BMI was 28.6 kg/m². The average alcohol consumption was 52.97g/week. In terms of comorbidities, 10.3% were diabetic and 42.6% were hypertensive. DEXA was performed in 29.4% patients, 30% of which performed it within the last 5 years. In terms of DEXA results, 15% had normal criteria, 40% showed osteopenia and 45% had osteoporosis. With regard to therapy, in 61.8% of cases it was prescribed at least one bisphosphonate.

DISCUSSION: The prevalence of osteoporosis found is much lower than reported in the literature, which can be justified by the absence of medical records. It is therefore necessary to alert physicians to the correct fulfilment of diagnostic criteria. This will allow the General Practitioners a more direct intervention through pharmacological and non-pharmacological measures.

Keywords: Osteoporosis, Primary Care

Figure 1: Distribution of patients by gender, %(n)

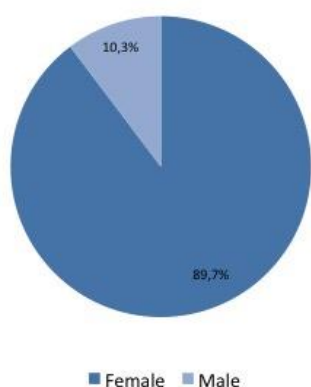


Table 1: Demographic characteristics of patients

	Age, years	BMI, kg/m ²	Alcohol, g/week
Mean ± SD	69.1 ± 10.3	28.6 ± 4.9	52.97 ± 119.5
Minimum	38	18.9	0
Maximum	88	42	672

BMI – Body mass index; SD – Standard deviation

Table 2: Distribution of patients comorbidities and risk factors by gender

	Smokers	Previous fracture	Diabetes	Hypertension
Female	33.3%	83.3%	85.7%	86.2%
Male	66.6%	16,7%	14.3%	13.8%
Total (n=68)	4.6%	8.8%	10.3%	42.6%

Figure 2: DEXA

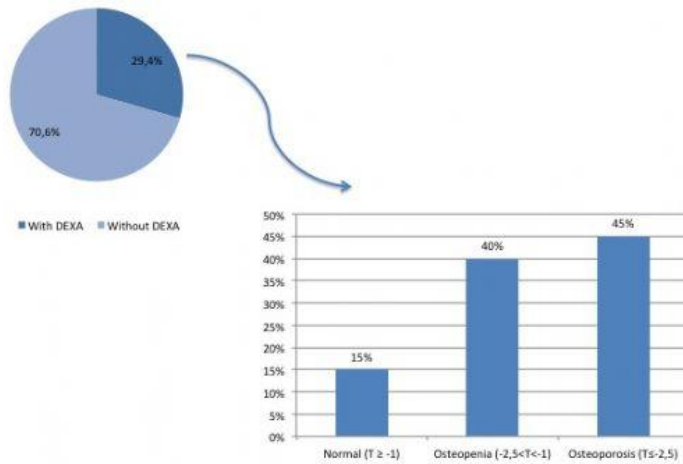
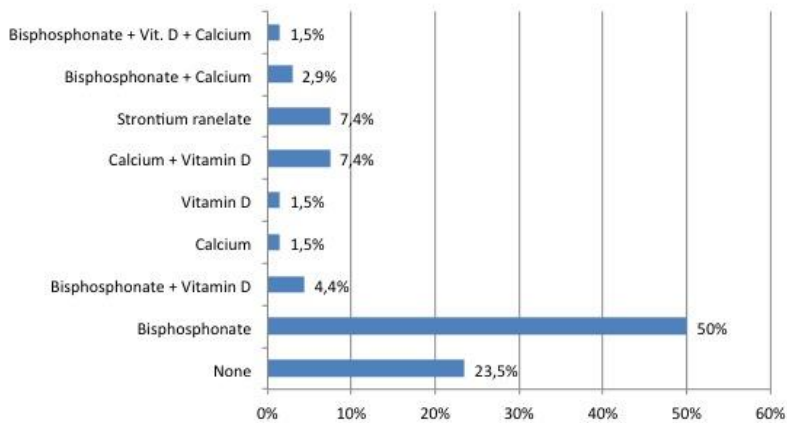


Figure 3: Therapeutics



P-1055

Serum alkaline phosphatase level as an early diagnostic tool in colorectal cancer

Bojan Zoran Pavkovic, Marina Slobodan Brankovic, Marija Marjan Zaric

Department of General Practice, Health Center "Dr Simo Milosevic"

Background&Aim

Serum alkaline phosphatase (ALP) levels is frequently elevated in patients with colorectal cancer (CRC). The significance of ALP as a predicting tool for CRC is not sufficiently well recognized.

The aim of study was to evaluate correlation between serum ALP levels as nonspecific blood test, fecal occult blood test (FOBT) as screening method for gastrointestinal bleeding, carcinoembryonic antigen (CEA) values as tumor marker and colonoscopy findings as final diagnostic procedure for CRC.

Method

The retrospective, observational study involved 151 patients, aged 50-74 years, whose medical records were reviewed and statistical analysis was done to evaluate the significance of ALP as predicting tool for CRC.

Results

A total of 151 patients were divided into two groups.

Observed population consisted of 73 patients, 41 females (56%) and 32 males (44%), who underwent colonoscopy which revealed the existence of tumor masses, and pathological findings confirmed malignancy.

Control group consisted of 78 patients, 42 females (54%) and 36 males (46%), from the general population, all without confirmed malignancy.

For a period of six months before further diagnostic procedures increased levels of ALP were recorded in 39 patients (53%) in observed population and in 13 patients (17%) in control group. There was statistically significant difference ($p < 0.005$).

CEA levels were elevated in 25 patients (34%) before colonoscopy is performed.

It was found that 23 patients (92%) with elevated levels of CEA had also increased levels of ALP.

FOBT was positive in 70 patients (96%), and in all who had increased levels of ALP.

Conclusions

Increased levels of serum ALP is associated with CRC. It is nonspecific blood test, but should arouse suspicion of CRC among other pathologic entities.

It is advisable to use of serum ALP levels as early diagnostic predicting tool for CRC, because it is a simple, low cost and relatively sensitive method.

Keywords: Serum alkaline phosphatase levels, Colorectal cancer

P-1056

Modern management of severe knee osteoarthritis with low power lasertherapy(L.L.L.T) associated with local steroid infiltration versus conventional therapy by GPs

Mihai Sorin Iacob, Sorina Saftescu, Adriana Carpinisan

Department of Family Medicine, Advitam Medicis Medical Center, Timisoara, Romania.

BACKGROUND: Knee osteoarthritis is a degenerative arthropathy, progressive, disabling, affecting elders, characterized by degradation of joint cartilage, bone remodeling and inflammatory changes in the synovial membrane. This study aims to present the results of LLLT, with red and infrared emission with 1800mW in comparison with classic therapy.

METHOD: We conducted a prospective, randomized, controlled study over three years, on 450 patients, using two laser devices. Imaging (US, MRI, x-ray), along with biomarkers were performed to make an accurate and fast diagnosis.

Inclusion criteria were: obese patients older than 60 years, with moderate / severe knee osteoarthritis, documented on X-Ray:II-III grade by Kellgren-Lawrence Scale.

Exclusion criteria were: other comorbidities with organ failure, diabetes, malignancies, fracture history, treatment with systemic corticosteroids, anticoagulants.

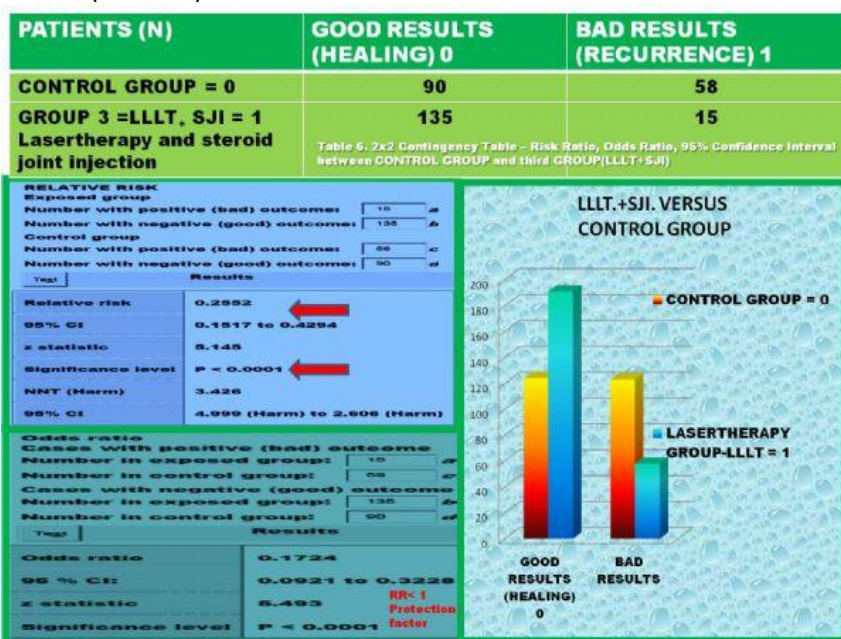
Cases studied were divided randomly into three groups: first - the Control Group received only conventional therapy: NSAIDs and analgesics, second includes patients treated with lasertherapy LLLT and third includes patients treated with local steroid infiltration associated with lasertherapy. The therapeutic protocol that we followed were: LLLT radiation density 4 - 10 J/cm², pulsed emission 9 Hz, IR spectrum radiation 870 nm and for joint infiltration we used Dexamethasone 4mg/ml with five exposures.

RESULTS: Elements evaluated in each patient before and after treatment were: pain on a Visual Analogue Scale (VAS), motion functional Scale, joint mobility, the quality of life, radiological changes. Our cure rates were: 60% in the first, 70% in the second and 90% in the third group of patients, with appreciation of personal satisfaction between 7 and 10 and significant reduction of pain, p<0,001, Relative Risk 0,40(Benefit), 95%CI 0,27 to 0,59, Odds Ratio 0,25 for exposed group with LLLT.

CONCLUSIONS: The combination of LLLT with steroid infiltration significantly improved outcome by 30% compared to those treated conventional. Laser therapy treatment is non-invasive, painless and shows excellent tolerance.

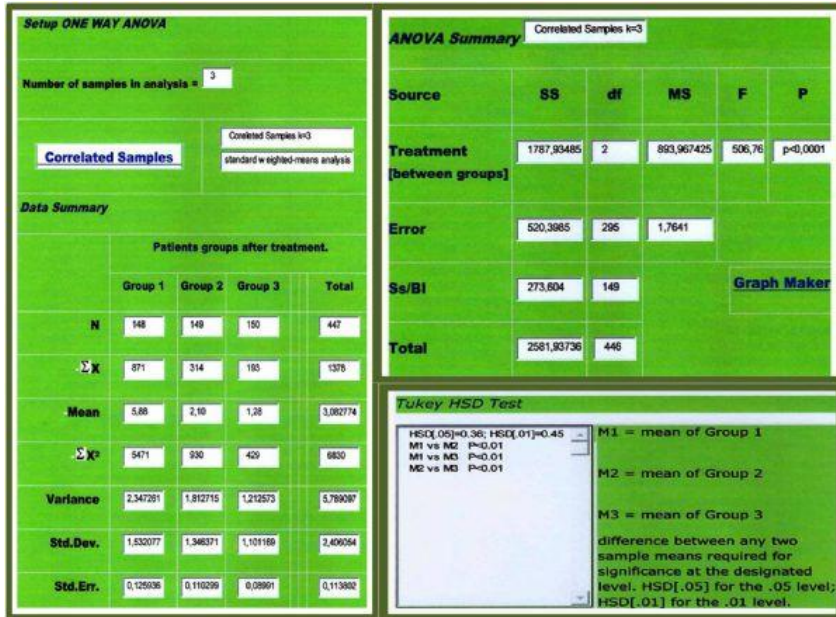
Keywords: Low Power Laser Therapy (LLLT), Knee Osteoarthritis, Local steroid infiltration.

2x2 Contingency Table with Risk Ratio, Odds Ratio, 95% Confidence Interval between CONTROL GROUP and third GROUP(LLLT+SJI)



2x2 Contingency Table with Risk Ratio, Odds Ratio, 95% Confidence Interval between CONTROL GROUP and third GROUP(LLLT+SJI)

Anova statistical analysis of the results after Therapy in the three groups of patients.

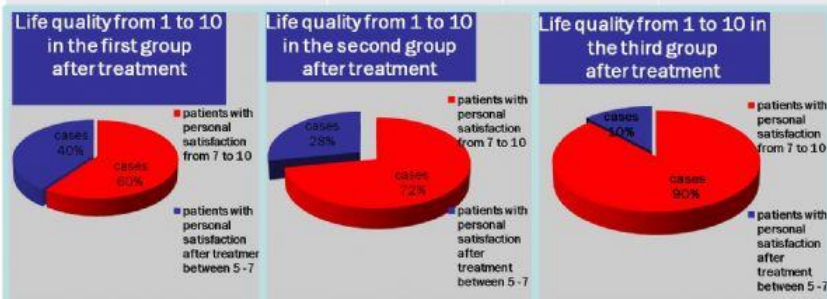


The best results of the study was in third Group, after Laser therapy associated with local steroid infiltration, p<0,001

Descriptive analysis of cases in the three groups.

RESULTS AND DISCUSSION:

n(%) or Mean ± SD	Control Group n=150	Laser therapy Group n=150	Laser therapy and steroid infiltration Group n=150
Age (years)	67.8 ± 5.4	66.8 ± 5.8	68.6 ± 5.8
Body weight (kg)	92±14	95±16	96±18
Female Gender- Sex Ratio=3:1	86 (66%)	84 (65%)	86 (66%)
Smoker (40+pack- years)	51 (39%)	47 (36%)	53 (41%)
History of diabetes	13 (10%)	17 (13%)	12 (9%)
History of Fractures	5 (4%)	8 (6%)	4 (3%)



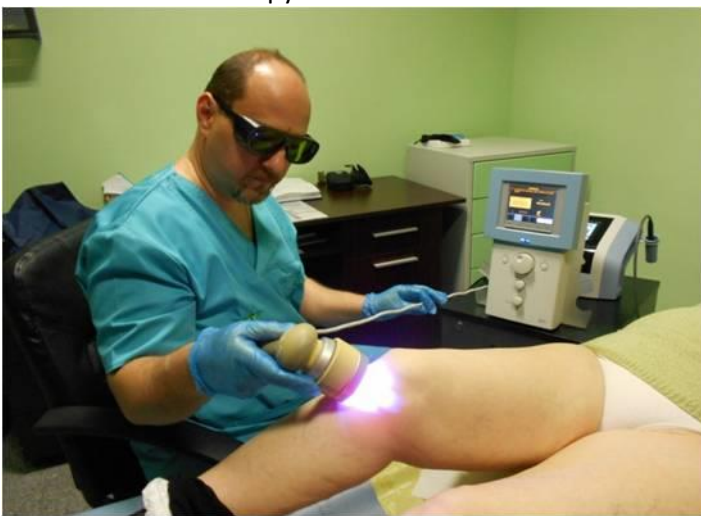
Characteristics of 450 Subjects enrolled in Knee OA treatments Trial by Randomization Status.

LLLT and Steroid Joint Infiltrations



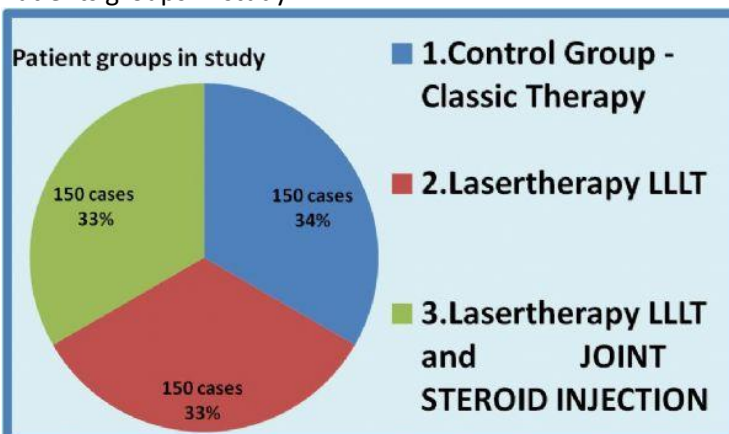
LLLT and Steroid Joint Infiltrations

Low Power Lasertherapy session.



Laser session in red and infrared spectrum of the knee joint

Patients groups in study



Patients groups in study

Results of the second and the third group



Results of the second and the third group

Steroid local infiltration.



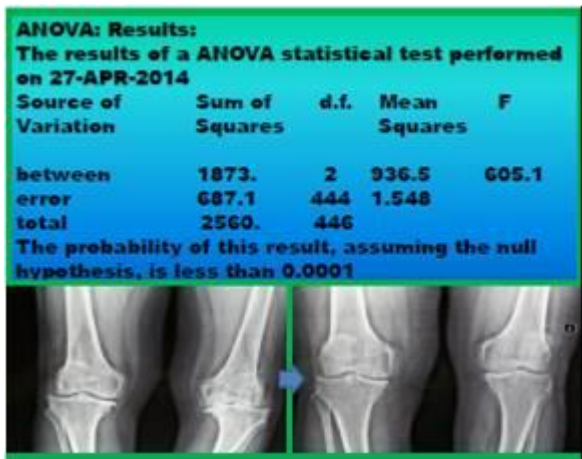
Steroid knee joint infiltration.

Table 2: Motion-functional Score (MFS from 1 to 10): - before and after treatment in all three groups- Student't-test data analysis

GROUPS	GROUP 1		GROUP 2		GROUP 3	
T-TEST p- value	p<0,0001		p<0,0001		p<0,0001	
95% CI CONFIDEN CE INTERVAL	From 3,53 to 4,11		From 5,06 to 5,52		From 6,08 to 6,71	
The mean diference Δ t0-t1	3,82		5,29		6,39	
Standard error of diference	0,146		0,118		0,159	
Time during the treatment: Before t0 After t1	t 0	t 1	t 0	t 1	t 0	t 1
Mean - MFS score	7,95	4,13	7,95	2,66	7,52	1,13
SD	1,12	1,39	1,12	0,90	1,56	1,15
SEM	0,09	0,11	0,09	0,07	0,13	0,09
N (patients)	150	148	150	149	150	150

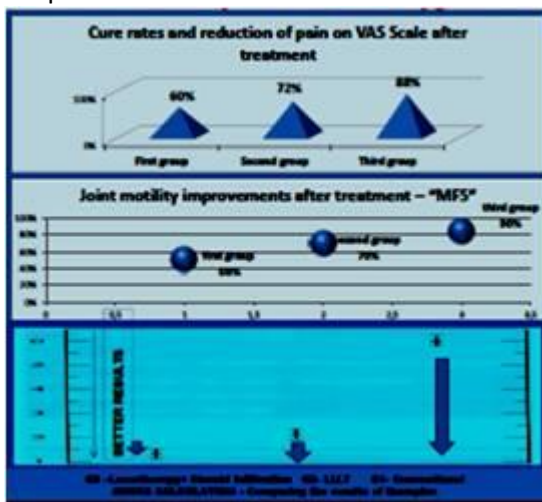
Table 2: Motion-functional Score (MFS from 1 to 10): - before and after treatment in all three groups- Student't-test data analysis

The results of a ANOVA statistical test.



The results of a ANOVA statistical test.

Graphics with VAS and MFS scales after treatments. ANOVA Calculations.



Graphics with VAS and MFS scales after treatments. ANOVA Calculations.

Table 1: Patients pain evaluation (VAS)- before and after treatment in all three groups- Student't-test data analysis

GROUPS	GROUP 1		GROUP 2		GROUP 3	
T-TEST p- value	p<0,0001		p<0,0001		p<0,0001	
95% CI CONFIDENCE INTERVAL	From 1,30 to 1,87		From 5,45 to 6,02		From 5,97 to 6,48	
The mean difference Δ t0-t1	1,59		5,73		6,23	
Standard error of difference	0,143		0,144		0,130	
Time during the treatment: Before t0 After t1	t 0	t 1	t 0	t 1	t 0	t 1
Mean - VAS score	7,58	5,99	7,85	2,11	7,52	1,29
SD	1,19	1,29	1,14	1,34	1,16	1,10
SEM	0,10	0,11	0,09	0,11	0,09	0,09
N (patients)	150	148	150	149	150	150

Table 1: Patients pain evaluation (VAS)- before and after treatment in all three groups- Student't-test data analysis

P-1057

Heart Failure in a Primary Care Population: What can we improve?

Maria João Abreu, Nuno Namora, Tiago Ribeiro, Maria Inês Madureira, Fernanda Rodrigues, Luísa Ferraz
USF Duovida - ACES do Alto Ave, Guimarães, Portugal

BACKGROUND: Heart failure (HF) is a disorder with increasing prevalence in recent decades, associated with high morbidity and mortality. According the EPICA study, the estimated overall prevalence of HF in the Portuguese population was 4.4%, with a marked increase with age.

AIM: Determine the prevalence and characterize the HF in the population of a primary care unit.

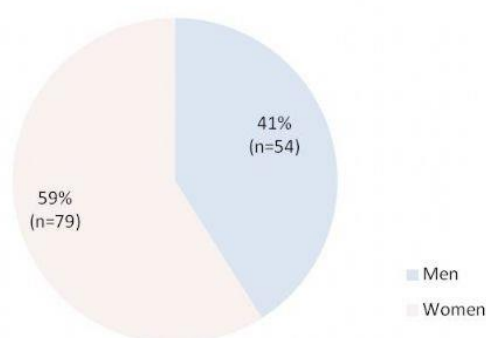
METHODS: Observational, descriptive and retrospective study in adult patients of a primary care unit with the HF code (K77) of the International Classification of Primary Care - 2nd edition. Data was obtained by consulting the electronic health record in February 2015 to characterize the population about: gender, age, body mass index (BMI), alcohol abuse, medical comorbidities, echocardiography (date of the last) and therapy. Statistical analysis was performed in SPSS.

RESULTS: 139 cases were considered with the diagnosis of HF, so the prevalence of this disease was 1,3%. The mean age was 74.5±14.0 years, with a predominance of female (59,4%). The population average BMI was 28.6±5.9 kg/m² and alcohol (g for week) was 100.6 ± 137.3. About 75% of patients had a history of hypertension, 23% had diabetes mellitus, 25% had atrial fibrillation, 12% history of stroke and 9% had myocardial infarction. It was found that 69.9% (n=93) of patients had registered echocardiography, and 72% (n=67) of these had echocardiography in the last 5 years. About therapy, in 82.7% (n=110) of patients were prescribed a modulator of the renin-angiotensin system. Diuretics were prescribed in 75.2% (n=100) and beta-blockers in 43.6% (n=58) of the patients.

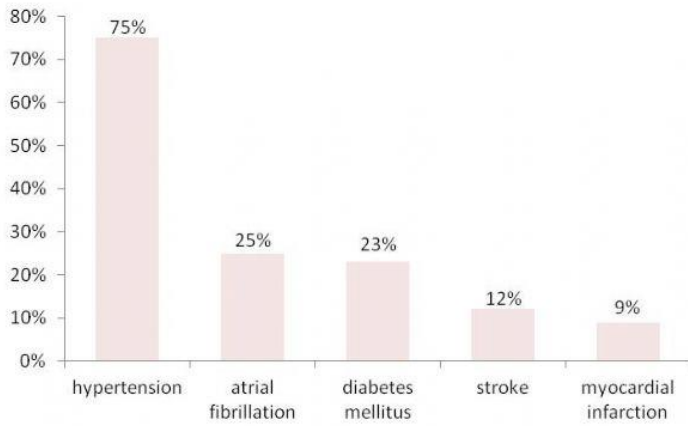
CONCLUSION: It was found that the prevalence of HF is lower than reported in the literature, which can be justified by the absence of clinical records. The General Practitioners have an important role in the early diagnosis of this disorder, thus reducing the morbidity and mortality associated with it.

Keywords: Heart Failure, Primary Care

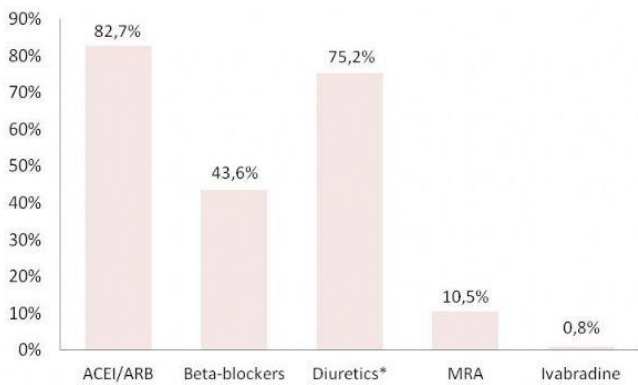
Graphic 1: Distribution of patients by gender, % (n)



Graphic 2: Distribution of patients comorbidities



Graphic 3: Distribution of patients medication



ACEI - angiotensin converting enzyme inhibition; ARB - angiotensin receptor blocker; MRA - mineralocorticoid receptor antagonist; *Diuretics non-spirolactone

Table 1: Demographic characteristic of patients

	Age, years	BMI, kg/m ²	Alcohol, g for week
Mean ± SD	74.5±14.0	28.6±5.9	100.6 ± 137.3
Minimum	23	14	0
Maximum	97	46	672

BMI - body mass index; SD - standard deviation

Table 2: Distribution of patients comorbidities by gender

	hypertension	atrial fibrillation	diabetes mellitus	stroke	myocardial infarction
Female	59%	60,6%	60%	62,5%	25%
Male	41%	39,4%	40%	37,5%	75%
Total (n=133)	75%	24,8%	22,6%	12%	9%

P-1058

Medical Relief in Malaysia: Examining the experiences of medical volunteers in the recent flood disaster relief management and their burnout rates. (Study protocol)

Nurainul Hana Shamsuddin¹, Aneesa Abd Rashid¹, Hani Syahida Salim¹, Siti Zulaikha Zakariah¹, Mohammad Ikram Mohd Salleh², Abdul Rashid Abdul Rahman³

¹Department of Family Medicine, Faculty of Medicine & Health Science, University Putra Malaysia

²Cyberjaya University College of Medical Sciences

³Malaysian Institute for Graduate & Higher Training (MIGHTy)

There are many Non-Governmental Organisation (NGOs) involved with flood relief projects to help the current existing resources available in Malaysia. NGOs have been involved in many aspect of relief including medical relief. The last 2 years of flood events in Malaysia were exceptionally larger in magnitude compared to previous flood events in the past decades. Therefore the effort in providing medical relief to flood victims recently had prevailed problems as we lack experience in coordinating large scale relief locally. Hence, we plan to bridge this gap by exploring experiences of volunteer health care providers involved in this process. As a number of the volunteers are involved repeatedly, we to determine if there is burnout amongst them. The main objectives of this study are to explore the views and experiences of health care provider volunteers involved in the recent flood disaster relief in Malaysia and to determine whether burnout is prevalent among medical volunteers in the recent flood disaster relief in Malaysia. The exploratory objectives would be done as a qualitative study, where as the burnout prevalence would be determined through a cross-sectional study using a validated questionnaire, the Maslach Burnout Inventory.

The qualitative arm would be carried out through focus group discussions and in-depth interviews. This study will be carried out at the states where the HCP volunteers reside, either from the affected states or others during the recent flood. Expected outcomes are knowledge regarding the experiences, contributions, and preparedness of health care provider volunteers involved in the recent flood disaster relief in Malaysia, their challenges and unmet needs and the prevalence of burnout amongst health care provider volunteers in medical relief in the NGOs. This knowledge will further be used to improve accessibility and efficiency of medical relief in future disaster management, which in turn would be more cost-effective.

Keywords: disaster, flood, primary care, health care providers

P-1059

Why have outpatients visited a family doctor and attended regular outpatients and why have regular outpatients terminated to visit a family doctor ?

Shin Matsumura, Tadao Okada

Department of Family Medicine, Tessyokai Kameda Family Clinic Tateyama, Japan

Background & Aim

However, continuity of care are known as one of the five key principles of primary care, it sometimes comes to an end. I try to reveal the reason why regular outpatients terminated to visit a family doctor by analyzing 3 year of medical chart.

Method

A retrospective chart review was conducted in outpatients from 1 Apr 2012 to 12 Mar 2015. The main outcome measures were the status and period.

Results

1954 charts were reviewed, total number of patients were 5044 and counting as there is no overlap outpatients were 1954. 271 patients attended regular outpatients and 168 patients have still continued to visit now. 103 patients terminate regular outpatients and 44 patients did at their reasons, 7 patients did at doctor's reasons, and 52 patients did by agreement. Some did not come to reservation because of cerebral infarction etc. by looking

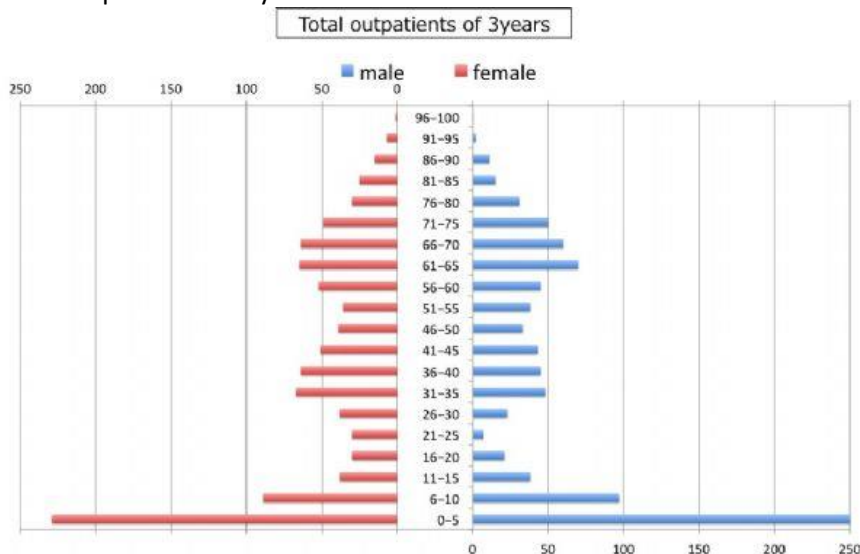
back later.

Conclusions

Half of regular outpatients terminated by agreement and some resumed as regular outpatients. I thought termination because of outpatients, there were compelling reasons by looking later. I might have maintained more continuity of care through the intervention such as letters or making a phone call to know the circumstances at that time.

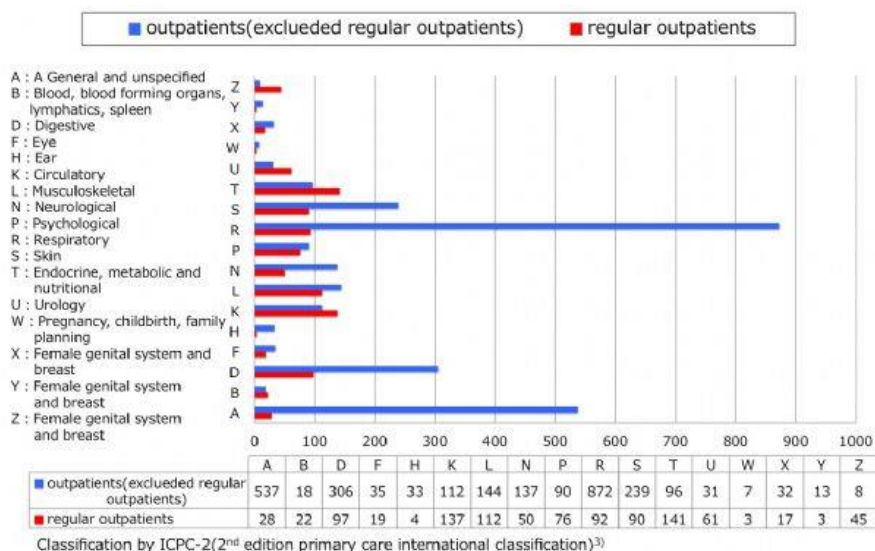
Keywords: continuity of care, regular outpatient, terminate to visit doctor, family medicine

total outpatients of 3 years

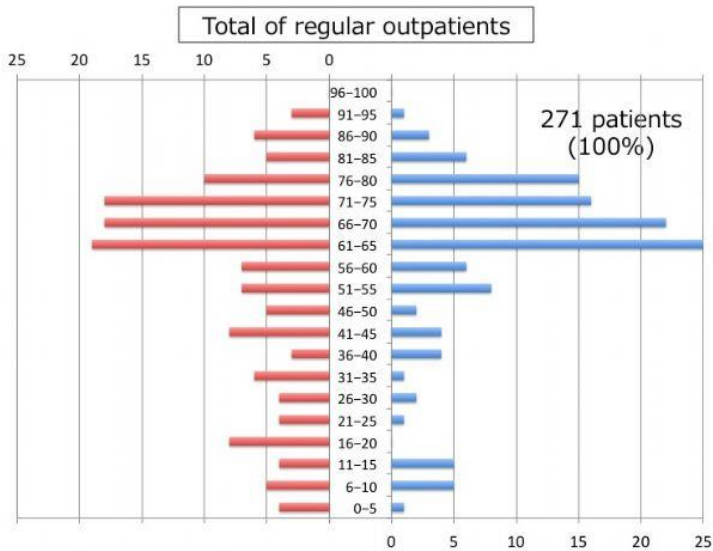


total outpatients of 3 years

reasons for visit

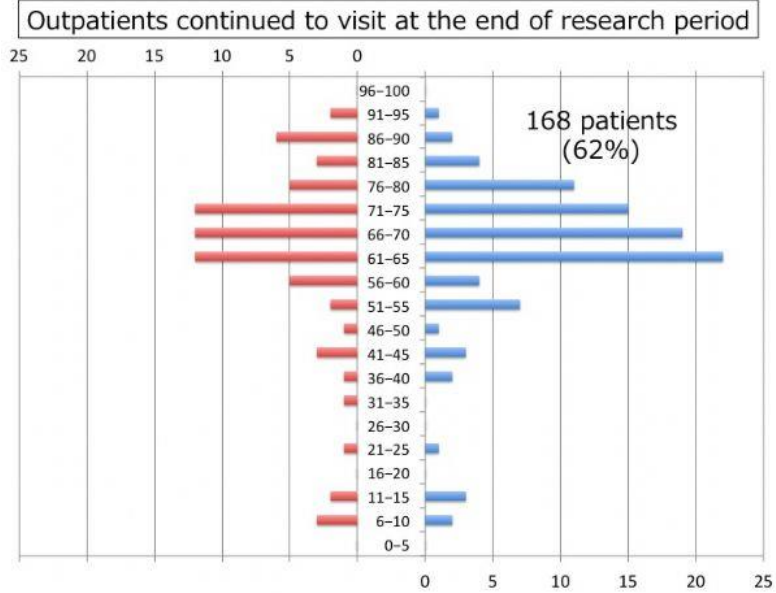


Total of regular outpatients



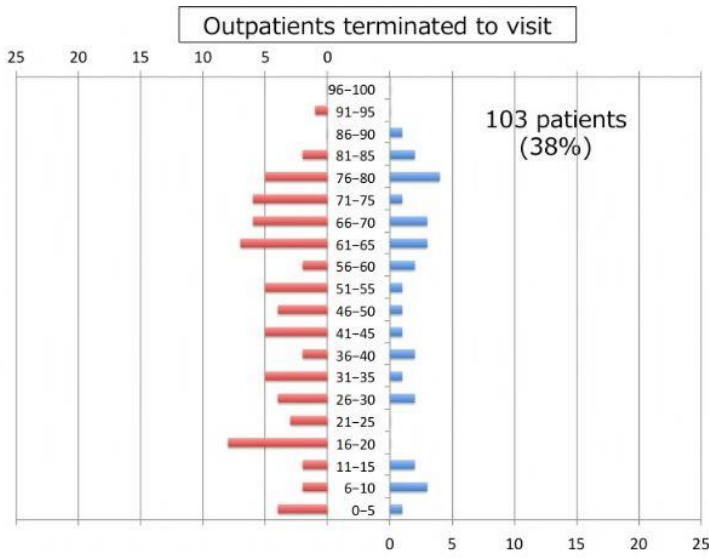
Total of regular outpatients

Outpatients continued to visit at the end of research period



Outpatients continued to visit at the end of research period

Outpatients terminated to visit

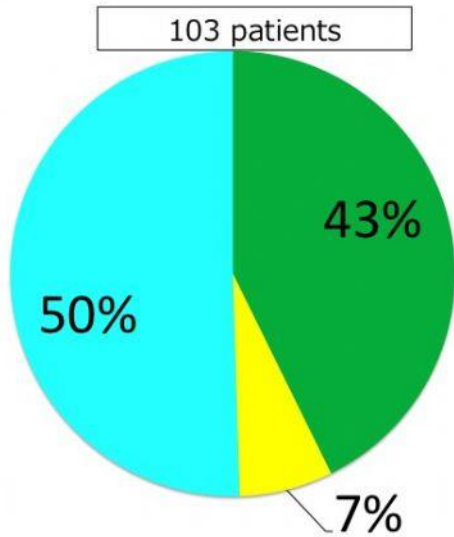


Outpatients terminated to visit

Proportion of termination

number of patients

- patient's reason
- doctor's reason
- agreement by both



details of reasons

[patients's reason]

- reason of 26 patients unknown
- 5 patients switched doctors by their wishes
- 4 patients did not come to the appointment in spite of scheduled to end
- 9 patients could not visit with compelling reasons (admission with heart failure, epilepsy, renal failure, cancer(2 lung, 1 prostate, 1 pancreas),accident, and busy with family death)

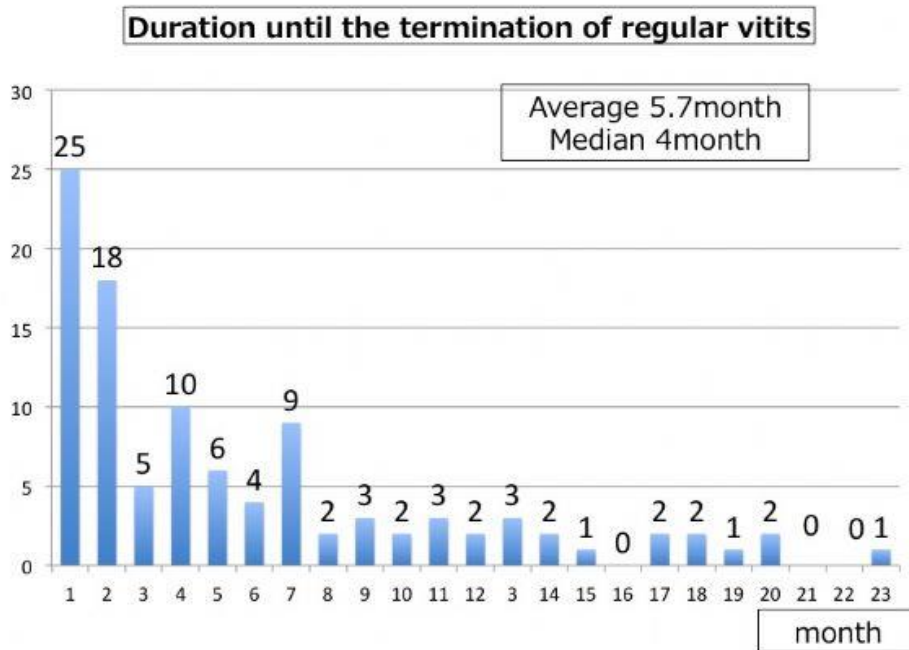
[doctor's reason]

- 2 patients referred and transferred to specialists
- 5 patients could not adjust the schedule because of rotation training

[agreement]

- problems solved
- 6 patients referred and transferred to other family physicians due to moving
- 3 patients introduced to homevisit
- 13 regular outpatients who terminated to visit occasionally visit the clinic

Duration until the termination of regular visits



Duration until the termination of regular visits

P-1060

The prognostic role of high sensitivity CRP and Triglycerides on the new onset of left ventricular diastolic dysfunction in type 2 diabetes patients

Evangelos Fousteris¹, Christos Verras¹, Anastasios Theodosios Georgilas², Athanasia Papazafeiropoulou¹, Christos Tountas², Dimitra Samiotou², Stefanos Foussas², Andreas Melidonis¹

¹Diabetes Center, Tzanio General Hospital, Piraeus, Greece

²Cardiology Department, Tzanio General Hospital, Piraeus, Greece

AIMS

This prospective observational study focuses on the biomarkers and the echocardiographic findings that could predict the new onset of LVDD on type 2 diabetes patients

MATERIALS & METHODS

We enrolled 48 volunteers (26 males) with type 2 diabetes of mean age 55.4 ± 10.0 years, mean HbA1c $7.5 \pm 1.5\%$, mean BMI 29.4 ± 5.1 Kg/m² and mean diabetes duration 2.8 ± 0.8 years with normal both systolic and diastolic cardiac function. We collected demographic, clinical and laboratory data and performed echocardiographic evaluation to each participant. Fasting plasma was drawn for BNP, sST2 and hs-CRP measurements. This procedure was repeated every 12 months for a 48-month time period.

RESULTS

At baseline: 41.7% of recruits had arterial hypertension, 45.8% dyslipidemia, 45.8% smoking. On metformin therapy was the 91.7% while 27.1 on SU, 8.3% on DPP-4 inhibitors, 8.3% on glinides and 4.2% on insulin therapy. Among the anti-hypertensives, 18.8% was on ACE-inhibitors, 16.7% ARB's, 4.2% HCT and 4.2% b-blockers. At the end of the study 28 subjects had LVDD. Univariate analysis showed that the presence of LVDD was related with: BMI ($p=0.05$), therapy with ARB's ($p=0.05$), hs-CRP ($p=0.02$), HDL-C ($p=0.03$), fasting triglycerides ($p=0.003$) and Left Ventricular Myocardial Index (LVMI) ($p=0.03$). No correlation was observed between LVDD and sex, age, diabetes duration, history of hypertension, dyslipidemia, smoking habits, oral antihyperglycemic agents, ESR, fibrinogen, total cholesterol, LDL-C, uric acid, BNP and sST2. Logarithmic regression analysis revealed that the new onset of LVDD was positively correlated with hs-CRP levels ($p=0.02$) and fasting triglycerides ($p=0.02$) and negatively with the therapy with ARB's ($p=0.05$)

CONCLUSIONS

Higher hs-CRP levels and fasting triglycerides may predict the new onset of LVDD – the echocardiographic depiction of diabetic cardiomyopathy - in type 2 diabetes patients with normal cardiac function, while therapy with ARB's may play a protective role in this 4-year prospective study.

Keywords: Diabetes, LVDD, CRP, Triglycerides

P-1061

4DSQ scores in a random sample of Turkish women and related factors

Gamze Şenol¹, Nurver Turfaner Sipahioğlu², Suphi Vehid³, Fikret Sipahioğlu⁴

¹As. Dr. Department of Family Medicine, Cerrahpasa Medical Faculty, Istanbul University, 34303

²Assoc. Prof. Department of Family Medicine, Cerrahpasa Medical Faculty, Istanbul University, 34303, Istanbul, Turkey

³Assoc. Prof. Department of Public Health, Cerrahpasa Medical Faculty, Istanbul University, 34303

⁴Prof. Dr. Department of Internal Medicine, Cerrahpasa Medical Faculty, Istanbul University, 34303

AIM: The aim of this study was to analyze depression-anxiety-distress and somatization levels with 4DSQ scale in a random sample of Turkish women and search its relationship with their demographic data.

MATERIAL-METHOD: The study group consisted of 106 women with mean age 52±15.23. Turkish version of 4DSQ scale was applied to all participants and their demographic data were questioned. The results were analyzed with SPSS 21 using one-way anova, chi-square and student-t test.

RESULTS: Demographic factors related with depression were; age (p=0.046), BMI (p=0.012), menopause duration (p=0.023), time after marriage (p=0.017), diabetes (p=0.042), employment (p=0.008), treatment (p=0.012), education (p=0.006) and consuming dairy products (p=0.004). Demographic factors related with distress were; BMI (p=0.058), hyperlipidemia (p=0.056), rheumatologic diseases (p=0.069), neurologic diseases (p=0.036) and education (p=0.058). Demographic factors related with somatization were; age (p=0.057), menarcheal age (p=0.005), time after marriage (p=0.021), smoking (p=0.003), number of packages (p=0.026), number of births (p=0.018), employment (p=0.045), cardiac diseases (p=0.003), hypertension (p=0.016), thyroid diseases (p=0.048), treatment (p=0.001) and consuming protein (p=0.045). Demographic factors related with anxiety were; smoking (p=0.002), number of packages (p=0.001), cardiac diseases (p=0.005), menopause duration (p=0.038).

CONCLUSION: Smoking was related with anxiety and somatization, employment was related with somatization and depression, education level was related with depression and menopause duration was related with depression and anxiety, time after marriage was related with depression and somatization and age, BMI and education were related with depression.

Keywords: 4DSQ, Turkish women, demographic factors

P-1062

"{" The effect of cigarette on diabetic complications "}"

Orhan Yılmaz¹, Zuhal Aydan Sağlam¹, Kaan Güngör²

¹Istanbul Medeniyet University Göztepe Training and Research Hospital; Department of Family Medicine

²Istanbul Medeniyet University Göztepe Training and Research Hospital; Department of Endocrinology

GOAL: Cigarette is one of the alterable risk factor of many diseases especially cardiovascular disorder and cancer. Cigarette increases micro and macrovascular complications on diabetic patients by damaging endothelial functions. The aim of our study is to assess the effect of cigarette on diabetic complications in a small-scaled group of patients.

METHOD: This study was practised on November-December 2014 as a cross-sectional analytic at Diabetes polyclinic of İstanbul Medeniyet University Göztepe Training and Research Hospital. Voluntary patients who are 18 or older with type-2 diabetes applied to the Diabetes polyclinic and smoking and non-smoking patients were compared in terms of demographic, metabolic features and complication frequency. The description of regulation was acknowledged as HbA1c≤%7. The analysis of the data was fulfilled by using frequency, chi square and t-test. P<0.05 was acknowledged as significant.

FINDINGS: Demographic features and complication rates of 206 patients suffering type-2 Diabetes Mellitus who were involved in the study can be seen on Table 1. Smoking habit of men was significantly high (p=0,000). Both groups differed in terms of diabetes age, average HbA1c and utilization of insulin (p=0,000). Considering the factors of microvascular and macrovascular complications, there were no differences between those who smoke and who do not (p=0.28; p=0.92). Not surprisingly, micro and macro complications increased on those who smoke

and who do not as the diabetes age increased ($p=0.018$; $p=0.020$). There were more frequent microvascular complications on smoking women than men($p=0.007$).

RESULT: Our study claims that cigarette has no effect on micro and macrovascular complications. Besides, microvascular complications were more frequent on women who smoke. The reason we cannot show the effect of cigarette on complications may be lack of sufficient time or patient. Moreover, we need more patients and extended studies in order to answer why microvascular complications are observed more frequently on women.

Keywords: effect of cigarette, diabetic complications, type 2 diabetes

1

	Smoking(-) N(%)	Smoking(+) N(%)
	Micro Complication(+)	Micro Complication(+)
Diabetes Age		
≤10	38(59,4)	39(56,5)
11-20	24(72,7)	20(83,3)
≥21	6(85,7)	8(88,9)
p(Chi-square)	0,214	0,018*
	Macro Complication(+)	Macro Complication(+)
Diabetes Age		
≤10	41(64,1)	35(50,7)
11-20	23(69,7)	18(75)
≥21	6(85,7)	8(88,9)
p(Chi-square)	0,480	0,020*
	Regulation(+)	Regulation(+)
Diabetes Age		
≤10	41(64,1)	45(65,2)
11-20	15(45,5)	10(78,9)
≥21	1(14,3)	2(22,2)
p(Chi-square)	0,018*	0,014*

Complication Distributions of the Patients

P-1063

The importance of COPD screening methods in Primary Care

Madalina Daniela Graure, Alexandru Claudiu Coman, Juana Flores Torrecillas, Florentina Guillen Cavas
Cartagena Casco Antiguo Health Center, Cartagena, Murcia, Spain

• Background & Aim

COPD is usually diagnosed in advanced phases when secondary complications appear. Most of the medical care of these patients takes place in General Practice, therefore it is important to establish preventive activities from the beginning to reduce the long term complications.

Microspirometry is a rapid and easy method to diagnose decreased pulmonary function with results comparable to classic spirometry.

Our main objective is to detect COPD in adult patients who smoke or had smoked, using microspirometry, COPD Diagnostic Questionnaire (CDQ) and COPD-PS.

• Method

Patients included in the study are aged 35 to 75 and are active or ex-smokers (≥ 10 pack years). Those diagnosed with COPD, asthma or with a history of respiratory infection in the last 4 weeks are excluded.

The calculated sample size is 370 (confidence level of 95%, 5% precision rate, estimated loss 5%).

For collecting data we are using opportunistic sampling methods.

Once selected the patients, they will have to complete the two questionnaires. Microspirometry will be performed using the Vitalograph COPD-6 microspirometer in those who obtain more than 4 points in the COPD-PS and/or 17 points in CDQ. Those who obtain a $FEV_1/FEV_6 < 0.7$ will be diagnosed as possible COPD.

The possible COPD patients will be referred to the Pneumology Department for confirmation.

Variables: gender, age, pack-years, result COPD-PS, result CDQ, FEV_1/FEV_6 . Data will be processed in SPSS-18.0 using univariate and bivariate analysis techniques.

• Results

The results obtained by now show that microspirometry is a valid method for diagnosing COPD at its early stages thus early treatment can be considered also increasing the chance of smoking cessation.

• Conclusions

We hope that with this study we will demonstrate the benefits of early diagnosis of COPD in General Practice by using microspirometry.

Keywords: COPD, Spirometry, Prevention

P-1064

The impact of the economic crisis on the organization, implemetation and programming of vaccination in infancy and childhood

Maria Gianniki, Michail Migkos, Maria Bakola, Konstantina Mavridou, Paraskevi Voulgari, Alexandros Drosos
Rheumatology Clinic, Department of Internal Medicine, Medical School, University of Ioannina, Ioannina, Greece.

Background & AIM: The worsening economic problems has brought effects on social and health level. The world faces the challenge to prevent the economic crisis becoming a social and a health crisis. The aim of this study is to defend the vaccination which should stay unaffected by the economic crisis.

METHOD: In the current study it has been conducted a combination of primary and secondary research. Secondary research is a literature review of authoritative scientific sources and legislation. The primary research was conducted through interviews with standardized questionnaires addressed to Health officers.

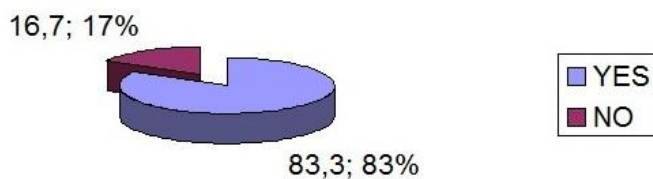
RESULTS: On the administrative level, fundamental reform is the amendment, which provides free supply and administration of vaccines in public structures to the uninsured. Despite the economic crisis, vaccination coverage of children in Greece remains at satisfactory levels. However, problems occur in covering specific vaccines such as repetitive doses of MMR, DTaP and polio. Also, delay is observed in performing pneumococcal, meningococcal, hepatitis B and HPV vaccines. Problems still exist in the coverage of special population groups (migrants, Roma). As a corollary of the above is the resurgence of diseases such as tuberculosis, meningococemia, pneumococcal respiratory infections, diseases which can be prevented by immunization. Vaccination coverage and the vaccination itself are directly related to demographic and socioeconomic factors (uninsured, unemployed, young age parents with many children(>3) and immigrants). Finally, is observed an increase of visits in outpatients clinics on public structures, which is directly correlated with the reduction in the percentage of families addressed now, in the midst of crisis, only in private pediatrician for childhood vaccination.

CONCLUSIONS: The economic crisis has adverse effects on the implementation of the immunization program, which are not recorded in their entirety, because immunization is a long process. The entirety of these effects will be the subject of reflection in the future.

Keywords: vaccination, crisis, resurgence, diseases, tuberculosis, prevention

Figure 1

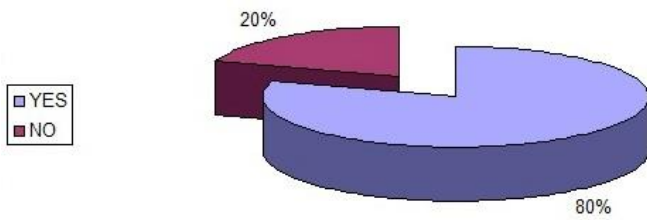
Percentage of Administered Vaccinations



Percentage of Administered Vaccinations

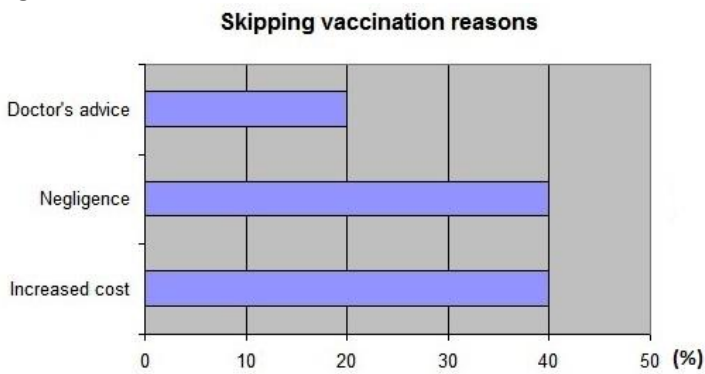
Figure 2

Administration of repetitive doses of vaccines



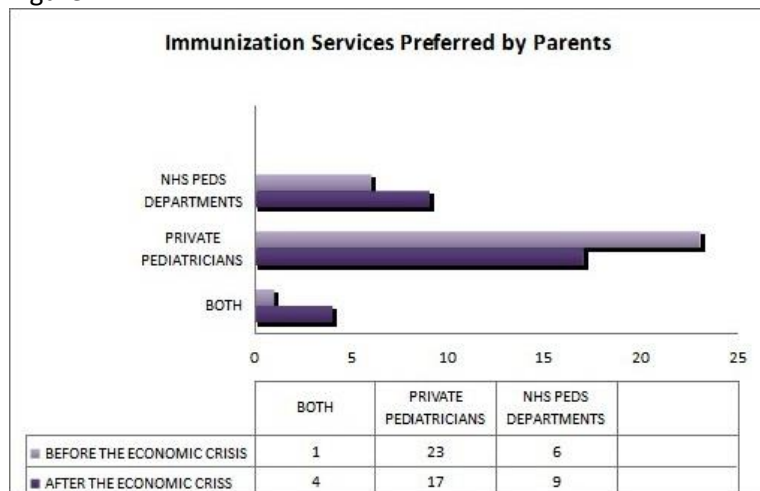
Administration of repetitive doses of vaccines

Figure 3



The reasons parents give for skipping a vaccination

Figure 4



Immunization Services Preferred by Parents for their Children Vaccination

Image 1



"If you connect the measles it spells out 'My parents are idiots.'"

Negligence of vaccination (The sketch was taken from www.newyorker.com)

Table 1

Uninsured parents	14,1%
Unemployed parents	30%
Immigrants parents	6,7%
Young parents with many children (>3)	5,9%

Vaccination related to demographic and socioeconomic factors

P-1065

Trends in peptic ulcer and gastro-oesophageal reflux disease registered in primary care and consecutive drug utilization in Croatia, 2005-2013

Vlatka Topolovec Nižetić

Foundation for the development of family medicine in Croatia

Background & aims

In daily practice we witness increase of utilization of drugs for peptic ulcer (PU) and gastro-oesophageal reflux disease (GERD). H₂-receptor antagonists (H₂RA) and proton pump inhibitors (PPI) have revolutionized the treatment of both groups of diseases. Aim of this study was to investigate if the trends of the consecutive drug utilisations were following the morbidity trends of PU and GERD registered in Croatian primary care (PC).

Methods

The study is observational and longitudinal, based on routinely collected data. The main sources of data collection were Croatian Health Service Yearbooks and annual reports of Agency for Medicinal Products and Medical Devices (HALMED), 2005 - 2013. We extracted the morbidity data related to the K diagnoses (ICD-X), number and structure of the registered diagnoses. From the HALMED Reports we obtained the data about the usage of the H₂RA and PPI drugs, types of drugs (ATC classification index) and amount expressed in DDD/TID.

Results

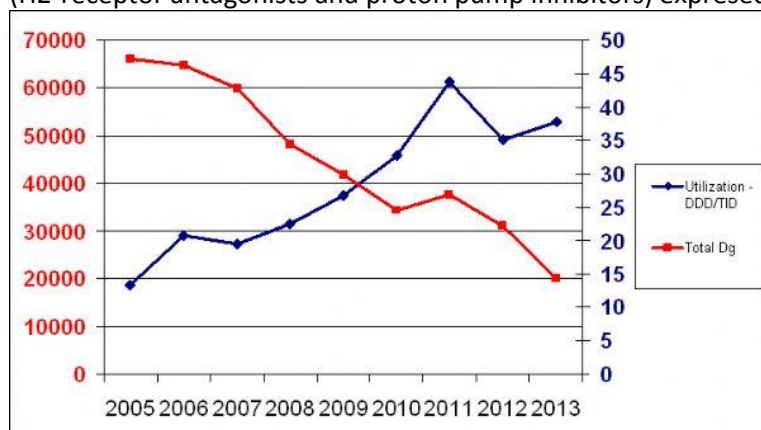
Number of PU and GERD diagnosis is in continuous decline, with the exception of year 2011 when it has slightly increased. Over the observed period, a number of diagnoses have declined by 70%, from 65,942 diagnoses registered in 2005 to 20,039 diagnoses in 2013. Overall utilization of H₂RA and PPI drugs has been increasing. Overall increase in the observed period was 183%, from 13.33 DDD/TID in 2005 to 37.72 in 2013. Utilization of H₂RA has increased by 34%, while utilization of PPI has increased by 345%.

Conclusions

The obtained results clearly indicated that the H₂RA and PPI drugs utilisation is not in association with the morbidity trends of PU and GERD registered in Croatian primary care. It could only be explained by utilization of those drugs in patients who use NSRI and other who are poly-medicated because of multi-morbidities, but further research are needed.

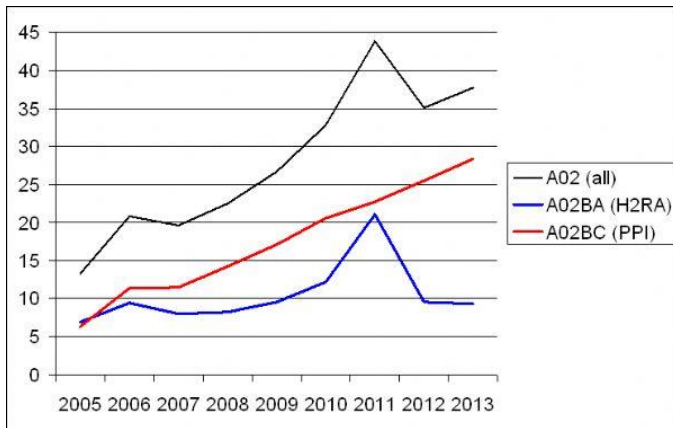
Keywords: peptic ulcer, gastro-oesophageal reflux disease, drug utilization

Fig. 1. Comparison of morbidity trends (number of PU and GERD diagnoses) and trends in the drugs utilisation (H₂-receptor antagonists and proton pump inhibitors) expressed in DDD/TID in Croatia: 2005 – 2013



DDD/TID = defined daily dose per 1,000 inhabitants per day "Total Dg" = PU and GERD diagnoses

Fig. 2. Trends in the utilisation of H₂-receptor antagonists (H₂RA) and proton pump inhibitors (PPI) expressed in DDD/TID in Croatia: 2005 – 2013



WHO ATC codes: A02BA = H2-receptor antagonists (H2RA) A02BC = Proton pump inhibitors (PPI)

P-1066

Clinical characteristics and survival in polymedicated elderly patients

Ricardo Enrique Reolid Martínez¹, Inmaculada Hernández Cerón¹, Marta Martínez Ruiz², Ana Belén Sánchez López³, Gema María Tello Nieves³, María Candelaria Ayuso Raya¹, Remedios Martínez Carmona³, Ignacio Párraga Martínez³

¹Albacete Area IV Health Centre, Health Care Service of Castilla-La Mancha, C/Seminario 4, 02006 Albacete, Spain

²Albacete Area V-B Health Centre, Health Care Service of Castilla-La Mancha, C/Profesor Macedonio Jiménez s/n, 02006 Albacete, Spain.

³La Roda Health Centre, Health Care Service of Castilla-La Mancha, C/Mártires 63, 02630 La Roda, Albacete, Spain.

BACKGROUND AND AIM:

To describe the clinical characteristics of polymedicated elderly patients in Primary Care and analyze their survival estimated as a function of comorbidity.

METHOD:

Cross-sectional study made in six consultations of family medicine of four basic areas of health. 275 individuals \geq 65 years who consumed more than five drugs for at least six months were selected through consecutive sampling. Sociodemographic variables, cardiovascular risk factors, health problems (CIAP-2 classification), drug consumption and survival estimated by the Charlson comorbidity index (CCI) were collected. Descriptive, bivariate and multivariate (multiple linear regression) analyzes were performed.

RESULTS:

The mean age was 76.5 years (SD: 6.7). 55.6% suffered from more than five diseases. The most common health problems were endocrinological 93.8%, cardiovascular 92.0%, locomotive 57.8%, respiratory 25.8%, digestive 24.0% and psychological 22.3%. 85.8% had hypertension, 57.1% dyslipidemia and 41.1% diabetes. The average number of drugs consumed was 8.2. (SD: 2.1). The median survival estimated at 10 years by CCI was 24.4% (interquartile range, 1.1% -53.4%). Survival showed a statistically significant inverse correlation regarding the number of health problems ($r=-0,309$; $p<0,001$) and the number of drugs ($r=-0,285$, $p<0,001$). Through adjustment with a multiple linear regression model, the variables associated with increased survival estimated at 10 years were: younger age, female sex, less number of drugs consumed, and absence of ischemic heart disease, stroke, peripheral artery disease, heart failure, diabetes, digestive, respiratory and urological problems.

CONCLUSION:

The vast majority of polymedicated elderly patients have endocrine and cardiovascular diseases. More than half of them suffer from more than five pathologies. Survival in polymedicated elderly people is related with the variables included in the CCI as with others such as sex, number of drugs consumed and the presence of any Urological, digestive or respiratory problems.

Keywords: Comorbidity, Drug Utilization, Primary Health Care

Charlson comorbidity index (CCI)

Comorbil conditions	Score
Myocardial Infarction	1
Heart Failure	1
Peripheral Arterial Disease	1
Cerebral Arterial Diseases	1
Dementia	1
Respiratory Tract Diseases	1
Connective Tissue Disease	1
Peptic Ulcer	1
Slight chronic liver Injury	1
Diabetes	1
Hemiplegia	2
Renal Insufficiency	2
Diabetes with target organ injury	2
Solid tumor or neoplasia	2
Leukemia	2
Lymphoma	2
Moderate chronic liver Injury	3
Solid tumor or neoplasia and metastasis.	6
AIDS	6

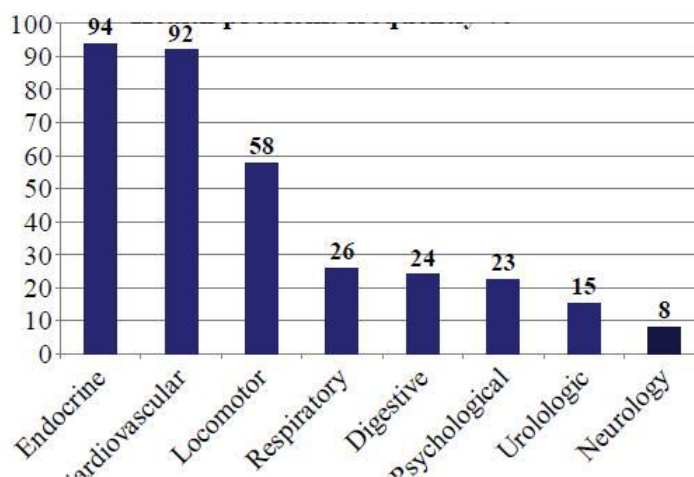
Chronic Dis. 1987; 40(5):373-383).

Sociodemographic characteristics as drugs prescribed amount

	Total n (%)	6-7 drugs n(%)	8-9 drugs n(%)	≥ 10 drugs. n(%)
Age (years)				
- 65-74	110 (40,0)	50 (45,5)	37 (33,6)	23 (20,9)
- 75-79	75 (27,3)	30 (40,0)	21 (28,0)	24 (32,0)
- ≥ 80	90 (32,7)	39 (43,3)	28 (31,1)	23 (25,6)
Sex				
- Hombre	122 (44,4)	61 (50,0)	39 (32,0)	22 (18,0)
- Mujer	153 (55,6)	58 (37,9)	47 (30,7)	48 (31,4)
Civil status				
- Single, widowed, Divor	80 (29,1)	35 (43,8)	22 (27,5)	23 (28,8)
- Married or partner	195 (70,9)	84 (43,1)	64 (32,89)	47 (24,1)
Social class				
- Class I-V	123 (44,7)	54 (43,9)	39 (31,7)	30 (24,4)
- Class VI-VII	152 (55,3)	65 (42,8)	47 (30,9)	40 (26,3)
Education level				
- Read or without education	145 (52,7)	48 (33,1)	47(32,4)	50 (34,5)
- Primary studies	130 (47,3)	71 (54,6)	39 (30,0)	20 (15,4)

Distribution of participants by the number of drugs consumed.

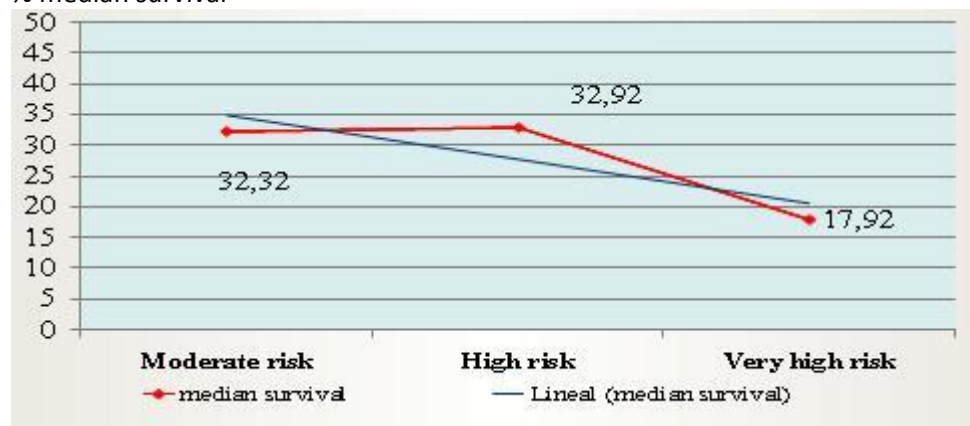
Health problems frequently



Cardiovascular comorbidity

CARDIOVASCULAR COMORBIDITY	n	%
-Myocardial Ischemia	52	18,9
-Cerebral Arterial Diseases	19	6,9
- Peripheral Arterial disease	22	8,0
- Heart failure	33	12,0
-Metabolic system	125	45,5
-Diabetes	113	41,1
-Hypertensión	236	85,8
-Dyslipidemia	157	57,1
-Obesity	147	53,5
- Smoker	11	4,0
- Sedentary lifestyle	51	18,5

% median survival



Multiple linear regression model to the variables associated with increased survival estimated by the Charlson Index

Variables	B	IC 95%	p
Younger	2,13	1,85 a 2,41	<0,001
Female	6,28	2,31 a 10,25	0,002
Menor nº fármacos consumidos	1,32	0,35 a 2,29	0,008
Not Myocardial Ischemia	13,47	8,58 a 18,36	<0,001
Not Cerebral Arterial Diseases	13,70	6,45 a 20,95	<0,001
Not Peripheral Arterial Disease	11,59	4,59 a 18,59	0,001
Not Heart Failure	15,99	10,5 a 21,84	<0,001
Not Diabetes	22,36	18,42 a 26,30	<0,001
Not Digestive Problems	5,52	1,16 a 9,88	0,013
Not Respiratory Tract Diseases	8,76	4,45 a 13,08	<0,001
Not Urologic problems	5,75	0,41 a 11,10	0,035

P-1067

Comparative Trial between High Intensity Lasertherapy (HILT) versus Low Power Lasertherapy (LLLT) associated with Trigger Point Injections in treatments of chronic low back pain

Mihai Sorin Iacob, Sorina Saftescu, Madalina Gligor

Department of Family Medicine, Advitam Medicis Medical Center, Timisoara, Romania.

In the GP practice, we often face with low back pain, that cause problems both, patients by long periods of inactivity and suffering, and physicians regarding management of this complex pathology. This study aims to present the results of LLLT, with red and infrared 685/830 nm wavelength with 1800 mW-power, compared with the results obtained after treatment with HILT in infrared emission 810/980 nm wavelength, 7W-power.

METHODS: Inclusion criteria were patients with chronic nonspecific back pain of various causes such as: degenerative vertebral joints and soft tissue disorders, or lumbar vertebral disk herniation with radiculopathy, but without neurological deficit without chronic diseases. We conducted a prospective study (RCT) over three years, on 750 patients, using two laser devices (semiconductor source). Steroid used in Trigger Point Injections (TPI) was Dexamethasone 4mg/ml. Cases studied were divided into three groups: First Group includes patients with classic medication, Second Group included patients treated with LLLT associated with TPI and Third Group included patients treated with HILT associated with TPI. Elements evaluated to each patient were: pain on a visual analogue scale (VAS) and a motion-functional scale (MFS) of the low back disability with scoring from 1 to 10.

RESULTS: Our healing rate was 48% in the first, 78%in second and 88%in third group with significant pain reduction. All these data, were entered in electronic database designed by us in Microsoft Access. Analysis of risk and data obtained on patients by: VAS and MFS scales, before and after treatment, within each group was compared by Student' t-test, $p<0,01$ and among all three groups after the final evaluation of patients by ANOVA, $p<0,001$.

CONCLUSION: The combination of HILT with steroid infiltration had significantly improved outcome with 40% compared to conventional therapy. HILT is proved to be more effective than LLLT in management of chronic low back pain.

Keywords: Chronic nonspecific low back pain, High Intensity Laser Therapy (HILT), Low Level Laser Therapy (LLLT), Trigger Point Injections

Steroid Trigger Point Injections (TPI).

Steroid Trigger Point Injections (TPI)



Steroid Trigger Point Injections (TPI).

2x2 Contingency Table with Risk Ratio, Odds Ratio, 95% Confidence Interval between Control and second group.

PATIENTS (N)	GOOD RESULTS (HEALING) 0	BAD RESULTS (RECURRENCE) 1
CONTROL GROUP = 0	124	123
LASERTHERAPY GROUP-LLLT = 1	191	58

Table 5. 2x2 Contingency Table - Risk Ratio, Odds Ratio, 95% Confidence Interval between Gr.

Relative risk

Exposed group
Number with positive (bad) outcome: 58
Number with negative (good) outcome: 191

Control group
Number with positive (bad) outcome: 123
Number with negative (good) outcome: 124

Test

Results

Relative risk: 0.4675
95% CI: 0.3614 to 0.6063
z statistic: 6.775
Significance level: $P = 0.0001$
NNT (Harm): 3.773
95% CI: 5.447 (Harm) to 2.886 (Benefit)

Odds ratio

Cases with positive (bad) outcome
Number in exposed group: 58
Number in control group: 123

Cases with negative (good) outcome
Number in exposed group: 191
Number in control group: 124

Test

Results

Odds ratio: 0.3201
95% CI: 0.2082 to 0.4801
z statistic: 6.918
Significance level: $P = 0.0001$

Computational notes

2x2 Contingency Table with Risk Ratio, Odds Ratio, 95% Confidence Interval between Control and second group.

Conclusions



Conclusion:

1. The combination of **HILT** with steroid infiltration had significantly improved outcome with 40% compared to conventional therapy and can be consider the treatment of LBP with best outcome.
2. **HILT** is proved to be more effective than **LLLT** in management of chronic low back pain combined with steroid TPI. ($p < 0,001$)

Conclusions

HILT -THERAPEUTICALLY LASER PROTOCOL

- **HILT.- therapeutically laser protocol from our study**



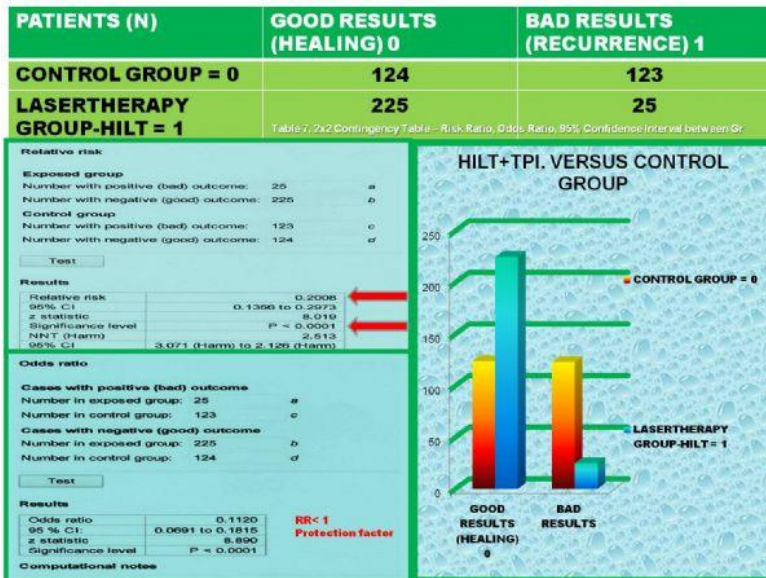
HILT -THERAPEUTICALLY LASER PROTOCOL

Improving of the radiological aspects before and after one year with HILT Laser Therapy associated with Steroid TPI.



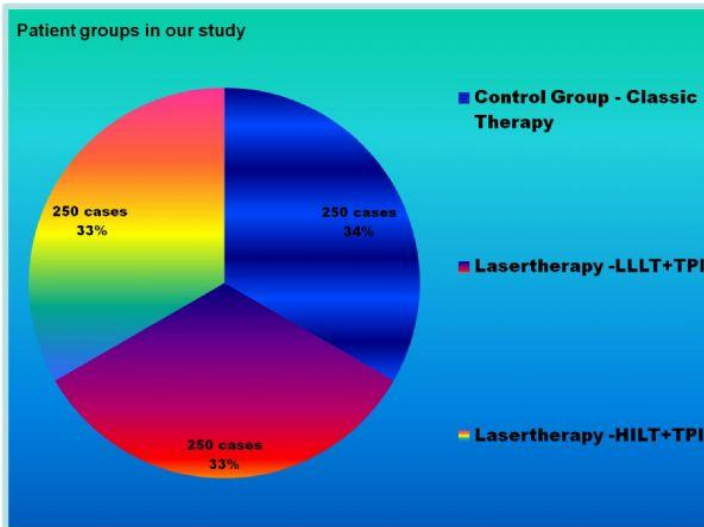
Research questions.

2x2 Contingency Table with Risk Ratio, Odds Ratio, 95% Confidence Interval between Control and Third Group.



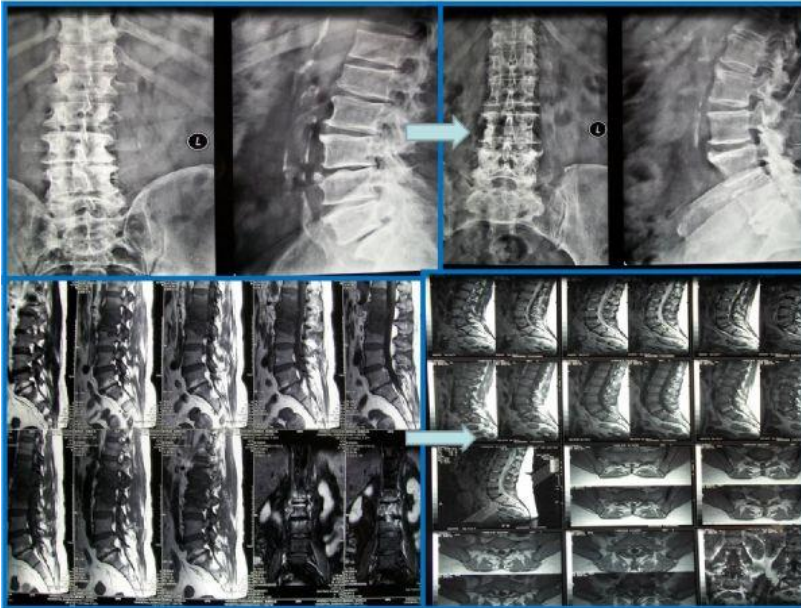
2x2 Contingency Table with Risk Ratio, Odds Ratio, 95% Confidence Interval between Control and Third Group.

Patients groups in our study



Patients groups in our study

Radiological differences observed before and after treatment.



Radiological differences observed before and after treatment.

The therapeutically laser L.L.L.T. protocol study.



• The therapeutically laser L.L.L.T. protocol study:

The therapeutically laser L.L.L.T. protocol study.

Student t-test data analysis - Patients pain evaluation VAS -before and after treatment in all three Groups.

GROUPS	GROUP 1 Control Group		GROUP 2 LLLT+TPI		GROUP 3 HILT+TPI	
T-TEST p- value	p<0,0001		p<0,0001		p<0,0001	
95% CI CONFIDENCE INTERVAL	From 1,30 to 1,87		From 5,45 to 6,02		From 5,97 to 6,48	
The mean difference Δ t0-t1	1,59		5,73		6,23	
Standard error of difference	0,143		0,144		0,130	
Time during the treatment: Before - t0 After - t1	t 0	t 1	t 0	t 1	t 0	t 1
Mean - VAS score	7,58	5,99	7,85	2,11	7,52	1,29
SD	1,19	1,29	1,14	1,34	1,16	1,10
SEM	0,10	0,11	0,09	0,11	0,09	0,09
N (patients)	250	248	250	249	250	250

Table 1: Patients pain evaluation (VAS)- before and after treatment in all three groups - Student't-test data analysis

Student t-test data analysis - Patients pain evaluation VAS -before and after treatment in all three Groups

Second Group Therapy.

Second Group



Second Group Therapy.

Student t-test data analysis - Patients evaluation Motion-functional Score MFS -before and after treatment in all three Groups.

GROUPS	GROUP 1 Control Group		GROUP 2 LLLT+TPI		GROUP 3 HILT+TPI	
T-TEST p- value	p<0,0001		p<0,0001		p<0,0001	
95% CI CONFIDENCE INTERVAL	From 3,53 to 4,11		From 5,06 to 5,52		From 6,08 to 6,71	
The mean difference Δ t0-t1	3,82		5,29		6,39	
Standard error of difference	0,146		0,118		0,159	
Time during the treatment: Before t0 After t1	t 0	t 1	t 0	t 1	t 0	t 1
Mean - MFS score	7,95	4,13	7,95	2,66	7,52	1,13
SD	1,12	1,39	1,12	0,90	1,56	1,15
SEM	0,09	0,11	0,09	0,07	0,13	0,09
N (patients)	250	248	250	249	250	250

Table 2: Motion-functional Score (MFS from 1 to 10): - before and after treatment in all three groups- Student't-test data analysis

Student t-test data analysis - Patients evaluation Motion-functional Score MFS -before and after treatment in all three Groups.

ANOVA Calculations - Statistical difference of results after treatment.

ANOVA Calculations - Statistical difference of results after treatment.

Setup ONE WAY ANOVA

Number of samples in analysis = 3

Correlated Samples

ANOVA Summary

Source	SS	df	MS	F	p
Treatment (between groups)	1787.83488	2	893.917425	506.45	p<0.0001
Error	620.3985	296	1.7611		
Ss/BI	273.804	149			Graph Maker
Total	2581.93736	446			

Data Summary

	Group 1	Group 2	Group 3	Total
N	248	249	250	747
$\sum x$	871	314	193	1378
Mean	3.51	1.26	0.77	3.05277
$\sum x^2$	6471	930	429	6930
Variance	2.34726	1.81271	1.21257	6.78909
Std.Dev.	1.53207	1.34637	1.10119	2.40605
Std.Err.	0.12953	0.11029	0.08991	0.11380

Tukey HSD Test

M1 = mean of Group 1
M2 = mean of Group 2
M3 = mean of Group 3

difference between any two sample means required for significance at the designated level. HSD(.05) for the .05 level; HSD(.01) for the .01 level.

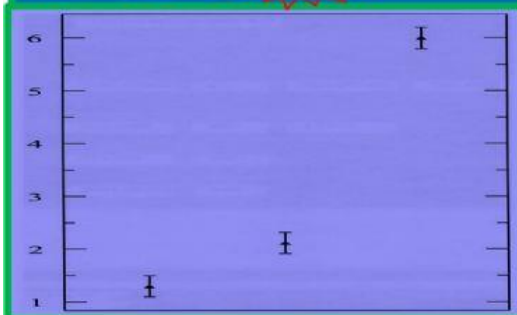

ANOVA Calculations - Statistical difference of results after treatment.

ANOVA Calculations - Comparing the results of all three Groups of patients.

ANOVA: Results:
The results of a ANOVA statistical test performed on 27-APR-2014

Source of Variation	Sum of Squares	d.f.	Mean Squares	F
between	1873.	2	936.5	605.1
error	687.1	444	1.548	
total	2560.	446		

The probability of this result, assuming the null hypothesis, is less than 0.0001

01 - Control Group 02 - Lasertherapy 03 - Lasertherapy
ANOVA CALCULATION - Comparing the results of therapy

ANOVA Calculations - Comparing the results of all three Groups of patients.

Third Group Therapy.

Third Group



Third Group Therapy

Characteristics of 750 Subjects Enrolled in the Low Back Pain Treatments Trial by Randomization Status.

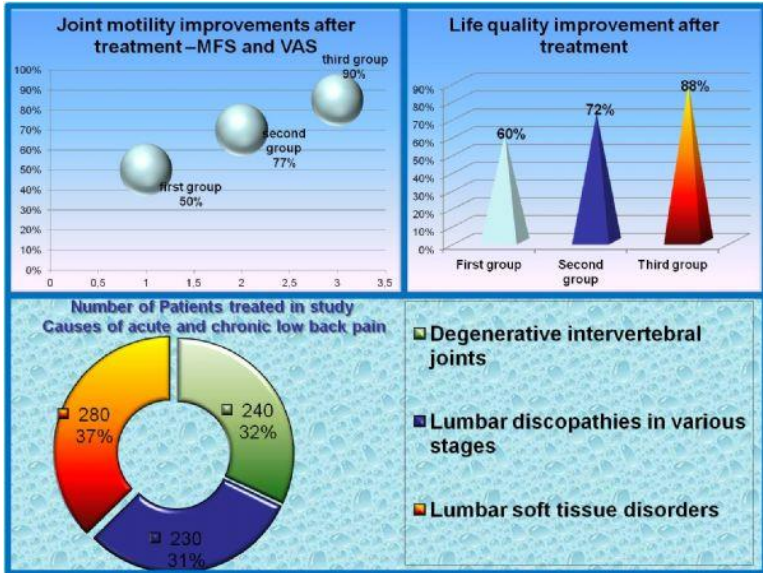
RESULTS AND DISCUSSION: Characteristics of 750 Subjects Enrolled in the Low Back Pain Treatments Trial by Randomization Status

n(%) or Mean ± SD	1.Control Group n=250	2.Laser therapy LLLT+TPI Group n=250	3.Laser therapy HILT+TPI Group n=250
Age (years)	47.8 ± 5.4	46.8 ± 5.8	48.6 ± 5.8
Body weight (kg)	87±14	85±16	88±18
Male Gender – Sex Ratio	150 (60%)	140 (58%)	155(61%)
Smoker (40+pack- years)	100 (45%)	125 (50%)	125 (50%)
History of diabetes	20 (8%)	25 (10%)	15 (7%)
History of rheumatic diseases	28 (11%)	25 (10%)	30 (12%)



Characteristics of 750 Subjects Enrolled in the Low Back Pain Treatments Trial by Randomization Status.

Descriptive analysis of the Groups after treatments.



Descriptive analysis of the Groups after treatments.

P-1068

Association of Mean Platelet Volume levels with cardiometabolic parameters, neurological outcome and mortality in patients with ischemic stroke

Christos Verras, Angeliki Angelidi, Evangelos Fousteris, Athanasia Papazafeiropoulou, Georgios Kapsalakis, Chariklia Sagia, Froso Efstratiadis, Georgios Christofilidis, Asimina Ganotopoulou, Andreas Melidonis
Diabetes Center, Tzanio General Hospital, Piraeus, Greece

Introduction - Purpose

The Mean Platelet Volume (MPV), a morphological marker of platelets, has been associated with cardiovascular events and it is a potential predictor of increased mortality and adverse outcomes in people with cardiovascular disease. The purpose of this study is to investigate the possible association between MPV with cardiovascular risk factors as well as the neurological outcome and the length of hospitalization in patients with ischemic stroke.

Material and method

We studied 78 patients (55% men, 45% women) with a mean age: 75.7 ± 7.3 and 79.4 ± 6.8 for men and women respectively, hospitalized for ischemic stroke. Twenty-five patients had previously known or newly diagnosed atrial fibrillation (AF), 37 had diabetes mellitus (DM) while 29 were smokers.

Severity of neurological deficit according to the National Institutes of Health Stroke Scale (NIHSS) was estimated on admission and on discharge from the hospital.

Results

The MPV showed a positive association with the outcome (NIHSS admission and discharge score) in patients with AF ($p < 0.05$) as well as the presence of diabetes mellitus and NIHSS admission score of these patients ($p < 0.05$). Furthermore, MPV was positively associated with the duration of hospitalization (6.7 ± 3.1 , $p < 0.05$) and a borderline significant trend with smoking ($p < 0.10$). No correlation was found between MPV and other cardiovascular risk factors and mortality of patients.

Conclusions

High levels of MPV are associated with a worse outcome particularly in people with AF. Moreover, MPV levels are associated with a longer duration of hospitalization but not a higher incidence of mortality in patients with ischemic stroke.

Keywords: Mean Platelet Volume, Ischemic stroke

P-1069

Correlation between Fetuin-A with biomarkers in morbidly obese patients prior to and six months after bariatric surgery

Christos Verras¹, Yannis Simos², George Ayiomamitis³, Evangelos Fousteris¹, Athanasia Papazafeiropoulou¹, Spyridon Konitsiotis², Angelos Evangelou², Nikiforos Dimitrios Kiortsis², Andreas Melidonis¹

¹Diabetes Center, Tzanio General Hospital, Piraeus, Greece

²Laboratory of Physiology, Medical School of University of Ioannina, Ioannina, Greece

³2nd Surgical Department, Tzanio general Hospital, Piraeus, Greece

Background and aims

The liver secreted glycoprotein Fetuin-A has been recently associated with insulin resistance, atherosclerosis and obesity. The objective of this study is to examine any possible correlation between Fetuin-A with these biomarkers in morbidly obese patients prior to and six months after bariatric surgery.

Materials and methods

We recruited 20 morbidly obese patients (mean BMI: 43.0±3.0 kgr/m²) who were admitted to the surgery clinic of our hospital to undergo programmed bariatric surgery (laparoscopic sleeve gastrectomy). Forty percent of our sample was males and 20% had type 2 diabetes. Fasting blood samples collected before and 6 months after surgery were analyzed for glucose, HbA1c, lipidemic profile, hs-CRP, fibrinogen, insulin and Fetuin-A. We calculated HOMA-IR index and lipid accumulation product (LAP) to all participants. Bioelectric impedance was performed in all patients for the assessment for fat mass and fat free mass at baseline and at 6 month follow up.

Results

The mean body weight loss during the study period was 31.5±11.81 kgs, of which 25.54±21.48 Kgs were fat mass. Mean (±SD) serum Fetuin-A levels at baseline were 0.27 (±0.05) g/l which did not show difference compared to the 0.26 (±0.07) g/l of the follow up re-examination (p=0.808). Baseline Fetuin-A levels correlated with total cholesterol levels (r=0.582, p<0.05), LDL-cholesterol (r=0.540, p<0.05) and fat mass (r=-0.549, p<0.05) prior to bariatric surgery. No correlation was found with the rest of the study parameters at baseline. Follow up Fetuin-A levels did not show any correlation with any of the study parameters. The changes of Fetuin-A levels correlated with baseline triglycerides levels (r=0.592, p<0.01).

Conclusion

Our study demonstrated that Fetuin-A levels remained unchanged besides the significant weight loss achieved within the first 6 months after bariatric surgery, possibly indicating that this time period after the surgery is too short to reveal significant changes.

Keywords: Fetuin-A, Bariatric Surgery, Biomarkers

P-1070

Does the sense of possession of basic professional competences have any effect on occurrence of burnout syndrome in family physicians?

Olgu Aygün¹, Vildan Mevsim²

¹Karabağlar 2 family health center

²Dokuz Eylül University, Medicine Faculty, Family Medicine Department

BACKGROUND:

Burnout syndrome is a major problem especially among health care workers. Many factors are known to be associated with this syndrome. Sense of individual skills and achievement are affected by one's education and competence in his/her professional practice. Higher the sense of individual skills and achievement, lower the occurrence of burnout syndrome.

Research question:

Does the sense of possession of basic professional competences have any effect on occurrence of burnout syndrome in family physicians?

METHOD:

This study is designed as a nested case-control study. Study population is physicians working in family health centres in Izmir. The sample was selected by cluster sampling method. Data were collected via a questionnaire consists of demographic variables and questions to measure sense of professional competences described by EURACT and Maslach Burnout Inventory Personal Achievement subscale (MBI-PA). Case and control groups were formed based on MBI scores. Student's t test, chi square test, correlation analysis and logistic regression analysis were used to analyse the data.

RESULTS:

There were 113 cases and 113 controls. Both groups were matched with respect to age and gender. Number of male and female participants was same for both of the groups; 64.6% male and 35.4% female. Mean ages of case and control groups were 44.7±6.9 and 44.8±6.8 respectively. MBI-PA scores were 23.04 for cases and 14.6 for controls. In case and control groups, the rates of physicians who have strong sense of competence were 36.3% and 84.1% respectively. Cases were more likely to participate postgraduate medical congresses and activities.

CONCLUSION:

Strong sense of competence is associated with low occurrence of burnout syndrome in primary care physicians. Postgraduate and continuous medical education is important in adoption of core competencies in primary care.

Keywords: burnout syndrome, primary care, core competencies

TABLO

Tablo 1. Olgu ve kontrol grubunun yaş grubu ve cinsiyete göre dağılımı

Yaş grupları	% (n)	Olgu	Kontrol	p
20-35		%48,8 (10)	%48,8 (10)	1
36-45		%46,0(32)	%46,0 (32)	
46-55		%38,9(44)	%38,9 (44)	
56-65		%6,2 (7)	%6,2 (7)	
Cinsiyet	% (n)			1
Kadın		%35,4 (40)	%35,4 (40)	1
Erkek		%64,6 (73)	%64,6 (73)	
Medeni durumu	% (n)			0,041
Evlü		%40,5 (91)	42,3(93)	0,001
Bekar		%13,3(15)	9,7(11)	
Boşanmış		%6,2 (7)	8,0 (9)	
Uzman	% (n)			0,001
Aile Hekimi		%96,5 (109)	%84,1(95)	0,101
Aile Hekimliği Uzmanı		%3,5 (4)	%15,9 (18)	
Medekte çalışıp çalışmaması		19,2(6,7)	19,2(7,1)	0,101
Hizmet verilen diğer(Cetalmaması)		3409,0,585,0	3560,8,564,8	0,093

Tablo 2. Mesleki yeterli hissetme durumlarının (ikerenmişlik durumuna göre dağılımı)

	Tükrenmiş	Tükrenmemiş	p
	%(n)	%(n)	
Az yeterli hisseten	%63,7(72)	%15,9(18)	0,001
Yeterli hisseten	%36,3(41)	%84,1(95)	
Toplam	%100,0(113)	%100,0(113)	

P-1071

Long term changes of metabolic parameters in T1DM patients on the switch from MDII TO CSII with BMI categorization

Alexandros Kamaratos, Evangelos Fousteris, Christos Verras, Athanasia Papazafeiropoulou, Ioannis Bakalis, Vasiliki Liosi, Viktoria Katsouri, Parthenopi Alexandropoulou, Styliani Iraklianiou, Andreas Melidonis
Diabetes Center, Tzanio General Hospital, Piraeus, Greece

This study addresses the impact of continuous subcutaneous insulin infusion (CSII) on each BMI category of type 1 diabetes patients under typical multiple daily insulin injections through a 3-year prospective follow up period. We compare the effectiveness of CSII on each BMI category as long as it concerns glycemic control, frequency of hypoglycaemia and needs of insulin units per day, given the fact that possible insulin resistance might alter the results as BMI rises.

81 patients with T1DM treated with multiple daily insulin injections were finally recruited after signed informed consent. We documented detailed medical history, clinical and laboratory findings for each participant before the launch of CSII and each year later on for 3 consecutive years. For statistical analysis we divided the study population according to their BMI: Group A: BMI<18,5: underweight, Group B: 18,5<BMI<25: Normal, Group C: 25<BMI<30: Overweight, Group D: BMI>30: Obese.

81 participants were divided into the 4 study groups: A: 2 patients, B: 40 patients, C: 25 patients and D: 14 patients. Except the group A, all the rest groups presented better glycemic control, within the first year of follow up which maintained throw-out the total follow up period ($p<0.01$) without change of BMI. Lesser hypoglycemias were noticed even from the first year after CSII especially for groups B & D ($p<0.01$). All study groups preserved initial basal insulin rate at first year but reduction was noticed for 2nd and 3rd year of re-examination.

This study is the first to show the impact of switch from MDII to CSII on a Greek cohort of type 2 diabetes patients according to BMI category. CSII ameliorates rapidly and safely the glycemic control of type 1 diabetes patients regardless the BMI category of each patient. Hypoglycemic events were significantly reduced in normal weight and obese patients.

Keywords: Continuous subcutaneous insulin infusion, BMI, Diabetes

P-1072

Health information on TV shows and health literacy in primary care patients with coronary heart disease; a descriptive survey in two districts of Istanbul

Berk Barış Özmen¹, Tahir Koray Yozgatlı¹, Ilayda Dalgakıran¹, Pınar Topsever²

¹School of Medicine, Medical Student, Acibadem University, Istanbul, Turkey

²Department of Family Medicine, Acibadem University, Istanbul, Turkey

INTRODUCTION: Television (TV) shows have a profound effect in people's lives, these elements in everyday life also play a critical role in the perception of health and are able to affect health literacy among individuals. Health literacy, in turn, may change the course of a disease by benefitting patient compliance and disease coping process. Patients with a chronic disease (coronary heart disease (CHD)) are targeted for this study, which aims to identify habits, attitudes and beliefs about TV shows containing health information, as well as, health literacy level.

METHOD: A descriptive survey study will be carried out in family health centres enrolling 150 coronary artery patients aged 40-65. Except for sociodemographic and health related information, patients will be asked about their habits regarding watching TV health shows and their attitudes and beliefs about credibility of health information sources via a survey designed by the researchers. Health literacy will be assessed by the Turkish versions of REALM and NVS tests. The data gathered will be analyzed with a quantitative method to identify possible relationship of exposure to health information on TV shows and health literacy in primary care patients with CHD.

RESULTS: Preliminary results of the study will be presented during the conference.

Keywords: health literacy, health information, TV, survey, coronary heart disease, family medicine

P-1073

The role of soluble ST2 and the correlation between of inflammatory and biochemical markers in morbid obesity

Christos Verras¹, Athanasia Papazafeiropoulou¹, George Ayiomamitis², Evangelos Fousteris¹, Panagiota Spyropoulou³, Spyridon Matsagos³, Spyridon Konitsiotis⁴, Angelos Evangelou⁴, Dimitrios Nikiforos Kiortsis⁴, Andreas Melidonis¹

¹Diabetes Center, Tzanio General Hospital, Piraeus, Greece

²2nd Surgical Department, Tzanio general Hospital, Piraeus, Greece

³Blood Bank Service, Tzanio General Hospital of Piraeus, Greece

⁴Laboratory of Physiology, Medical School of University of Ioannina, Ioannina, Greece

Background & Aims

Obesity is associated with various metabolic pathways by chronic low-grade inflammation of adipose tissue and the related cardiovascular encumbrance, by acceleration the process of atherosclerosis. In the present study we study the correlation of the new ST2 inflammatory marker (soluble ST2) with classical inflammatory and biochemical markers in morbidly obese individuals.

Materials & Methods

We recruited 35 obese persons [23 female /12 male, middle aged (\pm SD): 38.9 ± 10.4 years, 42 ± 4 Kg/m² BMI]. Medical history and demographic characteristics as well as measurement of the levels of soluble ST2 were documented for all participants. The 28.6% of participants in the study had type 2 diabetes, 25.7% arterial hypertension, 31.4% dyslipidemia, 11.4% chronic obstructive pulmonary disease (COPD), while the 51,4% were smokers.

Results

The value of soluble ST2 (\pm SD) of the participants was 13.9 ± 4.2 ng/mL higher than reference values of healthy results supplied by the manufacturer of the kit. Multivariable analysis of the results showed that the levels of soluble ST2 were positively related with the presence of COPD ($p = 0.01$), the number of white blood cells ($p =$

0.02), the levels of SGOT ($p = 0.04$) and waistlines ($p = 0.02$) and negatively with the INR ($p = 0.01$) and TSH levels ($p = 0.05$). There were no statistically significant correlations with age, sex, presence of diabetes, arterial hypertension, smoking, BMI, waist circumference, mass of adipose tissue, the levels of HbA1c, fibrinogen, hs-CRP, plasma lipids and other indicators of liver biochemistry.

Conclusions

Increased levels of soluble ST2 of morbidly obese patients seem to be associated with increased waist circumference. The correlation was not confirmed with classical parameters of inflammation, such as hs-CRP and biochemical indicators such as the lipid profile. Further research on this field with larger populations need to be done.

Keywords: Soluble ST2, obesity, biomarkers

P-1074

Effect of levonorgestrel-releasing intrauterine system on cardiovascular risk factors

Ana Paula Fonseca, Isa Cruz, Márcia Soares

USF Cruz de Celas, Coimbra, Portugal

Background and Aim

The levonorgestrel-releasing intrauterine system (LNG-IUS) is an effective and long-term reversible contraceptive. Currently, it has gained importance in perimenopausal women. Concerns remain that progestin absorbed systemically from the device can aggravate the cardiovascular risk. The aim of this study was to compare cardiovascular parameters between 2 groups: women using LNG-IUS and women using nonhormonal intrauterine devices.

Method

We designed an analytic study of a retrospective cohort of woman using intrauterine devices on a primary care unit. Exclusion criteria was hypertension, diabetes, dyslipidemia, thyroid dysfunction, menopause and women without analytic control. Study variables: cholesterol, diastolic and systolic blood pressure, glucose, corporal mass index (CMI), age, tabagism and time since device introduction. Statistical analysis was performed by using SPSS 21. Descriptive statistics are shown as mean \pm standard deviation. We used t-test to investigate the differences between both groups and we considered as statistically significant when $p < 0.05$.

Results

Fifty women were enrolled: 26 using LNG-IUS and 29 using nonhormonal intrauterine system. Mean age was 41.9 ± 6.4 years, CMI was 24.1 ± 3.9 Kg/cm², 18% were smokers and the evaluations were performed 3.0 ± 1.5 years after the insertion of intrauterine device.

No statistically differences were observed between the levels of cholesterol, blood pressure and glucose. However, levels of systolic blood pressure, glucose, total and LDL cholesterol were higher in the hormonal device group.

Conclusions

We admit the existence of type I and II errors.

In our study, the use of LNG-IUS was not associated with adverse effects on cardiovascular factors. However, further studies are needed to confirm these results.

Keywords: levonorgestrel-releasing intrauterine system; Glucose; Lipid; Blood pressure

Results- Lipid profile

	LNG-IUS	Nonhormonal-IUS	p value*
Total-C	195.5 ± 35.5	190.6 ± 37.3	0.85
HDL-C	58.12 ± 10.8	59.3 ± 11.6	0.70
LDL-C	118.9 ± 30.9	114.4 ± 35.5	0.62
Triglycerides	85.3 ± 27.7	85.3 ± 27.7	0.3

*Independent samples T-Test

P-1075**Evaluation of family care-givers' knowledge on warfarin in home care settings**

Nisa Solmaz, Feyza Çelik, Münevver Tulunay, Doğukan Doğruel, Mustafa Arslan Bircan, Cenk Aypak, Derya İren Akbıyık, Hülya Yıkılkan, Süleyman Görpelioğlu

Dışkapı Yıldırım Beyazıt Training and Research Hospital, Ankara, Turkey

Background&Aim

Warfarin is the most widely prescribed oral anticoagulant in the world. It has been shown that increasing patients' knowledge about warfarin usage via a structured education, lowers those side effects and leads to better outcomes. Therefore we aimed to determine warfarin education levels of family care-giver in our home care settings.

Method

We conducted this cross sectional study among care providers of patients (n=80) who have been followed up by Dışkapı Yıldırım Beyazıt Research Hospital Home Care Service. We obtained information via phone call if those care-givers had received education about warfarin from medical professionals. We collected the data about age, sex, all prescribed drugs, underlying disease, last three months INR (International Normalized Ratio) values, history of hemorrhage from medical records of home care service.

Results

There were 59(74%) women and 21(26%) men included in the study. The mean age was 76.1 ± 9.6 years. Warfarin associated hemorrhage was seen 16 (20%) of 80 patients during the last three months. Only sixteen (20%) care-givers have received an unstructured verbal warfarin education from a medical professional. There are no significant statistics in comparison between warfarin education group and control group regarding hemorrhage, INR monitoring frequency, therapeutic INR range weekly warfarin dose, in last three months period.

Conclusions

A huge investment of time and finances has been directed to optimising the outcomes of patients requiring oral anticoagulant therapy. Our findings have revealed that warfarin education of care givers of home-care patients who are among the most vulnerable population, is inadequate despite intense monitoring visits. A multidisciplinary and a real structured education program may improve family care-givers' warfarin knowledge and result in better anticoagulation control which leads to fewer visits and reduction in health care costs.

Keywords: warfarin, warfarin education, family care giver

P-1076**Prevalence of peripheral arterial disease in patients smokers with diabetes mellitus – Study in a primary health care institution**

Sara Quelha, Felicidade Malheiro

USF Arca d'Água; ACeS Porto Oriental; Porto; Portugal

Background and AIM: Peripheral arterial disease (PAD) is characterized by atherosclerotic occlusion of the arteries of the lower limbs and is a marker of systemic vascular disease. Diabetes mellitus and smoking are the main risk factors for its development, and 2/3 of patients are asymptomatic. In diabetic patients the prevalence estimated vary between 10-40%, with maximum in the sixth and seventh decades of life. Clinical history and physical examination is sufficient for the diagnosis of PAD, with the ankle-brachial index (ABI) is performed in all patients with risk factors for heart disease. The aim of this study is to evaluate the prevalence of PAD by evaluating the ITB, in the institution's patients most at risk for developing the disease - diabetes, smoking, the sixth and seventh decades of life.

METHODS: Search the computer system MIM@UF, of all patients between 50 to 69 years with ICPC2 codes P17 (Tobacco Abuse) and T90 (Diabetes mellitus non-insulin dependent). Descriptive and analytical observational cross-sectional study.

RESULTS: Of the 44 evaluable patients, the reason for female gender: male was 1: 8 and the average age was 59 years; 61.4% of patients were asymptomatic and of these, 41% had PAD. Of patients with intermittent claudication 61.5% had PAD. Only 4 patients reported pain at rest. The average value of HbA1C was 7.5 g / dl. Of the 21 patients with abnormal ABI, more than half (52%) did not show any clinical complaints. Only 3 patients with PAD had no other risk factors or injury already established elsewhere.

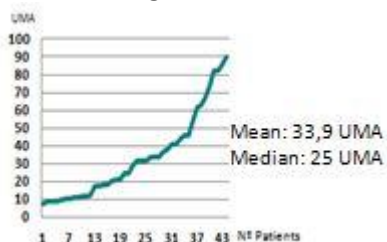
CONCLUSIONS: The prevalence of PAD was 47.7%, with the majority of asymptomatic patients. This study allowed the early diagnosis of disease in diabetic patients smoking, reinforce teaching, stratify risk and intervene in the prevention of complications, particularly in the coronary and cerebral lesions.

Keywords: peripheral arterial disease; smoker; diabetes mellitus

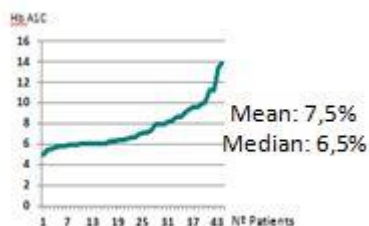
Gender



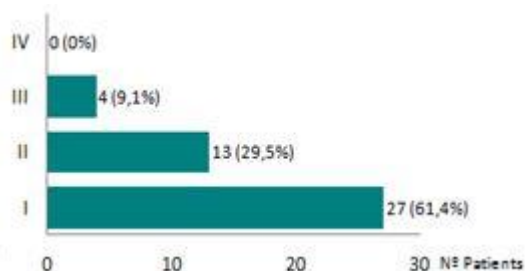
Load Smoking



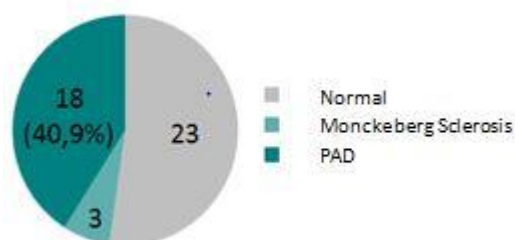
HbA1c Values



Leriche-Fontaine Classification

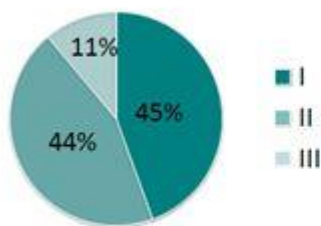


ABI Evaluation

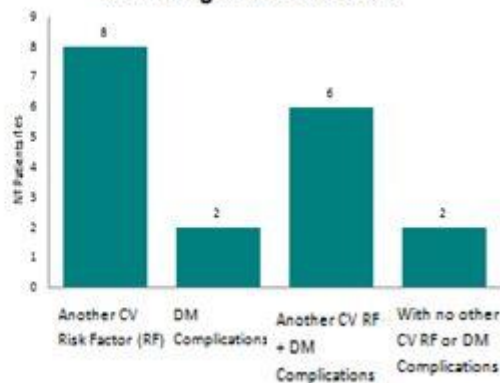


Evaluation of patients with PAD

According to Leriche-Fontaine Classification



According to Comorbidities



P-1077

Relationship between body mass index and estimated glomerular filtration rate

Bojan Zoran Pavkovic, Marija Marjan Zaric

Department of General Practice, Health Center "Dr Simo Milosevic"

Background & Aim

Obesity is significant risk factor for chronic kidney disease (CKD). Glomerular filtration rate (GFR) provides an excellent measure of renal function.

The aim of study was to determine the existence of possible links between body mass index (BMI) and renal function.

Method

BMI was calculated based on anthropological measurement of patients.

Renal function was evaluated by the estimated glomerular filtration rate (eGFR) using the Modification of Diet in Renal Disease (MDRD) study equation.

Data were collected during 2014 and statistical analysis was done using SPSS 19.0 software to evaluate the relationship between BMI and eGFR.

Results

The study included a total of 65 patients, 36 females and 29 males, aged 20-64 years, all without clinical history of diabetes mellitus, cardiovascular event or renal failure.

Subjects were divided into three groups according to BMI: normal weight ($18.5 \leq \text{BMI} \leq 24.9$), overweight ($25 \leq \text{BMI} \leq 29.9$) and obesity ($\text{BMI} \geq 30$).

Analysis showed statistically significant difference in eGFR between normal weight patients and both singly, overweight and obese patients ($p < 0.05$), but not between overweight and obese patients ($p > 0.05$).

It was found that normal weight patients had better renal function compared to both, overweight and obese patients.

Conclusions

Overweight and obesity are associated with decreased filtering capacity of kidneys.

In obese patients should always pay attention to renal function in order to prevent the occurrence of CKD.

Keywords: BMI, eGFR, chronic kidney disease

P-1078

Lower Zinc levels and risk of cognitive decline in Hypertensive adults

Eda Celik Guzel¹, Savas Guzel², Volkan Kucukyalcin², Aliriza Kiziler³, Birsen Aydemir⁴, Coskun Cavusoglu⁵, Tevfik Günyasar⁶

¹Department of Family Medicine, Namik Kemal University, Medical Faculty, Tekirdag, Turkey

²Department of Medical Biochemistry, Namik Kemal University, Medical Faculty, Tekirdag, Turkey

³Department of Department of Biophsica, Namik Kemal University, Medical Faculty, Tekirdag, Turkey

⁴Department of Department of Biophsica, Sakarya University, Medical Faculty, Sakarya, Turkey

⁵Department of Medical Biochemistry, Anatolia Hospital Istanbul

⁶Department of Department of Biophsica, Trakya University, Medical Faculty, Edirne, Turkey

AIM: The objectives of this study were to evaluate the relationship between hypertension and cognitive impairment, to identify risk factors associated to the development of cognitive impairment (zinc, copper, vitamin B12, folic acid, gender, age, body mass index, dyslipidemia).

METHODS: This study is a cross-sectional study and included total 90 participants as 30 normotensive (ages; 51,18±6,80) and 60 hypertensive subjects (ages; 53,83±7,71). All the participants underwent a standardized clinical assessment, which included a medical history, and physical and neurological examination together with the Mini Mental State Examination (MMSE) tests. Normal cognitive function was defined as MMSE >24. Zinc and Copper levels of serum were determined by a atomic absorbtion spectrophotometer with flame.

RESULTS: MMSE were found to be significantly lower in hypertension patients ($p<0.01$). Vitamin B12 level was observed to be significantly higher hypertension patients than control group ($p<0.01$). Trace elements status parameters; copper and zinc levels were no significant differences in hypertension patients than control group. In the >10 years hypertension group MMSE ($p<0.05$), vitamin B12 ($p<0.05$) and zinc ($p<0.05$) had significantly lower than <5 years hypertension patients. Vitamin B12 and zinc levels were significantly lower ($p<0.05$) in hypertension patients with cognitive impairment. A positive correlation were found between zinc and MMSE ($r=0.281$, $p<0.05$) and vitamin ($r=0.399$, $p<0.01$). Significant negative correlation was observed between zinc and diastolic hypertension ($r=-0.294$, $p<0.05$).

CONCLUSIONS: These results suggest that decreased zinc level can be relationship of cognitive decline in hypertension patients.

Keywords: Hypertension, Cognitive decline, Zinc, Copper

Table 1: Clinical assessments and laboratory findings in hypertension and and control group

	Control	Hypertension Group
N	30	60
M Age (years)	51.18±6.80	53.83±7.71
BMI (kg/m ²)	26.14±3.04	28.16±3.8 *
WHR (Gw/Gh)	0.86±0.07	0.86±0.26
SBP (mmHg)	120 (90-130)	150 (125-200) ***
DBP (mmHg)	80 (60-90)	100 (95-150) ***
MMSE Score	27 (21.00-30.00)	24 (18-30) **
Glucose (mg/dl)	98.31±11.13	107.18±14.26
Triglyceride(mg/dl)	130 (45.00-239.00)	135.00 (55.00-262.00)
T Chol (mg/dl)	205 (155.00-245.00)	222.00 (147.00-270.00)
HDL (mg/dl)	47 (29.00-65.00)	47 (32-74)
LDL (mg/dl)	104 (70.00-159.00)	141.6 (73-201)*
TSH (mIU/ml)	2.01 (0.91- 4.17)	1.78 (0.61-5.56)
Free T4 (ng/dl)	1.04 (0.76-1.53)	1.17 (0.68-1.41)
Urea (mg/dl)	22.66±7.2	25.9±8.54
Creatinine (mg/dl)	0.73±0.16	0.86±0.48
Vit B12 (pg/mL)	263.37±76.69	244.21 ±75.32 *
Folic acid (ng/ml)	8.12±1.69	6.61±2.16
Zinc (µg/dL)	172.55±45.47	179.13±34.06

BMI, Body Mass Index, WHR, Waist to Hip Ratio; SBP, Systolic Blood Pressure, DBP, Diastolic Blood Pressure; MMSE, Mini-Mental State Examination; T Col, Total cholesterol; HDL-C, High-Density Lipoprotein; LDL-C, Low Density Lipoprotein, TSH, Thyroid Stimulating Hormone.

*p<0.05, **p<0.01, ***p<0.001;

Table 2: Clinical assessments and laboratory findings according with in hypertension time groups

	<u>Hypertension Time</u>		
	<u><5 years</u>	<u>5-10 years</u>	<u>>10 years</u>
Age (years)	50.78±6.99	58.22±6.54	54.27±7.56
MMSE Score	25 (17.00-28.00)	24 (18-30)	23 (15-27) a*
Vitamin B12 (pg/mL)	271.38±86.5	225.94±61.12	217.8± 54.74 a*
Folic Acid (ng/ml)	6.51±2.33	6.87±2.39	6.52±1.62
Zinc (µg/dL)	179.04±47.94	168.17±44.93	152.95±40.53 a*

*p<0.05; a: < 5 years vs > 10 years

Table 3: Clinical assessments and laboratory findings in MMSE groups

	MMSE score <24	MMSE score ≥24
N	27	33
Age (years)	55.24±7.38	52.1±7.56
Vit B12 (pg/mL)	223.24±71.95	267.85±83.85 *
Folic Acid (ng/ml)	6.69±2.17	7.35±2.1
Zinc (µg/dL)	158.01±47.04	179.08±41.84 *

*p<0.05

Table 4: Correlation analysis of patients with hypertension

	r	P
MMSE / Zinc	0.281*	P<0.01
MMSE / Vitamin B12	0.422**	P<0.01
MMSE / DHT	-0.396**	P<0.01
Vitamin B12 / Zinc	0.399**	P<0.01
Vitamin B12 / DHT	-0.299*	P<0.05
Zinc / DHT	-0.294*	P<0.01

MMSE;Mini Mental StateExamination, BMI; Body massindex, DHT; Duration of hypertension

P-1079

pattern of Pap smears among women attending primary health care centers and hospitals in al-mukalla city, Yemen

Rasha Saleh Bazighifan

Hadramout university-almukalla city-hadhramout-Yemen

INTRODUCTION: Pap smear test is one of the most important tests for women to detect cervical cancer in low socio-economic countries. Cervical cancer is considered preventable, as the premalignant stages can be detected by Pap smear examination. This study aimed to identify the pattern of cervical smears and the factors that affect them and compare them among women attending primary centers and hospitals thereby improving the women health in Al-mukalla city, Yemen.

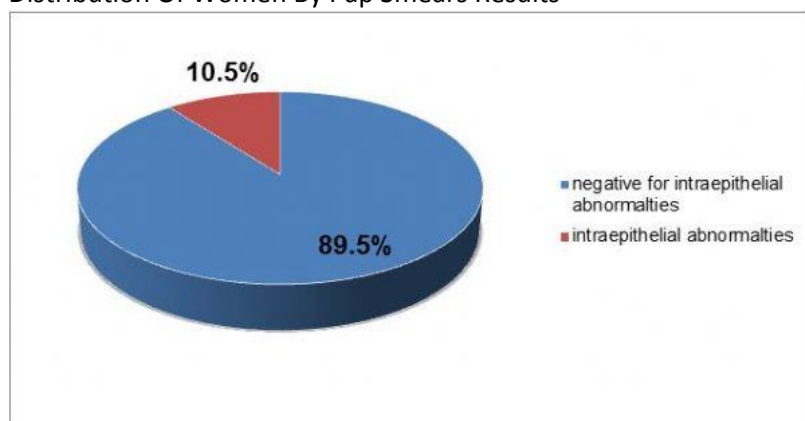
METHODOLOGY: a cross - sectional study was carried out on women aged 18 years to 60 years were collected who had visit the Obstetrics and Gynecology Clinic at primary centers and hospitals. The data was collected by recording the answers in questionnaires and performing cervical smears by extended tip spatula, then the smears immersed in 96%alcohol solution and were sent for staining and reported by pathologist. Analysis was done by using the SPSS for Windows system version 20.

RESULTS: 10.5% of cervical smears were abnormal and classified as precursors of cervical cancer. Percentage of precursors of cervical cancer in hospitals was 13.7 %, while in primary health care centers was 7.1%. Three types of precursors of cervical cancer were diagnosed which were (ASCUS) 5 (23.8 %), (LSILs) 14 (66.7%) and (HSILs) 2 (9.5 %).

CONCLUSION: Yemeni women would accept having a Pap test if properly offered to them. the precursors of cervical cancer were present in our society with high prevalence. The older age (33 yrs. and more), multiparty more than 3, long use of oral hormonal contraceptive five years and more, increased sexual activity for husbands and clinical cervical lesions per vaginal examination are the predictors of intraepithelial neoplasia of cervix.

Keywords: Intraepithelial lesion, Pap smears, Al-mukalla city.

Distribution Of Women By Pap Smears Results



P-1080

Evaluation of the knowledge and practices of primary care professionals in throne to approach alcohol: Study AlcoAP

Fernando Leiva Cepas, Esperanza María Romero Rodríguez, Adriana Cabello Chanfreut, José Cuevas Cruces, Joao Miguel Madeira Martins, Javier López Moreno, José Ángel Fernández García, Luis Ángel Pérula De Torres Teaching Unit of Family and Community Medicine of Córdoba, Andalusian Health Service, Junta de Andalucía, Spain

OBJECTIVES: To assess the knowledge, attitudes and practices of doctors and nurses in primary care (PC) to the implementation of interventions postulated by the Program of Preventive Activities and Health Promotion - PAPPS- target consumers patients alcohol (screening and temperance) advice.

Design: Observational descriptive, transversal.

Location: Multicenter. Health Centers of the National Health System in Spain.

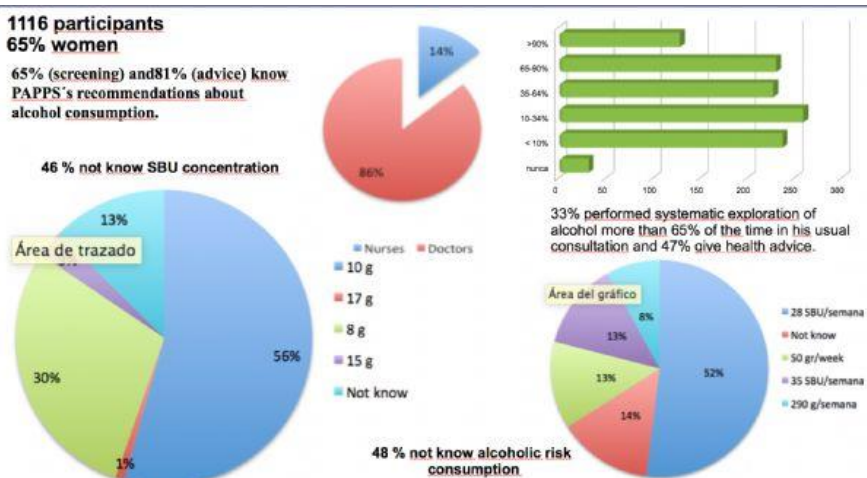
METHODS: Population: doctors and nurses PC. For an alpha error of 5% and an accuracy of 3% and a rate of 50%, would be recruited for the study to 1058 professionals. They were invited to engage all partners and professionals semFYC a sample selected through stratified sampling by autonomous communities and type of health facility. Once established their intention to participate, they completed an online survey. Variables: socio-labor, knowledge and practices on the approach in patients taking alcohol. Descriptive and inferential statistics (P <0.05 bivariate and multivariate analysis) will be made.

Applicability: Through the results of this study seeks to determine the knowledge, attitude and approach to PC professionals regarding this problem in our country, quite unknown aspects, so that thus may recommend to the Authorities Health intervention measures to increase the knowledge, awareness and implementation of preventive interventions temperance professionals PC.

Ethical and legal aspects: the protocol was approved by the Research Ethics Committee of Córdoba. Informed consent to the participants as well as the treatment of personal data will be required under the law of data protection

Keywords: Alcohol, Alcohol prevention, primary care

Results



In this image we can see the different results.

P-1081

Bmi values in rural team family medicine

Sedina Bosankic, Dusanka Becirovic, Mirsada Crnogorcevic Pamukcic, Senada Hrcic

Department of family medicine, Health center Zivinice, Bosnia and Herzegovina

INTRODUCTION: The body mass index (BMI) is a measure of relative size based on the mass and height of an individual. BMI categories: less than 18.5 kg / m²-malnutrition; 18.5-24.9 kg / m² ideal nutritional status, 25-29.9 kg / m²-over-nourished and over 30 kg / m² obesity.

OBJECTIVE: To analyze the value of BMI in patients in rural family medicine team.

METHODS: Searched the 1471 medical records and was allocated 649 cards in which the recorded value of BMI. Data collected from medical records are entered in the form of data collection, which was created for this study. Recorded the following data: number of health records, age, sex, value of BMI, and the number of chronic diseases from which the patient is treated.

RESULTS: The research included 649 patients, 277 men (43%) and 372 women (57%), aged 18-94 years. The average age stood at 46.3 years. BMI values ranged from less than 18,5 to 47 kg / m². The average BMI was 28.3 kg / m². BMI below 18,5 kg / m² had 6 patients (0.9%), the value of 18-25 kg / m² had 192 (29.5%) patients, 25-30 kg / m² had 200 (31.1%) patients a BMI greater than 30 kg / m² had the 251 patients (38.5%). The majority of patients (347-53%) were healthy, with no chronic diseases. A chronic disease had 96 (15%) patients, two chronic disease had 83 (13%) patients and three or more chronic diseases had 123 (19%) patients.

CONCLUSION: In rural family medicine team is most obese patients, then those who are over-nourished, while the lowest number of malnourished patients. There is a positive correlation between the amount of BMI with one and then the number of chronic diseases on the other. Value BMI increases with age is the number of chronic diseases.

Keywords: BMI, value, family team

P-1082

"Galactogogues and breastfeeding - what is the evidence?"

Maria Ana Sobral¹, Mario Cruz¹, Daniela Runa¹, Susana Medeiros¹, Inês Dias Ferreira², Sara Magalhães¹

¹Unidade de Saúde Familiar AlphaMouro, Rio de Mouro, Portugal

²Unidade de Saúde Familiar Venda Nova, Amadora, Portugal

INTRODUCTION: Often some mothers feel unable to extend the breastfeeding period according to their expectations. Whatever the reason, the use of lactation facilitators arises as an attempt to support the breastfeeding period extension by increasing milk production. Thus, the aim of this study is to determine the evidence of the effectiveness of galactogogues on the duration of breastfeeding and increase of milk production.

METHODS: We searched electronic databases for systematic reviews (SR), meta-analysis, randomized controlled trials (RCT), clinical trials, observational studies and guidelines published between January 2005 and January 2015 in English, Spanish and Portuguese. We searched MEDLINE, Clinical Queries, Cochrane Library, National Guideline Clearinghouse, CMA Infobase, NHS Evidence Search, DARE, Bandolier, Evidence-Based Medicine (BMJ) using MeSH terms "galactogogues" and "breast feeding". To rate the evidence we used the OCEBM Levels of Evidence.

RESULTS: We obtained 38 entries in our search. Of those, 34 were identified by reading the title. We selected 23 articles that met the inclusion criteria by reading the abstract. After reading these articles we excluded 19 articles, which did not answer our outcomes or address our objective. We obtained a final total of 4 articles: 3 SR and 1 RCT. None of the articles addressed breastfeeding duration, only evaluating the increase in milk production.

Several galactogogues were evaluated on the SR, but their conclusions were based on few trials with limited data.

CONCLUSION: There is no evidence of galactogogue effectiveness on the duration of breastfeeding. There is evidence of a modest increase in milk production on the short term in mothers of preterm infants who have insufficient breast milk production with the use of domperidone and some evidence that growth hormone might have a role in increasing milk production. However it is important to consider the potential risks of using these drugs.

Keywords: Breastfeeding; Galactogogues; Breastfeeding duration; Milk production

Results

Reference	Type of article	n	Population	Intervention	Comparison	Outcome	Results	Level of evidence
Timothy J Donovan The Cochrane Library 2012	SR with MA	59	Mothers of premature infants in neonatal unit with insufficient milk supply	Domperidone (10 mg, 3 times daily) since day 14	Placebo	Increase in milk volume	Modest increase in milk volume of 99,49ml daily	2
Mylove Mortel Journal of Human Lactation 2013	SR	587	Mothers with or without enough milk supply	5 herbs: Shatavari, torbangun, fenugreek, milk thistle, Japanese herbal mixture	Placebo	Increase in prolactinemia or milk volume	There is no evidence of an effect due to heterogeneity of the studies	1
McInnes RJ Maternal and Child Nutrition 2008	SR	148	Mothers of premature infants in neonatal unit	Domperidone Metoclopramide Oxytocin Growth hormone	Placebo	Increase in milk volume or breastfeeding duration	Domperidone* – increase milk volume Metoclopramide* * and Oxytocin spray*** – no effect, both studies were small Growth hormone**** – modest increase in milk volume	*2 **2 ***2 ****2
Knoppert DC Journal of human lactation 2013	RCT	15	Mothers of premature newborns	Domperidone 20 mg 3 times daily for 4 weeks, at week 5 twice daily and once daily for week 6	Domperidone 10 mg 3 times daily for 4 weeks. At week 5 twice daily and once daily for week 6	Increase in milk volume	20 mg instead of 10 mg was associated with clinical, but not statistically significant increase in milk production	3

Awareness of gestational diabetes mellitus among pregnant women in a health center in Turkey

Emel Kelestemur¹, Esengul Turkyilmaz², Irep Karatas Eray¹, Ayse Filiz Yavuz Avsar³

¹Department of Family Medicine, Ataturk Training and Research Hospital, Bilkent, Ankara, Turkey

²Department of Obstetrics and Gynecology, Ataturk Trainig and Research Hospital, Bilkent, Ankara, Turkey

³Department of Obstetrics and Gynecology, Yildirim Beyazit University, Bilkent, Ankara, Turkey

Background and AIM: Gestational diabetes mellitus (GDM) is defined as glucose intolerance that is first diagnosed during pregnancy. GDM is a kind of diabetes with a high risk of maternal and fetal morbidity. For the decrease in fetal morbidity and prevention of Type 2 diabetes mellitus (DM) development in mother, a 1-h 50-g oral glucose tolerance test (50g OGTT) is strongly recommended for 24-28 weeks of gestation according to guideline of the society of endocrinology and metabolism of Turkey (TEMED). Lately, it has been observed that the number of pregnancies, who do not attend OGTT, is continuously increasing. This study was done to understand the reasons of that increase and measure the knowledge of pregnancies about OGTT. METHOD: This study is consisted of a questionnaire, which is designed to measure the knowledge of pregnancies about the OGTT with 14 questions. It was conducted on pregnancies admitted to pregnant clinic during the months of February-2015 and April-2015. RESULTS: Three hundred and forty-two pregnant women participated in the study. Mean age of the women was 27.7 years and mean week of gestation was 19.3. Overall, 52.1% women did not want to attend OGTT and 63.2% of that believed that OGTT was harmful for both mother and fetus. 48.7% of the women, who believed that OGTT was harmful, acquired this knowledge from the television/radio. CONCLUSION: Person-oriented preventive medicine is one of the major responsibilities of family doctors. Advising and education are indispensable for periodic health examination. However, because of the wrong and non-evidence based information on the media, some of the screening test such as OGTT, can be refused. The decrease in the incidence and prevalence of disease having a high risk of morbidity including GDM can be achieved only with correct and evidenced based advising and education given by family doctors.

Keywords: Gestational diabetes mellitus (GDM), awareness, oral glucose tolerance test (OGTT)

Figure 1.

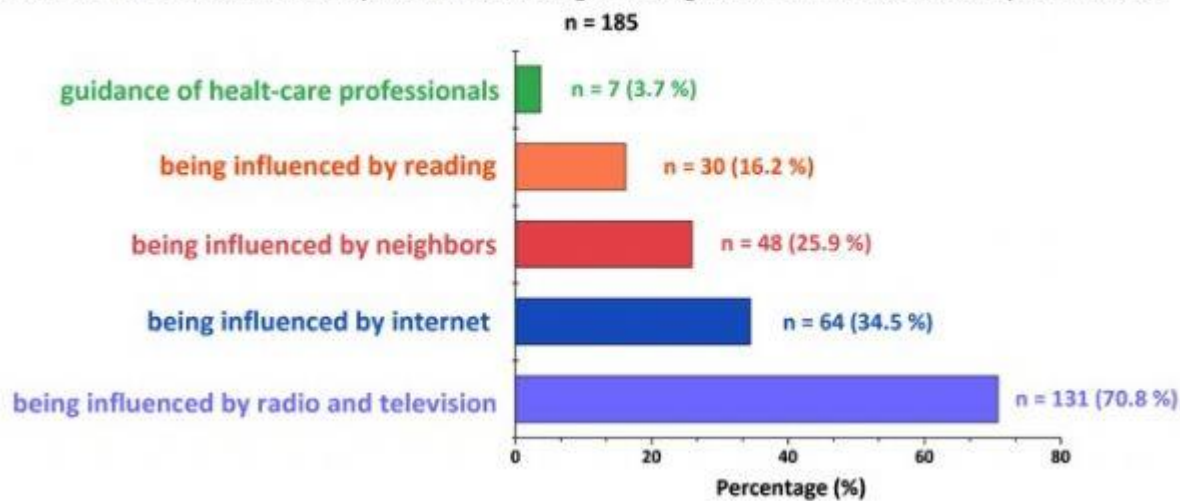


Table 1.

Q1. What is your birth date?
Q2. When did the last menstrual period start?
Q3. When is the glucose loading test done? (Which week or month of pregnancy)
Q4. Why is the glucose loading test done?
Q5. Have you ever been diagnosed with diabetes mellitus?
Q6. Do you have any relatives who were diagnosed with diabetes mellitus?
Q7. If the answer to the previous question was yes, what is the degree of relationship?
Q8. What is your education level?
Q9. Are higher levels of blood glucose during pregnancy harmful to mother and baby?
Q10. If the answer to the previous question was yes, what may be harmful effects?
Q11. Did you have glucose loading test in your previous pregnancy?
Q12. Do you consider having the glucose loading test during your current pregnancy?
Q13. If the answer to the previous question was no, what are the reasons?
Q14. What are the factors that make you think sugar loading test is harmful for both baby and mother?

Figure 2.

What are the factors that cause you to think that sugar loading test is harmful for both baby and mother?



P-1084

Assessing how well Diabetes is controlled in General Practice

Madalina Daniela Graure, Alexandru Claudiu Coman, Elena Martínez García, Jose Pedro Olivo Ros, Victor Arroyo Moreno, Juana Flores Torrecillas, Rosa María Requena Ferrer
Cartagena Casco Antiguo Health Center, Cartagena, Murcia, Spain

• Background & Aim

A maintained chronic hyperglycemia in diabetics results in micro and macrovascular long term complications increasing morbidity and mortality. Our main objective is to determine if the diabetics from our health centre present an adequate metabolic control.

Specific OBJECTIVES:

- Determine the prevalence of DM I and II
- Determine the HbA1c and the prevalence of cardiovascular risk factors: BMI, abdominal perimeter (AP), high blood pressure (HBP), hypercholesterolemia (HCL), hypertriglyceridemia (HTG), smoking, renal function
- Determine the prevalence of metabolic syndrome and high cardiovascular risk (SCORE)
- Determine which DM treatment is best related to good metabolic control

• Method

Design: cross-sectional study

Inclusion criteria:

- ≥18 years
- DM I or II

Exclusion criteria:

- Disabled patients
- Pregnant women
- Who do not want to participate

Sample size: 302 (95% confidence level, 5% precision rate, estimated loss 5%).

Sampling: simple random

Once selected the patients, they are called to come to the center on Fridays for data collecting.

Variables: gender, age, type of DM, HbA1c, BMI, HBP, HCL, HTG, smoking, metabolic syndrome, if they present HbA1c annual control, SCORE, DM treatment, renal function (glomerular filtration rate, creatinine, microalbuminuria).

Those who present an inadequate control are scheduled for treatment adjustment.

Data will be processed in SPSS-18.0.

• Results

Our study will finish in May of 2015. The data collected and processed until this date indicates that our patients could be better controlled and that most of them present metabolic syndrome. Overweight and obesity is a major risk factor present in more than 50% of the patients. Renal function should be better investigated.

• Conclusions

Our study will offer real information about the control of DM and if enough attention is given to other cardiovascular risk factors which increase global mortality. Our results will help us implement new follow-up strategies for a better control.

Keywords: Diabetes Mellitus, Metabolic Syndrome, hemoglobin A1c protein

P-1085

Depression Levels And Affecting Factors In Health Care Workers

Kenan Taştan¹, Abdulkadir Kaya¹, Beytullah Ismet Demirhan¹, Suat Sincan²

¹Ataturk University Medical Faculty Department of Family Medicine

²Atatürk University Student Health Center

Introduction and OBJECTIVES: Depression is important health problem, because of the prevalence and causes loss of ability. Lifetime prevalence ranged 10%-20%. Depression has presented at the beginning the most common diagnosis among all disorders in patients who presented to primary health care. In many studies, the role of working environment was determined in mental health disorders on workers. In this study, we aimed to discuss the factors that affect depression levels on health professionals.

METHOD: 337 people were taken randomly, admitted to policlinic of workplace health service in Atatürk University. Beck Depression Screening Scale Turkish translation for primary care were applied to patients. Results were analyzed with SPSS. Fisher's exact test and Mann-Whitney test were used. P value <0.05 was accepted for significant.

RESULTS: The average age of people in the study was 34.6±10.2. 56.9% of respondents (n=192) were female, 43.1% (n=145) consisted of men. The average of the scores obtained from the Beck Depression Screening Scale of the patients were 1.7±2.2. In this study, 11.3% (n=38) people 5 and above, 1.5% (n=5), people also took scores of 10 and above. 9.8% of participants (n=33) had received a diagnosis of depression before. The average of the depression scores of these individuals were significantly higher than those without a previous diagnosis (P<0.001). The situation of participants receive a diagnosis of depression before between marital status was not a significant relationship (p=0.13).

Conclusion and DISCUSSION: Depression ratio of health workers in a study in Brazil found 16%. Our study seems to be lower than that rate. Depression rate in people who participated in the study were close to the lower limit of depression rate in our country. Such as working in a hospital and in occupations that have night duty, there is a need for wider participated studies related to mental disorders.

Keywords: Depression, Health Workers, Beck Depression Screening Scale

P-1086

Screening for abdominal aortic aneurysm - an evidence-based review

Vítor Portela Cardoso¹, Paula Mendes²

¹USF Gualtar, ACES Cávado I, Braga, Portugal

²USF Maxisaúde, ACES Cávado I, Braga, Portugal

Background and AIM: An Abdominal Aortic Aneurysm (AAA) is defined when the diameter of the aorta is greater than 3 cm. The estimated prevalence is 4-9% in men and 1% in women. Although usually asymptomatic, the rupture of an AAA is associated with a mortality rate of 80%. If detected early, the mortality rate of elective surgery for AAA is 5%. Our aim was to review the evidence of mortality and adverse effects of screening for AAA in asymptomatic adults.

METHODS: We conducted a research for meta-analyzes (MA), systematic reviews (SR), randomized clinical trials (RCT) and clinical practice guidelines (CPG), in the data sources National Guideline Clearinghouse, Guidelines Finder, Canadian Medical Association Practice Guidelines, Cochrane, DARE, Bandolier, Medline and Index of Portuguese Medical Journals, published between 01/01/2003 and 03/23/2013 in Portuguese, Spanish, English and French languages, using the MeSH terms abdominal aortic aneurysm and mass screening. We used the Oxford Centre for Evidence-Based Medicine scale for assessment of levels of evidence (LE).

RESULTS: Of 337 articles obtained, 10 met the inclusion criteria (2 MA, 1 SR and 7 CPG). The SR and the MA selected showed that screening for AAA significantly decreased mortality in men aged between 65-75 years old, but not in women. A reduction in all-cause mortality was observed in one MA, which estimated a number needed

to screen of 156. This is lower than the number needed to screen in current cancer screening programs. Screening doubled the number of elective surgeries and decreased the number of emergency surgeries for ruptured AAA by half.

CONCLUSIONS: Consistent, good quality evidence demonstrated a reduction in mortality from AAA by screening asymptomatic men aged ≥ 65 years (LE1). The treatment of AAA is associated with significant risk of death and surgical complications, which may be acceptable in individuals at high risk.

Keywords: abdominal aortic aneurysm, mass screening, mortality, side effects.

Systematic Review

Systematic Review					
REFERENCE	POPULATION	INTERVENTION	RESULTS	LE	
			MORTALITY	ADVERSE EFFECTS	
Cosford et al 2007 United Kingdom	4 RCT n= 127891 men. 65-83 years. Follow-up 2.5-5.1 years.	AAA ultrasound screening in asymptomatic adults	<ul style="list-style-type: none"> ➢ Significant decrease in mortality from AAA in ♂ aged 65-79 years (OR = 0.60, 95% CI: 0.47-0.78) but not in women. ➢ No significant effect on all cause-mortality (OR = 0.95, 95% CI 0.85-1.07) 	<ul style="list-style-type: none"> ➢ Significant increase in surgeries OF AAA in ♂ (OR = 2.03, 95% CI 1.59 to 2.59). 	1

Systematic Review included

Meta-analysis

Meta-analysis				
REFERENCE	POPULATION	INTERVENTION	RESULTS	LE
Takagi et al, 2010 Japan	4 ECAC n= 114376 ♂ ≥ 65 years.	Long-term effects of AAA screening (≥ 10 years)	<ul style="list-style-type: none"> ➢ Significant decrease in mortality from AAA (OR = 0.55; 95% CI 0.36-0.86; absolute risk reduction (ARR) 4/1000, NNR= 238). ➢ Big trend for reduced mortality from all causes (OR = 0.98; 95% CI 0.95-1.00; ARR 5/1000, NNS= 217) 	1
Takagi et al, 2012 Japan			<ul style="list-style-type: none"> ➢ Significant decrease in all cause mortality (OR=0.973; 95% IC 0.95-0.997; ARR 64/10000, NNS=156). 	

Meta-analysis included

Clinical Practice Guidelines

Clinical Practice Guidelines				
REFERENCE	COUNTRY	RECOMMENDATIONS	LE	
USPSTF, 2005 ⁶	USA	Single screening with abdominal ultrasound to men aged 65-75 years who have ever smoked at least 100 cigarettes throughout their lives.	1	
		No recommendation for or against for men aged 65-75 years who had never smoked.	3	
		Recommends against screening in women.	2	
ACC/AHA 2005 ²	USA	Men aged 65-75 years who smoke or have smoked should undergo a physical examination and a single ultrasound screening.	1	
		Men aged ≥ 60 years, who are siblings or children of patients with AAA, should undergo a physical examination and abdominal ultrasound.	2	
NSC, 2007 ⁹	United Kingdom	Single screening with abdominal ultrasound in men aged 65 years.	2	
ESVS, 2011 ¹⁰	Holland	Single screening with abdominal ultrasound to men aged 65.	1	
		Consider screening at a younger age for those at high risk for AAA. Consider screening of individuals aged > 50 years with a family history of AAA.	4 3	
CSVS, 2007 ¹¹	Canada	Screening for men aged 65-75 years.	2	
		Consider screening with ultrasound in women with > 65 years and multiple risk factors for AAA (smoking, cerebrovascular disease, family history of AAA).	5	
		Against the screening of women aged > 65 years and adult population aged < 65 years.	3	
GSVS, 2009 ¹²	Germany	Single screening with abdominal ultrasound men aged > 65 years, especially if they are or have been smokers.	1	
		Single screening with abdominal ultrasound in individuals of all ages with a family history of AAA.	3	
		Single screening with abdominal ultrasound to women aged > 65 years who are or have been smokers and cardiovascular disease history.	5	
SVS, 2004 ¹³	USA	Single screening with abdominal ultrasound in all men aged 60-85 years.	2	
		Women aged between 60-85 years with cardiovascular risk factors. In all individuals aged > 50 years and with a family history of AAA.	5 5	

Clinical Practice Guidelines included

P-1087

Substance consumption in Paredes teenagers and young adults

Carlos Franclim Moreira Silva¹, Paulo Alexandre Azevedo Pereira Santos², Paula Alexandra Rocha³

¹USF S. João do Porto

²Faculdade de Medicina da Universidade do Porto

³CIES-IUL e ICS- Universidade do Minho

BACKGROUND: Habits, lifestyles and potential risk behaviors are mainly acquired during adolescence. Paredes, a county in the north of Portugal, is on top 10 of the youngest municipality, with people between 14 and 24 years of age counting for 14,1% of total inhabitants.

AIM: To characterize substance use habits of young inhabitants of Paredes.

METHODS: We conducted a cross-sectional study with population basis of young people aged 14 to 24, living in Paredes. An auto-administrated questionnaire was distributed using the random route method to a stratified cluster sample of 746, from May/2013 to September/2014. We accepted an alpha error of 0,05.

RESULTS: The majority of young people have tried alcohol (81,9%), specially males ($p=0,017$), with the median of 15 years old for the first time. Tobacco was used by 54,5%, mainly by males ($p=0,001$). The median of the first time for tobacco was 15 years old. Cannabis was experienced by 13,9%, most in males ($p<0,001$) with the median age for the first time at 16 years old. Dropping out of school system is significantly associated to high prevalence of harmful habits.

CONCLUSIONS: The consumption of harmful substances is a major health problem in this population, mainly in the male gender. The school appears to have a protective effect in teenagers and young adults

Keywords: adolescence, substance use, tobacco

P-1088

Is the prevalence of smoking in Federation of Bosnia and Herzegovina decreased in 2015?

Olivera Batic Mujanovic¹, Azijada Beganlic¹, Larisa Gavran², Edita Cerni Obrdalj³, Amra Zalihic³

¹Family Medicine Teaching Centre of Health Centre Tuzla; Department of Family Medicine, Medical Faculty of Tuzla University, Tuzla, Bosnia and Herzegovina

²Family Medicine Teaching Centre of Health Centre Zenica; Department of Health Care in Community, Health Faculty of Zenica University, Zenica, Bosnia and Herzegovina

³Family Medicine Teaching Centre of Health Centre Mostar; Department of Family Medicine, Medical Faculty of Mostar University, Mostar, Bosnia and Herzegovina

Background & AIM: Cigarette smoking is the largest preventable risk factor for morbidity and mortality in developed countries. We compared prevalence of smoking in people attended primary care centres from three cantons in Federation of Bosnia and Herzegovina 2015 and 2012.

METHODS: Study included people attended 16 primary care centres 2015 and 21 primary care centres 2012 from three cantons: Tuzla Canton, Unsko-Sanski and Posavski Canton. Every family medicine team, involved in the Program of Additional Training in Family Medicine, completed questionnaire for 100 patients about their smoking status and readiness to quit smoking. Data collections were performed between February-March 2012 and 2015.

RESULTS: Study included 3700 participants (aged 10-88 years): 1761 (47.59%) men and 1939 (52.41%) women. Prevalence of smoking 2015 is significantly lower than 2012 (40.06% vs. 47.71%; $p<0.0001$). Significantly more men than women are still smokers (50.82% vs. 38.58; $p<0.0001$). Number of ex smokers remained approximately the same 2015 and 2012 (17% vs. 17.1%; $p=0.9$). Significantly more men than women are still ex smokers (21.98% vs. 12.62%; $p<0.0001$) 2015 and 2012. Significantly more women than men have never smoked (61.95% vs. 22.95%; $p<0.0001$) 2015 and 2012. Significantly lower percentage of smokers don't think to quit smoking 2015 compared to 2012 (48.67% vs. 53.6%; $p=0.05$), while percentage of smokers who think to quit in the next six months is approximately the same 2015 and 2012 (38.53% vs. 37.5%; $p=0.68$). Significantly higher percentage of smokers are ready to quit smoking immediately 2015 compared to 2012 (12.79% vs. 8.88%; $p=0.01$).

CONCLUSION: Results of this study shows that the prevalence of smoking in Federation of Bosnia and Herzegovina

is still very high. It suggests more effective interventions of primary care teams to identify people who smoke and offer them comprehensive advice and appropriate treatment to quit smoking.

Keywords: prevalence, smoking, Federation of Bosnia and Herzegovina

Figure 1. Distribution of participants in 2015 related to gender

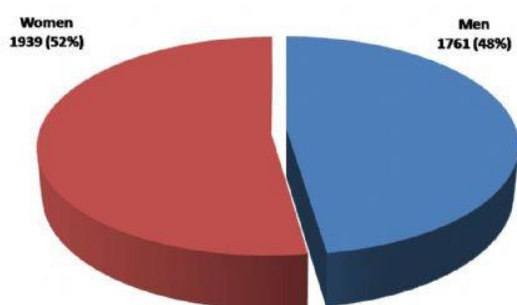


Figure 2. Distribution of participants in 2015 related to smoking status

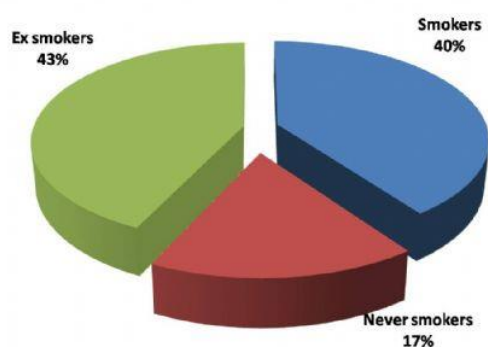


Table 1. Smoking status of participants in 2015 related to gender

Smoking status	Men	Women	Total	p
Smokers	*50.82%	38.58%	40.06%	<0.0001
Ex smokers	*21.98%	12.62%	17.00%	<0.0001
Never smokers	22.95%	*61.95%	42.94%	<0.0001

Table 2. Comparison of smoking status of participants in 2015 and 2012

Smoking status	2015	2012	p
Smokers	40.06%	*47.71%	<0.0001
Ex smokers	17.00%	17.10%	0.9
Never smokers	*42.94%	35.19%	<0.0001

Table 3. Comparison of readiness to quit smoking in 2015 and 2012

Readiness to quit smoking	2015	2012	p
Do not think to quit smoking	48.67%	*53.6%	p=0.05
Think to quit in the next six months	38.53%	37.5%	p=0.68
Ready to quit smoking immediately	*12.9%	8.88%	p=0.01

P-1089

The influence of social support, sexual life and mental health status on quality of life of breast cancer patients

Ali Kızıl¹, Kenan Topal¹, Timuçin Çil², Yarkın Özenli³, Çiğdem Gereklioğlu⁴

¹Adana Numune Training and Research Hospital, Department of Family Medicine, Adana/Turkey

²Adana Numune Training and Research Hospital, Department of Oncology, Adana/Turkey

³Adana Numune Training and Research Hospital, Department of Psychiatry, Adana/Turkey

⁴Baskent University Medical Faculty, Department of Family Medicine, Ankara/Turkey

BACKGROUND: To investigate social support status, sexual life satisfaction, anxiety and depression risk and quality of life of the breast cancer patients who were being followed up and treated at Medical Oncology Clinic of Adana Numune Research and Training Hospital.

MATERIAL-METHOD: This is a cross-sectional study conducted with 107 women who were admitted between 1 August 2014 and 31 October 2014. Demographic characteristics, breast cancer risk factors, disease process of the patients were questioned. Arizona Sexual Experience Scale, Multidimensional Perceived Social Support Scale, Hospital Anxiety and Depression Scale, World Health Organization Quality of Life Scale Short Form Turkish version (WHOQOL-BREF TR) were applied to the patients. Two independent sample t-test, One Way Anova, Chi-square tests were used for statistical analysis.

RESULTS: Mean age of the patients was 49.5±10.4 years (range 26 to 74 year). While 43.9% of the patients were illiterate, 42.1% were graduates of elementary-intermediate school, 14% were graduates of high school-university. Of the patients, 87.9% were in low income group, 12.1% were in moderate-high income group, 68.2% (n=73) of the patients were married. Anxiety risk was found in 29.0% (n=31) and depression risk was found in 58.9% (n=63) of the patients. Social support and quality of life were seen to be poorer in patients with high anxiety risk (p=0.010, p=0.0001). Satisfaction from sexual life (p=0.0001), social support (p=0.0001) and quality of life (p=0.0001) were found poorer in the patients whose depression risk was high.

CONCLUSION: The patients with breast cancer should not be only biologically treated but also psychological and social support should be provided and quality of life should be improved. High ratios of anxiety and depression require multidisciplinary approach. These measures which are taken during follow up and treatment would improve quality of life.

Keywords: breast cancer, anxiety, depression, quality of life

P-1090

Assessment of Health Care Utilization in Different Sociocultural Groups Living in Adana Province

Aslı Korur¹, Nafiz Bozdemir², Esra Saatçi², Çiğdem Gereklioğlu¹, Süheyl Asma¹

¹Başkent University, Department of Family Medicine, Adana, Türkiye

²Çukurova University, Department of Family Medicine, Adana, Türkiye

Background&AIM: The aim of this study was to assess the utilization of health care settings in different sociocultural groups in the city center of Adana, the relationship between sociodemographic parameters and utilization of health care systems and to show the ecology of medical care.

METHOD: We enrolled 685 person living in three different sociocultural regions (high, moderate, poor) in Adana province. The study was conducted from 1 May 2009 to 15 June 2009. Sociodemographic data collection questionnaire, health attitude behavior assessment questionnaire and short form-12 (SF-12) short health scale were completed face-to-face. Data was installed and analyzed with statistical package programs.

RESULTS: Of 685 individuals, 504 (73.6%) were women, 181 (26.4%) were men, the mean age was 36.68±13.89 years (range:18-83). Of individuals, 273 (39.9%) were primary school graduates, 520 (75.9%) were married, 479 (69.9%) had a history of moving to Adana, 577 (84.2%) had social insurance, 368 (53.7%) assessed their socioeconomic status as 'moderate'. There was significant relationship between the educational status, social insurance status, socioeconomic status and marital status and MCS-12, a subscale of SF-12. (p<0.05) The most preferred health care setting was the secondary health care for both acute and chronic health problems. There was a significant relationship between the preferred health care settings and sociodemographic parameters (gender, educational status, age, social insurance, socioeconomic status) (p<0.01) During the last one month, 540 participants (78.8%) reported at least one health problem, 433 (38%) had self-care, 323 (28.4%) admitted to a secondary health care unit, 309 (27.1%) admitted to a primary health care unit and 2 (0.5%) were hospitalized. **CONCLUSIONS:** The utilization of health care settings is influenced by sociodemographic parameters. The most

preferred health care setting is the secondary health care. Primary care should be improved and strengthened.

Keywords: Health care system utilization, SF-12, medical ecology, primary care

P-1091

Exercise and Diabetes: A transversal study in a Portuguese Health Center

Sara Neves Costa, Sara Madeira, Joana Gabriel, Carina Vargas

USF Mactamã, ACES Sintra, Portugal

Background and AIM: The treatment of Type 2 Diabetes Mellitus (T2DM) is based on 3 bases, diet, physical exercise (PE) and pharmacotherapy. The importance of PE on T2DM justifies its recommendation by several scientific institutions.

The family physician (FP) has a fundamental role promoting behaviour changes, especially on chronic diseases. The aim of the study was characterize the relevance and knowledge of T2DM patients concerning the role of PE in the management of their disease.

METHODS: We conducted an observational, transversal, descriptive and analytical study, between April and September 2014. The population included the adult patients with a diagnostic of T2DM followed in the Unidade de Saúde Familiar Mactamã.

The data was collected by a questionnaire (especially design for this study) that included the evaluation of the Physical Activity Index.

RESULTS: 7% of the 98 patients were classified as active and 42% reported doing PE exercise as part of their T2DM treatment. The risk of being inactive increases with age (OR[CI95%]:1,07[1,01-1,13]), it's 3 times higher in women (OR[CI95%]:2,95[1,07-8,08) and increases with the Body Mass Index (OR[CI95%]:1,13[1,00-1,28]).

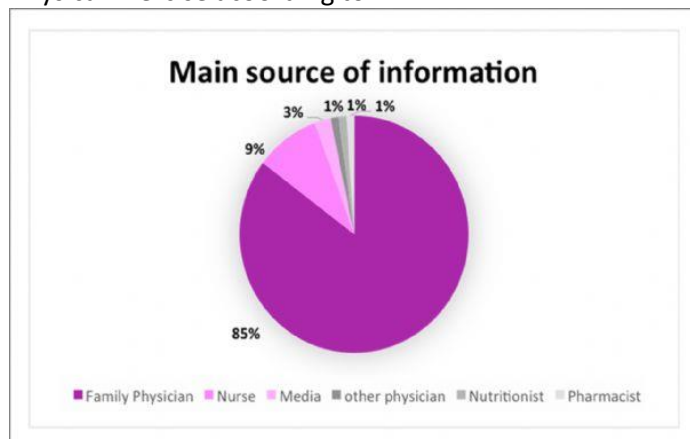
The majority of patient knew how to identify the PE recommendations and the main source of information was the FP. The patients said they were advised to practice PE in almost all appointments and considered being satisfied with the received information.

CONCLUSION: The prevalence of PE reported is equivalent to other national studies. The fact that the patients know the recommendations and are satisfied with the medical counselling, does not determine the practice of PE in the majority of this sample.

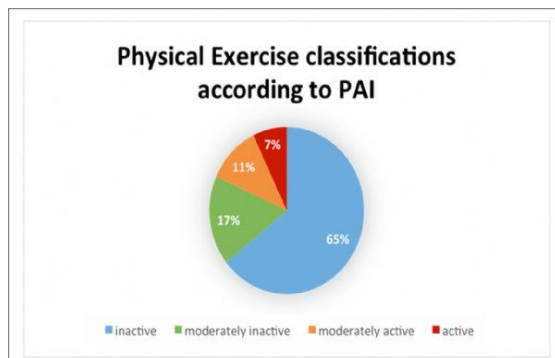
It would be important to evaluate, in future studies, the patient's motivations and limitations to practice PE in order to improve the FP interventions and increase the PE practice in T2DM patients.

Keywords: Exercise, Diabetes Mellitus, Family Physician

Physical Exercise according to PAI



Main Source of Information



Characteristics of Inactive and Not-Inactive Patients

	PAI	
	Inactive (n=63)	Not-Inactive (n=35)
Age (years) mean±SD	65,8±9,1	61,3±8,1
Gender n (%)		
Masculine	33 (55)	27 (45)
Feminine	30 (78,9)	8 (21,1)
BMI (kg/m²) mean±SD	30,3±5	28,3±4
Education n (%)		
≤ Primary	31 (70,5)	13 (29,5)
> Primary	32 (59,3)	22 (40,7)
Time since T2DM Diagnosis n (%)		
< 10 Years	32 (56,1)	25 (43,9)
≥ 10 Years	31 (75,6)	10 (24,4)

P-1092

Online structured education with email facilitation for people with type 2 diabetes: pilot study

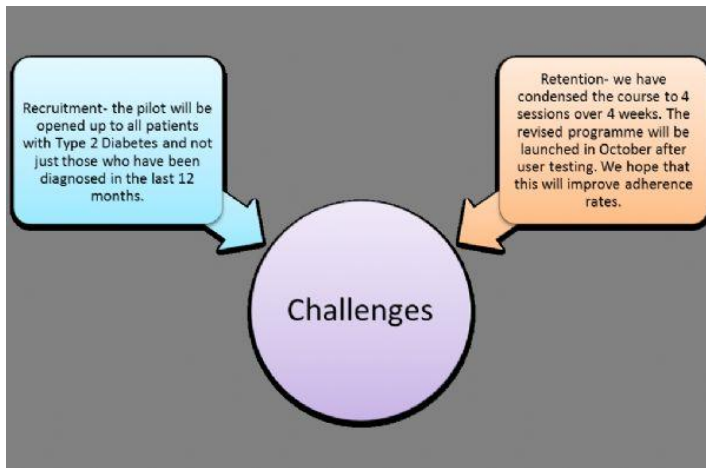
Shoba Poduval

Department of Primary Care and Population Health, University College London

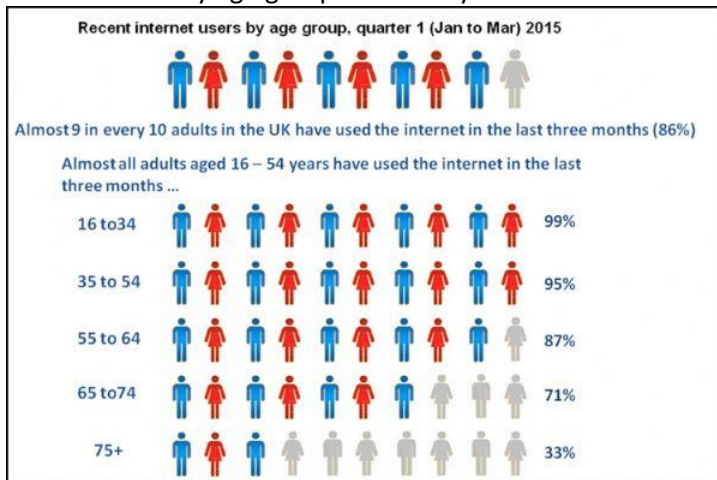
Type 2 Diabetes Mellitus (T2DM) is one of the most prevalent non-communicable diseases in the world affecting 3.8 million people in the UK alone. Annually £9 billion is spent on diabetes in the UK. Many of these costs are due to preventable complications. Data suggests that improved self-management can reduce the risk of complications fourfold. Uptake of self-management education programmes has been low, and one possible reason for this is that almost all are delivered through group-based sessions. Our research seeks to provide a more effective way of delivering self-management education to people with T2DM. I am working with an established multidisciplinary team at UCL who have developed an online structured education programme called "HeLP-Diabetes: Starting Out". A pilot study is needed to determine its acceptability and effectiveness, in order to optimize the programme and inform the design of a feasibility trial. We have designed a single arm mixed methods study to determine follow-up rates; uptake and adherence; data quality; changes in self-reported knowledge, self-efficacy, health behaviours, and diabetes-related distress; and resources required. The results of this research will allow us to apply for competitive funding for a feasibility study and subsequently for a definitive Phase 3 RCT. We will be contributing towards the body of knowledge on computerised self-management programmes for long-term conditions. The intervention has the potential to provide easily accessible self-management education to a large number of patients in a cost-effective way.

Keywords: Type 2 Diabetes, education, eHealth

Challenges



Internet users by age group Jan to May 2015



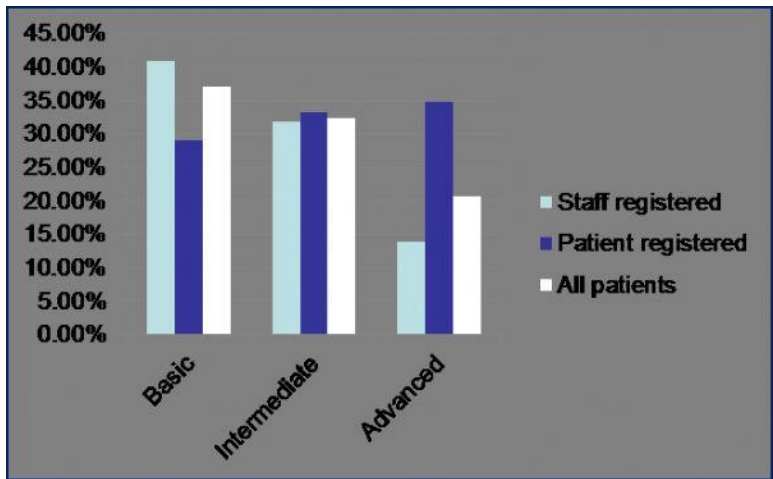
Methods

Design	<ul style="list-style-type: none"> • Single arm study using mixed methods with pre- and post-intervention quantitative measures plus qualitative interview data.
Participants	<ul style="list-style-type: none"> • Adults diagnosed with type 2 diabetes within the last 12 months, registered with participating general practices.
Outcomes	<ul style="list-style-type: none"> • Recruitment rates; follow-up rates; uptake and adherence; and changes in self-reported knowledge, self-efficacy, health behaviours, and diabetes-related distress.

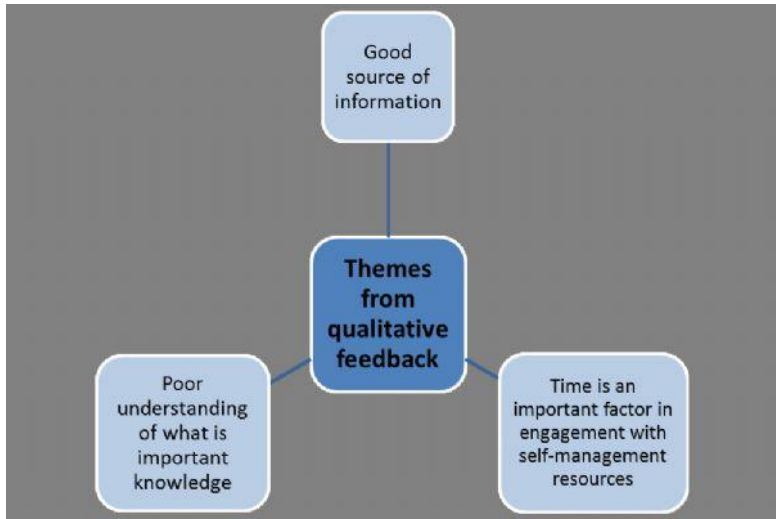
Uptake & adherence

Number of Practices contacted	22
Number of Practices agreeing to take part	14
Number of Clinical Commissioning Groups (CCGs)	4
Number of patients who have enrolled	20
Number of patients still active	13

Computer skills of patients registered for HeLP-Diabetes website Implementation Study



Themes from Qualitative Feedback



Screenshot of HeLP-Diabetes: Starting Out Welcome Page

Welcome to HeLP-Diabetes: Starting out

Previous Next

Overview of sessions

There are 8 sessions and they are listed below.

At the beginning of the course, we ask you to complete a questionnaire. This will tell us what you know already, and which areas you need most help with.

At the end of the course, we'll ask you to do the questions again.

We hope this will show you how much you've learnt, and encourage you to keep on doing things that you've learnt make you feel happier and healthier.

If you want to find out more details about the 8 sessions, you can look at the [learning goals](#).

- Session 1: Getting started
- Session 2: Self-management
- Session 3: Improving my health and well-being
- Session 4: Taking control of my diabetes
- Session 5: Medication and lifestyle
- Session 6: Reducing my risks
- Session 7: Working with my health care team
- Session 8: Celebrating success and planning for the future

Please click on the **Next** arrow to find out about email support available to you as part of this programme.

Part 3 - Reducing the risks of heart attacks and stroke

Previous Next

Complications

Problems with the heart and vessels are common even in people who don't have diabetes.

Although diabetes increases the risk, taking steps to promote health in addition to taking medicines can be very effective.

Click on the links below to find out more about these complications:

[Atherosclerosis](#)

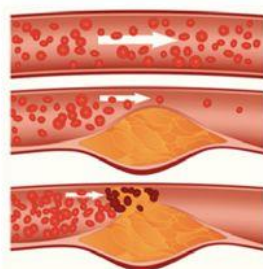
[High blood pressure](#)

[Heart disease](#)

[Problems with circulation in the legs](#)

[Problems with the blood supply to the brain](#)

[When should I contact my doctor?](#)



Previous Next

P-1093

Relationship Between Premature ventricular complexes and Neutrophil–Lymphocyte Ratio in asymptomatic healthy young men

Erkan Kibrisli¹, Sinan Iscen², Ahmet Yilmaz¹, Salim Ozenc³, Adem Parlak⁴, Duran Tok⁴

¹Family Physician, Dicle University Medicine Faculty Departments of Family Medicine, Diyarbakir, Turkey

²Cardiologist, Diyarbakir Military Hospital, Yenişehir, Diyarbakir, Turkey

³Family Physician, Diyarbakir Military Hospital, Yenişehir, Diyarbakir, Turkey

⁴Family Physician, Presidential Guard Regiment, Ankara, Turkey

BACKGROUND: Premature ventricular complexes (PVC) are a relatively common electrocardiographic abnormality presenting in individuals without overt cardiovascular disease. There is no clear mortality benefit from VPB suppression in asymptomatic patients. In addition, It has been showed that evidence for structural heart disease consistent with non-ischemic scarring possibly due to inflammation in patients with premature ventricular beats. This situation suggests that the mechanisms by which VPBs can be also generated with include clinical and subclinical inflammation. The neutrophil–lymphocyte ratio (NLR) is an easy, cheap, noninvasive, and universally available laboratory marker used to evaluate clinical and subclinical systemic inflammation. We investigated the NLR in asymptomatic healthy young men with PVC (structural heart disease excluded with cardiac magnetic resonance imaging) compared with controls. The study group consisted of 21 asymptomatic healthy young men with PVC (mean age 22.7 ± 2.0 years). Insead of Lown's grading of VPBs, we considered as endpoints > 153 PVC over 24 h (in Holter Electrocardiogram). The control group consisted of 922 male (mean age $22.6 + 3.1$ years). Hematologic indices were measured within 30 minutes of collecting the blood samples in tubes containing dipotassium EDTA. There were no significant differences between the 2 groups with respect to age, gender, body mass index, smoking, creatinine, total cholesterol, triglyceride, LDL-C, HDL-C, hemoglobin levels, white blood cell count, and red cell distribution width. The NLR was significantly higher among the men with PVC than that of the control group (2.7 ± 0.7 vs 1.5 ± 0.4 , respectively; $P < .001$) We found that the NLR is significantly elevated in asymptomatic healthy young men with PVC compared with control participants. The increased NLR values might indicate subclinical and clinical inflammation in asymptomatic healthy young men with PVC, and we must consider that there can also be inflammation about the mechanisms of VPBs in humans.

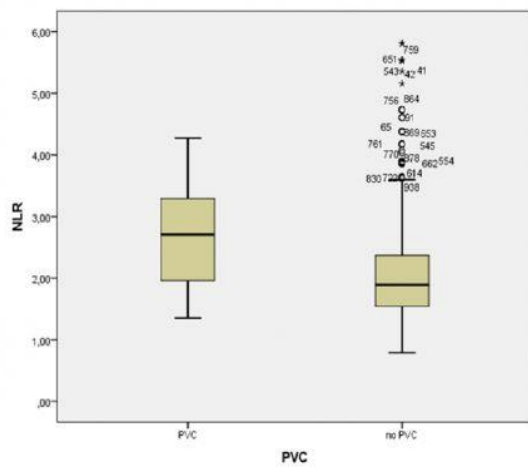
Keywords: Premature ventricular complexes (PVC), neutrophil–lymphocyte ratio (NLR), inflammation

Comparison of the Clinical and Laboratory Characteristics of the Asymptomatic Healthy Young Men With PVC and Control group.

	GROUP WITH PVC	CONTROL GROUP	P
N	21	962	
Age,	22.7 ± 2.0	22.6 ± 3.1	0.16
BMI, kg/m ²	22.6 ± 1.8	22.7 ± 1.7	0.91
Echocardiography	normal range	normal range	
Smoking,	9% 14	19%	0.34
Glucose, mg/dL	97 ± 5	90 ± 5	0.18
Creatinine, mg/dL	1.03 ± 0.10	1.00 ± 0.22	0.06
Total cholesterol, mg/dL	156 ± 35	157 ± 24	0.28
Triglycerides, mg/dL	124 ± 69	122 ± 36	0.19
LDL-C, mg/dL	102 ± 17	101 ± 15	0.16
HDL-C, mg/dL	34 ± 3	35 ± 3	0.15
WBC, 1000/mm ³	6.57 ± 0.92	6.58 ± 1.28	0.22
Hemoglobin, g/dL	14.5 ± 1.2	14.5 ± 1.1	0.15
RDW, %	14.2 ± 1.2	14.3 ± 1.6	0.14
Neutrophils, x1000/mm ³	4.1 ± 0.6	3.7 ± 1.1	0.004
Lymphocytes, x1000/mm ³	1.6 ± 0.45	1.8 ± 0.51	0.009
NLR	2.6 ± 0.8	2.1 ± 0.7	0.002

Abbreviations: BMI, body mass index; LDL-C, low-density lipoprotein cholesterol; HDL-C, high-density lipoprotein cholesterol; WBC, white blood cells; RDW, red cell distribution view; NLR, neutrophil lymphocyte ratio.

Comparison of the neutrophil lymphocyte ratio(NLR) of groups



P-1094

The Impact of Smoking Habit on HbA1c Level

Izzet Fidancı, Oğuz Tekin, İsmail Arslan, Şükrü Ümit Eren, Gökhan Dinçer, Özlem Kızıldaş
Department of Family Medicine, Ankara Training and Research Hospital, Ankara, Turkey

OBJECTIVE: In this study, we aimed to assess the impact of smoking habit on glycated hemoglobin, HbA1c.

MATERIAL-METHOD: We applied a questionnaire asking demographics and smoking status to 204 patients admitted Ankara Training and Research Hospital, Family Medicine Outpatient Clinics and got a HbA1c level. Body mass index was calculated for all patients. Fagerström Nicotine Dependence Test was applied to smokers.

RESULTS: Of 204 patients, 101 were male (49.5%) and 103 were female (50.5%). The study population consisted of 69 (33.8%) previous smokers, 63 (30.9%) smokers, and 72 (35.3%) never smoked patients. Mean age of patients was; 34,84(±12.53) years in previous smokers, 35.83(±14.70) years in smokers, and 41,75(±13.84) years in patients who never smoked. HbA1c level was significantly higher in males than females ($p<0.05$). In the assessment of age-HbA1c relationship, HbA1c levels was positively correlated with age ($p<0.05$). HbA1c levels was significantly higher in smokers and previous smokers than patients who never smoked ($p<0.001$).

CONCLUSION: According to our results, smoking habit increases the HbA1c level and is an important changeable risk factor, especially for patients with diabetes mellitus. We should promote to cessation of smoking in smoker patients to improve regulation of blood glucose level and prevent diabetes mellitus.

Keywords: Smoking, HbA1c, Diabetes Mellitus

Table-1. According to the average of the variable Smoking Habits.

Variables	Quitted Smoking(Sd)	Smokers(Sd)	Never Smoked(Sd)	P
HbA1c(%)	5,79(0,80)	6,69(1,27)	5,41(0,60)	<0,001
Fasting Glucose(mg/dL)	104,14(23,57)	117,81(36,11)	99,03(18,89)	0,232
Postprandial Glucose (mg/dL)	137,94(33,14)	157,75(48,86)	126,12(20,06)	0,356
Weight(kg)	73,70(7,29)	74,35(8,30)	72,31(8,17)	0,834
Height(cm)	161,25(4,59)	162,20(4,74)	161,04(4,11)	0,768
Body Mass Index(kg/m ²)	28,35(2,67)	28,25(2,79)	27,81(2,21)	0,964

P-1095

Our one month experience of diagnostic variations and demographics of the cases that admitted to family medicine outpatient clinic

Nur Şimşek Yurt, Feyza Nur Topçu Yenerçağ, Mahcube Çubukçu

Department of Family Medicine, Samsun Education and Research Hospital, Samsun, Turkey

AIM

To determine the diagnostic variations and demographics of the cases that admitted Samsun Education and Research Hospital, Family Medicine Outpatient Clinic and to plan a more qualified health service practice intended for our target group.

MATERIAL and METHOD

Study was conducted by the data of the patients over sixteen years who admitted to Family Medicine Outpatient Clinic in Samsun Education and Research Hospital in between 25.11.2010 and 25.12.2010 that obtained by hospital electronic registration system with file screening method. The data was evaluated retrospectively.

RESULTS

Of the 104 patients admitted to our Family Medicine Outpatient Clinic in between 25.11.2010 and 25.12.2010, 51 (%49.0) were women and 53 (%51.0) were men. Mean age was 48.6 in women and 46.1 in men. When the diagnoses were examined, the most common reasons for admission to our clinic were general medical examination (%27.9), hyperlipidemia (%11.6), hypertension (%10.6), anxiety (%9.6), dyspepsia (%8.7), stomachache (%6.8), anemia (%4.8), urinary tract infection (%3.8), diabetes mellitus (%3.8), myalgia (%3.8), lumbalgia (%2.8), angina pectoris (%1.9), chronic sinusitis (%0.97), epistaxis (%0.97), hypothyroid (%0.97), tinnitus (%0.97). It's detected that 57 of the cases (%54.8) were not prescribed and 47 of them (%45.2) were prescribed.

CONCLUSIONS

As admissions to Family Medicine Outpatient Clinic were evaluated, the number of the women and men was found very close to equal and the most of our cases were in the middle age group. Chronic diseases like hypertension and diabetes were seen less often than their prevalences in Turkey. Because of the fact that our Family Medicine Outpatient Clinic is also serving as a periodic health examination institution for the adult people who doesn't suffer from any diseases, admissions for the general medical examination were the majority. Trainings may be planned to improve the quality of the service for our most common diagnoses in outpatient clinic.

Keywords: Family Medicine Outpatient Clinic, diagnose, disease

P-1096

Assessment of the nutritional status of the patients who are followed by home care unit

Feyza Nur Topçu Yenerçağ, Nur Şimşek Yurt, Mahcube Çubukçu

Department of Family Medicine, Samsun Education and Research Hospital, Samsun, Turkey

OBJECTIVE: We aimed assessment of socio-demographical and medical properties of the patients using nutritional products, who are followed by Samsun Education and Research Hospital Home Care Unit.

METHODS: Our study have been performed by analyzing the data of patients older than sixteen years old who are followed by Samsun Education and Research Hospital Home Care Unit between January 2014 to April 2015. This study is retrospective and descriptive type of study.

RESULTS: We included 71 patients to the study, which have malnutrition or under the risk of malnutrition. We excluded the patients who have died before the study ended. 52 (73,2%) of the patients were women, 19 (26,8%) were men, and the mean age of the study was 77,5. 62 (87,3%) of the patients were bedridden, 9 (12,7%) were nearly bedridden. 18 (25,3%) of the participants had decubitus ulcers. Patients who were included to our study, had been using enteral nutrition for the mean of 11 months. 52 (73,2%) of the patients were taking their nutrition orally, 13(18,3%) with PEG, and 6(8,5%) of them were with nasogastric catheter. 50,7% of the participants have had Alzheimer disease, 35,2% have had some kind of serebrovascular disease, 7% have had chronic renal failure, 4,2% have had epilepsy, and 2,8% have had demans. The mostly seen comorbidity among the patients was hypertension with the number of 28(%39,4) people. Diabetes Mellitus was the following one with the number of 15(%21,1).

CONCLUSION: Nutrition is the most important changeable factor for well being of the patients. Particularly for the home care patients to improve the well being, and the state of the disease, nutrition should be performed in adequately by proper ways. To come to a conclusion; it is very important to find out nutritional status of home care patients and curing the malnutrition by appropriate ways.

Keywords: Home Care Unit, nutrition, malnutrition

P-1097

Media Effects on Statin Treatment and Determination of Reaching the Target LDL Ratio

Gökhan Dincer¹, Zeynep Sayın Dincer², Yakup Alsancak³, Enes Gümüüş¹, Nuri Şengüleroğlu¹, Aybüke Demir Alsancak², İsmail Arslan¹, Oğuz Tekin¹

¹Department of Family Medicine, Ankara Training and Research Hospital, Ankara, Turkey

²Department of Family Medicine, Ankara Numune Training and Research Hospital, Ankara, Turkey

³Department of Cardiology, Ankara Atatürk Training and Research Hospital, Ankara, Turkey

Background-AIM: As a result of extensive researches, patients who clinical requirements although the unquestionable benefits of treatment statin, recently, there is many discussion about the use of statins on media in Turkey.

It was aimed to report media effects on compliance with medication on statin therapy and determination of reaching the target LDL(Low density lipoprotein).

METHOD: The descriptive and observational research was conducted between October 2014- February 2015.

Data were collected from office of family medicine. The study population comprised patients who use statin at time of study, newly diagnosed dyslipidemia or discontinued statin therapy. Demographic-clinical characteristics, views about use of statins and health related behaviours of participants were collected from a questionnaires.

RESULTS: 58 male and 113 female patients(n=171) were included to study(mean age:62.6 years). 130 patients took statin before and 42.6 % of them were still on treatment. 36.6 % of these patients had target LDL values and the average duration of treatment was 6.6 years. Compliance with medication was not associated with sociodemographics such as age, sex, education level and financial income. Patients who discontinued statin therapy (n=70) were because of media effects in 52.9% and other physician's decision in 34.3%. Patients who discontinued or not previously initiated therapy were 111 people. 28.8% of them refused to use statins(93.8% of them media effects).

CONCLUSIONS: Although the evidences during last twenty years showed benefits of reduced LDL, it is still far for optimized target levels, compliance with medication and initiation of therapy all over the world. Results are similar in our study. Besides appropriate treatment, It is important to provide patient compliance in family medicine

practice. These findings show that media effects on patient attitude towards statins and treatment compliance. It is clear to need that family physicians should evaluate the compliance and inform patients openly.

Keywords: statin, media, LDL, patient compliance

picture



picture



P-1098

Study of Informational Awareness of Patients before Elective Surgery

Audrone Fabijanskiene¹, Ernesta Statkuvienė², Simona Vainoriene², Ligita Siauryte Skipariene², Lina Jaruseviciene², Violeta Simatoniene³

¹Primary care center "Saulene", Joniskis

²Department of Family Medicine, Lithuanian University of Health Sciences

³Department of Physics, Mathematics and Biophysics, Lithuanian University of Health Sciences

Patient informing before elective surgery strengthens patients motivation to take an active role in treatment process, increases his satisfaction with health care services and enhanced readiness of people, who belong to patient's social environment to help actively the patient during recovery time.

The objective of the study - to explore patients' informational awareness about elective surgery procedure and to identify factors related to better patients' preoperative awareness.

Methodology. The survey of patients' hospitalized to the Hospital of Lithuanian University of Health Sciences and Siauliai Republican Hospital. The study participants: 191 patients from the surgical units, 189 - from the ophthalmology units, 199 – from orthopedics and traumatology units. The instrument: 102-item questionnaire that consisted from sociodemographic questions, questions concerning the patients' anxiety before elective surgery, patients' informational awareness and their expectations for preoperative counseling.

Results. 37.5% of men and 62.5% of women participated in this cross-sectional survey. The highest informational awareness (more than 80% of patients) was found on the issues related to the admission to the hospital and current health status. More than 50% of patients were aware of the aspects related to the future surgery. Less than 50% of study participants knew about the potential consequences of the surgery and the possibilities for social assistance. Younger age, male gender, lacks of previous experience of hospitalisation and surgeries, the preoperative community nurse counselling was related to better informational awareness of the patients.

Conclusion. Aiming to improve informational awareness of patients before elective surgery special attention should be paid to the involvement of community nurses in this process, issues related to the potential consequences of the surgery, wound care options, social assistance opportunities should also be included in the agenda of preoperative counseling.

Keywords: elective surgery, preoperative patient counseling, community nurse

P-1099

That we attend to complications of diabetes in service of urgencies?

Juan Carlos Montalva Barra, Pedro Garcia Bermejo, M Teresa Magdalena Carreres, Luis Manclús Montoya, Oscar Martinez Ferris, M Teresa Benavent

Hospital de la Ribera-Alzira

The prevalence of complications dress in service of urgencies it is very variable.

We Realize a descriptively observational study, retrospectively and transversely from patients seen by diabetic complication sharp During the year 2014, Obtaining information from system SIAS and analyzes estadístico by Means of SPSS version 22.0 urgencies Attended Of 191 patients in 12 HAD more of 1 complication. 51.83 % of men with middle ages women 61.57 years and 39.79 % rest hyperglycemia was not cetósics, hypoglycemias 23.03 % (10 % serious Considered), 10.47 % and 4.72 % metabolic ketoacidosis of diabetic début

Addition There Were Studied in the co - morbidity Associated With sharp pictures separating macro - vascular disease (coronary, cerebrovascular or peripheral artery) and microvascular (retinopathy, nephropathy or neuropathy). Were Observed 28.79 % of macrovascular disease and 13.61 % Been Diagnosed of some microvascular alteration. 53.92 % of patients was hypertense acquaintances and in 29.31 % dislipemics needed treatment after adjustment of urgency 50.78 % c of the patients of Whom Were 35 5 Adjustments of insulin destination of the valued patients was: 40.83 % domiciliary discharge, 20.41 % I join short unit stay or medicine he hospitalizes and only 7.32 % needed reference to external consultation of endocrinology

Conclusion

The discharge prevalence of Complications for diabetic decompensation in our hospital Supposes 3.8 % of the hospitable income. The Control of Complications and comorbidities can improve increase in the short and the long term monitoring of the above Mentioned Complications and improve increase naturally the history of the diabetes of our patients.

Keywords: complications diabetes prevalence

comorbidity

Hypertension Dislipemic Complication(Macr and microvascular

53.92% 29.31% 42.4%

destination patients

domiciliary hospitalization Endocrinology consultation Adjust treatment

40.83% 20.41% 7.32% 50.78%

P-1100

Respiratory Function Assessment in Cork Industry Workers and its Relationship with the Spirometry Standard compatible with Suberosis

Pedro Ribeiro Oliveira¹, Patrícia Cunha¹, Diana Brigas¹, Rosa Neves¹, Ricardo Oliveira²

¹USF Fiães, ACeS Feira/Arouca, Fiães, Portugal

²USF Escariz, ACeS Feira/Arouca, Escariz, Portugal

Suberosis is a pulmonary interstice disease caused by a repeated exposure to cork dust and mold. It is the most prevalent pulmonary interstice disease in the north of Portugal where cork industry is placed. The studies of the pulmonary function in suberosis patients usually reveal a restrictive pattern.

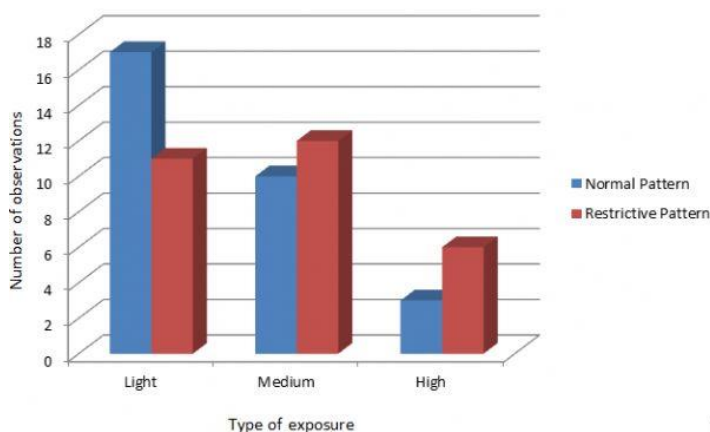
The main objectives of this study are to verify and quantify if time and type of exposure to cork dust and mold increase the risk of developing a restrictive spirometric pattern (compatible with suberosis). The type of exposure (severity) was defined from the job/working place of each worker.

For this purpose, a sample of 59 workers exposed to cork's dust and mold and a control group of 61 subjects not exposed have been selected. Spirometric tests have been performed in both groups.

The results show that the time and type of exposure to cork dust and mold are risk factors for the development of a restrictive pattern in exposed individuals. A light exposure leads to a risk of developing a restrictive pattern five times higher than the unexposed; a moderate exposure increases the risk nine times and severe exposure increases the risk fifteen times. For short-term exposure (less than 15 years) statistically significant results have not been obtained. The medium-term exposure (between 15 and 30 years) leads to a relative risk of developing a restrictive spirometric pattern nine times higher when compared with the control group, while the long-term exposure increases the same risk eleven times.

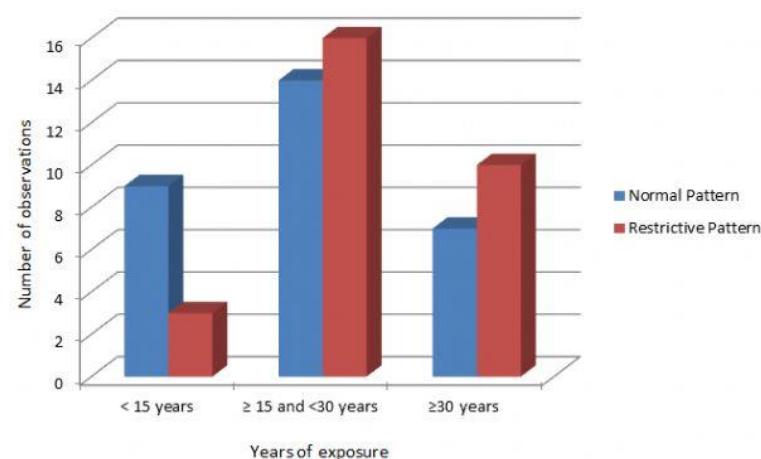
Keywords: Cork, Dust, Spirometry, Risk

Type of exposure



This figure shows the relationship between the Type of Exposure and the Spirometric Pattern

Years of Exposure



This figure shows the relationship between the years of exposure and the spirometric pattern

Table: Type of exposure/ spirometric pattern

	Type of Exposure				Total
	Light	Medium	High	Non-exposed	
Restrictive Pattern	11 (39.3%)	12 (54.5%)	6 (66.7%)	7 (11.5%)	36 (30%)
Normal Pattern	17 (60.7%)	10 (45.5%)	3 (33.3%)	54 (88.5%)	84 (70%)
Total	28 (100%)	22 (100%)	9 (100%)	61 (100%)	120 (100%)

$p = 0,000 < 0,05$

Table: Years of exposure/ spirometric pattern

	Exposure Time				Total
	<15 Years	≥15 and <30	≥30 Years	Non-exposed	
Restrictive Pattern	3 (25%)	16 (53.3%)	10 (58.8%)	7 (11.5%)	36 (30%)
Normal Pattern	9 (75%)	14 (46.7%)	7 (41.2%)	54 (88.5%)	84 (70%)
Total	12 (100%)	30 (100%)	17 (100%)	61 (100%)	120 (100%)

$p = 0,000 < 0,05$

P-1101

Determination of birth planning methods used by women in province Samsun 15-49 age

Mahcube Çubukcu¹, Nur Şimşek Yurt¹, Hakan Alan², Feyza Nur Topçu Yenerçağ¹, Mustafa Altuntop³, Emin Öz⁴, İsa Sezek⁵, Sevil Kocaman⁶, Emrullah Yılmaz⁷, Hüseyin Güler⁸, Tayfun Barış Kocaman⁹

¹Department of Family Medicine, Samsun Education and Research Hospital, Samsun, Turkey

²Terme Kozluk Primary Health Care Centers

³Çarşamba Sungurlu Primary Health Care Centers

⁴Canik Başalan Primary Health Care Centers

⁵İlkadım Yeşilkent Primary Health Care Centers

⁶Vezirköprü Kılıçgüney Primary Health Care Centers

⁷Vezirköprü Bahçekonak Primary Health Care Centers

⁸Ladik Merkez Primary Health Care Centers

⁹Vezirköprü Cumhuriyet Primary Health Care Centers

AIM

This study has been done for determining of the rates and preferences on birth planning method which applied by womens in the 15-49 age range who are living in Samsun.

MATERIAL and METHOD

Between 01.01.2014 and 31.12.2014, Samsun province was carried out by Primary Health Care Centers 8th, in the 15-49 age range registered in 4221 made woman screening method using the data file saved in the talks. All admitted patients aged 15-49 years were included in the study. Data were analyzed as retrospectively.

RESULTS

2879 (68.3%) women in 4221 are using family planning methods, the 1342's of (31.7%) are not using any method. 1851 of using family planning methods (64.3%), modern methods in 1028 (35.7%) are using traditional methods. The modern method 719 (17.0%) tüp ligation, 560 (13.2%) have a condom, 373 (8.8%) IUDs, 166 (3.9%) of the pill, 33 (0.78%) use injection method. Most of the women using traditional methods, withdrawal method 995 (23.5%) were used. The reasons for women not using contraceptive method; 414 (30.8%) don't want to use the method, 274 (20.4%) of them women want to stay, 267 (19.8%) were continuing the pregnancy, 185 (13.7%) have been identified as menopause, 158 (11.7%) is breast feeding, 44 (3.2%) of infertility.

CONCLUSIONS

Depending on family planning services are important in this regard to the needs of society in primary care services. In this study, the proportion of women using family planning methods is consistent with Turkey in general. (the rate of using modern methods 47.4%, the rate of using traditional methods 26%). To use family planning methods were close to the average rate in Turkey (26.5%). These results based on effective methods of training programs to increase the rate, to be extended to include anyone who needs and should also be permanent.

Keywords: family planning, contraception, pregnancy

P-1102

Anxiety and depression influences in therapeutic failure

Enrique Almenar Cubells, Laura Ruiz Pérez, Enriqueta Hernandez Hernandez, Alfredo Quiles Raga, Diana Diaz Gil, Oscar Perez Quintana, Jose Vicente Alcaide Domingo
Centro de Salud de Benifaio, Valencia, Spain

The object:

The study aims to answer the following questions:

- Knowing the current therapeutic failure in a medical quota.
- Find out if anxiety or depression (undiagnosed) influence compliance.

MATERIAL-METHODS:

Cross-sectional study on 217 patients treated at the Health Center Benifaio (Valencia) in the consultation of the family doctor with the diagnosis / ICD-9-401 Essential hypertension in both sexes, aged 18-95 years.

It was excluded from the study patients with secondary hypertension, which had severe chronic or acute illnesses, who had a diagnosis of mental illness, as well as patients with contraindications to antihypertensive treatment and pregnant or lactating.

Each patient the following validated tests were conducted: Test Morisky-Green Levine to assess the therapeutic failure. Abbreviated Scale Goldberg anxiety and depression to assess anxiety and depression and collected the following measures blood pressure, weight, height and waist circumference

RESULTS:

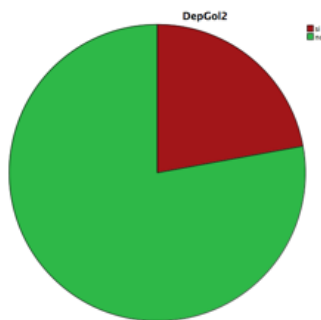
The average age of participants was 70.83 years and standard deviation of 11,107. 53.5% women and 46 men, %%; Obesity showed 46.1%, 44.7% overweight and 20% normoweight. The therapeutic failure stood at 37.3% and was significantly correlated with anxiety, present in 16.1% of patients. Depression was found in 22.1% and was not significant

CONCLUSIONS:

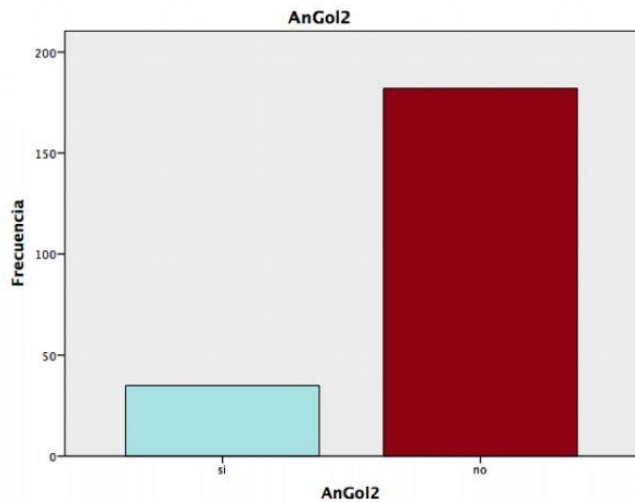
The prevalence of failure remains high, consistent with other studies. New measures to improve the therapeutic effect to be applied in the doctor's family doctor will be needed, as early diagnosis of mood disorder and anxiety that influence it.

Keywords: Test Morisky-Green Levine, Scale Goldberg, Essential hypertension, anxiety, depression

depression



anxiety



P-1103

Is Vitamin D Important Player In Hepatosteatosi In Childhood Obesity ?

Elif Özsü¹, Derya Tepe¹, Feyza Nur Topçu Yenerçağ²

¹Department of Pediatric Endocrinology, Samsun Obstetrics And Pediatrics Hospital, Samsun, Turkey

²Department of Family Medicine, Samsun Education And Research Hospital, Samsun, Turkey

BACKGROUND AND AIM:

Childhood obesity is one of the most serious public health problem. Obesity-related complications such as hepatic steatosis or type 2 diabetes can now be monitored even during early childhood. The aim of the study was to examine the relationship between vitamin D levels and obesity with hepatosteatosi in children.

METHODS:

A total of 128 children with obesity were included in this study. Hepatosteatosi (HS) was diagnosed using ultrasonography. Hepatosteatosi was graded. 25 hydroxyvitamin D, calcium, phosphate, alkaline phosphatase, parathormone, serum lipid level, glucose and insulin level were measured. Data were analyzed using 2 categories; obesity with HS and obesity without HS.

RESULTS:

A total of 128 children were studied. In our study group 42 % was male and the mean age 12,1±3,1 (range 4-18 years) Hepatosteatosi was identified in 39% (n: 50). There was a high prevalence (122/128 95%) of vitamin D deficiency or insufficiency; however, there were no significant associations between vitamin D level and HS. Uric acid, ALT, triglyceride level were significantly different in two groups.

CONCLUSIONS:

There is a high prevalence of vitamin D deficiency and insufficiency in children with HS, however, no association was found between vitamin D deficiency and HS.

Keywords: Vitamin D, Hepatosteatosi, Obesity

P-1104

Prevalence of Dysfunctional Family among students of a public and private elementary schools in Manila using FAMILY APGAR tool: A Pilot Study

Cherrielyn Recana Quezada

Ospital ng Maynila Medical Center

Family as the basic unit of the society, in its simplest form is composed of the parents and their children. With the recent researches indicate that family interaction contributes to a range of developmental outcomes. Family function measures the extent to which a family works as a unit; therefore it provides a rich mixture of stimuli to the children that often affect both physical and psychological development. The bumpy transition from childhood to adolescence phase is one of the most outwardly dramatic times of development and change in a child’s life. In line with this, the research aims to determine the prevalence of dysfunctional families using a sample population of 471 children aged 9 to 13 years old in two selected schools in the city of Manila.

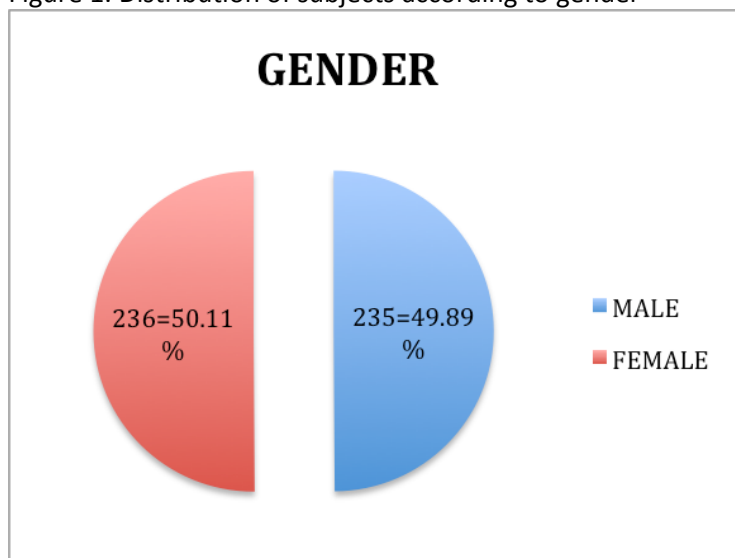
A descriptive cross sectional study was conducted using the Family APGAR questionnaire. For this purpose, A total of 471 subjects were included, 388 were from the chosen public school and 83 were from private school. Using the Family APGAR scoring, family’s ability to cope and adjust to different situations concentrating on five components: adaptation, partnership, growth, affection and resolve were noted.

The study showed that 351 or 75% were considered to have highly functional families, while 120 or 25% have dysfunctional families. Out of those with dysfunctional families, only 5 were considered to have severely dysfunctional families.

With the aim of understanding the factors that lead to effectiveness of family interactions, the researcher proved that the APGAR questionnaire is useful in examining the specific relationships that make up family life and the children’s perception of their respective families and family functioning is appreciated already by this age group. In addition, the result was able to describe the characteristics of study population in terms of their age, gender, religion and body mass for age.

Keywords: FAMILY APGAR, school setting, youth, assessment tools, evaluation, child development

Figure 1. Distribution of subjects according to gender



This graph showed that among 471 subjects, 236 (50.11%) were females and 235 (49.89%) were males.

Figure 2. Distribution of subjects according to age

Distribution of Subjects according to age

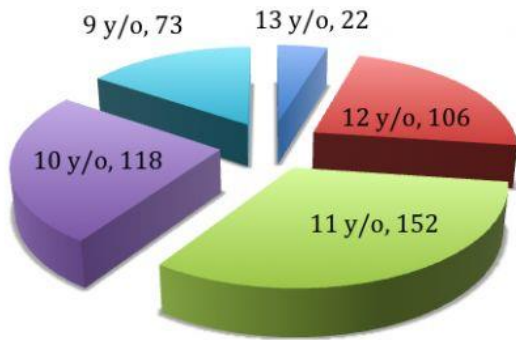


Figure 2 shows the age distribution of the subjects and their corresponding percentages. Among the 471 subjects, 73 (15%) were 9 years old, 118 (25%) were 10 years old, 152 (32%) were 11 years old, 106 (23%) were 12 years and 22 (5%) were 13 years old.

Figure 3. Distribution of Public and Private School Respondents

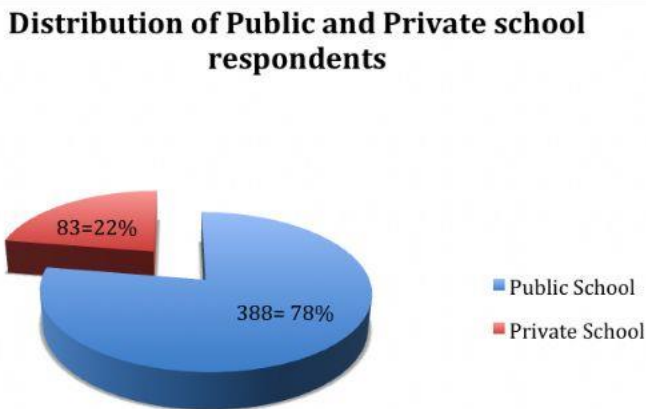
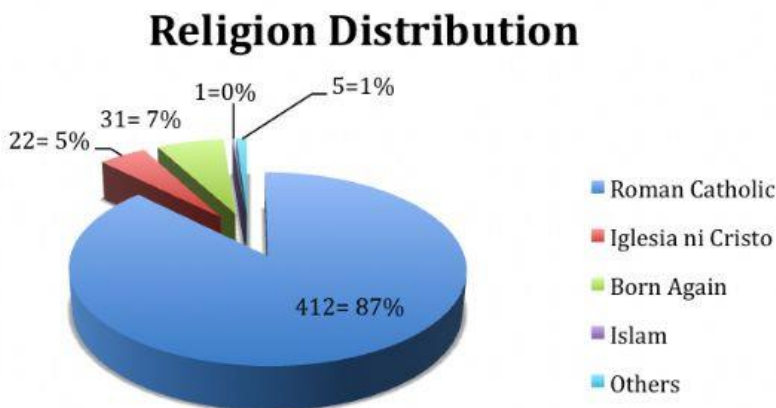


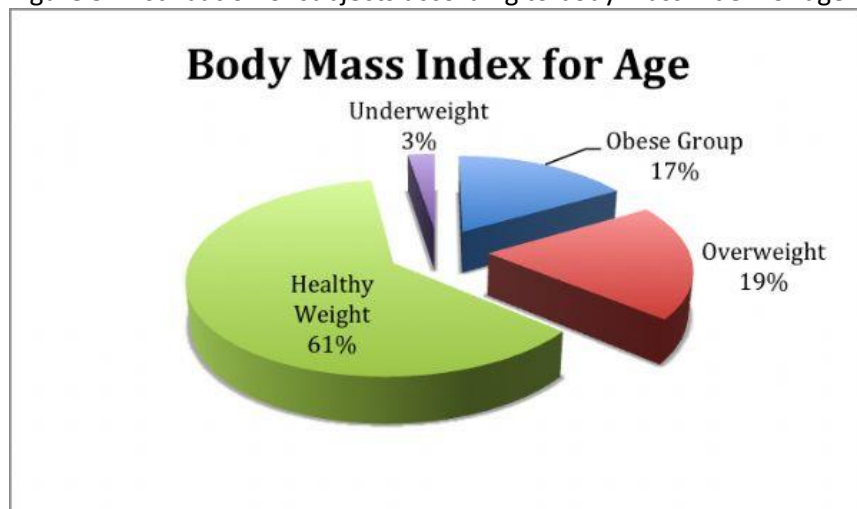
Figure 3. Distribution of Public and Private School Respondents Among the 471 subjects, 388 (78%) were from Fernando Ma. Guerrero Elementary School (public school) and 83 (22%) were from St. Pius Parochial School (private school). Equal distribution of the students from the private and public school was not met deemed necessary by the researcher as this study only aims to characterize and not compare between the private and public school subjects.

Figure 4. Distribution of subjects according to their respective religion



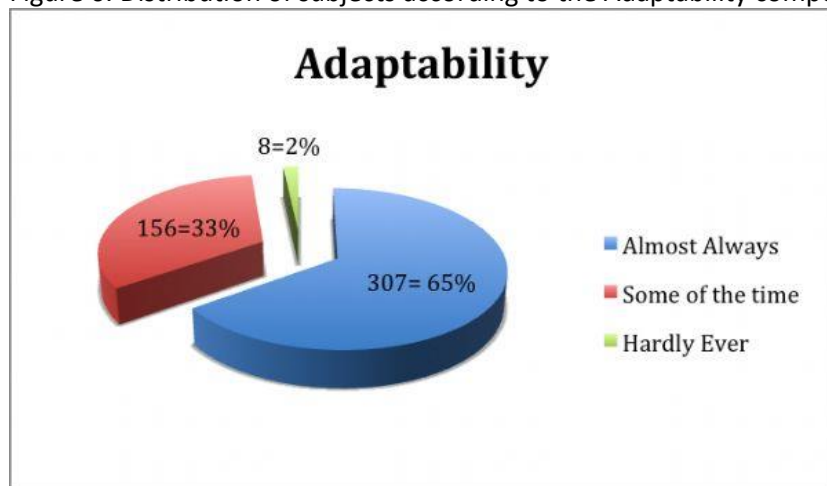
Majority of the subjects were Roman Catholics, followed by Born Again Christians. Interestingly, although the private school chosen is a Catholic School, students belonging to other religious sectors were also noted

Figure 5. Distribution of subjects according to body mass index for age



Majority of the subjects 289 (61%) were classified as healthy (healthy weight). 92 (19%) students were identified as overweight, 78 (17%) were obese and 12 (3%) were underweight. All subjects were classified using the Body Mass for Age (Fig. 5).

Figure 6. Distribution of subjects according to the Adaptability component of Family APGAR



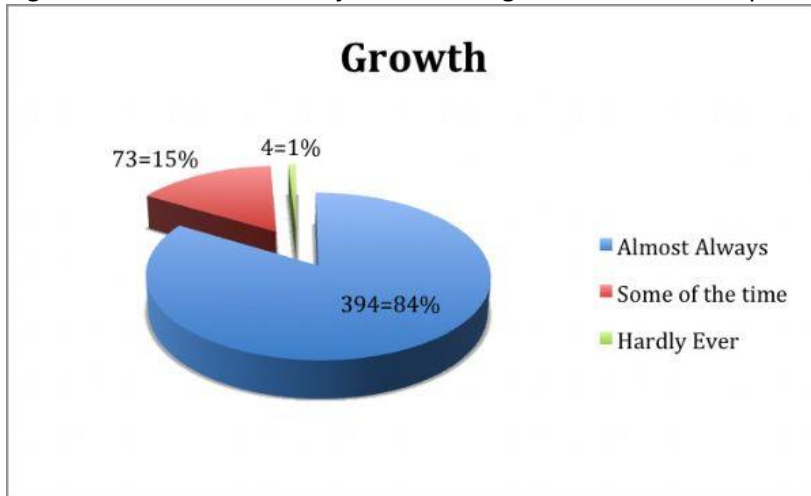
Among 471 subjects, 307 (65%) answered Almost Always when asked how satisfied they are for the support their family is giving them when something is troubling them. 156 (33%) answered some of the time and only 8 (2%) said they are hardly ever satisfied (Fig. 6).

Figure 7. Distribution of subjects according to the Partnership component of Family APGAR.



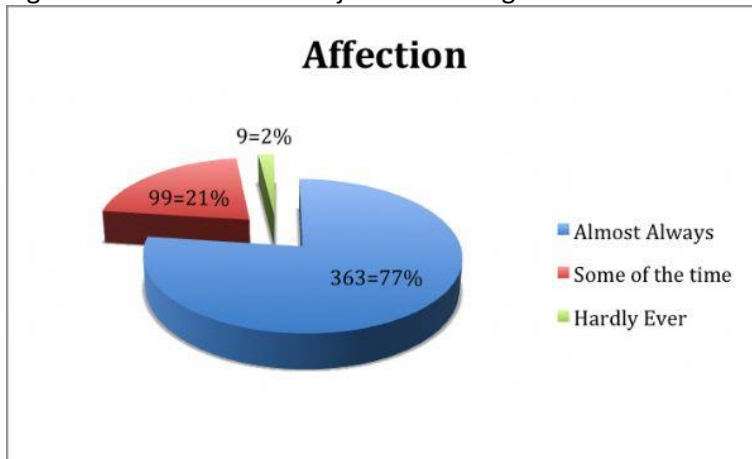
Among the 471 subjects 274 (58%) said that they are satisfied with the way their family discusses issues with them and helps in finding solutions for certain problems encountered. 177 (38%) answered that they are satisfied sometimes, while 20 (4%) said that they are hardly ever satisfied (Fig. 7)

Figure 8. Distribution of subjects according to the Growth component of Family APGAR



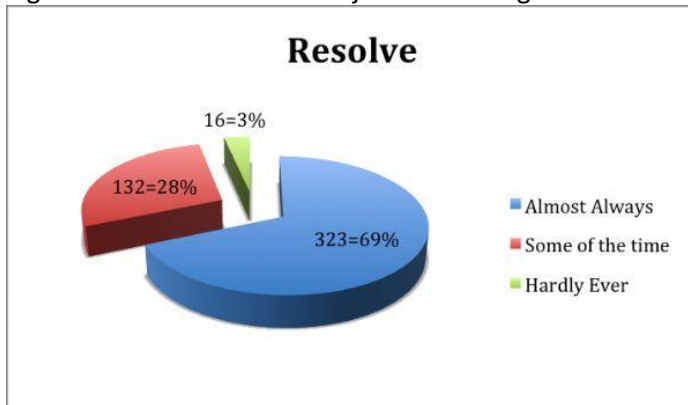
Majority of the subjects, 394 (84%) were satisfied as to how their family accepts and supports their wishes. 73 (15%) said they were sometimes satisfied and 4 (1%) answered hardly ever (Fig. 8).

Figure 9. Distribution of subjects according to the Affection component of Family APGAR



Among the 471 subjects 363 (77%) said that they are satisfied with the way their family expresses affection and responds to emotion such as anger, sorrow and love. Meanwhile, 99 (21%) are sometimes satisfied and 9 (2%) answered they are hardly ever satisfied on this parameter (Fig. 9).

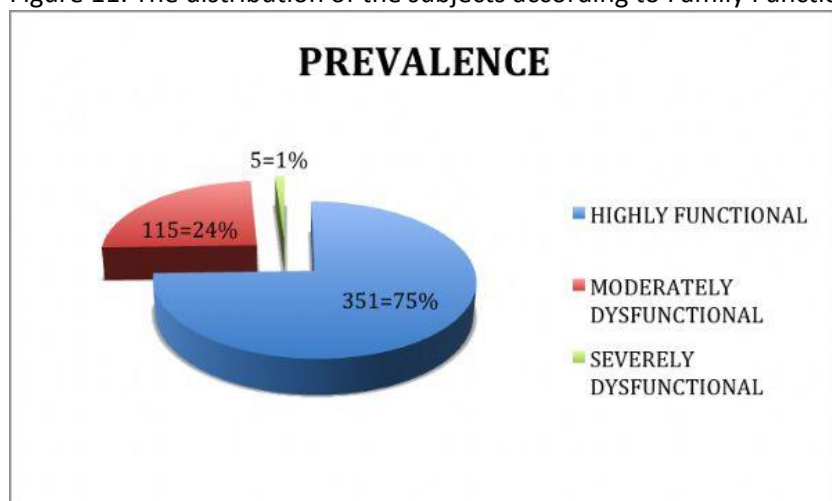
Figure 10. Distribution of subjects according to the Resolve component of Family APGAR



In addition, 323 (69%) of the 471 subjects were satisfied on how their family spend and spends their time together. 132 (28%) answered that they are sometimes satisfied and 16 (3%) answered that they are hardly ever

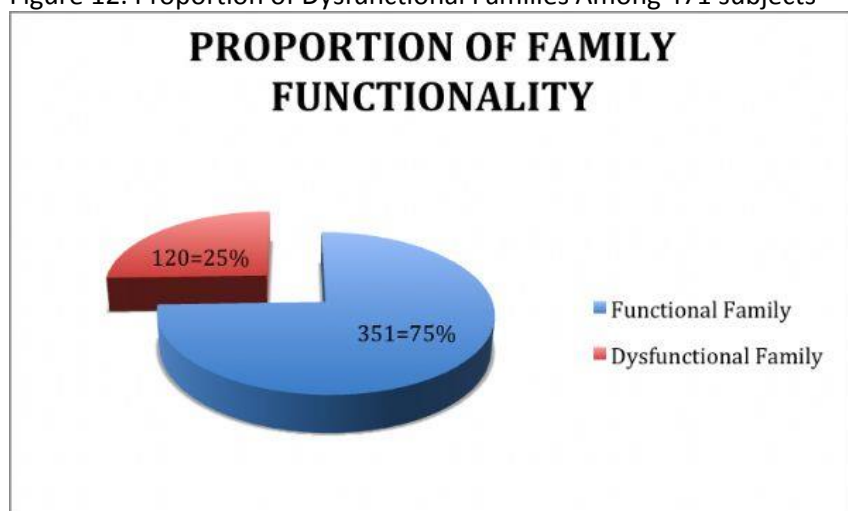
satisfied with this component (Fig. 10).

Figure 11. The distribution of the subjects according to Family Functioning.



Majority, 351 (75%) were classified to have highly functional families and are deemed to be satisfied with their respective family dynamics. Only five (1%) among the 471 subjects were classified to have severely dysfunctional families. Meanwhile, 115 (24%) were moderately found to have moderately dysfunctional families.

Figure 12. Proportion of Dysfunctional Families Among 471 subjects



For the purposes of this study, those with moderately dysfunctional and severely dysfunctional families will be lumped into simply dysfunctional family As children enter early adolescence, they begin spending more unsupervised time with friends and other peers (Brown, 1990; Larson & Richards, 1991). In fact, time spent with peers during early adolescence can often eclipse time spent with parents and other family members (Csikszentmihalyi & Larson, 1984). Early adolescents also become more concerned about peer acceptance and begin to turn to their friends more often as sources of advice and comfort (Gould & Mazzeo, 1982). In some ways, it appears that children's increased orientation toward peers during early adolescence is at the expense of their closeness to their parents. Steinberg and Silverberg (1986) found that whereas the percentage of peer-oriented children increased from late childhood to early adolescence, the percentage of adult-oriented children decreased. They speculated that during this period, children "trade" a dependency on parents for a dependency on peers. In fact, a converging body of research has supported that children disengage and distance themselves somewhat from their parents during early adolescence.

Table 1. Distribution of male and female subjects according BMI for Age Classification

Classification	MALE	FEMALE	Total
OBESE	47	31	78
OVERWEIGHT	41	51	92
HEALTHY WEIGHT	140	149	289
UNDERWEIGHT	7	5	12
Total	235	236	471

When compared, it was found that more males were found to be obese. But more females were found to be overweight and within the healthy weight category (Table 1)

Table 2. Distribution of the subjects according to age and Family APGAR classification

AGE	% Frequency	Highly Functional	Moderately Dysfunctional	Severely Dysfunctional	Total
9	15%	56	17	0	73
10	25%	99	19	0	118
11	32%	119	33	0	152
12	23%	66	36	4	106
13	5%	11	10	1	22
Total	100%	351	115	5	471

This table shows that subjects who were classified as part of "severely dysfunctional" families were from ages 12 and 13. Also half of the 13 years old subjects classified their respective families as dysfunctional. Meanwhile, majority of lower age group still classified their family as highly functional.

P-1105

Relationship Between Red Cell Distribution Width and Mean Platelet Volume with Asthma

Lutfullah Cakır¹, Gulali Aktas², Ozgur Enginyurt¹, Recep Akgedik³

¹Department of Family Medicine, Ordu University Faculty of Medicine, Ordu, Turkey

²Department of Internal Medicine, Abant Izzet Baysal University Faculty of Medicine, Bolu, Turkey

³Department of Chest Diseases, Ordu University Faculty of Medicine, Ordu, Turkey

BACKGROUND & AIM: Asthma is a disorder characterized with chronic inflammation of the airways. MPV and RDW are parts of routine hemogram test and they have been shown to be related with inflammation. We aimed to study relationship between these hemogram parameters with asthma in asthmatic patients and to compare with healthy subjects.

METHODS: 38 patients with asthma and 38 healthy volunteers enrolled into the study. Laboratory tests for patients with asthma were performed in stable period of the disease. Healthy volunteers had no known chronic or acute conditions.

RESULTS: Age, sex and basic laboratory tests were not significantly different between study groups. However, MPV was significantly decreased and RDW was significantly elevated in patients with asthma compared to control subjects. Table 1 shows general characteristics and laboratory data of the groups.

CONCLUSIONS: In conclusion, we think that RDW and MPV shall yield diagnostic value in asthma. However, further prospective studies with larger population are needed to confirm our results.

Keywords: RDW, MPV, Asthma

General characteristics and laboratory data of the the study and the control groups

	Study group	Control Group	P	
Gender	Women (n)	23	29	0.14
	Men (n)	15	9	
	Mean - SD			
Age (years)	39,24±12,75	44,05±11,9	0,09	
WBC (u/mm)	7,11±1,9	6,5±1,8	0,187	
Hb (gr/dL)	13,8±1,5	13,3±1,5	0,193	
RDW (%)	14,9±1,2	14,3±0,6	0,01	
PLT (u/mm3)	276±60	274±73	0,9	
MPV	7,9±1,1	8,8±1,4	0,002	
	Median (Min-Max)			
Neu	3,7 (1,5-12)	3,5 (1,1-7,2)	0,63	
Lymp	2,2 (1,3-4,8)	2,2 (1,3-3,9)	0,13	
Neu/lymp ratio	1,5 (0,6-6,8)	1,8 (0,6-3,7)	0,32	

P-1106

The Effects of Education about Osteoporosis on Knowledge and Attitude of the High School Students

Oğuz Yılmaz¹, Yılmaz Cankurtaran¹, Nuran Ozciftci¹, Ahmet Cekic¹, Selin Bulut², Vildan Mevsim²

¹Faculty of Medicine, Dokuz Eylul University, Izmir, Turkey

²Department of Family Medicine, Dokuz Eylul University, Izmir, Turkey

Background

Osteoporosis is closely related with paediatric years, which is the critical period for bone growth and development. The timing for attainment of peak bone mass is not yet known, however, it is thought to be near complete by the end of adolescence. Although 60-80% of the variability in peak bone mass is attributed to genetic variability, environmental factors such as nutrition and exercise are also thought to have an important role influencing peak bone mass and the later risk for osteoporosis. Considering the early age at which peak bone mass is attained, preventive measures for osteoporosis should begin in childhood. Education of adolescents will lead to better understanding of concept of "bone health".

Method

The research is an interventional study. The intervention was done in 102 first and second grade students of a high school. A survey consists of questions about knowledge, attitude and behaviour about osteoporosis was implemented. After that, an education was given on osteoporosis. After the education the survey was implemented again.

The student who attends the lecture is required to prepare a project based on osteoporosis in one month. There is no obligation on method selection. Preparing a project is going to effect the knowledge and attitudes about osteoporosis.

The analysis was done with the SPSS 15.0 software, the descriptive statistics and the T test for dependent groups was used.

RESULTS:

The 41.2% of the participants were female. The average age is 14.8±0,75. After the education the knowledge and attitude scores increased 38.2% (p=0,000) and 22,8(p=0,000) respectively. Projects prepared by students were awarded in four areas: music, banner, slogan and story.

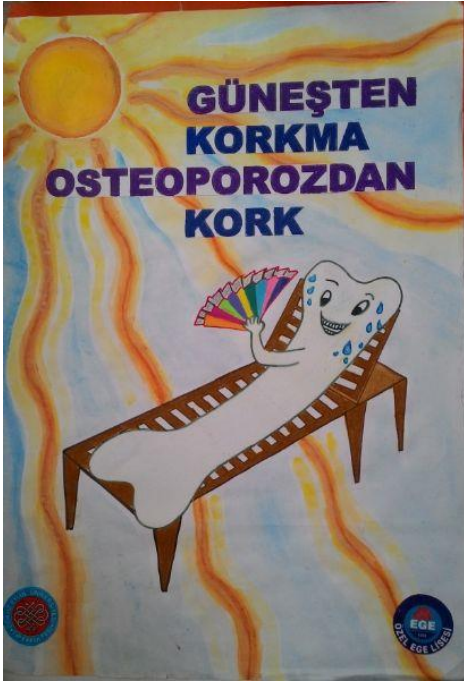
Conclutions

The study showed that the high school students' knowledge and attitude is insufficient and can be improved with

education.

Keywords: osteoporosis, adolescence, intervention study, peak bone mass

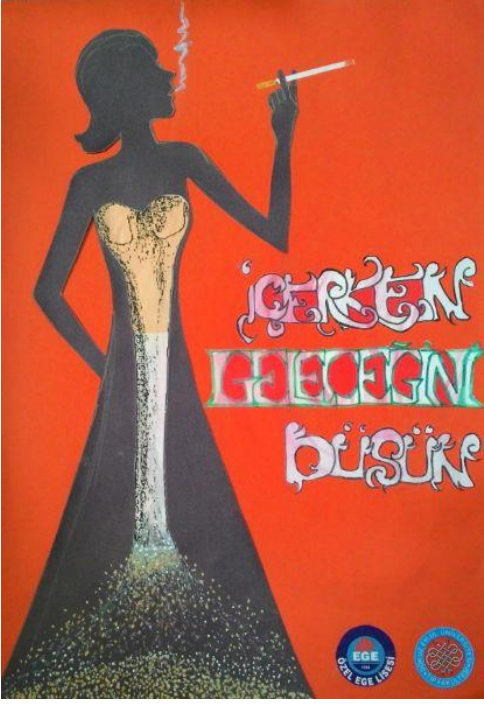
afis1



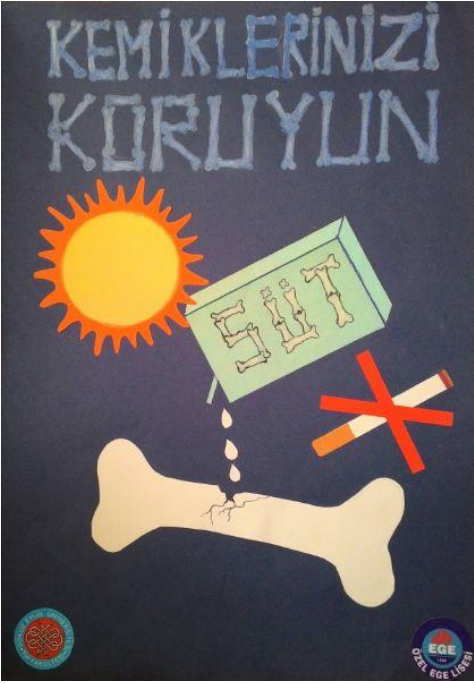
afis2



afis3



afis4



P-1107

Relationship Between Social Support And Anxiety Levels Among Ondokuz Mayıs University Medical Students

Feyza Parlak Kabakcioglu, Fusun Aysin Artiran Igde, Mustafa Fevzi Dikici

Department of Family Medicine, Ondokuz Mayıs University, Samsun, Turkey

OBJECTIVE: This descriptive study was planned to determine related factors with levels of social support and the anxiety.

METHOD: The study was conducted by the Department of Family Medicine of Ondokuz Mayıs University in Samsun between March 2 and May 15, 2015. Data were collected by using a questionnaire prepared by the researcher to determine the sociodemographic characteristics, Multidimensional Scale of Perceived Social Support (MSPSS) to determine student's social support levels and Beck Anxiety Inventory (BAI) for measuring student's anxiety levels. Data were analyzed using SPSS version 20 statistical software.

RESULTS: Among 340 participants 55,6% (n=189) was females, 44,4% (n=151) was males. The mean age of students was $20,87 \pm 2,52$ years. The mean score of the MSPSS for all students was $62,42 \pm 14,74$. For females it was $63,56 \pm 14,76$ and for males was $60,99 \pm 14,63$. Although the females' mean score of the MSPSS is slightly higher than males' mean score, this difference did not reach statistical significance ($t=1,63$, $p=0,11$). The mean score of the BAI for all students was $11,24 \pm 10,28$. For females it was $11,59 \pm 10,24$ and for males was $10,80 \pm 10,34$. There was no statistical difference between female and male students. ($t=0,7$ $p=0,48$). Based on the BAI cut off point, 178 (52,4%) students were suffering from anxiety and their mean score of the MSPSS was $60,07 \pm 15,62$. For students who has normal anxiety level on the BAI (n=162) the mean score of the MSPSS was $65,00 \pm 13,27$. Negative correlation is found between social support and anxiety level ($p=0,02$).

CONCLUSION: Mental health of university students is one of the important components of public health. Anxiety can adversely affect quality of life. Improving social support is required to help university students become as more healthy individuals.

Keywords: anxiety; social support; students, medical

P-1108

White Blood Cell Levels of Patients with COPD in Acute Exacerbation and Stable Periods

Mükremin Er¹, Samet Uludağ², Tuncer Kılıç², Furkan Dağcıoğlu², İrep Karataş²

¹Department of Pulmonology, Yıldırım Beyazıt University, Ankara, Turkey

²Department of Family Medicine, Yıldırım Beyazıt University, Ankara, Turkey

INTRODUCTION: Chronic Obstructive Pulmonary Disease (COPD) is a major cause of chronic morbidity and mortality throughout the world. Chronic airflow limitation caused by small airway disease and parenchymal destruction is characteristic for COPD. White blood cell (WBC) count is a marker of inflammation. The aim of this study is comparing white blood cell counts in stable and exacerbation periods of COPD.

METHODS: 35 patients (25 male, 10 female) with exacerbation of chronic obstructive pulmonary disease admitted to Atatürk Training and Research Hospital in the last 5 years were included to the study and WBC values on admission and discharge were evaluated of patients who were hospitalized for at least 7 days. The results were evaluated with a 95% confidence interval, and a P value < 0.05 was considered significant.

RESULTS: The mean age of the patients was 68.09 ± 9.84 , mean duration of hospitalization was found to be $11,8 \pm 3,8$. Average WBC value in acute exacerbations is 9455 ± 3518 , 9119 ± 3260 for stable period; whereas the difference wasn't statistically significant ($p=0,3$)

DISCUSSION: COPD is a common disease that family physicians encounter frequently. Our results reveals no correlation between WBC count and exacerbation of COPD in contrast with the stable period. Although COPD is an inflammatory disease, WBC levels don't increase as expected. So WBC count is not supposed to be a marker for acute exacerbation of COPD.

Keywords: WBC, COPD, Exacerbation, Stable

P-1109

Adherence to cardiovascular risk factors correction in patients with subclinical hypothyroidism

Victoria I Tkachenko, Christine M Kuharchuk

Shupyk National Medical Academy of Postgraduate Education

Background. Subclinical hypothyroidism (SG) is accompanied by increased levels of cholesterol dislipidemia and hypertension. A number of studies demonstrated that normalization of TSH during L-thyroxine therapy not always lead to removal of this dysfunction and need additional cardiovascular risk correction.

The aim of study: to analyze the adherence to cardiovascular risk factors correction in patients with subclinical hypothyroidism.

METHODS: 51 patients with SG were examined (45 women and 6 men, age $44,65 \pm 8,96$ years), average length of SG $6,09 \pm 4,68$ years. Blood pressure (BP) control, clinical and laboratory examination (blood chemistry, lipidogramme), retrospective analysis of outpatient cards, survey about cardiovascular risk factors and adherence to the prevention were conducted. Statistical analysis was performed by using Excel 2007.

Results. The 58.8% patients with SG (TSH $5,18 \pm 2,75$ when $N=0,17-4,05$) and average levothyroxine dose $112,5 \pm 32,7$ mg per day had dyslipidemia, the average level of cholesterol was $5,72 \pm 2,06$ mmol/l. Among the patients with dislipidemia, only 30% (9 people) took prescribed lipid-lowering therapy. The significant correlation was noted between TSH levels and total cholesterol values ($p < 0,05$). In addition, 52.9% (27 people) patients also had another cardiovascular risk factor – hypertension during $8,06 \pm 5,34$ years, but despite of antihypertensive therapy use, the blood pressure target 140/90 mmHg were reached only in 62,96% of patients (systolic BP was $140 \pm 19,21$ mmHg and diastolic BP= $88,81 \pm 11,07$ mm Hg), 66,67% of patients assigned they independently change the dose of the drugs, 25.92% of patients noted that often pass reception, 29.63% of patients rare missed antihypertensive drug, 3.7% of patients ignore it.

CONCLUSION: Patients with subclinical hypothyroidism have high cardiovascular risk despite Thyroxin therapy and low adherence to antihypertensive and lipid-lowering treatment. General practitioners should pay more attention to prevention of cardiovascular disease in patients with subclinical hypothyroidism and also check TSH level in patients in patients with dislipidemia.

Keywords: adherence, cardiovascular risk factors, subclinical hypothyroidism

P-1110

Mechanisms of dyslipidemia progression in patients with coronary heart disease and intestinal dysbiosis

Victoria I Tkachenko, Olga S Busygina

Shupyk National Medical Academy of Postgraduate Education

Background. The coronary heart disease (CHD) is the main clinical form of arteriosclerosis and is characterized by lipid metabolism disorders. Concomitant intestinal dysbiosis in patients with CHD is accompanied by modifications of lipid metabolism and progression of dyslipidemia. The mechanisms of lipid metabolism in these patients need to be studied.

The aim of the study was to examine the factors contributing to the progression of the blood lipid spectrum in patients with CHD and intestinal dysbiosis.

Methods. The study involved 106 patients with CHD and intestinal dysbiosis of 1-3 stage, age 50-65 years (63 men and 43 women) with body mass index (BMI) of 25-39.9 kg/m². The study excluded patients with inflammatory diseases, systemic diseases, diabetes, cancer. The blood levels of total cholesterol (TC), low density lipoprotein cholesterol (LDLP), triglycerides (TG), blood levels of insulin and factors of systemic inflammatory response - C-reactive protein (CRP), interleukin 6 (IL-6), fibrinogen were studied. Statistic – with Excel 2007.

Results. The levels of atherogenic lipoprotein fractions – LDLP cholesterol and TG - significantly correlated with BMI, blood levels of insulin, CRP and fibrinogen ($p < 0,05$). Levels of LDLP cholesterol correlated with BMI ($r=0,57$; $p < 0,05$), insulin level ($r=0,55$; $p < 0,05$), CRP ($r=0,61$; $p < 0,05$), fibrinogen ($r=0,60$; $p < 0,05$). TG levels correlated with BMI ($r=0,63$; $p < 0,05$), with insulin ($r=0,59$; $p < 0,05$), CRP ($r=0,49$; $p < 0,05$), fibrinogen ($r=0,44$; $p < 0,05$). Patients with more severe degrees of intestinal dysbiosis had more pronounced blood lipid disorders. Levels of LDLP and TG significantly correlated with the degree of intestinal dysbiosis - respectively ($r=0,48$; $p < 0,05$; $r=0,39$; $p < 0,05$).

Conclusions. The weight gain, hyperinsulinemia, factors of systemic inflammatory response took participation in

the mechanisms of the dyslipidemia progression in patients with coronary heart disease and intestinal dysbiosis. Increased intestinal dysbiosis is associated with a progressive disorder of blood lipid spectrum and has to be taken into account.

Keywords: coronary heart disease, dyslipidemia, intestinal dysbiosis

P-1111

Influenza vaccination and influencing factors among health care professionals

Süheyl Asma¹, Hülya Akan², Yücel Uysal³, Ahmet Gürhan Poçan¹, Mustafa Haki Sucaklı⁴, Erhan Yengil⁵, Çiğdem Gereklioğlu¹, Aslı Korur¹, İbrahim Başhan³, Ahmet Ferit Erdoğan¹, Akatlı Kürşat Özşahin¹, Altuğ Kut¹

¹Başkent Üniversitesi

²Yeditepe Üniversitesi

³Mersin Üniversitesi

⁴Kahramanmaraş Sütçü İmam Üniversitesi

⁵Mustafa Kemal Üniversitesi

BACKGROUND: We aimed to investigate the attitudes toward vaccination and influencing factors among health care professionals.

MATERIAL-METHODS: This is a cross-sectional multi-center study. The study universe was composed of 1220 doctors and 1650 nurses. The questionnaire which was sent to the participants through e-mail included the questions about demographic characteristics, sources of knowledge about influenza and likert type questions about the factors influencing vaccination. Data were analysed with SPSS 22.0.

RESULTS: 187 doctors and 455 nurses participated in the study. Of the participants, 72% stated that they had high risk for influenza however 9% reported vaccination every year, 14% had the vaccine this year. Vaccination ratio was higher among males ($p < 0.05$). Vaccination rate increased as working years increased. Risk perception was significantly higher among the vaccinated subjects. A statistically significant difference was not detected between groups with regard to believing alternative medicine. The subjects who did not have vaccination think that natural methods are better than vaccination. Beliefs were seen not to affect vaccination. The motivating factors were found as the recommendations of Ministry of Health, having knowledge and free availability of the vaccine.

CONCLUSION: Ratio of vaccination against influenza is low. It was concluded that even health care professionals need information about regular vaccination at their own institutions and potential side effects.

Keywords: influenza, vaccination, health care

P-1112

"Awareness Of Patients Who Plan To Use Corticosteroids For A Long Term About Osteoporosis"

Evrım Kardelen Dizdar¹, Ediz Yıldırım¹, Hüseyin Can², Zeynep Ay², Mustafa Gökhan Dizdar³, Azize Dilek Güldal¹

¹Department of Family Medicine, Dokuz Eylül University Faculty of Medicine, İzmir

²Department of Family Medicine, Katip Çelebi University Faculty of Medicine, İzmir

³Department of Forensic Medicine, Manisa Directorate of Forensic Medicine Institute, Manisa

"INTRODUCTION:

Osteoporosis is an important health issue. Cortisone increases risk of osteoporosis. To prevent osteoporosis, precautions such as exercise or calcium support should be considered, especially with long term use. The objective of our study is to determine the risk awareness of patients who plan to use corticosteroids for a long time and factors related with.

METHOD:

Cross-sectional study was done with patients followed in two university hospital outpatient clinics and planned to use long term corticosteroids. A survey which includes demographic features, and life style questions and the Osteoporosis Health Belief Scale (OHSB) is applied. Descriptive statistics and hypothesis tests were done by using SPSS 15.0 program.

RESULTS:

The mean age was 49.97 and the 77.3% of the participants were women. 40.1% were high school or above graduates. Women in whom bone density measurement made more frequently ($p=0.000$), are diagnosed with more osteoporosis ($p=0.006$). The number of people who knew that cortisone increases osteoporosis were higher at the ones who had higher income ($p=0.036$). 45.3% of the patients did not consume calcium, 60.5% did not use D vitamins, 65.1% did not drink milk, 43% never had any exercises and 28.5% never went out for the sun. 45.9% of them were never informed about the side effects of cortisone by any health officer. Sense of OHSB awareness was higher at women ($p=0.001$) and similarly it was also higher at participants in whom bone density measurement were made ($p=0.012$). The total points of the ones who had lower educational status were higher. There was a significant relationship between the OHSB total points and the duration of corticosteroid usage ($r=0.283$, $P=0.000$).

CONCLUSION:

In our study, it was observed that patients who begin to use corticosteroids are not informed of osteoporosis adequately and do not take required precautions."

Keywords: Osteoporosis, glucocorticoids, risk factors

P-1113

Knowledge and Attitudes of Pregnant Women and Their Postpartum Behaviors about Breastfeeding

Burcu Aslan, Mehtap Kartal

Department of Family Medicine, Dokuz Eylul University, Izmir, Turkey

In Turkey, although nursing rates are high, the rate of exclusive breastfeeding (EBF) in the first six months is low. Our aim was to determine the knowledge and attitude of mothers about nursing and their behaviors about exclusive breastfeeding in the first six months.

This study has a cross-sectional analytic design where initially 789 pregnant women at third trimester applied to the Pregnant Outpatient Clinics of Medical Faculties of Dokuz Eylul and Izmir Katip Celebi Universities, between 01.04.2014-31.05.2014 were included. All were asked for sociodemographic characteristics, knowledge about breastfeed and nursing, postpartum breastfeeding plans. In the second phase, all women were called when babies reached six months of age and 610 mothers completed the questionnaire related to birth, status of breastfeeding.

Their mean age was 28.80±5.763 (Range:16-44) years. All of pregnant wanted to breastfeed, 78.3% planned to complete EBF and 51.7% planned to nurse for first 19-24 months. After birth, 61.6% of the mothers, who were still breastfeeding, indicated that they will continue to breastfeed for 19-24 months. EBF ratios of babies for the first and sixth month were 51.1% and 16.1%, respectively. Mother’s history about breastfeeding had a positive impact on EBF plans during pregnancy and EBF behaviors at sixth month. Mothers, who nursed their previous babies less than 12 months, were planning to nurse their current babies for a shorter time than the mothers who nursed more than 12 months. When all the mothers included, it is found that nursing plan in the pregnancy period had a positive impact on plans and behaviors about maintaining breastfeeding in postpartum period. Positive breastfeeding experience of the women in their first pregnancy affects their nursing behavior for next babies. It’s an important clue for daily practice of family physicians’ breastfeeding consultancy to increase EBF ratios for future healthy generations.

Keywords: Knowledge Attitude Pregnant Postpartum Breastfeeding

The association between mothers' plans for EBF on delivery during pregnancy and previous EBF duration

Previous EBF duration (n=448)	EBF plan on delivery during pregnancy				p value
	Less than 6 months		6 months and over		
	n	%*	n	%*	
Less than 6 months	38	24.5	117	75.5	<0.001
6 months and over	16	5.5	277	94.5	

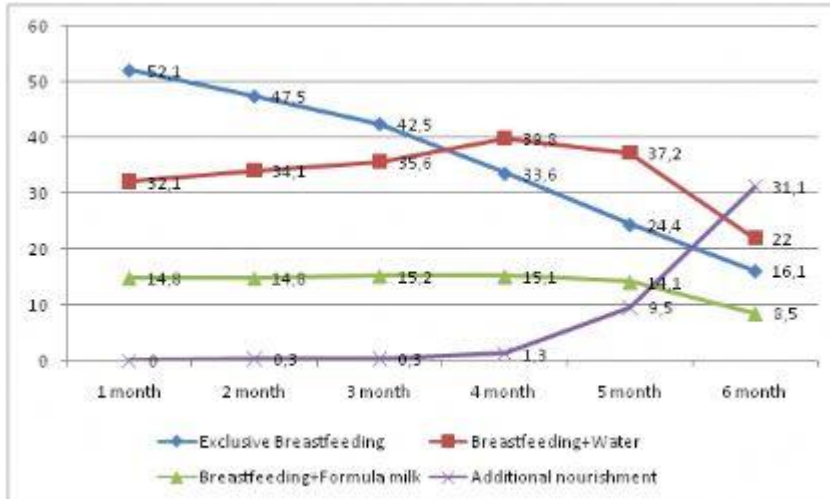
* Row percent

The association between mothers' postpartum EBF behavior and their previous EBF duration, and plans for EBF on delivery during pregnancy

		Postpartum EBF behaviour				p value
		Less than 6 months		6 months and over		
		n	%*	n	%*	
Previous EBF duration (n=351)	Less than 6 months	92	74.8	31	25.2	<0.001
	6 months and over	116	50.9	112	49.1	
Plans for EBF on delivery during pregnancy (n=610)	Less than 6 months	59	70.2	25	29.8	0.093
	6 months and over	319	60.6	207	39.4	

* Row percent

Nutrition types according to monthly periods during first six months of infancy



P-1114

depression, anxiety and stress state in mothers of children with cerebral palsy with or without epilepsy

Oktaç SARI¹, Mutluay ARSLAN², Ümit AYDOĞAN¹, Emrah BOYACIOĞLU¹, Sebahattin VURUCU²

¹Department of Family Medicine, Gulhane Military Medical Faculty, Ankara, Turkey

²Department of Pediatric Neurology, Gulhane Military Medical Faculty, Ankara, Turkey

BACKGROUND&AIM: Cerebral palsy(CP), developed as a result of nonprogressive brain damage is defined as the tone and posture disorders. Prevalence is reported to be 1.0 to 2.4 per 1000 live births. 25-80% of patients have additional disease other than posture and movement disorders. Any problems arising in children with CP bring both physical, psychological, financially need significant loads on parents. We investigated the emotional state of the parents of patients with cerebral palsy accompanied by epilepsy and not.

METHOD: This study was conducted on parents of patients diagnosed with CP, outpatients applied to Pediatrics Neurology Clinic by Gulhane Military Medical Academy(GMMA) Department of Family Medicine. The children's diagnosed with CP, age, gender, age-at-diagnosis, etiologic factors, the type of CP, CP's degree according to the Gross Motor Function(GMF) Classification was recorded. Afterwards, Depression Anxiety Stress Scale(DASS-42) was used for parents.

RESULTS: Total of 37 patients with CP, 23 patients (62.2%) had comorbid epilepsy. The mean age was 7.5 ± 3.3 (2-17) [CP: 7.4 ± 2.8 (3 to 13.5), CP+Epilepsy: 7.6 ± 3.6 (2-17)]. With CP children's 64.3% (n=9), and children's with epilepsy+CP 73.9% (n=17), hypoxia and/or prematurity as etiologic factors were encountered. According to the type of CP; 89.2% (n=33) of cases were spastic type (in 56.8% of them (n=21) types of spastic tetraplegia). According to GMF, nearly half of CP patients (45.9%, n=17) were level 5 (even assistive devices using, they are very limited in self-forth movement).

According to the parents of the DASS-42 points; with CP children's parents (n=5/14, 35.7%), CP+epileptic children's parents (n=2/23, 8.6%) had advanced symptoms of depression. Parents of children with CP (n=5/14, 35.7%), CP+epileptic children's parents (n=5/23, 21.7%) had high levels of anxiety symptoms. Symptoms of stress; the parent's with CP children (n=5/14, 35.7%), CP+epileptic children's parents (n=1/23, 4.3%) was advanced and very advanced. Statistical difference wasn't determined between two groups in terms of depression anxiety and stress (respectively; $p=0.297$, $p=0.246$, $p=0.50$).

CONCLUSIONS: CP, which requires a multidisciplinary approach, besides serious problems in children, brings the parents especially mothers of important psychological problems is a disease that leads to a decrease in quality of life. Therefore, providing psychological and social support should be among the important objectives to protect the psychological well-being of mothers.

Keywords: cerebral palsy, epilepsy, mood of mothers

P-1115

Burnout Syndrom and Job Satisfaction among Family Medicine Resident Doctors

Ayşe Didem Esen, Gülay Arıcı, Gözde Nizamoğlu, Ezgi Kaçar, Seçil Arıca

Department of Family Medicine, Istanbul Okmeydani Research and Training Hospital, Istanbul, Turkey

BACKGROUND: The aim of this study was to assess levels of burnout syndrom and job satisfaction among family medicine residents and to reveal their relations with different variables, like socio-demographic features, life style, qualities of working areas

METHOD: Family medicine resident doctors working in Okmeydani Research and Training Hospital and Şişli Etfal Hamidiye Research and Training Hospital are included in our study. The survey comprised of three parts (A) Sociodemographic data form and a questionnaire about personal lifestyle, habits, social and academic life, working conditions. (B) Maslach Burnout Inventory (C) Minnesota Satisfaction Inventory was administered to the resident doctors. Correlation analysis, independent sample t-tests are used as statistical methods.

RESULTS: 20 male and 26 female total 46 family medicine resident doctors take part in our study. Mean burnout scores were; MBI-EE (emotional exhaustion) 22.28 ± 5.60 , MBI-D (depersonalization) 21.43 ± 5.54 , MBI-PA (personal achievement) 30.93 ± 4.93 and mean satisfaction score was 58.63 ± 13.74 . Burnout and satisfaction scores were not affected by gender and marital status. Having social activities associated with high satisfaction ($p=0.012$) and MBI-PA ($p=0.001$) scores and low MBI-EE ($p=0.026$) scores. Feeling having support from hospital executives associated with high satisfaction ($p=0.048$) and low MBI-D ($p=0.014$) scores. Sporting regularly associated with low MBI-EE ($p=0.046$) scores. Having the idea of education content and quality is adequate was associated with high satisfaction ($p=0.036$), low MBI-D ($p=0.017$) scores. Following academic literature regularly is associated with low MBI-D ($p=0.034$) scores. Planning to change the clinical residency branch is associated with high MBI-D ($p=0.007$) scores. There was statically significant negative correlation between age and MBI-EE ($p=0.047$) and MBI-D ($p=0.029$) scores.

CONCLUSION: Burnout levels may decrease and also job satisfaction levels may increase among family medicine residents by having social activities, regulation of working conditions and education quality. Psychological support and arrangements in social, working, educational areas would effectively contribute to prevention of burnout syndrom and improvement of job satisfaction.

Keywords: Family medicine, Resident doctors, Burnout syndrome, Job satisfaction, Maslach Burnout Inventory, Minnesota Satisfaction Inventory

P-1116

Acute disease consultation: consultation's reasons

Susana Sá, Susana Rios, Mariana Pinto Leite, Gonçalo Pereira, Miquelina Redondo

Unidade de Saúde Familiar Sem Fronteiras, ACeS Entre o Douro e Vouga I

INTRODUCTION: In Primary Care, the acute disease consultation (ADC) serves to respond to situations of acute illness or escalation of chronic disease. However, there is often a misuse of the ADC, which may affect the accessibility of users that effectively need this consultation.

OBJECTIVES: To evaluate the correlation between the reasons given by the user in the admission sheet and the motives (S-Subjective; ICPC-2) recorded in the health care informatics software (SAM[®]) by the doctor; identify the non-valid reasons most frequently recorded in ADC; characterize the population that uses the ADC and evaluate the quality of medical records.

METHODS: Cross-sectional observational study, descriptive and analytical; Period analyzed: 01-02-2014 to 01-31-2015; Variables: gender, age, consultation reasons and motives (S). Information collection: SAM[®] and admission sheet; Compilation of the data and statistical analysis: Microsoft Excel[®]. The test pilot was made at 01-02-2014. Informed consent was required for the participation in the study. It was also requested permission for the realization of this research work to the family health unit coordinator. All ethical principles were respected.

RESULTS: Of a total of 5707 ADC, were selected randomly 1251 ADC. Overall, there was a conformity between the reasons given by the patient in the admission sheet and the motives codified by the doctor; The medical records were in general satisfactory; About 1/5 of ADC reasons weren't valid (22.5%)—the most recorded motive

(S) was Results Tests/Procedures (A60); There was a predominance of females (63%) and the age groups of 19-45 years (35.6%) and 46-65 years (33.3%) in these consultations.

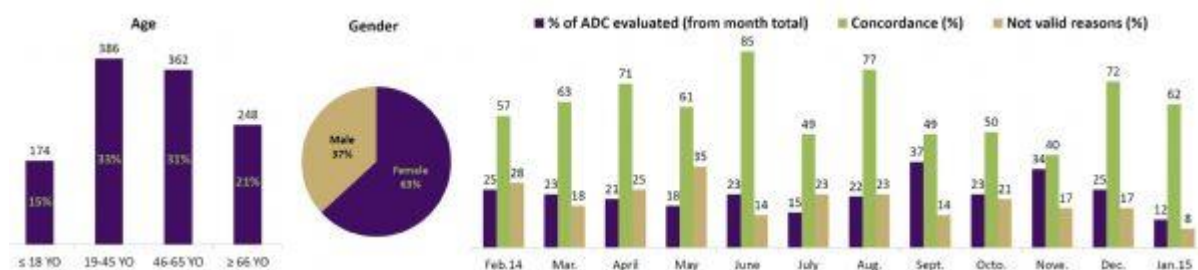
DISCUSSION: The investigators concluded that is essential to consolidate among the users of primary care the clinical conditions that justify the use of the ADC, in order to minimize the not valid reasons and to ensure the greatest accessibility to the ADC. Medical records, based on ICPC-2, can still be improved.

Keywords: acute disease consultation; accessibility; medical records; consultation's reasons

ACD valid and not valid reasons

ADC valid reasons:	ADC not valid reasons:
Acute illness with recent onset, less than 3 days of evolution	Clinical situations without acute complaints or escalation of chronic symptoms/ signs
When the user is absent from work due to acute illness	To show medical exams
Recent deterioration of chronic illness (in the last week)	To request credentials for medical exams, for physiotherapy or other treatments
Intention to make voluntary interruption of pregnancy/ Miscarriage	To request credentials for evaluation on hospital consultation
After evaluation, by the nursing team, of situation that deserves medical evaluation	To request medical statements/ reports (health/ disease certificates or others)
Prescription/ delivery of emergency oral contraceptives	To renew work incapacity certificate
Clinical situations related to recent exposure to infectious diseases capable of prevention or treatment (tuberculosis, meningitis, chicken pox ...)	To renew chronic medication or others prescriptions

Principal Results



P-1117

10 Years (2001-2010) Evaluation Of Cancer Cases At Dicle University

Necmi Arslan¹, Erkan Kibrisli¹, Hamza Aslanhan¹, Ahmet Yilmaz¹, Seyhmus Kaya², Ugur Firat², Mehmet Halis Tanriverdi¹

¹Department of Family Medicine, Medicine Faculty, Dicle University, Diyarbakir, Turkey

²Department of Pathology, Medicine Faculty, Dicle University, Diyarbakir, Turkey

AIM: The incidence of cancer is increasing in our country and in the world. The treatment of cancer is difficult, time wanting and costly. The most important step of treatment is early diagnosis. The incidence of these cases and differences with regards to gender and age groups are important for family physicians when evaluating patients in their regions.

METHOD: The biopsy reports of patients diagnosed malignant between 2001 and 2010 years, in the department of pathology at Dicle University Faculty of Medicine, were analyzed retrospectively. RESULT: A total of 3624 patients were examined with regards to age, sex, topography of material and biopsy results according to the pathologic diagnosis. 41.7% of cases were female and 58.3% were male. When examined the topographic distribution of received cases The most common type of cancer was observed in lung cancer %11.9 (Table 1). The cases were examined separately in men and women. In men the lung cancer was the most common with proportion 18.5%, while in women the breast cancer 23.1% were observed (Table 2). The incidence of cancer was the highest between 50-60 years of age.

CONCLUSION: Family medicine is a medical specialty, that is individual, preventive, holistic, multidisciplinary. Therefore, for a family physician it is necessary to know specific diseases of the area where serves in and has to know to take the necessary measures to determine in advance of these diseases. In our study, we tried to

determine by using the data of Dicle University Hospital, the biggest one in the region, which types of cancer contract of our people the most common in the geography we live with. We believe that this information would be guide for our works which we will do later, to protect our patients and to diagnose of diseases early.

Keywords: Cancer, archives,epidemyology

figure 1

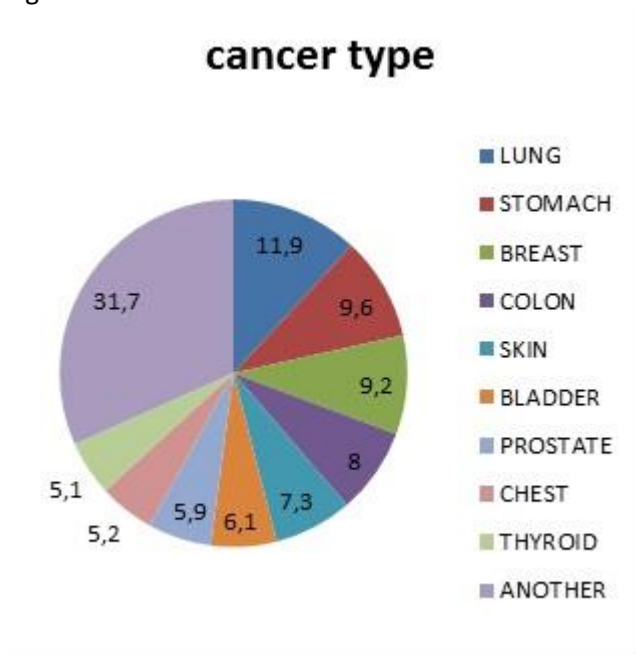


Table 1

MALE		FEMALE	
LUNG	18,5	BREAST	23,1
STOMACH	11,5	COLON	9,8
PROSTATE	11,3	THYROID	9,2
BLADDER	10,0	STOMACH	8,1
LARYNX	8,8	LUNG	5,8

P-1118

Career pathways for General Practitioners: linking life roles, work values and career stage

Lesley Margaret Piko

ACT Medicare Local Ltd

BACKGROUND: General practitioners (GPs) deal with increasingly complex health conditions and treatments, and an ageing population. However, once fully qualified, GPs are confronted with relatively flat career trajectories. Many GPs respond by working part-time on clinical activities, in combination with non-clinical life roles. GPs make choices about the relative importance of these roles within the context of a career in general practice.

AIM: The aim of this project was to explore the connections between career stage, work values, life roles, gender and age in decisions by doctors to limit their hours in clinical work.

METHOD: This research examined career decisions GPs made after working for several years in their chosen profession. Twenty GPs participated in semi-structured interviews and a pilot survey. They were asked about their work history, life roles, work values, career concerns and work intentions. The survey collected data about values and career concerns.

RESULTS: The findings of this project provide insights into the way in which work values and career concerns combine to influence mid-career choices by GPs, especially decisions to limit their involvement in clinical work. In the absence of an upward clinical career path, many GPs found development in other roles in spheres such as business, research, policy development, family and leisure. Several career pathways were found including the traditional career as a GP and the more diverse portfolio career model.

CONCLUSIONS: This research brings together factors which influence GP work life and examines them in the overarching framework of a professional career developing over time. An awareness of how GPs make mid-career decisions provides a basis for supporting their career development in an essentially flat career structure.

Keywords: career pathways, career choice, career mobility

Piko Poster Career Pathways for General Medical Practitioners

Career Pathways for GENERAL MEDICAL PRACTITIONERS: Linking life roles, work values and career stage

Lesley Piko, Australian Local of General Practice and Community Health, ANU Medical Centre, leslay.piko@anu.edu.au

General practice in the Australian health system
It could be even more difficult in the future to meet Australia's rising demand for primary health care. General medical practitioners (GPs) are dealing with increasingly more complex health conditions and treatments, and an ageing population. The average age of GPs is rising and a rise in GP numbers is looming. Approximately 80% of GPs are now working in groups or corporate practices and their career pathways are diverse. Once they are fully qualified, the ways in which GPs develop and progress their careers is less clear-cut when confronted with relatively flat career trajectories. Many GPs respond by working part-time on clinical activities, in combination with non-clinical roles.

AIM
This pilot project informs a larger study of career decisions which GPs make after working for several years in their chosen profession. The project's overall aim is to research the connections between work values, stage of career, life roles, gender and age in the decisions GPs make about their clinical work.

METHOD
Purposive sample for pilot stages
Semi-structured interviews with GPs (n=17)
Survey of career concerns and work values (n=17)

	Frequency	%
Male	4	23.5%
Female	13	76.5%
<40	6	35.3%
40-50	11	64.7%
>50	0	0%

Participants were asked about their academic and employment history, family circumstances, work values, and issues they are concerned about in developing their career.

Content was analysed using grounded theory methodology.
The Physician Values in Practice Study (PVP) and Adult Career Concerns Inventory-Short Form² were chosen for this pilot stage of the project.

CAREER PATHWAYS
Several pathways were found:
• Single, lower senior clinical positions
• Specialist, clinical + non-clinical roles
• Multiple clinical practices of same form
• Multiple roles, clinical + non-clinical at the same time
• Engaged, working in and out of clinical
• Non-work, working part-time, no fixed location
• Reciprocity, a back-up to support other interests
• Part-time and full-time participation

The different career pathways found in this pilot project provide insights into the way in which work values and career stage combine to influence choice made by GPs, especially decisions to vary their participation in clinical work. In the absence of an upward clinical career path, many GPs seek to enhance other non-clinical life roles in spheres such as business, research, education, policy development, family and leisure.

WORK VALUES
This research points to lifestyle factors and autonomy being of highest importance to GPs followed by passing on knowledge to new doctors.
Strongly influence between their personal and professional commitments (14 GPs);
Following a flexible work schedule (13 GPs);
Working a predictable number of hours (12 GPs).
A lot of people who suggest that they've got an interest in general practice that hasn't been entirely reciprocated in 2016. In other words, they will immediately see what I mean, when I say that for a lot of people their career path doesn't fit all of their reports about, you know that sort of stuff. I do something in the morning, they go, 'well, look at this, don't you?' And I have that point of view, a lot of your value propositions which may come across differently. They will see it as a new year - something that's coming, going over to get to holidays and do stuff. (GP14, 48min, 45min)

When you are a general practitioner as your main job, you're not really interested in the sort of stuff that's coming out of the industry. I don't think it's personal recognition really. So for all sorts of reasons I just don't respond. (GP16, 50min, 45min)

When they say they don't want to be a doctor, they're not saying they don't want to be a doctor. (GP17, 48min, 45min)

Having freedom to choose their own method of working (11 GPs);
Clear of the things that I do and to my capacity to determine my hours. (GP18, 50min, 50 min)

When I have and they don't have the hours and how I tell my patients and how many jobs I want to see per hour and what I want throughout the day. (GP19, 50min, 50 min)

Working and increasing new doctors (12 GPs);
How I see teaching is that not sharing the experience with them. (GP20, female, 44 min)

It's to give to make a difference to the next generation of doctors coming through. I suppose, to be able to offer... passed on knowledge. (GP21, female, 52 min)

DISCUSSION
Existing research relating to general practice in Australia, for the most part, deals with single aspects of a GP work life (e.g. satisfaction or well-being). There is little evidence of connections being made between these single aspects to the larger framework of a career development. Nor has the connection been made between time spent in different roles, work values, career stage, gender and age.
Workforce planning is essential for determining and designing policy options to ensure the supply of GPs to meet demand. An awareness of how experienced GPs make career-related decisions can inform workforce supply policy. It can also provide a basis for supporting the career development of a range of health professionals such as specialist pharmacists and dentists, who may work in an alternative way in essentially flat career frameworks.

P-1119

Aligning business and people in general practice

Lesley Margaret Piko

ACT Medicare Local Ltd

BACKGROUND: Approximately 80% of Australia’s general practitioners (GPs) work in group or corporate general practices, supported by practice managers, nurses and other staff. People are a key factor in these clinical practices achieving their business goals. People development is often seen as an activity of large businesses. However, greater attention to this issue by group practices could help retain experienced people within the primary health care workforce and ensure appropriately trained, motivated and managed staff are available.

AIM: The aim of this project was to explore how general practice business goals and the personal goals of GPs are being aligned to attract and retain GPs in clinical practice.

METHOD: Six case studies of general practices were conducted and ten GPs participated in semi-structured interviews and a pilot survey. Data were analysed to identify work values and the alignment between business and personal goals.

RESULTS: The case studies found that people management in general practice was for the most part limited to remuneration and payroll systems with little attention given to the personal development of people who worked in the practice.

This research also found that general practice business valued healthy business, healthy patients and healthy staff while GPs valued lifestyle, autonomy and service.

CONCLUSIONS: This research brings together factors which influence GP career development within the context of group general practices. GPs and non-clinical staff would benefit from career development, satisfying work experiences and financial remuneration that provide a better fit for their work lives and other interests. Business policies could support people within the general practice business in a way that aligns the goals of the practice with personal goals.

Keywords: Business management, workforce, career development

Piko Poster Aligning Business and People

Aligning BUSINESS AND PEOPLE in GENERAL MEDICAL PRACTICE

Lesley Margaret Piko, Academic Unit of General Practice and Community Health, ANU Medical School, Henty Professor, et al.

General practice in the Australian health system

Approximately 80% of Australia's general practitioners (GPs) work in group or corporate practices, supported by nurses and other staff. Little is known about how business and personal goals are aligned in general medical practice.

AIM

As part of a study of GP careers, I explored how general practice business goals and the personal goals of GPs are being aligned in the Australian Capital Territory (ACT) to attract and retain GPs in clinical practice.

METHOD

Purposive sample

- Case studies of general practice (n=6)
- Interviews with GPs (n=10)
- Pilot survey (n=10)
- Interviews with key informants (n=2)
- Review of literature

Data were analysed for conceptions of work values and the alignment between business and personal values within general practice.

FRAMEWORK

Work values are aspects of occupational life that contribute to job satisfaction, such as income, lifestyle, autonomy, providing service and achieving outcomes.

RESULTS

I found three peer-reviewed articles about work values in medicine (Australian doctors), Australian medical students and GPs (family physicians) but none of these connected personal work values to the general practitioner's business goals.

My case studies indicate that workforce management focuses on remuneration and payroll systems.

General Practices in the ACT

Practice Size	Number
2000-30	28
30-40	25
40-50	24
50-60	24
60-70	24
70-80	24
80-90	24
90-100	24

And fewer GP-owned or owned practices.

About 70% of Canberra's general practices are "solo" with less than four GPs. There is a shift of GPs towards larger practices because of higher commercial success and of lower costs.

Different models of general practice:

- Private business models owned by GPs
- For-profit business models owned by shareholders
- Not-for-profit community government general practices and clinics supported by government or charitable funding and in-kind contributions
- Health clinics within large government funded organisations

BUSINESS GOALS OF GENERAL PRACTICES

GPs join together in general practices, seeking the skills and infrastructure needed to achieve their goals for primary health care.

Healthy business:
Dr. [Name] (general practitioner, not GP doctor): "My practice is the business model" - to be staffed with enough doctors and nurses".
Practices seek the flexibility and adaptable resources to respond to changing patient and government demands.

Healthy patients:
While providing primary health care services to patients is seen as core to general practice, how this is achieved (cost, care in terms of performance, productivity, cost effectiveness, etc.) is debatable.

Healthy staff:
Attracting and retaining staff and workforce is a goal of business. For general practice in the ACT, more GPs, practice nurses and staff are needed but this may not be viewed as the most urgent. This situation highlights the importance of general practices in planning and managing their practice.
"Managing a general practice can be stressful... a practice might need help when their regular GP is not here... I have to do it" (Owner of a general practice-GP).

PERSONAL GOALS OF GENERAL PRACTITIONERS

My research predicts the lifestyle being of highest value to GPs, followed by autonomy from service. This agrees with a USA study of family physicians which reported service, lifestyle and autonomy as important but demotivated practice, reducing practice and management.

Lifestyle:
GPs said they wanted good work-life balance and time off when needed. In the ACT, 40% of GPs report having a second job.

Autonomy:
I asked to GPs who said they wanted to have control over when and how they work.

Service:
GPs said that working with people attracted them to general practice.
"I get working with a mixture of people and sometimes they become close" (General Practitioner-GP/MD).
"I prefer the interaction with patients and colleagues" (General Practitioner-GP/MD).

Remuneration:
The amount of acceptable remuneration for work. Most GPs agree the business side (not their work contract) is well understood. Few GPs thought remuneration was a good work and work-life.

DISCUSSION

In Australia, where GPs are choosing not to work alone, general practices can place more emphasis on managing their people to align business and personal aspirations.

Processes used to align:

- Design of work contract
- Scheduling of work
- Recruitment
- Performance monitoring
- Career development
- Succession planning

In the ACT, having organisations with different business goals and strategies to achieve them provides employment options for GPs.

Quote from a GP: "By giving the business right or that it spending resources is expensive and also profitable" (GP/MD).

P-1120

The frequency of urinary incontinence and effecting factors in women

Irem Kevser Cantürk, Hilal Abbak, Zuhal Aydan Saglam

family medicine

AIM:

To determine the frequency of urinary incontinence (UI) in women over 35 years old.

MATERIALS-METHODS:

Women ≥ 35 years old applying to Gynecology Department for general gynecological complaints between December 2013-January 2014 were invited for a questionnaire inquiring the presence and frequency of UI complaint. Demographic characteristics, intraabdominal operation history, number of pregnancies, smoking habit, associating chronic diseases and drug use were recorded and compared in women with and without UI.

RESULTS:

Of 163 patients (age: 49.4 ± 10.5 years; BMI: 29.7 ± 5.5 kg/m²) 94 had UI. 30 (31.9%) of women with UI had HT, 20 had DM (21.3%) and 8 had COPD (8.5%). The frequency of intraabdominal operation history was 66.2%. There was no relationship between smoking habit and UI ($p=0.811$). 69 women with UI (%18.4) had this problem 1-3 times in a day, 26 (%18.4) had 1-3 times in a week, 38 (%23.3) had 1-3 times in a month. UI was found significantly more frequent in multiparas as expected ($p=0.001$). The patients who has UI of total 94 patients 67 (%71.3) didn't apply to a doctor, 51 (%65.4) of them ignored ($n=43$; % 84.3) was explained. UI was found more significantly in the patients who has HT, DM and COPD (respectively; $p=0.003$; $p=0.016$; $p=0.021$)

Discussion and CONCLUSION:

UI is a common problem in females which is unfortunately being ignored by patients and doctors as well. While obesity, age, concomitant chronic diseases are the most common risk factors in most cases, post-menopausal women with additional history of multiparity, and intraabdominal operation who are attending to primary care unit for nonspecific reasons or for periodical examination should be questioned for UI.

Keywords: urinary incontinence women

P-1121

Evaluation of thyroid function tests in patients admitted to the family medicine clinic for examination

Yılmaz Sezgin, Ali Emre Akgün

Sürmene State Hospital, Trabzon, Turkey

INTRODUCTION:

In the last thirty years, conflicting studies have been published, regarding the effects of iodine fortified nutritional advice, on the targeted populations. Both the studies suggesting that iodine supplementation is inadequate and the studies suggesting that iodine supplementation may lead to hyperthyroidism are available.

In this study we investigated the effects of iodine supplementation by retrospectively reviewing the records of the patients who admitted to the family medicine clinic.

MATERIALS-METHODS:

This study was a retrospective cross-sectional study. A total of 572 patients who admitted to Tonya state Hospital between September 28th 2012 and 17 May 2013, meet the inclusion criteria, and both TSH and T3 levels have been measured were included in the study. The mean values of TSH and T3 were compared with the population mean. In addition, the TSH and T3 levels were categorized according to the reference value and percent distribution rate was calculated.

RESULTS:

The ratio of T3 levels above population mean was 80.6%. The ratio of TSH ratio below the population mean was 88.1%. The means of those included in the study according to the T3 levels were significantly higher than the means of population ($p < 0.001$). The means of those included in the study according to TSH levels were significantly lower than the means of population ($p < 0.001$).

CONCLUSIONS:

In our study, higher T3 values in comparison with population means and lower TSH values in comparison with population means indicate that the T3 levels suppresses the TSH levels. These results suggest that majority of the patients who admitted to the family medicine clinic have been affected subclinically at hyperthyroidism level. As a result, given that pharmacological treatment for hypothyroidism is easily available, the rationale for implementing iodine supplementation programs for the treatment of endemic goiter should be questioned again.

Keywords: Iodine supplement, Hyperthyroidism, TSH and T3

Tablo 1

Test Value = 2.71

	n	mean	SD	t	P
T3	572	2.99	0.35	18.83	<0,001

Comparison of T3 values to population mean

Tablo 2

Test Value = 2.65

	n	mean	SD	t	P
TSH	572	1.31	1.07	-29.80	<0,001

Comparison of TSH values to population mean

P-1122

Too early can be too late! Stroke in the young adult

Joana Carneiro¹, Sofia Correia Pinto², Inês Bento¹

¹USF Garcia de Orta, Porto, Portugal

²USF S.João do Porto, Porto, Portugal

Background & AIM: Recognizing the cause of a stroke in young adults is challenging and many studies have been trying to understand the etiopathogenesis behind it, which is undetermined in 35 to 42% of cases. The age range for which one is considered a young adult is not yet defined, but most studies consider patients up to 45 years of age. The aim of this study is to characterize the profile of a young adult who has had a stroke regarding sociodemographic characteristics, type of stroke, presence of risk factors and the clinical implications after this cardiovascular event.

METHODS: Descriptive cross-sectional study in two Primary Health Care Units in Porto, Portugal. The clinical process of patients who had had a stroke before or at 45 years of age was assessed, in particular the personal history, type of stroke, diagnostic tests and functional state. Arterial hypertension, diabetes, dyslipidemia, tobacco use, use of oral contraceptives and family history of premature cardiovascular disease were the risk factors taken into consideration. The presence of migraine, alcoholism, hyperthyroidism and pregnancy were also assessed. SPSS 20.0® was used for statistical analyses.

RESULTS: An association between atherosclerotic risk factors and stroke was established. However the importance of other factors such as genetics may also be implied in the etiopathogenesis of stroke in young adults, especially on those in which the cause is undetermined.

CONCLUSIONS: Primary prevention should be reinforced, modifiable risk factors should be regularly assessed and healthy life style habits should be promoted. Sensitizing health authorities, health care professionals and the general population about risk factors and early detection of stroke is essential and can eventually make a difference in outcomes.

Keywords: stroke, young adult, primary health care

Graphic 1: Patient distribution according to gender and age range at which the stroke was diagnosed

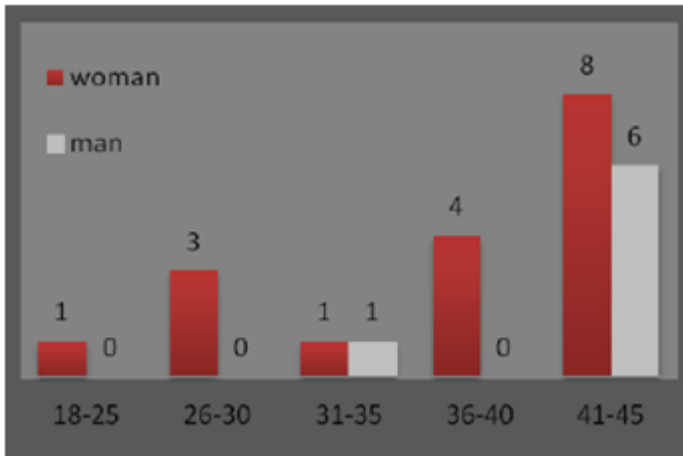


Table 1: Variables studied

Variable	Definition
Hypertension (HT)	SBP equal or superior to 140mmHg and/or DBP equal or superior to 90mmHg or previous diagnosis
Diabetes mellitus (DM)	Blood glucose > 200mg/dl, fasting blood glucose > 126mg/dl, impaired glucose tolerance or previous diagnosis
Dyslipidemia	Total cholesterol > 200mg/dl, HDL cholesterol <40mg/dl in men or <45 mg/dl in women, triglycerides > 150mg/dl
Family history of premature cardiovascular (CV) disease	First degree family member with cardiovascular disease onset <55 years of age in men and <65 years of age in women
Other relevant factors	
<ul style="list-style-type: none"> • Genetic changes • Acquired thrombophilias 	<ul style="list-style-type: none"> • Alcoholism • Obesity • Excess weight
	<ul style="list-style-type: none"> • Hyperthyroidism • Smoking • Migraine
	<ul style="list-style-type: none"> • Oral contraceptives (OC)

Graphic 2: Distribution according to type of stroke

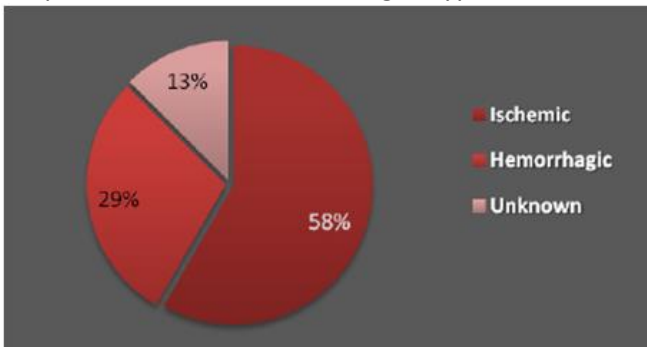


Table 2: Stroke localization

Localization	n
Large arteries	6
Lacunar	4
Arterial dissection	1
Other	2
Left middle cerebral artery aneurysm	1
Intra-cerebral hemorrhage	5
Extradural hemorrhage	1
Unknown	3

Graphic 3: Distribution according to CV risk factor

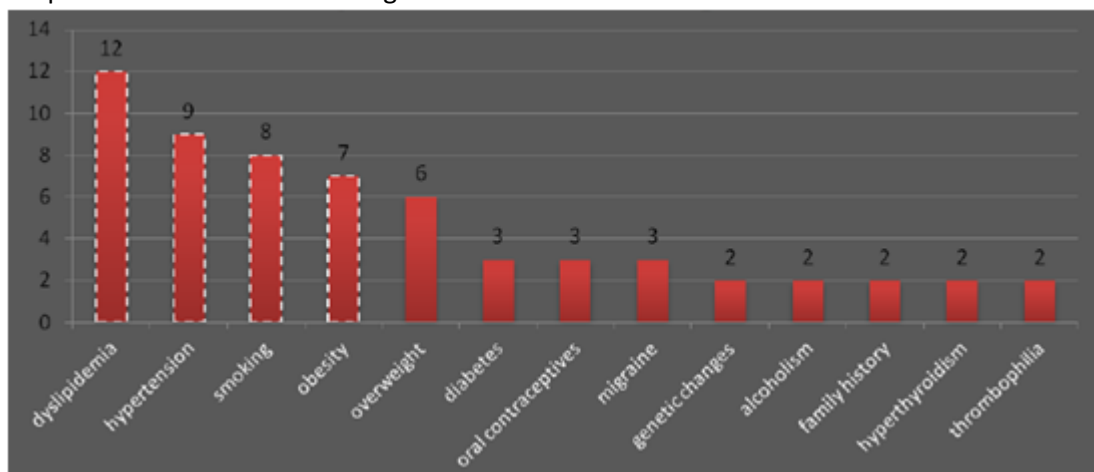
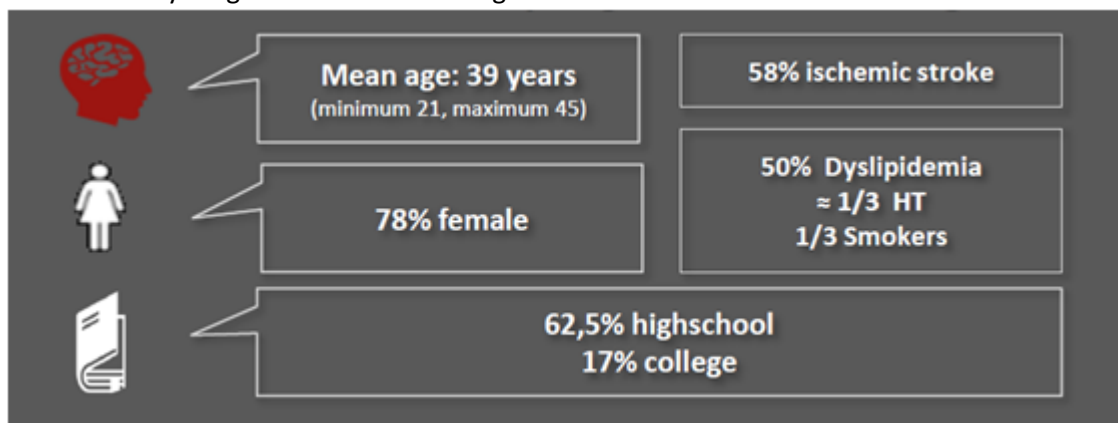


Table 3: Association between the different CV risk factors

	OC	HT	Smoking	Obesity	Migraine
OC	3	2	2	1	1
HT	-	9	3	4	2
Smoking	-	-	8	1	0
Obesity	-	-	-	7	2
Migraine	-	-	-	-	3

Profile of the young adult with stroke diagnosis



P-1123**working conditions and the effects of demographic characteristics on sleep quality of doctors**

Sema Erdogmus, Gokcen Cerrah, Hasan Huseyin Mutlu, Zuhal Aydan Saglam

family medicine, istanbul medeniyet university goztepe training and research hospital, istanbul, turkey

INTRODUCTION: To evaluate the sleep quality of doctors

METHOD: This cross-sectional analytic study was carried out in 2014 at a tertiary hospital among 99 residents. Pittsburgh Sleep Quality Scale(PSQS) was performed. PSQS \leq 5 showed good quality of sleep and scores over 5 showed bad quality. Socio-demographic characteristics of participants were recorded and analysed with respect to their consumption of sleeping pills, cigarette and alcohol.

FINDINGS: The average age was 33.70 \pm 9.62; 58.6% were men. While 30.32% were working in surgical departments, 69.7% were working in internal medicine. 20.2% were smoking and 45.5% were drinking alcohol. Mean BMI was 23.77 \pm 3.70 and 26.03 \pm 2.64kg/m² for women and men respectively. Mean waist circumference was 82.95 \pm 7.19 and 91.98 \pm 7.19 cm for women and men resp. BMI and waist circumference of men were found significantly higher than women (resp. p<0.0005 ve p=0.001).

8.1% had chronic disease [HT/DM/HL; n=1/2/7]. 60 participants had \leq 5 shifts and 39 had >5 shifts per month. Total PSQS was 4.23 \pm 3.16. 68.7% of the doctors had PSQS \leq 5 and 31.3% had a PSQS score of >5. The mean PSQS were 4.81 \pm 3.29 and 3.41 \pm 2.81 for women and man respectively (p=0.028). In terms of surgery and internal departments, sleep quality was found to be 66.7%/69.6% good and 13.3%/30.4% bad respectively (p<0.05). For doctors having 5 or less shifts/month (n=60), the mean PSQS was statistically lower than those who had more than 5 shifts (n=39) (p=0.024).

DISCUSSION: Although inevitable, it is for sure that shifts have long term negative effects on sleep quality of doctors. It seems that female doctors have much more burden in daily life which is supported by the data that they require more sleeping pills. Bad sleep quality for doctors may cause errors in intellectual/metabolic activities and in critical decision making. This possibility should be taken into consideration in planning working schedules of especially female doctors.

Keywords: sleep quality, doctor, working condition

Comparisons of demographic and environmental factors with sleep quality

PSQI		<5/5(good)	>5(poor)
Gender	Women	37	21
	Men	31	10
BMI (kg/m ²)	\leq 30	62	30
	>30	6	1
Cigarette	smoker	15	5
	non-smoker	53	26
Alcohol	drink	40	14
	not drink	53	26
Psychiatric drug	use	2	4
	not use	66	27
Physical exercise	do	16	8
	don't	52	23
Number of seizures	\leq 5	46	14
	>5	22	17

demographic variables

N=99

Women (N=58) Men(N=41)

BMI		23.77 ± 3.70	26.03.± 2.64
Cigarette	smoker	7	13
	non-smoker	51	28
Alcohol	drink	29	25
	not drink	29	16
Psychiatric drug	use	5	1
	not use	53	40
Physical exercise	do	12	12
	not do	46	29
Chronic disease	have	4	4
	no have	54	37
Sleep time (hours)		6.14±1.18	6.18 ± 0.98
Number of seizures	≤5	35	25
	>5	23	16

P-1124

Burnout syndrome among the residents of a university hospital

Zuhal Altınbaş, Hatice Esin Temiz, Zuhal Aydan Sağlam, Hasan Hüseyin Mutlu
family medicine

Background and AIM: To investigate the level of burnout and related factors among the residents of a university hospital.

METHOD: Sociodemographic data of 202 doctors were collected and Maslach Burnout Inventory was applied between December/2011-March/2012. Depersonalization (DP), decreased accomplishment (DA) and emotional exhaustion (EE) was investigated. In DP and EE subscales, high scores indicated high burnout level while in PA low scores were associated with high burnout levels. ANOVA and t-tests were used for statistical analysis. RESULTS: 56.4% were female; mean age was 28.6 years. 11% had chronic disease; 48.5% was married. 58.9% were currently doing compulsory medical service. Burnout Score (BS) was found significantly higher among bachelor residents compared to married ones. The smokers (25.7%) and alcohol consumers (29.7%) stated that they increased smoking and alcohol use due to work-related stress. BS was high also among the residents who increased smoking due to work-related stress. Lack of appreciation, lack of support from colleagues, lack of self-confidence, insufficient time for hobbies, lack of contentment with the chosen specialization and/or profession itself were the main factors for high BS. The prevalence of high scores was 55.4%, 34.6% and 9.9% respectively among the residents of internal medicine (IM), surgical departments (SD) and family medicine (FM). Working hours for SD, IM and FM were 288h, 273h and 254h per month, respectively. The mean workload of assistants in SD (288hrs) is significantly ($p=0.045$) higher than FM. The burnout levels of SD and IM were similar. However BS score of the residents of SD was higher than that of FM residents in all subscales and GT score. DA and BS scores of SD and IM were significantly higher than those of the FM residents.

CONCLUSION: Although associated with being bachelor, high Burnout Scores among SD and IM residents were highly associated with long working hours day and night and weekends. This makes it obvious that in Turkey the current Family Medicine Policy may be better without the negative influence of additional working hours for both physicians and patients.

Keywords: burnout syndrome, family medicine, workload

P-1125

Are People With HIV Happier?

Zuhal Aydan Sağlam¹, Fatma Sargin¹, Rasim Volkan Ertaş¹, Aynur Rzayev¹, Hasan Hüseyin Mutlu¹

¹family medicine

²infectious diseases clinic

AIM: Comparison of quality of life(QOL) of a sample of HIV(+) patients with healthy people.

METHOD: QOL of volunteering HIV(+) patients attending to a university hospital between 2012-2013 were assessed with SF-36 and compared with 70 healthy controls. Sociodemographic data were collected. Using SPSS Version 17, the data were tabulated and compared with chi-squared tests and the means were compared by one-way t-tests and F-tests.

RESULTS: Among the 70 HIV(+) patients, 55 are male, 38.6% are under 35 years old, 58.6% are not married, 64.3% have HS education or more, 65.7% are employed, 54.3% have monthly income over basal wage. Sociodemographic characteristics were in match with control group except marital status. Among the HIV group, 45.7% were diagnosed less than one year ago and 38.6% were treated for a year or less. Also, 48.6% had some HIV training, about half by their physician and the others by NGO's. About half (47.1%) believe that they are well informed about HIV and 60% believe that they are sufficiently treated. A vast majority of the patients (77.1%) did not get any psychiatric treatment. The mean Physical Component Score (PCS) for the HIV group was 61.68 (± 8.43) which is significantly greater than the mean PCS (58.62 ± 10.69) for the control group ($p=0.017$). Similarly, the Mental Component Scores (MCS) were 53.10 (± 10.69) and 48.62 (± 9.57) respectively for the two groups ($p=0.005$). The mean scores of Physical Function (PF), Back Pain (BP), Vitality (VT), Social Functions (SF) were significantly higher for the HIV group than the control group (resp; $p=0.0065$; $p<0.005$; $p=0.0025$; $p<0.005$). These indicate that the HIV group had significantly better QOL on many scores than the control group, surprising the researchers.

CONCLUSION: The data at hand is insufficient to explain why HIV people have a higher QOL. It may be due to the fact that they are more likely to take risks to be happy. However, this needs to be verified by further research.

Keywords: hiv, Quality of life, (SF-36)

P-1126

High sensitive CRP and sICAM-1 can predict Major Adverse Cardiovascular Events in a large Turkish Population Based (MELEN) Study

Yasin Turker¹, Osman Kayapinar², Hilmi Demirin³, Recep Erozu⁴, Ali Kutlucan⁵, Yasemin Turker⁶, Cengiz Basar⁷, Feyzullah Besli⁷, Taner Ucgun⁸, Hakan Ozhan², Anzel Bahadır⁹, Davut Baltacı¹⁰

¹Department of Cardiology, Faculty of Medicine, Suleyman Demirel University, Duzce, Turkey

²Department of Cardiology, Faculty of Medicine, Duzce University, Duzce, Turkey

³Department of Biochemistry and Clinical Biochemistry, School of Medicine, Turgut Ozal University, Ankara, Turkey

⁴Department of Medical Genetics, Faculty of Medicine, Duzce University, Duzce, Turkey

⁵Department of Internal Medicine, Faculty of Medicine, Selcuk University, Konya, Turkey

⁶Family Medicine Center, Isparta, Turkey

⁷Department of Cardiology, Düzce Atatürk State Hospital, Düzce Turkey

⁸Department of Biochemistry and Clinical Biochemistry, Faculty of Medicine, Duzce University, Duzce, Turkey

⁹Department of Biophysics, Duzce University, Medical School, Duzce, Turkey

¹⁰Department of Family Medicine, Faculty of Medicine, Duzce University, Duzce, Turkey

Background & AIM: To evaluate the predictors of major adverse cardiovascular events (MACE) in a prospective population based study.

METHOD: This study included 153 participants aged >40 yrs with high and very high cardiovascular risk, and 50 participants aged >40 years with low cardiovascular risk according to the SCORE risk assessment. All the participants underwent a Doppler ultrasound examination of carotid intima media thickness (CIMT), echocardiographic examination, ECG recording and various biochemical analyses. High-sensitivity CRP (hsCRP) was measured with chemiluminescent immunometric assay, serum amyloid-A (SAA) protein, soluble intercellular

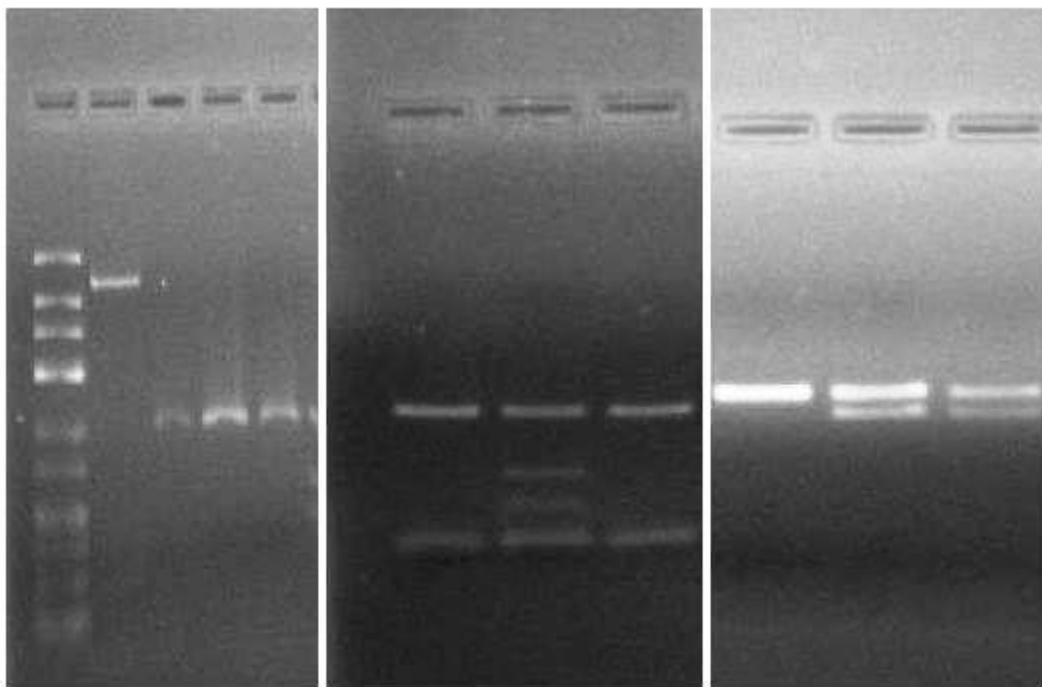
adhesion molecule-1 (sICAM), apolipoprotein-B (ApoB) were measured with ELISA method. eNOS single-nucleotide polymorphism was detected using polymerase chain reaction and restriction fragment length polymorphism methods (Figure 1). The follow-up was done 36 months after the baseline admission. MACE was defined as cardiovascular mortality or myocardial infarction or stroke.

RESULTS: Comparison of demographic, clinical characteristics and laboratory parameters among subjects with low risk SCORE and high risk SCORE were shown in Table 1 and 2. Comparison of demographic, clinical characteristics and laboratory parameters of subjects with and without MACE was shown in Table 3 and 4. Frequency of MACE was higher in high and very high risk group according to low risk group. There were no significant differences in eNOS gene polymorphisms between the risk groups and control subjects, and no significant association between eNOS gene polymorphisms and MACE was detected. Age, ejection fraction (EF), CIMT, hsCRP, ApoB, sICAM-1, and SAA protein levels were all significantly associated with MACE in univariate logistic regression analyses. Multivariate analyses revealed that age (OR:1.08, CI:1.02-1.15, p=0.013), EF (OR:0.94, CI:0.89-0.99, p=0.016), hsCRP (OR:1.36, CI:1.12-1.67, p=0.003) and sICAM-1 (OR:81.0, CI: 1.04-6320, p=0.048) levels were the only independent predictors of MACE (Table 5).

CONCLUSION: Higher age, hsCRP and sICAM-1 levels and lower EF were independent predictors of MACE.

Keywords: Major adverse cardiovascular events; SCORE risk; High-sensitivity C-reactive protein; soluble intercellular adhesion molecule-1; eNOS gene polymorphisms; serum amyloid-A protein; apolipoprotein-B

Figure 1



Agarose gel electrophoresis. Picture illustrating different eNOS gene genotypes by RFLP

Table 1. Comparison of demographic, clinical characteristics and frequencies of polymorphism of subjects according to SCORE risk.

	Low risk score (n=50)	High risk score (n=153)	P value
Mean age, years	55.5±5.4	69.1±8.0	<0.001
Female, n (%)	42 (84)	50 (32.7)	<0.001
BMI, kg/m ²	28.9±5.6	32.1±5.1	0.001
Active smoker, n (%)	7 (14)	84 (54.9)	<0.001

Hypertension, n (%)	34 (68)	115 (75.2)	0.320
Type II Diabetes Mellitus, n (%)	29 (58)	79 (51.6)	0.434
Obesity, n (%)	62 (40.5)	32 (64)	0.004
eNOS promoter (-786T/C) genotypes			
TT, n (%)	25 (50)	66 (43.1)	0.475
TC, n (%)	19 (38)	73 (47.7)	
CC, n (%)	6 (12)	14 (9.2)	
eNOS exon (894 G/T) genotypes			
GG, n (%)	28 (56)	103 (67.3)	0.116
GT, n (%)	20 (40)	49 (32)	
TT, n (%)	2 (4)	1 (0.7)	
eNOS intron (G10T) genotypes			
GG, n (%)	48 (96)	140 (91.5)	0.368
GT, n (%)	2 (4)	13 (8.5)	

BMI, body mass index; eNOS, endothelial nitric oxide synthase.

Table 2. Comparison of variables measured with ECG, echocardiography, ultrasonography, bioimpedance analysis and laboratory parameters among subjects with low risk score and high risk score.

	Low risk score (n=50)	High risk score (n=153)	P value
Systolic blood pressure, mmHg	133.3±21	144.3±27.9	0.004
Diastolic blood pressure, mmHg (Logarithmic transformed value)	82.2±12 (1.91±0.06)	84.3±14.8 (1.99±0.07)	0.482
Heart rate, bpm	77.6±12.7	72.3±12.4	0.010
LV mass, gr	220.8±51.4	251.4±78.0	0.010
Total cholesterol, mg/dL	181.9±37.9	193.1±42.7	0.093
LDL cholesterol, mg/dL (Logarithmic transformed value)	103.6±33.4 2.00±0.12	115.8±40.4 2.04±0.14	0.074
HDL cholesterol, mg/dL	41.7±11.2	41.8±12.0	0.984
Triglycerides, mg/dL (Logarithmic transformed value)	214.2±159.2 2.24±0.28	201.0±121.3 2.24±0.24	0.917
CIMT, mm (Logarithmic transformed value)	0.69±0.13 -0.18±0.08	0.78±0.30 -0.13±0.12	0.038
High CIMT (≥0.83), n (%)	11 (22)	59 (38.6)	0.032
High sensitive CRP, mg/L (Logarithmic transformed value)	1.92±1.56 0.148±0.360	2.65±2.58 0.272±0.375	0.042
Ejection Fraction, % (Logarithmic transformed value)	61.9±8.0 1.79±0.68	59.6±8.4 1.78±0.78	0.145
PR wave duration, ms	152.4±18.7	160.3±26.2	0.074
QRS wave duration, ms (Logarithmic transformed value)	87.3±8.5 1.94±0.14	97.5±17.9 2.00±0.71	<0.001
Corrected QT wave duration,ms	407±23.9	406±24.4	0.927
Corrected QT wave duration,ms	407±23.9	406±24.4	0.927
White blood cell	6.5±1.7	6.4±1.5	0.614
Hemoglobin, g/dl	13.1±1.1	13.2±1.5	0.452

Neutrophil/Lymphocyte ratio (Logarithmic transformed value)	1.77±0.84 0.205±0.193	1.92±0.96 0.241±0.196	0.252
Creatinine, mg/dL	0.79±0.19	0.91±0.26	0.002
Uric acid, mg/dL	4.1±1.1	4.6±1.4	0.026
SAA protein, µg/mL	114.7±86.6	165.3±98.7	0.001
Apolipoprotein B, mg/dL (Logarithmic transformed value)	94.3±43.8 1.89±0.39	135.4±51.5 2.09±0.26	<0.001
sICAM-1, ng/mL (Logarithmic transformed value)	0.115±0.042 -1.023±0.427	0.142±0.098 -0.917±0.240	0.031
MACE, n (%)	1 (2)	25 (16.3)	0.008

CIMT, Carotid Intima-Media Thickness; HDL, High-density lipoprotein; LDL, Low-density lipoprotein; LV, Left ventricular; MACE, Major adverse cardiac events; SAA, Serum amyloid A; sICAM, Soluble intercellular adhesion molecule-1.

Table 3. Comparison of demographic and clinical characteristics of subjects with and without major cardiac adverse events.

	No MACE (n=177)	MACE (n=26)	P value
Mean age, years	64.8±9.0	72.3±10.1	<0.001
Female, n (%)	82 (46.3)	10 (38.5)	0.452
BMI, kg/m ²	29.8±5.8	28.1±4.2	0.129
Active smoker, n (%)	79 (44.7)	12 (46.2)	0.968
Hypertension, n (%)	130 (73.4)	19 (73.1)	0.968
Type II Diabetes Mellitus, n (%)	98 (55.4)	10 (38.5)	0.107
Obesity, n (%)	86 (48.6)	8 (30.8)	0.089
SCORE risk (Logarithmic transformed value)	5.84±4.47 0.612±0.407	7.00±2.64 0.808±0.208	0.018
eNOS promoter (-786T/C) genotypes			
TT, n (%)	10 (38.5)	82 (46.3)	0.536
TC, n (%)	4 (15.4)	16 (9)	
CC, n (%)	79 (44.6)	12 (46.2)	
eNOS exon (894 G/T) genotypes			
GG, n (%)	115 (65)	16 (61.5)	0.555
GT, n (%)	60 (33.9)	9 (34.6)	
TT, n (%)	2 (1.1)	1 (3.8)	
eNOS intron (G10T) genotypes			
GG, n (%)	163 (92.1)	25 (96.2)	0.735
GT, n (%)	14 (7.9)	1 (3.8)	

BMI, body mass index; eNOS, endothelial nitric oxide synthase.

Table 4. Comparison of variables measured with ECG, echocardiography, ultrasonography, bioimpedance analysis and of biochemical variables among subjects with and without major cardiac adverse events.

	No MACE (n=177)	MACE (n=26)	P value
Systolic blood pressure, mmHg	141.6±27.3	141.3±23.3	0.956
Diastolic blood pressure, mmHg (Logarithmic transformed value)	84.1±14.3 1.92±0.07	81.5±13.1 1.91±0.08	0.384
Heart rate, bpm	73.2±12.3	76.5±14.9	0.218

LV mass, gr	272.0±94.9	239.8±69.1	0.097
Total cholesterol, mg/dL	184.1±44.3	191.7±41.2	0.462
LDL cholesterol, mg/dL (Logarithmic transformed value)	103.3±39.5 1.98±0.16	113.3±39.4 2.03±0.13	0.118
HDL cholesterol, mg/dL	39.7±12.3	42.0±11.6	0.565
Triglycerides, mg/dL (Logarithmic transformed value)	201.0±121.3 2.23±0.24	213.9±135.9 2.24±0.27	0.917
CIMT, mm (Logarithmic transformed value)	0.73±0.18 -0.15±0.10	0.96±0.53 -0.06±0.17	<0.001
High CIMT (≥0.83), n (%)	54 (30.5)	16 (61.5)	0.003
High sensitive CRP, mg/L (Logarithmic transformed value)	2.14 ±1.61 0.212±0.347	4.67 ±4.70 0.432±0.494	0.005
Ejection Fraction, % (Logarithmic transformed value)	60.7±7.6 1.78±0.07	56.5±11.8 1.74±0.11	0.016
PR wave duration, ms	156.7±23.0	169.3±32.8	0.071
QRS wave duration, ms (Logarithmic transformed value)	94.3±16.7 1.97±0.67	99.3±15.8 1.99±0.69	0.109
Corrected QT wave duration, ms	406±24.0	410±26.1	0.393
White blood cell	6.4±1.6	6.5±1.6	0.876
Hemoglobin, g/dL	13.3±1.4	12.9±1.5	0.232
Neutrophil/Lymphocyte ratio	1.8±0.89	2.0±1.1	0.395
Creatinine, mg/dL	0.89±0.26	0.90±0.16	0.662
BUN, mg/dL	36.2±10.9	38.3±9.8	0.354
Uric acid, mg/dL	4.4±1.3	4.9±1.7	0.067
SAA protein, µg/mL	145.6±97.8	202.2±86.2	0.006
Apolipoprotein B, mg/dL (Logarithmic transformed value)	120.8±51.6 2.01±0.32	155.6±50 2.17±0.15	0.021
sICAM-1, ng/mL (Logarithmic transformed value)	0.129±0.089 -0.96±0.31	0.181±0.076 -0.78±0.18	0.002

CIMT, Carotid Intima-Media Thickness; HDL, High-density lipoprotein; LDL, Low-density lipoprotein; LV, Left ventricular; MACE, Major adverse cardiac events; SAA, Serum amyloid A; sICAM, Soluble intercellular adhesion molecule-1.

Table 5. Results of univariate and multivariate Logistic regression analysis for prediction of MACE

	Univariate analysis			Multivariate analysis		
	OR	95% CI	P value	OR	95% CI	P value
Age	1.09	1.04-1.15	<0.001	1.08	1.02-1.15	0.013
EF	0.95	0.92-0.99	0.023	0.94	0.89-0.99	0.016
CIMT	13.2	2.29-76.5	0.004	2.88	0.41-20.2	0.287
HsCRP	1.39	1.18-1.65	<0.001	1.36	1.12-1.67	0.003
ApoB	1.013	1.005-1.021	0.002	1.01	0.99-1.02	0.073
sICAM-1	153	1.62-14609	0.03	81.0	1.04-6320	0.048

SAA 1.006 1.002-1.010 0.007

1.005

0.999-1.011 0.075

ApoB, Apolipoprotein B; CIMT, Carotid Intima-Media Thickness; EF, Ejection fraction; HsCRP, high-sensitivity C-reactive protein; MACE, Major adverse cardiac events; SAA, Serum amyloid A; sICAM, Soluble intercellular adhesion molecule-1.

P-1127

Medical student's motivation regarding research. Initial theory for a realist review

Louis Van Maele¹, Jean Macq¹, Sophie Leconte²

¹Institute of Health and Society (IRSS), Université catholique de Louvain, Belgium

²Academic Centre of General Practice (CAMG), Faculty of Medicine, Université catholique de Louvain, Belgium

BACKGROUND & AIM:

Promoting research in family medicine is essential for the future of our young discipline. While most difficulties are common amongst all medical specialties (i.e. supervision or competence development), some are specific to family medicine and still need to be explored, especially regarding motivational aspects. This study aims to provide a theoretical framework that could describe the mechanisms involved in students' motivation to engage in research activities, in order to explain which intervention works for whom and under what circumstances.

METHOD:

Respecting methodological guidelines for realist review, an initial program theory of student motivation regarding research has been developed by consulting field experts and by exploring the literature for existing theories. Selected theories have been compiled using an integrative model for the theories of motivation.

RESULTS:

The initial program theory points out the different factors that could influence student's motivation regarding research, which include his perception of the value of a research activity, his competence to achieve it and the control he has on it. A need of understanding and accomplishment, the kind of scientific objectives and the value granted to research could determine the student's motivation during the process of scientific creation. This dynamic model could finally be influenced by the society, his scientific community, his work and family environment.

CONCLUSIONS:

The initial theory presented in this communication is the first step of a realist review. The next steps include a literature review using realist logic and focused on existing interventions in order to refine the initial theory, and 3 case studies to apply the theory to the particularities of family medicine.

The refined theory -which could be translated into Context-Mechanism-Outcome configurations ("in this context, that mechanism generates this outcome") or guides for program development- will help faculties promote research activities among family medicine students.

Keywords: Research, Family Practice, Medical Education

P-1128

**Possibilities of knowledge circulation between neurodegenerative research and General Practice
(NEUROTRANS BMBF FZ 01GP1307)**

Markus Ludwig, Heinrich Herrmann¹, Astrid Eich Krohm¹, Bernt Peter Robra², Yvonne Marx¹, Julia Von Hintzenstern¹

¹Institute of General Practice and Family Medicine

²Institute of Social Medicine and Health Economics

Background & Aim

The NEUROTRANS project aims to build a sustainable knowledge transfer between GPs in Saxony-Anhalt and neuroscientists at the German Center of Neurodegenerative Disease Magdeburg (DZNE). The demographic challenge will dramatically increase the number of people with dementia over the next 30 years. GPs hold a key position in early detection of dementia because they are the first in the medical profession to realize changes in patients' behavior. However, very little is known how GPs detect and read those changes. Neuroscientists, on the other hand, are research focused and usually not connected with GPs' daily usual care. GPs make observations that can inform and contribute to research questions that would otherwise not be asked. At the same time, neuroscientists can inform GPs about the state of the research and how it might be helpful for their patients.

Method

The research design is based on a qualitative methodology by using semi-structured interviews and focus groups discussing case studies of patients with dementia. 36 GPs participated in qualitative interviews and different focus groups about their experiences in regards to early signs of dementia, tests and diagnosis, medications and counseling of patients and relatives. Qualitative interviews and observations of six leading neuroscientists provided insights into their work and their perspectives led to a professional exchange between both groups.

Results

Whereas GPs following a "life-world-perspective" are mostly concerned with the quality of life, neuroscientists based on a "biomedical-paradigm" conduct clinical research about brain functions and bio-markers with little attention paid to the daily situation of their research participants.

Conclusion

To foster a successful exchange between Neuroscientists and GPs joined research projects that focus on prevention and early detection of dementia promise to bridge the gap between the two groups and ultimately help to find solutions against dementia.

Keywords: General Practitioners, Dementia, Knowledge Transfer, Neuroscience, Family Medicine

P-1129

Medical students' attitude toward smoking in Poland & Kosovo

Sylwia Katarzyna Kalucka¹, Bashkim Gllareva²

¹The First Department of Family Medicine, Medical University, Poland, Lodz

²University of Prishtina' Hasan Prishtina' Faculty of Medicine in Kosovo.

Background and Aim. In 2030 about 8 million people will die because of smoking, and 80% of these deaths will take place in low and middle income countries. In Poland during last 25 years of political transformation were carried out preventive anti-smoking programs which decrease number smokers in society. Kosovo is at the beginning of the political transformation and we do not have complete data on the number of smokers in 2 million population. The aim of the study was an analysis of medical students' attitudes towards smoking in two different countries. Methods. A questionnaire on tobacco smoking was distributed among medical students of the last year at sixth year of their studies. Students who took part in this study, come from the Medical University of Lodz in Poland, English Foreign Division students (come from West European countries), and the Faculty of Medicine in Kosovo. Result. The study included 110 Polish medical students, 104 medical student from Kosovo, and 110 foreign medical student who study in Poland. In the Polish group were 8.2% active smokers, 70.9% non-smokers, 20.9 % ex-smokers. In the Kosovo group were 23.1% active smokers, 68.3% non-smokers, 8.6% ex-smokers. In the Foreign group were 18.6% active smokers, 63.7% non-smokers, 17.7% ex-smokers. There were statistically significant differences concerning two groups (Polish & Kosovo) of the subjects among active smokers, ex-smokers ($p < 0.0026$). There were no statistically significant differences between Kosovo & Foreign of the subjects among active smokers, ex-smokers, non-smokers ($p > 0.05$). Male students smoke cigarettes three times more often than female students ($p < 0.0001$). The average age of starting smoking among Kosovo students was 16,17 years, Polish students was 17,8 years, but for Foreign subjects was 18,07 years. Conclusions In XXI century medical students should have solid knowledge about smoking hazards, give up smoking in order to promote non-smoking among their patients in future.

Keywords: Tobacco, smoking, student

P-1130

Self-medication among cigarette smokers

Sylwia Kalucka

The First Department of Family Medicine, Medical University, Poland, Lodz

Background and Aim. It is estimated that in 2030 about 8 million people will die because of smoking, and 80% of these deaths will take place in low and middle income countries. Nowadays about 8 million Poles smoke cigarettes (30.3% of the total population aged 15 years and more). The aim of the study was analyze what methods smoking cessation using by chronic smokers cigarettes. Methods. The study randomly selected 323 people, who smoke cigarettes. The study group was divided into three subgroups according to number years of smoking. Among the participants were questions about the elements of use self- medication to quit smoking (chewing gum-Nicorette, nicotine patch, Tabex, Desmoksan, e-cigarette, tablets NiQuitin, motivation smoking cessation). Result. Among subjects (91 smokers) who smoke cigarettes only 10 years, chose the most often chewing gum (70), own motivation to quit smoking (79), e-cigarette (47). The group smokers (82 smokers) who smoke between 11 to 20 years, used the most often chewing gum (71), own motivation to quit smoking (50). This group smokers bought tablets NiQuitin, nicotine patch and Desmoksan the same often. The group smokers, who smoke cigarettes over 20 years, the most often use own motivation to smoking cessation than the other over-the-counter products. Over one year observation, only smokers, who had the highest motivation successful smoking cessation. Self-medication smokers, who bought over-the counter nicotine products after 3-4 weeks come back to smoking cigarettes. Conclusions. Self-medication among smokers willing to quit smoking nicotine replacement therapy for smoking cessation is not enough if a smoker does not have strong motivation.

Keywords: tobacco, smoking cessation, nicotine replacement therapy

P-1131

Disease knowledge level of the uncontrolled type 2 diabetes patients who were admitted to Internal Medicine Clinic of Adana Research and Training Hospital

Hicri Sarıçam¹, Kenan Topal¹, Aylin Karsandık Akyol¹, Çiğdem Gereklioğlu²

¹Adana Numune Training and Research Hospital, Department of Family Medicine, Adana/Turkey

²Baskent University Medical Faculty, Department of Family Medicine, Ankara/Turkey

BACKGROUND: We aimed to investigate the factors influencing the disease knowledge level of the patients with uncontrolled type 2 diabetes who admit to Internal Medicine Clinic.

MATERIAL-METHOD: This cross-sectional study was conducted with 71 uncontrolled type 2 diabetes patients between February 1 and May 15, 2015. Demographic characteristics, educational level, coexisting chronic diseases, diabetes complications, spot plasma glucose on admission, HbA1c levels were recorded. The Knowledge, Attitude, and Practice (KAP) Questionnaire was administered. Two independent samples t-test and chi-square tests were used for statistical analysis.

RESULTS: Mean age was 54.6 ±11.07 years, 37 patients were male (52.1%). Thirty nine (54.9%) patients had at least one comorbidity, 31 (43.7%) had at least one complication. Mean plasma glucose was 327.2±144.8 mg/dL, mean HbA1c was 11.05 ± 2.03. While ratio of the patients with low knowledge level was 35.2% (n=25), ratio of the patients with satisfactory knowledge was 64.8% (n=46). The highest score was among the graduates of high school or university ($\chi^2=8.8$, $p=0.012$). A significant difference was not found between gender and KAP scores ($t=0.14$, $p=0.989$). Ratio of the patients with high KAP scores was greater among the patients with less higher HbA1c (7.0-8.4%), (100%, n=6) compared to the patients with moderate (8.5-10.4), (%70.4, n=19) and very high HbA1c (≥ 10.5), (%55.3, n=21), ($\chi^2=4.8$, $p=0.028$). The ratio of the patients with high KAP scores was greater among the patients with less higher plasma glucose (154-195 mg/dL), (90%, n=9) compared to the patients with moderate (196-252 mg/dL), (%77.8, n=7) and very high plasma glucose (≥ 253 mg/dL), (%57.7, n=30), ($\chi^2=4.49$, $p=0.034$).

CONCLUSION: Disease knowledge level increased, plasma glucose regulation improved as educational level increased. Better education and having sufficient knowledge about the disease would improve the success of follow up and treatment.

Keywords: Uncontrolled, Type 2 Diabetes Mellitus, knowledge level,

P-1132

Assessment of screening tests in patients who were referred to pediatric endocrine outpatient clinic with suspicion of hypothyroidism

Süle Çalışkan¹, Kenan Topal¹, Çiğdem Gereklioğlu², Lena Türeyici¹, Yılmaz Kör³, Dilek Köse¹, Kayhan Süreyya Işgüzar¹

¹Adana Numune Training and Research Hospital, Department of Family Medicine, Adana/Turkey

²Baskent University Medical Faculty, Department of Family Medicine, Ankara/Turkey

³Adana Numune Training and Research Hospital, Department of Pediatrics, Adana/Turkey

BACKGROUND: Early diagnosis of congenital hypothyroidism is of great importance. We aimed to evaluate the screening tests done beginning from birth in the patients who were referred to Adana Research and Training Hospital in the context of newborn hypothyroidism screening program.

METHOD: This cross-sectional study was conducted with 424 cases between 1 June 2012 and 28 February 2015. TSH values tested with heel blood in the context of newborn hypothyroidism screening were compared with TSH values tested at Family Medicine Unit on day 7 and 14.

RESULTS: Of the patients, 241 (56.8%) were boys, the mean age of 19.7±8.4 days. Mean TSH of 375 newborns was 18.9±1.65 mIU/L and TSH was ≥ 5 mIU/L in 338 (90.1%), TSH was <5 mIU/L in 37 (9.9%). In Family Medicine Unit, mean TSH of 325 newborns was 26.4±2.07 mIU/L on day 7, TSH was ≥ 5 mIU/L in 323 (99.7%), TSH was <5 mIU/L in 1 (0.3%). On day 14, mean TSH of 172 newborns was 27.9±2.58 mIU/L and TSH was ≥ 5 mIU/L in 172 (100%). A statistically significant difference was found between TSH values tested at Family Medicine Unit and pediatric endocrine outpatient clinic ($r=0.594$, $p=0.00$ and $r=0.339$ and $p=0.00$). At pediatric endocrine outpatient clinic, mean TSH of 424 newborns was 18±30.3 mIU/L (min 0.19, max 150) TSH was ≥ 5 mIU/L pediatric endocrine

outpatient clinic in 216 (50.9%), TSH was <5 in 208 (49.1%). While sensitivity of screening test was 94% at birth, it was 98% on day 7 and 100% on day 14.

CONCLUSION: An ideal screening test should be inexpensive, non-invasive, clinically important, designed for the diseases which could lead to morbidity and mortality unless treated. Sensitivity of TSH screening tests done at Family Medicine Unit on day 7 and 14 was seen to be higher than test done at birth.

Keywords: Newborns, congenital hypothyroidism, screening, TSH

P-1133

The Relationship between the Perception of Individual Workload and Life Satisfaction among Medical Residents

Rana Gundogan, Kubra Uyar, Ozge Berfu Gurbuz, Ediz Yildirim, Dilek Guldal

Department of Family Medicine, Dokuz Eylul University, Izmir, Turkey

INTRODUCTION:

Workload perceived by one has a close relationship with the life satisfaction one has. In this study the relationship between the perception of individual workload and life satisfaction of the residents, and factors affecting these two parameters were examined.

METHOD:

Residents who work in Dokuz Eylul University Medical Faculty were chosen for this cross-sectional analytic designed study. Three different questionnaires were used. A survey including demographic features as well as Individual Workload Perception Scale (IWPS) and The Satisfaction with Life Scale (SWLS) were applied to the residents. Data was processed with SPSS 15.0 package program. Besides descriptive statistics, for constant variables t test and ANOVA, and for categorical variables chi-square tests were applied.

RESULTS:

48.3% of the 236 participants were women, 55.9% of them were from clinics of internal medicine, and 38.6% of them were from surgical clinics. The mean age was 28.5 years, and mean of their residency duration was 27.3 months.

There wasn't any difference with their IWPS and SWLS points regarding their gender, number of children, profession duration, residency duration, choice of specialty or age.

As the number of weekly work time and monthly on-call time increased IWPS and SWLS decreased ($r=-0.294$; $p=0.000$ and $r=0.256$; $p=-0.000$), ($r=-0.268$; $p=0.000$ and $r=-0.199$; $p=0.002$). There was a positive correlation between IWPS and SWLS scales ($r=0.386$, $p=0.000$).

IWPS and SWLS points of the ones who thought that specialty would affect their social lives very negatively ($p=0.000$, $p=0.000$), their health negatively ($p=0.000$, $p=0.000$) and their cultural lives negatively were significantly low ($p=0.000$, $p=0.000$).

CONCLUSION:

There is a significant relationship between the perception of individual workload and life satisfaction, work time and negative thoughts about future, affect both parameters negatively.

Keywords: Workload, personal satisfaction, internship and residency

P-1134**Our hospital health workers and Patients beliefs and behaviors related to breast self-examination**

Ayşe Mıdık Özpak, Ismail Arslan, Fatma Begüm Tokatlıoğlu Özcan, Adil Çetin, Gökhan Dinçer, Oğuz Tekin

Department of Family Medicine, Ankara Training and Research Hospital

BACKGROUND and AIM: Early diagnosis and effective implementation of the correct method of breast cancer is easier to treat cancer by ensuring early detection. Important place to introduce a simple and cost-free technique with early breast self examination. In this study, health professionals and breast cancer patients admitted to various clinics and beliefs regarding breast self examination, aimed to determine the attitudes and behaviors.

METHOD: Working 86 health professionals working in Ankara Training and Research Hospital and was conducted with 114 patients admitted to various clinics. Questionnaire including socio-demographic characteristics of the collection of data and the Champion's Health Belief Model scale is used.

RESULTS: 200 people participated in the study mean age of 33.16(+/-8.6). Health workers who have 87.2% of the 31.3% were housewives makes 30.3% of other professional groups working breast self examination(BSE). 78% of participants BSE and they learn in various ways related to breast cancer has been shown to be 22% of the tray information. Knowledge of BSE have no knowledge while 69.2% of which is only 4.5% do BSE. BSE and the non participants confidence/self-efficacy statistically significant difference was detected between the subscale mean scores ($p < 0.05$).

CONCLUSIONS: Individuals perceptions about breast cancer and breast self examination determines the attitudes and behaviors of individuals. Self-efficacy/confidence and that when he attempts to make a behavior is the belief that individuals can succeed. People of breast cancer and to increase the knowledge about BSE and confidence/self to strengthen the effectiveness of sense to move them into action in this regard to improve the BSE frequency of application, will enable them to be more sensitive to early diagnosis. In the training of health workers to be given to this issue in particular places patients should be expanded by transferring this information to.

Keywords: breast self examination, breast cancer, early diagnosis.

P-1135**Burnout status of medical students and affecting risk factors**

Kubra Can, Oguz Yilmaz, Tugba Onat, Ediz Yildirim, Dilek Guldal

Department of Family Medicine, Dokuz Eylul University, Izmir, Turkey

Introduction

Burnout is a common syndrome seen in healthcare workers, particularly physicians who are exposed to a high level of stress at work. The health care providers are supposed to be at a high risk for developing burn-out syndrome, due to their involvement in emotional stressful situations and intense collaboration with patients in difficult conditions. This situation may start during pupilage. In our study it is aimed to evaluate the burnout status of medical faculty students and risk factors affecting this.

Methods

In this descriptive cross-sectional study, as a first step, factors affecting education processes are determined by brain storming with students. At the end a consensus of 13 item questionnaire is used as a 5-point Likert scale. Mentioned questionnaire and Maslach Burnout Inventory are applied to Class 4, 5 and 6 students of Dokuz Eylul Medical School. SPSS Version 16.0 is used for all analyses. Descriptive statistics, independent sample t-test, ANOVA and correlation analysis are used.

Results

The total mean point of MBI is 67.00 ± 6.79 and mean points of subscales of MBI are 24.45 ± 4.98 (emotional exhaustion), 16.67 ± 3.35 (depersonalization) and 25.85 ± 4.66 (low personal accomplishment). Among 247 students, Grade 5 students have lower burnout level compared to Grade 4 and Grade 6 students (respectively,

p=0.,039 and p=0.001). Social drinkers have lower burnout level compared to non drinkers (p=0.044). The ones studying for longer hours daily have higher level of burnout (p=0.000). The ones who think to leave medical faculty before graduation, who tried to use drugs, who don't have spare time for social life have higher level of burnout (p values respectively 0.037; 0.028; 0.002). There is a statistically significant, positive and weak correlation between MBI and our questionnaire (r=0.183, p=0.004).

Conclusion

The burnout level of medical students is over median and closely related with training environment.

Keywords: professional burnout, medical students, risk factors

P-1136

Comparison of Changes in Anxiety and Depression Level between Dabigatran and Warfarin use in patients with Atrial Fibrillation Patients

Yasin Turker¹, Ismail Ekinozu², Seda Aytakin², Yasemin Turker³, Cengiz Basar⁴, Davut Baltaci⁵, Ertugrul Kaya⁶

¹Department of Cardiology, Faculty of Medicine, Suleyman Demirel University, Isparta, Turkey

²Department of Cardiology, Faculty of Medicine, Duzce University, Duzce, Turkey

³Family Medicine Center, Isparta, Turkey

⁴Department of Cardiology, Düzce Atatürk State Hospital, Düzce Turkey

⁵Department of Family Medicine, Faculty of Medicine, Duzce University, Duzce, Turkey

⁶Department of f Pharmacology, Duzce University, Medical School, Duzce, Turkey

AIM: We hypothesized that patients taking warfarin require frequent hospital follow-up and they are at higher risk for complications, so the incidence of depression and anxiety is higher in AF patients in the period of taking warfarin compared to the period of taking dabigatran.

METHODS: Fifty AF patients without valvular diseases under treatment of warfarin in whom a transition to dabigatran was planned were consecutively enrolled in this study and followed up prospectively between July 2013 and July 2014. All patients completed Beck Depression Inventory (BDI) and Hamilton Anxiety Scale (HAS) at the initiation of study and after six months after initiation of study. Of the subjects enrolled in the study, age, gender, smoking status and comorbidities, history of bleeding and transfusion were questioned.

RESULTS: A total of 50 subjects (28 woman; mean age 74.6±8.7 years) treated with warfarin in whom a transition to dabigatran were included. Table 1 shows basic demographic and clinical characteristics of study patients.

Table 2 gives comparison of mean values of BDS and HAS in patients before and after switching from warfarin to dabigatran. Basal mean value of BDS (24.4±11.9 vs 19.1±8.9, p<0.001) and HAS (18.7±12.5 vs 13.8±9.2, p<0.001) were significantly higher in subjects while they have used warfarin than while they were switched to dabigatran.

In categorical analysis, frequency of patients with depression (mild, moderate and severe) was significantly higher in period of warfarin use than after dabigatran transition (n= 24, 48% versus n=14, 28%, p=0.039).According to BDS categories, comparison of depression level between period of warfarin and dabigatran use was shown in Table 3.

CONCLUSION: Dabigatran decreases the score of BDS and HAS compared to warfarin in nonvalvular AF. These findings suggest that, dabigatran may increase quality of life and decrease morbidity and mortality due to reduction of anxiety and depression.

Keywords: Anxiety; Depression; Warfarin; Dabigatran

Table 1. Demographic and clinical characteristics of study participants.

Categorical Variables	Study Population (n, %)
Male, n (%)	28 (56)
Active smoker, n (%)	3 (6)
Hypertension, n (%)	37 (74)
Diabetes Mellitus, n (%)	12 (24)

Obesity, n (%)	9 (18)
Hyperlipidemia, n (%)	18 (36)
Coronary Artery Disease, n (%)	25 (50)
Continues Variables	Mean ± Standard Deviation
Mean age, years	74.6±8.7
Systolic blood pressure (mmHg)	127.1±15.6
Diastolic blood pressure (mmHg)	74.3±11.2
Heart Rate, beats/min	76.9±10.4
Hemoglobin (g/dl)	13.9±1.5
Fasting glucose (mg/dl)	103.9±14.9
Blood urea nitrogen (mg/dl)	18.8±4.7
Creatinine (mg/dl)	0.98±0.21
Thyroid stimulating hormone (mg/dl)	1.12±0.77
Ejection Fraction	55.1±6.7
Left Atrium	47.3±3.9

Table 2. Comparison of BDS, HAS and frequency of depression in study patients between while warfarin used and while dabigatran used.

	Warfarin 5 mg	Dabigatran 150 mg	P Value
BDS	15.6±7.8	11.5±4.8	<0.001
HAS	16.8±10.4	12.6±8.1	<0.001
Depression, n (%)	24 (48)	14 (28)	0.039

BDS; Beck Depression Scale, HAS; Hamilton Anxiety Scale.

Table 3. Comparison of depression level between warfarin and dabigatran.

	Depression level				P Value
	No	Mild	Moderate	Severe	
Warfarin, n (%)	26 (52)	4 (8)	18 (36)	2 (4)	0.017
Dabigatran n (%)	36 (72)	4 (8)	10 (20)		

P-1137**" Turkish reliability and validity study of Physical activity barriers questionnaire "**

Gurcan Balik¹, Gamze Akyol¹, Dilek Guldal¹, Irfan Yurdabakan²

¹Department of Family Medicine, Dokuz Eylul University, Izmir, Turkey

²Department of Educational Sciences, Dokuz Eylul University, Izmir, Turkey

"INTRODUCTION:

Lack of exercise, which is a shared risk factor for many chronic diseases, comes fourth reason among the risk factors which cause death worldwide. The prevalence of physical inactivity changes between %28 and %81 worldwide. Besides prevalence of physical inactivity is between 87% with women and 77% with men in Turkey. At this context, it is important to examine the obstacles that the young adults in Turkey face which prevent them from having physical activities. However there isn't a scale in Turkish to use for this area. The aim of this study is to find out reliability and validity of "physical activity barriers questionnaire" which was developed by Suraya and his friends in Malaysia.

METHOD:

After a translation and retranslation, the scale was applied to 150 patients and their relatives who were between the ages of 18-45. The data was analyzed in SPSS 15 package program; for the validity of the scale Factor analysis, for the reliability of the scale Tukey test, Hotelling's T test, Split half and Cronbach α analyses were used.

RESULTS:

52% of the sample was male (n: 78) and 48% was female (n: 72). Minimum age was 18 (n: 2), maximum age was 45 (n: 2); the mean age was 32.7 and the median was 34. KMO Bartlett test was found to be 0.840, F value of the Tukey test was 18.5 (p=0.000) and the F value of Hotelling's T test was 9.6 (p=0.000). Split half Spearman-brown value was 0.909, Cronbach α value was 0.874 and when the questions were evaluated one by one; the minimum Cronbach α value was 0.863 and the maximum was 0.876.

CONCLUSION:

The analyses made show that "physical activity barriers questionnaire" is both very highly reliable and valid in Turkish."

Keywords: physical activity barriers questionnaire, physical activity barriers, physical activity, Turkish reliability and validity, lack of exercise, young adults

P-1138**Knowledge and attitudes of patients about organ donation**

Gülay Şahin¹, Mustafa Kürşat Şahin², Füsün Aysin Artıran İğde¹, Mustafa Fevzi Dikici¹, Füsün Yarış¹

¹Department of Family Medicine, Ondokuz Mayıs University, Samsun, Turkey

²Canik Community Health Center, Samsun Turkey

Background & AIM: Organ transplantation is the most preferred treatment modality for end-stage organ diseases. The need for the transplants is higher than the availability. Prerequisites for the success of transplantation program include awareness and positive attitudes. This descriptive study was planned and applied to assess the knowledge and attitudes of patients who admitted to our clinic.

METHOD: Data were collected by the researcher, applying face-to face structured interview techniques with a questionnaire developed after a relevant literature review. Data were analyzed using SPSS 22.0 package program. In the analysis, frequency and percentage from descriptive criteria were used.

RESULTS: 109 patient participated our study. There were 68 (62.4%) female and 41 (37.6%) male. The average age of patient was 26.26 \pm 9.99 year. 68 (62.4%) of patients didn't want to donate organs. The decision to be an organ donor was influenced by relational ties, religious beliefs, cultural influences, family influences (15.6%), body integrity (15.6%), previous interactions with the health care system—medical mistrust, validity of brain death and fear of early organ retrieval (20.2%).

CONCLUSIONS: Patients have significant gaps in knowledge regarding the organ donation and transplantation system. Donation and transplantation education is necessary for community.

Keywords: organ donation, attitudes, knowledge, transplantation

P-1139

The relationship between self-rated health and periodic health examination in Samsun, Turkey

Mustafa Kürşat Şahin¹, Mustafa Fevzi Dikici²

¹Canik Community Health Center, Samsun, Turkey

²Department of Family Medicine, Ondokuz Mayıs University, Samsun, Turkey

AIM: To evaluate the relationship between demographic and medical status of the adults admitted to OMU School of Medicine Department of Family Medicine for the Periodic Health Examination between 2012- 2013 and their own "self-assessment of health".

METHOD: Total 274 Periodic Health Examination forms of the people admitted to department outpatient clinic between 01.01.2012-31.12.2013 were screened retrospectively. Data were processed using SPSS 22.0 for Windows. Data were evaluated as number and percentages, statistical significance was analyzed using t test, chi-square test and the Mann-Whitney U test. Statistical significance was considered at $p < 0.05$.

RESULTS: Of the 274 patients, 138 were women (50.4%) and 136 were men (49.6%). The mean age was 44.48 ± 15.72 years. Of the women, 95 (68.8%) and 70 of the men (51.5 %) had not exercised. In the patient group, body mass index of 159 (66.6%) was higher than 25 kg/m² and women had significantly higher body mass index than men. Total 75 (54.3%) women and 39 (28.7%) men had psychiatric disorders. Among these patients, 34 women (24.6%) and 17 men (12.5%) had a psychiatric drug use. history of psychiatric illness. Psychiatric illness history ($p < 0.001$) and psychiatric drug use ($p: 0.010$) was significantly higher in women than in men. Of the 90 women over 40 years, 66 (73.3%) had mammography. One patient was diagnosed with breast cancer. Of the participants, 113 (41.3%) stated that their general health status was poor. Women's self-assessment of health was significantly worse.

CONCLUSION: More than half of the participants had not exercised and were overweight or obese. As a result of cancer screening, a patient with breast cancer was detected. More than half of women had a psychiatric illness while one in four of the men had. Self-assessment of women and people with psychiatric disorders was significantly worse.

Keywords: Family practice, periodic health examination, preventive health service, self-assessment of health status.

P-1140

What patients want from their family physician?

Mustafa Kürşat Şahin¹, Gülay Şahin², Mustafa Fevzi Dikici², Füsün Aysin Artiran Iğde², Füsün Yarış²

¹Canik Community Health Center, Samsun, Turkey

²Department of Family Medicine, Ondokuz Mayıs University, Samsun, Turkey

Background &AIM: The public wants and is satisfied by care provided within a patient-physician relationship based on understanding, honesty, and trust. If the Turkey health care system is ever to become patient-centered, it must be designed to support these values and sustain, rather than fracture, the relationships people have with their primary physician. We aimed to evaluate the expectations of the patient's from family physician.

METHOD: The data were collected from 126 patients between 1st -31st March 2014 who admitted to family medicine clinic. In this study, by reading the relevant literature and requirement on the research, we prepared to questionnaire. Data were analyzed using SPSS 22.0 package program. In the analysis, frequency and percentage from descriptive criteria were used.

RESULTS: There were 65 (51.6%) male and 61 (48.4%) female patients. The average age of participants was $32,23 \pm 12,62$ year. Patients wanted who was nonjudgmental(120/126), understanding (126/126), and supportive(126/126); honest and direct; acts as partner in maintaining health (112/126); listens effectively (121/126); and attends to patients' emotional and physical health (111/126)

CONCLUSIONS: Even though patients and physicians are frustrated by the healthcare system, the research showed that patients seem to want the same things WONCA's criteria.

Keywords: family physician, perception, patient, WONCA

P-1141

Views And Opinions of the Students of Dumlupınar University about Family Medicine

Yasemin Korkut, Emre Ayaz

Department of Family Medicine, Dumlupınar University, Kütahya, Turkey

Aim

The aim of this research is to find out the thoughts of the university students, studying at Dumlupınar University, about family medicine practice and to evaluate their point of views.

Materials and Methods

Our research is a cross sectional survey on university students between the ages of 19-25 studying at Dumlupınar University in Kutahya. It was conducted between April-May in 2015. The questionnaire was completed by the participants who were selected by random sampling.

Results

The average age of the 107 students participating the study was 21.8 ± 1.4. When the participants were questioned about their level of knowledge about family medicine; 39% of them was at high level and 61% of them was at the medium or low level. When their satisfaction on the applied family medicine was inquired; 69% of them were not satisfied. 24% of them were unsatisfied because of the inadequate number of family physicians and the 17% was because of the lack of time devoted to the patients. Only 4.2% of the students thought that the application of the family medicine was very good.

Conclusions

As a result of our study, it was observed that practicing of family medicine is not known by the University students and probably for this reason when they go to an outpatient clinic they don't have a high level expectation. Consequently, informing the youngs about the the system of family medicine which has been adopted for almost five years need to be developed.

Keywords: Family Medicine, Student, Evaluate

P-1142

The World and you: An evaluation of Twitter use at a recent international family medicine conference

Kyle Hoedebecke¹, Andrea De Angulo²

¹Wonca Polaris, USA

²Waynakay, Colombia

BACKGROUND: The use of social media within medicine has increased every year. Yet, few publications exist describing its daily use or benefit to the medical community across the world. No peer-reviewed literature exists identifying the use of Twitter within WONCA or within Latin America.

METHODS: A literature search using PubMed resulted in only 13 results using "Twitter" and "Family Medicine." Furthermore, only one of these described the use of Twitter at a Family Medicine conference - the 2013 Society of Teachers of Family Medicine conference in the United States. Using the online tool Sympur, the authors have evaluated the Twitter use at the recent WONCA Iberoamerican Conference in Montevideo, Uruguay where the hashtags #4cwic and #waynakay2015 were used. The results were compared to other conferences.

RESULTS: The hashtag #4cwic had 4129 tweets from 551 users: 36.1% of the conference participants. The hashtag #waynakay2015 had 387 tweets from 72 users: 45% of the preconference participants. The top ten users were responsible for 69.2% of the activity of #waynakay2015 and 58.6% of that of #4cwic.

Conclusions: This is the first study to evaluate Twitter use in Iberoamerica as well as in a WONCA conference and has allowed for the evaluation of overall activity, major influencers, and for potential future uses within medicine for both academic and social purposes. Continued research is needed to further develop and identify uses of sites like Twitter or Facebook.

Keywords: Social Media, Young Doctor Medicine, Twitter, Polaris, Waynakay

P-1143**Effects of 25(OH) Vitamin D Levels on HbA1C Levels in an Elderly Population with Type 2 Diabetes Mellitus**

Uğur Bilge¹, Murat Ünalacak², Ahmet Keskin³, Pınar Yıldız⁴, Seda Güler⁵, Muzaffer Bilgin⁶

¹Uğur Bilge: Eskişehir Osmangazi University Faculty of Medicine Department of Family Medicine, Eskişehir, Turkey

²Murat Ünalacak: Hacettepe University Faculty of Medicine Department of Family Medicine, Ankara, Turkey

³Ahmet Keskin: Yıldırım Beyazıt University Faculty of Medicine Department of Family Medicine, Ankara, Turkey

⁴Pınar Yıldız: Eskişehir Osmangazi University Faculty of Medicine Department of Internal Medicine, Eskişehir, Turkey

⁵Seda Güler: Eskişehir Osmangazi University Faculty of Medicine Department of Family Medicine, Eskişehir, Turkey

⁶Muzaffer Bilgin: Eskişehir Osmangazi University, Faculty of Medicine, Department of Biostatistics and Medical Informatics, Eskişehir, Turkey

AIM: Our aim was to evaluate the potential effect of 25 (OH) levels on HbA1C levels in a population which were 65 years and older with type 2 diabetes mellitus (DM).

RESULTS: A total of 106 people were participated in the study (36 men and 65 women). The mean of vitamin D (VD) values is $18,65 \pm 14.17$ ng/ml and mean of HbA1c levels is 7.45 ± 1.42 . Vitamin D insufficiency was defined as serum 25-hydroxyvitamin D level of <30 ng/ml. The target value for HbA1c levels was accepted as below %7. Vitamin D deficiency was found in %80.0 of our patients. We found an inverse correlation between HbA1c and vitamin D levels ($p=0.001$). HbA1C levels were significantly high in the group with 25OH VD deficiency (7.62 ± 1.47 vs 6.77 ± 0.92 ; $p=0.011$). In 25OH VD deficient group; rate of having target HbA1C values was significantly low (% 41.2 vs %65; $p=0.094$).

DISCUSSION: VD deficiency is more common in the elderly population. VD deficiency seems to be a negative factor affecting the control of type 2 DM. This subject should be evaluated by different studies.

Keywords: Vitamin D, HbA1C, Elderly Population, Type 2 Diabetes Mellitus

P-1144**Inappropriate Nonsteroidal Anti-Inflammatory Drug Use Among Elderly According To STOPP Criteria**

Gamze Akyol, İlke Ekim Yardım, Candan Kendir Çopurlar, Tuğba Onat, Tolga Günvar, Dilek Güldal

Department of Family Medicine, Dokuz Eylül University, Izmir, Turkey

BACKGROUND & AIM:

Inappropriate nonsteroidal anti-inflammatory drug (NSAID) use among persons ≥ 65 years of age is a common health problem worldwide, and causes various preventable adverse effects. Several studies have shown that inappropriate NSAID use (INU) rates are between 11.2% and 20.1% among older adults and their knowledge of NSAIDs is considerably low. Our objective is to determine the frequency of INU among elderly and to investigate related factors.

METHODS:

A cross-sectional study was conducted in 5 different Family Health Centers in Balçova district of Izmir. Questionnaires which included demographic data, questions regarding adverse effects and questions related to STOPP criteria for NSAIDs were conducted by the researchers with face-to-face interview method. All data analyses were performed using IBM SPSS software (version 22.0).

RESULTS:

412 participants with mean age of 71.57 (SD: ± 5.92) were included, 223 (54.1%) of them were women. 225 (%54.6) of all participants reported that they prefer to use NSAIDs for their pain. 61 (14.8%) participants had INU when "moderate/severe hypertension (MSH)" was excluded as a criteria for INU; this number went up to 90 (21.8%) when MSH was included. Age, sex, educational level and knowledge about side effects except for "allergy" ($p<0.05$) and "stomach-ache" ($p=0.001$) were not significantly related to INU. To have a specific preference of a NSAID for pain ($p<0.05$) and using painkillers / NSAIDs in the last week ($p<0.05$ / $p<0.001$; respectively) were significantly related to INU.

CONCLUSION:

Under the guidance of STOPP criteria, this study highlights inappropriate NSAID use in Izmir, Turkey.

Keywords: nonsteroidal anti-inflammatory drugs, NSAIDs, inappropriate drug use, STOPP criteria, elderly, knowledge

Inappropriate Nonsteroidal Anti-Inflammatory Drug Use (INU) Rates & Related Factors (1)

	<i>Inappropriate NSAID use (Including MSH)</i>		<i>p value</i>	<i>Inappropriate NSAID use (Excluding MSH)</i>		<i>p value</i>
	<i>Yes (%)</i>	<i>No (%)</i>		<i>Yes (%)</i>	<i>No (%)</i>	
Income status perception compared to expenditure						
Income < Expenditure	26 (%28.9)	70 (%21.7)	0.156	21 (%34.4)	75 (%21.4)	0.026
Income ≥ Expenditure	64 (%71.1)	252 (%78.3)		40 (%65.6)	276 (%78.6)	
Name of the drug used for pain						
Acetylsalicylic acid / Aspirin	6 (%6.7)	14 (%4.3)	< 0.001	5 (%8.2)	15 (%4.3)	< 0.001
Paracetamol	0 (%0)	112 (%34.8)		0 (%0)	112 (%31.9)	
NSAID	84 (%93.3)	121 (%37.6)		56 (%91.8)	149 (%42.4)	
Other	0 (%0)	3 (%0.9)		0 (%0)	3 (%0.9)	
"I don't know its name"	0 (%0)	72 (%22.4)		0 (%0)	72 (%20.5)	
Having a specific drug preference for pain						
"I have a specific preference."	65 (%72.2)	184 (%57.1)	0.01	44 (%72.1)	205 (%58.4)	0.043
"I don't have a specific preference"	25 (%27.8)	138 (%42.9)		17 (%27.9)	146 (%41.6)	
Any kind of painkillers taken in the last week						
Yes	48 (%53.3)	130 (%40.4)	0.028	40 (%65.6)	138 (%39.3)	< 0.001
No	42 (%46.7)	192 (%59.6)		21 (%34.4)	213 (%60.7)	
Taking NSAIDs in the last week:						
Yes	44 (%48.9)	91 (%28.3)	< 0.001	36 (%59)	99 (%28.2)	< 0.001
No	46 (%51.1)	231 (%71.7)		25 (%41)	252 (%71.8)	
Do you think painkillers have any kind of side effects or do any harm?						
Yes	75 (%83.3)	293 (%91)	0.038	50 (%82)	318 (%90.6)	0.044
No / I don't know.	15 (%16.7)	29 (%9)		11 (%18)	33 (%9.4)	
Do you think painkillers harm your organs or have any side effects that may permanently damage your organs?						
Yes	61 (%67.8)	213 (%66.1)	0.772	41 (%67.2)	233 (%66.4)	0.899
No / I don't know.	29 (%32.2)	109 (%33.9)		20 (%32.8)	118 (%33.6)	
Do you think painkillers have life-threatening side effects?						
Yes	34 (%37.8)	124 (%38.5)	0.900	26 (%42.6)	132 (%37.6)	0.457
No / I don't know.	56 (%62.2)	198 (%61.5)		35 (%57.4)	219 (%62.4)	
Do you think painkillers may interact with other drugs? (e.g. increase or decrease other drugs' activity)						
Yes	36 (%40)	162 (%50.3)	0.083	27 (%44.3)	171 (%48.7)	0.520
No / I don't know.	54 (%60)	160 (%49.7)		34 (%55.7)	180 (%51.3)	
Have you ever felt any discomfort after taking a painkiller?						
Yes	15 (%16.7)	80 (%24.8)	0.103	10 (%16.4)	85 (%24.2)	0.181
No / I can't remember.	75 (%83.3)	242 (%75.2)		51 (%83.6)	266 (%75.8)	

Demographic variables except for "income status perception when compared to expenditure" were not significantly related to INU; when "moderate/severe hypertension (MSH)" was excluded as a criteria for INU.

Inappropriate Nonsteroidal Anti-Inflammatory Drug Use (INU) Rates & Related Factors (2)

	Inappropriate NSAID use (Including MSH)		p value	Inappropriate NSAID use (Excluding MSH)		p value No (%)
	Yes (%)	No (%)		Yes (%)	No (%)	
Which of these side effects may occur when painkillers are used for a long period of time?						
<i>Headache</i>						
Yes	3 (%3.3)	11 (%3.4)	0.969	3 (%4.9)	11 (%3.1)	0.478
No	87 (%96.7)	311 (%96.6)		58 (%95.1)	340 (%96.9)	
<i>Gastro disorders</i>						
Yes	68 (%75.6)	277 (%86)	0.017	46 (%75.4)	299 (%85.2)	0.056
No	22 (%24.4)	45 (%14)		15 (%24.6)	52 (%14.8)	
<i>Stomachache</i>						
Yes	28 (%31.1)	163 (%50.6)	0.001	16 (%26.2)	175 (%49.9)	0.001
No	62 (%68.9)	159 (%49.4)		45 (%73.8)	176 (%50.1)	
<i>Nausea</i>						
Yes	20 (%22.2)	81 (%25.2)	0.567	15 (%24.6)	86 (%24.5)	0.988
No	70 (%77.8)	241 (%74.8)		46 (%75.4)	265 (%75.5)	
<i>Agreeing with at least one of the gastrointestinal side effects</i>						
Yes	69 (%76.7)	278 (%86.3)	0.026	47 (%77)	300 (%85.5)	0.096
No	21 (%23.3)	44 (%13.7)		14 (23)	51 (%14.5)	
<i>Agreeing with all 3 gastrointestinal side effects (gastro disorders, stomachache and nausea)</i>						
Yes	19 (%21.1)	80 (%24.8)	0.464	14 (%23)	85 (%24.2)	0.831
No	71 (%78.9)	242 (%75.2)		47 (%77)	266 (%75.8)	
<i>Paresthesia / Formication, "pins and needles"</i>						
Yes	0 (%0)	11 (%3.4)	0.076	0 (%0)	11 (%3.1)	0.161
No	90 (%100)	311 (%96.6)		61 (%100)	340 (%96.9)	
<i>Allergies / Allergic skin manifestations</i>						
Yes	27 (%30)	136 (%42.2)	0.036	15 (%24.6)	148 (%42.2)	0.010
No	63 (%70)	186 (%57.8)		46 (%75.4)	203 (%57.8)	
<i>Kidney disorders / failure</i>						
Yes	50 (%55.6)	160 (%49.7)	0.325	35 (%57.4)	175 (%49.9)	0.278
No	40 (%44.4)	162 (%50.3)		26 (%42.6)	176 (%50.1)	
<i>Liver disorders / failure</i>						
Yes	34 (%37.8)	154 (%47.8)	0.091	25 (%41)	163 (%46.4)	0.430
No	56 (%62.2)	168 (%52.2)		36 (%59)	188 (%53.6)	
<i>Blood disorders</i>						
Yes	1 (%1.1)	16 (%5)	0.104	1 (%1.6)	16 (%4.6)	0.290
No	89 (%98.9)	306 (%95)		60 (%98.4)	335 (%95.4)	
<i>Elevated blood pressure</i>						
Yes	18 (%20)	89 (%27.6)	0.144	10 (%16.4)	97 (%27.6)	0.065
No	72 (%80)	233 (%72.4)		51 (%83.6)	234 (%72.4)	
<i>Cardiac disorders</i>						
Yes	17 (%18.9)	61 (%18.9)	0.991	11 (%18.0)	67 (%19.1)	0.846
No	73 (%81.1)	261 (%81.1)		50 (%82)	284 (%80.9)	
<i>Asthma-like symptoms / Shortness of breath</i>						
Yes	2 (%2.2)	10 (%3.1)	0.660	2 (%3.3)	10 (%2.8)	0.854
No	88 (%97.8)	312 (%96.9)		59 (%96.7)	341 (%97.2)	
<i>Other</i>						
Yes	2 (%2.2)	14 (%4.3)	0.356	1 (%1.6)	15 (%4.3)	0.326
No	88 (%97.8)	308 (%95.7)		60 (%98.4)	336 (%95.7)	
<i>None</i>						
Yes	12 (%13.3)	30 (%9.3)	0.266	8 (%13.1)	34 (%9.7)	0.414
No	78 (%86.7)	292 (%90.7)		53 (%86.9)	317 (%90.3)	

P-1145**Investigation Of Blood Biomarkers And Other Risk Factors Associated With Mild Cognitive Impairment Among Turkish Type 2 Diabetic Patients**

Aclan Ozder, Zeyneb Irem Yuksel Salduz, Mesut Bilginc, Zeynep Bakir

Department of Family Medicine, Bezmi Alem Vakif University, Istanbul, Turkey

Background & AIM: Diabetes mellitus is a common metabolic diseases associated with an increased risk of mild cognitive impairment (MCI) and dementia (1,2). The aim of this study was to determine the relationship between some risk factors and cognitive function in patients with type 2 diabetes mellitus (Type 2 DM).

METHOD: A total of 101 adults with Type 2 DM were included to study. The exclusion criteria were diagnosed depression or dementia. The Montreal Cognitive Assessment (MoCA) and the Standardized Mini-Mental State Examination (SMMSE) were used for cognitive function assessment. Functional information on daily activities was collected using Katz Basic Activities of Daily Living (BADL) and Lawton Instrumental Activities of Daily Living (IADL) questionnaires. Fasting blood glucose (FBG), Urea, Blood urea nitrogen (BUN), Creatinine, C-reactive protein (CRP), High-density lipoprotein (HDL), Low-density lipoprotein (LDL), Total cholesterol (TC), Triglyceride (TG), Alanine aminotransferase (ALT) and Glycated hemoglobin (HbA1c) levels were measured in all subjects.

RESULTS: The prevalence of MCI in diabetic patients was 78.2%. Type 2 diabetic patients with MCI were older and 56 (70.8%) subjects were female. The background characteristic of MCI in diabetic patients included lower education level and monthly income, longer duration of diabetes, higher rate of current smoking and use of anti-hypertensive drugs, also higher serum level of HDL (Table 1).

CONCLUSIONS: According to our findings, MCI in type 2 DM patients has a high prevalence, especially influenced by demographic variables. Early detection and appropriate management of diabetes in primer health care seems to reduce the risk of MCI.

1-Koekkoek, Paula S., et al. "Cognitive function in patients with diabetes mellitus: guidance for daily care." *The Lancet Neurology* 14.3 (2015): 329-340.

2-Strachan, Mark WJ, et al. "Cognitive function, dementia and type 2 diabetes mellitus in the elderly." *Nature Reviews Endocrinology* 7.2 (2011): 108-114.

Keywords: Diabetes Mellitus, Type 2; Mild Cognitive Impairment; Risk Factors

Table 1

	Type 2 diabetes with MCI	Type 2 diabetes mellitus without MCI	P value
Number of patients (%)	79 (78,2)	22 (21.8)	
Age (years±SD)**	60,4±11,2	52±7,6	0.001
Sex (male/female)**	23/56	16/6	0.001
Marital status (single/married)	21/58	4/18	0.422
Education (no school graduation/graduation)**	23/56	0/22	0.004
Monthly income (high/low)**	32/47	16/6	0.008
Current smoking*(%)	12(15,2)	8(36,4)	0.028
Social alcohol drinking (%)	3(3,8)	0	0.356
BMI (kg/m ²)	31,3±6,5	30,6±5,6	0.432
Duration of diabetes (years)**	11,5±8,5	6,5±6,2	0.002
Use of oral anti-diabetic drugs (%)	70(88,6)	20(90,9)	0.76
Use of insulin (%)	28(35,4)	7(31,8)	0.753
Use of antihypertensive drugs*(%)	51(64,6)	5 (22,7)	0.01

Use of lipid lowering medications (%)	17(21,5)	1(4,5)	0.067
Nephropathy (%)	20(25,3)	6(27,3)	0.853
Retinopathy (%)	5(6,3)	1(4,5)	0.755
FBG (mean± SD)(mg/dl)	168,1±66,8	194±86,3	0.228
Urea (mean± SD)(mg/dl)	33,5±12,6	31,6±11,1	0.545
BUN (mean± SD) (mg/dl)	15,6±5,9	14,8±5,2	0.545
Creatinine (mean± SD) (mg/dl)	0,8±0,2	0,8±0,1	0.474
CRP (mean± SD) (mg/dl)	0,8±1	0,6±0,8	0.639
HDL (mean± SD) (mg/dl)*	49,6±14,1	42,5±12,6	0.019
LDL (mean± SD) (mg/dl)	122,8±32,6	120,5±27,8	0.843
TC (mean± SD)(mg/dl)	199,9±45,5	208,5±93,4	0.554
TG (mean± SD)(mg/dl)	166,9±157,6	286,9±517	0.225
ALT (mean± SD)(U/L)	22,2±14,6	26,2±15,9	0.21
HbA1c (mean± SD) (%)	8,1±1,8	8,9±2	0.124

** p<0.001

*p<0.05

Demographic features and blood biomarker levels of Type 2 diabetic patients with and without MCI.

P-1146

What we can change in young people health?

Maria Malarska¹, Paulina Pachniak¹, Michał Podgórski², Michał Matyjaszczyk¹, Przemysław Kardas¹

¹Department of Family Medicine, Medical University of Lodz, Lodz, Poland

²Human Anatomy Collegium Anatomicum, Medical University of Lodz, Lodz, Poland

What we can change in young people health?

Self-examination in Poland is still the taboo subject. Young people want to know but they don't know where they can find this information. In our study we talk with almost 1500 people and sent our questionnaire to 500 girls and boys. Conversation with them open our eyes to the deep problem which is controlling their body by themselves. Two very popular cancers- testicle and breast, are not well "popular" subject to talk. Young men are afraid to talk to their doctors and family about sexual health and as a result they don't know how to properly do self-examination. Similar situation is with girls, if they didn't start examination now, they wouldn't do it when they have to. Also young people want to examine their partners, but they don't have a clue how to do it. What is more the big problem is also with cytology. Women under 25 years are afraid of this examination and they don't know what this test can change.

Our study shows that there is a lot to change in young people knowledge. It is our duty to protect them.

Keywords: testicular cancer, breast cancer, cytology, Poland, young people

P-1147

Knowledge, attitudes and barriers of primary care physicians towards water pipe smoking cessation

Maya Romani¹, Manar Shalak², Jumana Antoun¹

¹American University of Beirut, Beirut, Lebanon

²Yas health care center, Abu Dhabi, UAE

Background and AIM: Five million people die yearly from tobacco smoking and the number is expected to double in the following 20 to 30 years. Water pipe smoking is a new emerging epidemic that warrants serious movements against its spread because it is associated with similar if not even more health negative effects than cigarettes smoking. However, the paucity of studies targeting water pipe smoking and the wide acceptance of the society of water pipe smoking made us hypothesized that physicians might not be well equipped for proper counseling towards cessation of water pipe smoking. Thus this study aims to study the attitudes and knowledge of primary care practitioners towards water pipe smoking and the barriers to its cessation.

METHODS: This is a cross-sectional study using an anonymous survey among participants of an annual conference for family medicine in Lebanon.

RESULTS: 105 primary care practitioners (PCP) were surveyed. with 58% response rate. Only 38.1% of the physicians think similar techniques are used for cessation both cigarette and water pipe smoking. Similarly, 30.5% of the physicians think that nicotine replacement therapy works in water pipe smoking cessation. There was significant difference between the percentage of physicians who counsel for cigarette and those who counsel for water pipe smoking cessation ($p=0.005$) where 30% of the physicians tend to counsel against cigarette more than water pipe smoking. The major perceived barriers for waterpipe smoking cessation were the patients' compliance, the unavailability of referring program and the patients lack of awareness about waterpipe

CONCLUSION: This study shows a difference in the attitude and behavior of PCP towards cigarette and water pipe smoking. Moreover, there is lack of knowledge about water pipe smoking cessation techniques. Therefore, there is a great room for continued medical education to PCP in their private practice to improve their knowledge

Keywords: water pipe smoking, smoking cessation, family physicians

Response of the primary care physicians to the frequency of asking, counseling and following with cigarette and water pipe smoking

	Often N(%)	Sometimes N(%)	Seldom/Never N(%)
How often do you ask if your patient smokes?	99(94.3)	3(2.9)	3(2.9)
How often do you ask your patients about type of smoking?	88(83.8)	14(13.3)	3(2.9)
How often do you counsel your patients about cigarette smoking cessation?	79(75.2)	20(19.0)	6(5.7)
How often do you arrange follow up visits to discuss cigarette smoking cessation?	17(16.3)	42(40.2)	45(43.3)
How often do you warn your patients about water pipe health dangers?	78(75.0)	15(14.4)	11(10.6)
How often do you counsel your patients about water pipe smoking cessation?	65(63.1)	22(21.4)	16(15.5)
How often do you arrange follow up visits to discuss water pipe smoking cessation?	17(16.5)	26(25.2)	60(58.3)

N=105

Knowledge of Primay care physicians about facts concerning water pipe smoking

	Agree N(%)	Neutral N(%)	Disagree N(%)
Water pipe contains little toxicants because the smoke passes through a small receptacle of water*	9(9.0)	11(11.0)	89(80.0)

Water pipe delivers the addictive drug nicotine as is the case of cigarette	80(79.2)	12(11.9)	9(8.9)
During one session the water pipe smoker may inhale as much smoke as in 100 cigarettes	54(53.5)	17(16.8)	30(29.7)
Water pipe smokers are at risk for the same diseases as cigarettes smokers (cancer, heart and lung disease)	92(91.1)	5(5.0)	4(4.0)

N=101 *Missing values exist

Importance of different barriers to physician to counsel against water pipe smoking

	Very important/ important N(%)	Neutral N(%)	Not important N(%)
Patients are not compliant	72(79.1)	5(5.5)	14(15.4)
Lack of adequate training and knowledge about smoking cessation	60(78.7)	6(6.7)	13(14.6)
Lack of available smoking cessation referring clinic or program	69(77.5)	11(12.4)	9(10.1)
Patients are not interested	66(72.5)	12(3.2)	13(14.3)
Shortage of time	60(69.8)	18(20.9)	8(9.3)
Patients lack of awareness about water pipe harms	63(69.2)	9(9.9)	19(20.9)
Lack of personal knowledge about water pipe smoking cessation	61(67.8)	12(13.3)	17(18.9)
Waterpipe smoking is considered norm in special places by the community	57(63.3)	11(12.2)	22(24.4)
Lack of knowledge about water pipe harms	54(60.0)	11(12.2)	25(27.8)
Cost of medications and clinic visit	53(58.9)	21(23.3)	16(17.8)
No expected benefit as patients will continue to smoke anyway	45(52.3)	20(23.3)	21(24.4)
The physician smokes	29(38.2)	9(11.8)	38(50.0)

P-1148

Barriers to visiting a Family Physician: a nation based survey in Lebanon

Manar Hamid Shalak¹, Maya Romani², Joumana Antoun²

¹Yas Health care

²American University of Beirut medical center

Background and AIM: Primary care improves health and “people receiving care from primary care physicians are healthier”. Although evidence shows that primary care offers health equity, positive health outcomes and cost-effective care, it is still not the key element of all health care systems worldwide. In many European countries, general practice is the cornerstone of healthcare systems. Recently in the United States they are putting emphasis on primary care. However, the Middle East health care systems are still based on free market. Our aim is to assess the patient’s knowledge, attitude and practice regarding family medicine in Lebanon and to identify barriers for not visiting a family physician in a free market health care system.

METHODS: We conducted a nation based, anonymous phone survey among a sample of Lebanese population.

373 citizens were randomly chosen, 60 from each one of the six Lebanese regions and enrolled in the study

RESULTS: the study showed that 72.4% of the sample did not understand the scope of practice of family medicine, even though 63% had heard the term 'family medicine'. The perception of the respondents of the scope of family medicine differed among the various services of family practice. A family physician could treat all family members (93%), common diseases (80%), deal with prevention (86%) and chronic diseases (80%). However, family

physicians were not qualified to do pap smears(70%), insert an intrauterine device(74%) or perform a normal vaginal delivery(62%). 70% of those surveyed had a regular doctor. The main identified barriers were the lack of awareness about family medicine in addition to the absence of a nearby or accessible family doctor.

CONCLUSION: Family practice in Lebanon is undervalued; actions should be taken to focus on population education. Without proper official plans from healthcare policy makers, family practice is unlikely to reach its mission.

Keywords: primary health care, family medicine, Lebanon

P-1149

Vitamin D Deficiency in Adults

Turan Set, Elif Altunbaş Ateş, Rahman Kuri, Ceyhun Yurtsever

Department of Family Medicine, Karadeniz Technical University Medical Faculty, Trabzon, Turkey

BACKGROUND & AIM: Vitamin D is the steroid hormone involved in mineral ion homeostasis regulation. It plays an important role in bone health maintenance and neuromuscular functioning. Vitamin D deficiency in adults has been associated with muscle weakness and an increased risk of falling. In this study, we aimed to assess prevalence of the vitamin D deficiency in adults at our clinic.

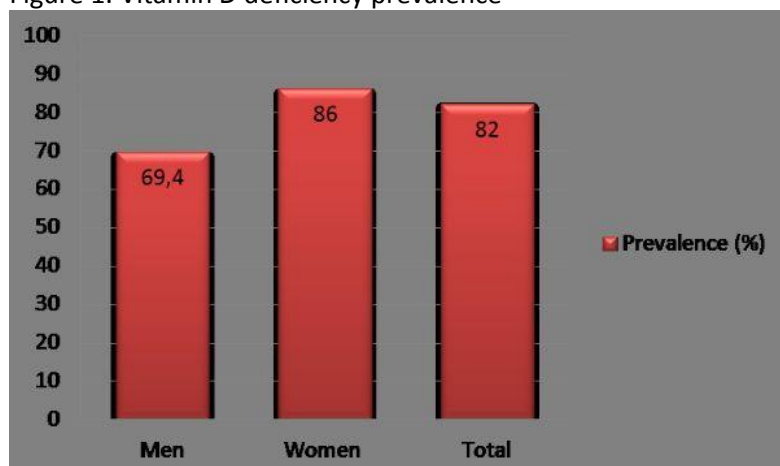
METHOD: This retrospective study was carried out between February 2014 and January 2015 in family medicine clinic. In the study, we included the data of 150 patients who are 18 years and over. Patients were divided into two groups. Group 1: Patients with vitamin D deficiency [25(OH) vitamin D levels <20 ng/mL], Group 2: Patients who have not vitamin D deficiency [25(OH) vitamin D levels >20 ng/mL]. Sociodemographic characteristics and serum 25(OH) vitamin D levels were recorded. Data were analyzed using SPSS.

RESULTS: The average age of patients was 35.4±12.8 years. There was no significant difference between the mean age of men and women (p=0.108). In this study, 76% (n=114) of patients were female. Average vitamin D levels were 16.4±8.9 ng/ml in men and 12.8±8.8 ng/ml in women (p=0.033). Vitamin D deficiency prevalence were found 82%. This ratio were found 69.4% (n=25) in men and 86% (n=98) in women (p=0.024).

CONCLUSIONS: Our study found that vitamin D deficiency in four out of every five adults. This deficiency was significantly higher in women than men. These findings may be associated with climatic conditions, dietary habits and inadequate utilization from sunlight. The most common cause of vitamin D deficiency are insufficient encounter with sunlight. The scope of preventive health services of family physicians for the prevention of vitamin D deficiency in adults will be useful to give advice about the utilization from sunlight and diet to individuals.

Keywords: Vitamin D, Deficiency, Adult

Figure 1. Vitamin D deficiency prevalence



P-1150

Prenatal Care Status of Mothers Admitting to a Newborn Clinic

Emrah Ersoy, Esra Saatci

Department of Family Medicine, Cukurova Universty, Adana, Turkey

Background and AIM: Prenatal care is a type of preventive healthcare with the goal of providing regular examinations to prevent potential health problems throughout the course of the pregnancy while promoting healthy lifestyles that benefit both mother and child.

METHODS: Sixty six mothers admitting consecutively to the Newborn Outpatient Clinic of Cukurova University Hospital in May 2015 completed a sociodemographic and Prenatal Care Questionnaire. Response rate was 100%. Data was installed and analyzed using SPSS statistical pocket program version 20.

RESULTS: All mothers stated that they had prenatal care. Of mothers, 31.3% (n=21) was in the 26-30-age group, 61% (n=41) were housewives, 34.3% (n=23) were high school graduates, and 46.3% (n=31) were married and 50.7% (n=34) had their first pregnancy in the 21-25-age group, 17.9% (n=12) of mothers had previous abortions and 11.4% (n=6) had dilatation and curettage. No stillbirths were declared. Two mothers had disabled older children. More than half of the mothers (53.8%, n=36) stated that they did not use any contraceptive methods and 85% (n=57) of pregnancies were intended. Of mothers, 83.6% (n=56) initiated prenatal care in the second month of pregnancy, 73.1% (n=49) had no health problem during pregnancy. There was a significant relationship between the time of onset for prenatal care and the health problems ($p=0.0001$). Of mothers receiving nutritional consultation, 61.2% (n=41) stated that they changed their nutritional behavior ($p=0.0001$), 92% (n=62) had tetanus vaccination and iron, calcium, and vitamin supplementation in Family Health Centers. Seven mothers quitted smoking during their pregnancy.

CONCLUSION: Family physicians have an essential role in providing integrated prenatal care, including evidence-based screening, counseling, medical care, and psychosocial support.

Keywords: Prenatal care

P-1151

Bronchiectasis, severity ranges in Primary Health Care

Amparo Hervás Docón¹, Silvia Álvarez Álvarez², Núria Sánchez Ruano¹, Laia Gené Huguet¹, Xavier Flor Escriche², Elisenda Sant Arderiu³, Marta Navarro González¹

¹cap comte borrell, barcelona, spain

²cap chafarinas, barcelona, spain

³cap casanovas, barcelona, spain

Justification

Bronchiectasis not due to cystic fibrosis is characterized radiologically by permanent dilation of the bronchi, and clinically by a syndrome of cough, sputum production and recurrent respiratory infections. The prevalence of bronchiectasis is not precisely known and has been historically underestimated. International data show an increase in the prevalence of bronchiectasis over recent years. The impact on healthcare systems is substantial. Bronchiectasis has a clear attributable mortality. Bronchiectasis is a heterogeneous disease with a highly variable impact on patients. Severity ranges from patients without daily symptoms who have infrequent exacerbations, to patients requiring lung transplantation. Rate of lung function decline is highly variable and is associated with P.Aeruginosa colonization and severe exacerbations. Often the patient with bronchiectasis is visited in primary health care when it presents an exacerbation; therefore patients should receive treatment appropriate to their stage and severity of disease.

Recently, the European bronchiectasis network described the first clinical prediction tool for hospital admissions and mortality in bronchiectasis, the Bronchiectasis Severity Index(BSI).

Content

We propose to test BSI to all patients who are diagnosed of bronchiectasis in our computer clinical history. The

following variables will be evaluated: age, body mass index ($\text{kg}\cdot\text{m}^{-2}$), FEV1(%) predicted (forced expiratory volume in 1 s), hospital admissions in the past 2 years, exacerbation frequency in the past 12 months, MRC dyspnoea score(Medical Research Council), bacterial colonization (Pseudomonas aeruginosa, other potentially pathogenic microorganisms, none), radiological severity (≥ 3 lobes involved or cystic bronchiectasis, <3 lobes involved). Then we will have a different rate: 0–4 points: low risk of hospitalization and mortality; 5–8 points: moderate risk; ≥ 9 points: high risk.

In this way we will have a description of gravity range of our patients with bronchiectasis, which will allow us to give an appropriate treatment in order to the stage and severity of this disease.

Keywords: Bronchiectasis, Primary health care, Severity of Illness Index

Pseudomona aeruginosa and expectoration



TCAR



P-1152

Investigation Of Socioeconomic Status Evaluation Grouping Criterias In Medical Studies

Ali Ümit Geçkil, Altuğ Kut, Funda Salgür, Gökhan Eminsoy, Fisun Sözen, Yasemin Çetinel
Department of Family Medicine, Baskent University, Ankara

Background & Aim

Socioeconomy is a concept that covers social and economical structures of society in addition to the relationship among them. In general socioeconomic status (SES) can be defined as a set of various and up-to-date criterions which reflect not only individuals' but also families' income, educational status, and employment. In order to evaluate results of medical studies in the right way, both socioeconomic indicators and the researches should be properly selected and designed.

METHOD:

This study is designed as a cross-sectional observational survey. Articles written between years 2004-2014 were scanned among Turkish Medical Database of ULAKBİM. SES evaluation criterias were questioned in those articles. In this context, articles having keywords "Socioeconomic, sociodemographic, sociocultural, demographic" in its header or the text were included the study.

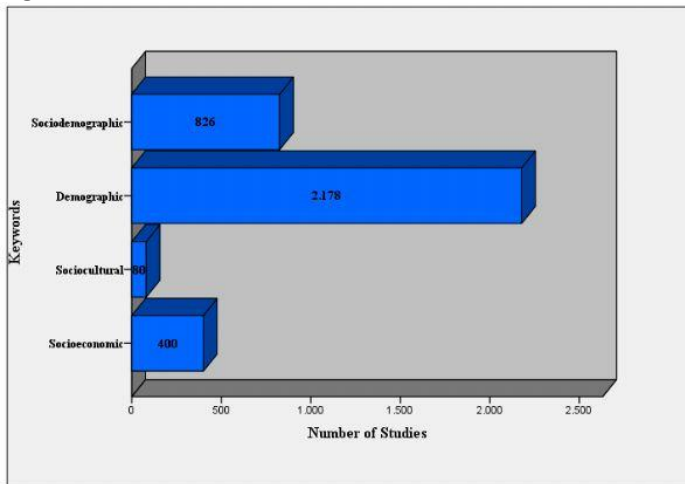
Data were analyzed using SPSS v21.0 software. For descriptive statistics mean±SD, minimum-maximum levels and percentages were used; continuous variables were analyzed using t- test and categorical variables using Chi-square tests. P values <0.05 were accepted as statistically significant.

RESULTS: 80 articles were analyzed so far out of 3342 selected articles. 25% of them were written in English (n=20). 32.5% were published in international journals (n=26). Most frequently used criterias were age, gender, education and household income. 63.75% of them made a right association between the article's main subject and socioeconomic parameters (n=51).

CONCLUSION: This research that still goes on. So far articles show us that the socioeconomic criterias are widely divergent and not properly used to form the article structure. In other words the association between socioeconomic criterias and results among 36.25% of the articles were not well associated.

Keywords: Socioeconomic, sociodemographic, socioeconomic status.

Figure 1



Distribution of enrolled studies according to keywords.

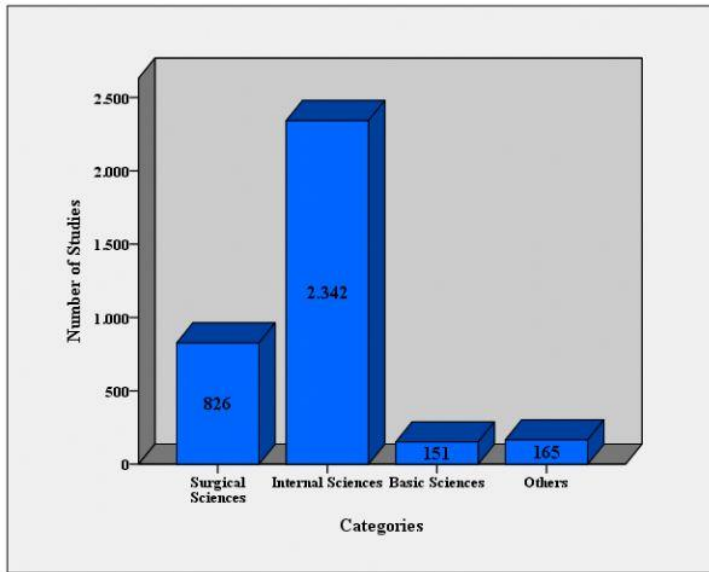
Table 1

	Turkish	English	Total (n)
Review	52	8	60
Short Communication	3	0	3
Letter to Editor	3	0	3
Article	2787	608	3395

Case Report	23	0	23
Total (n)	2868	616	3484

Types of publications according to their language

Figure 2



Distribution of enrolled studies according to subcategories.

Table 2

SES Criteria	No(%)	Yes(%)
Marital Status	73,4	26,6
Working Status	69,7	30,3
Household Income	77	23
Residential Area	83,9	16,1
Educational Status	50,3	49,7
Rent/Owner Status of The House Living	98,9	1,1

SES criterias questioned among the investigaded publications

P-1153

Expressive and Procedural touch in clinical consultations in the United Arab Emirates

Usman Ghani Lashari

United Arab Emirates University

Background

Verbal and non-verbal communication skills are essential for successful doctor-patient relationship and integral part of day to day clinical consultations. Touch is an important part of non-verbal communications. This study investigates use of touch of clinical consultations in UAE. No such data is available in UAE. Touch has been divided into procedural (related to performing a procedure) and expressive (unrelated to a procedure).

Aim

This study investigates doctors and patients perceptions and experiences in clinical consultations.

Design

Qualitative study in city of Al-Ain, UAE.

Method

Participating doctors and patients were asked to fill in a questionnaire and informal interviews. Data was subjected to comparative analysis

Results

305 patients and 21 doctors participated in the study. 51% of the patient participants were Emiratis and 49% were expats residing in Al Ain. 23% of doctors were Emiratis and 77% were expat physicians. Age range 18-67 years. 52% patients rated expressive touch as a fair to excellent form of non-verbal communication and 48% of the patients rated it as a poor. Only 11% of the patients were touched expressively by their physician in the past 12 months.

96% physicians acknowledged expressive touch as fair to excellent form of communication. There were clear gender preferences among the doctors and the patients as being touched by the same gender was felt as more appropriate.

Preferred areas for touching included hands, arms, shoulders and head. Majority of doctors used expressive touch in consultations relating to breaking bad news, bereavement, showing compassion and trust.

CONCLUSIONS:

Expressive and procedural touch are an important part of non-verbal communication between patients and doctors. Mixed results were obtained relating to its current use in a relatively conservative society in UAE. Increased education of use of expressive touch would probably enhance doctor patient relationship and probably improve clinical outcomes.

Keywords: Communication skills, non-verbal communications, touch, clinical consultations, Qualitative research

P-1154

The attitudes of family medicine residents in Ankara regarding to coagulation tests, anticoagulant treatment and monitoring

Iskender Bülbül¹, Irfan Şencan², Ismail Kasım², Adem Bahadır³, Ömer Akca⁴, Turgay Albayrak⁵, Rabia Kahveci², Adem Özkara²

¹Guzelyurt County Hospital, Aksaray, Turkey

²Ankara Numue Education and Research Hospital, Ankara, Turkey

³Kalkandere County Hospital, Rize, Turkey

⁴Kayseri Education and Research Hospital, Kayseri, Turkey

⁵Cigdemtepe ASM, Yenimahalle, Ankara, Turkey

Background & Aim

Failure in prevention of arterial and venous thrombosis or inability to manage of thrombosis treatment is a clinical condition which is morbidity and mortality is very high. Because of family medicine is first point of contact in health care system every family medicine specialist should know Monitoring of coagulation tests, current anticoagulant therapy and knowledge of the complications that can occur during treatment and situations that can impair these tests. These has to be essential knowledge and skills of family medicine specialists. The aim of our study is to evaluate the knowledge and attitudes of the family medicine residents in Ankara about anticoagulant therapy and its' monitoring.

Method

Observational and cross-sectional survey was designed. Configured 21 question survey was created after pilot study. The study executed among 216 family medicine residents from university hospital and educational and research hospitals in Ankara. 199 resident agreed to participate study and 143 of them who answered questions fully included to study. Data were evaluated in SPSS program using chi-square, likelihood ratio by chi-square or Fisher's exact chi-square.

Results

The majority of the research participants consisted of young physicians, who have not completed 10 years in their medical profession. The residents stated that only 8.4% of them attended a training on anticoagulant treatment and follow-up. We found that participants who attended training have more accurate answers to questions which intended to measure awareness and knowledge. The correct answer rates of the group that we call young physicians was higher.

Conclusions

Our findings revealed that the awareness about anticoagulant therapy and monitoring are low and there is a need for education. We need studies to identify and education plans on subjects for family medicine residents in order to improve their awareness and better equipped family physicians.

Keywords: Family Medicine Residents in Ankara, Coagulation Tests, Anticoagulant Treatment and Monitoring

Some findings and opinions of family medicine residents regarding to coagulation tests, anticoagulant treatment and monitoring

Table. Some findings and opinions of family medicine residents regarding to coagulation tests, anticoagulant treatment and monitoring		
	n	%
Gender		
Female	94	65,7
Male	49	34,3
Duration in occupation		
1-5 years	99	69,2
6-10 years	29	20,3
11 years and more	15	10,5
Daily practice for INR monitoring		
Yes	76	53,1
No	67	46,9
Education about INR monitoring		
Yes	12	8,4
No	131	91,6
Is anticoagulation therapy and INR follow-up appropriate in primary care.		
Yes	94	65,7
No	19	13,3

Table about some findings and opinions of family medicine residents regarding to coagulation tests, anticoagulant treatment and monitoring

P-1155

Internet Addiction And Related Factors In a University Sample

Tuğçe Refika Turan, Fisun Sözen, Ali Ümit Geçkil, Sinem Aydemir, Rengin Erdal

Department of Family Medicine, Baskent University, Ankara, Turkey

Background and AIM:

Internet addiction can be defined as excessive and also uncontrolled use of internet which results in weak academic and professional performance, relationship dispute, sleep disorder and psychiatric symptoms. Several scales have been developed to assess internet addiction. Young Internet Addiction Scale is among one of the most widely used scales for this purpose. In European based trials, rates of internet addiction were between 1-9%. The aim of this research is to figure out internet addiction prevalence and factors related among a population of university students.

MATERIALS-METHOD:

This study is planned as a cross-sectional survey including a 27 item questionnaire applied to university students. Besides Young Internet Addiction scale is added to the questionnaire. The sample size is calculated as 390 university students. So far we have fulfilled results of 100 volunteers.

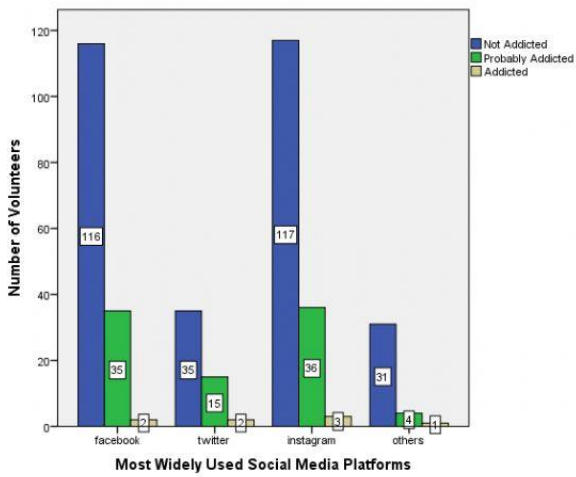
RESULTS:

Mean age of 100 participants was $20,66 \pm 1,8$. 70% were female (n=70) and 56% (n=56) of participants were students in Faculty of Social Sciences. Preferred internet connection locations were 27% home, 8% school and 65% mobile (cell phones etc). 87% of participants preferred using mobile phones as a method to connect the internet (n=87). We also found that there is a correlation between Young scores and duration of social media use. According to Young Internet Addiction Scale 67% were not addicted, 29% were probably addicted and 4% were addicted.

DISCUSSION:

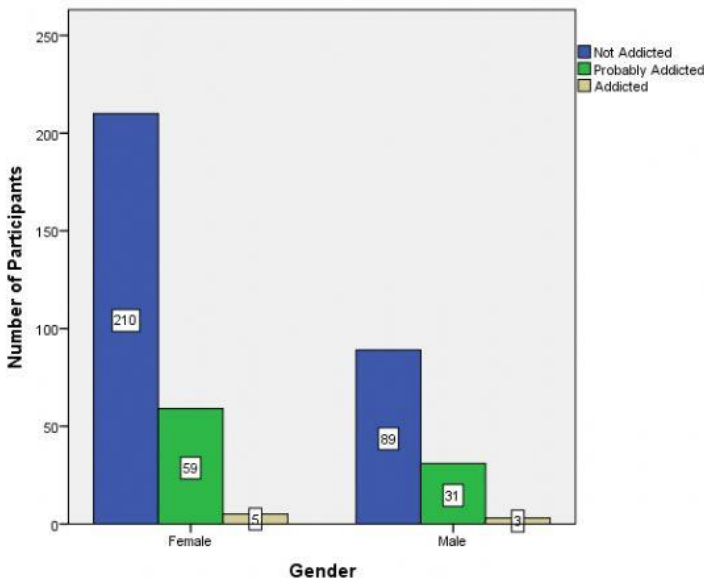
Results of 100 participants have been processed. We expect to define internet addiction prevalence and related direct and indirect factors affecting this health issue by the help of this survey. Our findings were coherent with general prevalence worldwide. It can be stated that social media is the major use of internet among university population nowadays.

Keywords: Internet Addiction, Young Internet Addiction scale, university students, social media



Internet Addiction among Most Widely Used Social Media Platforms

Figure 2



Internet Addiction among Gender

The relation between Young scores of addiction and time spent on Internet

Hour Spent	Not Addicted	Probably Addicted	Addicted	Total
0	15,4%	11,1%	0%	14,1%
1	38,1%	27,8%	0%	18,6%
2	18,7%	20,0%	0%	12,6%
3	12,0%	14,4%	12,5%	5,3%
4	4,7%	6,7%	12,5%	3,5%
5	4,7%	7,8%	0%	5,3%
6	2,3%	6,7%	12,5%	3,5%
7	0,7%	0%	0%	0,5%
8	0,3%	2,2%	0%	0,8%
10	2,0%	3,3%	25,0%	2,8%

12	0,3%	0%	12,5%	0,5%
20	0,3%	0%	0%	0,3%
24	0,3%	0%	0%	0,3%
Total	100%	100%	100%	100%

P-1156

The comparative effects of a Buddhist meditation retreat and vacation on mindfulness and measures of well-being

Otto Pichlhöfer¹, Adrienne Chang², Gerhard Blasche¹

¹Medical University of Vienna

²Miami University, Ohio

***BACKGROUND:** * Recovery from work through respite and vacations is necessary to maintain well-being and health and is essential to avoid a variety of negative health outcomes like burnout, chronic fatigue, psychosomatic diseases and longer sick-leave. To identify activities enhancing the duration of recovery effects are of interest.

***METHODS:** * A sample of Europeans and North Americans was invited to participate in the study. A questionnaire was electronically administered 10 days prior, 10 days after and 66 days after the retreat/vacation. Respondents in the meditation retreat group (n=60) were compared to vacation with meditation (n=40) and vacation without meditation (n=26). Measures were “act with awareness” (10 items) and “accept without judgment” (9 items), the “fatigue assessment scale” (10 items), the “perceived stress scale” (10 items) and the “WHO-5 Well-being Index” (5 items). First, the retreat was compared with those individuals taking a vacation without meditating during vacation. Second, the retreat was compared with those individuals taking a vacation in which they did meditated. Within person contrast were calculated comparing assessment 1 & 2 as well as assessment 1 & 3.

***RESULTS:** * The total group time effect was significant for all variables between assessment times 1 & 2 and 1 & 3. The within-subject contrasts of retreat versus vacation without meditation showed a significant difference for act with awareness and accept without judgment at both time intervals and for perceived stress and emotional well being at time 3.

***DISCUSSION:** * Participation in a residential meditation retreat of 1-week or longer and leisure vacation with meditation, leads to significant stress reduction and increased mindfulness compared to leisure vacation alone. Our findings suggest benefits of mindfulness meditation on retreats and mindfulness meditation on vacation over vacation alone in promoting a more enduring, long-lasting, resilient response to daily stressors and improved, sustained psychological well-being.

Keywords: Mindfulness, Meditation, Stress, Burnout, Vacation, Psychosomatic Diseases

Pre, post and follow-up adjusted means for retreat, vacation w meditation, vacation w/o meditation

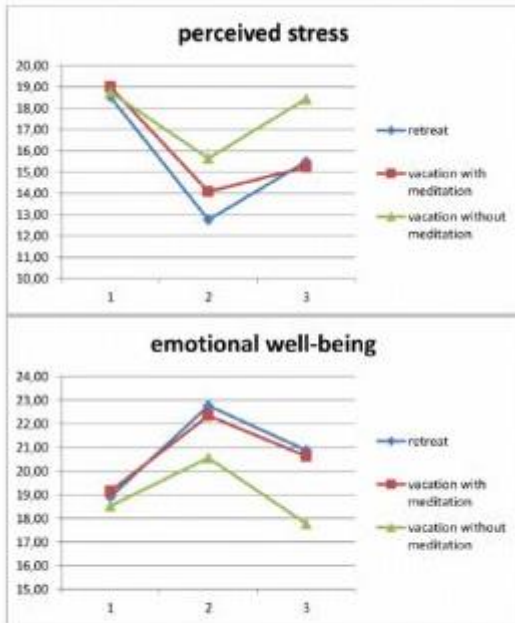
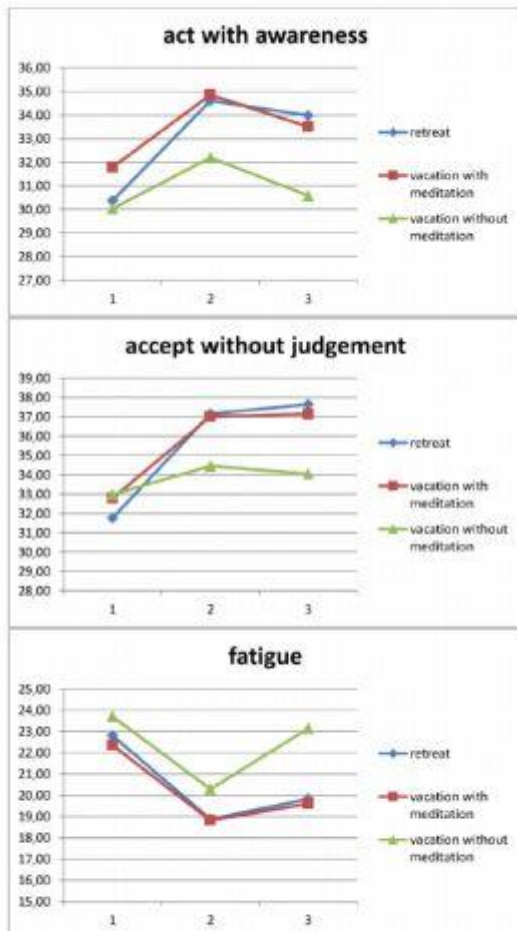


Figure 1: Pre, post and follow-up adjusted means for retreat, vacation w meditation, vacation w/o meditation

Pre, post and follow-up adjusted means for retreat, vacation w meditation, vacation w/o meditation



P-1157

Quality of life of dyspepsia patients who were admitted to Family Medicine Clinic of Adana Numune Research and Training Hospital

Dilek Köse¹, Kenan Topal¹, Çiğdem Gereklioğlu², Sait Yıldırım¹, Kayhan Süreyya Işgüzar¹, Gizem Erdoğan¹

¹Adana Numune Training and Research Hospital, Department of Family Medicine, Adana/Turkey

²Baskent University Medical Faculty, Department of Family Medicine, Ankara/Turkey

BACKGROUND: Dyspepsia is defined as a recurrent and persistent disturbance composed of distention and early satiety in the upper part of the abdomen and epigastrium. Its prevalence is between 25-40%. We aimed to evaluate the quality of life of the dyspepsia patients.

METHOD: The study included 66 dyspepsia patients. A structured questionnaire form inquiring the sociodemographic data, nutritional habits was applied and quality of life was evaluated with WHOQOL-BREF quality of life scale. Comparisons between groups were done with independent two-sample t-test.

RESULTS: Mean age was 37.58±12.7 years. Of the patients, 53.0% (n=35) were female, 68.2% (n=45) were married, 31.8% (n=21) were graduates of elementary school, 30.3% (n=20) were graduates of high school, 69.7% (n=46) had less than 2 children, 30.3% (n=20) were working at private sector, 77.3% (n=51) were living at city center. Mean WHOQOL-BREF score was 16.0± 2.03. When the highly educated (53%, n=35) and poorly educated (47%, n=31) groups were compared with regard to physical and psychological health domains of the scale, a statistically significant difference was not detected between groups (t= -0.029, p=0.97 and t= -0.922, p=0.36, respectively). There was a statistically significant association between groups in social relationships and environmental domains. A significant difference was detected between WHOQOL-BREF total score of the groups (t = -2.28, p=0.026).

CONCLUSION: Sufficient approach of the family physicians is of great importance for dyspepsia. Biopsychosocial approach, the main principle of family medicine, addresses not only the diseases but also their influences on quality of life. Our study indicated that dyspepsia leads to an impairment in total score and especially social relationships and environmental domains of WHOQOL-BREF quality of life scale in poorly educated dyspepsia patients.

Keywords: Dyspepsia, quality of life, biopsychosocial approach

P-1158

Seroprevalence Of Hepatitis B and C and HIV Among Prisoners In Turkey

Derya Keten¹, Mehmet Emin Ova², Evrim Gülderen¹, Hamit Sırrı Keten³, Alper Keten⁴, Seray Tümer⁵, Ahmet Çalışkan⁵, Suleyman Kulotu¹

¹Department of Clinical Microbiology and Infectious Diseases, Necip Fazil City Hospital Kahramanmaraş, Turkey

²Kahramanmaraş Prison Doctors, Kahramanmaraş, Turkey

³Department of Family Medicine, Kurtul Family Health Center, Kahramanmaraş, Turkey

⁴Kahramanmaraş Branch of the Council of Forensic Medicine, Kahramanmaraş, Turkey

⁵Department of Microbiology, Necip Fazil City Hospital Kahramanmaraş, Turkey

BACKGROUND: This study aimed to discuss hepatitis prevalence and hepatitis genotypes among prisoners as a specific group.

METHODS: The study was endorsed by Kahramanmaraş Sutçu Imam University Medical Faculty Ethic Committee (date: 02.06. 2014, number 07) and was conducted with the permission of the Kahramanmaraş Public Prosecutor. Two hundred sixty-six patients who have been convicted of several crimes such as robbery, sexual abuse, assault, violence, and substance selling and abuse were included in the current study.

RESULTS: Of the 266 patients, 89.5% were male, 10.5% were female, and the mean age was 31.21± 8.99 years. Risk factors were detected in 27.4% of the patients. Out of 73 cases who had risk factors, a history of intravenous drug addiction was found in 20.3%, a history of operations/transfusions was found in 3.8%, indentation was found in 1.9%, and suspicious sexual contact was found in 1.5%. The rate of HBsAg positivity was 2.6% and the ratio of cases who were anti-HBs positive was 35.0% and immunity was achieved with vaccination in 43% of these cases. Anti-HCV was positive in 17.7%. HCV RNA was at measurable levels in 48.9% of the cases. In cases with HCV,

genotype 3 was detected in 97% and genotype 1 was detected in 3% of cases. No HBV and HCV association was detected in the cases.

Conclusions

In prisons, there are individuals who have hazardous behavioral patterns, who have been in prison due to violence, abuse and substance abuse. As most of the drug addicted patients continue to use substance in prisons; the common use of infectious materials, tattoo and other situations causing contact with blood increase the risk of blood borne infections. In our country, precautions should be taken also for the increased risk of these events and the community should be informed.

Keywords: Hepatitis B, hepatitis C, HIV, Prisoners

P-1159

Practical Recommendations for Obesity

Rahman Kuri¹, Turan Set², Elif Altunbaş Ateş²

¹Department of Family Medicine, Kanuni Education and Research Hospital, Trabzon, Turkey

²Department of Family Medicine, Karadeniz Technical University Medical Faculty, Trabzon, Turkey

Background & AIM: Obesity is a major public health problem in worldwide. It is associated with serious diseases such as dislipidemia, cardiovascular diseases, hypertension, type 2 diabetes mellitus and some types of cancer. In this study, we aimed to give information about practical methods for prevention and treatment of obesity.

METHOD: Several resources about obesity has been examined.

RESULTS: Patients must be aware of eating and physical activity habits. The studies reported that most of the entreated patients gained weight again. Therefore, practical lifestyle recommendations should be emphasized. These recommendations are primarily related to eating habits and exercise and can be listed as follows:

- o Pay attention to calorie and fat content
- o Avoid sweet drinks and fast food
- o Consume fruit and vegetable daily
- o Drink at least 2-3 liters of fluid daily
- o Chew solid foods thoroughly
- o Form an own serving plate
- o Not skip breakfast
- o Eat meals on time
- o Avoid snacking
- o Keep an eating list
- o Determine a routine place and time for exercise
- o Use stairs instead of elevator
- o Deal with housework and gardening
- o Go on foot for short distances
- o Don't do shopping when you are hungry
- o Park car on the furthest place
- o Don't watch tv more than 2 hours a day and 10 hours in a week
- o Control your weight once a week

CONCLUSIONS: For patients, it is necessary to adopt lifestyle changes and have a high level of awareness for treating obesity and maintaining of ideal weight. There are simple and effective lifestyle changes that can be applicable for everyone and all conditions. In order to get a successful result, we should give understandable, clear and easy recommendations by taking the most suitable method for each patient into consideration.

Keywords: Obesity, Prevention, Treatment, Practical Recommendations

P-1160

(Attitude and Practice of Parents Towards Medication Usage for Their Children's Diseases)

Umut Gök Balcı¹, Şenay Demir², Yasemin Şimşek¹, Hande İleri¹, Özten Biçici³, Verda Erdal³, Gülay Arslan³, Nuriye Birlık³, Yeliz Acar³, Salih Özgür³, Kurtuluş Öngel¹

¹Umut Gök Balcı, Yasemin Şimşek, Hande İleri, Kurtuluş Öngel, Department of Family Medicine, Tepecik Research and Training Hospital, İzmir, Turkey

²Şenay Demir, Department of Pediatrics, Tepecik Research and Training Hospital, İzmir, Turkey

³Özten Biçici, Verda Erdal, Gülay Arslan, Nuriye Birlık, Yeliz Acar, Salih Özgür, Department of Pediatrics, Ödemiş Government Hospital, Ödemiş, Turkey

(Background & AIM: Attitudes and behaviours towards usage of medication can vary in society. People has concerns about the side effects of the drugs and the drug usage were accused of many factors. The study objective was to evaluate attitude and practice of parents towards medication usage for their children's diseases

METHODS: Questionnaire based study was carried out in parents of admitted children in İzmir Tepecik Training and Research Hospital and Odemis State Hospital in 2014. Respondents were surveyed with 27 questions about parents attitudes against diseases and usage of medications. SPSS 20.0 statistical program package was used for data analysis.

RESULTS: The study included 208 participants. %10.09 of participants (n:21) were fathers, %93.1 of them were mothers. The majority of the parents (n:150, %72,11) were primary school graduates. 16 parents (%7.69) consult non-physicians about medications, 77 (%37.01) parents use herbal medicine. Medications consisting of analgesics and antipyretics groups are used without consult of physicians. 81 Parents (%38.94) had these medications as a spare at home. All participants were following expiration dates of the drugs. 21 of the parents (%10.09) recommended these medications -which they have had clinical benefits- to their relatives. 180 people (86.53%) asked information about prescribed drugs and 207 individuals (%99.51) used the medications as prescribed. The majority (n = 195, 93.75%) had read the prospectus. In case of the adverse effects 171 parents stated that they didn't benefit from the medications, 163 parents consulted the physician and referred to the hospital. 201 parents (%96.63) reported that they would dispose of the non-used medication

CONCLUSIONS: The study represented that parents had proper attitude about the usage of medications. This study is limited by the data from small-scale population from the particular region)

Keywords: Child, parents, medication, attitude

P-1161

Painful shoulder in Primary care patients

Delia Rodriguez¹, Patricia Marquez², Maria Del Carmen Fernandez¹, Jose Maria Segura¹

¹Centro de Salud Canalejas, Gran Canaria, Spain

²Clinica Cajal, Gran Canaria, Spain

INTRODUCTION:

Shoulder pain is the third most common cause of musculoskeletal consultation in primary care. Any pain or disability in it, affects a person's ability to carry out daily activities.

Our study determines in a period of time from October 2011 to September 2014 in a Primary Care Centre of Gran Canaria; the number of adults consulting painful shoulder (non traumatic, non related to malignant diseases or inflammatory diseases), its distribution and management of them.

METHODS: Observational, descriptive and retrospective study was designed. The data was collected from the electronic clinical registries.

RESULTS: 1976 cases, 750 (38%) men, 1225 (62%) women, with an average age of 58 (95% CI.) The most common diagnosis was codified as unspecified shoulder pain 92.04% followed by rotator cuff tendinitis 5,80% and 0.9%

calcified tendonitis. All cases were firstly managed by GP and 32.4% were referred to specialists.

DISCUSSION: Importance in primary care due to its prevalence, of a good diagnosis and treatment of the principal shoulder pathology (frozen shoulder, rotator cuff disorder, glenohumeral joint arthritis and instability), to avoid chronicity and complications. Management should be multidisciplinary, including analgesics, relative rest and access to rehabilitation programs.

Keywords: Shoulder pain, rehabilitation

P-1162

Environmental Factors Contribute to Pulmonary Tuberculosis in North Minahasa, North Sulawesi, Indonesia

Henry Palandeng¹, Grace Kandou², Herlina Butiop³

¹Department of Community Medicine, Faculty of Medicine, Sam Ratulangi University

²Public Health Faculty, Sam Ratulangi University

³Medical Student at Faculty of Medicine, Sam Ratulangi University

Pulmonary tuberculosis (TB) remains health problem throughout the world, including in Indonesia. Efforts to eliminate cases of pulmonary tuberculosis in Indonesia still has many obstacles. Environmental factors contribute to the high prevalence of pulmonary tuberculosis. Of the 33 provinces in Indonesia highest prevalence of pulmonary tuberculosis derived from three provinces, namely Jakarta, Banten, and North Sulawesi. This study aims to investigate the relationship between household contact and physical environmental factors homes with pulmonary TB incidence in the region of Wori, North Minahasa in North Sulawesi. This study was a cross sectional study with independent variables studied are household contacts, ventilation, and temperature of the room. Analysis using the chi-square test showed that there is a relationship household contacts with pulmonary TB incidence with $p = 0.016$, while the variable ventilation $p = 0.278$ and $p = 0.677$ at room temperature showed no association with the incidence of pulmonary tuberculosis in the village of Wori, North Minahasa, North Sulawesi, Indonesia.

Keywords: pulmonary tuberculosis, household contacts, ventilation, room-temperature

Distribution of sex on the incidence of pulmonary tuberculosis

Figure 2

Gender	TB Event				Total
	Pulmonary TB		Non Pulmonary TB		
	N	%	N	%	
Men	20	62,5	17	26,1	37
Women	12	37,5	48	73,8	60
Total	32	100	65	100	97

Age	TB Event				Total
	Pulmonary TB		Non Pulmonary TB		
	N	%	N	%	
12-16	2	6,25	2	3	4
17-25	2	6,25	10	15,3	12
26-35	6	18,75	11	16,9	17
36-45	0	0	20	30,7	20
46-55	6	18,75	7	10,7	13
55-65	8	25	11	16,9	19
>65	8	25	4	6,1	12
Total	32	100	65	100	97

Age distribution of the incidence of pulmonary tuberculosis

Figure 3

Education	TB Event				Total
	Pulmonary TB		Non Pulmonary TB		
	N	%	N	%	
Elementary	14	43,7	18	27,6	32
Middle-High	9	28,1	26	40	35
High-School	8	25	17	26,1	25
D3	1	3,1	1	1,5	2
Graduate	0	0	3	4,6	3
Total	32	100	65	100	97

Distribution of respondents by educational level

Figure 4

Type of work	TB Event				Total
	Pulmonary TB		Non Pulmonary TB		
	N	%	N	%	
Farmer	9	28,1	8	12,3	17
Housewife	7	21,8	43	66,1	50
Entrepreneur	4	12,5	5	7,6	9
Fishermen	2	25	1	1,5	3
Civil Servant	1	3,1	2	3	3
Not Working	9	28,1	6	9,2	15
Total	32	100	65	100	97

Distribution of respondents by type of work

Figure 5

Household -contact	TB Event				Total		P	OR	95% CI
	Pulmonary TB		Non Pulmonary TB		N	%			
	N	%	N	%					
Positive	9	28,1	6	9,2	15	22,4	0.016	3,848	1,231 -12,029
Negative	23	71,9	59	90,8	82	84,5			

The correlation between household contact with incidence of pulmonary tuberculosis

Figure 6

Ventilated area	TB Event				Total		P
	Pulmonary TB		Non Pulmonary TB		N	%	
	N	%	N	%			
TMS	17	53,1	42	64,6	59	60,8	0,278
MS	15	46,8	23	35,3	38	39,1	

Correlation of Ventilated area with pulmonary tuberculosis

Figure 7

Temperature	TB Event				Total		p
	Pulmonary TB		Non Pulmonary TB		N	%	
	N	%	N	%			
TN	30	93,7	59	90,7	89	91,7	0,677
Normal	2	6,2	6	9,2	8	8,2	

Room temperature relationship with pulmonary tuberculosis

P-1163

General Practitioners' attitudes towards serum immunoglobulin testing in the South of Ireland: a qualitative study

Sharon L Cadogan¹, Sheena M Mchugh¹, Colin P Bradley², John P Browne¹, Mary R Cahill³

¹Department of Epidemiology and Public Health, University College Cork, Cork, Ireland.

²Department of General Practice, University College Cork, Cork, Ireland

³Department of Haematology, Cork University Hospital, Cork, Ireland

BACKGROUND: Research suggests that variation in laboratory requesting patterns may indicate unnecessary test use. Requesting patterns for serum immunoglobulins vary significantly between General Practitioners (GPs). This study aims to explore GP views on testing to identify the determinants of behaviour and recommend feasible intervention strategies for improving immunoglobulin test use in General Practice.

METHODS: Qualitative semi-structured interviews were conducted with GPs requesting laboratory tests in the South of Ireland. A random sample of GPs were purposively sampled based on the sampling criteria of: location (urban/rural); length of time qualified; and practice size (single-handed/group). Interviews were carried out between December 2014 and February 2015. Interviews were transcribed verbatim using NVivo 10 software, and analysed iteratively using thematic analysis. Emerging themes were then mapped to the theoretical domains framework (TDF), which identifies 12 domains that can enable or inhibit behaviour change. The behaviour change wheel and behaviour change technique (BCT) taxonomy were then used to recommend potential intervention strategies.

RESULTS: Sixteen GPs were interviewed, including ten males and six females. Preliminary analysis, using the TDF and BCT taxonomy, found that serum immunoglobulin test use in General Practice is influenced by many social and contextual factors. The main domains from the TDF which emerged were: 'knowledge', 'environmental context and resources', 'social influences', 'beliefs about capabilities', 'beliefs about consequences', with the findings identifying a need for 'shaping knowledge'. In particular, GPs identified education and feedback strategies as feasible interventions to change their behaviour.

CONCLUSIONS: Identified GP challenges with serum Immunoglobulin testing included difficulty interpreting test results, patient expectations, personal experiences, and the lack of implementation of guidelines and knowledge about when to test for serum immunoglobulins. Study findings and the application of the TDF and BCT taxonomy, will inform the development of a feasible intervention for improving immunoglobulin test use in General Practice.

Keywords: laboratory testing, health services research, Immunoglobulins, haematology, qualitative research, health care interventions,

Table 1: Seven of the 12 theoretical domains beliefs were identified during the coding of the transcripts

Theoretical domains belief identified	GP quotes to support identified domain
Knowledge	"...some GPs....would have a much better grasp or understanding of them. Maybe that is part of my issue that I don't fully understand them, and as I say in the rare incidence that I am doing them, I am really clutching at straws trying." (I015)
Behavioural regulation	I think the education strategy has to be built in with reminders"...a CME meeting discussing it or whatever would be good but we don't see enough to remember all the details of what is said so you probably need that reminder of what is said coming out with the result." (I003)
Beliefs about capabilities	"I feel my ability to triage them is poor, and you don't want to be ringing haematology all of the time" (I013) "You know any abnormalities at all, I tend to refer...I have serious difficulty interpreting them." (I014)

Beliefs about consequences	<p>“Yeah yeah, basically, I don’t want to miss them but I don’t want to be a doing wasteful tests either”. (I010)</p> <p>“...some of the time, the patient is actually recovered and your thinking aw h do I really want to follow this up?” (I015)</p>
Memory/attention/decision-making	<p>“I’m learning to live with slightly abnormal Igs in recent years and this whole thing of Monoclonal Gammopathy of Uncertain Significance and just keep monitoring them.” (I005)</p>
Environmental context	<p>“Some doctors don’t live well with uncertainty even in primary care.” (I005)</p> <p>“Pressure time also causes us to do tests.” (I005)</p>
Social/professional role	<p>“...we don’t have a huge call to do Igs really because I would consider that to be something that a specialist say a haematologist...would have interest in...” (1007)</p>

Table 2: Suggested intervention strategies identified by applying the TDF and BCT taxonomy to the study findings

TDF domains	COM-B	Construct	Strategy examples
Knowledge. Memory, attention and decision-making processes. Behavioural Regulation Beliefs about capabilities/consequences	C- (Psych.)	Shaping knowledge,	Education: Information about MGUS, guidelines on when to request and how to interpret results.
	C- (Phys.) M- (Refl.)	Natural consequences, Comparison of outcomes	Persuasion: Clearly communicate situations where IG testing is not beneficial. Persuasive communication of the information, supported by consultant haematologists and GPs.
Environmental context, memory, attention, decision-making processes and social/professional role	O- (Phys.) C- (Psych.) C- (Phys.)	Antecedents, Associations	Environmental restructure/enablement: Restrict the availability of the test at the laboratory end, eg. Reasons stated for request. Provide electronic notes detailing consultant advice (ideally provided on the end of the results).

P-1164

TB-DM Score: a new score of TB comorbidities in DM patients

Fabianto Santoso¹, Steven Zulkifly¹, Edo Prabudi¹, Trevino Aristarkus Pakasi², Indah Suci Widyahening²

¹Faculty of Medicine Universitas Indonesia, Jakarta, Indonesia

²Department of Community Medicine, Faculty of Medicine Universitas Indonesia, Jakarta, Indonesia

Background

Indonesia is facing double-burden diseases of tuberculosis/TB (communicable disease) and diabetes mellitus/DM (non-communicable disease). A collaborative framework for detection and management of TB-DM patients established by World Health Organization (WHO) and The International Union Against Tuberculosis and Lung Disease (IULTD) recommends acid fast bacilli (AFB) sputum smear and chest x-ray examination in DM patients with TB symptoms. However, DM patients in Indonesia often show non-specific TB symptoms, thus they often disagree to undergo chest x-ray examination. Therefore, a study was done, aiming to establish scoring system for DM patients with non-specific TB symptoms to decide for chest x-ray examination.

Method. This was a cross-sectional study conducted among TB and/or DM patients in Jakarta, Bogor (West Java), Ternate (North Maluku), Kupang (East Nusa Tenggara), and Manado (North Sulawesi). Subjects are categorized into DM group and TB-DM group. TB is diagnosed based on positive AFB sputum smear, while DM is diagnosed based on fasting blood glucose (FBG). Multivariate logistic regression are conducted based on seven indicators: (1) sex, (2) age, (3) smoking history, (4) close contact with TB patients, (5) body mass index (BMI), (6) BCG scar, and (7) FBG.

Result

There were 620 patients participated in the study. They were all DM patients registered in the primary care. Cut-off points of these seven variables are taken from literatures and previous studies. Based on multivariate logistic study, there are four indicators that can be used: (1) age, (2) smoking history, (3) BMI, and (4) close contact with TB patients. To decide that a DM patient needs to undergo chest x-ray examination, the score must surpass cut-off point of 3. The score can be categorized as low risk (score ≤ 3 , 53.3%) and high risk (score > 3).

Conclusion

The risk score can identify the risk of TB in DM patients.

Keywords: Tuberculosis, Diabetes Mellitus, Scoring, Comorbidities

P-1165

"Evaluation of the Clinical Characteristics of Children with Henoch Schönlein Purpura in Samsun"

Burcu Sezer¹, Yonca Açıköz²

¹Department of Family Medicine, 19 Mayıs University, Samsun, Turkey

²Obstetrics and Pediatric Hospital, Samsun, Turkey

AIM: Henoch-Schönlein purpura (HSP), is the most common vasculitis in childhood. Although the etiology is unknown, it is generally held responsible for previous upper respiratory tract infection or some infectious agents. Classically non-thrombocytopenic palpable purpura is accompanied by arthritis/arthralgia, abdominal pain and renal involvement. The demonstration of clinical features is important to make patients care plan. In this study, we aimed to evaluate the epidemiologic, geographic and clinical features of children diagnosed with HSP followed up in Samsun Obstetrics and Pediatric Hospital over a five-year period.

METHODS: From April 2010 to May 2015, the epidemiological, clinical and laboratory findings of all patients with diagnosis of HSP were collected by reviewing medical files retrospectively.

RESULTS: One hundred and twelve children (49 females, 63 males) aged between 2.5-17 years (avg. 7.4 years F, 8.7 years M) included in the study. Previous upper respiratory tract infection was determined in 39 patients (%34) and previous gastroenteritis in 1 patient (%8). The first symptom was purpura in 44 patients (%39), abdominal pain in 4 patient (%3), arthritis/arthralgia in 3 patients (%2), macroscopic hematuria in 1 patient (%8). Purpura was finding seen in all patients, gastrointestinal involvement occurred in 58 patients (%51.7), joints involvement in 48 patients (%42.8), renal involvement in 44 patients (%39.2), scrotal involvement in 12 patients (%19). Familial Mediterranean Fever (FMF) was determined in 3 patients (%2).

CONCLUSION: The epidemiologic and clinical features of patients with HSP followed up in our clinic are similar to the literature. In our patients we observed gastrointestinal and renal involvement either at the beginning of the disease and in progress of time. It is very important that the patients with HSP and their families should be informed about the course of the disease, varying in the wide spectrum, and also regular medical examination of the patients.

Keywords: Henoch-Schönlein purpura, children, vasculitis

P-1166

An Investigation into the Knowledge, Attitudes, and Behaviors of Physicians about Rational Drug Use

Mahmut Yılmaz¹, Zeynep Hazıroğlu Ökmen², Hatice Rümeysa Dülger², Halime Dilber Kiraz², Dilek Toprak²

¹Department of Family Medicine, Dicle University, Medical Faculty, Diyarbakir, Turkey

²Department of Family Medicine, Sisli Hamidiye Etfal Training and Research Hospital, Istanbul, Turkey

AIM: Rational drug use is defined as "the use of right drugs by patients in adequate dose for the sufficient duration and appropriate to their clinical needs at lowest cost both for themselves and the community". The steps of rational drug use include the establishment of correct diagnosis, determination of prognosis and goals of treatment, revision of treatment options, selection of appropriate treatment modality, and, if needed, prescription and follow-up of right drugs.

RESULTS: The study included 176 physicians who examined 3-300 patients a day. Of the physicians, 53.4% (n=94) spent less than 5 min and 13.1% (n=23) of them performed a whole system examination for each patient. 9.1% (n=16) of them didn't query liver and kidney function disorder and drug allergy in their patients. Most of the physicians (72.7%; n=128) explained their patients their diagnosis. Only 32.4% (n=57) of them warned their patients about the side effects of drugs. More than half of them (61.4%; n=108) advised non-drug treatments to their patients. The most common resources used by physicians for prescribing drugs were as follows: the views of colleagues (59.1%; n=104), Vademecum (54%; n=95), drug-related websites (51.7%; n=91), medical books (48.3%; n=85.9), and the commercial advertisements delivered by pharmaceutical companies (19.9%; n=35). More than half of them (56.8%; n=100) had knowledge about the side effects of the drugs, whereas 42.6% (n=75) of them had knowledge about the side effects of some drugs. It was revealed that only 15.9% (n=28) of them had correct knowledge about the prices of three drugs.

CONCLUSION: Physicians spend too little time for the examination of each patient and the presence of liver and kidney function disorder and the history of drug allergy are not queried during drug prescription. Physicians are

influenced by pharmaceutical companies and they have limited knowledge about the side effects of drugs. Most of the physicians have little information about the prices of drugs and they do not provide their patients with sufficient information about the drugs.

Keywords: physician, rational drug use

Departments and rates of the physicians included into the study

Family Medicine	Emergency Medicine	Internal Diseases	Pediatrics	Gynecology and Obstetrics	General Surgery	Other
46% (n=81)	10.2% (n=18)	10.2% (n=18)	9.7% (n=17)	8% (n=14)	5.1% (n=9)	11.2% (n=19)

P-1167

(Approaching the Life Quality Among Different Patients in Treatment)

Nazlı Soysal, Umut Gök Balcı, Yasemin Şimşek, Hande İleri, Özgür Alavcı, Kurtuluş Öngel
Nazlı Soysal, Umut Gök Balcı, Yasemin Şimşek, Hande İleri, Özgür Alavcı, Kurtuluş Öngel, Family Medicine Department, Tepecik research and Training Hospital, İzmir, Turkey

INTRODUCTION: Life quality is a broad concept that affected with person's physical health, psychological state, beliefs, social relations and their relationship with the environment. Biopsychosocial approach is the basic assesment method of patients in the Family Medicine to improve the quality of life; by this way, factors affecting the quality of life identified.

AIM: In this study, quality of life during treatment in different patient groups was assessed with WHOQOL-BREF-TR scale and factors affecting the quality of life were intended.

MATERIAL METHOD: Study was performed between 1 January 2014 to 31 May 2014 in Tepecik Training and Research Hospital inpatient medical and surgical branches. WHOQOL-BREF-TR scale, that validity and reliability study had done, was used to detect the quality of life of people in their physical, psychological, social and environmental areas. Statistical analyses of data were performed by SPSS 16.0 programe.

RESULTS: There were 352 participants in this study. 154 of them were men (43.8%) and 198 of them were women (56.3%). The average age of people was 54±18,2 (min:17, max:91). Of the patients who participated in the study, 176 (50%) hospitalized in internal medicine, 176 (50%) in the surgical departments. Of those; 23 (6.5%) had never married, 243 (69%) were married, 13 (3.7%) were divorced, 71 (20.2%) widowed, and 2 (0.6%) were separated. Widowed patients' social average score was significantly higher in female patients. Life quality of women in the social field, male patients was found to be significantly higher.

CONCLUSION: Quality of life scores of patients in surgical departments were high. Patients in the internal departments had lower life quality scores. Life quality of patients with chronic diseases such as hypertension, diabetes were lower than acute illness. Pain, weakness and limitation of motion were found to be the most important factors that affects quality of life.

Keywords: Quality of life, WHOQOL-BREF-TR, factors affecting life quality

P-1168**(The Impact of Anxiety on University Students And Their Daily Diet)**

Umut Gök Balcı¹, Yasemin Şimşek¹, Hande İleri¹, Özgür Alavcı¹, Kurtuluş Öngel²

¹Umut Gök Balcı, Yasemin Şimşek, Hande İleri, Özgür Alavcı, Department of Family Medicine, Tepecik Research and Training Hospital, İzmir, Turkey

²Kurtuluş Öngel, Department of Family Medicine, Katip Çelebi University, İzmir, Turkey

INTRODUCTION: Eating disorder is a risk factor among university students. Various studies in our country have showed that university students have not balanced eating habits

AIM: This study researched the eating habits and the influence of anxiety on eating habits of İzmir Katip Çelebi University Medicine students

MATERIAL METHOD: This study case was done in March-April-May 2014; based on 196 medicine students of Katip Çelebi University in their first, second and third classes. A survey was used to evaluate the eating habits of the students. The anxiety symptoms of the students were researched with the Beck Anxiety scale test. The data codification and statistic analysis were made with the Spss 18 windows computer program.

RESULTS: The study case had involved 196 student; 109 were female (55.6%) and 87 (44.4%) were male. The statistic parameters; age (p:0.000), usage of psychiatric drug (p:0.000), medical problems (0.006), study problems and obesity (0.018), eating disorder (guilt) (0.001), weighing frequency (0.001), change of eating habits before exams (p.0.032) have shown a significant correlation with Beck's Anxiety Scale Test.

CONCLUSION: In this study, the significant parameters correlated with anxiety were not studied before. Because of this each parameter should be researched in detail.

Keywords: (Anxiety, Eating habits, Students)

P-1169**The Knowledge, Attitudes and Behaviors of Postmenopausal Women in Osteoporosis**

Özge Berfu Gürbüz, Tuğba Onat, Rana Gündoğan, Kübra Uyar, Tuba Aydın, Vildan Mevsim

Department of Family Medicine, Dokuz Eylül University, İzmir, Turkey

BACKGROUND & AIM: The aim of this study was to determine the knowledge, attitude and behaviors of postmenopausal women (PMW) about osteoporosis.

METHOD: A cross-sectional analytical study design was applied to 200 PMW over the age of 45 in a postmenopausal clinic. Survey administered which's questions about demographics, osteoporosis knowledge, attitudes, and behaviors. Osteoporosis status of these patients was also assessed according to the DEXA results. Participants were questioned about osteoporosis knowledge, attitudes, and behaviors with respectively 13, 6, 9 questions. The knowledge score (KS) ≥ 26 (13-39), the attitude score (AS) ≥ 14 (7-21) and the behavior score (BS) ≥ 20 (10-30) considered 'good'. Data was analysed using descriptive, chi-square statistics, student t test and correlation analyses.

RESULTS: The average age of the participants 59.58 ± 7.9 where the average age of menopause was 50.66 ± 1.96 . 23.5 % of the participants had bone resorption. The average KS of the participants was 31.93 ± 4.83 ; the average AS was 16.41 ± 2.35 ; and the average BS was 19.73 ± 3.88 . KS of 14 %, AS of 16%, and BS of 41.5 % of the respondents was 'low'. 44.7 % of the participants with low score of knowledge and 61,7% of those with low score of behavior has osteoporosis. 37,5% of the participants with bone fractures has low KS and 41.7 % of those has bad AS. 89 % of the participants with good KS, have good attitude scores and 62,9% of those have good behavior scores also. There is moderately strong correlation between knowledge, attitudes and behavior scores.

CONCLUSION: Knowledge attitudes and behaviors of PMW about osteoporosis and its prevention is effective in preventing osteoporosis.

Keywords: postmenopausal women, osteoporosis, knowledge, attitude, behaviors

P-1170

Evaluation of the Relationship Between Sleep Disorders and Smoking and Use of *Nicotiana rustica* (Smokeless Tobacco)

Hamit Sırrı Keten¹, Hakan Öney², Celal Kuş³, Özgür Ersoy⁴, Oğuz Işık³, Mustafa Çelik³

¹Department of Family Medicine, Kurtul Family Health Center, Kahramanmaraş, Turkey

²Faculty of Arts and Humanities, Arts, Sciences & Technology University in Lebanon, Beirut, Lebanon

³Department of Family Medicine, Medical Faculty, Kahramanmaraş Sutcu Imam University, Kahramanmaraş, Turkey

⁴Department of Public Health, Medical Faculty, Cukurova University, Adana, Turkey

BACKGROUND: The present study aimed at evaluating the relationship between sleep disorders and smoking and use of *Nicotiana rustica* (smokeless tobacco).

METHOD: The present study was conducted in 10 coffee houses in Kahramanmaraş province located in the Mediterranean Region of Turkey between April 1st 2014 and September 1st 2014. The participants were informed of the study and 180 male subjects that provided written consent were included in the study. The smokeless tobacco users group was comprised of 60 subjects who were using *Nicotiana rustica* and the smoker group was comprised of 60 subjects who were smoking cigarettes. The control group was comprised of 60 subjects who indicated themselves as have never used any tobacco products. The Epworth Scale was used to evaluate excessive daytime sleepiness and the Pittsburgh Index was used to determine sleep quality. The maximum total score in Pittsburgh Index is 21 points and it contains 7 sub-dimensions, and maximum total score in the Epworth Scale is 24 points.

RESULTS: The mean age of the study subjects was 41.97±14.02 (min=18, max=65) years. The mean score in the Epworth Scale was 4.30±2.80 in the control group, 4.23±3.12 points in the smokers group, and 4.91±4.02 points in smokeless tobacco group. The study groups achieved similar scores in the Epworth Scale ($p=0.471$). The mean score in the Pittsburgh Index was 7.63±2.50 in the control group, 8.11±2.70 points in the smokeless tobacco group, and 8.95±3.04 points in the smokers group. The scores achieved in Pittsburgh Index were significantly higher in the smokeless tobacco group compared to other groups ($p=0.033$).

CONCLUSION: The study found that subjects that used tobacco products experienced daytime sleepiness similar to subjects who did not use tobacco products. Sleep quality was significantly lower in the smokeless tobacco group compared to smokers and subjects in the control group.

Keywords: Sleep Disorders, Smoking, *Nicotiana rustica*, Smokeless Tobacco)

P-1171

The Determination Of Acute Effects Of Maras Powder (Smokeless Tobacco) On Hemodynamic Parameters

Hamit Sırrı Keten¹, Soner Ölmez², Hüseyin Üçer³, Fatih Yıldırım³, Oğuz Işık³, Mustafa Çelik³

¹Department of Family Medicine, Kurtul Family Health Center, Kahramanmaraş, Turkey

²Department of Family Medicine, Samsat Family Health Center, Adıyaman, Turkey

³Department of Family Medicine, Medical Faculty, Kahramanmaraş Sutcu Imam University, Kahramanmaraş, Turkey

BACKGROUND: In this study it is aimed to determine the acute effects of maras powder (smokeless tobacco) on hemodynamic parameters.

METHOD: This study was conducted in 20 coffee houses in Kahramanmaraş city on 140 voluntary males. Brachial systolic blood pressure (SBP), diastolic blood pressure (DBP) and the heart rate (HR) were measured from the left arm by automated digital oscillometric device. The first HR, SBP and DBPs after a relaxing period of 15 minutes were accepted as the basal values. After the basal measurement, the measurements were performed on 5., 10., 15. and 20th minutes. Following the initial measurement, the participants were made to place and keep 1,5 grams of maras powder between the gingiva and the lower lip for 10 minutes. The measurements of the 5. and 10. minutes were performed when maras powder was still in participants' mouths. After measurement of the 10. minute, maras powder was taken out of the participants' mouths. $P<0,05$ was accepted to be statistically significant.

RESULTS: The mean age of the participants was 51.64 ± 13.46 . It was found that the HR, SBP and DBP values of 5., 10., 15. and 20. minutes were significantly higher compared to basal measurements ($p < 0.05$). It was determined that the HR, SBP and DBP were the highest at 5. minute when maras powder was still in mouth and decreased in following measurements.

CONCLUSIONS: We revealed that maras powder increased the HR, SBP and DBP acutely and significantly in our study. This effect of maras powder on hemodynamic parameters indicate that it is an important risk for cardiovascular diseases.

Keywords: smokeless tobacco, maras powder, heart rate, hemodynamic

P-1172

Nicotine Dependence and Related Factors

Ayşe Didem Esen, Seçil Arıca, Begüm Koçar, Ayla Karaca, Umut Karagöz, Gülten Belgin, Şeniz Suvan
Department of Family Medicine, Okmeydani Research and Training Hospital, Istanbul, Turkey

BACKGROUND: The aim of this study is to define properties of patients and risk factors who has applied to smoking cessation unit in our hospital.

METHODS: The study included 415 cases who applied smoking cessation unit between january and april in 2015. SPSS software version 15.0 was used for statical analysis. Destriptive analyses, chi-square tests, in parametric data pearson correlation analysis and in non-parametric data spearman correlation analysis was performed. Logistic regresyon analyzis was used to define risk factors of smoking.

RESULTS: 415 cases include 172 male, 243 female. 16% attended smoke cessation unit by doctor advice. 214 cases were living in the house with smokers Mean fagerstrom nicotine addiction level was 5.64 ± 2.59 and mean CO level was 7.82 ± 5.16 . The median ages of beginnig to smoke were in female 17(8-47), in male 15 (7-49) and the difference was significant($p = 0.0001$). There was not a significant correlation between education level ($r = 0.123$ $p = 0.07$). There was a positive correlation between amount of cigarettes smoked per day and fagerstrom score ($r = 0.618$, $p = 0.0001$). There was a positive correlation between cigarettes per day and CO level. Fagerstrom score and CO level had a positive correlation ($r = 0.337$, $p = 0.001$). There was negative correlation between how much minutes passed after last cigarette smoking time and CO level ($r = 0.226$, $p = 0.001$). Amount of cigarettes per day and years of smoking had a positive correlation ($r = 0.129$, $p = 0.008$). 54.7% of male and 60.5 % of female smokers found to have high grade nicotine dependence. Beginning to smoke before age of 15 and low education level were not a risk factor for high grade nicotine dependence.

CONCLUSION: Fagerstom score was correlating with amount of cigarette per day and CO level but not correlating with age of beginning to smoke and years of smoking. Also some demographic features of patients were effective on nicotine dependence

Keywords: Fagerstrom score, nicotine dependence, smoking cessation

P-1173

Recreational Drugs: what the family physician should know

Vanessa Carvalho¹, Leonor Troni², Catarina Bastos³, Arnaldo Abrantes⁴

¹USF Cynthia

²USF D. Jordão

³USF Sobreda

⁴USF Dafundo

INTRODUCTION: Recently several of new recreational drugs have arisen. It can be synthetic compounds or originate in natural products. Psychoactive substances are easily accessible, providing a challenge for health professionals that should play an important role in preventing consumption.

OBJECTIVE: Review the approach of recreational drug use in Primary Health Care.

METHODOLOGY: Proceeded to the literature of Evidence Based Medicine databases, using the keywords: recreational drugs, primary care. The search was limited to articles in English and Portuguese published between 2005 and May 2015.

RESULTS: The clinical manifestations of drug abuse vary according to the route of administration, concentration, excipients, and can be intensified by concomitant ingestion of alcohol. It may be variable and often difficult to attribute to drug use. The most important is the recognition of dependence. It's difficult to distinguish between experimentation, frequent use and abuse. The lower the age of onset of drug use, the higher the risk of pathological consumption and dependence in adulthood. The main risk factors are family history of addiction, school failure, low self-esteem, aggressive or impulsive personality, psychiatric pathology, family instability and low socioeconomic level. Intervention should be initiated by a motivational interview guided by an empathetic attitude without prejudice. In the anamnesis it's important questions about professional and social activities, family atmosphere, food and drug habits and ultimately toxic habits. The complete physical examination should be performed and further diagnostic tests may be need.

DISCUSSION: Most of the recreational drug users use them temporarily and intermittently. It's recommended a phased intervention that should be initiated by a motivational interview. If the patient does not respond to this brief intervention but are motivated, referral for more specialized care should be considered. The family physician should be able to monitor drug use, its cessation and the progression of physical and mental symptoms.

Keywords: Recreational Drugs, primary health care, intervention

P-1174

{Publication status of all scientific papers presented in WONCA Europe Conferences between 2006-2013: Reflections to research quality in primary care }

Adem Ozkara, Rabia Kahveci, Ummugulsum Yildiz, Ismail Kasim, Irfan Sencan, Rumeysa Agbektas

Department of Family Medicine, Ankara Numune Training and Research Hospital, Ankara, Turkey

OBJECTIVE:

Our aim is to find out the quality of researches in primary care by detecting transforming ratio of presentations to manuscripts and quality levels via several quality indicators (degree of journal, impact factors and citations etc.) of WONCA Europe Conferences, which constitute supreme presentation level of primary care researches.

METHODS:

Five thousand seven hundred thirty-four abstracts that were presented at Wonca Europe Conferences between 2006 and 2013 were evaluated in this study. Publication status was assessed from PubMed, Google Scholar and Clinical Key. Journal name, publication date, impact factors, inclusion in Index Medicus and number of citations were determined. Mean duration between date of presentation at the congress and date of publication was also calculated. Abstracts were assessed according to their being presented as posters, oral presentations and receiving an award.

RESULTS:

Table 1

Database searches are still running and final results are planning to be shared in WONCA Europe 2015.

CONCLUSIONS:

Primary care is a real indicator of health status of community. Hospital data only will not reveal health status, disease distribution, community reaction to diseases or effect of diseases on community. That's why research in primary care is a necessity. Value of research is determined by research quality. We believe this study would contribute to comment on success of research by years between 2006 to 2013.

Keywords: research quality, wonca conferences, manuscripts, publication

Table 1

WONCA Europe Conferences	Years	Oral Presentations	Poster Presentations	Total
Florence	2006	71	97	168
Paris	2007	292	651	943
Istanbul	2008	319	635	964
Basel	2009	300	555	855
Malaga	2010	517	679	1196
Warsaw	2011	270	483	753
Vienna	2012	269	607	876
Prague	2013	600	500	1100
Total		2638	4207	6845

The Number of Oral and Poster Presentations by Years

P-1175

"Use of Antibiotics for Upper Respiratory Tract Infections at the Family Medicine Out-patient Clinic at a University Hospital"

Seda Coskun, Zehra Dağlı, Ayşe Selda Tekiner, Ayşe Gülsen Ceyhan Peker, Mehmet Urgan

Ankara University Faculty of Medicine, Department of Family Medicine, Ankara, Turkey

OBJECTIVE: Antibiotics are mostly prescribed for respiratory tract infections in primary care. For ideal antibiotic use, the right antibiotic should be given at effective doses with optimum range for appropriate duration after accurate diagnosis. The study aimed to determine oral antibiotic preferences and rates in patients with upper respiratory tract infections (URTI) at a family medicine out-patient clinic.

METHODS: The retrospective, cross-sectional, and descriptive study included 434 patients who were prescribed for URTI for once at a family medicine out-patient clinic of a university hospital in Ankara between August 1, 2012 and July 31, 2013. Descriptive statistics were given as mean±standard deviation and percentage. Chi-square test was used for differences between the groups. Any p<0.05 was considered statistically significant.

RESULTS: Mean age of 434 patients (36.6% male, 63.4% female) was 33.45±16.36 years. The diagnoses made were acute tonsillitis (30.9%), acute sinusitis (30.0%), acute pharyngitis (16.4%), undifferentiated URTI (11.8%), acute nasopharyngitis (9.2%), influenza (1.2%), chronic sinusitis (0.5%), and both acute sinusitis and acute pharyngitis (0.2%) in order of frequency. Amoxicillin/clavulanic acid (59%), symptomatic treatment (27.9%), and clarithromycin (6%) were prescribed most frequently. The most common antibiotic groups preferred were synthetic penicilines (27%), macrolids (7.3%), and cephalosporins (4.1%). There was no statistically significant difference between the diagnosis and the method of treatment chosen (p<0.001). No antibiotics were prescribed to patients with influenza, whereas 17.5% of those with acute nasopharyngitis received antibiotic treatment.

CONCLUSION: The patients with URTI were most commonly treated with amoxicillin/clavulanic acid, however, antibiotic therapy was initiated in one fifth of viral acute nasopharyngitis cases. That may be because most of the care of the patients was given by family medicine residents relatively less experienced in medicine, therefore, rational antibiotic use and patient-physician communication should be emphasized in both continuous medical education and specialty training.

Keywords: Upper respiratory tract infection, antibiotic treatment, primary care

Table 1. Distribution of patients according to age groups

Age group (year)	Number (n)	Percentage (%)
0-5	30	6.9
6-12	35	8.1
13-18	18	4.1
19-40	210	48.4
41-64	127	29.3
≥ 65	34	7.8

Figure 1. Distribution of patients according to months of attending

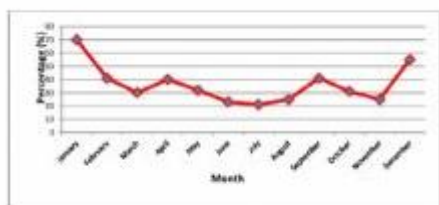
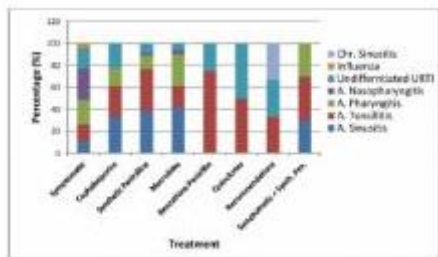


Table 2. Distribution of patients according to treatment given

Treatment	Number (n)	Percentage (%)
Symptomatic	115	26.5
Cephalosporin	18	4.1
Synthetic penicillin	125	28.8
Macrolids	31	7.1
Beta-lactam penicillin	4	0.9
Quinolones	2	0.5
Respiratory stimulants	3	0.7
Symptomatic+Synthetic pen.	5	1.2
Symptomatic+Macrolides	1	0.2

Figure 2. Distribution of the treatment method selected according to diagnosis



P-1176

Evaluation of Daily Life Activities in Home Care Patients

Sevim Ogulmus¹, Irep Karatas Eray¹, Pinar Ilhan², Aylin Baydar Artantaş¹, Tuncer Kilic², Mehmet Ugurlu²

¹Department of Family Medicine, Atatürk Training and Research Hospital, Ankara, Turkey

²Department of Family Medicine, Yıldırım Beyazıt University Faculty of Medicine, Ankara, Turkey

OBJECTIVE: The purpose of this study is to determine the ability to do the daily activities of home care patients.

METHODS: The sample of the research includes 303 patients who were registered in a database of a training and research hospital offering home care services. Research data were collected through The Katz Index of Independence in Activities of Daily Living. The Index was developed to provide a standardized quantitative measure of functional changes in the chronically ill and the elderly. The Index ranks adequacy of performance in the six functions of bathing, dressing, toileting, transferring, continence, and feeding. A score of 6 indicates full function, 4 indicates moderate impairment, and 2 or less indicates severe functional impairment(1).

RESULTS: Of the 303 subjects in the study, 207(55.8%) were females and 96(44.2%) were males, with an overall mean age of 75,39. It was determined that the patients had a Katz Index of Independence in Activities of Daily Living mean score of 1,92 and 66,6% were severe dependent, %14,6 were semi-dependent. %76,2 of the primary caregivers were women with an overall mean age of 57,01. The caregivers were mostly university graduates(%39,6). Only %5,8 of the caregivers were trained for caring patient.

Conclusions: The result of this study show the needs of organizations and health care professionals. It is suggested that necessary care and help should be provided to support independence of elderly people in their daily life activities. Most of the homecare patients are dependent to caregivers so there is a need for formal training for the caregivers.

Keywords: Home care patients, Katz daily livings activity, Caregivers

Figure 1:The Katz Score of Patients

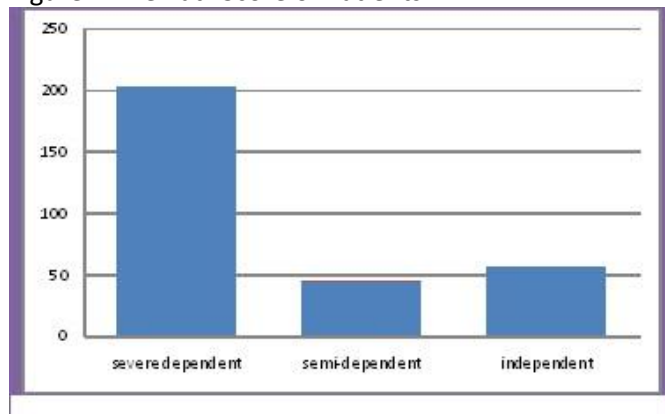
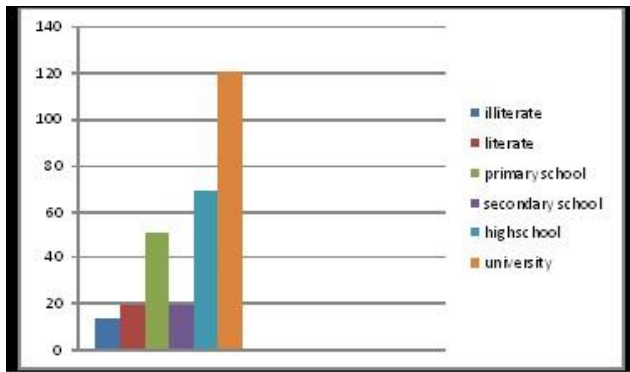


Figure 2:The Educational Levels of Homecare Givers



P-1177

{Do all abstracts end up with publications in peer-reviewed journals?: An overview of Wonca Europe 2008 Istanbul Conference}

Adem Ozkara, Rabia Kahveci, Ummugulsum Yildiz, Ismail Kasim, Irfan Sencan, Rumeysa Agbektas
 Department of Family Medicine, Ankara Numune Training and Research Hospital, Ankara, Turkey
 Aim

Our aim is to review abstracts that were presented in Wonca Europe 2008 Istanbul Conference and find out publication ratio of these abstracts in peer-reviewed journals as of today. This is part of a larger project which explores research quality in primary care.

Methods

Oral and poster presentations of Wonca Europe 2008 Istanbul Conference are reviewed. Manuscripts investigated in several scientific search portals according to authors, key words and title. All found manuscripts listed and classified as SCI classified journals, national indexes and peer-reviewed journals. Contacting with authors, where possible, is also planned not to miss any potential paper. As a last step we calculate publication ratio of reports as well as determine publication quality by journals' classification.

Results

The total number of abstracts were 954 (Oral Presentation 319, Poster Presentation 635) from a total number of 49 countries. Database searches are still running and final results are planning to be shared in WONCA Europe 2015.

Table 1

Conclusions

It is important to increase quality of research in the primary care. Although one conference will not be enough to map the whole research quality and how well abstracts form the basis for future articles, we believe this study would still give us a good idea about the current status in Europe. A broader project tackling several different aspects will help us outline current activities in primary care research field in Europe.

Keywords: research quality, wonca conferences, manuscripts, publication

Table 1. Study type and publication status according to abstract presentation type

		Oral	Poster	Total
		n(%)	n(%)	
Study type	Research	312(33.7)	615(66.3)	927
	Case Report	2(18.2)	9(81.8)	11
	Review	6(35.3)	11(64.7)	17
Publication status	Not published	249(30.8)	559(69.2)	808
	Published	71(48.3)	76(51.7)	147
Total		320(33.5)	635(66.5)	955

Statistically difference in rate of publication is observed in respect of the type of presentation. (P<0.001, X2:17.61)

Table 2. Impact factor classification according to presentation type

Impact Factor	Oral Presentation	Poster Presentation	Total
	n(%)	n(%)	
0-0,99	25(53.2)	22(46.8)	47
1-1,99	23(48.9)	24(51.1)	47
2-2,99	9(28.1)	23(71.9)	32
3-5,99	9(64.3)	5(35.7)	14
≥6	5(71.4)	2(28.6)	7
Total	71(48.3)	76(51.7)	147

P-1178

Homicides Against Women of Reproductive Age: a Public Health Problem of a Brazilian Metropolis

Ana Luísa Franco Moura, Gustavo Aguilar Alvarenga Amorim, Lara Louise Guimarães Silveira, David Carvalho Rezende, Wallace Pinheiro Rodrigues, Lorena De Almeida Ribeiro Prudente, Vinicius Bernardes Mendonça Damasceno, Natália Carasek Matos Cascudo, Camila Garcia De Souza, Aysa Teles Abrão Trad
School of Medicine, Federal University of Goiás, Goiânia, Brasil.

Since 1990, violence against women has been considered by the World Health Organization a problem of public health, that can even result in death of woman by murder.

The aim of this work was to show the importance of homicides as cause of death between women of reproductive age in the city of Goiania - GO.

We used as method the analysis of data from the death declarations of women in reproductive age (10 to 49) residents in the city of Goiania - GO, in the period of January to December of 2013. The variables age, cause of death, marital status and education were collected for the study. The search of these data was carried out in the Health Information Division of the Department of Epidemiology at the Municipal Health Secretary of Goiania - GO. In 2013, murders were responsible for 10,83% of deaths between women of reproductive age in the city of Goiania - GO. The age group with the highest number of cases was 20-29 years, with 43,14%. As the civil state, 72,55% of women who died by murder were divorced or single. As for education, 62,74% had completed only elementary school. On the other hand, only 5,88% had completed higher education.

With this work, it was concluded that murders are an important cause of death between women of reproductive age in the city of Goiania - GO. Measures as largest investments in education and awareness campaigns on violence against women may show effective in reduction of these killings.

Keywords: Women, murder, mortality.

P-1179**Cigarette Smoking and Thiol /Disulphide Homeostasis**

Ahmet Keskin¹, Yusuf Üstü¹, Basri Furkan Dağcıoğlu¹, Tuncer Kılıç¹, İrep Karataş Eray², Aylin Baydar Artantaş², Mehmet Uğurlu¹

¹Department of Family Medicine, Yıldırım Beyazıt University, Ankara, Turkey

²Department of Family Medicine, Atatürk Training and Research Hospital, Ankara, Turkey

OBJECTIVES: Thiol/ disulphide homeostasis has a critical role on cellular events like antioxidant protection and apoptosis. It is known that there is an increase of oxidative stress accompanying chronic diseases. It is shown in many studies that smoking may enhance oxidative stress through the production of reactive oxygen radicals in smoke and weakening of the antioxidant defense systems. We aimed to investigate the relationship between cigarette smoking and thiol/disulphide homeostasis which is a new indicator for the oxidative stress.

METHODS: Thiol / disulphide homeostasis parameters were studied in the blood samples of 62 smokers and 68 non-smokers in the control group, who were 18 years or over and admitted to outpatient clinic of our hospital between December 2014 and March 2015. Subjects were selected from 574 patients according to exclusion criteria including history of chronic disease, alcohol consumption and malignancy. Venous blood samples were taken from all subjects and plasma obtained by centrifugation 15 min at 3600 rpm. After that, native thiol, disulphide, total thiol, index 1 (disulphide/native thiol), index 2 (disulphide/total thiol) and index 3 (native thiol/total thiol) levels were measured by an automated colorimetric analyzer. Statistical analyzes were performed on 130 patients who were included to the study.

RESULTS: Index 1 and index 2 levels of smoking patients were significantly higher than the control group [(p:0,018; Z:-2,37) and (p:0,005; Z:-2,78) respectively]. Native thiol, disulphide and total thiol levels tended to be higher on patient group too, whereas the difference was not significant.(Table 1)

CONCLUSION: These findings are the first results of our continuing study and we aim to finish the process with higher amounts of patient data in order to publish the final results. Further studies may reveal the clinical importance of dynamic thiol/disulphide homeostasis on many conditions like cigarette smoking.

Keywords: Thiol Disulphide Homeostasis, Smoking, Oxidative stress

Table 1

Parameters	Groups	N	Mean Rank	p	Z
Native Thiol	Non-smoker	68	65,25	0,937	-0,7
	Smoker	62	65,77		
	Total	130			
Disulphide	Non-smoker	68	60,32	0,100	-1,64
	Smoker	62	71,19		
	Total	130			
Total Thiol	Non-smoker	68	64,29	0,702	-0,382
	Smoker	62	66,82		
	Total	130			
Index 1	Non-smoker	68	58,15	0,018	-2,37
	Smoker	62	73,56		
	Total	130			
Index 2	Non-smoker	68	56,95	0,005	-2,78
	Smoker	62	74,88		
	Total	130			
Index 3	Non-smoker	68	70,06	0,146	-1,45
	Smoker	62	60,50		
	Total	130			

Results of Statistical Analysis

P-1180

Mortality by Cancer in a Female Population of a Brazilian Metropolis

Ana Luísa Franco Moura, Lara Louise Guimarães Silveira, Gustavo Aguiar Alvarenga Amorim, David Carvalho Rezende, Wallace Pinheiro Rodrigues, Lorena De Almeida Ribeiro Prudente, Vinicius Bernardes Mendonça Damasceno, Natália Carasek Matos Cascudo, Camila Garcia De Souza, Ayssa Teles Abrão Trad
School of Medicine, Federal University of Goiás, Goiânia, Brasil.

The progressive increase in life expectancy of the Brazilian population in recent decades has brought with chronic diseases, including cancer.

The aim of this study was to show the importance of cancer as a cause of death among women in the city of Goiania - GO.

The method used was the collection and analysis of data obtained from death certificates of women of childbearing age (10 to 49) living in the city of Goiania - GO. The variables type of cancer, age and education were collected for the study. The survey of all data was carried out in the Health Information Division of the Municipal Health Department of Epidemiology of the city of Goiania - GO. The period for data collected was from January to December of the year 2013.

In 2013, cancer accounted for 25.48% of deaths among women of childbearing age in the city of Goiania - GO. The five most common cancers were breast, with 34,17%; the cervical, with 10,83%; the intestine, 7,5%; Leukemia, 7,5%; and lung, with 6,67%. The age group with the highest number of cases was 40-49 years with 63,33%. On the other hand, the age group 10 to 29 years accounted for 9,17% of all cancer deaths. As for education, only 15,83% of women who died of cancer had a full university degree, while 31,67% of them had no schooling or had only completed elementary school.

With this work, it was concluded that cancer is a leading cause of death among women of childbearing age in the city of Goiania - GO, requiring policies aimed at public awareness of this fact, especially the attention to women who are in the fourth decade of life and/or who have low educational attainment.

Keywords: Women, cancer, mortality.

P-1181

Nutritional Status of Home Care Service

Pınar İlhan¹, İrep Karataş Eray², Sevim Öğülmüş², Ahmet Keskin¹, Furkan Dağcıoğlu¹, Yusuf Üstü¹

¹Aile Hekimliği Ana Bilim Dalı, Yıldırım Beyazıt Üniversitesi Tıp Fakültesi, Ankara, Turkey

²Aile Hekimliği Ana Bilim Dalı, Atatürk Eğitim Araştırma Hastanesi, Ankara, Turkey

NUTRITIONAL STATUS OF HOME CARE SERVICE

OBJECTIVE: The growing need for home care services is due to the rising age of population, increasing rate of chronic illnesses and disabilities in Türkiye and around the world. An imbalance (deficiency or excess) of energy consumption, together with protein, and other nutrients' intake causes malnutrition. This study was designed to determine nutrition status of the patients who were registered in home care service.

The 'Malnutrition Universal Screening Tool' ('MUST') was designed to help identify adults who are underweight and at risk of malnutrition. 'MUST' has classified patients for their risk of malnutrition in an easy, rapid and reproducible manner. (1)

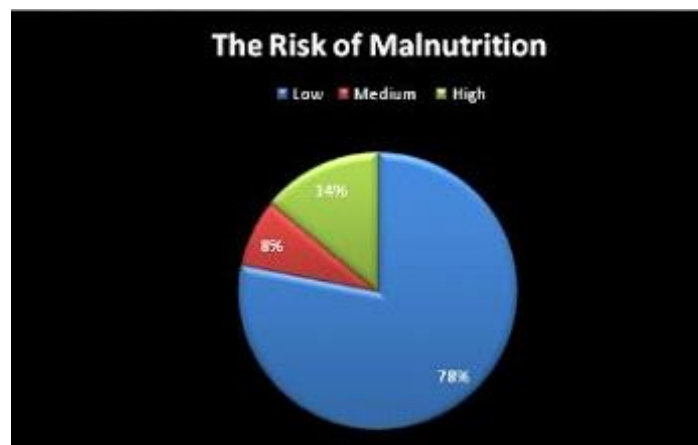
METHODS: This cross-sectional study was carried 303 patients who were registered in home care unit of Atatürk Research and Training Hospital in Ankara. 'MUST' was used to determine the nutrition status. Scores classified as low, medium or high risk.

RESULTS: In the study, most of the patients were women (n= 207). Mean age was 75 and 245 of the patients had at least one chronic illness. 21.87 % of the patients (n=63) were at risk of malnutrition (medium and high risk). And 11.55 % of them had decubit ulcer (n=35)

DISCUSSION: Malnutrition and risk of malnutrition are common among elderly patients. Primary care physicians who provide home care services have a primary role in the care of the such patients. 'MUST' could be used in the early diagnosis of malnutrition among these patients. Individuals who are at risk of malnutrition should be evaluated as soon as possible to receive the necessary treatment and dietary supplement. In summary, 'MUST' is provided to assess the nutritional status of patients for early diagnosis and this will positively effect general health status.

Keywords: Home care, Malnutrition Universal Screening Tool, Nutrition

Fig. 1.



The Risk of Malnutrition

P-1182

Chronic Pain Management: The Role of The Primary Care Prescriber

Josephine Rebecca Fowler

Office of Academic Affairs & Department of Family Medicine, JPS Health Network, Fort Worth TX USA

State and federal laws are in place to abate misuse of pain medication especially narcotics. As a result of laws and the onslaught of patients seeking narcotics, primary care physicians have decreased the number of prescriptions written for chronic pain and tend to refer those patients to a pain specialist. In an attempt to avoid "drug seeking" behavior and over writing of narcotics. Over the past years, the use of 'narcotics first' has continued to increase in emergency and primary care. In 2014, the most commonly prescribed narcotic pain medications in the state were reassigned to more restricted prescribing practices changing the way teaching hospitals are able to prescribe, namely reallocating responsibility to faculty. Training in pain management is needed.

Methods

Practice gaps were determined through a review of specialty clinic referrals for pain management with specific pain management ICD-9 codes. Educational needs were based on determined practice gaps and qualitative data. Three CME programs on Pain Management were conducted in various formats. Attendees were recruited using standard CME methods. Attendance was voluntary. A follow-up survey was administered to each attendee that filled out a survey at a session; the follow-up survey contained questions inquiring about the attendee's implementation of the material presented in the session(s) they attended. Outcomes were evaluated by analyzing responses on surveys and querying patient visits for pain management.

Results

Pain management education was received favorably. Participants stated they were willing to assess and change their practice. Acupuncture and alternative options were unfamiliar to most prescribing pain medication. A large amount stated that acupuncture could have helped their patients with pain.

Conclusion

Chronic Pain is a problem in many practices and varies across regions. Stepwise management is rarely used. Persistent education about a systematic approach to pain management is pertinent to improving prescribing methods.

Keywords: Narcotics, Primary Care, Education

Figure 1: Type of Learner (%Type)

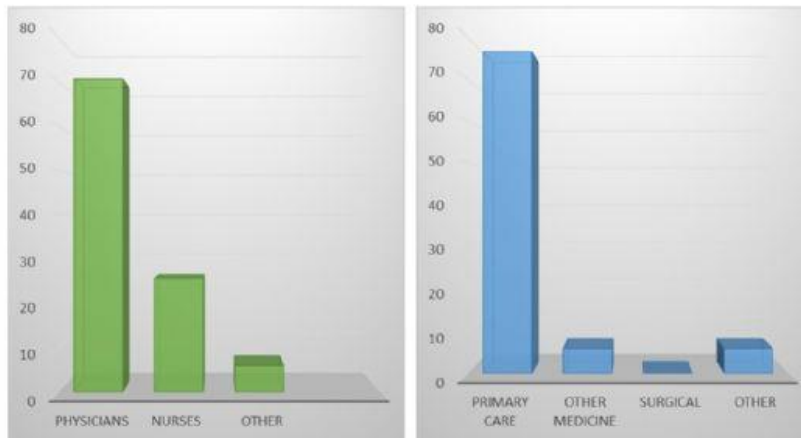
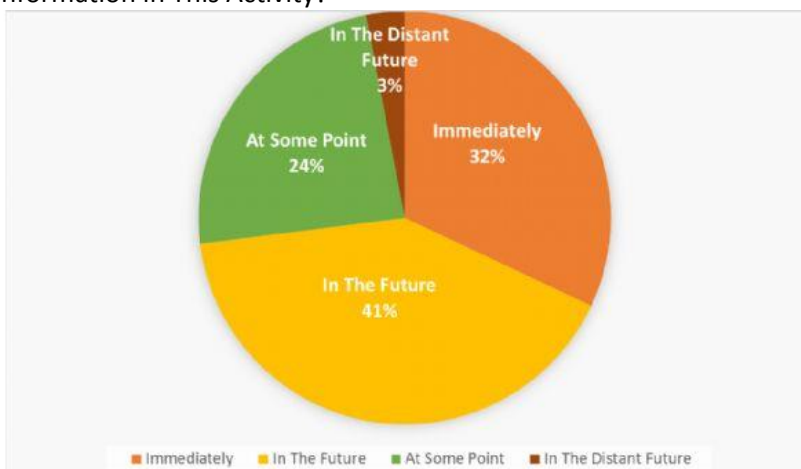


Figure 2: How soon Do You Plan To Evaluate Your Approach To Chronic Pain Management Based on The Information in This Activity?



Development and Validation of a Personality Type Inventory Based on Enneagram

Kenan Taştan, Zekeriya Aktürk, Memet Işık

Department of Family Medicine, Atatürk University, Erzurum, Turkey

INTRODUCTION: The Enneagram of Personality is an ancient model of human personality, which is principally understood and taught as a typology of nine interconnected personality types. There is no inventory in Turkish measuring Enneagram personality types.

AIM: The aim of this study was to develop a Turkish inventory based on the Enneagram principles.

METHODS: The final questionnaire consisting of 44 questions was applied to a sample of 156 Turkish-speaking participants using a Likert scale ranging from 0 to 6. Expert validation, factor analysis and internal consistency were applied. Data analysis was done with the SPSS version 20.

RESULTS: Of the participants 89 were females (57.4%) and 66 were males (42.6%). Mean age of the participants was 30.52±10.0 years. Most of the participants were university graduates/students (n=113; 72.4%). Cronbach alpha value for the total items was 0,839 with a split half value of 0.817 for part 1 and 0.757 for part 2. Guttman Split-Half Coefficient was calculated as 0.520. Confirmatory factor analysis showed that the nine components explained more than 60% of the total variance

In the confirmatory factor analysis all items except item 22 had factor loadings ranging from 0.411 to 0.829. Mean sensitivity and specificity of the instrument for detecting different personality types was high (82.8% and 97.8% respectively). While specificity was above 94% for all domains, sensitivity for type 4 personality was 66.7%.

DISCUSSION: We conclude that the Taştan Personality Type Inventory is an effective tool in identifying personality types according to the Enneagram principles in Turkish citizens.

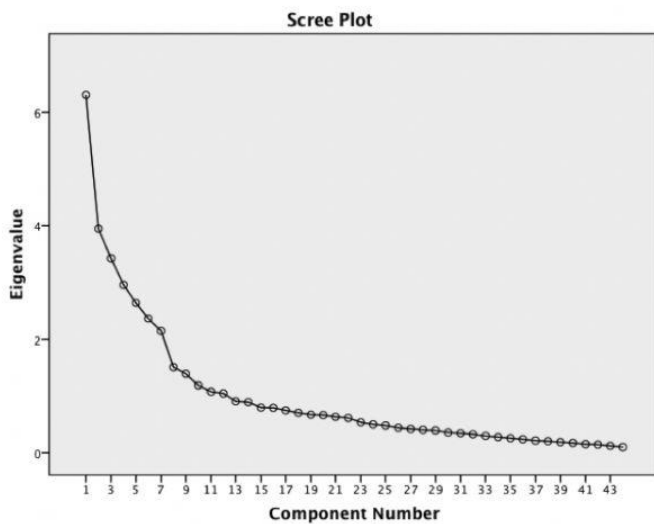
Keywords: Personality types, Enneagram, Patient communication

Items of the personality type inventory

İfça B. 2021 yılında bu çalışmada ve yayımlanmasında için http://dx.doi.org/10.15013/psf010002_0001_01_kenan-tastan adresine bakınız

TAŞTAN İŞKUR TİPİ ÖLÇEĞİ								
No	Yorum: Cevap: 1-4 () 2-6 () Mesajlar: Etkilemeler: <input type="checkbox"/>	Değerlendirme türü:	1-Hayat	2-Kararlar/Hayat	3-Nokta ve Hayat	4-Kararlar ve Hayat	5-Evet	6-Değerlendirme evriği
1	Bütün seçeneklerim değiştiğimi için aklıma geçmekte zorlanırım.							
2	Değerler konusunda çok hassasım.							
3	Kayıplar bir bakiye kaybetmiş gibim.							
4	Hayatın tehlikeli ve dağınık olduğunu her zaman hissettim.							
5	Yaptığım işi en ince ayrıntısına kadar düşünür, öyle yaparım.							
6	Ayıklağınla bürünm.							
7	Çok zihinsel ve duygusal açıdan çalışırım.							
8	İnsanlara bencim, işi yaptırıp çarpmadan doğuştan konuşmalarını isterim.							
9	Takdir etmek benim için çok önemlidir.							
10	Bir iş yaptığım insan çok yöresizdir, işi andın alıp konum tamamlarım.							
11	Çok acıma bürünm.							
12	Çok çalışkan bürünm.							
13	İhtiyaç ettiğim her şeyi için atılacak kararım.							
14	Her zaman ulaşmak istediğim bir hedefim vardır.							
15	Her zaman yapacak işim vardır.							
16	Çabuk kırılabilirim.							
17	Çok hissus bir insanım.							
18	Çok yüksek duygular yaşarım.							
19	İhtiyaç ettiğim her şeyi için çalışırım.							
20	Sık sık hissettiğimdir.							
21	Araştırmacı bürünm.							
22	Aynı işi çok sık tekrar ederim.							
23	Çalışma yöntemim çok dardır.							
24	Hayatı düşünmek çok gerektirir.							
25	Sahip olduğum bir şeyimdir.							
26	Kendimi emsallerimle karşılaştırmak için sürekli olarak düşünürüm.							
27	İnsanlar beni çok takdir ederler.							
28	Sürekli olarak risk almama engel olur.							
29	Yaratıcı potansiyelimde sınırların rahatsızlık duyuyorum.							
30	Aynı işi çok sık tekrar ederim.							
31	İhtiyaç ettiğim her şeyi için çalışırım.							
32	Genelde nazik bürünm.							
33	Önceliklerimden önce diğer şeyleri düşünürüm.							
34	Önceliklerimden önce diğer şeyleri düşünürüm ama diğer insanların beni kolay kolay unutmasınlar.							
35	Her işi bitiririz.							
36	Her zaman kendim için düşünürüm, düşünürüm.							
37	Herkesin farkında olduğumu düşünürüm.							
38	Her işi bitiririz.							
39	Tarafımızda kolay kolay geri adım atmam.							
40	İhtiyaç ettiğim her şeyi için çalışırım.							
41	En çok kayıplarımı düşünürüm.							
42	En önemli değerlerimden biri olanı düşünürüm.							
43	Her işi bitiririz.							
44	Sabırlı bürünm.							

Scree plot showing cumulative Eigenvalues of the different components.



P-1184

Sleep quality and day time sleepiness in healthy adults with active or passive smoking (Early results)

Ayşe Yılmaz¹, Tuncer Kılıç¹, Melike Esen¹, Esra Demir¹, Ahmet Keskin¹, Basri Furkan Dağcıoğlu¹, İrep Karataş Eray², Aylin Baydar Artantaş², Yusuf Üstü¹, Mehmet Uğurlu¹

¹Department of Family Medicine, Yildirim Beyazıt University, Ankara, Turkey

²Department of Family Medicine, Atatürk Education and Research Hospital, Ankara, Turkey

BACKGROUND & AIM

It is well known that both active and passive cigarette smoking lead to severe health problems. Although there are several studies demonstrating impaired sleep quality with healthy adults with active smoking, data regarding passive smoking is limited. The aim of this study is to investigate sleep quality and day time sleepiness in healthy adults with active or passive smoking.

METHODS

We enrolled 48 healthy adults with active or passive smoking (18 of them were passive, 30 active smoker) and 27 healthy controls who had never smoked and had no regular exposure to cigarette. Pittsburgh Sleep Quality Index (PSQI) and Epworth Sleepiness Scale(ESS) questionnaire were used. Statistical analysis was done using SPSS 20.

RESULTS

The main demographic characteristics were comparable between groups. There was significant difference between control and any type of smoking group (active or passive) in terms of PSQI and ESS (Table1). PSQI and ESS scores of passive smokers were significantly high compared with the control group. PSQI and ESS scores of active smokers were significantly high compared with the control group. But no significant difference was seen between active and passive smoking group in terms of PSQI and ESS (Table 2,3,4).

CONCLUSION:

Passive smoking is associated with poor sleep quality as well as active smoking.

Keywords: Sleep quality, Day time sleepiness, Passive Smoking, Active smoking

table1

Variables	Control (N=27)	Active or Passive Smokers (N=48)	P values
PSQI	3,89±1,8	6,08±2,8	0,001
ESS	3,07 ±2,2	5,87 ±3,8	0,001

PSQI: pittsburgh sleep quality index ESS: epworth sleepiness scale

table2

Variables	Control (N=27)	Active Smoking (N=30)	P values
PSQI	3,89±1,8	5,9 ±3,1	0,01
ESS	3,07±2,2	5,72±4,2	0,01

PSQI: pittsburgh sleep quality index ESS: epworth sleepiness scale

table3

Variables	Control (N=27)	Passive Smoking (N=18)	P values
PSQI	3,89±1,8	6,3±2,5	0,001
ESS	3,07±2,2	6,11±2,8	0,001

PSQI:pittsburgh sleep quality index ESS: epworth sleepiness scale

table4

Variables	Active Smoking (N=30)	Passive Smoking (N=18)	P values
PSQI	5,9 ±3,1	6,3±2,5	0,31
ESS	5,72±4,2	6,11±2,8	0,56

PSQI: pittsburgh sleep quality index ESS: epworth sleepiness scale

P-1185

Topical estrogen therapy in labial adhesion

Daniela Pedrosa Costa¹, Sónia Manuela Rodrigues Moreira², Sofia Rendeiro Correia Pinto³, Célia Pinto Saraiva Oliva⁴, Pedro Miguel Paulino Pereira⁵

¹Unidade Saúde Familiar Torrão, Lousada, Portugal

²Unidade Saúde Familiar Torrão, Lousada, Portugal

³Unidade Saúde Familiar S. João, Oporto, Portugal

⁴Unidade Saúde Familiar Além D'Ouro, Gaia, Portugal

⁵Unidade Saúde Familiar Vale do Vez, Viana do Castelo, Portugal

Background & AIM:

Labial adhesion can be diagnosed in prepubertal girls in family practice. It's estimated prevalence is of 1.8% and occurs predominantly between 13-23 months of age. Mostly asymptomatic, it can complicate with local inflammation, dysuria, urinary tract infection and obstruction.

Our aim is to review the available evidence relative to the efficacy of topical estrogen in labial adhesion in comparison to other topical treatments.

METHODS:

Review on guidelines, systematic reviews and randomised controlled clinical trials on Medline/Pubmed database using the MeSH terms "labial adhesion" OR "labial fusion" OR "labial agglutination" AND "topical estrogens".

Studies in english, portuguese, spanish and french published between January 2005 and March 2015 were included. To evaluate the strength of recommendation and body of evidence, the Strength of Recommendation Taxonomy (SORT) of American Family Physician was used.

RESULTS:

A total of 9 articles were identified, 6 of which met the selection criteria: one systematic review (level of evidence, LE 1) and four randomised controlled clinical trials (three LE 2, one LE 3) that recommend topical estrogen use only in symptomatic cases. One randomised controlled clinical trial (LE 2) recommends the use of


topical estrogen whether the labial adhesion is symptomatic or asymptomatic.

Conclusion

Although the number of studies available are scarce, the results are relatively homogeneous, stating that topical estrogen can be used for labial adhesion resolution, primarily when it is symptomatic. Nevertheless topical corticoids are frequently the chosen treatment. We consider that the scientific evidence is insufficient to recommend in favour or against the use of topical treatments in labial adhesion.

Keywords: labial adhesion, labial fusion, labial agglutination, topical estrogen

epostor suggestion



Topical estrogen therapy in labial adhesion

Pedrosa D.^{1,11}; Moreira S.¹²; Correia Pinto S.¹²; Oliva C.¹³; Pereira P.¹⁴
Family Medicine trainees in USF Torrão¹¹, USF S. João do Porto¹², USF Aem D'ouro¹³; USF Vale do YeZ¹⁴

Background

Labial adhesion can be diagnosed in prepubertal girls in family practice. It's estimated prevalence is of 1.8% and occurs predominantly between 13-23 months of age. Mostly asymptomatic, it can complicate with local inflammation, dysuria, urinary tract infection and obstruction.

Aim

Review the available evidence relative to the efficacy of topical estrogen (TE) in labial adhesion in comparison to other topical treatments, in pediatric age.

Methods

- **Research Material:** Review on guidelines, systematic reviews (RS) and randomised controlled clinical trials (RCCT) on Medline/Pubmed database.
- **MeSH terms:** "labial adhesion" OR "labial fusion" OR "labial agglutination" AND "topical estrogens".
- **Languages:** english, portuguese, spanish and french.
- **Research period:** between January 2005 and March 2015.
- **Evaluation of strength of recommendation and body of evidence:** the Strength of Recommendation Taxonomy (SORT) of American Family Physician.
- **Inclusion criteria:** studies evaluating the effect of topical estrogens (TE) for the treatment of labial adhesion in comparison to other treatments

9 articles

→

6 articles

Results

Type of study	Intervention	Conclusions	LE
RS, Tebruegge M. et al., 2007	TE vs others treatments	use only in symptomatic cases, topical corticoids have less secondary effects	1
RCCT, Ertürk N., et al., 2014	TE vs topical corticoids (TC)	use only in symptomatic cases, TC have less secondary effects and is safer than TE	2
RCCT, Eroğlu E., et al., 2011	TE vs TC	use only in symptomatic cases, there are no significant differences between both treatments	2
RCCT, Mayoglou L. et al., 2009	TE vs TC	use only in symptomatic cases, corticoid treatment may separate fusion quicker with less recurrence and fewer side effects than topical estrogen therapy	2
RCCT, Tutku S., 2007	TE vs spontaneous resolution	can be used in asymptomatic children, prevents recurrence	2
RCCT, Velander MH. et al, 2008	TE vs spontaneous resolution	use only in symptomatic cases	3

Conclusion

Although the number of studies available are scarce, the results are relatively homogeneous, stating that topical estrogen can be used for labial adhesion resolution, primarily when it is symptomatic. Nevertheless topical corticoids are frequently the chosen treatment. We consider that the scientific evidence is insufficient to recommend in favour or against the use of topical treatments in labial adhesion- strength of recommendation B.

Results

Type of study	Intervention	Conclusions	Level of evidence
RS, Tebruegge M. et al., 2007	TE vs others treatments	use only in symptomatic cases, topical corticoids have less secondary effects	1

RCCT, Ertürk N., et al., 2014	TE vs topical corticoids (TC)	use only in symptomatic cases, TC have less secondary effects and is safer than TE	2
RCCT, Eroğlu E., et al., 2011	TE vs TC	use only in symptomatic cases, there are no significant differences between both treatments	2
RCCT, Mayoglou L. et al., 2009	TE vs TC	use only in symptomatic cases, corticoid treatment may separate fusion quicker with less recurrence and fewer side effects than topical estrogen therapy	2
RCCT, Tutku S., 2007	TE vs spontaneous resolution	can be used in asymptomatic children, prevents recurrence	2
RCCT, Velandar MH. et al, 2008	TE vs spontaneous resolution	use only in symptomatic cases	3

A total of 9 articles were identified, 6 of which met the selection criteria: one systematic review (level of evidence, LE 1) and four randomised controlled clinical trials (three LE 2, one LE 3) that recommend topical estrogen use only in symptomatic cases. One randomised controlled clinical trial (LE 2) recommends the use of topical estrogen whether the labial adhesion is symptomatic or asymptomatic

P-1186

Tobacco use among Yeditepe University students, and relationship between first experimented tobacco product and current use

Recep Erol Sezer¹, Özlem Tanrıöver¹, Güliz Dirimen Arıkan², Mehtap Kaçar¹

¹Yeditepe University Faculty of Medicine

²Yeditepe University Faculty of Health Sciences

Background and AIM: Although impressive progress has been made in tobacco control in Turkey, increasing tobacco use rates among young people remain a national concern. We aimed to describe the experimentation and use of tobacco products among university students, and to investigate the relationship between the first experimented product (a waterpipe product vs a cigarette) and current smoking rates.

METHOD: This questionnaire survey was conducted in the spring term of the 2014-15 academic year. The research ethics committee approval was received. The study subjects included all four-year students from the schools of medicine, pharmacy, dentistry, and health sciences of the Yeditepe University, Istanbul. The response rate was 97.5% (345/354).

RESULTS: The proportion of those who have ever experimented a tobacco product was 74% (256/345) with no significant difference by gender. Of those who have ever experimented a tobacco product, 50% experimented a waterpipe product first, while the other half experimented a cigarette first. There was no relationship between the first experimented product and current smoking rates. Of the 345 respondents 36.5% (126) were current smokers, 3.2% (11) former smokers, 60.3% (208) never smokers. The proportion of current smokers was 53.5% in males, 29.7% in females ($p < 0.001$). Among current smokers ($n=126$), 79.4% (100) were daily smokers, 20.6% (26) some-day smokers with no significant difference by gender. In all daily smokers, the daily used product was cigarettes. There was also no relationship between regularity of current smoking and the first experimented product. The proportion of those who smoked waterpipe in the last 30 days was 16.1% (29.9% in males, 9.9% in females, $p < 0.001$).

CONCLUSIONS: the high smoking rate is alarming and needs urgent intervention. Waterpipe smoking, the preferred choice in the first experimentation of tobacco for half of the students, appeared to feed cigarette smoking.

Keywords: smoking, tobacco, waterpipe

P-1187

Investigate Nasal Colonize Staphylococcus Species Biofilm Produced

Cemil Demir¹, Betül Battaloğlu Inanç²

¹Mardin Artuklu University, Health Higher school, Mardin.

²Muğla Sıtkı Koçman University, Faculty of Medicine, Family Medicine Department, Muğla.

AIM: 127 S.aureus and 65 CoNS strains were isolated from patients noses'. To produce a biofilm ability was investigated using three different methods. Slime-positive and negative staphylococci's resistance were evaluated against different antibiotics.

MATERIAL-METHOD: Swap samples puted 7% blood agar. Staphylococcus aureus and coagulase-negative staphylococci

(CoNS) isolates biofilm produced ability were investigated using Congo Red Agar (CRA), microplates (MP) and Standard Tube (ST) methods. In addition to that, presence of antibiotic resistance of the staphylococcal isolates

are determined agar disc diffusion method. RESULTS: The rate of biofilm producing Staphylococcus spp strains was found to be 72.4%, 67.7%, and 62.9%,

with CRA, MP, and ST tests. There was no significant relationship among the tests ($p>0.05$). In addition, antibiotic

resistance of Staphylococcus spp. against various antibiotics was also determined by the agar disk diffusion

method. Resistance rates of biofilm positive (BP) Staphylococcus spp for penicilin G, ampicilin,

amocycilin/clavulanic acid, tetracyclin, eritromycin, gentamycin, and enrofloxacin 71.7%, 69.7%, 6.2%, 20.7%,

21.4%, 1.4%, and 0.7%, respectively. Resistance rates of biofilm negative (BN) spp for 42.6%, 23.4%, 4.3%, 14.9%,

19.1%, 0.0%, 0.0% respectively. All Staphylococcus isolates were found to be susceptible to vancomycin and

teicoplanin. Although BP strains antibiotic resistance rates were observed higher than BN strains. But resistance

rates were not found statistically significant ($p>0.05$).

DISCUSSION: CRA is the reliability and specificity method to determine Staphylococcus spp. biofilm produce ability.

Keywords: Biofilm; Coagulase; Antibiotic Resistance; Staphylococcus Aureus

P-1188

Scientific Studies Performed in The Field of Family Medicine in Turkey: Evaluation of The National Congresses

Hüseyin Üçer¹, Yaşar Koşar¹, Soner Ölmez², Celal Kuş¹, Hamit Sırrı Keten³

¹Kahramanmaraş Sutcu Imam University, Department of Family Medicine, Kahramanmaraş

²Samsat Family Health Center, Adiyaman

³Kurtul Family Health Center, Kahramanmaraş

BACKGROUND & AIM: In this study was aimed to examine the distribution of articles according to issues done in the National Congresses of Family Medicine.

METHOD: For the last five years of the study (9, 10, 11, 12 and 13th National Congress of Family Medicine) published abstracts and dialogues were included. Due to majority in the dialogue abstracts "consult the specialist" platform were categorized separately.

Panels, workshops, and discussion sessions included speakers and topics were discussed "other studies" in the title. The courses were not taken into evaluation because of the more than one trainer. Abstracts were assessed according to presentation of, multidisciplinary, type of study, and subjects. Title and key words were taken into account in the determination of the issues.

The topics were obtained from abstracts located in report submission web pages. The data were analyzed by using SPSS 20.0 software.

RESULTS: 1278 paper were included in this study. Papers 948 (74.2%) were poster presentation, 188 (14.7%) were oral presentation, 32 (2.5%) to consult specialist, and 110 (8.6%) were the other speech summaries. Only 799 studies (62.5%) while in the field of family medicine, 81 (6.3%) different areas, and 398 (31.1%) were in the form of common study with family medicine.

Poster and oral abstracts of 188 (14.7%) were consist of case reports. Abstracts were examined by subject were

determined most research (n=212, 16.6%) and least ethical issues (n=12, 0.9%).

CONCLUSIONS: With its young and dynamic structure of our speciality of Family Medicine is able to practice in many different fields.

It is remarkable that there are few studies on ethical and abuse&violence issues. Scientific practices needs to be done on different topics in consideration of the discipline characteristics of the specialty of Family Medicine.

Keywords: family medicine, scientific, congress

P-1189

Evaluation of the Level of Knowledge, Attitudes, and Behavior toward Hypertension in Patients Presenting to the Tertiary Health Care Facility (Medical Faculty Hospital)

Hamit Sırrı Keten¹, Numan Güvenç², Ümit Aslan², Soner Ölmez³, Mustafa Çelik²

¹Department of Family Medicine, Kurtul Family Health Center, Kahramanmaraş, Turkey

²Department of Family Medicine, Medical Faculty, Kahramanmaraş Sutcu Imam University, Kahramanmaraş, Turkey

³Department of Family Medicine, Samsat Family Health Center, Adıyaman, Turkey

BACKGROUND: Hypertension is an important risk factor of the leading causes of preventable deaths in the world. Hypertension is an important public health concern considering its worldwide prevalence and co-occurrence with other comorbid conditions and risk factors. The aim of the present study was to evaluate the level of knowledge, attitudes, and behavior toward hypertension in patients presenting to a tertiary health care facility (Medical Faculty Hospital).

METHOD: The study included 90 subjects, who presented to the outpatient clinics at Kahramanmaraş Sütçü İmam University Faculty of Medicine for any reason between April 5, 2015 and June 17, 2015. A questionnaire containing questions about sociodemographic features and assessing the level of knowledge hypertension was administered using the face-to-face interview technique.

RESULTS: Of the participants, 69 (76.7%) were males and 21 (23.3%) were females, and the mean age was 40.97±17.24 years (min=18, max=86). Of participants, 36 (40%) reported a chronic illness and nine (10%) reported previous diagnosis of hypertension. Of the participants, 24 (26.7%) were smokers and 18 (20.0%) were using smokeless tobacco. Of these subjects, 53 (58.9%) reported that they knew the normal ranges of blood pressure and 37 (41.1%) reported that they did not know the normal ranges of blood pressure. Of the participants, eight (8.9%) responded, "a few times a week", 20 (22.2%) responded, "a few times a month", 33 (36.7%) responded, "a few times a year", and 29 (32.2%) responded, "never" to the question, "How often do you have your blood pressure measured?" Of the patients with hypertension, two (20%) reported regular attendance to control visits at the hospital.

CONCLUSION: The present study showed a considerable lack of knowledge about hypertension in patients presenting to the tertiary health care facility (Medical Faculty Hospital). It is of great importance to develop preventive health policies for hypertension.

Keywords: Hypertension, knowledge, health care facility

P-1190

Knowledge and Attitudes of Term I-II-III Students of Dumlupınar University School of Medicine Towards Organ Donation

Yasemin Korkut, Miyase Orhan

Department of Family Medicine, Dumlupınar University, Kütahya, Turkey

AİM: Although, information and education about the importance of organ donation and transplantation were made through all channels of communication in our country, it is observed that behavioral development of society on this issue is limited. The aims of this study are examining knowledge and attitudes of students of school of medicine towards organ donation and investigate the impact of getting closer to be a doctor on these attitudes and behaviors. **METHODS:** Data 2014-2015 academic year are registered in Dumlupınar University School of Medicine and the 115 medical schools in the first three years of accepting students to participate. The study was obtained dordurularak 6-item questionnaire.

RESULTS: Information about organ donation with 67.8% of students say they receive through television and the Internet, only 1.7% of the family physicians, while 17.6% had received information from teachers at the school. 44.3% of students thought to organ donation, organs did not forgiving them. Students from 76 people (63.9%) said they saw the most reliable in the university hospitals in organ donation. 5.2% of respondents thought that organ donation is given to our country, 52.1% said that people should be educated about it. The most preferred as the slogan 'survival chances, even if you have the chance to live' was. Medical faculty of knowledge and attitudes about organ donation of students overall period III and knowledge level of the students is higher and closer to being a physician in student increases both attitudes were found to be changing in a positive direction.

Keywords: Organ donation, medical students, knowledge

P-1191

Nutritional status of infants 0-2 years and the level of knowledge of mothers

Raziye Şule Gümüştakım¹, Saide Eda Cebeci², Lütfullah Çakır³, Erdinç Yavuz⁴, Serdal Kanuncu⁵

¹Karaman second family health centre, karaman

²Serdivan family health centre, sakarya

³University of ordu family medicine department, ordu

⁴Rize first family health centre, rize

⁵Tanışma family health centre, antakya

INTRODUCTION: The purpose of this study to measure the knowledge of mothers about feeding babies 0-2 years and to determine what can be done as a primary care for incomplete issues.

MATERIAL-METHOD: This descriptive study, a total of 250 mothers with babies 0-2 years were included who applied Family Health Centers in the different provinces of Turkey for various reasons. However, eight babies were excluded from the study because of missing data. Mothers in the study, given a questionnaire consisting of 37 questions and sociodemographic characteristics, breastfeeding, additional nutrients and assessing the knowledge of mothers on this topic and infants' height-weight measurements were made. The data obtained from this study assessed using SPSS 16.0, descriptive analysis and chi-square test were used for statistical analysis and $P < 0.05$ was considered statistically significant.

RESULTS: 242 mothers' average age was 28.93 ± 5.788 (17-46 years). 76% of mothers were housewives, 30.2% of primary school graduates. The mean age of the infants was 11.24 ± 7.261 months. 46.7% of infants were female, 53.3% were male and age distribution width varies between 24 months and 5 days. Babies' average height was 72.29 ± 10.076 ; weight was 9023.43 ± 2572.837 . 44.2% of infants were the first baby, 84.3% were breastfed within the first 1 hour. 100 babies were breastfed for 3-6 months and 40 babies' breastfeeding were cut before 6 months. 50.8% of infants fed with formula, 25.6% were initiated supplementary food before 6 months. Mothers' knowledge about breastfeeding 66.9% and information about supplementary food 62.4% were received from healthcare professionals. The difference was found maternal education between knowledge about breastfeeding, supplementary food and breastfeeding withdrawal time. No differences were found maternal

education between formula use, the use of feeding bottles, mother opinion, supplementary food starting shape and time and the infection status of the infant.

CONCLUSION: Mothers get their information about the nutrition of infants largely health care workers and in this respect primary care had major tasks where the first applicant for patients.

Keywords: Nutrition, primary care, level of knowledge, breastfeeding, supplementary food

Anlamli bulunan istatistiksel farklılıklar

Anne eğitimi	x ²	p
Anne sütü hakkında bilgi	35,536	0,017
Ek gıda hakkında bilgi	47,108	0,001
Anne sütü kesilme zamanı	13,206	0,04

Statistical significant differences

Maternal education	x ²	p
Knowledge about breastfeeding	35,536	0,017
Knowledge about supplementary food	47,108	0,001
Withdrawal time of breastfeeding	13,206	0,04

P-1192

Family physicians views about family practice application in Kütahya

Yasemin Korkut, Kemal Tektaş

Department of Family Medicine, Dumlupınar University, Kütahya, Turkey

AİM: The aim of this study is to examine the views of family physicians working in the family practice field regarding good and problematic parts of the system.

METHODS: A cross-sectional study of the universe, Kütahya who work in the center and create 49 family physicians who agree to participate in the survey and family medicine specialist. 8-item questionnaire including questions and socio-demographic profile of our doctors surveyed were applied. The obtained data were loaded into 19 programs SPSS, descriptive statistics were used in the evaluation of the data.

RESULTS: Participants in the research, the Family Medicine system is asked to contribute to the health sector, while expressing it is quite positive returns compared to the former's 51.2% implementation of 32,6's% of the attending physician with a rate of application of family medicine patients were found to indicate that applicants are not enough. The lack of tools in the clinic for the question of whether this one is an impact of 38.7% saying yes, 4% said he disagreed. When asked in Turkey family medicine system is 55.1% in comparison with other countries of our lack too much, he said that we are closer to world standards 34.6%. Questions about whether enough is 48.9% of the number of family physicians to say that there is insufficient number of physicians also said that the idea of bringing doctors reluctant to 89.7% from abroad.

CONCLUSION: In this study, satisfaction and views on family medicine practice were asked. Knowing the expectations of family physicians in this process of change and solving the problem, it will improve the quality of service

Keywords: family medicine, Opinion, Satisfaction

P-1193

Zoonoses at Work Again: Lyme Findings from Eastern Black Sea Region

Sibel Gök İncikli¹, Serpil Ekici¹, Mehmet Fatih İncikli², Ayşe Ertürk³, Ayşe Irem Sönmez⁴

¹Recep Tayyip Erdogan University Faculty of Medicine, Department of Family Medicine, Rize, Turkey

²Recep Tayyip Erdogan University Faculty of Medicine, Department of Radiology, Rize, Turkey

³Recep Tayyip Erdogan University Faculty of Medicine, Department of Infection Disease, Rize, Turkey

⁴Istanbul University Cerrahpaşa Faculty of Medicine, Istanbul, Turkey

PURPOSE: Diseases spreading by tick bites can be seen all over the world, they become a bigger problem. Lyme Disease (LD) is transferred to humans from infected ticks. Because Lyme Disease can imitate the symptoms of many illnesses, The Eastern Black Sea Region is suitable for ticks due to its climate and geographical conditions. In this research, the necessity of having LD as an early diagnosis in cases with different clinical findings was stressed.

MATERIALS-METHODS: 5 cases with LD diagnosis between 2009 and 2015 were retrospectively evaluated.

FINDINGS: Out of 5 cases, 1 was a man and 4 were women. The age range was between 14 and 49 (an average of 33) and patients were young to middle aged people. All of the cases worked in gardening, in rural areas. All of the 5 cases had joint pain. One case had complaints of conjunctivitis, one had complaints of paresthesia in extremities and one had complaints of loss of strength in the arm. Two of the patients were diagnosed with polyneuropathy, one with uveitis, one with Multiple Sclerosis (MS) and one with erythema chronicum migrans.

DIAGNOSIS and TREATMENT: In the blood tests of patients, *Borrelia burgdorferi* IgM and IgG were looked at. IgM came out positive in all cases. After the diagnosis, tetracycline and benzathine penicillin was prescribed for treatment.

RESULT: Due to geographical of the Eastern Black Sea Region, the possibility of seeing illnesses transferred by ticks is high. The patients usually come to the family practitioner months after the tick bite, when the findings become chronic. It is necessary to take the medical history well from each patient that visits Family Health Centers in our region. Since the awareness level of the public about ticks is low, as family practitioner we need to inform people so that we can take the necessary precautions about LD before the illness occurs.

Keywords: CHRONOLOGICAL ILLNESSES, LYME, TICKS

Resim 1

Picture 1

NUMBER	AGE	SEX	SYMPTOM	AFTER TICK BITES	RESULTS
1	34	MALE	PAIN IN EXTREMITIES	5 MONTHS	POLYNEUROPATHY EMG (+)
2	31	FEMALE	JOINT PAIN LOSS OF STRENGTH IN THE ARM	9 MONTHS	NEUROPATHY EMG (+) LP(+)
3	14	FEMALE	JOINT PAIN CONJUNCTIVITIS	10 MONTHS	UVEITIS VEP(+)
4	40	FEMALE	ERYTHEMA AND EDEMA IN SKIN	8 MONTHS	ERYTHEMA CHRONICUM MIGRANS
5	49	FEMALE	HEAD ACHE PARESTHESIA IN EXTREMITIES	5 MONTHS	EMG (-) MR: DEMYELINATING PLAQ.

Lyme Hastalığı tanısı konulan olguların klinik ve radyolojik bulguları

Clinical and radiological results of the cases diagnosed by Lyme Disease

Lyme Hastalığı tanısı konulan olguların klinik ve radyolojik bulguları

Clinical and radiological results of the cases diagnosed by Lyme Disease

NUMBER	AGE	SEX	SYMPTOM	AFTER TICK BITES	RESULTS
1	34	MALE	PAIN IN EXTREMITIES	5 MONTHS	POLYNEUROPATHY EMG (+)
2	31	FEMALE	JOINT PAIN LOSS OF STRENGTH IN THE ARM	9 MONTHS	NEUROPATHY EMG (+) LP(+)
3	14	FEMALE	JOINT PAIN CONJUNCTIVITIS	10 MONTHS	UVEITIS VEP(+)
4	40	FEMALE	ERYTHEMA AND EDEMA IN SKIN	8 MONTHS	ERYTHEMA CHRONICUM MIGRANS
5	49	FEMALE	HEAD ACHE PARESTHESIA IN EXTREMITIES	5 MONTHS	EMG (-) MR: DEMYELINATING PLAQ

P-1194

Palivizumab Prophylaxis, Respiratory Syncytial Virus And Subsequent Development Of Asthma

Mahir İğde¹, Hilal Kabasakal², Onur Öztürk³, Guner Karatekin⁴, Canan Aygün⁵

¹Samsun Education and Research Hospital, Department of Pediatrics, Division of Allergy and Immunology, Samsun

²Samsun Education and Research Hospital, Department of Pediatrics, Samsun

³Atakum Community Health Center, Samsun

⁴Zeynep Kamil Maternity and Children's Training and Research Hospital, Department of Pediatrics, Division of Neonatology, Istanbul

⁵19 Mayıs University Faculty of Medicine, Department of Pediatrics, Division of Neonatology, Samsun

In this study, it was examined whether the risk of development of asthma in the late phase is reduced or not in children protected with palivizumab prophylaxis against RSV infection.

This study was designed by 339 children between 2 to 5 years of age who were followed up in healthy children polyclinic from 2008 to 2011. The study group was chosen randomly and divided into three groups with equal number of patients in each group (n=113). Cases were evaluated in terms of the rate of wheezing and characteristic features. The comparisons were made among three groups, Palivizumab-treated children born preterm (group1), Palivizumab-untreated children born preterm (group2) and children born term (group3).

Rate of the question about children's experienced wheezing times was significant between groups. A significant difference was found between the groups in terms of the clinician who diagnosed the asthma. The groups were compared in terms of the mAPI positivity and significant difference was found among the groups. Group1 and group3 were different, group2 was found higher than the group1, but was similar to group3.

CONCLUSION: This study supports the benefit of administration of palivizumab to premature born children for reducing the risk of asthma development.

Keywords: Palivizumab; prophylaxis; asthma; RSV

mAPI

Table 1: Modified Asthma Predictive Index

Major Criteria	Minor Criteria
Physician diagnosed asthma history in the family	Allergic rhinitis diagnosed in infants
Physician diagnosed eczema in infants	Wheezing attack not associated with cold
Diagnosis of aeroallergenic sensitivity	Eosinophilia > 4%
	Diagnosis of food allergy

P-1195**The Quality of Life Difference Between Smoker and Non Smoker Rheumatoid Arthritis and Ankylosing Spondylitis Patients**

Onur Öztürk¹, Bektaş Murat Yalçın², Mustafa Ünal²

¹Atakum Community Health Center, Samsun, Turkey

²Ondokuz Mayıs University Medical School Department of Family Practice, Turkey

OBJECTIVE: We aimed to investigate the effect of smoking on the life quality of patients with Rheumatoid arthritis (RA) and Ankylosing spondylitis (AS).

MATERIALS-METHOD: Our study was carried out on 79 (54,5%) RA and 66 (45,5%) AS patients that were followed by Ondokuz Mayıs University Medical Faculty Hospital between March 2014 and July 2014. Since these patients were grouped as study (smokers) and control (non-smokers). Both of these groups were applied a questionnaire including certain demographic features, disease history, SF-36 and EQ-5D general quality of life scale. Both groups' quality of life is compared with each other.

FINDINGS: Of the 145 patients, 54,5 % (n=79) of the participants were females. The mean age of RA and RA patients was found as 49,6±12.9 years and 39.5±12,7 years (t=4,712, p<0,001). 39,2 % of the RA and 50,0% of the AS patients were active smokers. The average cigarette consumption of RA and AS patients was 17.94±14.73 and 13.03±9.50 packet/year respectively. First symptoms of disease were initiated 5 years earlier in RA and 7 years in AS patients who smoked patients compared with no smokers (Respectively t=2,214, t=1,9965, p<0,001). There was no statistical difference between the scores of SF-36, sub-groups of SF-36 and EQ-5D scale between smoker and non-smoker RA and AS patients (p>0,05).

CONCLUSION: Although we found no relation between quality of life and smoking in RA and AS patients, our study revealed that smoker AR and AS patients' initial symptoms begin much earlier compared with non-smokers. More studies needed to investigate the effects of smoking in AR and AS patients are needed.

Keywords: Quality of Life, Smoking, Rheumatoid Arthritis, Ankylosing Spondylitis

P-1196**Research On Information and Attitude Levels of Residents For Smoking Conditions and Smoking Cessation Abilities**

Onur Öztürk¹, Gülsah Öztürk², Bahadır Yazıcıoğlu², Bektaş Murat Yalçın², Mustafa Ünal²

¹Atakum Community Health Center, Samsun, Turkey

²Department of Family Medicine, Ondokuz Mayıs University Faculty of Medicine, Samsun, Turkey

OBJECTIVE: To investigate the difference between the smoking frequency, cessation knowledge, attitudes and beliefs between internal and surgery specialty residents.

MATERIALS-METHOD: 121 internal and 30 surgery specialty residents voluntarily participated into the study. They answered a questionnaire consisting of 35 questions investigating their smoking frequency (The addiction level if they smoke), knowledge about cessation, beliefs. Their knowledge about smoking cessation is asked with 27 questions and every residents right answer about them is calculated.

FINDINGS: Smoking rate was 15,8% (n=24) and 12 (7,4%) among the residents and 33 (21,3%) of them were ex-smokers. Although 92% of the residents said that providing smoking cessation services are important only 33 (21,3%) of them were provided smoking counselling services. The mean number of the internal specialty residents had a mean of 13±0,7 (min=2, max=17) right answers while surgery residents had 9±0,6 (min=2, max=14). The internal specialty residents had more right answers compared to surgery residents (t=7,425, p=0,002). Residents who participated in our study believe that either their under graduate (72,9%) or post graduate medical training (62,9%) is satisfactory in this topic.

CONCLUSION: In order to increase their knowledge level regardless of their specialty of the resident's best methods should be investigated in their undergraduate or post graduate training curriculum about smoking cessation.

Keywords: Residents, Smoking, Conditions, Abilities

tablo 1

The unknown methods which are the most important pharmacological treatments to quit smoking

Tablo. Sigara bırakmada kullanılan en önemli farmakolojik yöntemleri tanıtmama

İLAÇ	TANIMAMA
Nikotin bantı/Sakızı	%7,7 (n=12)
Bupropion	%20,0 (n=31)
Vareniklin	%50,3 (n=78)
Trisiklik antidepresan	%72,9 (n=113)

P-1197

The Factors That Can Be Effective on Blood Count Values Among Women Aged 15-49 Years

Hilal Battal¹, Kenan Topal¹, Çiğdem Gereklioğlu²

¹Adana Numune Training and Research Hospital, Department of Family Medicine, Adana/Turkey

²Baskent University Medical Faculty, Department of Family Medicine, Ankara/Turkey

OBJECTIVE: Iron deficiency anemia is a frequent disease among women aged 15-49 years however its follow up and treatment are insufficient despite being a preventable health problem. In this study, we aimed to investigate the factors that could be effective on blood count values among women aged between 15-49 years, registered in our family medicine unit.

METHOD: A total of 617 women out of 951 aged between 15-49 years, whose blood counts were done were included in the study. Socio-demographic data, marital status, educational status, contraceptive methods used by the married women, gravida and number of children of the patients were recorded. In the patients whose hemoglobin value <12.0 mg/dL, the effectiveness of these factors was investigated with t-test and One Way Anova tests.

RESULTS: Mean age of the participants was 32.9±8.9 years, 159 (25.8%) were single, 458 (74.2%) were married. Of the married women, 102 (22.3%) were not using any contraceptive methods, 251 (54.8%) were using modern contraceptive methods, 72 (15.7%) were using conventional methods and 33 (7.2%) had underwent tubal ligation. According to education level of woman 170 (27.6%) had low education, 317 (51.4%) had moderate education and 130 (21.1%) had high education. Mean hemoglobin was 12.3±1.3 mg/dL (min 7.4 mg/dL, max 16.0 mg/dL). Hemoglobin values were found statistically significantly higher among singles (12.6±1.1 mg/dL) compared to married ones (12.3± 1.3 mg/dL). There was not a statistically significant difference between participants with regard to educational status (p=0.595), gravida (p=0.722), number of children (p=0.612) and contraceptive methods (p=0.244).

CONCLUSIONS: Anemia is frequent in fertile age and leads to many organic and psychological disturbances unless treated. We found Hemoglobin values lower among married women compared to single ones. It would be beneficial to evaluate married women more carefully in family medicine.

Keywords: anemia, female health, contraceptive methods

P-1198**Retrospective Assessment of Family Medicine Office Patients in Last Three Years**

Izzet Fidancı, Şükrü Ümit Eren, İsmail Arslan, Oğuz Tekin

Ankara Training and Research Hospital, Department of Family Medicine, Ankara

OBJECTIVE: It was purposed to assess the number and diagnosis of family medicine office admissions in last three years retrospectively.

METHODS: Patients, who applied to Family Medicine Department of Ankara Training and Research Hospital between 2012 and 2014, were evaluated according to the number, diagnosis and monthly distribution. All offices (Huseyingazi, Ulus, Yenimahalle, Bahcelievler district offices and Central Family Medicine Office) data were evaluated separately and totally.

RESULTS: 250 054 patients were included to our study. The number of female was higher than male for all offices and total. Patient admissions for each year were more than previous one. Although it varies the location of office, the most common health insurance was SSK. It was reported less number of patients in July and August, more number of patients in January and February. Upper respiratory infections were the most common reason for office admission(Table-1).

CONCLUSION: Upper respiratory infections, anemia and dyspepsia need to be emphasized in Family Medicine Residency Programs. In our study, comprehensive approach of discipline of family medicine's core competencies was supported by excessive number of patients who came for follow up acute and chronic diseases.

Keywords: Family Medicine, diagnosis, health insurance

Tablo-1. 2012, 2013 ve 2014 başvuran hastalara en sık konulan 15 tanı ve ICD-10 kodları.

Table-1. The most common 15 ICD-10 codes in 2012,2013 and 2014.

	ICD-10	The most common diagnosis	N (%)
1.	J00	Acute nasopharyngitis [common cold]	10234 (15,4)
2.	J01.8	Other acute sinusitis	9702 (14,6)
3.	D64	Other anaemias	6113 (9,2)
4.	Z00.0	Health check-up NOS	5781 (8,7)
5.	M79.1	Myalgia	5431 (8,2)
6.	I10	Essential (primary) hypertension	5249 (7,9)
7.	I25.0	Atherosclerotic cardiovascular disease, so described	4718 (7,1)
8.	D51	Vitamin B12 deficiency anaemia	3986 (5,9)
9.	N30	Cystitis	3096 (4,6)
10.	K21	Gastro-oesophageal reflux disease	3011 (4,5)
11.	E78.4	Other hyperlipidaemia	2476 (3,7)
12.	E03.9	Hypothyroidism, unspecified	2009 (3)
13.	E13	Other specified diabetes mellitus	1938 (2,9)
14.	R10	Abdominal and pelvic pain	1902 (2,9)
15.	K52.9	Noninfective gastroenteritis and colitis, unspecified	1669 (2,5)

P-1199

COPD (Chronic Obstructive Pulmonary Disease) and Anemia

Serpil Ekici¹, Sibel Gök İncelikli¹, Aziz Gümüş²

¹Recep Tayyip Erdogan University, Department of Family Medicine, Rize,Turkey

²Recep Tayyip Erdogan University, Pulmonary Medicine Department of, Rize,Turkey

PURPOSE: COPD is a type of progressive and treatable disease that is characterized by chronic inflammatory response of lungs to harmful gases and particles. In COPD patients, anemia can be observed. In addition to accompanying illnesses, anemia can be caused by COPD itself as a systematic disease. In our research, it was aimed to determine the cooccurrence of COPD and anemia as well as draw attention to this situation which is actually preventable.

METHODS-MATERIALS: 250 male patients in the stable period over the age of 18 among all COPD patients that went to the Pulmonology Clinic at Recep Tayyip Erdoğan University Faculty of Medicine between 01.01.2015 and 01.07.2015 were determined. Hemogram values of patients in the stable period were retrospectively evaluated by scanning file archives. Staging of COPD was done in accordance with 2015 GOLD (Global Initiative for Chronic Obstructive Lung Disease) criteria (FEV1/FVC<0.7). Anemia diagnosis was given in accordance with WHO criteria. For male patients, anemia was accepted as hemoglobin (Hb) levels being <13mg/dl and haematocrit(Htc) levels being <%39.

FINDINGS: Hb<13mg/dl and Htc<%39 was determined in 96 of 250 patients. %38.4 of patients were diagnosed with anemia. While borderline Htc and Hb levels were observed in 16 patients (%6,4), in 7 patients (%2,8) values of Htc<39 Hb>13mg/dl were observed and in 4 patients (%1,6) values of Hb<13 mg/dl ve Htc>%39 were found. Those who met both criterias were assessed as anemic.

RESULT: As can be seen from our research, the cooccurrence of COPD and anemia is very common. Approximately one out of every three patients also struggle with anemia. This situation lowers patients' quality of life as well as making it difficult to deal with the illness. With the protective and rehabilitative measures taken by family practitioners, preventing this and such comorbid situations will be possible.

Keywords: Anemia, chronic, COPD, hematocrite, hemoglobine, systemic

P-1200

1 year sharings of Turkish Family Medicine Journal Group

Muhteşem Erol Yayla¹, Erdiç Yavuz², Emrah Kırımlı³, Mustafa Kürşat Şahin⁴

¹SARIÇAM MEHMET AKİF ERSOY FAMILY MEDICINE CENTER

²RİZE FAMILİ MEDICINE CENTER NO:1

³ÜMRANİYE FAMILY MEDICINE CENTER

⁴SAMSUN COMMUNITY HEALTH CARE CENTER

Turkish Family Medicine Journal Group was found in 7th Juna 2014 as a facebook social media page. Between dates 20th August 2014 and 10th July 2015 abstract of the journals were shared by yahoo mail group "Aile" twice a month on 10th and 25th days of every month. In every sharing, content of research in Turkish was shared with an internet link.

Sources were national and international. As international source(alphabetically); BMJ evidence updates, Cochrane reviews, American Academy of Family Physician(AAFP), Medscape Family Medicine, New England Journal of Family Medicine, Medpage Today's Kevin MD were used. As national sources(alphabetically); Ankara Medical Journal, Eurasia Journal of Family Medicine, Düzne University Konuralp Medical Journal, Medical Network Actual Medicine, Smyrna Medical Journal, Turkish Journal of Family Medicine and Primary Care, Turkey Family medicine Journal were used.

As a summary, shared total journal number was 329. Every month 12 at minimum, 38 at maximum, mean 27.4 articles were shared. Shared contents other than articles were more than that numbers, but we were not be able to reach the past contents because of Facebook protocols.

Keywords: journal, family medicine, article

P-1201

Seasonal influenza vaccination rate among 18-64 years adults

Münevver Tulunay, Esra Durmuş, Esra Akkan, Cenk Aypak, Süleyman Görpeliöğlü
Diskapı Training and Research Hospital

AIM: Seasonal influenza infection leads to significant morbidity and a major cause of loss of workforce among adults. Vaccination has shown to be a reliable, efficient and cost-effective measurement against seasonal influenza. The influenza vaccination is suggested to everyone ≥ 6 months by World Health Organization. The aim of the study is to determine the frequency of seasonal influenza vaccination among adults aged between 18-64 years. METHODS: The study was carried out in Family Medicine Department of Diskapı Training and Research Hospital between 01.04.2015-30.06.2015. Patients, aged between 18-64 years and agreed to participate were enrolled in this study. A questionnaire form including questions about demographic characteristics, health status and influenza vaccination were filled by the participants. Descriptive statistical analysis was performed. RESULTS: A total of 314 patients (72,3% female, 27,7% male) were included in this study. The mean age of the participants was 43.14 ± 13.0 years. Among the study population 119 (39.7%) patients had at least one chronic disease such as diabetes mellitus, coronary artery disease, asthma/COPD or rheumatic disease; 37 patients (11.1%) had two or more chronic diseases. The rate of patients who had been vaccinated against influenza was found to be 9.2%. Although there was no relationship between vaccination status and gender, education level, living area, marital status or having chronic disease ($p \geq 0.05$); there was a relationship between vaccination status and occupation ($p=0.02$); housewives and retirees were more likely to be vaccinated. The most frequent barriers against vaccination were found to be: not believing effectiveness (62,8%), being unaware of vaccination (15,4) and believes about potential side effects (13,3) respectively. The influenza vaccination was commonly recommended to the people who had been vaccinated, by their physicians (51,7%), by pharmacists (24,1%) or by media (13,7%). CONCLUSION: Our data have revealed that the frequency of influenza vaccination was low even among patients with comorbidities. Clinicians should inform people about influenza vaccination and try to increase the rates of vaccination.

Keywords: adult, influenza, vaccination

P-1202

Evaluation of The National Journals Published in The Field of Family Medicine

Hüseyin Üçer¹, Hamit Sırrı Keten², Celal Kuş¹, Yaşar Koşar¹

¹Kahramanmaraş Sutcu Imam University, Department of Family Medicine, Kahramanmaraş

²Kurtul Family Health Center, Kahramanmaraş

This study aimed to examine the contents of the National Family Medicine journals. The study prepared in Turkey was taken from the journal of family medicine. Journals until the last number of years from the initial date of publication was divided into their journals and investigated from the internet. Number of articles in each issues, types of texts (letter to the editor, review, case, research and other) number of authors, the first author's gender, titles and were classified according to related disciplines. The data were analyzed by using SPSS 20.0 software. Yet our study is under construction and total of 8 national journals of family medicine was reached. All the number of journals separated by years and their contents have been categorized. Just a journal (Turkish Journal of Family Medicine) for the last 5 year-data analyzed, a total of 187 data were entered to SPSS. Accordingly, the data of 71 (38.0%) original article, 28 (15.0%) review, 24 (12.8%) case, 6 (3.2%) letters to the editor and 58 (31.0%) were the other types of articles.

When looking at annual number of publication in the last 5 years the most 70 (37.4%) was published in 2013. According to their subjects the most in the field of women's health 26 (13.9%) were found. The results will be shared with when our study is completed.

Keywords: family medicine, journal, national

P-1203

Patient quality differences in the level of competencies of family physicians in Kosovo

Gazmend Bojaj¹, Fitim Skeraj², Genc Burazeri³, Katarzyna Czabanowska⁴

¹Principal Family Medicine Center, Kline, Kosovo

²University of Medicine, Tirana, Albania

³Department of International Health, School for Public Health and Primary Care (CAPHRI), Faculty of Health, Medicine and Life Sciences, Maastricht University,

⁴Faculty of Health Sciences, Jagiellonian University Medical College, Krakow, Poland

BACKGROUND: Skills and competencies of family physicians are a basic prerequisite for high-quality primary health care services. The aim of this survey was to assess urban-rural differences in the level of competencies of family physicians from patients' perspective in transitional Kosovo.

METHODS: A cross-sectional study was conducted in Kosovo in 2013 involving a nationwide sample of 1340 primary health care users aged ≥ 18 years (49% males and 51% females; overall age: 50.5 ± 17.9 years; response rate: 89%). Patients were asked to rate the level of competencies of their family physicians regarding different domains of health services. The self-administered questionnaire included 37 items. Answers for each item of the tool ranged from one ("novice" physicians) to five ("expert" physicians). An overall summary score on the level of competencies of family physicians was calculated [range: from 37 (minimal competencies) to 185 (maximal competencies)]. Demographic and socioeconomic information was also collected. General Linear Model was used to compare urban-rural differences in the overall level of competencies of family physicians.

RESULTS: Upon multivariable adjustment for demographic factors (age and sex), socioeconomic characteristics (education, income and employment), number of health visits in the past 12 months and the overall satisfaction with the quality of medical encounter, mean value of the overall summary score for the 37-item instrument was higher among rural residents compared with their urban counterparts (121 vs. 118, respectively, $P=0.008$).

CONCLUSION: Our findings from Kosovo indicate that patients in rural areas perceive a significantly higher level of competencies of their family physicians compared with patients from urban areas. Determinants of such urban-rural differences should be further explored in future studies in Albanian settings.

Keywords: competencies, family physicians, Kosovo, primary health care users, urban-rural differences.

Primary Health Care



Patient Quality

Table 1 Distribution of background characteristics in a nationwide sample of primary health care users in Kosovo (N=1340), in 2013

Variable	Urban areas (N=876)	Rural areas (N=464)	P [‡]
Age (years)	50.16 \pm 17.88*	51.27 \pm 17.96	0.285
Educational level (years)	10.00 \pm 3.99	8.25 \pm 3.86	<0.001

Income level:			
Low	136 (15.5) [†]	129 (27.8)	
Middle	653 (74.5)	323 (69.6)	<0.001
High	87 (9.9)	12 (2.6)	
Employment status:			
Employed	336 (38.4)	120 (25.9)	
Unemployed	283 (32.3)	226 (48.7)	<0.001
Students	79 (9.0)	42 (9.1)	
Retired	178 (20.3)	76 (16.4)	
No. health visits in the past 12 months:			
0	9 (1.0)	7 (1.5)	
1-2	163 (18.6)	93 (20.0)	0.590
≥3	704 (80.4)	364 (78.4)	
Overall satisfaction with health services:			
Very good/good	651 (74.3)	352 (75.9)	
Average	201 (22.9)	90 (19.4)	0.067
Poor/very poor	24 (2.7)	22 (4.7)	

* Mean values ± standard deviations. † Numbers and column percentages (in parentheses). ‡ P-values from Mann-Whitney test (for age and education) and from the chi-square test (for the other variables presented in the table).

Table 2 - Competencies of family physicians by patients' place of residence Mean values from the General Linear Model

Model	Mean*	95%CI	P
Model 1 [†] :			
Urban areas	117.0	115.7-118.3	0.010
Rural areas	119.9	118.1-121.7	
Model 2 [‡] :			
Urban areas	116.9	115.6-118.2	0.008
Rural areas	119.9	118.1-121.7	
Model 3 [¶] :			
Urban areas	116.9	115.6-118.2	0.008
Rural areas	119.9	118.1-121.7	
Model 4 [§] :			
Urban areas	115.7	113.8-117.6	0.003
Rural areas	119.2	116.8-121.6	
Model 5 ^{**} :			
Urban areas	117.6	113.8-121.4	0.008
Rural areas	120.7	116.7-124.7	

* Range of the overall summary score from 37 (minimal competencies) to 185 (maximal competencies). † Model 1: crude (unadjusted) estimates. ‡ Model 2: age-adjusted values. ¶ Model 3: additionally adjusted for sex. § Model 4: additionally adjusted for socioeconomic characteristics (education, income, and employment). * Model 5: additionally adjusted for the number of health visits in the past 12 months and the overall satisfaction with the medical encounter.

P-1204

Features of the patients evaluated at Dokuz Eylul University of Family Medicine Department, their satisfaction status and the opinions of doctors about the patient files who works in the clinics

Serkan Yavuz, Nilgun Ozcakar

Department of Family Medicine, Dokuz Eylul University, Izmir, Turkey

AIM: To determine the status of outpatients' file records of Dokuz Eylul University Faculty of Medicine (DEUFM) to the Department of Family Medicine, to evaluate the views of physicians about files and satisfaction of patients.

METHODS: Our study consists of all patients' records in our department between 30.03.2007-31.07.2011. All 2486 files were examined except 38 files unfound. The views of 23 physicians worked at clinic at least 3 months via a questionnaire by face to face interview. Volunteered 213 patients participated between 01.01.2013-30.06.2013 applied "Patient Satisfaction Survey".

RESULTS: The mean age was 33.93 ± 17.39 (min.0-max.87) and 1616(65%) were female within examined files. The first three main complaints were identified as general examination 606(17.9 %), cough 174(5.1%) and fatigue 121(3.6%). 1626(65.4%) patients had attended once, 441(17.7%) twice and 419(16.9%) were more than three. Most fulfilled part of patient history file was "medical history in 2172(87 %)" and the least was "problem list section 131(5.3%)". Among physicians' opinions about the files 14 of them (60.9 %) were working over 2 years, 7(30.4%) were 1-2 years and 2(8.7%) were less than 1 year. Physicians scored files as a mean point of 6.22 and stated that files are long (n=15), more detailed (n=14) and time-consuming (n=13). The "Patient Satisfaction" was considered high by 95.7 % and stated as "very good". Our patients said they would recommend our clinic to others.

CONCLUSION: In our clinic patient files are not at the desired level, physicians stated files were long, time-consuming and detailed; our patients have been satisfied.

Keywords: Family Medicine, Patient Profile, Primary Care Files Record, Opinions of Doctors About The Patient Files, Patient Satisfaction

Table 1. Main Applications

First Ten Main Complaints of All Applications			Sex				Total	
			Female		Male			
ICD-10	Complains	n	%	n	%	n	%	
1	Z00.0	General medical examination	373	16,4	233	21	606	17,9
2	R05	Cough	105	4,6	69	6,2	174	5,1
3	R53	Malaise and fatigue	81	3,6	40	3,6	121	3,6
4	M79.6	Pain in limb	70	3,1	32	2,9	102	3
5	R06	Abnormalities of breathing	59	2,6	31	2,8	90	2,7
6	R07.0	Pain in throat	57	2,5	26	2,3	83	2,4
7	M54	Dorsalgia	47	2,1	24	2,2	71	2,1
8	R51	Headache	47	2,1	19	1,7	66	1,9
9	R10	Abdominal and pelvic pain	48	2,1	8	0,7	56	1,7
10	E66	Obesity	35	1,5	8	0,7	43	1,3
11		Others	542	23,7	225	20,3	767	22,7
12		No Information	812	35,7	393	35,5	1205	35,6
Total			2276	100	1108	100	3384	100

Table 2. Physicians Opinions About the Files

Which one or ones is / are the best define for registry files? (You can choose more than one)	
Long	15
More Detailed	14
Time Consuming	13
Handy	6
Developable	5
Meet the Needs	4
Necessary	2
Enough	2
Does Not Meet Needs	2
Insufficient	0
Exellent	0

P-1205

Quality of care for the patients with osteoarthritis in primary care practise

Milena Tosic¹, Maja Račić², Igor Novaković³

¹Health Centre, Ugljevik, Bosnia and Herzegovina

²Faculty of Medicine Foča, East Sarajevo, Bosnia and Herzegovina

³Health Centre, Bijeljina, Bosnia and Herzegovina

Background. Osteoarthritis is one of the most common chronic diseases in Bosnia and Herzegovina, with greater prevalence in women, older people, and those with poorer socioeconomic status. Effective treatments are available, yet little is known about the quality of primary care for this disabling condition.

Aim. To measure the quality of care for patients with osteoarthritis in primary care practise, and assess variations by patient characteristics.

Methods. The retrospective observational study was conducted in eight family practices in the region of Ugljevik, Bosnia and Herzegovina. The records of all 120 patients with osteoarthritis registered with these practices were reviewed. High-quality health care was specified by fourteen quality indicators established by The Arthritis Foundation Quality Indicator Project. Logistic regression modelling assessed variations in quality by gender, age, occupation, functional status, localization and time since diagnosis.

Results. There was substantial variation in the recorded achievement of individual indicators. The percentage of patients whose records show that they received care in the form of information provision ranged from 85% to 91%. For regular assessment indicators the range was 21% to 100%, and for treatment indicators the range was 40% to 78%. Recorded achievement of quality indicators was higher in those with more severe osteoarthritis and longer time since diagnosis.

Conclusion. This study has demonstrated the feasibility of using The Arthritis Foundation Quality Indicator Project set of indicators to measure the quality of care for the patients with osteoarthritis in primary health care practise. Family practitioners should focus more on disability and pain and on giving information about treatment since these topics are often inadequately addressed. One challenge will be to provide a more proactive, patient-centered care.

Keywords: osteoarthritis, quality indicator, primary health care

Table 1. Scoring of HOOS-PS/KOOS-PS/MHQ

Questionnaire score	KOOS-PS	0-25	26-50	51-75	76-100
	HOOS-PS				
	MHQ	19-40	41-60	6.80	81-95
OA severity		Mild	Moderate	Severe	Very severe

Table 2. Patients characteristics (N=120)

Characteristic	N	%
Female	83	69
Occupation		
Farmer	24	20
Housewife	47	39
Age retiree	10	8
Blue collar jobs	22	18
White collar jobs	17	15
Place of living		
Town	45	37.5
Rural region	75	62.5
Smoking		
Yes	21	17.5
No	99	82.5
Physical activity		
Yes	16	13
No	104	87
Localization		
Hip	29	24
Knee	56	47
Hands	35	29
Comorbidity		
Other chronic disease	97	81
Time since diagnosis		
<1 year	8	6.7
1-3 years	38	32
4-6 years	36	30
7-10 years	22	18
>10 years	16	13.3

Distribution of OA



Akvarobik



Exercise



OA pathophysiology



Tabela 3. Severity of impairments in physical functioning according to the HOOS-PS/HOOS-PS/MQH score

	Affected joint		All
	Hip/Knee	Hand	
I group- mild OA	N 11	5	16
	% 12.8	14.7	13.3
II group. moderate OA	N 21	10	31
	% 24.4	29.4	25.8%
OA severity (HOOS-PS/KOOS-PS/MHQ)	N 31	11	42
	% 36.0	32.4	35.0%
IV group- very severe OA	N 23	8	31
	% 26.7	23.5	25.8%
All	N 86	34	120
	% 100	100	100

Hand OAX-ray



Table 4. Distribution of severity of functional impairments according to BMI value, smoking status, physical activity, duration of disease and occupation

	Mild	Moderate	Severe	Very severe	H	p
BMI						
19-24,9	5	6	4	0	4,005	0,009
25-29,9	8	21	10	8		
>30	3	4	28	23		
Smoking						
Yes	3	10	12	13	2,935	0,402
No	13	21	30	18		
Physical activity						
Yes	2	6	4	4	1,458	0,482
No	14	25	38	27		
Duration of the disease, year						
<1	4	1	2	1	20.868	<0.001
1-3	4	15	17	2		
4-6	4	9	14	9		
7-10	4	3	4	11		
>10	0	2	6	8		
Occupation						
Farmer	2	6	7	9	14,847	0,011
Housewife	4	9	15	19		
Age retiree	4	1	4	1		
Blue collar jobs	5	8	9	0		
White collar jobs	3	7	6	1		

Farmers hands



Table 5. Achievement rate of quality indicators (QI)

QI	Number of patients eligible N	Achievement rate in medical records (%)	Achievement rate in patient interview (%)
Physical examination	120	100	100
Pain and functional assessment			
2	120	100	100
3	120	100	100
Education	120	90.8	100
Exercise	120	78	78
Weight loss			
6	85	84.7	86
7	85	84.7	86
8	71	23	23
Assistive devices			
9	97	83	83
10	104	90.4	92
Pharmacologic therapy			
11	47	40.4	42
12	30	24	26
Surgery	54	75.9	78
Radiographs	73	79	79
Mean QI achievement rate		74	77

P-1206**Accreditation of the Family Medicine teams at Health Centre Bijeljina**

Srdjan Mijatovic, Zlatko Maksimovic, Aleksandra Mijatovic, Ruzica Jelusic, Dijana Dukic
Health Centre Bijeljina

The accreditation process of the health care institutions is a recognized and widespread, comprehensive method for improving the health care quality in the world.

The aim of this work is to show the quality of work of 33 accredited FM teams compared to 22 unaccredited in Health Centre Bijeljina.

An analysis of work performed both by the accredited and unaccredited group was conducted during the year of 2014. The analysis included the first medical check number, control medical reviews, number of preventive medical reviews, number of curative checks, number of laboratory referrals, number of referrals for radiologic and ultra-sound medical check, and number of referrals for consultation reviews.

The first medical review number and the control medical review number showed that the accredited FM teams had had more first medical checks performed compared to the other control ones. The number of preventive medical reviews performed by FM accredited teams was in the average of 624.12 and 465.95 for the unaccredited ones, while the number of curative reviews was higher in the unaccredited group – 11,810 compared to 9,563.30 in the accredited group.

The accredited teams had significantly less laboratory referrals (651.30) compared to the unaccredited ones (1084.68). Also, a lot more analyses per patient were requested by the unaccredited FM teams.

As for analysis of the number of referrals for radiologic and ultra-sound medical reviews, the accredited teams had considerably less referrals compared to the unaccredited. The accredited teams had 926.94 referrals in

average compared to 1,329.41 for the unaccredited ones when analyzing consultative-specialist medical review referrals.

The performance analysis for the accredited and the unaccredited FM teams at Health Centre Bijeljina for the year of 2014 showed a great importance of the accreditation and significant improvement of performance quality.

Keywords: accreditation, quality, Family medicine

P-1207

Performance efficiency indicators for Health Centre Bijeljina during the time period from 1st of January until 31st of December 2014

Ruzica Jelisic, Zlatko Maksimovic, Cedomir Radovanovic, Aleksandra Mijatovic, Srdjan Mijatovic
Health Centre Bijeljina

AIM: Aim of the work is to point out the significance of establishing the system for monitoring the performance efficiency indicators for the primary health care institutions. The final result of these activities would be improvement of the health care quality, benchmarking establishment and improvement of primary health care contracting and paying.

METHODS: By applying analytic, synthetic and statistic methods, the analysis results for the three indicators monitored at Health Centre Bijeljina during the time period from 1/1/14-31/12/14 have been presented throughout the work. The monitored indicators are: number of biochemical-laboratory diagnosis per 1,000 of insured persons, number of prescriptions per capita, and number of performed MR and CT per 1,000 of insured persons.

RESULTS: Discrepancy of the number of biochemical-laboratory diagnosis services per 1,000 insured persons compared to the average of 309.4 (defined by the Republic of Srpska Health Insurance Fund) is 5.1%. The number of prescriptions per capita is 0.2 less than the average (6.4) at Health Centre Bijeljina, and the excess has been registered in 32 health care institutions in Republic of Srpska. The number of the conducted MR per 1,000 of insured persons is 3.2 higher than the average (14.5). The number of the performed computed tomography per 1,000 insured persons is 0.1 less than the average (19.4).

CONCLUSIONS: The total cost of the services exceeding average values is around 4 % of the total agreed primary health care value for the period of one year. In order to improve the primary health care contracting and paying model, it is necessary to develop and apply the indicators for monitoring performance efficiency of the primary health care institutions.

Keywords: indicator, primary health care, quality

Poster

Performance efficiency indicators for Bijeljina Public Health Care Centers during the time period from 1st of January until 31st of December 2014

P-1208**Monitoring patients' satisfaction at Health Centre Bijeljina**

Zlatko Maksimovic, Ruzica Jelusic, Milija Cvijetinovic, Cedomir Radovanovic, Srdjan Mijatovic
Health Centre Bijeljina

At Health Centre Bijeljina different parameters are being continuously analyzed, possible problems solved, quality of the services improved, the boundaries of the set tasks pushed, because things can be done in a better way, and only a satisfied user of the health care services secures us a leading position in the region and farther.

Aim of the work: is to show the significance of monitoring and measuring the satisfaction of health care users at Health Centre Bijeljina.

METHODS: Data, information, points of view and opinions of the service users have been gathered by applying the questionnaire method.

RESULTS: The Republic of Srpska Health Insurance Fund Bijeljina has been monitoring satisfaction of the insured at Health Centre Bijeljina. The users of the services are allowed to give a mark from 1 to 5 in the questionnaires. The total satisfaction mark in 2009 was 4.63, and 4.95 for the year of 2013.

In addition to the above mentioned questionnaire, the Republic of Srpska Agency for certification, accreditation and health care quality improvement regularly performs its own surveys among the accredited FM teams. The questionnaire addresses the issues of patients' rights and needs being respected by the FM team members, and the aim is to have 75% of the examinees answer the asked questions positively. The results obtained by processing these polls have shown that 97 % of the examinees gave positive answers in the year of 2013.

Information on satisfaction and experiences of the health care users are also obtained based on Health Centre Bijeljina yearly poll performed by the Quality Sector.

CONCLUSION: By monitoring and measuring satisfaction of the health care users at the health care institutions we obtain information based on which the quality of health care and services can be improved.

Keywords: patients' satisfaction, questionnaire, monitoring, measuring

Monitoring patients' satisfaction at Bijeljina Public Health Care Centre

P-1209**Performance in 2014**

Nevenka Strahinja Radosavljevic

Prim dr Nevenka Radosavljevic

Background & AIM:

Analyze last year's work aimed at considering the possibility of increasing quality.

METHOD:

Retrospective analytical study of annual report.

RESULTS:

In the period 1.1 2014 - 1.1 2015 7577 was conducted visits patients, in average 43 per a day, a curative reviews is 93.8% or 7106, screening 6.2% or 471 visit.

First curative review is 2957 or 41.6%, control examinations of the chronic patients 2016 or 28.4%, short visits (prescribing medication, blood glucose monitoring, EKG) was 2133 or 30%.

From preventive examinations vaccination is 120 or 25.5%, visit of the Health Educational Work Group 6.6% or 31, 145 individual patients education or 30.7%, systematic examinations 101 or 21.5%, screening 74 or 15%.

CONCLUSION:

Unsatisfactory number of examinations check-ups, because of the workload.

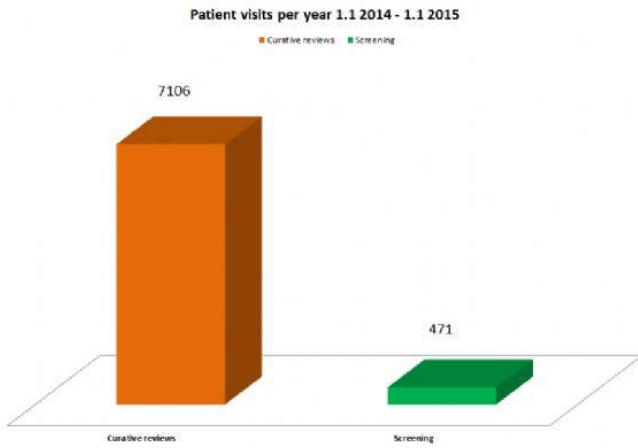
Exchange experiences and ideas to improve the quality of work.

Questions for DISCUSSION:

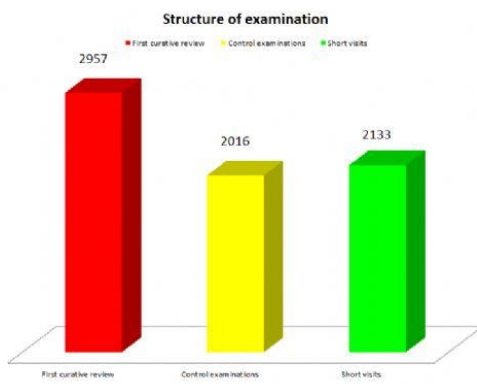
What is your workload and the structure of the examination?

Keywords: workload, quality of work, exchange experiences

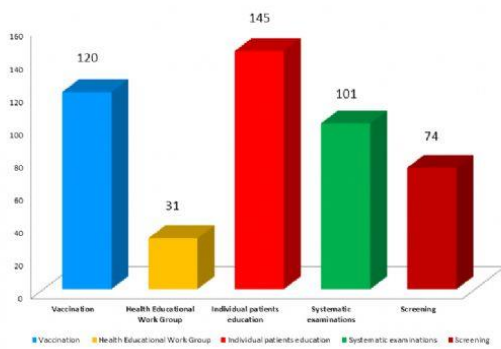
Patient visits per year 1.1 2014 - 1.1 2015



Structure of examination



Preventive examinations



P-1210

Improving family medicine referrals to mental health services for over 75 year olds

Claire Patricia Rees¹, Debra de Silva²

¹Centre for Public Health and Primary Care, Queen Mary University, London, UK

²The Evidence Centre, UK

Background & Aim

Most western countries have an ageing population and there is a hidden burden of mental health issues amongst the elderly. Family practice has a key role to play in ensuring older people can access the support they need. One UK family practice aimed to increase identification of people aged over 75 years with depression and anxiety and improve referrals to free community mental health services.

Method

The study used a before and after design. Family doctors were surveyed about barriers to identifying and treating depression and anxiety in older people. Data were collected about the prevalence of anxiety and depression and referral rates.

A drop-in advice session for patients was run in partnership with a local charity and family doctors and practice nurses attended a training session about mental health in older people. A resource pack was developed for family doctors, including screening tools for depression and anxiety and a leaflet to give patients about local services to improve mental wellbeing. The programme is running from October 2014 to May 2015.

Results

The practice has 580 registered patients aged over 75 years, 61 of whom have a recorded diagnosis of anxiety or depression (11%). In the year before the interventions, only seven people were referred for help (1% of the entire older group and 11% of those with a known diagnosis). In just five months after project began, a further seven people were referred, thus doubling the referral rate (23% of those with a diagnosis).

Conclusion

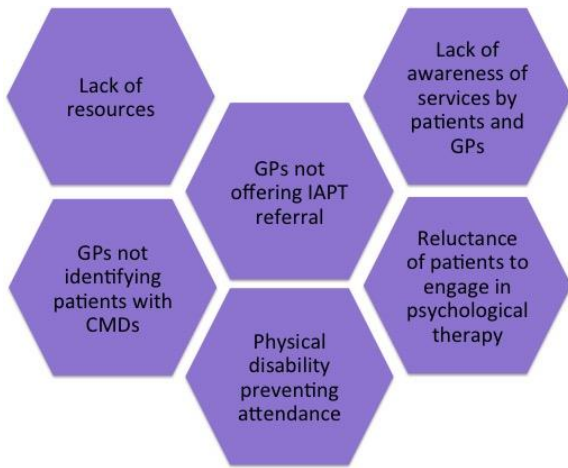
This pilot study shows that simple changes can raise awareness in family practice about mental health issues in the elderly and help more people get the support they need. It also shows that it is possible for family practice to take a proactive approach to improvement, strengthening service delivery.

Keywords: Aged, Mental health, Community mental health services

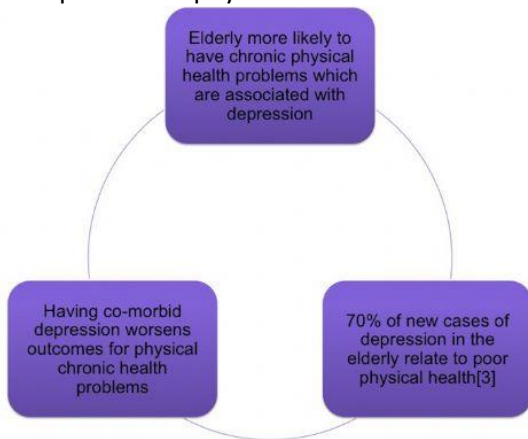
Costs vs. benefits of the project

Costs vs Benefits	
Costs <ul style="list-style-type: none">• Time commitment• Resources- printing out information leaflets for patients• Cost to AgeUK of running information and advice service- room rent, volunteer's time• Increase in workload by identifying patients with mental health problems• Increased referrals to IAPT so increased work load and pressure on appointments• Identifying an un-met need (IAPT home visits for housebound) that cannot be met due to financial constraints	Benefits <ul style="list-style-type: none">• Increased staff awareness of mental health problems in the elderly• Increased referral rates• Increased treatment completion rates• Improved relations with voluntary sector and mental health services• Feedback to improve IAPT service

Hypotheses for inequity of access to mental health services for elderly



Relationship between physical and mental health in elderly



Results

Objectives	Results
1. To increase diagnosis of anxiety and depression by 5% in people aged 75 and over	Not achieved- decrease in number with active diagnosis from 62/580 (10.7%) to 52/557 (9.3%)
2. To increase referral to IAPT by 10% in people aged 75 and over	Achieved- increase from 0.6 referrals per month to 1.0 referrals per month (60% increase)
3. To increase completion of IAPT treatment (attend at least 2 sessions) in people aged 75 and over by 50%	Achieved- 4 out of 7 completed 2 sessions of treatment (57.1%) vs 2 out of 7 before (28.6%)
4. To improve staff and patient knowledge of mental health problems and services available	Achieved- changes- education session, leaflet available for patients on mental wellbeing services, AgeUK Information & Advice service established

Situation in Queenswood Medical Practice at start of project

	All patients in practice	Patients aged >75
Population	19,102	580 (3%)
Active diagnosis of CMD	1445	62
	8% of all patients	11% of >75s
Patients referred to IAPT Oct 13-Sep 14	485	7
	3% of all patients	1% of >75s
	34% of those with CMD	11% of >75s with CMD

IAPT patients completing treatment	204 42% of referrals	2 28% of >75 referrals
------------------------------------	-------------------------	---------------------------

CMD = Common Mental Disorders

P-1211

Quality of life after aorto-iliac by-pass surgery

Nurver Turfaner Sipahioğlu¹, Murat Kurul¹, Ece Sivrel Uzun¹, Tuğba Durdu¹, Caner Arslan², Hasan Tüzün²

¹Istanbul University, Cerrahpasa Medical Faculty, Department of Family Medicine

²Istanbul University, Cerrahpasa Medical Faculty, Department of Cardiovascular Surgery

AIM: The aim of this study is to assess the quality of life before and after aorto-iliac by-pass surgery in peripheral artery disease patients and correlate it with demographic factors, comorbidities and presenting complaints.

Materials&METHODS: Thirty patients admitted to the cardiovascular surgery department for aorto-iliac by-pass surgery were recruited in the study. All of them were male gender except one patient. Their mean age was 59±9.93 years. SF-36 was applied to the patients in one week before surgery and after 2 months. A questionnaire involving demographic data and information about the disease was also given to the patients.

RESULTS: In SF-36 quality of life questionnaire, physical role restriction (p=0.012) and pain (p=0.020) scores were significantly decreased post-operatively.

Education level was negatively related with post-operative pain (p=0.036). Pre-operative pain was positively related with BMI (p=0.038).

Receiving education about illness (p=0.032) and the source of information (p=0.030) affects pre-operative general health.

DISCUSSION: Aorto-iliac by-pass surgery improves physical role restriction and pain caused by peripheral arterial disease after two months. Low education level causes an increase in post-operative pain.

Keywords: Quality of life, SF-36, aorto-iliac bypass, peripheral artery disease

P-1212

Quality in Italian General Medicine: a mixed-method research approach to study how to improve GP-work quality

Alessandro Mereu¹, Stefano Giovannoni¹, Alessandro Bussotti²

¹Specific Training on General Medicine, Tuscany Region, Florence, Italy

²Continuity of care Agency, Careggi Hospital, Florence, Italy

The Italian GP-work needs fundamental improvement in order to face new important transformations (epi-demographic, organizational, economic straits, medicalization of life, healthcare expenditure growth) which could make obsolete the traditional activities.

The aim is to answer the research question "How to improve GP work-quality?" with a fieldwork research where young and senior GPs can acknowledge the actual quality level and imagine quality improvement strategies.

Method

A mixed-method approach is the best option to examine the perceived quality of GP activities in order to collect relevant quantitative data about GP-workload in daily life, and meanings of what is quality for GPs.

The study design consists of 6 interviews with senior-GP and 3 focus groups with 6 young-GPs each group.

The results of this qualitative section will contribute (concurrently with a bibliographic research and the collaboration with an anthropologist) to build a semi-structured questionnaire, about quality and quantity GP work indicators, consigned to 30 senior-GP and to design quality improvement activities to settle in actual GP work-

system.

The research is based in Tuscany. All of the samples are gender and geographically balanced.

Interviews and focus groups will set on April-June 2015; semistructured questionnaire will set on June-August 2015; result analysis will set in September 2015; quality improvement argumentation will set in October 2015.

Results

Results are not available at this time. Interview and focus group tracks are ready.

The results will be statistical data and qualitative information.

Conclusions

In order to give back a complex scenario about quality and quality improvement needs, is important to use, as key-informers, the GPs and not only external observers.

GPs could give important contribute about how to design the future PHC delivery-system because they are deeply involved. The mixed-method research approach could be significant to give relevant information in the PHC work, not just numbers but also meanings.

Keywords: Quality Improvements, Mixed-method Research, General Medicine

P-1213

We really have time in our practice for the digital age?

Hector Leonardo Lugo Ramos, Juan Jesus Rodriguez Vallejo, Jose Maria Fernandez Gonzalez, Pedro Guijo Gonzales
La Granja Health centre, Jerez de la Frontera, Cadiz, Spain.

OBJETIVES

Evaluate the use and management of a "digital tool" for primary care to receive results of laboratory tests requested.

MATERIALS AND METHODS

Survey of all physicians in two health centers in the same health area, questioning on a new digital tool that generates messages when accessing the daily list of patients, showing analytical results previously requested and generating alert symbols in the altered tests.

It consists of 10 questions(9 multiple choice,1 open)seeking information on knowledge of digital tools, when and how it is used, utility versus query time and influence in number of applications. An item in the end self-assessment of the survey and a space to suggest research topics. Data analyzed by SPSSv.21

RESULTS

23 doctors are surveyed, everyone knows the digital tool, 34.8% use it daily, 21.7% several days a month and 26.1% never used. 52.6% open messages with alert symbol, 47.4% open all messages, 63.2% calls the patient with abnormal results, 31.6% expect to go on their own and 8.7% do nothing. 78.9% Rate digital useful tool, 21.1% did not.

To use, "84.2% consider it a necessary one additional time in medical practice", 17.4% believe no longer useful. Who consider additional time in medical practice 4.3% consider 5-10 minutes, 47.8% 10-15 minutes, 36.4% 15-20 minutes, and 13% more than 20 minutes.

None requests further tests from the use of the portal. Most (84.2%) believed that these surveys help manage medical practice.

The final opinions suggest researching emergencies in primary care and patient hyper-frequenter.

CONCLUSIONS

Digital tools in medical practice are necessary and useful.

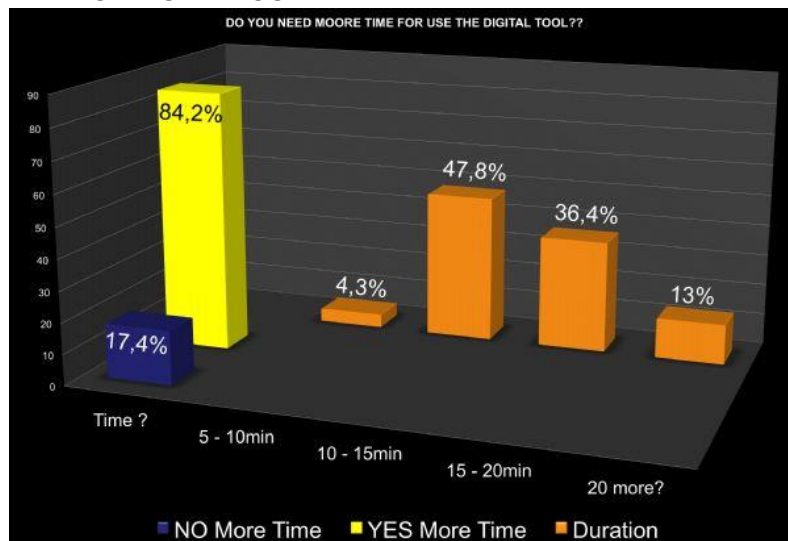
Alerts on digital tool accelerate the detection of altered tests.

It is considered necessary additional time in medical practice to use them.

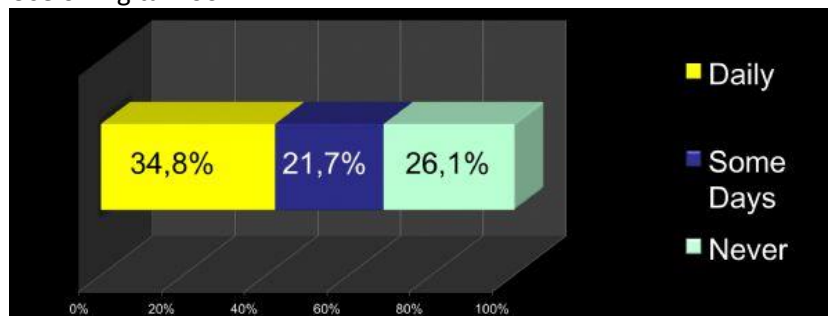
The number of applications did not increase with the use of the portal.

Keywords: Primary Health Care, Continuity of Patient Care,Laboratory Techniques and Procedures, Quality Assurance, Health Care

TIME FOR DIGITAL TOOL



Use of Digital Tool



P-1214

Infant mortality as sentinel event for improving the quality of healthcare provided by Family Health Program

Selma Cristina Franco¹, Maria Volpato Kropiwicz², Terezinha Hillesheim², Fatima Mucha², Débora Galli Morais², Viviane Korovski²

¹Health and Environment Master, University of the Region of Joinville - UNIVILLE, Joinville, Brazil

²Secretary of Health, Joinville, Brazil

Background and AIM: Infant mortality (IM) is considered a sentinel event that may express quality of healthcare. This paper aims to describe the profile of IM occurred in areas assisted by Family Health Program and to report the analysis and recommendations of an Infant Mortality Prevention Committee (IMPC) regarding improvement of healthcare.

METHOD: Retrospective study conducted in a municipality in the south of Brazil with data collected through interviews with the families of children who died between 2010 and 2014, medical reports and death certificates. **RESULTS:** In the period, 316 infants died in the municipality, 119 of them living in areas assisted by Family Health Program. Infant mortality index was 8.2 per 1,000 live births and the neonatal component was 4.9. Mothers' characteristics showed high percentage of adolescents (22.7%) and insufficient number of prenatal care visits (63.7%). Newborn babies were mostly premature (63.9%) with low birth weight (68.9%). Most of the deaths occurred in State-run hospitals (76.5%) due to perinatal causes (42%) and malformation (28.6%). Investigation of deaths conducted by IMPC showed problems in health care provided by Family Health Program (18.5%), Neonatal Intensive Care Unit (10.1%) and Prenatal (8.4%). According to SEADE criteria, 79.8% of the deaths could have been avoided by preventive measures, early diagnosis and prompt treatment (42.9%). IMPC performed correction in national databases (37% of the deaths), forwarded written responses and orientations to Family Health Teams (17.6%) and discussed healthcare problems with professionals (11.8%).

CONCLUSIONS: Most of infant deaths (79.8%) were preventable. Knowledge on the profile of deaths and

investigation performed by IMPC indicate there is possibility for improvement in the quality of healthcare delivered at Family Health Program and generate useful data for local planning.

Keywords: Infant Mortality; Child Mortality; Family Health; Quality of Health Care; Sentinel Surveillance

P-1215

Can general practices read a point-of-care urine culture? General practices' ability to interpret the Flexicult™ using an online multiple-choice-test

Anne Holm, Volkert Siersma, Lars Bjerrum

The Research Unit for General Practice and Section of General Practice, Department of Public Health, University of Copenhagen

BACKGROUND & AIM

Urine culture and susceptibility testing in general practice is common in Denmark. The Flexicult™ ssi Urinary kit, a chromogene agar for urine culture and susceptibility testing, has been validated and ongoing trials are testing it clinically. The ID Flexicult™ is a chromogene agar for culture only. The aim of this study was to investigate if general practices were able to read and interpret the two tests and to generate hypothesis about factors influencing test performance.

METHOD

General practices participating in a randomized controlled trial were told to complete an online multiple-choice-test. The test consisted of ten photos, five of the Flexicult™ ssi Urinary kit and five of ID Flexicult™. For each photo, the respondents should answer if they found significant growth or not. Two photos had no significant growth and eight had significant growth.

RESULTS

17 practices answered the test with 37 respondents in total. The number of respondents per practice ranged 1-9. On average, 89% were correctly answered. Growth was correctly identified in 90% of cases, no growth in 85%. The probability of answering correctly was tested in a logistic regression model including photo, respondent background (owner, employed doctor or other staff) and type of clinic as covariates, and GEE methods to adjust for multiple answers per respondent. The respondents' background was associated to answering correctly, but the difference was not statistically significant. Some photos turned out more difficult to answer correctly than others and the difference was close to statistically significant ($P < 0.07$).

CONCLUSIONS

In this small online-test, general practices performed well in reading the Flexicult™ both with and without susceptibility testing. Photo-based online tests could be used for quality control in primary care, but photo difficulty and respondent background has to be taken into account when designing and evaluating the test.

Keywords: Urine culture, Point of Care Test, Urinary Tract Infections [Mesh]

P-1216

Patient-related continuity of care has deteriorated markedly in general practice in Finland from 1997 to 2012

Risto Raivio¹, Kari Mattila², Tuula Arvonen³, Seppo Voutilainen³

¹Primary Health Care Unit, Joint Authority for Päijät-Häme Social and Health Care Group, Finland

²School of Medicine, Department of General Practice, University of Tampere, Finland

³General Practitioner (retiree), Finland

Background and Aim

Continuity is an essential aspect of primary care quality. We here assessed patient-related continuity of care in general practice in the City of Oulu in Northern Finland. We also studied the relationship between the patient indicators and the continuity of care.

Method

We conducted a follow-up questionnaire survey in 1997 and 1999, and from 2002 to 2012 every second year among patients attending the Oulu health care centres. We used the questionnaire "The quality of health centre care: patients' view" developed in the National Research and Development Centre for Welfare and Health and subsequently adapted by the National Institute of Welfare and Health of Finland. Continuity was assessed by the question: "When visiting the health centre, do you usually see the same doctor?" The relationship between the indicators of patients and the continuity of care was analyzed in the questionnaires in 2010 and 2012.

Results

Continuity of care in general practice in Oulu decreased from 92 % to 30 % from the year 1999 to 2012. During the years 2010 and 2012 continuity of care was 41 % among patients 60 years or more and 37% among those who attending consultations more than six times. Continuity of care was realized slightly better in the elderly age-group and in the frequent attenders' group than in other groups. There was no relationship between gender or education and continuity of care.

Conclusions

Patient-related continuity of care deteriorated significantly in general practice in Oulu health care centres in Northern Finland from 1997 to 2012.

Keywords: Patient-related continuity of care, general practice, questionnaire

Table 1

Patient-related items	OR (95 % confidence interval)	p
Woman	1,22 (0,95–1,51)	0,115
Age 60 years or more	2,25 (1,78–2,84)	<0,001
Lower education	1,08 (0,86–1,36)	0,487
Previous visit	1,18 (0,93–1,50)	0,171
More than 4 visits before	1,50 (1,19–1,89)	0,001

Table 1: Patient-related covariates explaining continuity of care (same doctor) in binary regression model

Figure 1

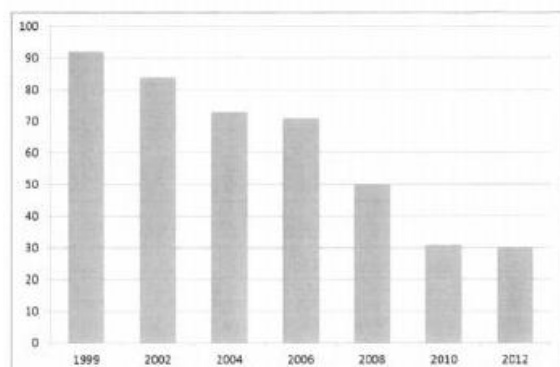


Figure 1: The percentage (%) of those patients who usually saw the same doctor in the study years (1999-2012)

P-1217

TITLE Internal Communication Plan

Anna Forcada Arcarons, Laura Almendros Plana, Josefa Soler Arau, Silvia Altimiras Rovira, Engracia Costa Atienza, Alícia Díaz Pilco

institut català de la salut

BACKGROUND

Internal communication is the basis of media organizations. It is addressed to the internal customer and comes in response to the needs of companies to motivate his team.

There is no good corporate communication (neither external) without good internal communication.

AIM

- Improve communication between professionals and promoting participation
- Improve efficiency and participation of people of the team
- Improving relations between different levels
- To promote the sense of belonging to the organization
- Reduction of collateral information
- Improve the work environment

METHODOLOGY

Descendant communication: goes from one superior hierarchical level to a lower one. Provides information to people about what to do. Expected misunderstandings and build trust with respect to superiors. The tools are the ICS portal, GTCC intranet, SAP Management advices, EAP meetings, meetings for strata, team leaders meetings, corporate email, space R (located on each computer), information panel in the rest room.

Ascendant communication: It originates in a lower hierarchical level and goes to the top. Reveals the working environment of workers and stimulates creativity. Increase commitment to the organization. The tools are SAP Management advices, EAP meetings, meetings for strata, team leaders meetings, suggestions and corporate email inbox.

Horizontal communication: between professionals from different units of the same level or between components of a working group. Promotes teamwork. The tools are the clinical sessions, EAP meetings, corporate email, R space, information panel in the rest room.

RESULTS AND CONCLUSIONS

The communication plan allows us to improve the information to all levels of the organization, optimizing media and channels of communication within the team, create a good climate for communication and a sense of belonging to a tea

Keywords: Internal communication, media organization, motivation

P-1218

How we manage the Ramadan in the Primary Healthcare centre of Manlleu

Anna Forcada Arcarons, Silvia Altimiras Rovira, Lluisa Barranco Cozar, Maria Callis Privat, Anna Maria Garcia Moreno, Carla Hernandez Bacardit, Marta Roca Lafont, Alícia Díaz Pilco

institut català de la salut

BACKGROUND

The month of Ramadan is the 9th month of the Muslim calendar and has 30 days. It is one of the five pillars of Islam. From sunrise to sunset can not drink or eat, or smoke, or sexual relations.

Are excluded, the sick, pregnant women, breastfeeding women, young children, the elderly or who might harm their health. This protocol is designed for all Primary Health Care team of Manlleu for good coordination between public health, the correct use of health services and patient safety practitioner of Ramadan.

AIMS

- To program tests and visits of the users effectively.
- Optimize health resources with the right information and a prudent time in advance.

METHODOLOGY

Annually information through Iman of the community to know which is the month of Ramadan.

Each group made some specific actions:

- Doctors and Nursing: will assess if some analytics and / or tests can be postponed until after the month of Ramadan. Insist on the importance of continuing with diet and medication according to the user's pathology.
- Administrative: inform the user of practicing Ramadan fasting compulsory whether to do some testing. Postpone the test unless it is urgent.
- Dentistry: will postpone control visits

Users requesting an urgent visit, the health professional will inform the attending high probability that prescribes medication may interfere with Ramadan and try to adapt the pattern of medication.

RESULTS

During the month of Ramadan in 2013 there was a 13.39% of Ramadan practitioners who could not realize the analysis because they had not applied fasting.

During the month of Ramadan in 2014, when the protocol was applied the incidents were reduced at 3.16 %.

CONCLUSIONS

Ramadan protocol applied in our center has been very efficient.

Keywords: Ramadan, primary health care, resources optimization

P-1219

General practitioners' views on the integration of a non-dispensing pharmacist into general practice

Vivianne Sloeserwijn¹, Antoinette De Bont², Dorien Zwart¹, Marcel Bouvy³, Han De Gier⁴, Niek De Wit¹, Anne Leendertse¹

¹Julius Center for Health Sciences and Primary Care, University Medical Center Utrecht, Utrecht, The Netherlands

²The Institute of Health Policy and Management, Erasmus University, Rotterdam, The Netherlands

³Department of Pharmaceutical Sciences, Utrecht University, Utrecht, The Netherlands

⁴Department of Pharmacotherapy and Pharmaceutical Care, University of Groningen, Groningen, The Netherlands

BACKGROUND & AIM: Risk factors for medication-related problems are age, polypharmacy and multimorbidity. Given the ageing of the population, the population at risk will grow in near future. Hence, new strategies are needed to improve the quality of pharmacotherapy in clinical practice. There is growing support to expand the role of pharmacists in the process of medication management, for example by integration of a non-dispensing pharmacist (NDP) in a general practice. The aim of this study is to describe general practitioners' (GPs) perspectives on the integration of a NDP in general practice.

METHOD: Semi-structured interviews with ten GPs were conducted 6 months after NDPs started working in their practices, to identify GPs' views on the integration of a NDP in primary care and their current experiences. At 12 months additional in-depth interviews were conducted. Interviews were audio-taped and transcribed verbatim. NVivo was used to perform qualitative analyses.

RESULTS: Interviews after six months showed that most GPs agreed on the initial need for improvement of provided pharmaceutical care. They collectively agreed that a NDP was an appropriate professional to assist with medication management. Required competencies and various roles for the NDPs were described. Overall, GPs' perspectives on the integration of a NDP were positive. GPs experienced an increased medication safety as a consequence of better collaboration in medication management. Also several barriers – mainly logistic – were reported. Results of the in-depth interviews after 12 months, will be available and presented at the conference.

CONCLUSIONS: After six months, GPs' perspectives on the integration of NDPs are positive. All GPs experienced an increased medication safety.

Keywords: General practitioner, Pharmacist, Pharmacotherapy

Results: GPs' opinions

Results: GPs' opinions		
After 6 months <i>In-depth interviews</i>	After 12 months <i>Focus-groups</i>	After 15 months <i>Post-intervention</i>
Need for improvement		
Increased medication safety, by improved collaboration in medication management	Increased medication safety	5 NDPs continued working in GP practices, after the intervention-period
Barriers	Barriers ↓	Barriers ↓↓↓
<ul style="list-style-type: none"> Lack of appropriate remuneration Accommodation Influence on the workload of GPs +/- Pharmaceutical expertise vs. clinical knowledge 	<ul style="list-style-type: none"> Lack of appropriate remuneration Influence on the workload of GPs + Clinical knowledge ↑ 	<ul style="list-style-type: none"> 2 NDPs: financial barriers

The POINT-study, Julius Centre, UMC Utrecht, The Netherlands



P-1220

A mixed-methods evaluation of emerging large-scale family medicine organisations in England

Natasha Curry, Alisha Davies, Kushal Barai, Claire Currie, Lucia Kossarova, Stephanie Kumpunen, Niraj Patel, [Luisa Pettigrew](#), Rebecca Rosen

Nuffield Trust

BACKGROUND & AIM: The international trend towards federating family doctors into large-scale organisations has attracted significant attention in England, but the impact of these organisations on outcomes (for patients, populations and staff) relative to traditional models of family medicine remains unevaluated. This two-year study examines the aims, benefits and challenges to delivering high-quality care in emerging large-scale family medicine organisations.

METHOD: A mixed-methods approach was used to examine the evolution of 12 large-scale family medicine organisations, including four in-depth case studies. Document analysis, semi-structured interviews and observations were undertaken to understand organisations' aims and structures, motivations for forming, and factors affecting development. Time trends in nationally available practice-level quality indicators were compared between and within organisations, and to national benchmarks.

RESULTS: Interim case study results reveal that the principal aims for organisations' formation included improving care, ensuring capacity and sustainability, and bidding for large service contracts. Many clinical governance and quality improvement systems and processes were in place or under development across organisations, but attributing changes in quality to particular quality initiatives or organisational forms requires additional analysis.

CONCLUSIONS: Lessons identified in the organisations' formation are of significant importance given the national and international drive to implement new models of large-scale family medicine. It may be too early to identify changes in quality of care, but further analysis of the in-depth case studies will enable examination of more specific quality metrics and determine whether new models provide benefits relative to 'traditional practice'.

Keywords: large-scale family medicine organisations, quality, mixed-methods evaluation, England

P-1221

Usage of an unobtrusive decision support system in general practice

Derk L Arts¹, Stephanie Medlock², Saeid Eslami², Ameen Abu Hanna², Henk C Van Weert¹

¹Department of general practice, Academic Medical Center, Amsterdam, The Netherlands

²Department of medical informatics, Academic Medical Center, Amsterdam, The Netherlands

Aim and PURPOSE: Adherence to clinical guidelines is reported to be as low as 50%. Studies have shown decision support systems can improve guideline adherence. We implemented a clinical decision support system to improve guideline adherence among general practitioners (GPs). We report on usage of the system over time.

METHODS: We developed a novel decision support system that displayed a list with pending recommendations for the on-screen medical record in real time. Recommendations could be opened for a description or ignored.

Usage of the system was investigated in a randomized controlled trial by tracking mouse movement and clicks.

RESULTS: A recommendation was triggered 336141 times, resulting in an average of 55 recommendations per GP per day. Usage, defined as [opened recommendations] / [total recommendations], was on average 0.012%.

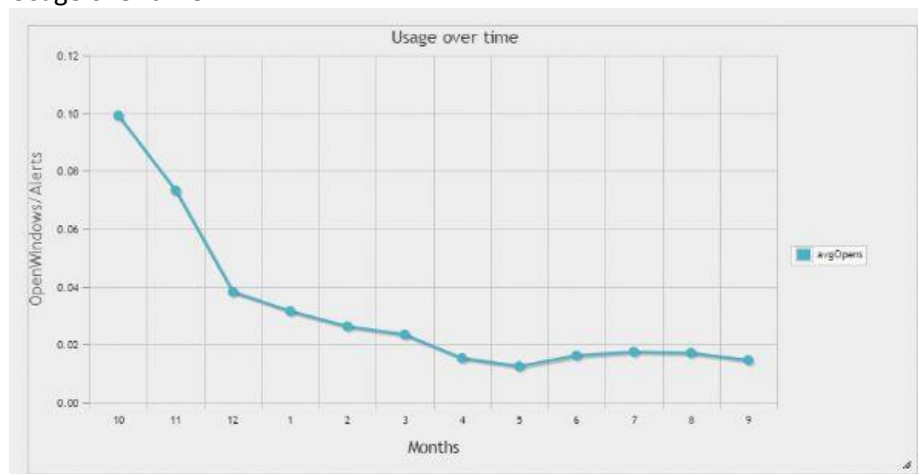
Overall usage over time declined with an average usage of 9.9% during the first month and 1.7% after 9 months.

Usage per GP ranged from 0% to 8%. Recommendations with the highest usage pertained to fall and stroke prevention while those with lowest usage pertained to diabetes care and benzodiazepine usage.

CONCLUSION: We performed a randomized controlled trial to study the usage of a clinical decision support system in general practice. Usage of the system was low and decreased over time. There were big differences in usage between GPs and usage depended heavily on recommendation content.

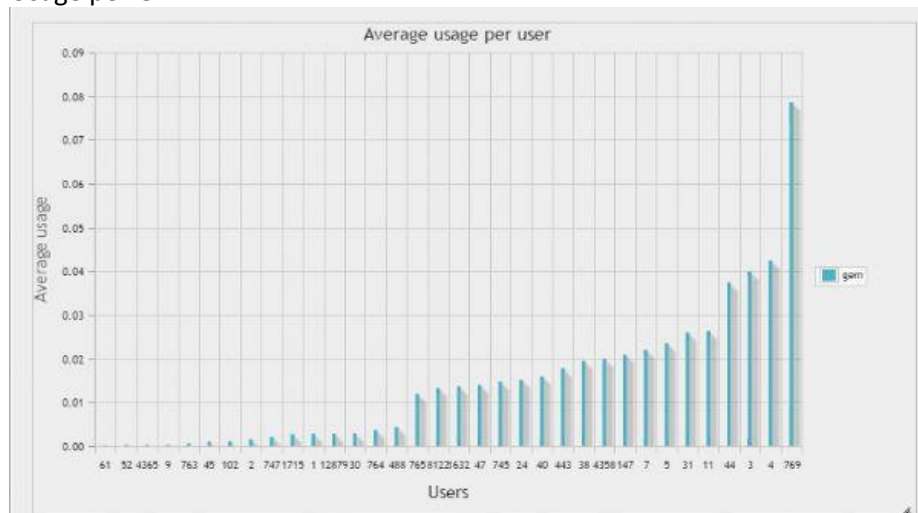
Keywords: decision support, general practice, usage, healthcare it, guidelines

Usage over time



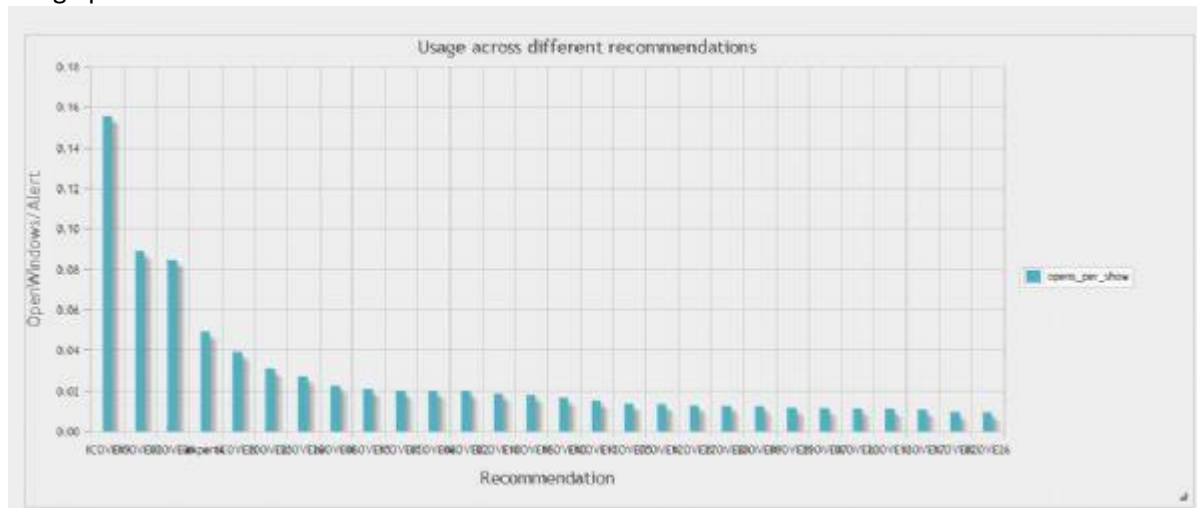
[This is not the final image to be used in the presentation.] Overall usage of the CDSS over time (9 months).

Usage per GP



[This is not the final image to be used in the presentation]. Usage of the CDSS by individual GPs.

Usage per recommendation



[This is not the final image to be used in the presentation]. Overall usage of the CDSS by recommendation content.

P-1222

Improving pharmaceutical care by integration of a non-dispensing clinical pharmacist in Dutch primary healthcare: a Q-study on the debate

Ankie Hazen¹, Vivianne Sloeserwij¹, Dorien Zwart¹, Marcel Bouvy², Han De Gier³, Niek De Wit¹, Anne Leendertse¹, Antoinette De Bont⁴

¹Julius Center For Health Sciences And Primary Care, University Medical Center Utrecht, The Netherlands

²Department of Pharmaceutical Sciences, Utrecht University, The Netherlands

³Pharmacotherapy and Pharmaceutical Care, University of Groningen, The Netherlands

⁴The Institute of Health Policy & Management, Erasmus University Rotterdam, The Netherlands

Background & AIM: Lately, the role of pharmacists in the Netherlands is changing: instead of mainly organising and monitoring logistic processes (e.g. dispensing the right medication to the right patient), the focus is increasingly on providing patient care. The most profound example of this shift in scope is the integration of a non-dispensing pharmacist in a primary care team. Opinions on these developments differ widely. The aim of this study is to provide insight in differences and similarities between general practitioners, pharmacists and external stake holders in their opinions on integration of a pharmacist in primary healthcare.

METHOD: Based upon an extensive literature search and six semi-structured interviews with healthcare professionals, 37 statements on pharmaceutical patient care in the Netherlands were formulated. In a period of five months, general practitioners, pharmacists and external stake holders in primary care were invited to rank-order these 37 statements and to explain the order chosen. Groups of participants with different or shared mindsets were identified using by-person-factor analysis.

RESULTS: This study identifies the degree of consensus on specific statements about a non-dispensing pharmacist integrated in primary care. Preliminary results showed that no consensus existed on the need for pharmacists to fully shift their focus from dispensing drugs to providing pharmaceutical patient care, nor on whether GPs' knowledge about pharmacotherapy is sufficient or not. Consensus existed on the importance of having access to patient information in order to improve quality of pharmaceutical patient care. Further results will be available and presented at the conference.

CONCLUSIONS: Integration of a non-dispensing pharmacist in primary care is controversial.

Keywords: general practitioner, pharmacist, pharmacotherapy

P-1223

Creating a Simple and Comprehensive Primary Care Library Catalogue using Referencing Resources

Adam Azzam, Soleman Begg

St John's Hill Surgery - Begg Practice

This poster disseminates the practical experiences of using online tools and current referencing applications to create a comprehensive and searchable library catalogue. With a critique of currently available tools including: Google Scholar, End Note, Reference Manager and ProCite.

This poster focuses upon the organisational aspect of primary care.

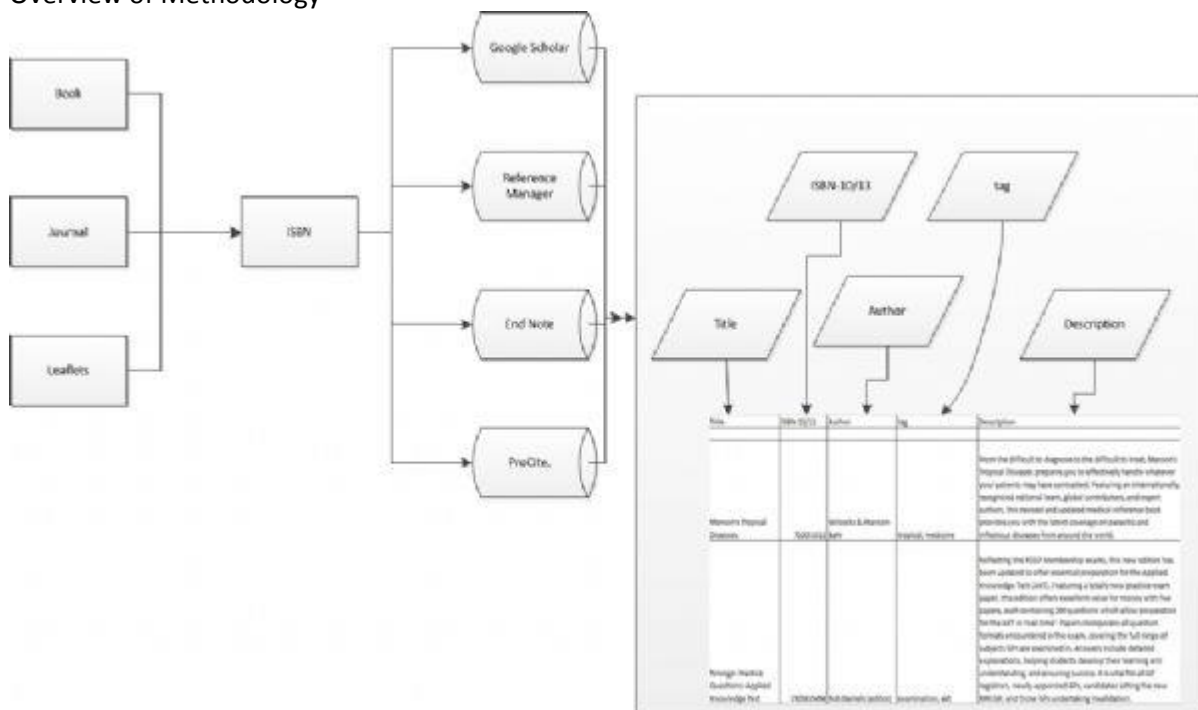
PURPOSE: To encourage the use and accessibility of the contents of libraries within Primary Care Centres.

METHOD: Allowing accurate and quick indexing and tracking of the books. Simultaneously increasing accessibility of these resources to the staff members within a surgery, including trainees. As well as reducing loss of the books.

This will also enable the reader to decide upon their preferred method of completing. With suggestions for how to use of developing technology in the future (eg mobile devices).

Keywords: Organising, library, books, catalogue, reference, indexing

Overview of Methodology



Cataloging Methodology

P-1224

Ensuring quality management in drug prescription at Primary Care

Gemma Puig Ponsico, Isabel Rosich Martí, Mònica Torremorell Núñez, Esther Diaz Salcedo, Cristina Gallardo Sánchez, Margarita Navarro Pujol, Mar Pérez Herrera, Herminia Palacín Piquero, Josep Maria Vidal Royo, Miquel Perona Pagán

SAP Garraf, Institut Català de la Salut, Catalonia, Spain

Background and Aim

A computerized module integrated into the medical patient record called Self-audit supports physicians in reviewing their prescription. Self-audit allows the physician to perform a self-assessment in the drug prescriptions process. It also allows running searches in the database of ECAP (the medical record software) in those patients who meet clinical conditions relating to the use of drugs that may be improved and providing alternatives easy to apply.

Improvements can be made in different areas of the drug prescription (safety, effectiveness and efficiency). In this experience we prioritized safety considering its implication on the patient healthcare.

The aim of the study is to analyze the results of the review of patients with security incidents in prescription through the self-audit tool

Method

Intervention study conducted in before-after in 5 primary healthcare teams in the Area of Primary Care Garraf that gives health coverage to a population of 132.634 patients. The impact is measured as assessment/reduction of patients that Self-audit identifies incidents with security alerts, duplication of medication and polimedication during the year 2014.

Self-audit detects: 1.Security alerts communicated by the Spanish Agency for Medicines and prioritized by their clinical relevance (Identification of patients with contraindications); 2. Duplications high relevance; 3.

Polimedication in patients > 65 years > 10 drugs

Results

The total number of incidents in the baseline period were: Security Alerts (61) duplicities (890) and polimedication (1273) and in the final period Security Alerts (14) duplicities (404) and polimedication (910).

The reduction in Security Alerts was a 77%, duplicities 54.61% and polimedications 28,71%.

Conclusion

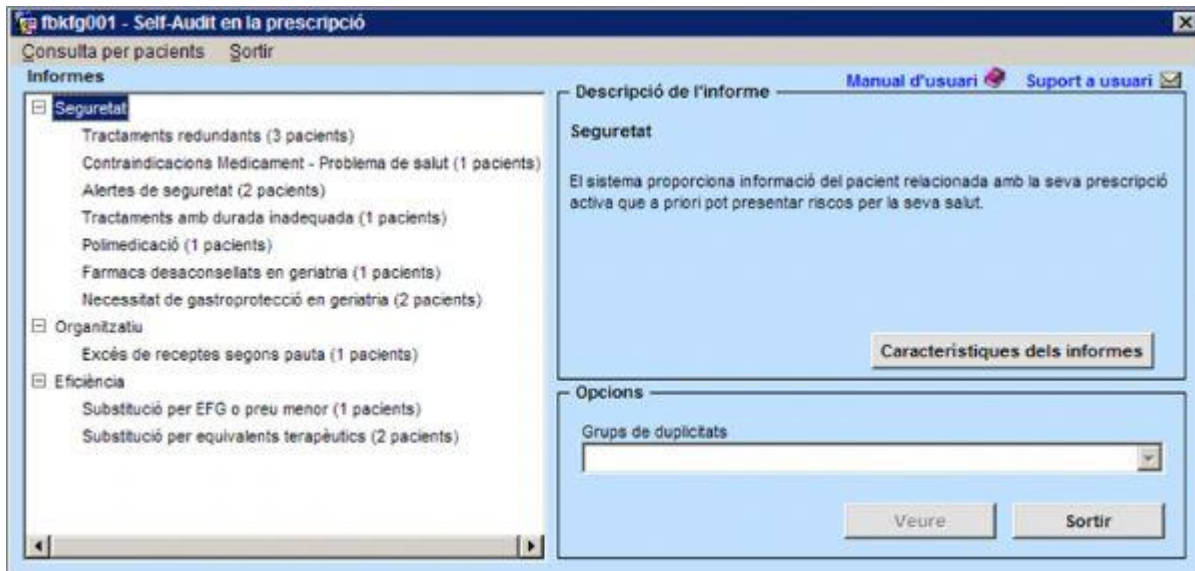
The Self-Audit tool built-in the computerized medical record allows the family doctor identify security alerts and take decisions in the patient treatment according to clinical conditions of each of them in the act of health care.

Keywords: : Quality of Health Care, Drug Prescriptions, Primary Care

Security drug prescription



Self-Audit tool



Drugs evaluated by Spanish Agency for Medicines as a Security Alerts

Cilostazol

Citalopram and Escitalopram

Coxibs (celecoxib, etoricoxib), diclofenac

Strontium ranelate

Trimetazidine

Raloxifene and bacedoxifene

Total number of incidents in the baseline period / final period and % alerts reduction

ALERTS	Baseline period	Final period	% alerts reduction
Security	61	14	77
Duplicities	890	404	54,6
Polimedicacion	1273	910	28,7

P-1225

poverty and childhood

Hadiye Küçükkaragöz¹, Selbinaz Güneş²

¹DEÜ EDUCATION INSTITUTE FAMILY COUNSELING AND EDUCATION DEPARTMENT

²Family and Social Policies Minister, Social Services Department

This research is examined the effects of poverty over children between eight (8) and fifteen (15) ages in physical, cognitive, social and emotional manner. Main purpose is to identify how children, who are obligated to live in poverty, are affected by poverty. Children's thoughts, feelings and behaviors and the influence of poverty variables (age, gender, family members, education, siblings, parental education, employment, whether parent(s) dead or alive, conditions of handicapped parents, school and friendship etc.) are examined.

This study is a relational/ descriptive model and both quantitative and qualitative data collection tools are used. Population consists of poor families and theirs' children live in Buca, İzmir in 2014. Sample group 30 families and their children who are applied for monthly financial aid to Buca Social Service Department Social and Financial Support Division.

Data tools, developed by researchers, are; a) interview survey form which is constituted to determine socio-demographic and economic conditions of poor family (FSDEF), b) a semi-structured interview form for children to analyze psycho-social effects of poverty over children and (CPSIF) and c) a semi-structured interview form for mothers to examine their opinions about poverty and family development (mothers interview form family interaction), (MIFFI). The data, is evaluated with review of literature and outcomes are presented through frequency, percentage and descriptive/ content analyze.

40 % of family members that contributed to the research are primary school graduates and 36 % of the research sample is illiterate. It is concluded that 90 % of the families are supported by governmental agencies when they had a financial difficulty and 83 % of their children are not working after school in order to earn money.

Keywords: Poverty, Childhood, Family, Counseling,

P-1226

Development of Clinical Practice Guideline Adaptation Strategy and Pilot Testing of Strategy

Duygu Ayhan Başer¹, Rabia Kahveci², Ilknur Yaşar⁴, Meltem Koç³, Irfan Sencan², Ismail Kasım², Adem Özkara²

¹department of family medicine, Kocaeli Deince Public Health Center, Kocaeli, Turkey

²department of family medicine, Ankara Numune Training and Research Hospital, Ankara, Turkey

³department of family medicine, Mamak Public Health Center, Ankara, Turkey

⁴department of family medicine, Yenimahalle Public Health Center, Ankara, Turkey

INTRODUCTION: The development of high quality clinical practice guidelines is very important. The clinical practice guidelines developed by using 3 methods in all over the world. In our country, guidelines are developed by de novo methods or translated directly; adaptation method don't known and used in Turkey.

Our goal with this study is to develop adaptation strategies specific to Turkey for clinical practice guidelines and to adapt the ADAPTE manual to develop this strategy.

MATERIALS-METHODS: "ADAPTE Adaptation Guideline" determined as a basis guide to develop adaptation strategies specific to our country. The ministry of health translation guidelines for primary health care was considered appropriate to the pilot study. Adaptation required areas of the selected pilot guidelines' have been identified. During the implementation of adaptation of pilot guidelines, the availability of ADAPTE' with current state was tried, the additional parameters in guidelines which should be used in the adaptation process was also determined.

FINDINGS: As a result of adaptation of ADAPTE guideline to conditions in Turkey, 2 of 24 steps rejected, 4 of them have been accepted with modification, 3 of them have been accepted with additional suggestions.

As a main result of pilot tests showed that translated guidelines required adaptation especially on diagnostical recommendations.

RESULT: The guideline adaptation is a new concept for many countries and the institution / organizations. By the adaptation of ADAPTE Adaptation Guidelines to our country, the usage of this guideline in our country will be facilitate and the information in the guidelines that will useful to audience to use and will be created in the days

ahead, will be collected in a guideline more quickly with less effort by the selection, screening, or modifying and without having to spend much material and spiritual effort as de novo methods and methods.

Keywords: Clinical Practice Guidelines, Guideline Development, Adaptation Method, Turkey

Figure 2

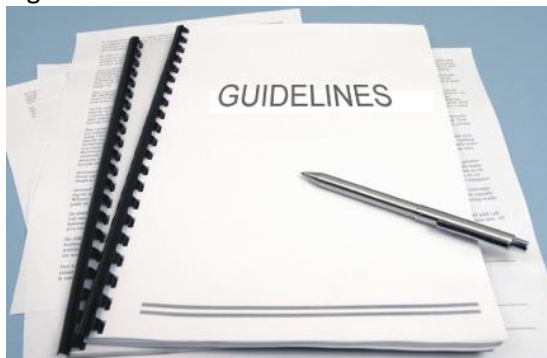
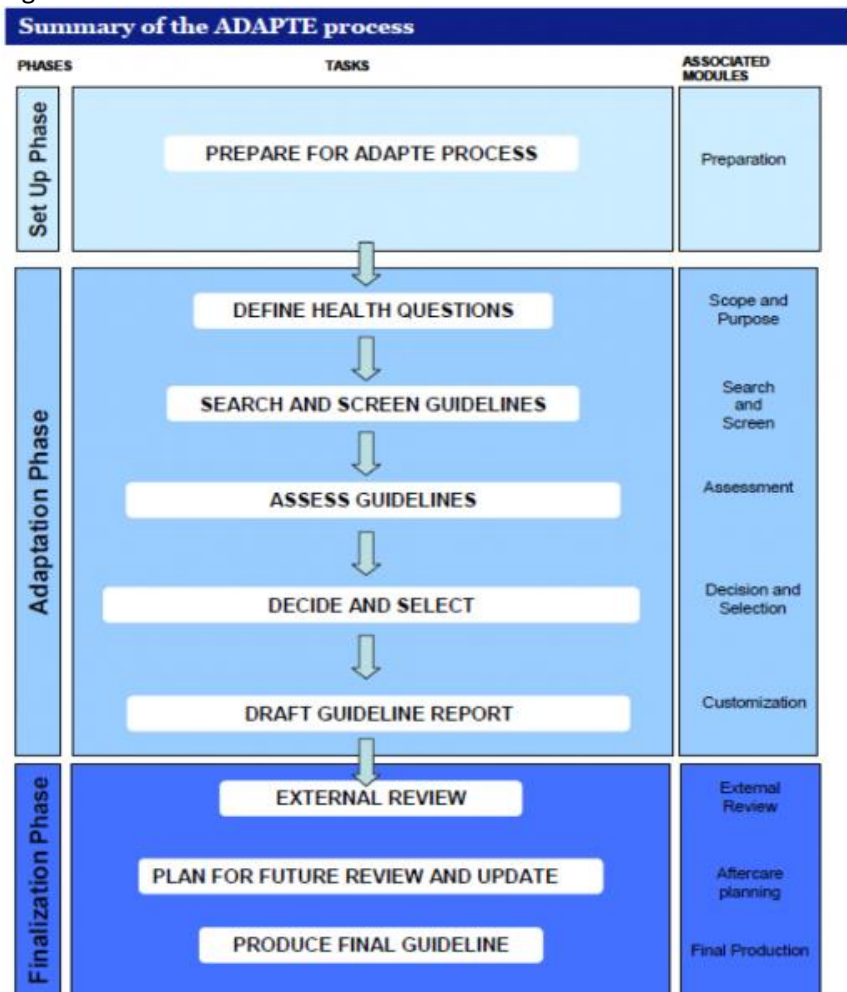


Figure 3



Figure 1



ADAPTE steps

P-1227

Quality of iron deficiency anemia diagnosis and treatment in pregnant women

Isa Maria Cruz, Ana Paula Fonseca, Márcia Filipa Soares

USF Cruz de Celas, ACeS Baixo Mondego, Coimbra, Portugal

AIM: Evaluate the quality of iron deficiency anemia diagnosis and treatment in pregnant women, according to clinical guidelines provided by the Portuguese Health Authority (NOC nº 030/2013 de 31/12/2013).

Population: Pregnant women who had an appointment at our family health unit from 18/09/2014 to 18/02/2015 (first assessment period). The second assessment period is scheduled from 18/05/2015 to 18/10/2015.

Data source: Electronic medical records.

Data analysis: Descriptive and growth dynamics (Δ).

Evaluation type: Internal, between-peers and retrospective.

Quality criteria:

1 – Diagnosis of iron deficiency anemia in pregnant women (microcytosis; hypochromia; hemoglobin: 1st and 3rd trimesters < 11g/dl; 2nd trimester < 10,5 g/dl; serum ferritin < 70 ng/ml).

2 – Iron supplementation of pregnant women with diagnosis of iron deficiency anemia (starting treatment after determination of serum ferritin).

Exclusion Criteria:

3 – Pregnant women not followed by their family doctor (by choice or pregnancy with mild to high risk).

4 – Women “misdiagnosed” as pregnant (still encoded in electronic medical records as pregnant, but already delivered).

Intervention: oral presentation at service meeting on the principles of iron deficiency anemia in pregnant women and first assessment data.

RESULTS: Sample: 62 pregnant women (on 1st assessment). After application of the exclusion criteria: 23 pregnant women - 9 were diagnosed with iron deficiency anemia and treated with iron supplementation. 2 of them were correctly diagnosed with anemia, and medicated, but serum ferritin was not requested. The remaining 7 were misdiagnosed with anemia, serum ferritin was not requested, but were medicated with iron supplementation.

CONCLUSIONS: At this point, it is apparent that the diagnosis and management of iron deficiency anemia in pregnant women is frequently inaccurate. It's important to warn family physicians to this issue, given that iron supplementation is often poorly tolerated, affecting the well-being of pregnant women.

Disclosure: No conflict of interest declared.

Keywords: iron deficiency, anemia, pregnant women

P-1228

Opioid therapy in our population

Joaquín Brea Aymerich¹, Laura Torrente Nieto², Albert Mora Martinez¹, Mireia Cramp Vinaixa³, Teresa Basora Gallisa¹

¹Centro de Atencion Primaria, Reus 4-Horts de Miro. Institut Catala de la Salut.

²Centro de Atencion Primaria, Reus 1. Institut Catala de la Salut.

³Centro de Atencion Primaria, La Granja-Torreforta. Institut Catala de la Salut.

Background and AIM: Pain, the most common reason for consultation in primary care, is described as an unpleasant sensory and emotional experience associated with real or potential tissue injury. For its treatment we use the WHO's analgesic ladder: first step (NSAIDs and/or analgesics), second step (lower opioids+/first step) and third step (higher opioids+/first step). There is also the possibility of adding adjuvants (corticosteroids, anxiolytics, antidepressants, anticonvulsants, neuroleptics) and nonpharmacological treatments.

The aim is to know the characteristics of the pain in the patients treated with opioids in our area, evaluate if the treatment pattern is correct (according to the WHO's ladder), and assess the therapeutic compliance and the adjuvant treatment needs.

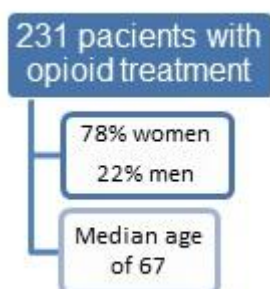
METHODS: Longitudinal retrospective study in an area with approximately 23000 inhabitants. Variables: total number of patients with opioids treatment. Of them: age, sex and reason of the treatment. Regarding the treatment: WHO analgesic ladder, type of opioid, adjuvant treatment and therapeutic compliance.

RESULTS: Of all the 231 patients with opioid treatment, 78% were women and 22% men, with a median age of 67. Pain type: 8,6% acute, 59,3% chronic and 22,1% sharp chronic pain. Reason of opioids treatment: 78% traumatological, 5% oncological and 1% surgical. WHO analgesic ladder: 75% of the total with second step (74,9% tramadol, 3,5% codeine) and 25% with the third step (11% fentanyl, 6% oxycodone, 5% buprenorphine, 2% tapentadol, 1% morphine, 0,4% hydromorphone). The 41,6% needed to combine two different drugs and 34,6% more than two. Coadjuvant treatment: 35,9% without and 64,1% with (13% anxiolytics, 13% antidepressants, 11% anticonvulsants, 3% neuroleptics, 2% corticoids, 20% with two or more drugs). The 90% had a good treatment compliance.

CONCLUSION: Most of the patients treated with opioids in our area are women. The main reason for using these drugs is for chronic pain with a traumatological origin. Minor opioids (2nd scale) are usually enough to control the pain, even though a large percentage need coadjuvant treatment to control it. The majority seem to have a good therapeutic compliance so we can consider them to be prescribed well.

Keywords: pain, opioids therapy, WHO's analgesic ladder

Patients



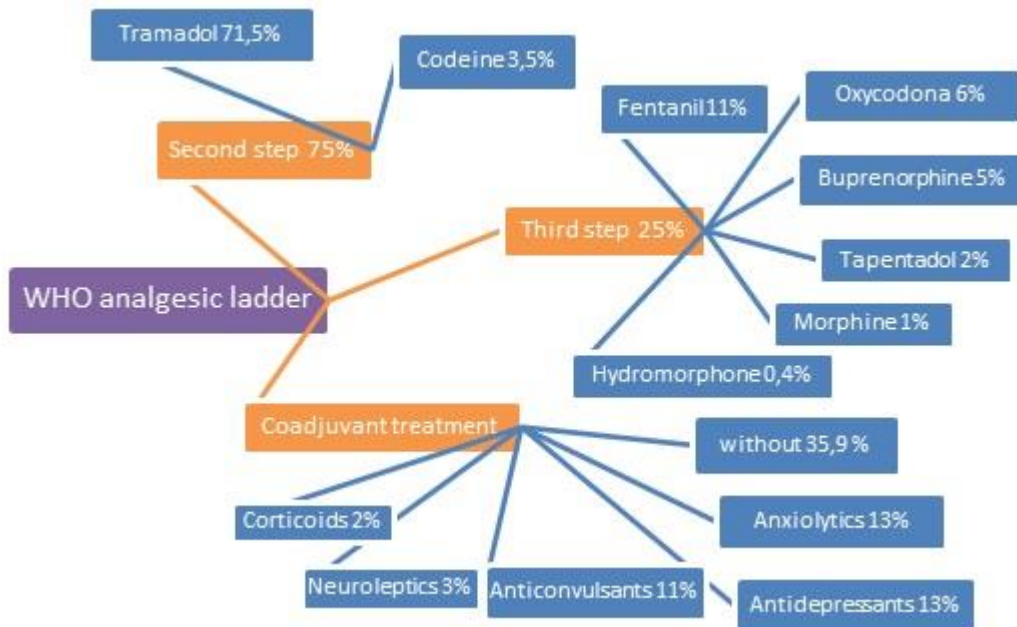
Pain type

Acute	18,6%
Chronic	59,3%
Sharp chronic pain	22,1%

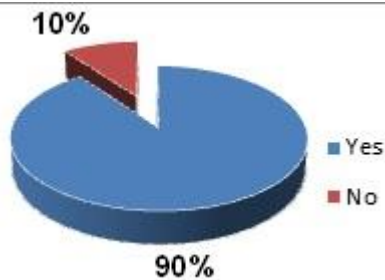
Reason of opioids treatment

Traumatological	78%
Oncological	5%
Surgical	1%

WHO analgesic ladder



Therapeutic Compliance



P-1229
Training as a quality criteria: descriptive study in Barcelona

Mireia Leal Negre, Carles Alvarado Montesdeoca, Cecília Doménech Rodríguez, Arantxa Castillejos Ruiz Molí Nou, Institut Català de la Salut, Sant Boi de Llobregat, Barcelona, Spain

Educating healthcare professionals is a key issue in the provision of quality healthcare services, and so, training in care quality is spreading. Quality is an innovative management philosophy that has been imported to healthcare from other industries and training is a cornerstone to archiving quality healthcare.

Meditating on the current situation in our organization, led us to want to know which was the starting point in order to settle down which areas we need to improve. So, we did a descriptive study, with the aim of collecting and analysing training needs. This study was conducted among professionals of different categories (health and non-health) in a health centre that serves to two populations, with a total of 21,000 inhabitants in Barcelona (Spain).

Data from our study was collected through personal interviews. The variables analysed were: professional category, sex, age, type of training requested, and if it matched with those detected by the management team, or not detected by management team.

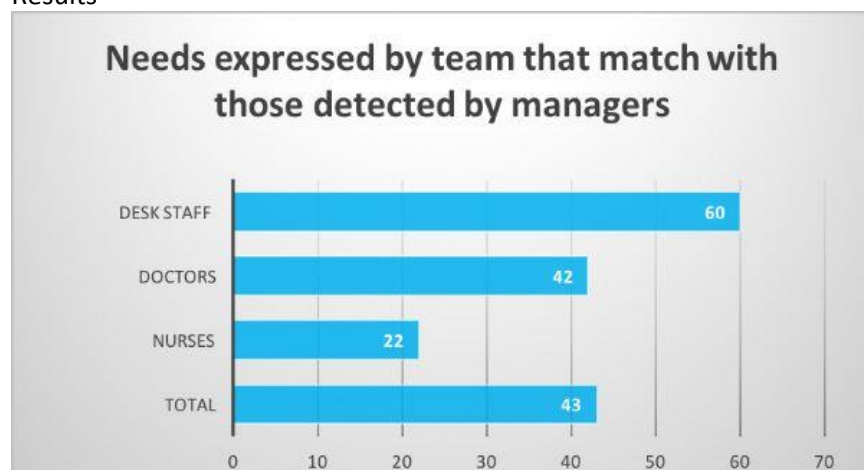
Participation was voluntary and the interview was strictly private.

The results show that only in a 43% of cases expressed needs match with those detected by the management team. By categories Doctors mach in a 42%, nurses only in a 22% and desk staff matches in a 60% of the cases. Only a 6% demanded Healthcare Quality training, however a 84% of the medical staff asked for training about cares.

In too many cases expressed needs differ from those detected by the management team and professionals do not want to be formed in Healthcare Quality training what is very worrying as it is where the strategic lines of the company are directed. We have to work harder in order to show our colleges how important quality training is for those who work in a health centre.

Keywords: quality, training, healthcare, health centre

Results



P-1230

Brief advice on stopping tobacco use- quality of medical records

Ana Paula Fonseca, Isa Cruz, Márcia Soares

USF Cruz de Celas, Coimbra, Portugal

Background and Aim

Scientific evidence indicates that advice from a doctor significantly increases smoking abstinence rates. Our propose is to assess, on appointments were the problem "tobacco abuse" were identified, if the tobacco use were quantified and if any type of advice was given.

Method

Population: smokers with an appointment at our primary care unit from 01/02/2013 to 31/03/2013 (1st assessment period) and from 16/04/2014 to 08/06/2013 (2nd assessment period). Data source: Electronic medical records. Data analysis: Growth dynamics (Δ).

Evaluation type: Internal, between-peers and retrospective. Quality criteria: all smokers identified should have a quantification of the tobacco use and a medical counselling. Exclusion criteria: smokers attending intensive interventions.

Intervention: oral presentation at service meeting on the importance of brief intervention on tobacco cessation and the results of the first assessment.

Results

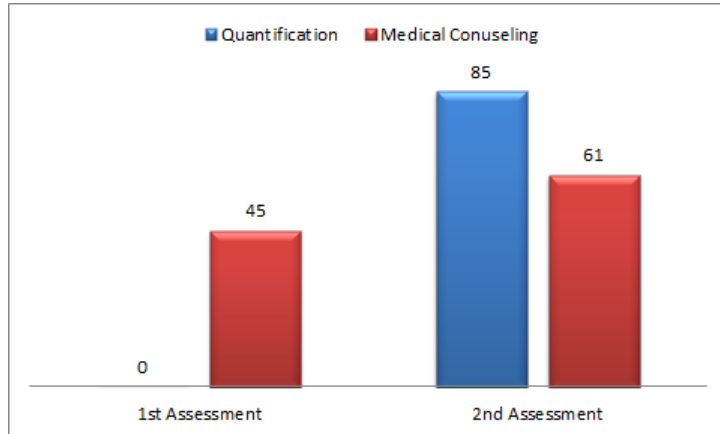
At the first assessment, 11 appointments were evaluated: none of them had a quantification of the tobacco consume and only 6 (45%) had a medical counselling recorded. At the second assessment, 54 appointments were evaluated: 46 (85%) had a quantification and 33 (61%) had a medical counselling.

Conclusions

Our results suggest that we improved the number of brief interventions, and probably the abstinence ratio.

Keywords: Brief Advice; Medical counselling; Quantification

Results of the first and second assessment.



P-1231

Routine urinalysis in asymptomatic adults – a study for the continuous quality improvement of clinical practice

André Pereira Lourenço¹, Aníbal Martins², Catarina Miranda³, Catarina Peixoto³, Luís Alves Sousa⁴, Margarida Moreira⁵, Mariana Afonso⁶, Rute Mota²

¹USF Modivas, AcES Grande Porto IV, Vila do Conde, Portugal

²USF Santa Clara, AcES Grande Porto IV, Vila do Conde, Portugal

³USF do Mar, AcES Grande Porto IV, Póvoa de Varzim, Portugal

⁴USP Espinho/Gaia, Porto, Portugal

⁵USF das Ondas, AcES Grande Porto IV, Póvoa de Varzim, Portugal

⁶USF Corino de Andrade, AcES Grande Porto IV, Póvoa de Varzim, Portugal

Background & Aim

Urinalysis is commonly requested as a screening tool in asymptomatic adults, since it (is) can be an easy, informative and non-expensive test. However, there appears to be no benefit in such procedure, since it almost never changes the course of investigation and its frequent false positive results imply more invasive and costly techniques, yielding very few, if any, advantages for the patient. As such, our group intended to evaluate the frequency with which such test is requested in asymptomatic adults and, after an intervention designed to inform and clarify its indications, reevaluate – do old habits die hard, or is adequate information a true power favoring change?

Method

We performed a retrospective analysis of all “general health” consults performed by 58 doctors (31 specialists and 27 trainees) along 8 weeks, prior and after the intervention. Hypertensive and diabetic patients were excluded. We scrutinized each individual consult, evaluating if urinalysis was requested and, if so, if the patient reported any signs and symptoms that justified it. We then proceeded to an informative intervention intending to expose the frailties of using urinalysis as a screening test, and reevaluated some weeks after.

Results

4341 consults were reviewed prior to the intervention, and of 864 urinalysis requests, 760 (87,96%) were on asymptomatic individuals. After the intervention, a total of 4043 records were analyzed, with 72,04% of the urinalysis requests being incorrect (15,92% difference; 95%CI of the difference 10,82-21,03, p<0,001)

Conclusions

After the intervention, the percentage of incorrect urinalysis requested dropped significantly, showing the success of our intervention. These results reflect the high potential of change that even simple measures (like an informative session) can have. Thus, it is important to reinforce these measures, so that the good results obtained in this project can be maintained or even improved.

Keywords: "urinalysis" "asymptomatic adults" "quality improvement"

P-1232

Promoting quality and integration of care through alliance contracting between funders, clinicians and the community. Using the New Zealand experience as an example

Les Toop¹, Vince Barry²

¹Department of General Practice, Univesity of Otago, Christchurch, New Zealand

²Pegasus Health Charitable Ltd, Christchurch, New Zealand

Traditional quality frameworks often contain multiple narrow clinical or process outputs rather than meaningful high level outcomes, too often focussed on individual bodily systems and diseases rather than on people and families, They are often applied to the work of single parts of the system e.g. general (family) practice.

In New Zealand, an innovative incentive quality framework has been developed, based around the triple aim, one which encourages integration across both health and social systems and whose top level system measures require input from multiple groups. Second level contributory measures use a quality improvement paradigm to manage variation rather than applying QA arbitrary thresholds. The implementation of this system requires the formation of district alliances between a variety of clinicians, funders and with community engagement. The guiding alliancing prinicple is to achieve consensus on approaches that foster integration and are best for patient / families and are best for system. This workshop will discuss the appicability of these principles to other countries and health systems.

Keywords: quality, integration, alliancing

P-1233

Nursing Students' Use of and Information about Complementary and Alternative Medicine

Edibe Pirincci¹, Ferit Kaya², Sultan Erol¹, Fulya Onal³

¹Firat University

²Public Health Directorate

³Ege University

BACKGROUND & AIM: This study examines nursing students' knowledge, attitudes and behaviors regarding complementary and alternative medicine (CAM). **METHOD:** This is a descriptive and cross-sectional study. The study sample consists of all the students (550 persons) in the Health College Department of Nursing. The questionnaire form was given to all the students who came to school while the study was conducted. The study was conducted in collaboration with 489 students agreeing to participate on a voluntary basis. Students' rate of participation is 88.9%. The author obtained the Ethics Committee's approval and written consent from the institution. The data collected were analyzed using the SPSS Program. In the analyses, values of $p < 0.05$ were accepted as statistically significant.

RESULTS: Of the participating students, 56.2% are female, and their average age is 21.29 ± 2.02 . The CAM methods that students are most informed about are religious practices (14.2%), exercises (14.2%), vitamins (13.1%) and massage (10.6%). The frequency of using alternative medicine is 51.3%. The CAM methods most commonly used by students include herbal products, vitamins and exercise and religious practices. Males have a higher rate of using CAM methods ($p < 0.05$). Students' use of CAM methods increases significantly with age ($p < 0.05$). Of the reasons for using CAM methods, 71.8% were health problems, 50.1% were stress, and 44.4% were hair and facial care. Their main source of information about CAM methods is the internet, followed by family and then friends. Of the students, 13.3% had received training about CAM methods. Of those with such training, 64.6% used CAM methods, while 49.3% of the others used these methods ($p < 0.05$). The rate of recommending CAM methods to other people is 52.6%.

CONCLUSION: Nursing students have deficiencies of knowledge about this subject; however, more than half of the students still use CAM methods and recommend them to others.

Keywords: Nurse, complementary and alternative medicine students

P-1234

Quality of medical prescription of FOBT and colonoscopy as screening exam

Patrícia Rodrigues Cunha, Pedro Oliveira, Rosa Neves, Diana Brigas

Family Health Unit of Fiães, Santa Maria da Feira, Portugal

Introduction and objectives

Colorectal Cancer (CRCA) is one of the main oncological causes of morbidity and mortality in Portugal.

The existence of curative treatment and very high survival (>90%), when detected at an early stage, took the Portuguese General Directorate of Health (GDH) to create a standard on opportunistic screening of CRCA.

It's intended to assess and improve the quality regarding to the FOBT and colonoscopy prescription for CRCA screening.

Methods

The study comprised three methodological phases: initial assessment, intervention and reassessment. Dimension studied: technical and scientific quality; Unit of study: all individuals between 50 and 74 years old; Location: Family Health Unit (FHU) of Fiães; Exclusion criteria: all individuals with a personal or first-degree relative history of adenoma or CRCA, with diagnosis of inflammatory bowel disease and all patients who refused to undergo the exam; Sample Type: simple random sample of 206 patients; Evaluated criteria/indicators: FOBT prescription in the past year or normal colonoscopy during the previous 5 years; Type of evaluation: retrospective, internal and peers; Intervention: Educational and Informational.

Results

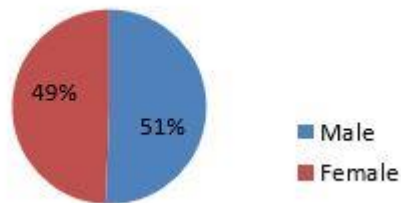
From the sample analyzed, 52% were women. The proportion of patients with FOBT and colonoscopy prescribed in the recommended timings was 55,3%. The most prescribed examination was FOBT (n=85), with 63% of prescriptions, representing the colonoscopy the remaining 37%. It can be concluded that there were shortcomings in compliance with the standard, being improved the quality standard, proven in the revaluation, after the educational intervention and informative.

Conclusion

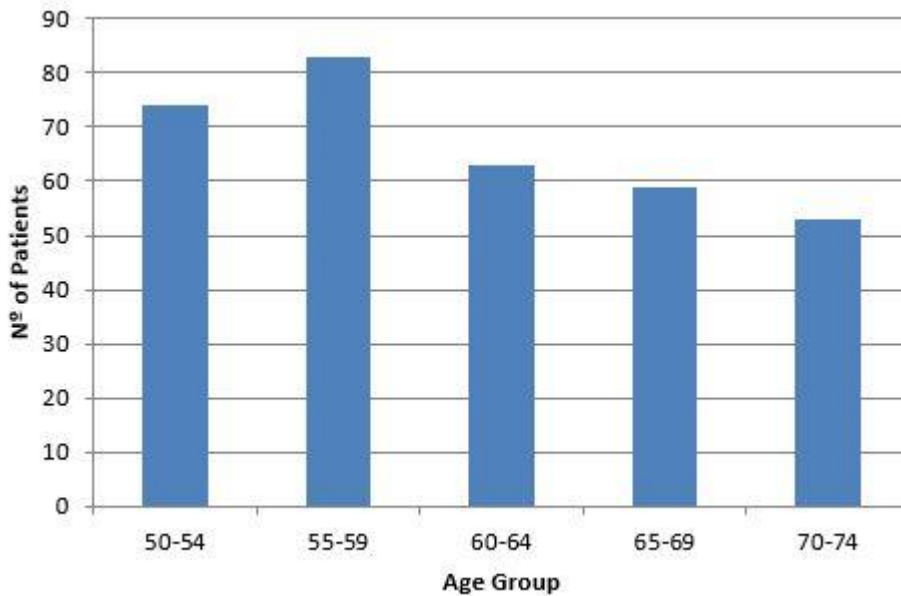
The existence of 14 non-regular patients and an indicator which assesses the FOBT prescription every two years, rather than annually as recommended by the GDH, can justify the results obtained initially. The proposed intervention was adequate because after reevaluation there was an improvement in the quality standard of prescription of these examinations.

Keywords: colorectal neoplasms, colonoscopy, fecal occult blood test

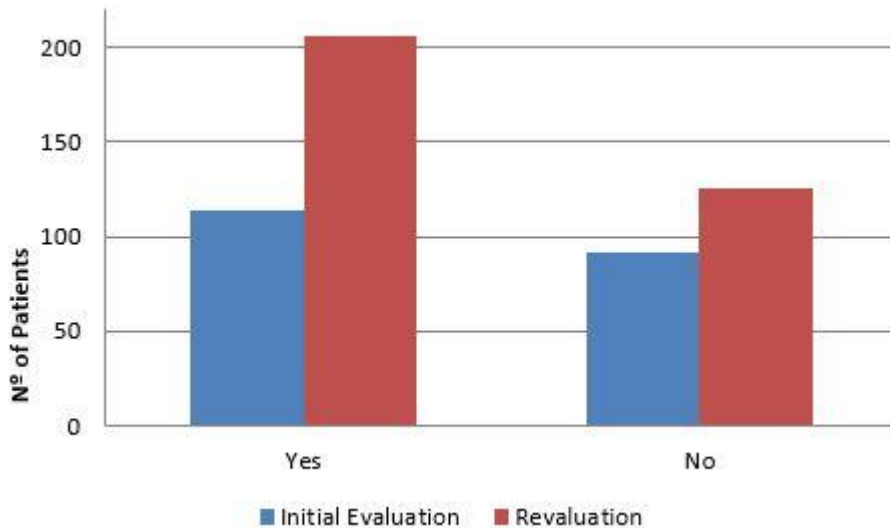
Sample Distribution by Gender



Sample Distribution by Age Group



FOBT & Colonoscopy Prescription in Proper Timings



P-1235

Use of hypertension diagnosis and treatment guidelines by family physicians working in primary care and obstacles of guideline use

Nur Gundogan Gunes, Vildan Mevsim

Department of Family Medicine, Dokuz Eylul University Faculty of Medicine, İzmir, Turkey

Background

We aimed to investigate use of hypertension diagnosis and treatment guidelines (HDTG) in primary care by family physicians who work in primary care and obstacles of guideline usage.

Method

The study is a cross-sectional analytical study performed with 382 physicians who work in family health centers that were selected by cluster sampling method in the province of Izmir metropolitan. Two scales were developed with Delphi technique in the first step of our research in order to identify the use of hypertension guidelines and obstacles to the use guidelines. In the second step the scale was performed to physicians.

Results

61.5% of the physicians were male and 38.5% were female. Physicians under the age of 40 ratio (14.7%) were lower ($p > 0.05$). Physicians with graduation year 20-year and higher were more common with ratio of 52.9% ($p > 0.05$). Physicians who worked in primary care shorter than 5 years were 6.5% in ratio, percentage of family physician specialists was 16% ($p > 0.05$). Assessment of physicians' scale of HDTG considered in three categories and found that 18.6% used at a good level, 78.0% used in moderate level and 3.4% didn't use. The mean score of HDTG of female physicians (15.16 ± 3.26) were higher compared with men (14.20 ± 3.14), ($p = 0.005$). When we assessed obstacles of using guidelines, highest mean score was 3.73 ± 0.85 which interfere with the working conditions.

Conclusions

Family physicians use hypertension diagnosis and treatment guidelines at the intermediate level in managing hypertension patients. Physicians remarked that working conditions are the most important obstacles of guideline usage. Necessary arrangements should be made for increasing physicians' compliance to hypertension diagnosis and treatment guidelines.

Keywords: Hypertension guideline, family physician, guideline use obstacles physician

Table 1. Sociodemographic characteristics of physicians

Demographic Properties		n	%
Gender	Female	147	38,5
	Male	235	61,5
Age Group	40 age and below	56	14,7
	41 - 45 ages	137	35,9
	46 - 50 ages	114	29,8
	50 age over	75	19,6
The year working as a physicians	10 year and below	13	3,4
	11-15 year	37	9,7
	16-20 year	130	34,0
	20 year over	202	52,9
Title	General practitioners	321	84,0
	Family physician specialist	61	16,0
Study year in primary care	5 year and below	25	6,5
	5-10 year	52	13,6
	10-15 year	57	14,9
	15-20 year	110	28,8
	20-25 year	66	17,3
	25 year over	72	18,8
Total		382	100,0

Table 2. Physicians guideline usage status (p < 0,05)

Guide use case	Number (n)	Rate (%)
Good level using	71	18,6
Medium-level using	298	78,0
No using	13	3,4
Total	382	100,0

P-1236

An Analysis On Social Support And Quality Of Life Perceived By The Mothers Of Children With Cancer Receiving Chemotherapy

Gülçinay Selamet¹, Seyhan Hıdıroğlu², Melda Karavuş³, Pınar Ay⁴, Nimet Emel Lülecı⁵

¹Gülçinay SELAMET, Family and Social Policy Ministry, Zeytinburnu Semiha Şakir Nursing Home, İstanbul, Turkey

²Seyhan HİDİROĞLU, Marmara University, The Department of Public Health, İstanbul, Turkey

³Melda KARAVUŞ, Marmara University, The Department of Public Health, İstanbul, Turkey

⁴Pınar AY, Marmara University, The Department of Public Health, İstanbul, Turkey

⁵Nimet Emel LÜLECİ, Marmara University, The Department of Public Health, İstanbul, Turkey

This descriptive research was carried out for the purpose of analyzing the social support and quality of life perceived by the mothers of children with cancer receiving chemotherapy. The sampling group of the research comprised the mothers of the children with cancer receiving treatment in the hematology-oncology service and polyclinic of Marmara University, Pendik Training and Research Hospital and in the outpatient chemotherapy centers. In order to measure the quality of life, The Quality of Life Scale (QOLS) of the family members taking care of a cancer patient was used, and to measure social support, The Multidimensional Scale of Perceived Social Support (MSPSS) was used. 99.18% of the mothers interviewed are married, whereas 31,8% of them are between the age range of 39-45 and 37.05% of them are primary school graduates. While the marital status of the mothers of children with cancer, their social security did not affect the quality of life, the scores of social support scale of the mothers who had no blood relation with their spouse, who were supposed to look after another patient, who were aged and had no younger kids were found to be significantly high. (p<0,05). Mothers who have children suffering from cancer spare all their time for their sick children and cannot get enough support in the course of the disease, which affect their quality of life in a negative way. In order to solve such problems, necessary educational and expert support should be provided for children with cancer and their mothers while also improving their living conditions.

Keywords: Cancer and Oncology, Children, Hematology, Motherhood, Quality of Life

P-1237

Comparison with European Primary Health Care Quality Assessment EPA's and Ministry of Health ASM Evaluation Form

Melahat Akdeniz¹, Ethem Kavukcu²

¹Department of Family Medicine, Akdeniz University, Antalya, Turkey

²Department of Sports Medicine, Akdeniz University, Antalya, Turkey

Background. Quality of the primary care practices is also important for both physicians and staff in primary care as well as patient satisfaction with the service they receive. The EPA tool was first tested in more than 270 practices in Europe. The aim of EPA is to have an impact on the quality improvement on the premises of the practice and in practice organisation. In Turkey, Primary health care services has been given in the Family Health Centers since 2010. ASMs are supervised by the Ministry of Health and a standard form that is used in the control. ASM evaluation forms compared with the EPA in this study.

MATERIALS-METHODS: Firstly permission of translation was received first translation because lack of translation Turkish of EPA; then was translated into Turkish by all the researchers separately. It was then agreed a joint text combining translation. Secondly, it were compares Ministry of Health's ASM evaluation forms with the EPA in terms of common areas and differences.

RESULTS: Physical and technical requirements are located in both forms. The evaluation forms of ASM describe the internal and external features of ASM, ASM building, medical equipment, essential medicines in detail. In the EPA, accessibility is further highlighted; building inside nesting features are less detailed. Availability of medical equipment, and essential drugs were highlighted, but not provided lists. ASM assessment form is questionable whether they are physicians and their staff to the task. The patients, physicians and staff's thoughts and feelings about institution and working conditions have a higher priority area In the EPA,

Conclusion. The goal of the EPA is to assure the standard and qualified health services in primary care alongside buildings and properties. To use the EPA can provide significant improvements; increase the quality of health care in our country.

Keywords: Quality, Primary care, EPA

P-1238

Impact of electronic prescriptions in the demand for care

Hector Leonardo Lugo Ramos, Rocio Lobato Martinez, Jose Maria Fernandez Gonzalez, Juan Jesus Rodriguez Vallejo

Hospital Jerez de la Frontera - Cadiz

OBJECTIVES:

To know how to influence the final implementation of the electronic prescription in Primary Care in demand for consulting assistance

MATERIAL-METHODS:

A descriptive cross-sectional observational study. Data collected from a sanitary zone digital system including the total number of patients treated at a health center differentiating by gender for the first six months of final implementation of electronic prescriptions compared with the same data are analyzed in the year above.

RESULTS:

Preliminary studies showed a decrease in the number of health demand something more than 14% difference remaining stable attendance rate of women (55 %) compared to male (45%).

CONCLUSIONS:

A digital system that allows almost unlimited prescription drugs to patients reduce demand clinic substantially a few months of use. However, there is clear frequency by the female gender. This situation allows the patient to go not only for their monthly prescription and gives opportunity to demand assistance to patients without chronic diseases.

Keywords: Electronic Prescribing, Primary Care, Drug Costs, Telemedicine, Comprehensive Health Care

P-1239

The Need of Developing TB-DM National Program for Diabetes and Tuberculosis Comorbidity: {Lesson Learnt from Experience of Faculty of Medicine Universitas Indonesia in West Java Province, Indonesia}

Della Puspita Sari¹, Irene Darmawan¹, Lorens Prasiddha¹, Trevino Aristakus Pakasi², Indah Suci Widyahening²

¹Faculty of Medicine Universitas Indonesia, Jakarta, Indonesia

²Department of Community Medicine, Faculty of Medicine Universitas Indonesia, Jakarta, Indonesia

Background

Developing countries are currently facing double burden of disease, the comorbidity of tuberculosis (TB) and diabetes mellitus (DM). The WHO and International Union against Tuberculosis and Lung Disease (IUATLD) managed to elaborate a collaborative framework with the World Diabetes Foundation to solve the issue. The meeting recommended an early detection and management of DM-TB. Since 2013, a guideline for primary health care (PHC) was prepared by the Faculty of Medicine Universitas Indonesia and implemented in Jakarta, Bogor, Ternate, Kupang and Manado, where the burden of diabetes were quite high. After a year of implementation, we did supervision in Bogor, West Java. The study aimed to describe lesson learnt of the guideline implementation in Bogor.

Method.

A system approach was applied in the supervision. We performed an in-depth interview to the program manager and other health personnel in the PHCs to describe how they diagnose and treat DM-TB, number of patients, and asking the usefulness of the guideline.

Results

From three samples of PHCs in Bogor, case finding of TB-DM was 14 out of 111 registered TB patients. Two issues hindered the application of the TB-DM guideline. The first was limited resources and facilities. The second was the absence of target coverage as the PHC expected. In the patient care aspects, the guideline to screen DM among TB patients was well adapted and useful but not for TB screening among DM patients. It was rather difficult because limited resources and facilities. In the interview, health personnel suggested to make as a national program, with certain targets. Otherwise, there was no enforcement to implement the guideline.

Conclusion

The guideline was quite useful for the PHC, but need more enforcement in the implementation, i.e. becoming a national program. This was also recommended by the WHO-IUATLD-WDF meeting, in order to optimize the program achievements.

Keywords: DM-TB, guideline, national program

P-1240

Analysis of satisfaction in maintaining of the implantable venous acces system in the primary healthcare centre of manlleu

Alicia María Díaz, Gloria Padullers, Sara Belmont, Silvia Altimiras, Meritxell Cassasas

The Primary Healthcare Centre, Catalan Institute of Health, Manlleu, Vic, Barcelona

BAKGROUND

The Primary Healthcare Centre (PHC) of Manlleu, since November 2011, is doing the control and maintenance of the Implantable Venous Access System (known as Port-A-Cath® reservoir), to patients who have stopped making active treatment with chemotherapy.

Our concern is how patients live this new way to perform the procedure that was previously done in the hospital.

AIM

- Evaluate patient satisfaction with the procedure carried out by the PHC.
- Analyze the possible improvements in the development of the procedure.

METHOD

Telephone survey to all patients with the system (Port-A-Cath reservoir), about satisfaction on the procedure conducted in PHC.

RESULTS

- 5 of the 23 interviewed did not answer. 74% were women and 26% men.
- The most common malignancy is breast cancer (43%), followed by colon cancer (21%).
- The average age is 55 years.
- Be pensioner was the most frequent employment situation (61%).
- The average time of attention in the PHC has been 19 months.
- None of the patients presented any problems caused by the reservoir which needed its referral to the hospital.
- In terms of accessibility (flexitime) and the improvement in the economic expense 94% of respondents listed as excellent. 100% as excellent in facility in traveling and the reconciliation of work and family schedules.

CONCLUSIONS

From the 18 patients who responded the survey, 100% are satisfied that the procedure is carried out in their PHC. The monitoring of Port-A-Cath in PHC has proven to be effective and safe.

Keywords: Port-A-Cath, Primary Healthcare Centre, Oncology treatment

implantable venous acces system



P-1241

Study about the use of benzodiazepines

Ángel Hurtado De Mendoza Medina¹, Carmen María Jiménez Herrera², Ruth Muñoz Maya³, Elvira García Martín⁴

¹CS Don Paulino García Donas, Alcalá de Guadaíra. AGS Sevilla-Sur, Andalussia, Spain

²CS Nuestra Señora de la Oliva, Alcalá de Guadaíra. AGS Sevilla-Sur, Andalussia, Spain

³CS Don Paulino García Donas, Alcalá de Guadaíra. AGS Sevilla-Sur, Andalussia, Spain.

⁴CS Virgen de Consolación, UGC Utrera Sur, Utrera. AGS Sevilla-Sur, Andalussia, Spain

Background and Aim: Analysis of the clinical profile of patients taking benzodiazepines in a Family Medicine Clinic in southern Europe and whether such benzodiazepine (BZD) prescription is suitable according to the diagnosis and type of benzodiazepine in terms of half-life.

Method: Study on the prevalence of benzodiazepine prescription. Retrospective, descriptive. Adults (>18) with BZD prescription at the time of the study (January 2015) in a family medicine consultation (1345 people). We scanned the prescriptions made at the time of the study, patient data (age, gender, prescription data, duration, diagnosis, type of benzodiazepine).

Results: Of these 1345 patients, 219 (16.28%) had been prescribed benzodiazepines as recorded in their digital history at the time of the study.

BZD consumer profile was: female (68.2%), of which 28.7% were in an age range between 53 and 69 years-old. In most cases (40.05%) there was not an established diagnosis. The main diagnoses found were: anxiety-depressive disorder (39.2%) and musculoskeletal disorders (12.3%).

In the group of women the main diagnosis was anxiety-depressive disorder while in men musculoskeletal pathology was more prevalent.

A diagnosis analysis by age showed that population under 40 years-old presented mainly mechanical pathology while insomnia was common in people over 65 years-old

Types of prescribed benzodiazepines: Short half-life (6.7%), Intermediate Half-life (58.2%), Long Half-life (35.1%)

Conclusions: Women are the population were benzodiazepines are most prescribed, in a context of anxiety-depressive syndrome as main diagnosis.

There are a lot of fragile patients being treated with benzodiazepines. In these patients, we should watch over BZD because they would be contraindicated.

There is a great scope for improvement in the use of this drugs, since a large percentage of patients use them without a definite diagnosis.

Keywords: Benzodiazepines, Drug prescription, Prescription Drug misuse

P-1242

Evaluation of electronic prescribing after one year use

Arzu Uzuner¹, Pemra Ünalın¹, Ezgi Yiğit², Nurullah Yazlı², Şeyda Aslan², Halis Uğur², Tuğba Çetin², Gülşah Yiğit¹

¹Department of Family Medicine, Marmara University medical School, İstanbul, Turkey

²Marmara University medical School, İstanbul, Turkey

INTRODUCTION: Electronic prescribing is a recent application in Turkish health system to prescribe the medications. With this applicaiton mostly encountered writing errors, fake prescriptions and wrong medication use are expected to be avoided, reimbursements to be timely and easier.

AIM: The aim of this study was to investigate the e-prescription by a broad perspective.

METHOD: This is a qualitative study. Physicians and pharmacists were interviewed by semi structured in dept interviews; patients by focus groups. On purpose sampling which enabled detailed investigation based on the different age, education level, working conditions for the patients; sex, age, specialty, working place for the doctors and the location of the pharmacy and the experience for the pharmacists. All the interviews were thematically analysed depending on the transcript of the audio tape records.

RESULTS: There is a general satisfaction within the groups. Still some of the patients are not aware of the system. There are some faults by entering the passwords into the system or some technical difficulties in the systme. Print out is not usually given to the patient. The advantages are easy access to the medications, leass bureaucratic procedure, economization of paper consumption. The effects of generic medication use on the e-prescription.

CONCLUSION: Technical interventions can solve the dissatisfying system based disadvantages. A shared electronic system can be created so that the prescription entries could be seen by the hospitals all over the country.

Keywords: electronic, prescription, physician, pharmacist

Table 2. Characteristics of the Participants and Themes

Table.2 Characteristics of the participants AND		Themes issued from the interviews with physicians and pharmacists and pharmacy workers
Physicians	N	
Gender		1. Benefits of the e-prescription Code 1: easy to write technically Code 2: easy to remember some medications <i>"easy to use. Once enter the initial letter then flow the medications immediately, that is why its use is easy and practical, easier then writing for us." (gen.surgeon)</i> Code 3: easy to correct <i>"...when a pharmacist call by phone we can do a correction practically"(family physician,fp)</i> Code 4: easy to read, less scribing error <i>"You do not make any error, no more.."(fp)</i> <i>"...it provided great facility to read,especially for the dosages (milligram, microgram)."</i> (male pharmacist) Code 5: time saving <i>"I can dialogue more with the patient, I can listen more to the patient; the patient thinks so, because instead of looking to the paper I look to the patient's face."(fp)</i> <i>"...and, enabled the work to be done quickly. We only call the prescription, otherwise we had enter the whole prescription by hand. It provided speed and made the system work appropriately." male pharmacist.</i> <i>"No need to make any procedure after the prescription. We do not work though the midnight as before..."(female pharmacist)</i> Code 6: use of template prescriptions <i>"Templates facilitates our job but have some side effects: this time uniform prescriptions occur. ... it means group of medications and there is ready prescription in the system.(resident in pediatrics)</i> Code 7: paper saving 2. Negative aspects of the e-prescription Code1: no print out, no document. Patient can not see the prescribed medication. <i>"It can be written false, we can not notice it. And we have to go to the hospital to correct it... can be a mistake in the password, in the prescribed medication ...it is not ready as a system. (patient)</i>
Female	10	
Male	10	
Work place		
University hospital	12	
Family Health Center	8	
Job		
Resident	7	
Practitioner Family Physician	6	
Specialist Family Physician	4	
Academician	3	
Branch		
Family medicine	11	
Surgery	6	
Internalist	3	
Total	20	
Pharmacists and pharmacy workers		
Localization of the pharmacy		
Busy	5	
isolated	1	
Gender		
Female	8	
Male	5	
Education		
Primary school	1	
High school and over	12	
Total	13	
Patients		
Gender		
Female	9	
Male	9	
Education		
illiterate	1	
Primary school	7	
High school and over	10	
Total	18	

Table 1.The main questions asked during the interviews

For the patients

1. What do you think about the application of e-prescription
2. Do you have any modification proposal?

For the physician

1. How do you proceed e-prescription?
2. Did the e-prescription provide you facility? If yes in which aspects?

For the pharmacists and pharmacy workers

1. How do you proceed e-prescription?
2. Did e-prescription provide you facility? If yes in which aspects?

P-1243

Evaluating The Quality Of Clinical Practice Guidelines

Aylin Baydar¹, Meltem Koç², Rabia Kahveci³, Duygu Ayhan Başer⁴

¹ankara atatürk training and research hospital,ankara,turkey

²mamak public health center,ankara,turkey

³ankara numune training and research hospital,ankara,turkey

⁴kocaeli public health directorate,kocaeli,turkey

Clinical practice guidelines (CPGs) are one of many tools that can be used to improve the quality of care provided by health professionals, especially when they are designed to support appropriate or necessary behavior change. Recently, clinical practice guidelines have become increasingly popular all over the world. The number of the national and international organizations that have been laboring about guidelines has been rising.

The aim of this study is to determine how to assess the quality of clinical practice guideline and approach the examples of the different countries.

Clinical practice guidelines are developed by different governmental and non-governmental institutions and international guideline networks all over the world. Due to wide variations in quality of clinical practice guidelines, many tools were developed to separate the high and low quality guidelines from each others. Recent studies emphasize that the most appropriate choice is to use AGREE II or DELBI instrument to make an comprehensive guideline evaluation. In Turkey there are few studies about the assessment of the clinical practice guidelines, developed by ministry of Health and non governmental institutions. With this study these experiences will be shared with the family physicians and also its strenghts and weaknesses will be discussed.

Keywords: Clinical practice guideline, Quality, Practice guidelines

Figure 1

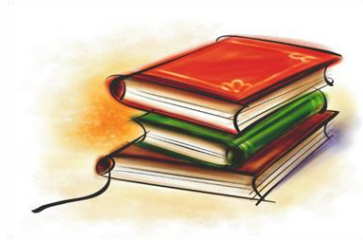


Figure 2



P-1244

Jack3D: May Be A Cause of Persistent Atrial Fibrillation?

Özden Gökdemir¹, Hüseyin Dursun², İnce Tuğçe Çöllüoğlu², Ayşegül Karaman³, Dayimi Kaya²

¹DOKUZ EYLÜL ÜNİVERSİTESİ TIP FAKÜLTESİ AİLE HEKİMLİĞİ ANA BİLİM DALI-İZMİR

²DOKUZ EYLÜL ÜNİVERSİTESİ TIP FAKÜLTESİ KARDİYOLOJİ ANA BİLİM DALI-İZMİR

³DOKUZ EYLÜL ÜNİVERSİTESİ TIP FAKÜLTESİ İÇ HASTALIKLARI ANA BİLİM DALI-İZMİR

Multicomponent dietary bodybuilding supplements comprise as herbal preparations to the public. It's herbal origin is emphasized while told that has no adverse effect as promotion. One of these product is Jack3D which consists of arginine alpha-ketoglutarate, creatine monohydrate, beta alanine, caffeine, 13-Dimethylamylamine HCl, Schizandrol A, Citric Acid, Silicon Dioxide, Acesulfame Potassium, etc.

Atrial fibrillation (AF) in young patients without structural heart disease is rare. Therefore, when the arrhythmia is present in this population, reversible causes must be identified and resolved. Hypertension, Coronary Artery Disease, Heart Valve Diseases, chronic lung disease, heart failure, cardiomyopathy, congenital heart disease, pulmonary emboly are the most common reasons of the atrial fibrillation and less common causes are thyroid disorders, pericarditis. Less common reasons of AF, are of illicit drug-stimulant use, acute alcohol intoxication, overuse of caffeine, electrolyte imbalance, metabolic disorders, infections or genetic factors.

This case is also remarkable because it's the first case in literature which reports a young man who developed persistent AF depends on the use of Jack3D.

A 22 year-old man came to the emergency department complaining of palpitations and dyspnea of abrupt and recent onset (>2 hours). There was nothing significant in his medical history. His blood pressure was 130/80 mmHg, pulse was 126/min and arrhythmic, respiratory rate was 18/min. Tachyarrhythmia was detected in his physical examination. 130 beats/min AF speed was observed in electrocardiography. No structural cardiac pathology was detected by the transthoracic echocardiography. Amiodorone infusion was applied and continued for 24 hours period. He converted to normal sinus rhythm. On direct questioning about herbal products and dietary supplements, he revealed that he took Jak3D which was a bodybuilding supplement.

Multicomponent dietary bodybuilding supplements are mostly used to increase muscle mass. Many researchers reported that to use compound of creatinine and arginine-alpha-ketoglutarate is effective to increase the muscle endurance, repeated Wingate tests are also evidence of the improvement in muscle power. However, fatal side effects in young adults, in particular cardiovascular side effects should not be underestimated.

Keywords: atrial fibrillation, bodybuilding supplements, muscle mass, cardiotoxicity

P-1245

Acne: Does youth assess as an illness?

Ilyas Erken¹, Ülkü Yıldız³, Melike Çağaydın¹, Gizem Limnili², Nilgün Özçakar¹

¹Department of Family Medicine, Dokuz Eylul University, Izmir, Turkey

²Medical Center, Dokuz Eylul University, Izmir, Turkey

³Çukurca Hospital, Hakkari, Turkey

Background and AIM: Acne vulgaris, a chronic disorder of the pilosebaceous units, is common in adolescents. Acne is also the most common skin disease in adults. The early detection and appropriate treatment of acne is essential in the prevention of severe acne and scarring, and the consequent adverse psychosocial disabilities resulting from feelings of embarrassment, frustration and poor self-esteem. Emotional issues in young individuals with acne must be identified appropriately.

METHOD: This was a cross-sectional survey involving students who applied to Dokuz Eylul University Medical Center with any reason of health. They were administered a questionnaire gathering their socio-demographical data, presence of acne, prior or current treatment, general knowledge about causes of acne, questions regarding the quality of life and Rosenberg Self-Esteem Scale's first ten questions. SPSS 15.0 program was used for statistical analysis and p<0.05 was accepted as statistical significant.

RESULTS: Two hundred and forty seven students were included and 63.7% were women. Mean age was

21.40±2.38. Majority of the students (99.3%) had acne but 41.3% of acne problems had lasted before three months. Acne was defined as an illness by 53.4% of the students and 38.1% visited a doctor for acne treatment. Relationship between suffering from acne for longer than three months and Rosenberg Self-Esteem Scale scores were not statistically significant ($p>0.05$).

CONCLUSION: Despite the high prevalence of acne, there is still much deficiency of knowledge and wrong beliefs about acne. This indicates that there is an urgent need for education about etiopathogenesis, potential complications and importance of effective treatment for acne.

Keywords: Acne, University students, Rosenberg Self-Esteem Scale

Table 1. Questions asked to students

	N(%)
Do you still have acne?	
Yes	232 (93.9)
No	15 (6.1)
How long do/did you have/had acne?	
<3 months	102 (41.3)
3-6 months	28 (11.3)
7-12 months	26 (10.5)
>1 year	91 (3.9)
Do you think acne as an illness?	
Yes	132 (53.4)
No	115 (46.6)
Did you ever visited a doctor for acne?	
Yes	94 (38.1)
No	153 (61.9)

Table 2. Rosenberg self-esteem scores

Self esteem scores	N(%)
High	165 (66.8)
Middle	81 (32.8)
Low	1 (0.4)

Wafa Halasa

Emergency department, Al Bashir Hospital, Amman, Jordan

Background and AIM: Increasing demands on health services have resulted in a number of innovations in delivering care. In November 2005, a unique new care model was started in the Emergency Department of Al-Bashir Hospital, the largest government hospital in Amman, Jordan. Family medicine physicians (specialists and residents) started working and are still working in newly added clinics to the Emergency Department, providing 24-hour primary care services to non-urgent patients; 'inappropriate attenders', on a non-appointment basis, with the aim of decreasing the pressure on the overburdened Emergency Department. Aim of the study was to identify characteristics of patients attending Family Medicine Walk-in-Clinics.

METHODS: Reviewing the emergency department registration books from April 18 till May 17 2010. A total of 10000 patients were identified, according to age, sex, main complaint and time of attendance.

RESULTS: Total number of patients 10000. Males - 5333 (53.33%), females - 4667(46.67%). Male to female ratio was 1.14:1. 1 to 5 years - 2852 (28.52%). 1 to 30 years - 7329 (73.29%). Main presenting complaint was respiratory tract problems in 4090(40.9%) patients, of which upper respiratory tract infection constitute 2776 (27.76%), followed by gastrointestinal tract problems in 2937 (29.37%), of which acute simple gastro- enteritis constitute 1782 (17.82%), renal problems - 549 (5.49%), back ache - 401(4.01%), cardiac problems-381 (3.81%) and skin problems - 361 (3.61%). 434 (4.34%) requested sick leave. Shift B (17:00 - 23:00) was the busiest - 4301 (43.01%) patients. 831 (8.31%) patients were referred to on call teams.

CONCLUSION: Children and young adults with upper respiratory tract infections were the main attendees. Main patient attendance and workload was in shift B. Providing primary care services in the emergency department offer safe effective and popular services.

Keywords: Family Medicine, Emergency department

The Hashemite Kingdom of Jordan

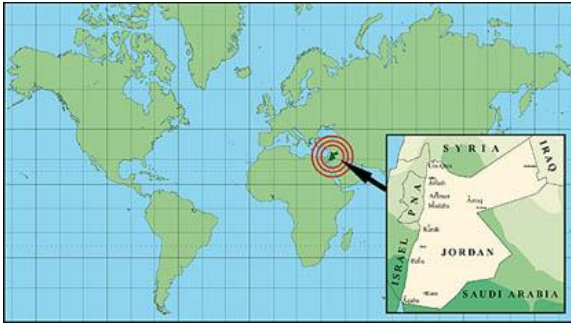


Number of Patients according to AGE

Age (Year)	Male	Female	Total	%
1-5	1596	1256	2852	28.52%
> 5 - 10	507	451	958	9.58%
> 10 - 20	809	716	1525	15.25%
> 20 - 30	1089	905	1994	19.94%
> 30 - 40	693	581	1274	12.74%
> 40 - 50	362	426	788	7.88%
> 50 - 60	140	193	333	3.33%
> 60	137	139	276	2.76%
Total	5333	4667	10000	100%

Less than 1 year referred to pediatric emergency

Jordan Location Map



Summation of number of Patients according to Age

Age in years	Total	Percentage
1 - 5	2852	28.52%
1 - 10	3810	38.10%
1 - 20	5335	53.35%
1 - 30	7329	73.29%
1 - 40	8603	86.03%
1 - 50	9391	93.91%
1 - 60	9724	97.24%
1 - > 60	10000	100%

JORDAN



Jordan has a total land territorial area of 89,300 square kilometers. Jordan's population is 6.1 million (2010)

Number of Patients according to Presenting Complaint

Presenting Complaint	Male	Female	Total	%
1 URTI	1585	1191	2776	27.76%
2 Acute G/E	921	861	1782	17.82%
3 Abdominal pain	369	431	800	8.00%
4 Wheezy chest	360	307	667	6.67%
5 Sick leave	301	133	434	4.34%
6 UTI	157	255	412	4.12%
7 Backache	278	123	401	4.01%
8 Cardiac pain	214	167	381	3.81%

9	Skin problems	169	192	361	3.61%
10	S.O.B	176	160	336	3.36%
11	Dizziness	137	196	333	3.33%
12	Chest infection	167	144	311	3.11%
13	Headache	124	146	270	2.70%
14	Epigastric pain	108	133	241	2.41%
15	Joint pain	125	86	211	2.11%
16	Renal colic	74	63	137	1.37%
17	Legal report	131	1	132	1.32%
18	Ear pain	63	59	122	1.22%
19	Rt Iliac fossa pain	66	48	114	1.14%
20	High blood pressure	43	51	94	0.94%
21	High blood sugar	21	26	47	0.47%
22	+ve meningeal signs	16	13	29	0.29%
23	Croup	24	11	35	0.35%
24	Febrile convulsion	5	3	8	0.08%

Amman



Amman is the capital city

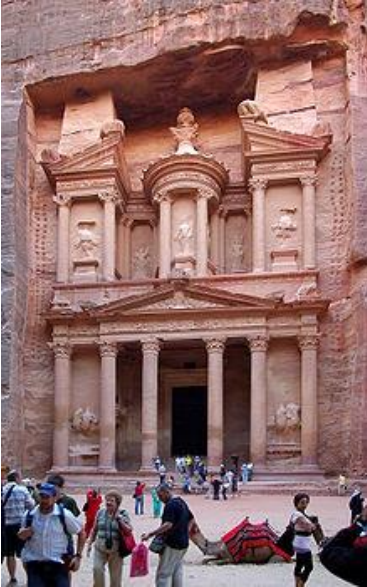
Number of Patients attending each Shift

	Shift A	Shift B	Shift C	Total
Number of patients	3320	4301	2379	10000
%	33.20%	43.01%	23.79%	100%

Dead Sea

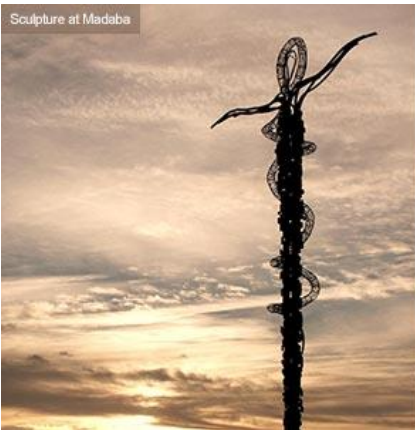


Petra



Petra is one of the New Seven Wonders of the World

Madaba



P-1247

“Correlation authorized by sanitary inspection with increased spending on primary care”

Alfonso Piñana Lopez, Rafael Luquin Martinez, Concepción Alonso Garcia, Jose Miguel Bueno Ortiz, Jesus Fernandez Lorencio, Jose Eduardo Caballero Martinez, Susana Martinez Gonzalez, Maria Lucia Garcia Guerrero, Beatriz Guerrero Diaz, Jose Lopez Gonzalez

Health Center Virgen de la Caridad, Area 2Cartagena, Murcia Health Service, Spain

“Background & Aim

the adequacy of the budget in pharmacy diversion between health centers in the same area of health leads us to find a way to adapt the diversion of the budget in pharmacy with the characteristics of the general population

Method

We determine the percentage of budgetary slippage of each general practitioner health center more diversion health area of 2014 to map each family doctor visadas total number of prescriptions or authorized inspection

Results

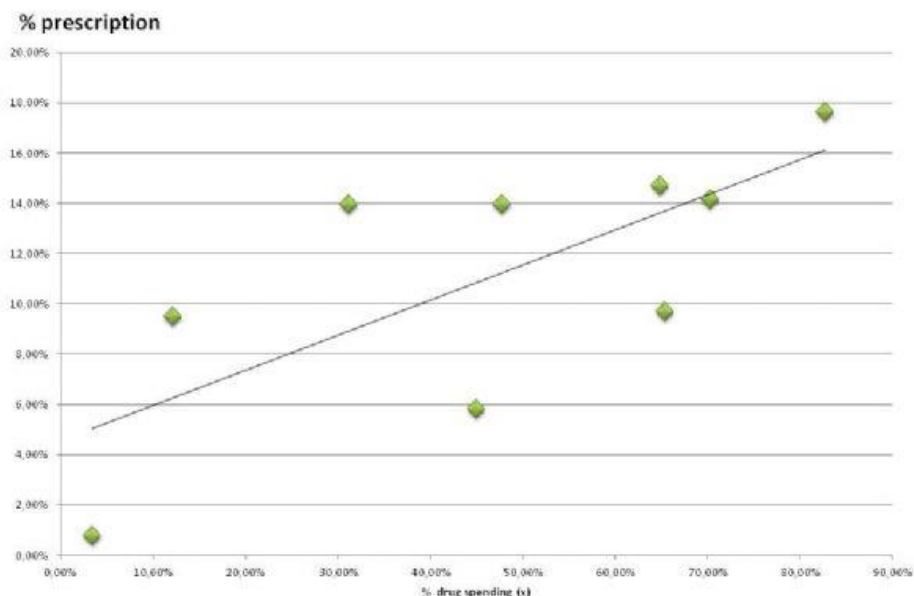
The% of prescriptions authorized by the sanitary survey ranged from 0.8% to 17.6% and% deviation pharmaceutical expenditure by general practitioner health center ranged from 3.44% to 82.74% of the budget. Getting a correlation coefficient of 71.9%

Conclusions

The correlation indicates that the greater the number of authorized inspection recipes will find greater diversion of budget so we conclude that while health centers in the area are homogeneous in age groups, the health status of patients differ yes. It would also be desirable generalization of an index of approved recipes for inspection as a compensatory mechanism to own budgetary slippage”

Keywords: prescription drug spending

wonca2015.prescription



The correlation indicates that the greater the number of authorized inspection recipes will find greater diversion of budget so we conclude that while health centers in the area are homogeneous in age groups

P-1248

Look or See

Özden GÖKDEMİR¹, Hilal Heybeli², Şevki Çetinkalp², Mehtap Kartal¹, Lütfiye Füsün Saygılı²

¹DOKUZ EYLÜL ÜNİVERSİTESİ TIP FAKÜLTESİ AİLE HEKİMLİĞİ ANA BİLİM DALI-İZMİR

²EGE ÜNİVERSİTESİ TIP FAKÜLTESİ DAHİLİYE ANA BİLİM DALI ENDOKRİNOLOJİ BÖLÜMÜ-İZMİR

AIM: Adolescence is an important developmental process that relates to many physical, emotional and behavioural problems due to structural, physical and also neuro-chemical changes of brain. Understanding this developmental process and recognition of any delay is important for the life of adolescents. This case presentation discusses the importance of periodic physical examination of General Practitioner/Family Physician.

CASE: 21-year-old male patient was admitted to emergency department of Ege University Faculty of Medicine because of seizure. He was conscious with blood glucose 440 mg/dL, urine ketone 150 mg/dL, and the pH value 7.1. His initial diagnosis was diabetic ketoacidosis due to unrecognized diabetes mellitus. Dexamethasone was started for its anti-oedema effect after he attended to emergency service. He was hospitalized for further investigations.

His complaints were dry hands, weakness, fatigue, weight loss, catarrhal purulent otitis in the right ear for a week ago, and he had polyuria and polydipsia for last month. His medical detailed history about seizures included brain tumour (anaplastic ependymoma grade 3) with chemotherapy and radiotherapy. He used antiepileptic treatment when followed up regularly until a year ago and he wasn't using his drugs for last year.

His testis couldn't be palpated and couldn't be visualized by scrotal ultrasonography. His flaccid and stretched penis size was <4 cm. His FSH-LH and prolactin values were high and total testosterone, DHEA-S were low. Chromosome analysis result was XX. His primary diagnosis was Klinefelter's Syndrome.

DISCUSSION: His denial of antiepileptic treatment for last year caused seizure, however his main problem was the physical differences that he found out himself. Unfortunately, he didn't have a complete physical examination that would give him the chance of early diagnosis, before adolescence. Till his situation became a life-threatening problem, it wasn't visible. The periodic physical examination shouldn't be ignored not to have the diagnosis by coincidence.

Keywords: Adolescence, Diabetic Ketoacidosis, Klinefelter Syndrome, Hypogonadism, Periodic health examination

P-1249

Self-rated health among peoples: a cross-national comparison

Aliye Mandiracioğlu¹, N. Emel Lüleci²

¹Ege University Faculty of Medicine Department of Public Health

²Marmara University Faculty of Medicine Department of Public Health

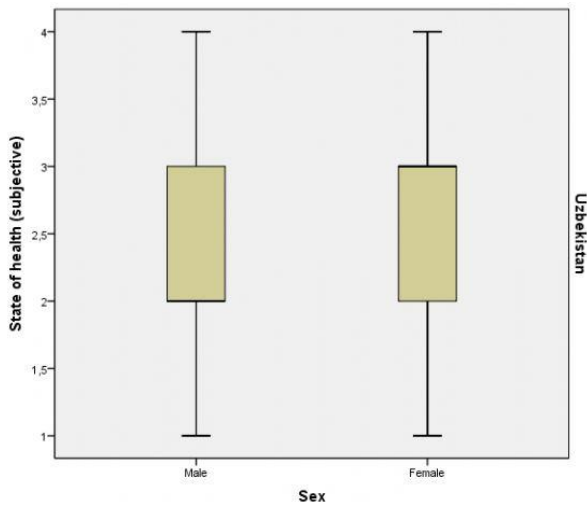
Background & AIM: Self-rated health (SRH) is used extensively in cross-national studies to evaluate a population's state of health, because it is simple and global. The aim of the study is to explore cross-cultural differences in self-rated health. METHOD: Data used in this study are from the sixth wave (2011–13) of the World Values Survey from Turkey (n:1500), Azerbaijan (n:7109), Kazakhstan (n:1002), Kyrgyzstan (n:1502), Uzbekistan (n:1605). SRH is measured using a 5-point response scale. The respondent's characteristics are included. RESULTS: In the four countries, more than 80% of the respondents have secondary or higher education, Turkey the rate is about 63%. People in Kazakhstan are most likely to report low income level. The prevalence of poor self-rated health is highest among participants from Kazakhstan (6.3%). The percentage of self evaluation "good" is 75.2.0% for Turkish people, and 56.4 % Uzbek. The percentage of positive self-evaluation in the Azerbaijan is 68.7%. SRH is worse among females in all countries. Married persons have significantly better health than did unmarried persons. There is poorer health among elderly persons. In all countries, people with elementary school or less have poor health compared to those with higher education. Lower income is significantly related to poor health in all countries. Conclusions This study results indicate that age, gender, income, and degree of education are relevant SRH in all countries. There are differences in SRH between countries. There are a lot of explanations for the differences in SRH across countries. Some of the explanations may be differences in cultural factors (such as life style, social structures) and economic inequalities.

Keywords: self rated health, World Values Survey, Turkic peoples

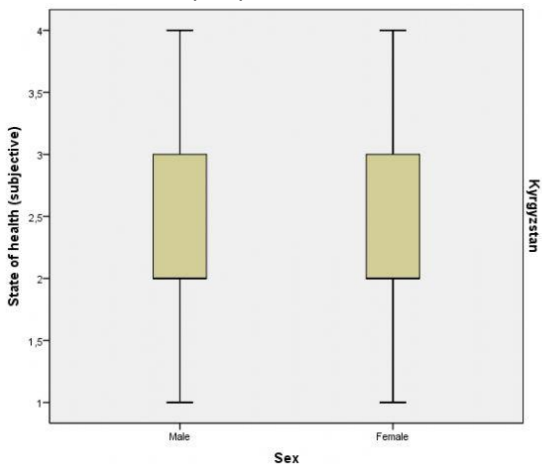
Map of the Turkic Republics



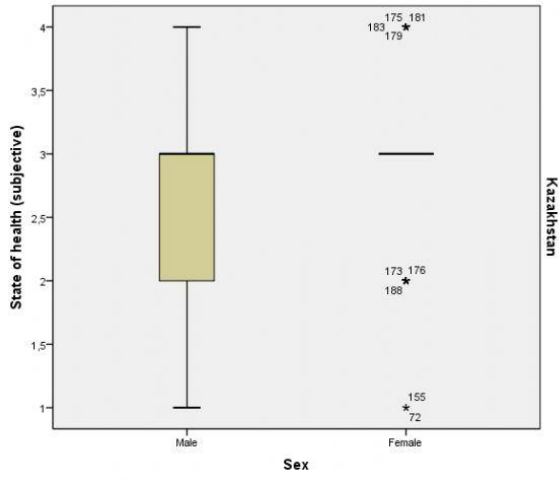
SRH of the older people



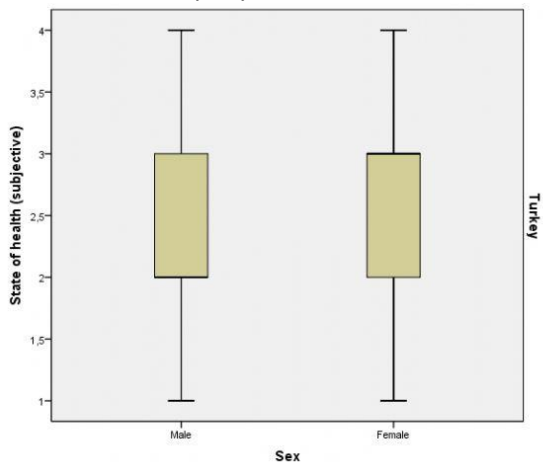
SRH of the older people



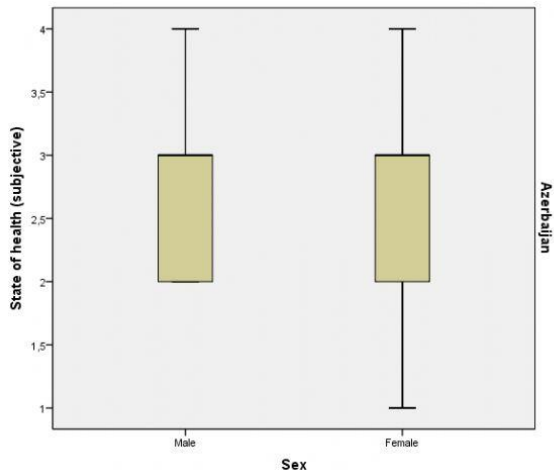
SRH of the older people



SRH of the older people



SRH of the older people



P-1250

Knowledge, Attitudes and Behaviors of Cigarette and Hookah Smokers About Hookah Smoking

Selen Soyuluol Gulec, Dilek Toprak

Family Medicine Outpatient Clinic, Şişli Hamidiye Etfal Research and Training Hospital, Istanbul, Turkey

AIM: In this study, we aimed to compare the effects of smoking hookah and cigarette to the level of carbon monoxide in the breath and also to evaluate the knowledge, attitudes and behaviors of individuals who smoke.

MATERIALS-METHOD: This study conducted between 25.02.2014-15.08.2014 in İstanbul hookah cafes and Şişli Hamidiye Etfal Research and Training Hospital Family Medicine Outpatient Clinic, among the individuals over 18 years who only smoke cigarette, only hookah and smoke both of them. Beside the sociodemographic informations, questions about knowledge, attitudes and behaviors were asked to these three groups with face to face method.

RESULTS: Totally 208 participants were included the study. Most of them were male (88.5%; n=184); married (71.6%;n=149) free-employed (%29,3;n=61) and graduated from university (49,5%; n=103). The mean age of the group was 29.16±10.80. Water pipes were smoked mostly in hookah cafes (96.6%;n=201) and the most common reason of this was "being together with friends" (%54.3; n=113). The most effective factor to start smoking waterpipe (%39.9;n=83) was "to enjoy". Hookah was smoked mostly ≤5 times/month (%43.8;n=91) and the average duration to smoke waterpipe was 7,42±6.08months. Flavored hookahs (94.2%;n=196), especially Apple flavored hookah (55.8%;n=110) were usually preferred. While 85.1% of the participants (n=177) thought waterpipe is harmful, 61.1% (n=127) of them thought hookah smoking is not addictive as cigarette. Equal number of people thought as hookah/cigarette smoking is more harmful to health (42,3%;n:88)

Participants (70,2%;n:146) didn't found warning signs on hookahs useful. Most participants thought adding fruit particles and/or aroma into the waterpipe; passing through water does not remove the harmful substances in it.

CONCLUSION: This study showed that smoking hookah increases breath CO level more than cigarette. Researches about Hookah use would help for further Projects and emphasise the importance of this health problem.

Keywords: Waterpipe, Cigarette, Smoking

P-1251

"{".Generalised woolly hair: Case report "}"

Beril Gümüş Demirel¹, Rafet Koca¹, Nilgün Solak Tekin¹, Ayşe Semra Demir Akca²

¹Department of Dermatology and Venereology, Bülent Ecevit University Faculty of Medicine,Zonguldak, Turkey

²Department of Family Medicine,Bülent Ecevit University Faculty of Medicine, Zonguldak, Turkey

Woolly hair is a rare congenital abnormality of the scalp hair characterized by kinkiness of the hair which is resembling negroid hair. Prevalance is unknown and it can be present at birth or appear in the first months of life.

Hutchinson et al. Classified wooly hair into three variants: a localized variant, woolly hair nevus and generalized variants. Generalized variant can be autosomal dominant hereditary woolly hair and autosomal recessive familial wooly hair. In dermatologic examination there is a marked reduction in the diameter of hair shafts which is usually poorly pigmented. Growth rate and the ratio of anagen/telogen are normal. Generalized woolly hair affects the entire scalp and can occur in isolation or in association with other cutaneous and extracutaneous abnormalities. It can occur in combination with Menkes disease, Naxos disease, Karvajal syndrome, Cardiofaciocutaneous syndrome and Noonan syndrome. Keratosis pilaris has been a well known association of woolly hair, and can also be a part of the Naxos or Carvajal syndromes.

We report the clinical case of a 14 year-old girl with generalized woolly hair. Marked keratosis pilaris was seen on the external side of arms. Cardiac evaluation did not show any abnormalities. There was a similar hair abnormalities history in her cousin. In physical examination there are no alteration or characteristics associated with other syndromes were found.

Keywords: Palmoplantar keratoderma; Hair diseases; woolly hair

woolly hair



P-1252

. Using greetings, thanks and words of courtesy in primary care online

Alfonso Piñana Lopez¹, Rafael Luquin Martinez¹, Nuria Luquin Ciuró², Concepción Alonso Garcia¹, Maria José Sanchez Sanchez¹, Jose Miguel Bueno Ortiz¹, Maria Dolores Rodriguez Santos¹, Encarna Ros Martinez¹, Jesús Fernandez Lorenzo¹, Jose Eduardo Caballero Martinez¹, Maria Lucía García Guerrero¹, Jose Antonio Piñana López³

¹Servicio Murciano de Salud

²Servicio Valenciano de Salud

³Universidad de Murcia

OBJECTIVES

Understand the use of written words to determine greetings, courtesy acknowledgments in primary care online. and attitudes, beliefs and experiences of adolescents and their mothers about nutrition.

PATIENTS AND METHODS

Qualitative methodology interpretive method. Where all the queries from a primary care physician received online at the health center of Cartagena West Murciano Service are analyzed. The criteria of linguistic heterogeneity is the presence of a welcome (Hello, good morning, good afternoon,), presence of words agradecimiento (thanks) and finally terminating words written some words of courtesy (greetings, Sincerely, etc.) With completion of calculating the percentage of their respective use.

RESULTS

Of total Internet e analyzed (93 mails internet) it follows that any greeting presentation appears, in 35.5% appears a word of thanks and 36.6% in 54.4% displayed some word courtesy. With these percentages say that it is common to find at least one or two words of greeting, gratitude and courtesy in the physician-patient communication over the Internet implying a deal by the user towards your next family doctor and cordiality toward.

Conclusions

The courteous treatment we can say that Internet communication has to be enhanced and desarrollada to its conclusion

Keywords: primary care, online, words, e-mail

P-1253

What?! Mesotherapy?

Catarina Ferreira Leite¹, Andreia Filipa Lopes Fernandes², Joana Silva Parente³, Raquel Cardoso Abreu⁴

¹Family Health Care Unit AmareSaude, Amares, Portugal

²Family Health Care Unit Alcaldes Faria, Barcelos, Portugal

³Family Health Care Unit São Lourenço, Braga, Portugal

⁴Family Health Care Unit Pro Saúde, Vila Verde

Background & Aim

Intradermotherapy known as mesotherapy, is a medical procedure introduced by Pistor in 1958 that consists in the application of intradermal injections of diluted pharmacological substances, at very low doses, between the epidermis and dermis as close as possible to the site to be treated, with a minimum undesirable effects and without involving other areas of the body. There are reports of the use of intradermotherapy to treat painful diseases (fibromyalgia, gout, headache, neuralgia, low back ache, sports injuries like sprains, strains, bursitis and tendinitis), skin diseases (alopecia) as well as unaesthetic conditions (colloid scars, wrinkles).

METHOD: Literature review of the clinical use of mesotherapy

RESULTS: Each session of mesotherapy involves superficial injections of medication using specialized short needles and specific techniques directly over the affected structures.

Medication mixtures used to inject in mesotherapy are commonly called "Mesotherapy Cocktails". The most common cocktails used in the therapies include local anesthetics, NSAIDs, decontracturants / muscle relaxants, corticoids, vasoactive drugs and phlebotonic drugs. The contraindications to mesotherapy include hypersensitivity to any component, body mass index greater than 30, pregnancy, lactation and less than 18 years of age. Side effects following mesotherapy are extremely rare in experienced hands and if they occur they are usually mild. Non-specific common adverse effects include nausea, vomiting, diarrhea, mild pain, skin hyperesthesia, edema, itching, erythema and tender subcutaneous nodules at injection site.

CONCLUSIONS: Despite the increasing number of studies, there are few indexed ones. Adequate methodological studies need to be conducted so that the true value of intradermotherapy with useful procedures can be applied in family medicine.

Keywords: Mesotherapy

Mesotherapy needles



P-1254

Longitudinal trends in the morbidity from musculoskeletal disorders and the consumption of the anti-inflammatory drugs in Croatia

Martina Menegony¹, Leonard Lamot², Gordana Prljević³

¹General Hospital Slavonski Brod, Croatia

²Health Center Krapinsko-zagorska County, Krapinske Toplice, Croatia

³Family Practice „Dr. Gordana Prljević“, Krapinske Toplice, Croatia

Background & aims

Musculoskeletal disorders (MSDs) are an increasing healthcare issue globally, being the high ranking cause of disability. Neck and low-back pain are the most common complaints seen in the primary health care (PHC), although the numbers of inflammatory conditions are increasing. There are several researches on MSDs in PHC, but limited in the scope and time. The aims of this study are to investigate trends in the morbidity of MSDs registered in Croatian PHC and the consumption of MSDs drugs.

Methods

From the Croatian Health Statistics Yearbook, 2005-2013, data related to the MSDs morbidity registered in PHC (ICD-X version) were obtained. Data on MSDs drugs (M01-M09) consumption expressed in DDD/TID and in Croatian currency, kunas, were taken from annual reports, 2005-2013, of Croatian Agency for Medicinal Products and Medical Devices in which the ATC classification index was used.

Results

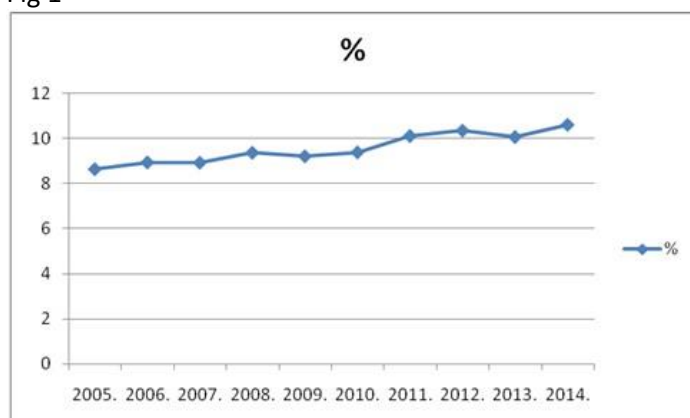
The number of diagnoses of MSDs recorded in PHC during the observed period increased from 798 358 recorded in 2005 to 1 437 931 in 2011, when it was the highest. While the number of kyphosis, scoliosis and lordosis decreased, the number of inflammatory MSDs increased in 240% and intervertebral disc disorders and other dorsopathies in 200%. At the same time, the consumption of MSDs drugs increased from 37.29 DDD/TID in 2005 to 57.84 in 2013 or from 148.455.470 Croatian kunas in 2005 to 208.434.476 in 2013, occupying in between 4th and 6th place in overall drug consumption. The higher increase was observed among the non-steroid anti-inflammatory drugs (M01), especially ibuprofen and diclofenac (increase in 220% and 180%).

Conclusions

The obtained results indicate that the MSDs registered in Croatian PHC are continuously increasing, followed by the increased trends in MSDs drugs consumption, especially ibuprofen and diclofenac consumption.

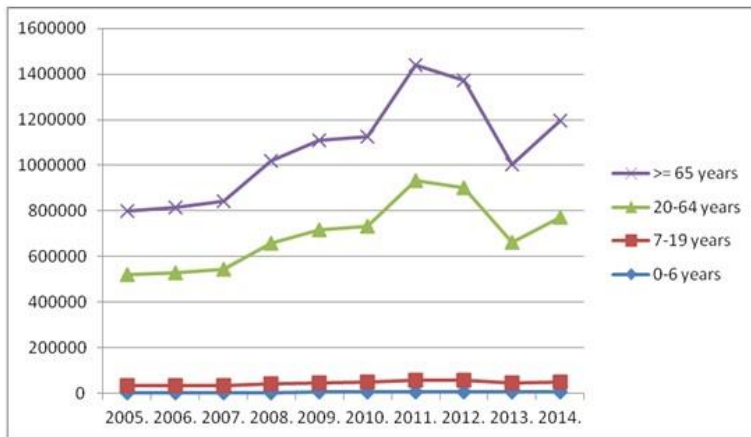
Keywords: musculoskeletal disorders, primary health care, anti-inflammatory drugs

Fig 1



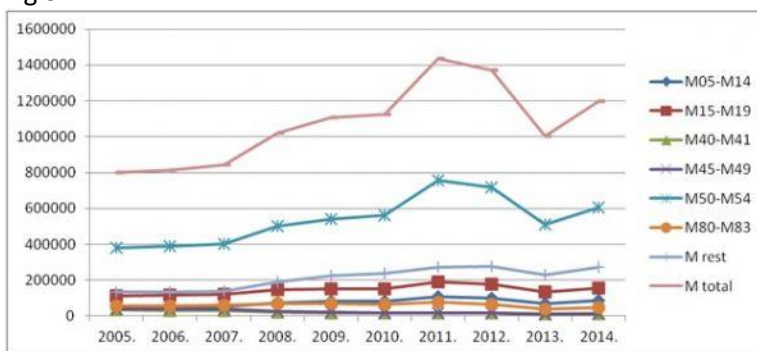
Percentage of the number of diagnoses of musculoskeletal disorders in total morbidity registered in Croatian primary health care, 2005 - 2014

Fig 2



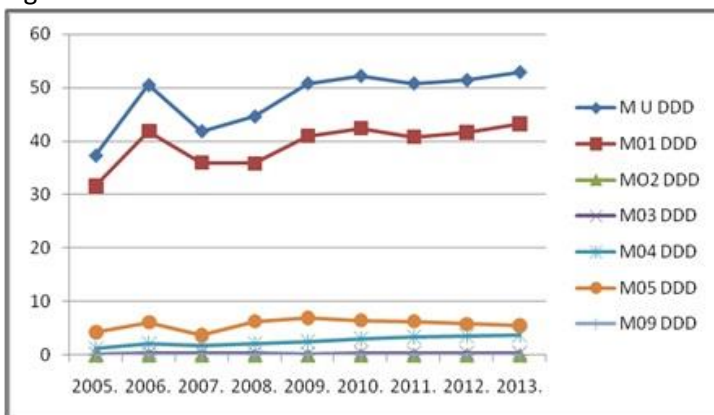
Number of diagnoses of musculoskeletal disorders registered in Croatian primary health care, in relations to the patient's age, 2005 - 2014

Fig 3



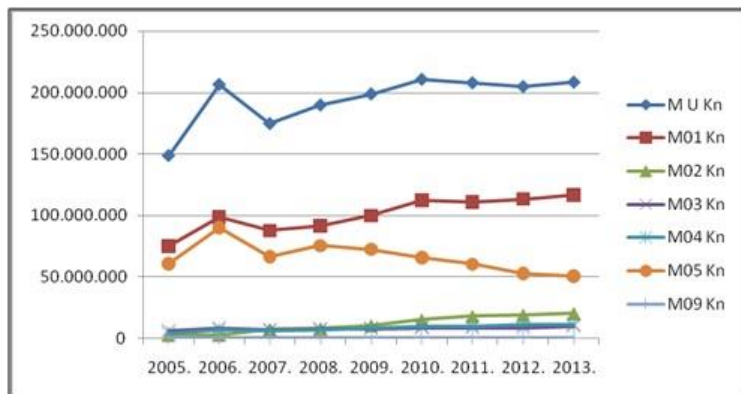
Morbidity trends of specific groups of musculoskeletal disorders registered in Croatian primary health care, 2005 - 2014 Legend: M05-M14 - rheumatoid arthritis and other inflammatory arthropaty; M15-M19 - osteoarthritis; M40-M41 - kyphosis, scoliosis and lordosis; M45-M49 - spondilosis; M50-M54 - diseases of inter-vertebral disc's; M80-M83 - osteoporosis; M rest - other musculoskeletal disorders; M total - total number

Fig 4



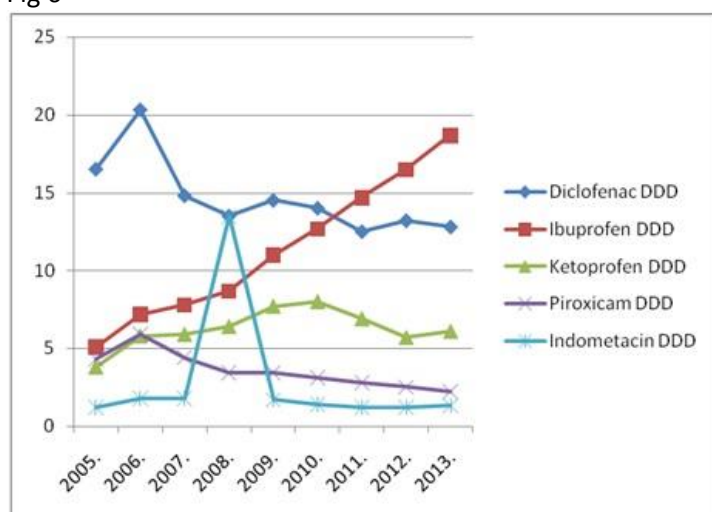
Consumption of the musculoskeletal drugs (ATC - M group) expressed in DDD/TID in Croatia, 2005 - 2014 Legend: M U - total; M01 - non-steroidal anti-inflammatory drugs; M02 - locally applied antireumatics; M03 - myorelaxants; M04 - drugs for the gout; M05 - drugs for the osteoporosis; M09 - others

Fig 5



Consumption of the musculoskeletal drugs (ATC - M group) expressed in Croatian currency (kn) in Croatia, 2005 - 2014 Legend: M U - total; M01 - non-steroidal anti-inflammatory drugs; M02 - locally applied antireumatics; M03 - myorelaxants; M04 - drugs for the gout; M05 - drugs for the osteoporosis; M09 - others

Fig 6



The five most utilised musculoskeletal drugs in Croatia, expressed in DDD/TID, 2005 - 2014

P-1255**Marmara University School of Medicine Basibuyuk Campus's Workers' Sleep Quality Anxiety Level and Related Factors**

Ayşe Gülsen Teker, Nimet Emel Lülecı, Seyhan Hıdıroğlu, Zülal Tarımtay, Türkan Cengiz, Muzaffer Ece Hakan, Ayşe Eren Yılmaz, Tuğba Altunkaya, Elif Uğur, Melda Karavuş

Department of Public Health, Marmara University Medical Faculty, Istanbul, Turkey

BACKGROUND and AIM: Sleep disorder is a disease that directly affects the health status but rarely questioned. Sleep disorders affect about 20-30% of the general population, although it is common to all over the world.

Generalized anxiety disorder is the most common psychiatric disorder seen in patients with sleep disorders. The aim of this study is to investigate Marmara University Medical Faculty (MUMF) Basibuyuk Campus's workers' sleep quality and anxiety level, to find the correlation between them and to determine other related factors.

METHOD: The sample of study collected from 130 MUMF Basibuyuk Campus's workers who agreed to attend in. Demographic information form, Beck Anxiety Inventory Scoring (BAIS) and Pittsburg Sleep Quality Index (PSOI) were applied to participant. The data was processed by SPSS 22.

RESULTS: The participants were 130 people, %68.5 female, %31.5 male. Mean age was 36.6 ± 10 . Participants' PSOI's mean: 5.61 ± 3.3 , BAIS mean: 8.6 ± 9 . According to our data sleep quality positively affected by high income, going to bed at the same hour, having good relationship with the family and social environment. Sleep quality was not affected by sex, age, chronic illness. The significant correlation was found between sleep quality and anxiety level ($r=0,48$ $p=0,01$). Anxiety level is negatively affected by female sex, having chronic illness, chronic medication, known sleep problem, drinking coffee, tea, eating meal before going to bed and having bad relationship with social environment.

CONCLUSION: This study showed that sleep quality and anxiety level were significantly correlated. Both of them are affected by income level, chronic medication and social relationship. However to find the possible triggers of the vicious cycle between sleep quality and anxiety level, more studies are required to be designed.

Keywords: sleep disorders, anxiety, pittsburgh sleep quality index

P-1256**Lemon Juice and Parsley, Union is Strength**

Polat Nerkiz

Department of family medicine, Gümüşsuyu Asker Hastanesi, İstanbul, Turkey

Background & AIM: Nowadays plants and herbal medicines are used widely as well as other treatment options to be protected from the diseases and for treatment of diseases. In health programs on TV many herbal mixtures are recommended. Mixture of lemon juice and parsley is one of the recommends increasing in popularity with the claim that the effect of healing the fatty liver and weight-loss.

Method and RESULTS: 47-year-old female patient, who got consulting from a wellness expert to lose weight, did not lose weight at a level to meet the expectations at the end of 3 months period. She admitted to our center because she was told that an underlying metabolic disturbance could cause this. In routine biochemical tests we found Thyroid stimulating hormone (TSH): 1.72 IU/L, fasting blood glucose: 92 mg/dL, Aspartate aminotransferase (AST): 46 IU/L, Alanine aminotransferase (ALT): 78 IU/L. Patient had no liver dysfunction or no known history of the disease will lead to disorder. In a detailed history, we determined that she did not use any drug but she drunk at least 6-7 glasses of mixture of lemon juice and parsley per day in order to contribute to weight loss. Patient was told to stop drinking this mixture. In tests after 3 weeks, we found AST: 24 IU/L and ALT: 26 IU/L.

CONCLUSIONS: Herbal medicines are widely used nowadays. However, the vast majority of physicians do not question enough the use of these products and patients do not mention about them if they were questioned especially because they do not accept them as drugs. We must pay attention to this subject while taking history.

Keywords: Lemon juice, parsley, liver function

P-1257

Can simple changes in family practice reduce polypharmacy in the elderly?

Laila Abdullah

Department of Primary care and Population Health, UCL

Background and Aim

Elderly people often take a variety of medications, yet some of these may no longer be needed or might interact with other drugs. Elderly people are at greater risk from adverse drug reactions and interactions which may lead to falls, drowsiness and cognitive impairment. Up to one in five hospital admissions in the elderly have been attributed to adverse drug reactions. We therefore need more stringent and focused medication reviews for frail elderly people. This study aimed to see whether simple changes in family practice could reduce polypharmacy in the elderly.

Method

The study is using a before and after design and is running from October 2014 to May 2015. One family practice in England searched its records to identify people aged over 75 on ten or more medications who had an unplanned admission in the past year. After certain exclusions, these patients were invited to a medication review and 20 out of 26 people attended (78%). Patients completed a baseline questionnaire about their medication and quality of life. Medications were reduced according to the no TEARS and STOPP protocols in a 20 minute review. 15 out of 20 people had one or more medications stopped (75%). Patient's 'named doctors' were informed of any changes.

Results

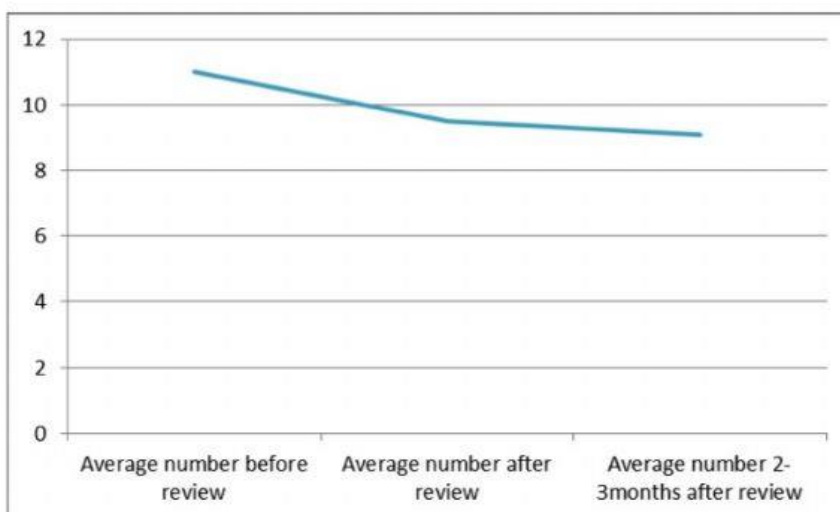
Follow-up data are currently being collected, including surveys with patients and doctors. The number of falls and hospital admissions three months after the review will be compared to the same time period one year earlier.

Conclusion

Results from this pilot study are beginning to suggest that family practice has a key role to play in reducing polypharmacy in the elderly. Family doctors are now taking part in an educational workshop, an alert is being set up on electronic records and annual 20 minute polypharmacy reviews for vulnerable people are planned.

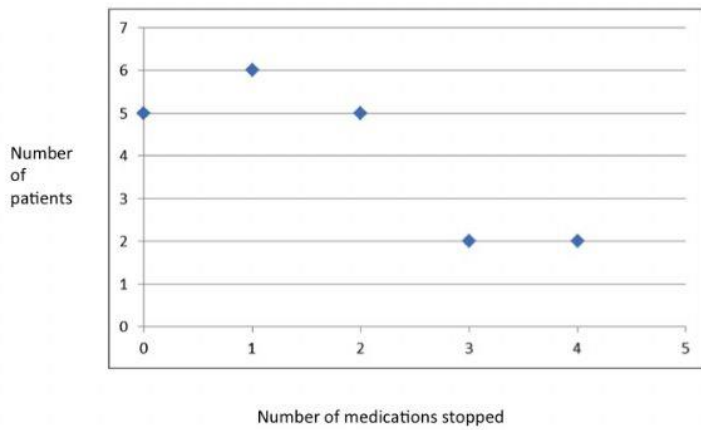
Keywords: polypharmacy, frail, elderly, medication, deprescribing, drug, interaction

Figure 1



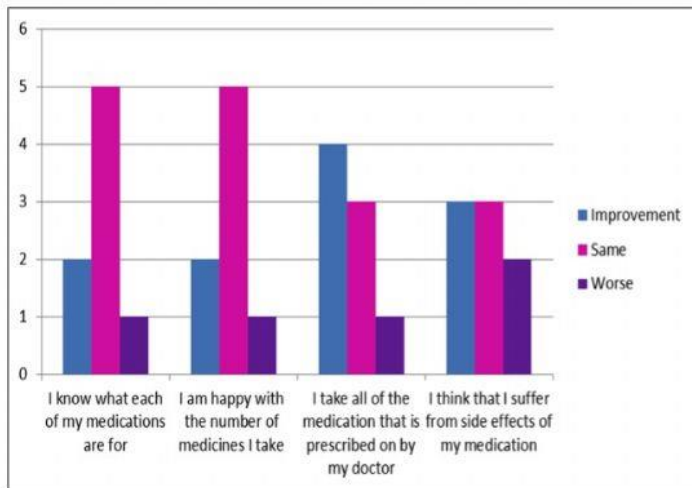
Average number of medications stopped per patient

Figure 2



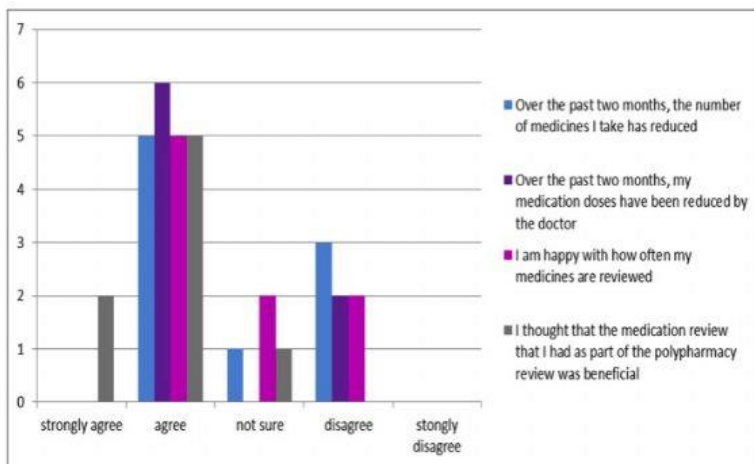
Number of patients with varying number of medications stopped

Figure 3



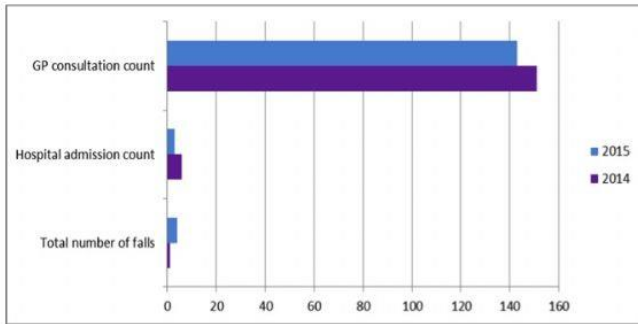
Comparison of pre and post intervention questionnaire results

Figure 4



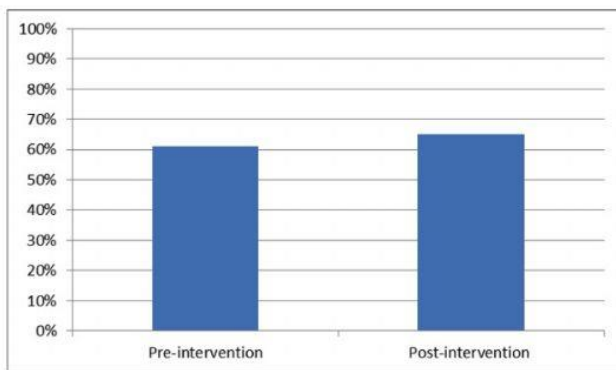
Post intervention questionnaire

Figure 5



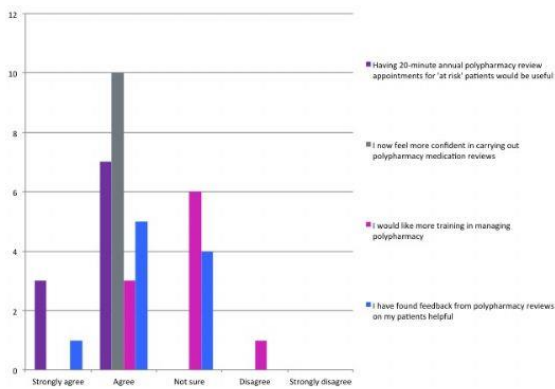
Comparing number of GP consultations, hospital admissions and falls

Figure 6



Comparing 'health status averages'

Figure 7



Doctors' questionnaire results

P-1258

Case Report: Approach To Tinea Incognito

Mehmet Ziya Gençer, Ezgi Kaçar, Gözde Nizamoglu, Reyhan Üstündağ, Seçil Arıca

Department of Family Medicine, Istanbul Province Beyoglu Association of Public Hospitals Okmeydanı Training And Research Hospital, Istanbul, Turkey

INTRODUCTION: Tinea incognito is a disease that gets the look of atipic form of mycotic infection, imitating many different dermatomes formed by misdiagnosing and giving improper topical, systemic steroids or immunosuppressive therapy. This form which named "Tinea incognito" or "steroid-modified tinea" may appear with different clinical forms after corticosteroid applications. In this case we demonstrate a patient who started topical corticosteroids application with misdiagnosis and after that insisting topical corticosteroids use on her treatment from doctors she see.

CASE: Forty-two-year-old female consulted to our clinic with severe itch, rash, redness that started at inguinal region and spreaded to belly region. Patients complaints is ongoing for 5 months and she first admitted to the pharmacy and given her klobetazolpropiyonat cream for itching. Later while she was out of town prescribed same medicine to a family doctor. Patient stated that given cream reduced itching and after stop using medicine itches increased and worsened. Patient related rise of complaints with "unfinishing "treatment. Patient has requested the re-prescription of the same medicine from our clinic "to be able to continue treatment". The patient has been informed and convinced to an examination. During examination erythematous papules and squamous plaques with unclear boundaries seen examination in the belly and around the inguinal region. From the anamnesis taken from the patient and clinical look disease thought as tinea incognita. Terbinafine 250mg/day, isoconazole cream (2 times a day) and terbinafine spray (2 times a day) started. In her supervision a week later lesions and complaints were seen reduced and totally disappeared in four weeks.

CONCLUSION: The history of tinea incognito case is fairly typical. As a result of using corticosteroids, immune system suppressed and at the beginning clinical signs depends on dermatophyte infection to become indistinct, rash disappeared but fungal infection gradually spread. Patients forced to use drugs repeatedly, and this becomes a vicious cycle. This clinic properties caused by steroids should be kept in mind by the family physician, also society should made aware of the drawbacks of using unscripted drugs.

Keywords: Tinea incognito, misuse of corticosteroid, mycotic infection

P-1259

Self-Regulation Skills in Cigarette Addiction: A Case Report

Evrım Kardelen Dizdar, Makbule Neslişah Tan, Vildan Mevsim

Department of Family Medicine, Dokuz Eylül University, İzmir, Turkey

INTRODUCTION: Self-regulation involves being able to set goals, monitoring one's behaviour to ensure that it is in line with those goals, and having the will power to persist until goals are reached. Self-regulation skill is not a personal ability and specific processes need to be fulfilled. In literature, there are few studies about self-regulation and dependence, and are generally about alcohol and drug dependency. The effect of self-regulation skills on the treatment of nicotine dependence remains unstudied.

CASE: A 55-year-old male patient who had been smoking for 40 years admitted to DEUTF Family Medicine smoking cessation clinic with the reasons; considering health, being a good example to community. 80 pack-year is calculated with 60 pcs/day smoking. The alcohol consumption per week was 70+70ml. The patient had been suffering from hypertension and type 2 diabetes for a year and was taking Novorapid, Levemir and Wansaar Plus. System symptoms were observed normal in physical examination. No other evidence rather than cholesterol and triglyceride elevation (cholesterol 184, triglycerides 285) were observed in laboratory tests. Fagerstrom test for nicotine dependence score was 9 points, which showed the patient had a high dependence, while Self-regulation Questionnaire score was 139 detected as low. Appropriate treatment in flow diagram was administered which was specified in national health program. Bupropion and nicotine patch were recommended in treatment. Patient started medical treatment and quitted smoking on the date he preferred. With the routine visits and patient's

cooperation to treatment, the second month is over. He never smoked then, and went on treatment successfully. Self-regulation questionnaire score was detected 138 points at second and will be applied again on the third month.

DISCUSSION: Determining self-regulation capacity and developing methods to increase the level, will increase the chance of success in smoking cessation programmes and coping with other life problems.

Keywords: self-regulation, smoking cessation therapy, case report

P-1260

Topical Treatment in Otologic Disorders – state of the art

Ana Sofia Rocha¹, Céline Raposo Gama², Sara Daniela Ferreira³, Sofia Maria Faria⁴

¹USF Modivas, ACES Póvoa de Varzim/Vila do Conde, Porto; Portugal

²USF Oceanos, ULS Matosinhos, Porto; Portugal

³USF Infesta, ULS Matosinhos, Porto; Portugal

⁴USF Lagoa, ULS Matosinhos, Porto; Portugal

Background & Aim

Otologic disorders are a common problem in primary care and its treatment is a Family Physician’s challenge. Topical therapy has many advantages however it appears that a large part of the patients are still treated with systemic antibiotics. This review aims to assess the current topical therapy recommendations for the most common ear diseases.

Methods

A systematic literature search was conducted at main research database, Pubmed and National Guideline Clearinghouse, of systematic reviews, meta-analyzes and guidelines, published between 2004 and 2014 in English, Portuguese, French and Spanish with the MESH terms “Administration, Topical” and “Ear disease”.

Results

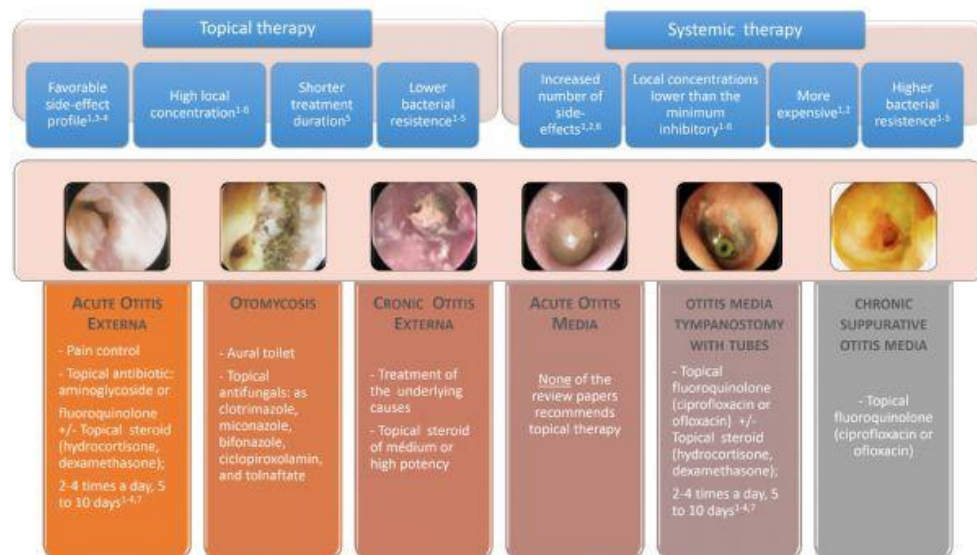
The reviewed papers demonstrate that topical therapy provides significant benefits in the treatment of outer ear pathology (external otitis and otomycosis) and middle ear (acute otitis media with tympanostomy tubes and chronic suppurative otitis media). None of these recommends topical therapy for acute otitis media. Considering the ototoxicity potential associated with other drugs, fluoroquinolones are assumed to be the agents of choice. The association with corticosteroids demonstrated several advantages.

Conclusions

Topical therapy is defined as first-line treatment in many otologic conditions. Despite recommendations it's not always the first choice in clinical practice over systemic therapy, contributing to bacterial resistance, increased number of adverse effects and longer duration of treatment.

Keywords: Ear disease, Drug therapy, Topical Administration

Treatment



P-1261

Relation of serum Creatinine with result of D-Dimer

Jose María Fernandez Gonzalez¹, Pedro Guijo Gonzalez², Juan Jesus Rodriguez Vallejo³

¹HEALTH CENTER OF LA GRANJA-MANUEL BLANCO, DISTRICT JEREZ-northwest coast, HOSPITAL OF JEREZ DE LA FRONTERA.

²INTENSIVE CARE UNIT OF JEREZ DE LA FRONTERA

³HEALTH CENTER OF LAS DELICIAS DISTRICT JEREZ-northwest coast, HOSPITAL OF JEREZ DE LA FRONTERA.

Objective

To know the influence in patients with elevated levels of creatinine in relation to positive results of d-dimer (DD). - This is a retrospective study, from the Emergency Department, (DD) is requested in patients with high disease suspected thrombus-embolic, studying the positive values of these levels depending on the serum creatinine, and revising later with study of radiological image, the confirmation of the pathology.

Total of 1116 patients, lost 6.7 %, obtaining a subgroup of 670 patients with levels higher than normal ($>0.5\text{mg/L}$), with a value of DD means of 3.25 and a standard deviation of 6.16, windmills in intermediate levels of 3 or less (74.9 %) and high levels of 3 or higher (25.1 %), the value of mean serum creatinine was 1.11 mg/dl and a standard deviation of 0.94.

In patients with DD high, all of them underwent image test, we obtained a positive predictive value VVP of 14.1 %, with a diagnosis of 14.1 %.

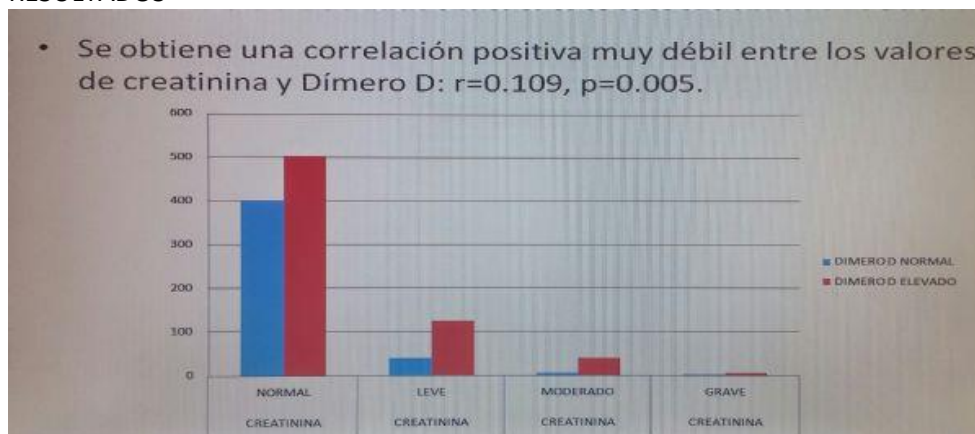
Analyzing the results based on values of creatinine, reached a PPV of 14.3 % in the patients with normal levels of creatinine, in addition to a PPV of 14.5 % of patients in the subgroup of mild renal impairment and a PPV of 9.4 % in patients with moderate renal insufficiency.

Studying creatinine level, in which that value is > 3 , highlights a growing number of requests for evidence (53.7 %) compared with the total (37.6 %), with an increase in PPV from 38.3 % in the total, that if we divided in function of the three groups of creatinine, it would give us the following RESULTS: with normal kidney function VPP 40.6 %, mild renal dysfunction 41.9 % dysfunction moderate 9.1 %.

We got a positive correlation between serum creatinine and D-dimer: $r=0,109$, $p=0.005$

Keywords: thrombosis; d-dimer; creatinine

RESULTADOS



P-1262

Virilizing Adrenocortical Carcinoma in a Premenopausal Woman: Case Report

Nazli Sensoy, Mehmet Yilmaz

Department of Family Medicine, Afyon Kocatepe University, Afyonkarahisar, Turkey

AIM: Adrenal cortical carcinoma is rare malignant tumor and with an annual incidence of about 0.6-1.67 cases per million persons per year. In this case, we are to show the role of primary care physician in approach of adrenal cortical carcinoma that presented as virilism.

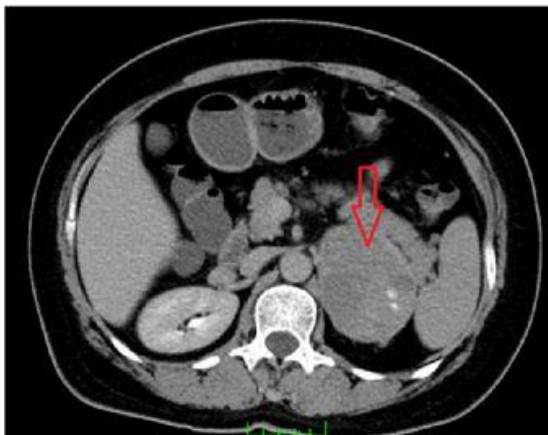
METHODS: A review of the literature is made.

RESULTS: A 45 year woman came with a complaint of hirsutism. Detailed history of the patient was taken. There were irregular menstrual bleeding of 4-month duration and hirsutism of 6-month duration. Physical examination of the patient was elevated blood pressure. There were 8-10 scored hirsutism and androgenic alopecia. Family history of hirsutism detected. On local examination there was no mass detected in lumbal region. Blood investigations, liver function and renal function tests were within normal limits. Plasma total testosterone level and 17 OH Progesteron level were elevated. There was hyperandrogenemia. We thought that this case could be an androgen secreting adenom, pheochromocytoma, Cushing syndrome or adrenocortical neoplasm presented with virilism. We consulted to our endocrinology clinic. A spiral computed tomography of the abdominal showed a mass of size 6 x 8 cm in left surrenal gland and 16 mg dexametazon suppressed the cortisol level. Patient underwent surgical excision of mass, histopathology of the mass confirmed adrenocortical carcinoma. Then referred to oncology clinic with the clinical diagnosis of metastatic adrenal cortical carcinoma. She visits her oncologist after the treatment currently.

CONCLUSION: This case shows that assesment of patient's medical and laboratory history will provide for the primary care physicians' care coordination and advocacy in their primary care management, also longitudinal continuity for the person-centered care.

Keywords: Adrenocortical Carcinoma, Virilism, Family Physicians.

A spiral computed tomography of the abdominal



P-1263

From Space to Family Medicine

Pedro Caetano¹, Carolina Martins Moreira²

¹USF Nova Via - CHVNG, Porto, Portugal

²CHP - Serviço de Fisiatria, Porto, Portugal

BACKGROUND and AIM:

Scientists and physicians can use an unique space based platform from which to conduct groundbreaking medical research. Since 2000, the International Space Station (ISS), is used as an orbiting laboratory for many kinds of research, establishing a strong relationship between health care research and space programs effort.

There has been an enormous investment from Space agencies, particularly from NASA in aerospace medicine, regarding the alterations that human physiology has in space environment and there are many medical problems that space missions have in common to a family doctor daily usual diseases as, increased infections rate, weight-bearing bone and muscles deterioration, fluid redistribution, glaucoma or increased cancer risk.

METHOD:

Bibliography research, collected data and lived experience from the author's internship in aerospace medicine in NASA-UTMB.

RESULTS:

Without gravity to help orient them, astronauts experience changes in their sense of balance. Studying this phenomenon yields insights into dizziness, vertigo, balance problems and disorders related to the inner ear. Observing the behavior of microbes and other organisms in space can generate insights into the behavior of organisms on earth, and lead to better understanding of infectious diseases and the immune system's response to them.

Studies regarding the influence of microgravity in musculoskeletal system, namely bone and muscle loss, showed the importance of exercise when compared to bisphosphonates, isolated and established some protocols that are being used on earth.

CONCLUSIONS:

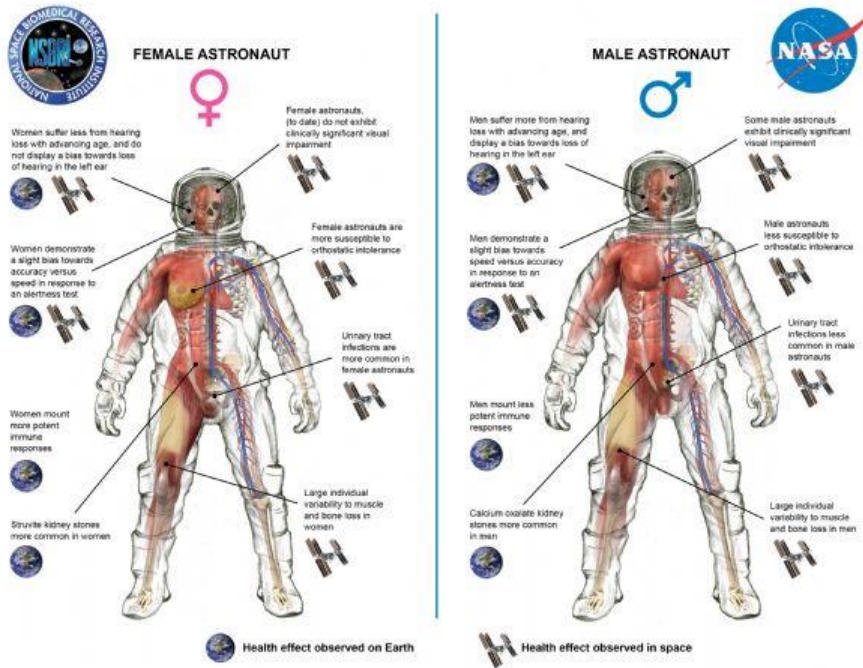
Research on the space station will help generate better understanding of how weightlessness affects the bone, muscle, inner ear systems and microbes behavior in immune system. Our health, medical knowledge and capabilities have grown greatly because of space exploration and the equipment and techniques developed for it. FM can take advantage from research and innovation and use this cutting edge information to treat patients.

Keywords: Space, ISS, microgravity, laboratory, family medicine, innovation

Exercise in ISS



Space related problems



P-1264

The Clinical and Morfoligical Picture of asytmomatic HBsAg carriers in Fachklinik Furth im Wald-Germany – Medical Cener Laza.K.Lazarevic Sabac-Serbia

Maja Canak¹, Snezana Mihailovic²

¹Fachklinik Furth im Wald-Germany

²Meical Center Laza.K.Lazarevic Sabac-Serbia

Background &AIM: Viral Hepatitis acute or chonical course is common infectious disease which characteristic inflammation and necrosis liver,and may be couesd by meny viruses.Aim of this paper is to show the incidence of different clinical form from HBV infections by asymptomatic carriers HBsAg,monitoring of Laboratory results,viral markers,ultrasound diagnostic and histopathological findings and significance of histopathologically verifications disease.

METHOD: In the Group of patients studied was 54 asymptomatic carriers disease 35(64,8%)men,19(35,2)women.The average age was 36,8+/- 9 years.The most of Patients belongs to age 21-30 years.

RESULTS: The Analysis of our findings of a small number of respondent had a " surrogate" markers of active viral replikations 9(16,7) but at 14(35,9)were founded histopathological picture of chr.Hepatitis which means that even in a number of HBeAg negative Patients active virus replikations takes place and the disease progresses by 1/3 asimptomatically holders HBsAg.By this Patients is blood testing from HBV DNA-positiv which representing the most reliable marker active virus replication.By asimtomatic carriers there is a correlation between histopathological findings and transaminase,this suggests that the routine control of transaminase is important parameter in assessing liver damage,or at leatest a guide line for liver biopsy.Determination of bilirubin to assess liver damage in asymptomatic HBsAb holders is consider it unnecessary.

CONCLUSIONS: As in our environment growing number of HBeAg negative patient,we conclude that the findings of HBV DNA as the most reliable markers of active viral replication would be useful to do in these patients and that is by asimpt.holders HBsAg necessary liver biopsy and histopathological verification of disease.

Keywords: HBsAg,Asymptomatic carriers,transaminase,liver biopsy

Asymptomatic carries HBsAg in conection HP verification / AST

AST - u/l	N	Mean	Std. Deviation	Std. Error	95% Confidence Interval for Mean Lower Bound	95% Confidence Interval for Mean Upper Bound	Minimum	Maximum
Helth without activity	40	39,58	15,81	2,50	34,52	44,63	22	95
Chr. Hepatitis B minimalne activity	11	70,00	21,19	6,39	55,76	84,24	32	96
Chr. Hepatitis B mild activity	1	75,00	/	/	/	/	75	75
Chr. Hepatitis B moderate activity	2	84,50	27,58	19,50	-163,27	332,27	65	104
Total	54	48,09	22,38	3,05	41,98	54,20	22	104

F=12,840; p<0.01

Asymptomatic carries HbsAg in conection HP verification /ALT

ALT - u/l	N	Mean	Std. Deviation	Std. Error	95% Confidence Interval for Mean Lower Bound	95% Confidence Interval for Mean Upper Bound	Minimum	Maximum
Helth without activity	40	51,65	25,07	3,96	43,63	59,67	25	135
Chr. Hepatitis B minimalne activity	11	94,18	26,70	8,05	76,25	112,12	39	137
Chr.Hepatitis B mild activity	1	114,00	/	/	/	/	114	114
Chr.Hepatitis B moderate activity	2	111,50	19,09	13,50	-60,03	283,03	98	125
Total	54	63,69	32,25	4,39	54,88	72,49	25	137

F=12,048;p<0.01

Asymptomatic carries HBsAg in conection HP verification/bilirubin

Bilirubin -Mmol/l	N	Mean	Std. Deviation	Std. Error	95% Confidence Interval for Mean Lower Bound	95% Confidence Interval for Mean Upper Bound	Minimum	Maximum
Helth without activity	40	17,9250	3,9379	,6226	16,6656	19,1844	11,00	30,00
Chr. Hepatitis B minimalne activity	11	20,0000	4,7329	1,4270	16,8204	23,1796	11,00	25,00
Chr. Hepatitis B mild activity	1	22,0000	/	/	/	/	22,00	22,00
Chr. Hepatitis B moderate activity	2	22,5000	3,5355	2,5000	-9,2655	54,2655	20,00	25,00
Total	54	18,5926	4,1732	,5679	17,4535	19,7317	11,00	30,00

F=1,620;p<0.05

Biochemical characteristics of asymptomatic carries HBsAg

• Bilirubin-Mmol/l	N	% of Total N	Mean	Std. Deviation	Minimum	Maximum
Normal value (<=22)	46	85,2%	17,3696	3,0938	11,00	22,00
Higher value (>22)	8	14,8%	25,6250	1,9955	24,00	30,00
TOTAL	54	100,0%	18,5926	4,1732	11,00	30,00

t=-7.257; df= 52; p<0.01

Biochemical characteristics of asymptomatic carries HBsAg

Ast - u/l	N	% of Total N	Mean	Std. Deviation	Minimum	Maximum
Normal value (<37)	26	48,1%	30,88	4,66	22	37
Higher value (>37)	28	51,9%	64,07	20,34	38	104
Total	54	100,0%	48,09	22,38	22	104

t=-8.121; df= 52; p<0.01

Biochemical characteristics of asymptomatic carries HBsAg

Alt - u/l	N	% of Total N	Mean	Std. Deviation	Minimum	Maximum
Normal value (<40)	14	25,9%	33,79	4,53	25	39
Higher value (>39)	40	74,1%	74,15	31,20	40	137
Total	54	100,0%	63,69	32,25	25	137

t=-4.794; df= 52; p<0.01

Distribution asymptomatic carries in relations to pole

	Frequency	Percent	Cumulative Percen
Male	35	64,8	64,8
Female	19	35,2	100
Total	54	100	

Test results,X²=4.741; df= 1; p<0.05

Distribution of asymptomatic carriers in relation to the histopathological findings

Ph verification	Frequency	Percent	Cumulative Percent
Helth without activity	40	74,1	74,1
Chr. Hepatitis B minimalne activity	11	20,4	94,4
Chr.Hepatitis B mild activity	1	1,9	96,3
Chr.Hepatitis B moderate activity	2	3,7	100
Total	54	100	

The frequency of asymptomatic carriers of HbsAg in belonging to certain categories of age

	Frequency	Percent	Valid Percent	Cumulative Percent
18				
from 21 -30		33,3	33,3	33,3
17				

	5			
	54			
From 31-40	14	25,9	25,9	59,3
from 41-50	17	31,5	31,5	90,7
from 51-60	5	9,3	9,3	100
Total	54	100	100	

$\chi^2=7.778$; $df= 3$; $p>0$.

P-1265

Primary Erythromelalgia is a uncommon vasomotor syndrome localized on hands: Report of Clinical Case

Cristian Ayala Carreño, Sara Sánchez Belmonte, Ester Muñiz Quinto, Engracia Costa Atienza, Gloria Padullers Furriols, Anna Forcada Arcarons, Alícia Díaz Pilco

Primary care center. ABS Manlleu, Barcelona. España

Description of the case

57 year old woman with a history of thalassemia minor with no other relevant history who consulted for painful burning sensation, accompanied by erythema, acral paresthesias, triad of erythema, increased temperature, and intermittent pain in the upper extremities for 3 years.

The patient was treated with anti-inflammatory drugs and corticosteroids without notice improvement

Exploration and complementary tests

Upper extremities: Both hands with erythema, swelling, a painful deep-aching of the soft tissue and tenderness, along with elevated skin temperatures in affected area.

Analysis: CBC compatible with thalassemia. Other laboratory results were nonspecific.

Differential diagnosis

Fabry disease, Peripheral neuropathy, Raynaud phenomenon, Vasculitis, Cellulitis, Reflex Sympathetic Dystrophy, Palmar Erythema, Neural Compression, Occlusive Vascular Disease, Mercury Poisoning, Autoimmune disorder, Polyneuropathy, Osteomyelitis and Sciatica.

Clinical features

The diagnosis of erythromelalgia is clinical and is set with the manifestation of 3 major and 2 minor criteria. They are major criteria: a) the evolution of paroxysmal crisis, b) the burning pain, c) erythema; are minor criteria: a) the exacerbation of seizures with heat, b) improvement in the cold, rest or both, c) local hyperthermia during the crisis, d) the favorable therapeutic response with acetylsalicylic acid (ASA).

Conclusions

Living with erythromelalgia can reduce the quality of life resulting in the inability to function in a work place, lack of mobility, depression, and is socially alienating. As with many rare diseases, many people with EM end up taking years to get a diagnosis and to receive appropriate treatment. To get a diagnosis can take many months and the patient will often have seen many specialists before finding out what is wrong with them.

Keywords: Primary erythromelalgia. Secondary erythromelalgia. Erythromelalgia. Arteriovenous anastomosis. Glomus cutaneus.

Erythromelalgia



P-1266

{"Hospitalizations due to warfarin overdose within a year in Ankara Numune Hospital and place of primary health care in follow-up"}

Elçin Katı¹, Duygu Ayhan Başer², İrfan Şencan¹, İsmail Kasım¹, Rabia Kahveci¹, Adem Özkara³

¹Department of Family Physician, Ankara Numune Training and Research Hospital, Ankara, Turkey

²Department of Family Physician, Derince Public Health Center, Kocaeli, Turkey

³Department of Family Physician, Hitit University, Çorum, Turkey

"BACKGROUND-AIM: Thrombotic diseases are one of the most common fatal disease groups, therefore treatment and prophylaxis of these diseases become important. Warfarin with a narrow therapeutic range is used in the prophylaxis and treatment of many diseases.

The purpose of this study is to evaluate the management of hospitalized patients who use warfarin, whom INR values are 4 and above, and the level of primary care follow-up.

METHOD: This is descriptive and retrospective study. All patients take warfarin, applied to our hospital for any reason between November2012-October2013 and whom INR value is at least 4 included. 187 patients detected. The patients were evaluated according to sociodemographic features, complaints, duration, doses, indications, INR values, comorbid diseases, blood transfusions, follow-up periods. We contacted with 116 patients by phone and asked the duration of warfarin use, follow-up, primary health care applications, the clinic which set-up doses, educations about warfarin.

RESULTS: 53.5% of 187 patients were male and 46.5% of patients were women. Most of complaint to the hospital was bleeding(22.4%). INR value was between 4.5-6.4. 31.6% of the hospitalized patients had blood transfusions. 116(62%) patients were discharged and 71(38%) patients were excitus. The indications for use warfarin were atrial fibrillation 30.5%, cerebrovascular event 12.8%, deep vein thrombosis 7.5%, pulmonary thromboembolism 5.9%. The cardiology started warfarin to 38%(71) of patients. 12,3%(23) of patients were admitted to the primary health care for warfarin dose adjustment. Patients followings were done by cardiology, home health services, cardiovascular surgery and neurology(16%, 6.4%, 5.9%, 4.3% respectively). The number of patients educated for warfarin use was 25(13,4%).

CONCLUSION: We determined that the management of thrombosis should done in primary health care like other diseases with high morbidity and mortality. Management of these cases must be performed by multidisciplinary approach and family physician has to be a part of it."

Keywords: primary health care, warfarin, thrombosis, anticoagulation

P-1267

Evaluating Family Functioning using FACES III in a Korean Primary Care Family Cohort

Eunjeong Choi¹, Hye Won Park², Sung Sunwoo³

¹International Healthcare Center, Asan Medical Center, Seoul, South Korea

²Department of Pediatrics, Seoul National Bundang Hospital, Seongnam, South Korea

³Dept. of Family Medicine, Asan Medical Center, Univ. of Ulsan College of Medicine, Seoul, South Korea

BACKGROUND: The family, a basic unit of social relationships, share genetic, physical and psychosocial environments. Therefore, it is considered to have an impact on the development, management and prevention of many health problems. If we can assess family functioning with objective values and observe the incidence of a disease in a prospective setting, we can prove whether the family plays a role in the development of a disease. By using a standardized FACES III (Family Adaptability and Cohesion Evaluation Scale), this study is aimed at investigating the family functioning of Korean couples METHODS: From April 2009 to April 2011, 1,034 subjects visited 26 family physicians in 23 different hospitals and were enrolled in a 'Primary Care Family Cohort'. They were all couples older than 30 years.

Family functioning was evaluated by FACES III, a 20-item scale standardized in Korean. Using the results of this questionnaire, we calculated the norms of cohesion /adaptability scale and their distributions. We also distributed them and compared with the Circumplex model devised by David Olson. RESULTS: 1,027 subjects completed filling out FACES III. The mean of cohesion scale was 34.8 and that of adaptability scale was 24.0. Women had higher adaptability and cohesion scores than men. The younger also rated higher adaptability and

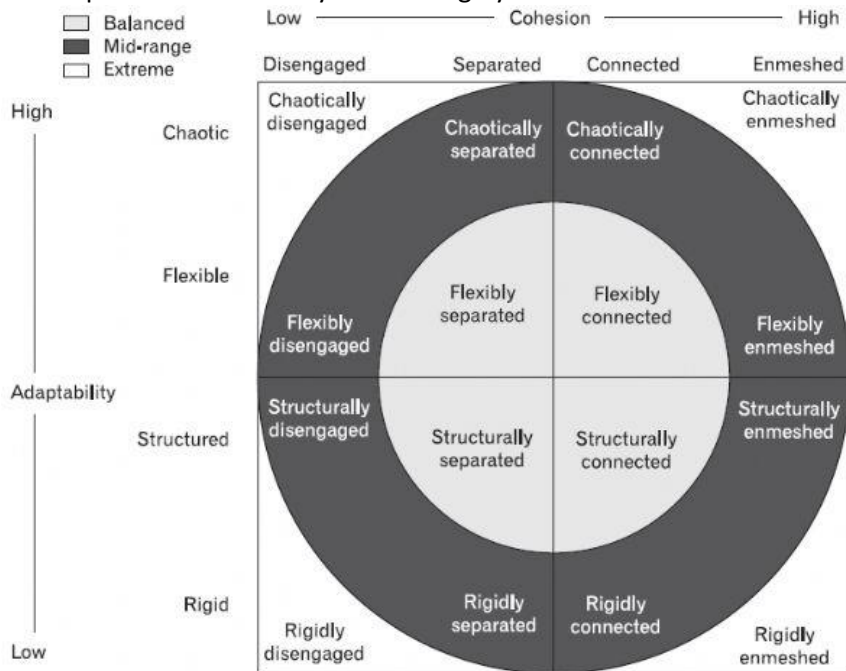
cohesion scores than the elder. The gross distribution of cohesion and adaptability scores of Korean couples in this study was not a circumplex but a crescent or a semi-circumplex.

Family functioning of Korean couples showed that the adaptability scale has two extreme values with a normal distribution. But the cohesion scale showing skewed distribution to the left is due to different family value on cohesion in Korean culture.

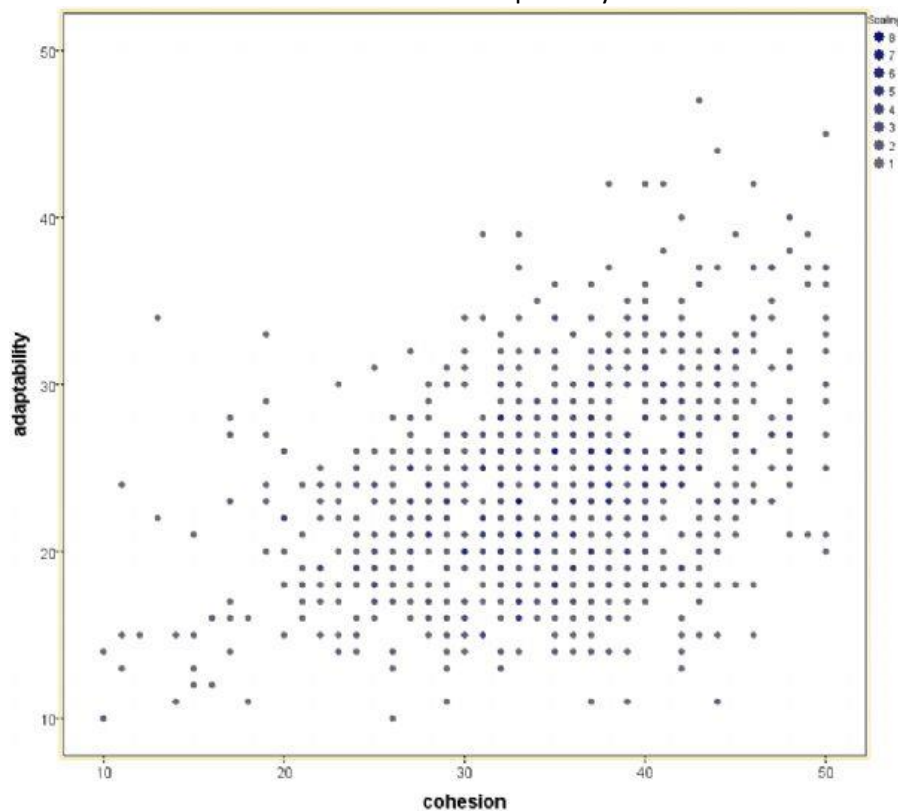
CONCLUSION: This led us to the conclusion that Korean's cohesion scale satisfies linear hypothesis rather than conventional curvilinear hypothesis.

Keywords: Family functioning, adaptability, cohesion, Family Adaptability and Cohesion Evaluation Scale, FACES III

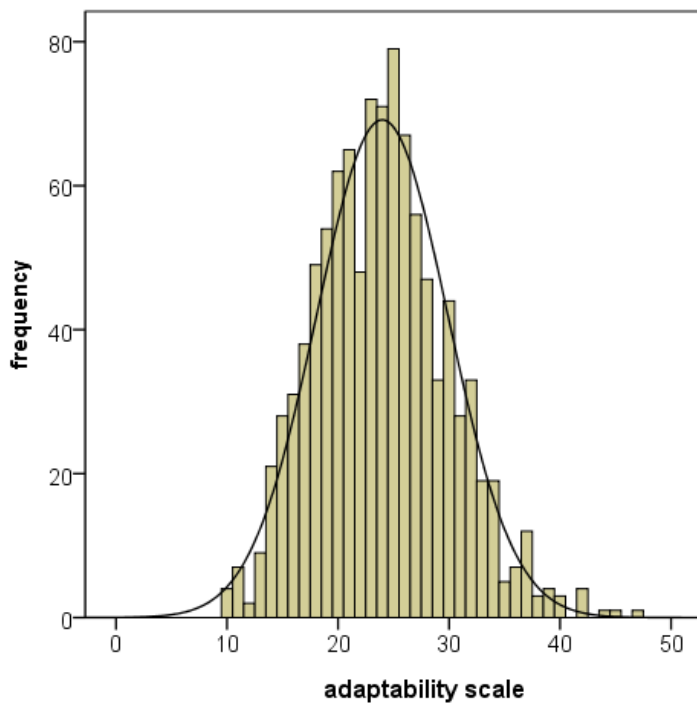
Circumplex Model of family functioning by Olson



Crescent Distribution of Cohesion and Adaptability Scores

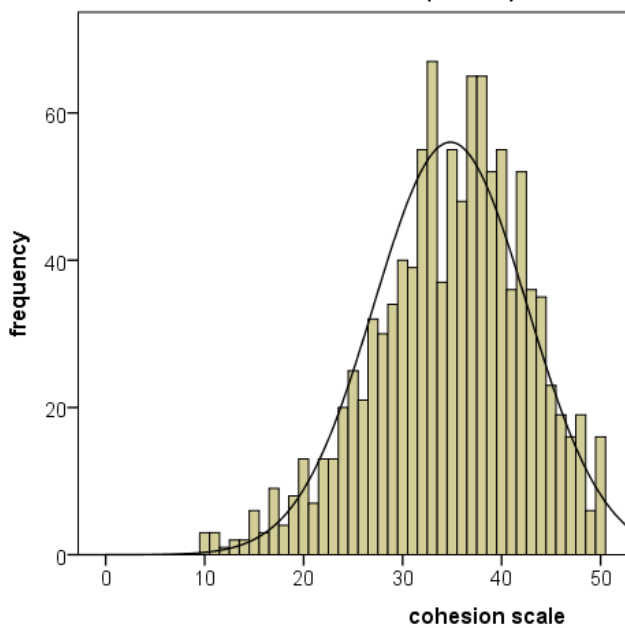


Distribution of Adaptability Scores in a primary care cohort



Mean=23.98 SD=5.92 N=1,027

Distribution of cohesion scores in a primary care cohort



Mean=34.83 SD=7.72 N=1,027

Korean Norms for FACES III

Group	N	Cohesion		Adaptability	
		Mean	SD	Mean	SD
Couples in all ages	1,027	34.8	7.7	24.0	5.9
By gender					
Male	520	34.4	7.7	23.4	5.9

Female	507	35.3	7.8	24.6	5.9
By Age(Year)					
30-39	54	36.5	5.5	25.3	5.8
40-49	146	35.4	7.2	24.3	5.2
50-59	326	34.8	7.7	24.2	5.8
60-69	391	34.4	8.2	23.6	6.2
70-	110	34.8	7.5	23.8	6.1

Abbreviations: FACES, Family Adaptability Cohesion Evaluation Scale; SD, standard deviation.

P-1268

Analysis of reasons for temporary deferral of blood donors

Hamza Aslanhan, Necmi Arslan, Erkan Kibrisli, Ahmet Yilmaz, Mehmet Halis Tanriverdi
 Department Of Family Medicine,Dicle University Medical Faculty,Diyarbakir,turkey

AIM: We aimed to determine the refusal reasons that lead to temporary deferral of blood donation.

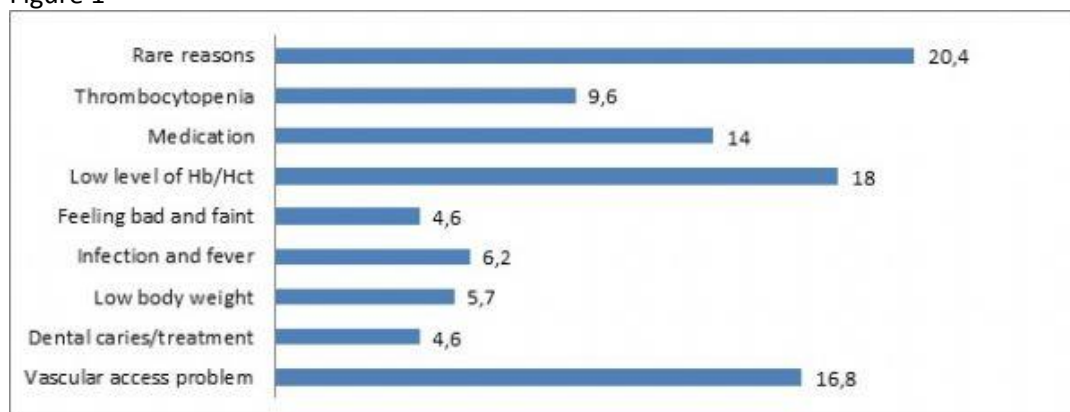
METHOD: The files of 1663 temporarily refused blood donors among the 54429 people, who applied to Dicle University, Medical Faculty, Blood Center between 2012 and 2014, were retrospectively reviewed. The selection of blood-donors and deferral criteria were based on National Blood and Blood Products Guide published by Turkish Republic, Ministry of National Health in 2011. Chi-square test was performed using SPSS15.0, and $p < 0.05$ was accepted as statistically significant.

RESULTS: Among the 54429 blood-donor candidates only 1663 people (0.03%) were temporarily refused during the 3 years period. Of these candidates, 1565 (94.1%) were male, and 98 (5.9%) were female. The mean age of them was 31.76. Among the refusal reasons, the most frequent three reasons were low Hb/Htc level, vascular access problem and medication respectively (Figure 1). The refusal reasons were evaluated by comparing four age groups (18-24, 25-39, 40-54 and ≥ 55), and statistical differences were found ($P < 0.05$) (Table 1). In addition, the rates of rare reasons responsible for the refusal of 340 donors (20.4%) were given in Figure 2. Among these rare reasons, the most common three reasons were having a chronic disease, previous donation within 3 months and operation history.

CONCLUSION: Selection of appropriate blood donors is crucial to prevent the hazardous blood transfusion. It was observed that only a small proportion of all blood donor candidates has been temporarily deferred. Therefore, more attention should be paid to the medical history and physical examination of blood donors, and education programmes should frequently be organised for health personnel. As “Dental caries/treatment” was determined among the common reasons, although we did not encounter this reason in the literature, this suggests that we need to increase public awareness on this issue.

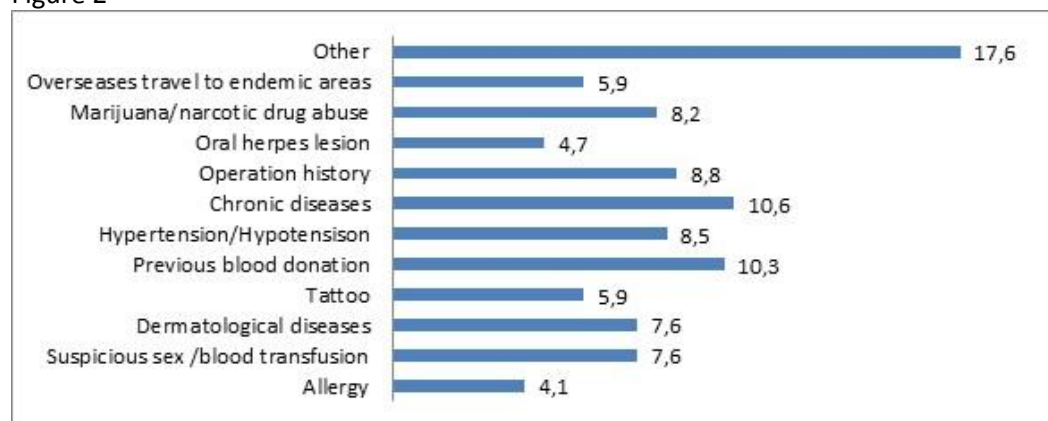
Keywords: blood donors,temporary deferral,blood transfusion

Figure 1



The rates of temporary refusal reasons

Figure 2



The rate of rare reasons

Table 1

Age	18-24 n %	25-39 n %	40-54 n %	55 ≥ n %	Total n %
Vascular access problem	64 22,9	153 54,8	58 20,8	4 1,4	279 100
Dental caries/treatment	14 18,2	48 62,3	14 18,2	1 1,3	77 100
Low body weight	41 43,2	51 53,7	2 2,1	1 1,1	95 100
Infection-Fever	24 23,3	60 58,3	17 16,5	2 1,9	103 100
Feeling bad - faint	27 35,5	42 55,3	6 7,9	1 1,3	76 100
Low level of Hb/Hct	79 26,3	155 51,7	59 19,7	7 2,3	300 100
Medication	53 22,7	129 55,4	46 19,7	5 2,1	233 100
Thrombocytopenia	33 20,6	99 61,9	23 14,4	5 3,1	160 100
Rare reasons	79 23,2	188 55,3	64 18,8	9 2,6	340 100
Total	414 24,9	925 55,6	289 17,4	35 2,1	1663 100

The comparison of temporary refusal reasons according to four age groups

P-1269

Just a musculoskeletal pain? A case report of Pancoast Tumor with Horner Syndrome

Manuel Maria Barbosa¹, Céline Raposo Gama²

¹USF Caravela; Unidade Local de Saúde de Matosinhos, EPE.

²USF Oceanos; Unidade Local de Saúde de Matosinhos, EPE.

BACKGROUND & AIM: Musculoskeletal pain is a frequent complaint at primary health care. The Family Physician (FP) has an important role in the differential diagnosis and ruling out potentially severe conditions. The aim of this case report is to emphasize that a commonly benign presentation may have a complex outcome.

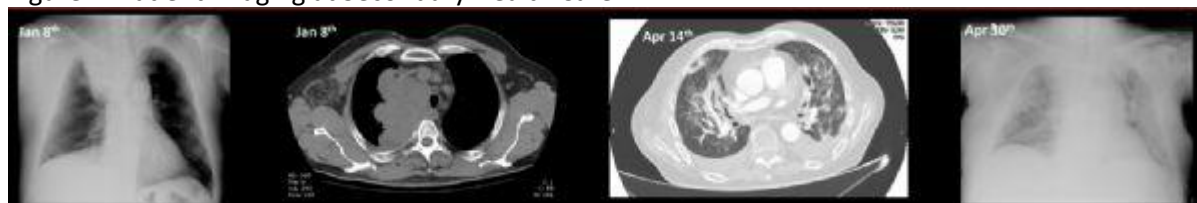
METHODS: A case report based on patient interview and electronic clinical records. A bibliographical research was conducted for clinical review.

RESULTS: A 63-year-old man, with personal history of dyslipidemia, overweight, and former smoker (fourteen months tobacco-free; 94 pack-year). Over two weeks frequently recurs to medical care with complaints of right upper limb pain with moderate functional limitation. There was a history of trauma associated. The initial physical exam showed painful right upper limb edema, especially at the elbow. There was no significant improvement in symptoms with analgesia prescribed. By his initiative the patient did a chest radiograph that showed an opacity in the upper third of the right lung. Presented to an emergency appointment with his FP. The physical findings at this point were right unilateral ptosis and miosis, edema of right side of the face, pain and edema of right upper limb and an exuberant right supraclavicular mass. The patient was referred to Secondary Health Care for study and therapeutic decision. The diagnosis was a Pancoast's tumor with an associated Horner Syndrome. The FP maintained the continuity of care with his patient, that was eventually referred to a Palliative Care Unit.

CONCLUSION: The FP, being the point of first medical contact within the health care system, is responsible for the provision of longitudinal care. He is a fundamental agent in the efficient use of health care resources working with other professionals. Finally, this case highlights the importance of considering non-musculoskeletal causes of upper limb pain.

Keywords: Musculoskeletal Pain, Pancoast Syndrome, Horner Syndrome

Figure 1. Patient Imaging at Secondary Health Care



P-1270

Painful subcutaneous nodules in HIV-pregnant woman

Paola Lievano, Alvaro Irigoyen, David Idoipe, Jose Antonio Ibañez, Carlota Canet, Oscar Zepeda, Miguel Lopez Del Pueyo, Sara Lainez, Laura Urieta, Jesus Maria Tenias, Amparo Cantin, Miguel Rivas, Violeta Alastrue, Santiago Letona

Department of Community & Family Medicine. Sector III. Hospital Clínico Universitario Lozano Blesa, Zaragoza, Spain.

Background & Aim

HIV patients with antiretroviral treatment are not uncommon in primary care. However, pregnancy increases complications. Is a major challenge to control risk factors while using antiretroviral and detection of disturbance and comorbidities. It is critical to be alert of warning signs that allow us to early diagnosis and treatment.

Method

32-year-old African-American woman was diagnosed with HIV five years ago (Category A: asymptomatic, > 500/ μ L CD4+ T-cell count) currently 28 months pregnant. Presents painful and red subcutaneous nodules located on the posterior aspects of the lower legs two weeks ago. Due to suspicion of erythema nodosum, multiple tests are requested.

Results

A positive Mantoux (vesicle and erythema 25mm). A chest radiography and echography were normal. Sputum smear and culture were performed with negative results. Biopsie of the subcutaneous fat demonstrated a lobular panniculitis.

Conclusions

Erythema induratum of Bazin (EIB) are a granulomatous lobular panniculitis that may develop in association with tuberculosis^{1 2}. Young women are commonly affected³. Treatment of EIB is the same as that for systemic tuberculosis. HIV-pregnant women who are suspected of having TB disease must be treated without delay. In contrast to EIB, lesions of erythema nodosum are more likely to occur on the anterior legs and show a septal panniculitis⁴.

Is important to know which antituberculosis drugs are contraindicated in pregnant women (Streptomycin, Amikacin and Fluoroquinolones). Rifampicin is a potent inducer of liver enzymes and lowers the blood levels of Nevirapine, should not use together.

In this case treatment was well tolerated and leaving areas of hyperpigmentation.

Treating pregnant women with both HIV and TB can be challenging frequently due to drug interactions of the medications needed for both diseases. Is necessary emphasize the role of primary care interventions.

Keywords: Tuberculosis/complications; HIV/tuberculosis co-infection; pregnancy;

A positive Mantoux (vesicle and erythema 25mm)



subcutaneous nodules located on the posterior aspects of the lower legs



P-1271

Teledermatology... Effective or theory?

Joana Palmira Magalhães

Centro de Saúde Miranda do Douro - ULS Nordeste

Background & AIM: In recent decades the worldwide incidence of skin cancer has increased. In this context, teledermatology becomes a tool more useful. With resource to doctors, communications and internet technologies, teledermatology allows easy care of population's skin.

We seek to show a case of how teledermatology can work in primary health care,

METHOD: Male, 76 years, with history of dyslipidemia and hypertension, presents to the primary care with a skin lesion on the neck, that appeared 3 years ago. Described initially as a papule of reduced dimensions, with progressive growth, appearance of a central ulcer and easy bleeding. At the objective examination revealed a lesion 2 centimeter in its longest axis, raised edges and central crust.

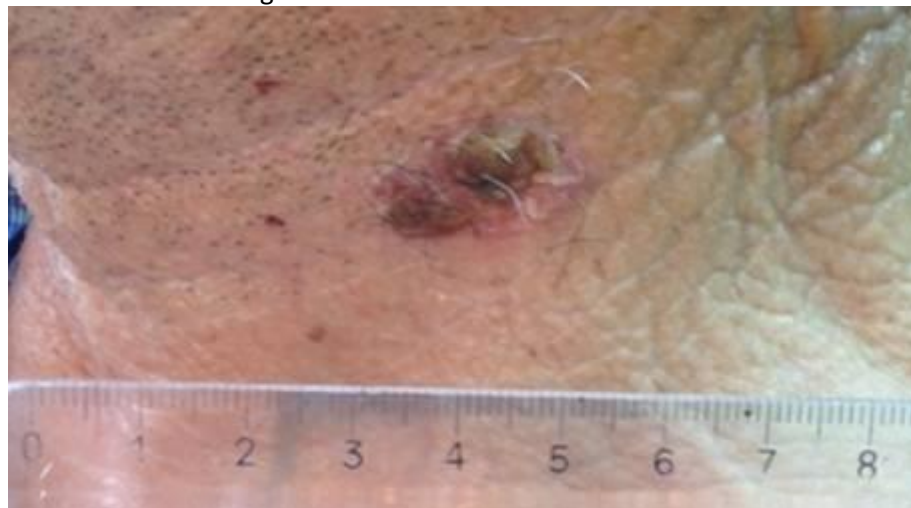
It was sent a request (with the history and the images) for review by the dermatological teledermatology screening for the hospital of reference – Hospital de Santo António, with informed consent of the patient.

RESULTS: The answer was given on the same day of the request, with a therapeutic proposal: "The patient requires surgical excision (...) at the local hospital (...) or (...) at our institution. (...) suggests basal cell carcinoma." After the patient decided to receive treatment at Hospital de Santo António, subsequent contacts took place by e-mail, to speed up and solve the problem.

CONCLUSIONS: This case report is an example of teledermatology speed and cost-effectiveness. Allows impact reduction of distance and obtains a therapeutic approach without increase the waiting list. In addition, is a tool used by family doctors and dermatologists, in a faster diagnosis and a better health outcomes. Finally, teledermatology provides training through the exchange of experiences among professionals.

Keywords: teledermatology, diagnosis, skin, cancer

Lesion with raised edges and central crust on the neck.



This lesion was the reason why the patient went to a consultation and the motive to request the teledermatology screening.

Informed consent

Anexos:

Anexo II: Quadros, tabelas e gráficos

CONSENTIMENTO INFORMADO, ESCLARECIDO E LIVRE PARA ATOS/INTERVENÇÕES DE SAÚDE NOS TERMOS DA NORMA N.º 015/2013 DA Direção-Geral da Saúde

[Parte informativa: Diagnóstico e ou descrição da situação clínica; descrição do ato/intervenção, sua natureza e objetivo; benefícios; riscos graves e riscos frequentes; atos/intervenções alternativas viáveis e cientificamente reconhecidas; riscos de não tratamento.]

À Pessoa/representante

[Parte declarativa do profissional] Confirmando que expliquei a pessoa abaixo indicada, de forma adequada e inteligível, os procedimentos necessários ao ato referido neste documento. Respondi a todas as questões que me foram colocadas e assegurei-me de que houve um período de reflexão suficiente para a tomada da decisão. Também garanti que, em caso de recusa, serão assegurados os melhores cuidados nesta Unidade de Saúde, mantendo a assistência necessária à situação de saúde que apresenta.

Nome legível do profissional de saúde: _____

Data ____/____/____ Assinatura e número de cédula profissional _____

Por favor, leia com atenção todo o conteúdo deste documento. Não hesite em solicitar mais informações se não estiver completamente esclarecido/a. Verifique se todas as informações estão corretas. Se tudo estiver conforme, então assinie este documento.

O pedido de assinatura deste documento resulta do disposto na Norma n.º 015/2013 do DGS de 03/10/2013, da Direção-Geral da Saúde.

[Parte declarativa da pessoa que consente]

[exemplo 1] Declaro ter compreendido os objetivos de quanto me foi proposto e explicado pelo profissional de saúde que assinou este documento, ter-me sido dada oportunidade de fazer todas as perguntas sobre o assunto e para todas elas ter obtido resposta esclarecedora, ter-me sido garantido que não haverá prejuízo para os meus direitos assistenciais se eu recusar esta solicitação, e ter-me sido dado tempo suficiente para refletir sobre esta proposta. Autorizo o ato indicado, bem como os procedimentos diretamente relacionados que sejam necessários no meu próprio interesse e justificados por razões clínicas fundamentadas.

[exemplo 2] Riscar o que não interessar: "Declaro que concordo / não concordo com a _____, conforme me foi proposto e explicado pelo profissional de saúde que assinou este documento, tendo podido fazer todas as perguntas sobre o assunto. Assim, autorizo / não autorizo a realização do ato indicado nas condições em que me foram explicadas e constam deste documento."

_____/_____/____ (local), ____/____/____ (data)

Nome: _____

Assinatura _____

SE NÃO FOR O PRÓPRIO A ASSINAR POR IDADE OU INCAPACIDADE

[se o menor tiver discernimento deve também assinar em cima, se consentir]

NOME: _____

DOC. IDENTIFICAÇÃO N.º _____ DATA OU VALIDADE ____/____/____

GRAU DE PARENTESCO OU TIPO DE REPRESENTAÇÃO: _____

ASSINATURA _____

Nota: Este documento é feito em duas vias – uma para o processo e outra para ficar na posse de quem consente.

Informed consent to be read and signed by the patient to authorize the sending of his photographs, which is archive in his process.

P-1272

Job Satisfaction of Primary Health Care Professionals in Turkey and Their Exposure Levels to Violence

Seyhan Hidiroglu¹, Ozlem Tanriover², Melis Tosun¹, Cem Armağan Turan¹, Burcu Sena Günaydın¹, Büşra Eser¹, Kaug Myat Htoo¹, Melda Karavus¹

¹Department of Public Health, Marmara University School of Medicine, Istanbul, Turkey

²Department of Family Medicine, Yeditepe University Faculty of Medicine, Istanbul, Turkey

Background and AIM:

Job satisfaction can be affected by various factors such as financial compensation, opportunity for advancement, relationship with the supervisor, and the job security in workplace. On the other hand, the incidence of workplace violence against health care workers is reported 16 times higher than that of any other professionals.

The aim of this study was to determine the correlation between workplace violence and job satisfaction of primary health care professionals in Turkey.

METHOD:

In this descriptive cross-sectional study a questionnaire was administered to 143 primary health care professionals. The questions asked about workplace violence and their reactions against it, while the job satisfaction was asked using "Minnesota Job Satisfaction Scale".

RESULTS:

Sixty-five percent (n=92), was exposed at least once to workplace violence throughout their career. Majority (82%, n=117) of the sample were exposed to psychological harm including verbal assaults, while 20% (n=28) of the sample were exposed to physical aggression, during the last year. Most of them had never been trained how to prevent the workplace aggression or how to react when it took place. Seventy percent (n=88) of the participants who showed great anxiety in case of violence, had been exposed to workplace violence at least once throughout their career (p<0,05). The ones who had been exposed to workplace violence at least once were less satisfied with their current profession than the ones who had never been exposed to violence before (p<0,05).

CONCLUSION:

Overall, the results showed that the majority of primary health care professionals had been exposed to workplace violence. Their anxiety levels due to the violence lead them to doubt whether the standards for workplace security are sufficient or not. The findings also pointed out the fact that the exposure to workplace violence affects the job satisfaction in a negative way.

Keywords: Violence, job satisfaction, primary health care professionals

P-1273

Minor surgery referrals at a rural/urban health center

Gloria Inmaculada Mestre Reoyo, Maria Rosario Rosillo Rein, Nayade Jorge Martin, José Carlos Perez Sánchez, José Ángel Sánchez Ortiz, Juan Carlos De Sola Jurado

Andalusian Health Service

OBJECTIVE:

Test the level of coincidence between final diagnosis by one's family healthcare professional that lead the patient to undergo minor surgery through the health center, and the post-surgery diagnostics that follow.

MATERIAL-METHODS:

Transversal descriptive study patients that were recommended minor surgery. Data obtained from clinic archives regarding the medical history of each patient. Said data was divided according to gender and diagnostic coding.

RESULTS:

Of the 238 patients sent to minor surgery, 203 kept their appointments, 87 men and 116 women. Of them, only 8 had diagnosis of derivation: 6 papillomas, 1 of papilloma / eccema and 1 with an ingrown nail. The minor surgery center only coincided with 2 papilloma diagnosis. After passing through diagnostical procedures the 203 patients were diagnosed as such: 6 abscesses, 6 soft corns, 2 fibroids, 11 lipomas, 7 nevus, 10 papillomas, 1 rubi point, 1

hemosiderotic cyst, 1 keratoderma, 9 seborrheic keratoses, 4 trichilemmal cysts, 107 warts.

12 samples from the minor surgery were sent to anatomical pathology, and were diagnosed as follows: 1 Bowen, 1 melanoma, 2 basal cell carcinomas, 3 dermatofibromas, 2 trichilemmal cysts, 3 blue nevus.

ARGUMENTS / CONCLUSION:

Improvements must be made to the regulations regarding referrals to de minor surgery, including possible diagnosis.

It would have to involve discovering why 35 patients with scheduled appointments at the minor surgery didn't attend as planned, when the average waiting time for screening consultation is 1 week, for surgery with electric scalpel 1 week and for surgery with cold scalpel 3 weeks.

It involves medical treatment with minimum delay that solves various problems and is less inclined to admit patients in to the hospital.

Keywords: Minor Surgery, Referrals, Diagnosis.

Figure 1

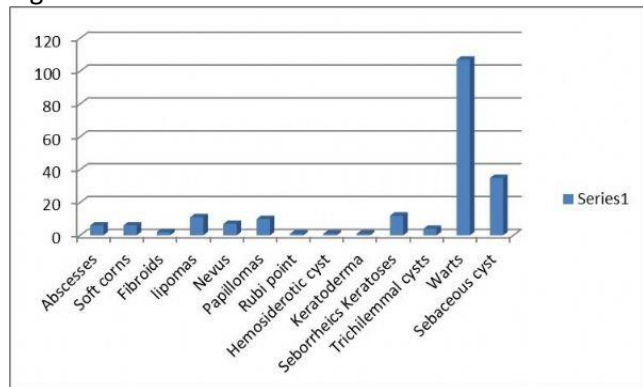


Figure 2

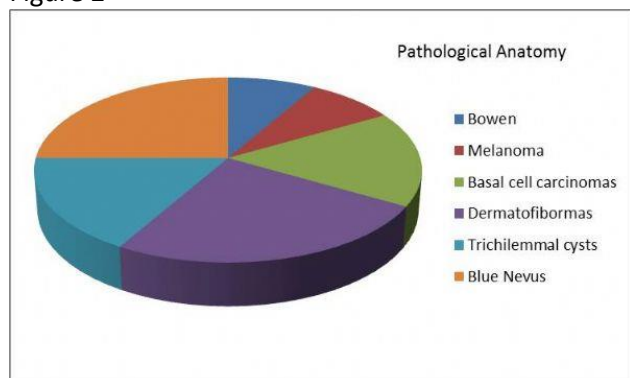


Figure 3



P-1274

probiotics supplementation and its efficacy in helicobacter pylori eradication. there's evidence?

Joana Andrade Barros¹, Lisete Aires Silva¹, Marta Sousa Santos³, Simão Costa Martins², Cilia Nogueira², Sabrina Pedone¹, Sónia Marcelo¹, José Verdelho Alves³

¹USF Terras de Souza, Paredes, Portugal

²USF Hygeia, Lixa, Portugal

³UCSP Boticas, Boticas, Portugal

Background & AIM: Helicobacter pylori (Hp) colonizes the gastric mucosa and it's associated with some pathologies, from chronic gastritis to gastric cancer. Hp eradication (HpE) may reduce the risk of developing this cancer and therefore, it should be a primary objective. The commonly used treatment may have several side effects, contributing to its failure. Some studies refer an increased benefit when the recommended treatment is associated with probiotics, revealing itself an useful tool in the HpE treatment complementarity. The aim is to gather evidence on the increasing efficiency in HpE, when combining probiotics to the eradication therapy.

METHODS: There were researched guidelines, systematic reviews, meta-analyzes and randomized controlled trials (RCT), from the last 10 years, in Portuguese and English, using the MeSH terms: "Helicobacter pylori" and "Probiotics". When necessary, the strategy was adapted to each database. To assess the level of evidence and strength of recommendation, Strength of Recommendation Taxonomy of the American Academy of Family Physicians was used.

RESULTS: There were found 236 articles, which 19 selected: four meta-analyzes, fourteen randomized controlled trials e one guideline. The meta-analyzes and the guideline refers that an increase in the HpE rates could exist with the use of probiotics. However, the included randomized controlled trials, conclude that the addition of these probiotics doesn't increase eradication rates, but showed higher tolerance to adverse effects.

CONCLUSIONS: The probiotics addiction to HpE therapy, with the purpose of achieving greater efficiency, has been under discussion in the present. Due to the results heterogeneity more studies are needed, in order to extrapolate to the population in a more sustained way. In a more consistent way, there seems to exist a beneficial effect in side effects redution, that for the greater adhesion to therapy, may lead to greater success in the eradication.

Keywords: Helicobacter pylori; Probiotics.

1



2

Authors	Year	Population (n)	Main Conclusions	Evidence Level
Wang Z, Gao Q, Fang J. ⁶	2013	1469	<ul style="list-style-type: none"> Probiotics containing Lactobacillus and Bifidobacterium in addition to eradication therapy may have beneficial effects in eradication rates and side effects 	1
Sachdeva A, Kogpal J. ⁷	2009	953	<ul style="list-style-type: none"> Probiotics possibly increase eradication rates; There're few studies yet and side quality studies, requesting more investigation 	2
Zou J, Dong J, Yu X. ⁸	2009	1372	<ul style="list-style-type: none"> Lactobacitos supplementation might be effective increasing eradication rates; Positive impact in eradication therapy side effects 	1
Tong J, Ran Z, Shen J, Zhang C, Xiao S. ¹	2007	1671	<ul style="list-style-type: none"> Probiotics supplementation might be effective in eradication rates increase and might be usefull in patients whose therapy fails; Positive impact in side effects related with eradication therapy 	1

Table 1: Systematic Reviews

3

Entity	Authors	Year	Recommendations	Level of Evidence	Recommendation Strength
National Guideline Clearinghouse ¹⁷	Carvalho L, Galaviz E, Gonzalez C, Gurney S.	2013	<ul style="list-style-type: none"> Supplementation of triple therapy with <i>Saccharomyces boulardii</i> may be considered because it may increase eradication rates; Probiotics supplementation decreases eradication therapy side effects. 	3	C

Table 2: CGS

4

Authors	Year	Population (n)	Main Conclusions	Evidence Level
Bavero-Rodriguez T, Slin F, Barbut R, Mabe R, Boscá-Frías J, Chelakoti, Reyes G, Chaves D, Elag JJ ¹⁸	2015	112	<ul style="list-style-type: none"> Probiotic association to eradication therapy didn't show an efficacy increase 	2
Shewell A, Taheri E, Yaghoobfar A, Heston R, Tahan F, Roshdaraei B, Shewell M, Shewell S, Ghobadipour A. ¹⁹	2015	100	<ul style="list-style-type: none"> The probiotic uses did not show any beneficial effect in eradication rates. The result could be associated to the probiotic low dose and/or gastrointestinal side effects high frequency 	2
Do Y, Su T, Pan J, Lu Y, Zheng P, Li X, Qian C, He F, Wang Y, Li Z. ²⁰	2012	234	<ul style="list-style-type: none"> Probiotic administration, before or after triple therapy may increase eradication rates 	2
Marshall M, Bazzani B, Eschewer R, Baccant G, Calabrese L, Faldut F, Cappello G. ²¹	2012	227	<ul style="list-style-type: none"> Probiotic addition to therapy seems to increase treatment compliance and reduce intolerance symptoms No difference in eradication rates was observed 	1
Rosato R, Miravet M, Giorgio F, Facciolongo A, Francioso Y, Hassan G, Parola G, Savazzi G. ²²	2012	80	<ul style="list-style-type: none"> Probiotic reduce antimicrobial charge, despite the effect low impact triple therapy success 	1
Machicao J, Garcia-Jover T, Soriano L, Pantoja M, Gonzalez J, Pantoja A, Calvo A. ²³	2011	42	<ul style="list-style-type: none"> Eradication rates were similar in both groups (with or without probiotics) More studies are needed with dosage, treatment duration and different probiotics combination 	1
Song M, Park D, Park J, Kim H, Cho Y, Bohn C, Jeon W, Kim B. ²⁴	2010	981	<ul style="list-style-type: none"> Supplementation with <i>S. boulardii</i> is effective reducing side effects, but not increased eradication rates 	2
Yager S, Abd E, Rappelli G, Torres S, Baroni M, Altieri S, Faldut F, Kurling G. ²⁵	2010	78	<ul style="list-style-type: none"> Probiotic addition to the therapy doesn't increase eradication rates Symptoms such as diarrhea and stomatitis were reduced 	2
Hu B, Wu B, Liu B, Park Y, Wang J, Wu J, Jiang S, Cao D, Wu J, Song R, Song L. ²⁶	2009	387	<ul style="list-style-type: none"> Adding probiotics to triple therapy did not reduce side effects, but increased eradication rates 	2
Bombardieri G, Zuffi A, Hassan G, Gerotto F, Chiodini F, Carlini V, Joly M P, Fighiera D, Mucci G. ²⁷	2009	85	<ul style="list-style-type: none"> Adding probiotics did not increase eradication rates 	2
Chelakoti M, Khan G, Kulkarni T, Dhanraj A, Vaid B. ²⁸	2007	124	<ul style="list-style-type: none"> Supplementation with <i>S. boulardii</i> showed a decrease in side effects and increase in tolerance to eradication treatment; <i>S. boulardii</i> had no significant effect on the eradication rates 	2
Madden J, Plummer S, Tang J, Gavalron L, Plummer R, Robinson M, Sumner J, Shewell C, Cheng L, Shewell Y. ²⁹	2006	30	<ul style="list-style-type: none"> Probiotics have an important role both associated to antibiotic or after antibiotic use in eradication 	2
Malykhina E, Vagstad L, Blixen T, Synnøve S, Barbut R, Vagstad H, Rørvik B. ³⁰	2005	47	<ul style="list-style-type: none"> Probiotic supplementation did not significantly decrease the frequency of new or worsening symptoms during eradication. However, it showed a better treatment tolerability 	2
Mateo E, González M, Crescenchi F, García L, Sosa M, Pascualini F, Camarero G, Gualandri G, Gualandri A. ³¹	2004	120	<ul style="list-style-type: none"> <i>S. boulardii</i> inclusion in eradication therapy decreased incidence and intensity of antibiotic side effects; There was no difference in treatment adherence or eradication rates 	2

Table 3: RCT

P-1275

Awareness and Opinion About Complementary and Alternative Medicine Amongst Healthcare Professionals

Saba Sağlıker, Nazlı Çelik, Cansu Öztürk, Burcu Demirbaş, Dilek Toprak

Şişli Hamidiye Etfal Training and Research Hospital Department of Family Medicine, İSTANBUL/ TURKEY

AIM: Complementary and alternative medicine (CAM) consists of the ever growing and popularizing range of therapeutic approaches. This study focuses on the awareness and opinion of healthcare professionals about complementary and alternative medicine.

METHODS: This research was conducted on 264 healthcare professionals. A 3-point Likert type scaled questionnaire about the knowledge level and opinion of the participant about 13 different complementary and alternative medicine approaches and socio-demographic characteristics were recorded. Data was analyzed via Chi-Square T test and frequency analysis using SPSS v20.0.

RESULTS: 143 (54.2%) of the participants were women, and 121 (45.8%) were men. Of these participants; 49 (18.6%) were midwives, 141 (53.4%) were resident physicians, and 74 (28%) were specialist. 174 (65.9%) had <5 years of clinical experience. The age average was 30.26 ±7.15. The most (n=129;48.9%) self-performed method was prayer therapy. The most common recommended therapies respectively were prayer (n=155;58.7%), massage therapy (n=145;54.9%), and nutrition therapy n=130;49.2%). Participants mostly (n=134;48%) requested nutritional therapy to be added to the curriculum; Especially females (p=0.000). Similarly, females applied prayer technique more than men (p=0.000). Most of the participants got educated on prayer (n=25;9.5%) and nutrition therapy (n=15;5.7%). While residents self-applied prayer more (p=0.000), and suggested most as well (p=0.000), they did not suggest prayer therapy education to be added to the curriculum (p=0.000). Residents believed in the application and use of nutrition therapy significantly more than midwives and specialists(p=0.005).

CONCLUSION: Today CAM are becoming more warm and interested. If CAM are added to the curriculum of medical faculties, physicians and the patients would use the method properly.

Keywords: Complementary medicine, Alternative medicine, nutrition therapy, prayer technique, therapy techniques

Chart-1

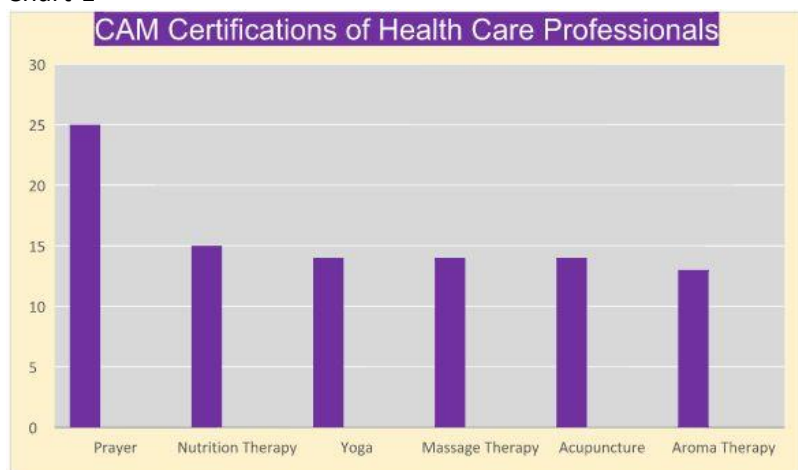


Table-1

Professional Titer	View on Adding Nutrition Therapy in the Curriculum			TOTAL	P
	Yes	No	Maybe		
Midwife/Nurse	35 %71,4	3 %6,1	11 %22,4	49	0.003
Resident/GPs	66 %46,8	47 %33,3	28 %19,9	141	
Specialist and above	33 %44,6	25 %33,8	16 %21,6	74	

Chart-2

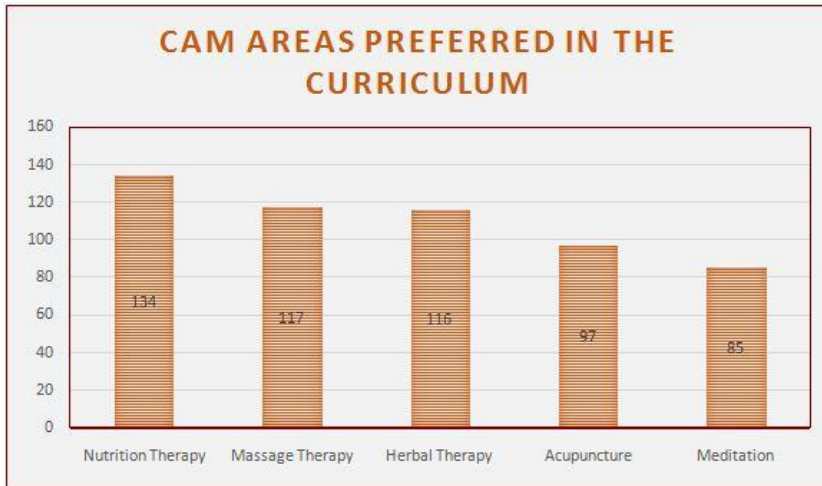


Table-2

Professional Titer	View on the Implementation After Receiving Nutrition Therapy Class			TOTAL	P
	Yes	No	Maybe		
Midwife/Nurse	29 %59,2	5%10,2	15%30,6	49	0,017
Resident/GPs	61 %43,3	44%31,2	36%25,5	141	
Specialist and above	26 %35,1	22 %36,5	27 %29,5	74	

P-1276

Eating Habit and Characteristics of Residents at Şişli Hamidiye Etfal Training and Research Hospital Family Medicine Clinic

Saba Sağlıkler, Sibel Karaman Tunç, Dilek Toprak

Şişli Hamidiye Etfal Training and Research Hospital Department of Family Medicine

INTRODUCTION: Eating disorders are both physical and psychosocial conditions that emerge from self-conscious thoughts about ones eating habits, weight, and visual image. In this report, eating characteristics of family medicine residents are taken into consideration.

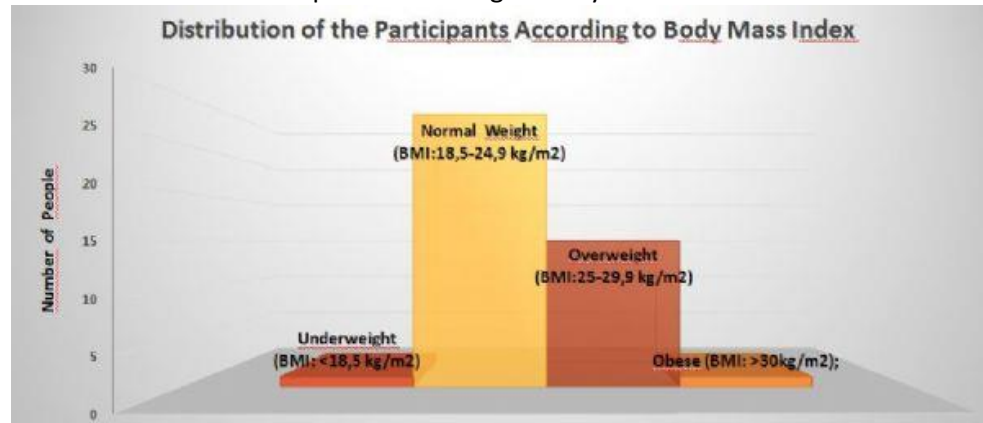
METHODS: Out of 54 residents working at Şişli Hamidiye Etfal Training and Research Hospital (ŞHETRH) Family Medicine Clinic, 45 were included in this study. Socio-demographic information data and EAT-40 eating characteristics scale results were recorded. Data was analyzed by Chi Square Test and frequency analysis on SPSSv20.0; $p < 0.05$ was considered significant.

RESULTS: Among 46 participants 32(71.1%) were women, 13 (28.9%) were men. While the average age was $28.48 \pm 2,07$; 30 (66.7%) of them were over 30 years old, 26(57.8%) married, 28(62.2%) participants had normal BMI and 31(68.9%) were living with their families. There were 21(46.7%) participants who had night shifts; 9(20%) of the participants had chronic disease. Alcohol consumption was observed in 32(28.9%) participants and there were 5(11.1%) smokers. According to their EAT-40 score, 5(11.1%) of the participants had moderate-high risk in eating disorders; 68.9% spent more than 500 TL/month for their kitchen expense. There were 24(53.3%) participants who preferred to eat outside at least 4/week. Participants who had normal BMI, rarely felt anxious after having dessert($p=0.016$), and never ate after when they felt hungry ($p=0.000$). Women are more pleased to try sweet, fat rich foods than men($p=0.023$), and preferred to not eat alone($p=0.043$). 15 (78.9%) single participants had regular weight, while 13(50%) of married participants were overweight and did not prefer diet food ($p=0.012$).

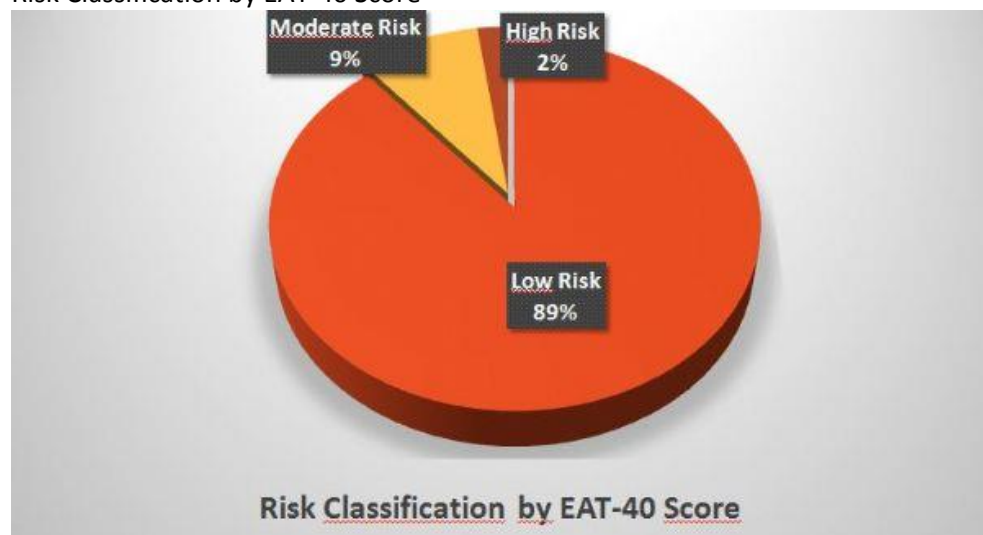
CONCLUSION: Despite the fact that eating behaviour is determined by multi-factors, it is mainly driven by person's ability to reach and consume the nutrition, and their willingness of staying healthy. Environmental factors always regulate the result. Regarding working conditions and hours, eating characteristics of residents are evident, however future analysis are needed.

Keywords: EAT-40, Eating habits, Eating disorders, visual image, consume nutrition

Distribution of the Participants According to Body Mass Index



Risk Classification by EAT-40 Score



P-1277

Magnesium and Muscle cramps – Which evidence?

Teresa Bastos, Marta Guedes, Lourdes Sousa

UCSP Sul, Oliveira de Azeméis, Portugal

BACKGROUND: Muscle cramps are involuntary contractions, sudden and painful, usually of the posterior muscles of the leg, which can last seconds to minutes. The only pharmacological intervention with proven efficacy for its treatment is quinine (with serious side effects); however, magnesium supplements have been widely used for this purpose.

AIM: Review existing evidence regarding the benefit of magnesium supplementation in reduction of muscle cramps (number, duration and frequency) on non-pregnant adults.

METHODS: Research on Medline and medical sites based on evidence; articles published between January 2004 and February 2015; English, Spanish or Portuguese; keywords "muscle cramps" AND "magnesium". It was used the Strength of Recommendation Taxonomy scale (SORT) of American Family Physician to evaluate the levels of evidence (LE) and strength recommendation (SR).

RESULTS: Of the 383 articles found we included 6 articles, 2 systematic reviews (SR), 2 guidelines and 2 randomized controlled trials (RCT).

According to an SR, the differences in frequency and duration of muscle cramps between the intervention group (magnesium) and the placebo group were not statistically significant (LE 1). In another SR, the administration of magnesium showed mixed results (LE 2), by referring that magnesium supplements may be useful in the prevention of muscle cramps (SR C).

Guidelines said that magnesium supplements are unlikely to be effective in the treatment of non-pregnant adults muscle cramps (SR C).

In RCT it was found a reduction, not statistically significant, of the number of muscle cramps in the intervention group (magnesium) compared with the placebo group (SR 1). The severity and duration of muscle cramps remain unchanged between groups (LE1).

CONCLUSIONS: We can conclude that it is unlikely that magnesium helps to prevent muscle cramps in non-pregnant adults (SR C), but will take more studies to be able to draw definitive conclusions.

Keywords: Magnesium, muscle, cramps

Leg Cramps



www.pivotphysicaltherapy.com

P-1278

to know the non-invasive mechanical ventilation

Jose María Fernandez Gonzalez¹, Pedro Guijo Gonzalez², Hector Leonardo Lugo Ramos¹, Juan Jesus Rodriguez Vallejo³

¹HEALTH CENTER OF LA GRANJA-MANUEL BLANCO, HOSPITAL OF JEREZ DE LA FRONTERA.

²INTENSIVE CARE UNIT HOSPITAL OF JEREZ DE LA FRONTERA

³HEALTH CENTER OF LAS DELICIAS DISTRICT JEREZ-northwest coast, HOSPITAL OF JEREZ DE LA FRONTERA.

Non-invasive mechanical ventilation (VMNI) has a fundamental importance in many vital and urgent pathologies. In Primary care, Family Doctor can work in the Emergency Room and for this reason, we need to know the management and usefulness of the VMNI. It is for this reason that we consider important to analyze the epidemiological characteristics and effectiveness in patients that we prescribe VMNI in emergencies.

Descriptive study conducted in the area of emergency care in patients where employment in the area of VMNI observation during a period of 6 months. Qualitative variables were age, sex, APACHE II, personal history, cause of start of VMNI, cases in which i need invasive mechanical ventilation (VMI) and mortality. The data were analyzed using the statistical program SPSS, version 22.0

There were 69 patients with a mean age of 64 years, with 54% of men and 46% women. The Apache II averaged 19.2 points. The 55% of the signs was for heart failure(IC), 29% of respiratory infection (IR), and 5% in hypercapnic encephalopathy.

In the 41.9 % of the cases it was necessary the VMI,remain effective the VMNI in 58.1 %. The average mortality found was 19 %.

41% Of failures, they had respiratory infections concomitant.

CONCLUSIONS:

The VMNI presented a high rate of effectiveness and it is a good tool in the emergency area.

In our series, the main indication of VMNI was heart failure, followed by respiratory infection, being the most prevalent factor arterial hypertension.

The main failure of the VMNI is associated with respiratory infection.

Keywords: Respiration, Artificial; Emergencies; Primary Health Care

P-1279

Studying Hyperlipidemia in diabetic patients in a rural area of Crete

Theodoros Vasilopoulos¹, Georgia Arseni², Nikolaos Kontarakis¹, Eirini Trachanatzi², Cornilia Dimitriadou², Georgios Modinakis²

¹Health center of Ag.Barbara, Herakleio,Crete, Greece

²Venizeleio Gen. Hospital, Herakleio,Crete,Greece

BACKGROUND-AIM: Diabetic patients in Greece today account for 8-9%. Specialists estimate that the percentage is higher, since many people are unaware that they suffer from SD. WHO estimates that in 2030 in Greece, the number of diabetics will rise to 1.08 million from about 853 000 in 2009. The macroangiopathy is the most common cause of death in diabetics, rising to 74%. The purpose of our study is to investigate the prevalence mainly of hypertriglyceridemia and pathological values of LDL cholesterol among diabetic patients in a rural area of Crete.

METHOD: 281 diabetic patients were studied, the year 2014, of whom 172 women and 109 men. The concentrations of total cholesterol, HDL and triglycerides were measured by enzymatic colorimetric method in biochemical analyzer BT300 TARGA of A.Menarini Diagnostics. The LDL cholesterol value was calculated based on the formula $Ldl\ levels = Total\ cholesterol - (Triglycerides\ levels / 5 + HDL\ levels)$. Values of triglycerides $>150\ mg / dl$ and LDL cholesterol $>100\ mg / dl$ were considered abnormal.

RESULTS: Ninety-nine (35.2%) diabetics, of which 61 were male, were found to have elevated levels of total cholesterol. Seventy-eight (27.7%) diabetics, of which 49 women were found to have elevated triglycerides levels, while 17 (6.04%) had abnormal values in both parameters, of which 12 were men. Pathological LDL cholesterol values were found in 46 (13.37%) diabetic patients of which 12 were women.

CONCLUSIONS: In our region, the prevalence of diabetes is higher in women. Women with diabetes present more often with hypertriglyceridemia, whereas diabetic men present with hypercholesterolemia. The high frequency of hyperlipidemia in patients with diabetes entails greater risk for coronary heart disease than in the general population. Therefore, the main concern of general practitioners is to reduce the risk of severe atherosclerosis development.

Keywords: Hyperlipidemia, diabetic patients, macroangiopathy

P-1280

“Doctor my nipples are strange!” A case of hyperkeratosis of the nipple

Cátia Pereira Da Silva¹, Diana Vaz De Miranda², Olga Pereira³, Sofia Alves²

¹General Practice and Family Medicine, USF Aquae Flaviae, Chaves, Portugal

²General Practice and Family Medicine, USF São Nicolau, Guimarães, Portugal

³Dermatology, Centro Hospitalar do Alto Ave, Guimarães, Portugal

Background & AIM:

Primary health care is the first line of patient care and it is up to the general practitioner (GP) to recognize warning signs in time and investigate or refer for further study in other specialties. A dermatological complaint assumed to be a purely aesthetic problem, such as a nipple with hyperkeratosis, maybe the first sign of a serious condition. The hyperkeratosis of the nipple and areola is due to an excessive keratinization of the nipple and /or areola. This paper aims to remind that this condition may be idiopathic or secondary to other conditions and should not be ignored.

Methods and results (Case description):

Female patient, 27 years old, referenced to Dermatology by the GP because of the presence of a nipple keratosis in the last 10 years, refractory to topical treatments. Standing out from the personal history are an hay allergy and chronic sinusitis. Medicated since 21 years old with oral contraceptive (estrogene and progestative). On the physical examination the patient presents crusts on both nipples with seborrheic aspect, non pruriginous. The crust easily come off with bathing or with tweezers, without bleeding. The areolae were normal. Breast palpation was normal. No other relevant findings on physical examination. No family history of similar injuries was reported. Requested analytical study with hormone assay, breast ultrasound and histological analysis of the crusts removed from both nipples. Recommended hypoallergenic cleansing milk without fragrance.

CONCLUSION:

The treatment of hyperkeratosis of the nipple and areola depends if it is primary or secondary to other causes, such as hormonal changes or malignancy. This condition has affected the patient's quality of life in the last 10 years and by itself is a reason to consider in approach of the GP. The aesthetic complaint of this patient should have been investigated and oriented earlier.

Keywords: hyperkeratosis, nipple hyperkeratosis, seborrheic

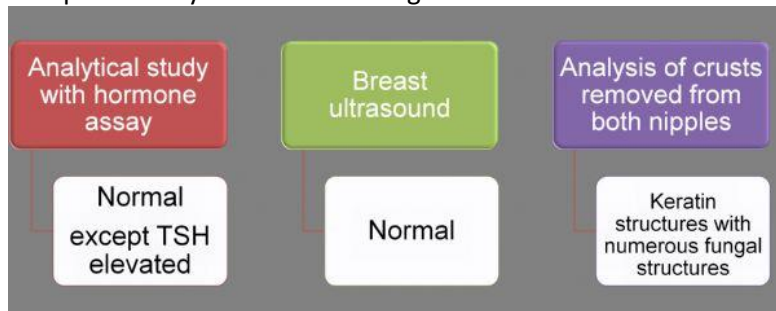
Physical examination



Physical examination



Complementary Methods of Diagnosis



Treatment



Treatment:

- Hypoallergenic cleansing milk without fragrance
- Ketoconazole cream 2 times per day, 1 week

P-1281

Alcohol consumption habits of family medicine physicians in Slovenia

Marijana Nagy¹, Sara Nikolić²

¹Healthcare Center " Dr Adolfa Drolca" Maribor, Slovenia

²Faculty of Medicine University of Maribor, Slovenia

Background & Aim

Alcohol consumption, part of Slovenian tradition and culture, is one of the most important and most frequently discussed causes of different health, social and economic issues. The purpose of the research was to assess alcohol consumption habits among family medicine physicians in Slovenia. The goal was to obtain the data about alcohol drinking patterns of the family medicine physicians and to classify them to abstinent, low-risk drinkers, high-risk drinkers, hazardous drinkers or alcoholics.

Methods

The study was descriptive, cross - sectional one on the population of 700 family medicine physicians who were invited to complete the questionnaire: The Alcohol Use Disorder Identification Test (AUDIT-10), which was used as screening tool for identification of one`s drinking patterns. 53.2% (373) doctors completed the questionnaire and were included in the final analysis and evaluation.

Results

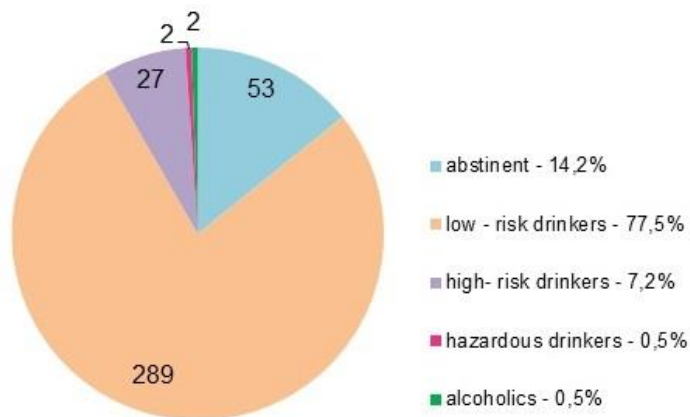
Analysis of the answered questionnaires showed that 53 (14.2%) of the doctors were abstinent, 289 (77.5%) were low-risk drinkers, 27 (7.2%) were high-risk drinkers, two (0.5%) were hazardous drinkers and two (0.5%) were alcoholics. The results revealed that the doctors with more patients and more monthly on-call hours drink more often, which was statistically significant.

Conclusions

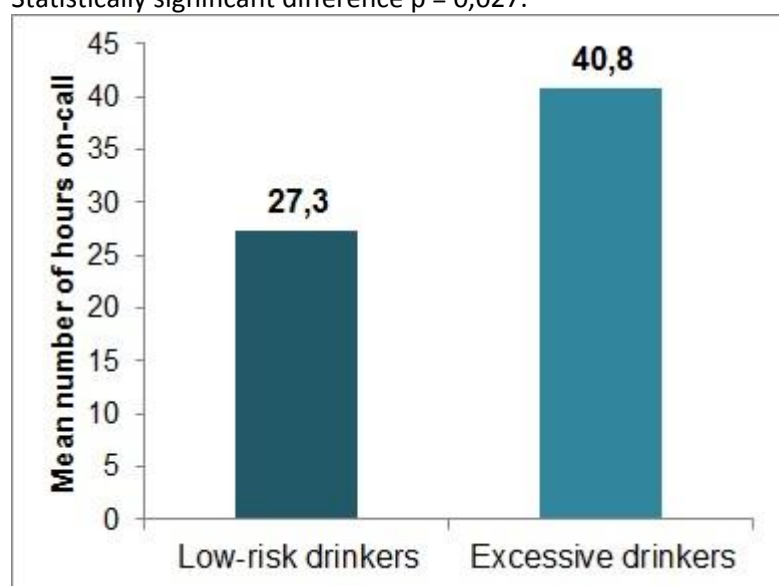
The research demonstrated that the alcohol consumption habits of family medicine physicians were comparable with those of general Slovenian population. 91.7% of the surveyed doctors were abstinent or low-risk drinkers. 8.2% of doctors were excessive drinkers, which represents an important risk-factor for low quality, unsafe and unprofessional clinical practise. Also, it may prevent one to deal properly with patients` drinking problems.

Keywords: Alcohol, physicians, Slovenia

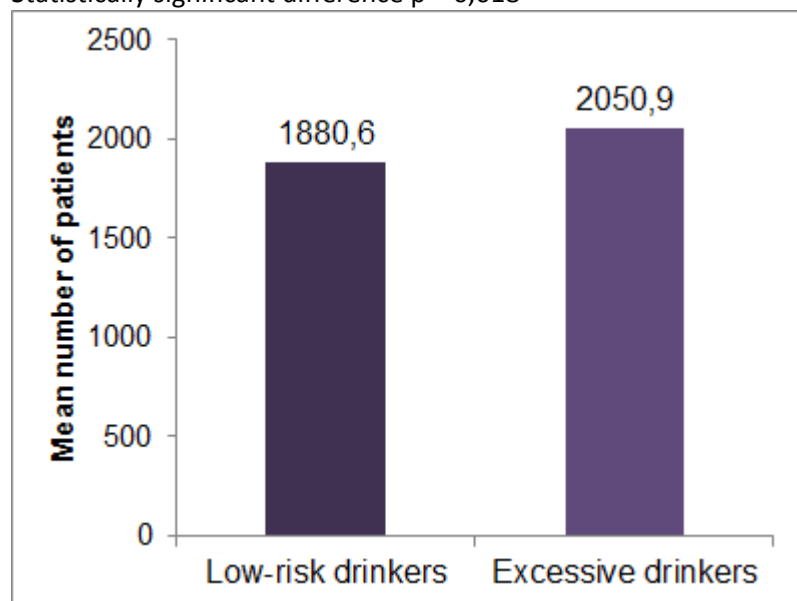
Classification of alcohol consumption patterns in family medicine physicians in Slovenia



Mean number of hours on-call in low-risk and excessive drinkers among family medicine physicians in Slovenia. Statistically significant difference $p = 0,027$.



Mean number of patients in low-risk and excessive drinkers among family medicine physicians in Slovenia. Statistically significant difference $p = 0,018$



P-1282

Sleep-Related Painful Erections Following Sexual Intercourse

Pieter Barnhoorn, Chris Walinga

Leiden University Medical Center, department of Public Health and Primary Care, Leiden, the Netherlands

BACKGROUND and AIM:

Until now, the aetiology of sleep-related painful erections (SRPEs) is unknown. There are various hypotheses about the pathophysiology. As a result different treatments have been proposed during the last four decades. However, not every patient with SRPEs agrees with pharmacological interventions for his SRPEs. We report a patient with SRPEs that only occurred after sexual intercourse in the evening.

METHOD:

A 40-year-old man presented with a 6 year history of SRPE always occurring after sexual intercourse with ejaculation in the evening. The patient underwent a bio- psychosocial evaluation by his general practitioner-sexologist as well as by a urologist-sexologist. Medical conditions, drug abuse, psychological and major relational issues were ruled out. The patient refused the proposed medication and shifted the time of sexual intercourse. After having sex in the morning or in the afternoon, he experienced no SRPEs anymore.

RESULTS:

Shifting the time of sexual intercourse to the morning or afternoon was effective in preventing SRPEs.

CONCLUSIONS:

Careful history taking is always important, especially with regard to symptoms that are only rarely reported in common practice. This case revealed that SRPEs may be related to intercourse in the evening before. Changing the time of sexual intercourse may be the simple solution.

Keywords: Sleep-related painful erections; Sleep-related erections; Pharmacological Treatments; Non-pharmacological Treatments

P-1283

Gingival hyperplasia secondary to drugs

Cátia Pereira Da Silva¹, Diana Vaz De Miranda², Maria Lurdes Rodrigues³, Rosa Couceiro¹

¹General Practice and Family Medicine, USF Aquae Flaviae, Chaves, Portugal

²General Practice and Family Medicine, USF São Nicolau, Guimarães, Portugal

³Neurology, Centro Hospitalar do Alto Ave, Guimarães, Portugal

Background and AIM:

The gingival hyperplasia secondary to drugs is an exaggerated response of the gingival tissue that appears after systemic use of some drugs, which can cause aesthetic, functional and physiological discomfort. The pathogenesis and prevalence behind this is unclear. The drugs most commonly associated with this condition are anticonvulsants, immunosuppressants, and calcium channel blockers. This paper aims to remind the importance of the General Practitioner's acknowledgment of this adverse reaction when prescribing prolonged systemic use of these drugs.

Methods and results (Case description):

We relate a case of female patient, 53 years old, with Epilepsy since the age of 10 and with nodular goiter. Treated with phenytoin and primidone for about 10 years, with symptomatic control. Referred to the Neurology Department for replacement therapy due to side effects of chronic medication. Standing out from the objective examination, a gingival hyperplasia of the upper dental arch. The patient reported that she had had the same changes in the lower dental arch lower, with the placement of dental implants. Phenytoin was suspended and replaced by eslicarbazepine acetate.

CONCLUSION:

Gingival hyperplasia can cause pain and difficulty during mastication, gingival bleeding and periodontal changes. The cosmetic damage may substantially affect the social and professional quality of life of the patient and should not be ignored. Phenytoin is a popular antiepileptic often associated with the development of this pathology. Despite the symptomatic disease control with phenytoin, the replacement therapy is mandatory, as it is a common side effect of antiepileptics. The therapeutic adjustment and reinforcement of appropriate orodental hygiene should be the first line of action.

Keywords: Gingival hyperplasia, phenytoin, anticonvulsants

Physical examination



P-1284

Chronic Obstructive Pulmonary Disease and smokers working in highly polluted areas

Maria Chalkidou¹, Maria Bakola², Konstantina Mavridou², Efcharis Fileli¹

¹Primary health care center of Tsotyli, General Hospital of Kozani, Kozani, Greece

²General Hospital of Ioannina „G.Hatzikosta“, Ioannina, Greece

Background & AIM: Chronic Obstructive Pulmonary disease (COPD) is a leading cause of morbidity and mortality worldwide and results in an economic and social burden that is both substantial and increasing. Inhaled cigarette smoke and other noxious particles such as smoke from biomass fuels cause lung inflammation, asthma, lung cancer etc. The aim of the study was to evaluate smokers who work in unhealthy areas.

METHOD: 78 smokers, employees at the Hellenic Electricity Corporation, were evaluated at our primary care health centre, between November 2013 and June 2014. Data were collected by means of a modified questionnaire based on COPD Assessment Test, Modified Medical Research Council Dyspnea Scale and COPD population screener.

RESULTS: Study sample included 72 male and 6 female smoker employees, aged 30 to 59 years, divided in three age groups. Group I (30 to 39) n = 26; Group II (40 to 49) n = 33; and Group III (50 to 59) n = 19 The symptoms of COPD are evident in Group II. The number of daily cigarettes predominates in Group III which is the group that seems to have more symptoms. The average age of daily smoking initiation was 17.5 years old. The number of episodes of breathlessness, chest tightness, shortness of breath increases with age.

CONCLUSIONS: Often patients approach the doctor with delay and respiratory infections usually are not attributed to COPD. The average patient with COPD at diagnosis has already lost 50% of respiratory function. Family medicine physicians should always have in mind that smokers who work in an unhealthy environment are more likely to develop COPD symptoms. It is necessary to work on the prevention of smoking in such areas, recognize early symptoms of COPD and refer the patients to pulmonologists for further evaluation and treatment.

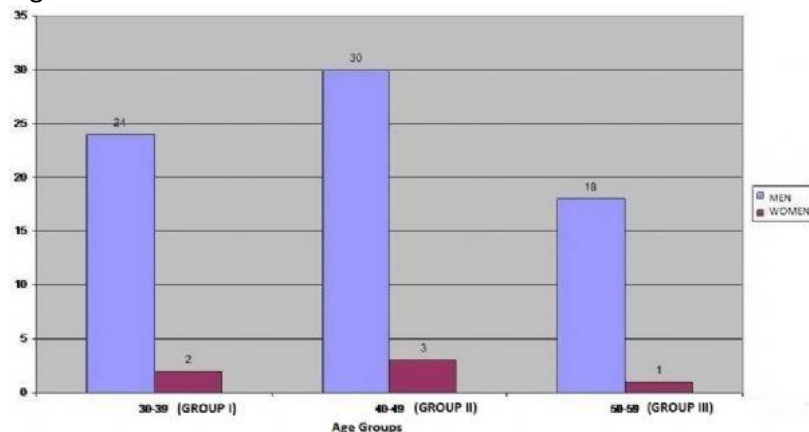
Keywords: smokers, pollution, copd, biomass, prevention

Figure 1



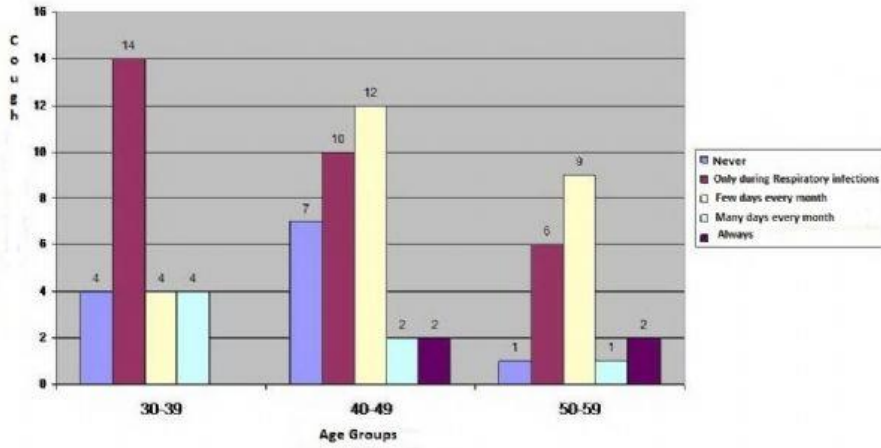
COPD will be the third leading cause of mortality by the year 2020 (Murrey and Lopez 1997) (The photograph was taken from www.econews.gr)

Figure 2



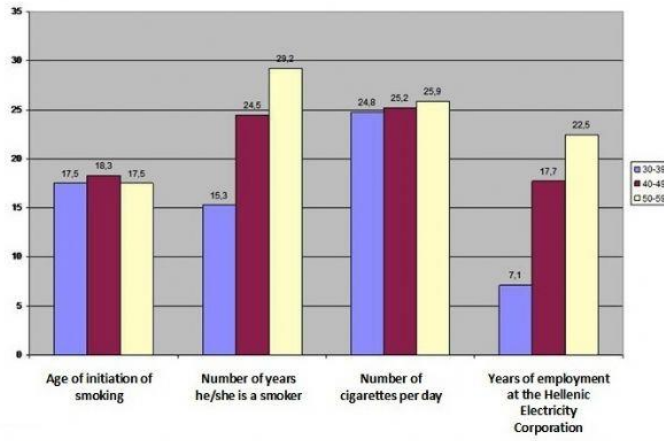
Sample of the population divided into three age groups

Figure 3



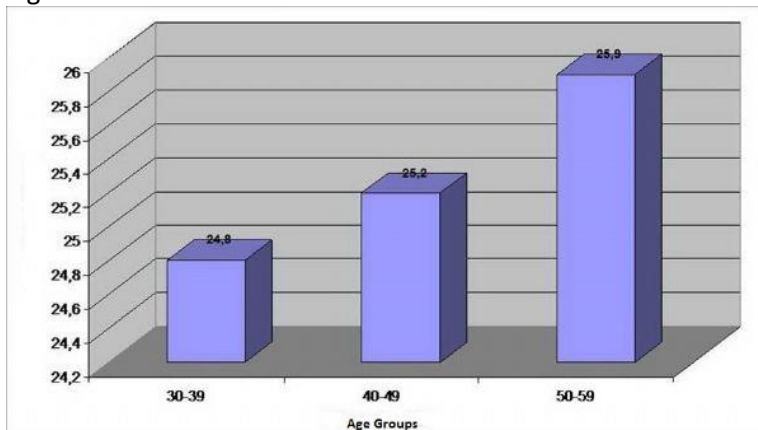
Incidence of Cough

Figure 4



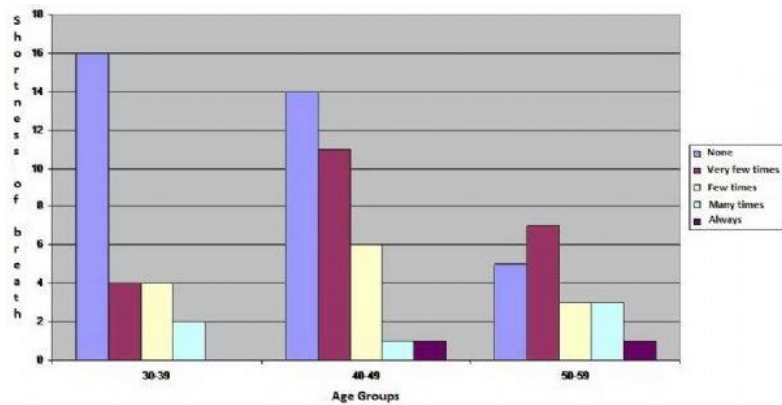
Questionnaire answers

Figure 5



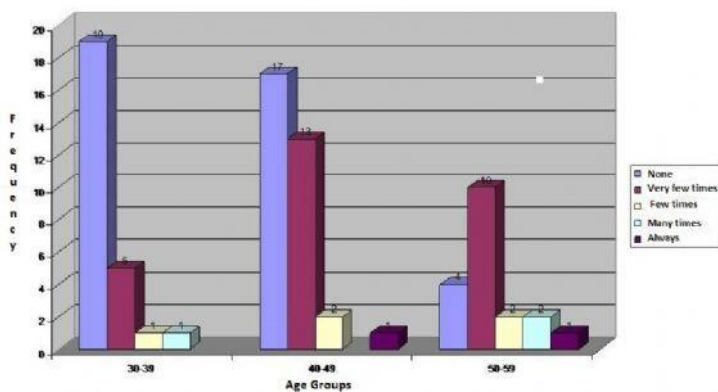
Number of cigarettes per day

Figure 6



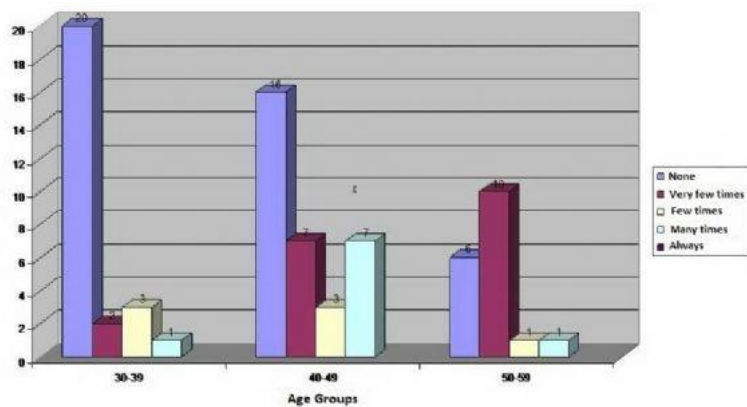
Incidence of Shortness of Breath

Figure 7



Incidence of Chest Tightness

Figure 8



Activity Limitations at home (Chest Pain, Breathlessness etc.)

P-1285

Acute superficial lymphangitis following a kitten bite. Cat scratch disease? A case report

Maria Bakola, Konstantina Mavridou, Eyfrosyni Gianouza, Akrivi Logotheti, Maria Chalkidou, Christodoulos Papaioannou

Primary care health center of Derviziana, General Hospital of Ioannina „G.Hatzikosta“, Ioannina, Greece

Background & AIM: Cat scratch disease (CSD) is caused by *Bartonella henselae*, a gram negative bacteria which is most often transmitted to humans through a bite or scratch from an infected cat or kitten. CSD often is a self-limiting condition but sometimes can affect major organ systems of the body. The aim of this case report was to draw the attention of family physicians concerning this disease.

METHOD: A 53-year-old man presented to the primary care health centre with rapidly progressive right arm pain and erythema.

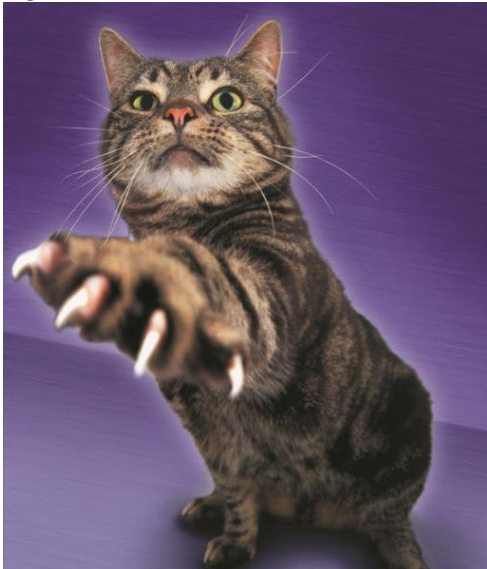
The history revealed a kitten bite in his right thumb 36 hours ago. The patient had no symptoms until the next day when his thumb became increasingly painful, with erythema spreading to his wrist, which prompted him to seek medical care. On presentation, the temperature was 39,2 °C, the heart rate 61 beats per minute, and the blood pressure 121/79 mm Hg.

RESULTS: The physical examination revealed a painful pustule on his right thumb with surrounding warmth, tenderness, erythema, and linear streaking to the elbow as well as axillary, painful and ipsilateral lymphadenopathy. The patient was referred to the hospital where empirical antibiotic treatment with clindamycin was initiated. By the third day of hospitalization, the erythema and the pain had improved, and the patient was discharged after seven days, while receiving oral antibiotics for another 14 days. At follow-up two weeks after discharge, the pustule was crusted and the erythema was substantially improved.

CONCLUSION: Although *Bartonella henselae* was not confirmed in our case, it is important for family physicians to recognize patients at risk of CSD and have in mind that can develop systematic symptoms as well as lymphadenopathy. In such cases the patients should be referred to the hospital in order to receive intravenous antibiotic therapy.

Keywords: *Bartonella henselae*, lymphangitis, lymphadenopathy, Cat Scratch Disease

Figure 1



Scratch of an infected cat

Figure 2



Painful pustule

Figure 3



Erythema and linear streaking to the elbow

Figure 4



Improved erythema

P-1286

Differences between primary care in developed and developing countries - From Portugal to a Burmese refugee-camp in Thailand, two different worlds

Pedro Caetano¹, Carolina Moreira²

¹USF Nova Via - CHVNG, Porto, Portugal

²CHP - Serviço de Fisiatria, Porto, Portugal

BACKGROUND

In the last years there was an increase in quality patient care in Portuguese health system, mainly because of an improvement in primary care quality due to creation of last generation health centers – Unidades de Saúde Familiar B (USF B). The health care provided in a refugee camp in an developing tropical country is totally different from the standards that we have in Europe. MaeLa refugee-camp provides shelter for ~45000 refugees. Inside the camp, a humanitarian organization provides free acute primary care in a outpatient department (OPD). Infectious diseases are a significant cause of morbidity and mortality in the developing world. Viruses contribute significantly to medical consultation, although data for low-income and tropical countries are scarce. The aim of this work was to compare the different motifs of acute primary care consultations between a developed country and among refugees living on the Thailand-Myanmar border.

METHODS

RESULTS: collected data from open consultations carried out by the author in USF-Nova Via between January/March 2015 and lived experience from the author in MaeLa Refugee-Camp Thai-Myanmar border in November/December 2014.

RESULTS

The most common motifs in USF-Nova Via`s acute consultations were: upper respiratory infections, administrative procedures, musculoskeletal diseases in comparison with motifs in MaeLa Refugee-camp in which infectious diseases prevailed with tropical diseases such as malaria, parasites, dengue, lower respiratory infections, measles and diarrhea on top.

CONCLUSION

There are meaningful gap in health care conditions between developed and developing countries. Developed countries have prevention standards, hygiene conditions and public health politics, as well as health education on the other hand, developing countries infectious diseases still have the higher impact, due to the lack of structural conditions and health education.

Individuals in conflict-affected areas rarely get appropriate care for chronic or non-infectious diseases, due to that, infections continue to be the most common motifs.

Keywords: Primary care, refugee camp, developed, developing countries, humanitarian

Most frequent reasons for consultation

USF NOVA VIA - PORTUGAL SMRU CLINC MaeLa Refugee Camp THAI-MYANMAR Border

1- Upper respiratory infections 1- Infectious tropical diseases (malaria, parasites, dengue; measles)

2 - Administrative procedures 2 - Lower respiratory infections

3 - Musculoskeletal diseases 3- Diarrhea

MaeLa - Burmese Refugee Camp



Clinic Room - Children on the floor

MaeLa Refugee Camp



MaeLa Refugee Camp Clinic



SMRU Clinic MaeLa Refugee Camp



European Medical Office



P-1287

From Space to day to day - Medical Innovations

Pedro Caetano¹, Carolina Moreira²

¹USF Nova Via - CHVNG, Porto, Portugal

²CHP - Serviço de Fisiatria, Porto, Portugal

BACKGROUND and AIM:

Space investigation is in the center of many important medical and technological inventions.

Since the beginning of manned space flight that NASA's role in medical breakthroughs is unquestionable, with a crescent importance with the establishment of space agency.

The research led to the design of different protocols and medical devices that we use daily in our medical practice.

METHOD

Bibliography research, collected data and lived experience from the author's internship in aerospace medicine in NASA-UTMB.

RESULTS

Artificial members: NASA robotic department led to the discovery of very light materials, with great power to absorb the impact and that adjusts to human conditions, leading to the construction of new prosthesis

Ocular screening: An image-processing technique developed by NASA and now used to detect eye problems in very young children.

Insulin-Bomb: the need to have a permanent monitoring of astronauts health led to the development of vital control devices over long namely by controlling sugar level in the blood and inducing an adequate dose of insulin - now known as the insulin pump, helping control blood sugar in people with diabetes.

MRI and CT: Occasionally NASA didn't invent the breakthrough, but rather the technologies that led to breakthrough. NASA's Jet Propulsion Laboratory (JPL) developed digital image processing to enhance pictures of the moon, that contributed to MRIs and CT.

Headset Thermometer: Taking advantage of the technology that NASA uses to measure the temperature of stars, using infrared technology, was created an infrared sensor that is used as ear thermometer.

CONCLUSION

Remote health-monitoring sensors and insulin-bomb, that helped to make the control of the diabetes process easier to manage, are just two examples derived from orbital space medical programs. Our health, medical knowledge and capabilities have grown greatly because of space exploration and the equipment and techniques developed for it.

Keywords: Space medicine, medical innovations, family practice

Artificial Limbs



Headset Thermometer



Insulin-Pump



P-1288

Alcoholic Cardiomyopathy

Özden GÖKDEMİR¹, Ülkü BULUT³, Kemal Aygün⁴, Hüseyin Dursun², Mehtap Kartal¹, Dayimi Kaya²

¹Dokuz Eylül University, Medical Faculty, Family Medicine Department, İzmir, Turkey

²Dokuz Eylül University, Medical Faculty, Cardiology Department, İzmir, Turkey

³Torbali Public Health Care Center, İzmir, Turkey

⁴Dokuz Eylül University, Medical Faculty, Internal Medicine Department, İzmir, Turkey

BACKGROUND: According to WHO approximately 2 billion people consume alcohol. It is stated that little/moderate consumption of alcohol reduces cardiovascular disease risk due to antioxidant, anti-inflammatory, even anti-coagulation effects. However its mostly known abuse outcomes are impairments in cognition, reflexes, judgments and movements as it effects neurological system.

CASE: A 47 year old male admitted to the emergency room with complaints of palpitation, dyspnea of New York Heart Association (NYHA) Class 3 which was started a month ago. His coronary angiography, performed a year ago due to nonspecific complaints, was normal. In his physical examination; 2/6 degree systolic heart murmur was audible on the mitral area. Electrocardiography showed an atrial fibrillation rhythm with a rate of 110/min without any ischemic signs. Global hypokinesis of left ventricle with an ejection fraction of 25% and moderate degree mitral insufficiency were detected on transthoracic echocardiography. In his medical history his alcohol consumption was more than three glass/day. He has been hospitalized as dilated cardiomyopathy, atrial fibrillation. Amiodarone of 1000 mg was started intravenously for cardioversion. However atrial fibrillation persisted, electrical cardioversion performed for sinus rhythm achievement. His control echocardiography under sinus rhythm was similar. He discharged as complaints declined. In his third month control he was asymptomatic, considered as NYHA stage 2. As he had no detectable ischemic pathology in coronary angiography, cardiomyopathy couldn't be due to ischemic etiology.

DISCUSSION: Physicians should keep in mind the alcoholic cardiomyopathy for their patients with signs of heart failure and should carefully evaluate the alcohol consumption. However besides the long term use of alcohol, the

possible asymptomatic course of the disease should not be forgotten. So high alcohol consuming patients should also be informed about alcoholic cardiomyopathy. More than 80 gr/day of alcohol consumption with a minimum of 5 years is considerable for diagnosis and treatment includes cessation of alcohol and standard treatment of heart failure.

Keywords: alcohol consumption, cardiomyopathy, prevention

P-1289

Burn out among private general practitioners of the region of Sousse (Tunisia)

Meriam El Ghardallou¹, Thouraya Ajmi², Manel Limem¹, Awatef Jawadi¹, Menel Mellouli², Chekib Zedini¹, Iheb Bougmiza², Ali Mtiraoui¹

¹Department of family and community medicine, Faculty of medicine, University of Sousse, Tunisia

²Laboratory research of quality of maternal health care, "LR12ES03". Faculty of medicine of Sousse, Tunisia.

BACKGROUND:

In the last few years, pressure on Tunisian doctors has risen as a result of several changes such as economics constraints. This resulted in work stress and in increase of chronic reactions like the burn out syndrome.

AIM:

This study aimed to evaluate the prevalence of burnout among private general practitioners (GP) of the region of Sousse (Tunisia).

METHOD:

We conducted a descriptive cross sectional design evaluating the burnout syndrome among GP in the sanitary region of Sousse.

It was carried out in 59 GP working in the private sector of the primary health care during December 2014.

Data were collected via a structured questionnaire with two mainly parts:

The first concerned the socio-demographical variables (age, marital status, time when the installed their practice, type of practice...) the second corresponded to the French version of the Maslach Burn out Inventory (MBI). The data were analyzed using SPSS.18.

RESULTS:

The majority of participants were men (72.4%), living in an urban area (91.2%) and were married (86.2%). Their mean age was 47 years \pm 11.

Median scores on the three dimensions of burn out (emotional exhaustion, depersonalization, low personal accomplishment) were respectively 22.5 [Q1=13 - Q3= 27.2], 4 [Q1=1 - Q3= 8] and 43 [Q1=39 - Q3= 46].

About fourteen per cent of the practitioners had high scores of burn out on the 3 subscales.

CONCLUSION:

Burnout among doctors is becoming a serious problem that can affect patient care. However, it still be prevented.

Keywords: Burnout-general practionners

P-1290

Fatigue and excessive daytime sleepiness in patients with Myotonic dystrophy type 1

Ana Borivoje Bojčić¹, Veroslava R. Maksimović¹, Stojan Perić²

¹Health center Dr Simi Milosevic, Belgrade

²Institute of neurology, Clinical Centre of Serbia, School of Medicine, University of Belgrade, Serbia

OBJECTIVES: Myotonic dystrophy type 1 (DM1) is a multisystemic disorder. The main emphasis is usually placed on progressive muscle weakness and myotonia, while central nervous system manifestations have received little attention.

AIM: To evaluate the presence of fatigue and excessive daytime sleepiness (EDS) in patients with DM1 and to assess if these two symptoms affect quality of life (QoL).

Patients and METHODS: This study included 62 consecutive patients with adult form of DM1 who were seen at the outpatient unit of the Institute of Neurology, Clinical Center of Serbia. Severity of muscular involvement was measured by MRC score. Following assessment questionnaires were used: the Fatigue Severity Scale (FSS), the Daytime Sleepiness Scale (DSS), the Hamilton Depression Scale and the SF-36 questionnaire.

RESULTS: Our study showed that 58% of DM1 patients were fatigued and 40% were sleepy. Fatigue was related to the age of patients ($p < 0.05$), their muscle strength ($p < 0.01$) and the level of depressiveness ($p < 0.01$). However, EDS was related only to the level of depressiveness ($p < 0.01$). SF-36 total score was significantly affected by fatigue ($p < 0.01$), but not by EDS ($p > 0.05$).

CONCLUSION: Significant fatigue was observed in majority of DM1 patients and it significantly affected their health-related QoL. EDS was frequently found in DM1 patients and it may present a danger to the patients themselves and to the others.. We emphasize the importance of development of compensatory strategies to reduce fatigue and EDS in patients with DM1.

Keywords: myotonic dystrophy, fatigue, excessive daytime sleepiness

P-1291

Diagnosis indurated leg injury

Lorea De Unamuno Lumbreras¹, Verónica Parent Mathias², Irina Yezerska Sushko³, Juan Manuel García López²

¹El Palo Primary Health Center, Málaga, Spain

²Department of Emergency of Regional Hospital, Málaga, Spain

³Cantabria Public Health Service, Spain

Medical history: former smoker, tonsillectomy 12 years ago, at age 9 hospitalization for nodal tuberculosis. He does not take medication.

Anamnesis: male patient aged 37 who consults for several days about indurated lesions on the front of both legs somewhat painful to touch.

He denies fever or sweating. No cough or diarrhea or joint pain. No prior throat infection.

Exploration: On the front of both legs several painful erythematous nodules are seen to touch resizable between 2 and 6 cm in diameter.

Additional tests: Blood test: blood count, hemostasis and normal biochemistry, ASLO negative, HIV, HBV, CMV, EBV negative syphilis and toxoplasmosis. Chest radiography revealed nothing abnormal. Skin test negative tuberculin.

Clinical Trial: Erythema nodosum (EN) idiopathic.

Differential Diagnosis: The EN can be confused with other forms of panniculitis, especially nodular vasculitis, the Weber-Christian disease, subcutaneous bacterial or fungal infections, superficial thrombophlebitis and cutaneous vasculitis.

Treatment: Erythema nodosum is usually a benign condition and self-limiting to cure without sequelae, but sometimes painful, so treatment should be aimed at improving the symptoms with rest and anti-inflammatory drugs and treat the underlying cause if any.

Evolution: The lesions healed without scarring in two months.

CONCLUSIONS: The interest of erythema nodosum is not only in making a diagnosis of the skin lesion, but in examining the possible existence of an underlying disease associated. In the case described highlights the history of tbc in childhood, although their association is discarded. The list of possible etiologies is extensive: infectious cause: hemolytic streptococcus, tuberculosis, yersinia, salmonella, campylobacter, HIV, HBV, CMV, EBV, syphilis, toxoplasmosis; sarcoidosis; inflammatory bowel disease; Behcet disease; connective tissue diseases; lymphomas; carcinomas; drugs such as oral contraceptives, analgesics, penicillin.

EN idiopathic is a diagnosis of exclusion, however, the clinical monitoring should continue over time to rule the late appearance of some pathology as erythema nodosum may precede these entities from months to years.

Keywords: erythema nodosum, etiology, tuberculosis

erythema nodosum



P-1292

The stigmatization of tuberculosis patients registered at Maltepe and Bahcelievler tuberculosis dispensaries in the province of Istanbul

Seyhan Hidirođlu¹, Abdullah Sariöz¹, Mahmoud Bhais¹, Seda Karakurt¹, Hasan Can Şahan², Melda Karavuş¹

¹Department of Public Health, Marmara University, Istanbul, Turkey

²Maltepe tuberculosis dispensaries, Health ministry, Istanbul, Turkey

Introduction

This research has been conducted to determine the status of the stigmatization of tuberculosis patients registered at the tuberculosis dispensaries in İstanbul. Stigmatization results in preconception which in turn leads to discrimination. Discrimination as a result of preconception and stigmatization leads to loss of rights and benefits

These social concepts lead to huge imposition on the patient. This situation places a huge strain on the patients and affects the treatment adversely.

METHOD:

Stigma Scale for Patients with Tuberculosis is used. The Cronbach's alpha coefficient has been found as 0.91. The scale is composed of four sub-dimensions: "Felt stigma, Self-perception, family-friend relationship, internalized stigma".

Without any specific sample selection our research population consisted of active tuberculosis patients and patients who have been completing the treatment in Maltepe and Bahcelievler districts of İstanbul. Study is conducted between 15 of January 2015 to 15 of February 2015. The data have been collected from 186 patients.

The patients, who came to the dispensaries between the dates specified, were included in the research and some of them were reached by phone call. Non-parametric tests such as Mann-Whitney U and Kruskal Wallis were used because parametric conditions were not provided. Statistical significance is accepted as $p < 0.05$

Results

In the study, there was no significant difference for age, sex, education, marital status, and living area variables. For total scale score, patients with complicated treatment condition, patients with pulmonary tuberculosis, patients with low socio-economic status, patients working as employee worker and patients who have not have any tuberculosis relatives at their houses or family environment within the last year have higher median stigma scores which were statistically significant.

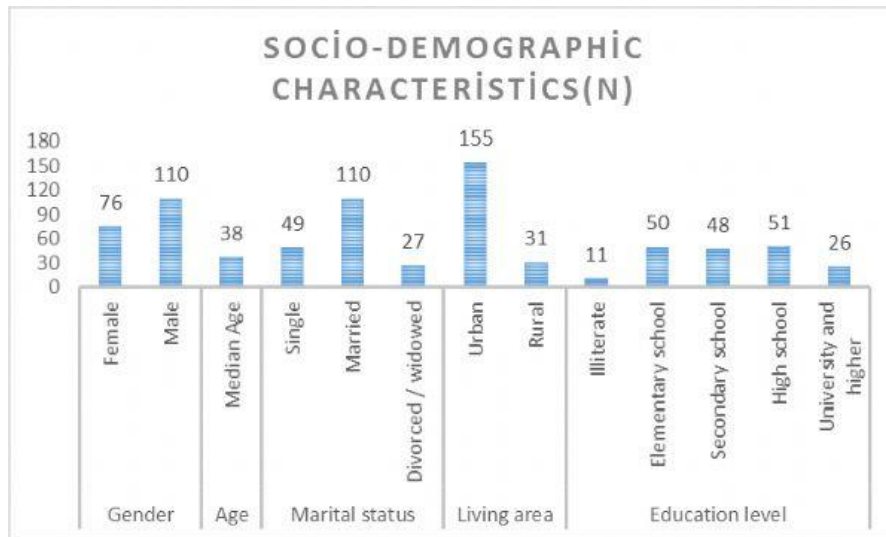
In sub-scales same significant results were also achieved.

Conclusions

Level of stigma was found higher in patients with complicated treatment condition, pulmonary tuberculosis, low socio-economic status, and working as employee.

Keywords: Mycobacterium tuberculosis, Social Stigma, Istanbul

Socio-demographic characteristics of the participants



Socio-demographic characteristics are shown in figure 1 with frequency. Age variable is demonstrated as median.

Overall stigmatization scores for Tb location, income, treatment situation, employment status and having a relative with TB in their house

		Overall Score			p
		Median	Minimum	Maximum	
TB location*	Pulmonary TB	84	58	115	0,001
	Extrapulmonary TB	66	57	104	
	Lower	90	60	114	
Income**	Average	77	57	115	0,001
	Higher	78	78	78	
	Still on ongoing treatment	79	58	115	
Treatment Situation**	Chronic or MDR TB	78	71	90	0,001
	Complicated TB	90	89	114	
	Recovered	70	57	114	
Employment **	Other	87	62	110	0,014
	Own job	78	59	107	
	Regular worker	77	57	115	
Have any tuberculosis relatives at their houses or family environment within the last year*	Officer	83	63	109	0,006
	temporary worker	91	73	114	
	Unemployed	77	60	114	
	No	81	57	115	0,006
	Yes	67	63	89	

* Mann-Whitney U Test is used ** Kruskal-Wallis Test is used

P-1293

"Listening to right hemisphere in primary care consultation"

Silvia Membrilla Pastor

CAP RAMONA VIA. EL PRAT DE LLOBREGAT

BACKGROUND

Interest for the life of the emotions, a land where they have not been educated in general and when difficult situations leads to a difficult management arise.

This led me to take courses for personal growth.

Once the Master of Leadership and personal development ask me to do a presentation where I explain so that has helped me and as I have been able to apply in my work.

TARGET

Capture in my practice my knowledge about the importance of emotions and the right hemisphere in our lives

METHOD

We selected a group of patients who had consulted by physical or emotional problems revealed great emotional distress.

Were treated with standard tools I usually use in the query.

A posteriori test I passed them on as obtained before and after care.

Emotion recognition, prioritization guidelines, enhancing sports and activities contact with the inner Self.

There was a free hand to express creatively their current state, most had already surpassed the state of emotional blockage.

RESULTS

A clear subjective and objective improvement attending to their literal responses and emotions described in the current state. They added pictures, music and inspiring positivity situations.

CONCLUSIONS

A holistic consultation with enough time to explore emotions, to discriminate the physical symptoms that are not organic and provide space support an improvement in the quality of life of patients, and often avoids situations medicalization of emotional disorder (symptomatic treatments explorations... etc). The sensitization of primary care professional in these serious issues essential to achieve this.

Keywords: emotions primary care personal growth

TITTLE



âœœListening to right hemisphere in primary care consultation" Autor: MEMBRILLA PASTOR, SILVIA CAP RAMONA VIA - El Prat de Llobregat ICS (Catalan Institute of Health, Barcelona, Catalonia, Spain)

BACKGROUND

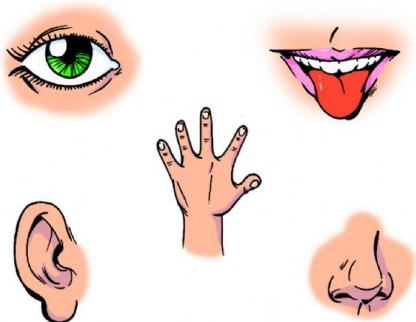


BACKGROUND & AIM: In the last years I did some courses about NLP (Neuro Linguistic Programming), Mindfulness, emotions management, clinical interview and brief psychotherapy techniques, Master of Leadership and Personal Developments by the Barcelona University). Later I wanted offer to my patients in my daily practice all of those knowledges about the importance of emotions and the right hemisphere in our lives, in our symptoms and in our whole wellness

METHODS



METHODS



MATERIAL-METHODS:WHO: We selected a group of patients who had consulted by physical or emotional problems and suffered great emotional distress **HOW ? SKILLS:** Before and after test about own emotions

RECOMMENDATIONS



RESULTS 3

C'est jolie la Bretagne

SPRING PROGRESSION

HANDCRAFT. The same hands touched non real tumors too much worry.. Blessed!!!

la hecho a mano malandras

RESULTS 2

...AFTER ...

LIBERATION
SYMPATHY
RELAX
ORIENTATION

ALSO

CRYING
PAIN

Talk to you she made me think and say enough!
Everything has to flow, face life
Now I see it differently
I can not swim against
I keep getting dizzy EVEN WITHOUT APPARENT REASON

LIGHT

RESULTS 4

MIGUEL was inspired with
I WOULD LIKE TO THANK Dra Membrilla for your attention and professionalism.
My niece two years old for having managed to give me all the joy he had ever imagined CAPACITY AS SOMEONE GIVE HAPPINESS SO SMALL ... THANKS FOR HELP. THANKS A MILLION

MEMA Carpe diem You believe just like you know that I'm a hypochondriac, but not, when a person is not what he wants is to be good to take a good quantity of vida. Sin more receives a warm greeting

Actually, my problem is none, is everything around me is great. There is no more. That had led me to not stop for a minute and wipe cream for the hours so isolating myself and not cope **MEMA**

RESULTS 5

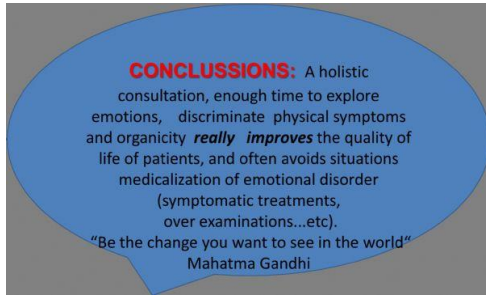
As much as I return
I can not find my memories
The look, the dream,
I already own them.
They fill edges
And the vessel is already full.
And now just trying to escape
I just need to take off.
It was so long dead in the end ALmost confused it with my home

Vetusta MORLA:
La Deriva

Adagietto
Gustav Mahler

SEPTEMBER
4 Letzte
Lieder,
Richard
Strauss,

CONCLUSIONS



P-1294

Prevalence of thyroid cancer in patients referred from primary care to a high-resolution thyroid nodule clinic

Carmen Maria Cortes Salazar¹, Jose Carlos Fernández Garcia², Diana Domínguez Jiménez³, Isabel Mancha Doblas²

¹Primary Care Centre of Badolatosa, Seville, Spain.

²Endocrinology Department, Virgen de la Victoria University Hospital, Málaga, Spain.

³Primary Care Centre of Estepa, Seville, Spain.

BACKGROUND & AIM: Thyroid cancer is the most common endocrine malignancy. In this study we aimed to evaluate the prevalence of thyroid cancer in patients with suspected thyroid nodule referred from primary care to a high-resolution thyroid clinic.

METHOD: Retrospective cohort study which included patients with suspected thyroid nodule referred from primary care to a high-resolution thyroid nodule clinic. Demographic and clinical characteristics were collected, all patients underwent thyroid ultrasound and subsequently, a fine needle aspiration (FNA) was performed if thyroid nodules were >1cm of diameter or if there was evidence of risk factors for thyroid carcinoma (in accordance with American Thyroid Association guidelines).

RESULTS: 987 patients were included in this study. After performing thyroid ultrasound the presence of a thyroid nodule was detected in 79.5% of patients (785 nodules) with a mean nodule diameter of 2±1.15 cm. FNA was performed in 585 nodules (74.5% of all nodules). 11.8% of all cytological samples had suspected malignancy and 2.1% were malignant. Referral for surgery was required in 23.2% of patients (mainly because of nodule size or suspected malignancy). Malignancy was confirmed in 5.6% of thyroid nodules.

CONCLUSIONS: The prevalence of thyroid cancer in this cohort of patients from primary care is 5.6%. Thus, approximately 1 out of 20 thyroid nodules referred from primary care to a high-resolution thyroid clinic is malignant.

Keywords: thyroid cancer, high-resolution thyroid clinic, thyroid ultrasound, prevalence, clinical characteristics

P-1295

UPI's contributions to the education of health students at the Federal University of Vale do São Francisco Foundation in Brazil

Carla Santos Araújo¹, Ana Dulce Batista Santos², Karoline Barros Conceição², Láyla Moanna Araujo Moraes¹, Rafael Nascimento Barreiros³, Rafael De Abreu Maynard¹

¹Department of Medicine, Federal University of Vale do São Francisco Foundation, Petrolina, Brazil

²Department of Nursing, Federal University of Vale do São Francisco Foundation, Petrolina, Brazil

³Circo da Trindade Eventos e Produções LTDA, Olinda, Brazil

Background and Aim

Since Brazilian Unified Health System (SUS) undertakes health as a state duty, it supports its actions in the wider definition of health. Within this new conception, it's necessary to insert SUS principles - completeness, fairness and universality - in daily work. This new model bases the training of health professional on humanizing principles, taking a holistic approach to the needs of users as human beings, beyond the disease.

Thus, extension projects arise within universities, such as the Intensive Clownery Unity (UPI), created in 2011, a clowntherapy student project which aims to promote patient's well-being and to reduce tensions in work environment, enabling SUS experience on a non hospital-centered model.

It is the aim of this paper to report the experience of health courses students on how the UPI contributes to their professional training process. We declare that we have no competing interests related to this presentation.

Method

Reports of 25 undergraduate volunteers about their experience in health care, about what was learned in UPI and their professional education in health.

Results

Participation in the UPI allows students to work their sensitivity and subjectivity, using art as a guide to the reaffirmation of this new health care model, to understand the health practices in a wider way, respecting the complexity of human beings. It leads to the recognition of the project contribution to the formation of the professional profile required by SUS principles UPI also develops in its members a more sensitive vision about interpersonal relationships; promotes integration between the various health courses, respect for knowledge, multidisciplinary integration and teamwork, as recommended by the SUS.

Conclusions

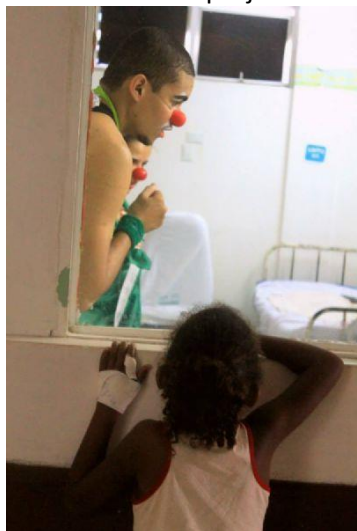
The participation of students in UPI contributes to the formation process of future professionals in accordance with SUS principles and improves the relationships of all involved.

Keywords Brazilian Health System, Clowntherapy, Multidisciplinarity, Health Promotion

Members of the project as clowns in one of the maternities hospitals of the region



Members of the project dressed as clowns in a pediatric hospital



P-1296

Can we trust the results of the urine dipstick for the identification of pyocytes and red cells? Comparison with microscopy

Konstantinia Karakoula, Zoi Tsimtsiou, Antigoni Tsimtsiliakou, Antonis Asimakopoulos, Elpida Efthimiadou, Eirini Litra, Achileas Koureas, Fotini Dantsi

Urban Health Center of Evosmos, Thessaloniki, Greece

Background & AIM: Urine dipstick testing is widely used in Primary Health Care settings. This study aimed in evaluating the sensitivity, specificity, positive and negative predictive values of the examination with dipsticks in identifying pyocytes and red cells in urine.

METHOD: All the results of the urine examinations that took place in the Primary Health Center of Evosmos from January to December 2014 were recorded, along with the gender of the examined patients. The results of the urine dipstick tests were compared with the findings of microscopy of the same urine sediments.

RESULTS: 1716 urine samples were examined. 135 (7.9%) were positive for the pyocytes (enzyme of the leukocyte esterase) and 739 (43.1%) for red cells (method of peroxidase activity of erythrocytes). The sensitivity of the urine dipstick test for the detection of pyocytes (≥ 4 per field) was 28.2%, the specificity 99.6%, the positive predictive value 96.3% and the negative predictive value 79.1%, whereas for the detection of ≥ 12 pyocytes per field the results were respectively 45.7%, 84.8%, 78.5% and 92%. The corresponding values for the detection of hematuria (≥ 3 red cells per field) were 92.6%, 99.5%, 98.6% and 97.4%. When the dipstick found one plus (+) for pyocytes the median value of the pyocytes counted with microscopy was 18 to 20 per field, in two plus (2+) 50 to 60 per field and in three plus (3+) 53 to 60 per field.

CONCLUSIONS: Urine dipstick testing can serve as a useful guide to the physician of Primary Health Care settings, as a screening test or as a diagnostic test, but there are many times that the dipstick results have be correlated with microscopy and clinical parameters, especially for the detection of urinary tract infections.

Keywords: urine dipstick test, pyocytes, hematuria

Evaluation of the sensitivity, specificity, positive and negative predictive values of the examination with dipsticks in detecting pyocytes ≥ 4 per field

Urine Dipstick test-Result	Microscopic detection of ≥ 4 pyocytes per field)	Microscopic detection < 4 pyocytes per field	Sum
+ (positive)	130 (a)	5 (b)	135 (a+b)

- (negative)	331 (c)	1250 (d)	1581 (c+d)
Sum	461 (a+c)	1255 (b+d)	1716

Sensitivity = $a/a+c=130/461=28.2\%$ Specificity = $d/b+d=1250/1255=99.6\%$ Positive predictive value = $a/a+b=130/135=96.3\%$ Negative predictive value = $d/c+d=1250/1581=79.1\%$

Evaluation of the sensitivity, specificity, positive and negative predictive values of the examination with dipsticks in detecting ≥ 4 red cells per field

Urine Dipstick test- Result	Microscopic detection of Hematuria (≥ 4 red cells per field)	Microscopic detection < 4 red cells per field	Sum
+ (positive)	426 (a)	6 (b)	432 (a+b)
- (negative)	34 (c)	1250 (d)	1284 (c+d)
Sum	460 (a+c)	1256 (b+d)	1716

Sensitivity = $a/a+c=426/460=92.6\%$ Specificity = $d/b+d=1250/1256=99.5\%$ Positive predictive value = $a/a+b=426/432=98.6\%$ Negative predictive value = $d/c+d=1250/1284=97.4\%$

P-1297

How "Tweetchats" can be used as a tool to develop online communities and engagement: The #FMChangeMakers Experience

Claire Marie Thomas, [Patrick Reichel](#), Hassna Errami, Harris Lygidakis

#FMChangeMakers, Vasco de Gama Movement

Background/Aims

#FMChangeMakers is an initiative born out of a working group at the Vasco de Gama Movement Preconference of WONCA Europe Conference 2014. Initially, known as #VdGMChangeMakers, the group was formed to develop tools and resources to aid young GPs interested in initiating changes in their local and national health and education systems. The primary communication platform for the group has been social media, most notably our regular tweetchats, and subsequently the #FMChangeMakers movement has been born.

Our aim is to analyse the contribution of tweetchats to the evolution of the #fmchangemakers network to determine the value of further investment in developing the culture of tweetchats, as well as provide possible lessons for other evolving online communities.

Method

We have utilised statistics generated by the Symplur healthcare hashtags project to analyse the reach and impact of the FMChangeMakers hashtag. Cumulative data on impressions, participants and mentions has been evaluated over time and cross-referenced with the dates of tweetchats and other key events.

Results

Each successive tweetchat has directly led to growth in impressions (1,575,485), mentions (1,647) and participants (113). Tweetchats have also contributed to the rapid expansion of our network beyond Europe. There is a variance in the impact of the tweetchats, which is related to the publicity and advertising of each chat. The majority of the tweetchats led to more growth than face-to-face events such as the VdGM Forum.

Conclusions

Tweetchats can be an effective and innovative way to engage, develop and grow an international online community. Their impact is maximised through regular and consistent publicity and advertising and a robust facilitative process. Most notably they present opportunities for expanding dialogue and networks, both globally,

inter-professionally and across the patient/professional divide. Tweetchats are a potentially invaluable tool for advocacy, knowledge sharing and the future development of global family medicine.

Keywords: social media, internet, technological innovation, family medicine, primary care

Details of Tweetchats held

Date	02/11/14	16/11/2014	07/12/14	21/12/2014	04/01/15	01/02/15	15/02/2015
Topic	Improving collaboration between primary and secondary care	Communication skills and patients empowerment	How to improve the image of FM	Professional networking and collaboration (Postponed)	How to develop independent guidelines in FM	How can change benefit patients and family doctors around the world	How to encourage behavioural change in FM (Postponed)
Facilitator	Claire Marie Thomas	Nina Monteiro	Ana Nunes Barata	Yuslanmar Mariani	Claire Marie Thomas	Canan Tuz	Claire Marie Thomas
Hashtag	VdGMchangemakers	VdGMchangemakers	FMChangeMakers (Unregistered)	FMChangeMakers	FMChangeMakers	FMChangeMakers	FMChangeMakers

Date	03/01/15	05/04/15	19/04/2015	03/05/15	17/05/2015	07/06/15	21/06/2015
Topic	How can GPs engage in quality improvement	Medical leadership in healthcare	International collaboration in Primary Care	Patients & physicians burnout	Stigmatisation of GPs	Rural GP/rural health	Rural health connectivity
Facilitator	Ulrich Bak Kirk	Harris Lygidakis	Janine Correia	Sara Rigon	Claire Marie Thomas	Veronika Rasic	Jo Scott-Jones
Hashtag	FMChangeMakers	FMChangeMakers	FMChangeMakers	FMChangeMakers	FMChangeMakers	FMChangeMakers	FMChangeMakers

Join our tweetchats!



Come and join the fun!

Official Logo

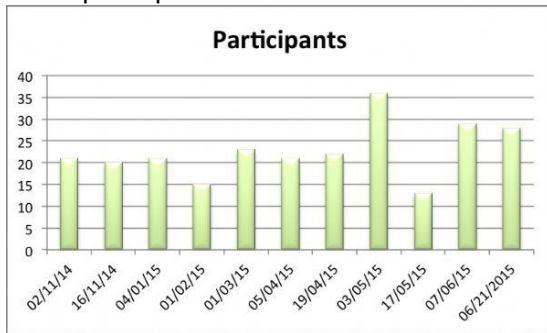


The Original Workshop Participants



The original participants of the workshop team who created the #VdGMChangeMakers concept

Participants per Tweetchat

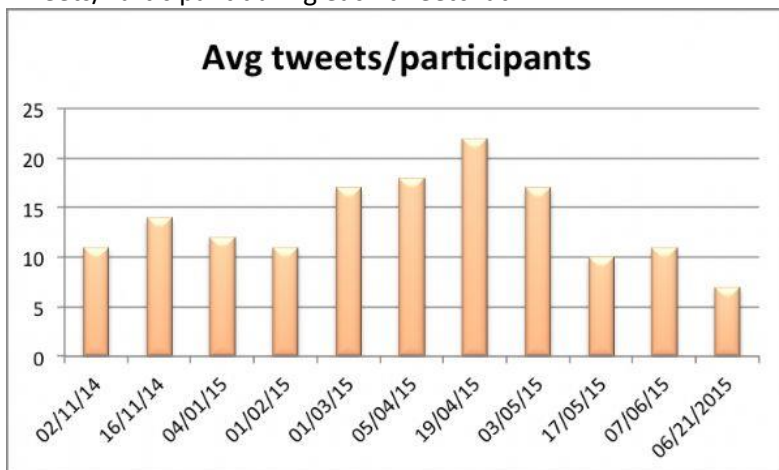


#FMChangeMakers Participants

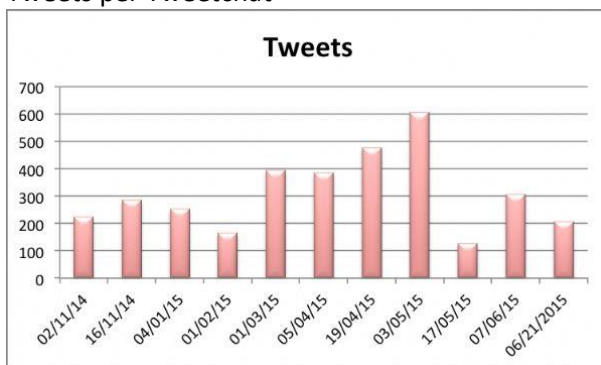
#FMChangeMakers Participants



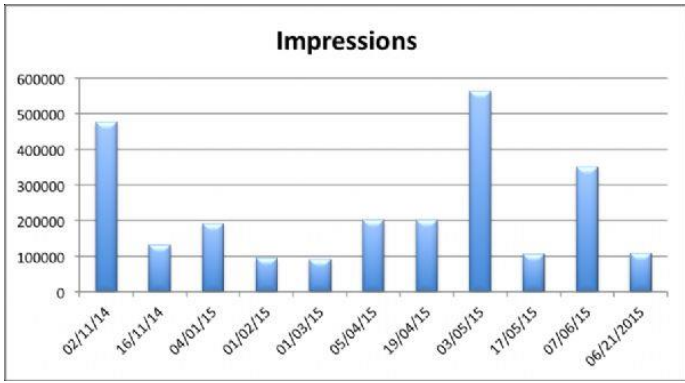
Tweets/Participant during each tweetchat



Tweets per Tweetchat



Impressions Generated during each tweetchat



Cumulative Data

5,398,153 Impressions

6,736 Tweets

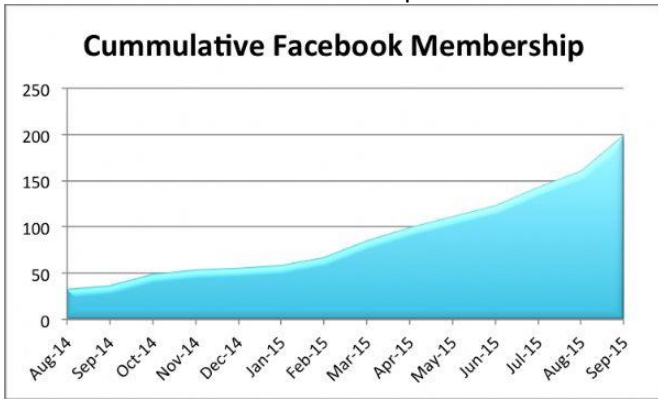
376 Participants

1 Avg Tweets/Hour

18 Avg Tweets/Participant

Cumulative data of the #FMChangeMakers hashtag to date

Cumulative Facebook Membership



P-1298

Cerebral stroke during pregnancy

Alexandru Claudiu Coman, Madalina Daniela Graure, Juana Flores Torrecillas, Florentina Guillen Cavas, Enrique Pagan Dato, Rosa Requena Ferrer
Cartagena Casco Health Center, Cartagena, Spain

Background & Aim

A 30 years-old woman, 6 weeks pregnant, refers a short episode of paresthesia and loss of strength in her upper left arm the day before consulting her General Practitioner. Four days later a similar episode occurs. The first neurological exploration is normal. After the second episode, she presents a slight dysarthria with left central facial palsy and distal weakness mainly at wrist extension. No sensitive alterations. She is remitted to the Emergency room suspecting a stroke.

Method

Complementary tests: Blood analysis is normal. Magnetic nuclear resonance imaging: Acute right basal ganglia stroke. Neurosonology study, Echocardiography, Venous ultrasound, thrombophilia study are negative.

Results

Diagnosis: Acute right basal ganglia stroke

Differential diagnosis: Intracerebral tumor, Intracerebral hemorrhage

Evolution

The patient is admitted to the Neurology Department. Treatment with antiplatelet drugs is installed, with continuous improvement in patient status. Within 24 hours of hospitalization the patient was not presenting neurologic symptomatology.

On the 39th week of pregnancy cesarea section is performed. The patient continues to be asymptomatic.

Conclusions

During pregnancy due to the hormonal changes there is a procoagulant state which increases the risk of venous thrombosis and potential stroke. Ischemic and hemorrhagic events in pregnant women could be due to the increase of risk factors like obesity, diabetes or hypertension.

The general practitioner must prevent the instauration of this risk factors in pregnant women or, if they are already installed, to maintain a close and thorough follow up of these women.

Keywords: pregnancy, paresthesia, stroke

P-1299

What hides behind "nail clubbing"?

Alexandru Claudiu Coman¹, Madalina Daniela Graure¹, Juana Flores Torrecillas¹, Florentina Guillen Cavas¹, Enrique Pagan Dato¹, Rosa Requena Ferrer¹, Emiliano Esteban Redondo²

¹Cartagena Casco Health Center, Cartagena, Spain

²Occupational Health Department, Universitary Hospital Santa Lucia, Cartagena, Spain

Background & Aim

A 63 year-old woman attends her general practitioner for polymyalgia with low fever and asthenia in the last week. Medical history: Smoker. COPD. Hypothyroidism. Right pneumonia in 2009. Hypopharyngeal carcinoma in 2003.

The clinical examination shows diminished vesicular lung sounds and digital clubbing.

Method

Complementary tests:

Blood analysis: Complete blood count was normal. Biochemical: PCR 3.9, VSG 43, TSH 5.38, T4 0.99 Rheumatoid factor 11, Tumor marker: CEA 8.2.

Thoracic radiography: left pulmonary mass

Thoracic CT-scan: 4.8 cm pulmonary mass in the lingula area of the left lung

PET-CT-scan: malignant lung tumor (lingula)

Bone scintigraphy: the right sacrum presents an area of hypercaptation suggesting bone metastasis.

Pneumology Department: the treatment with bronchodilators is increased and the patient is remitted to the Thoracic Surgery Department.

Rheumatology Department: treatment with corticosteroids and analgesics is initiated.

Results

Diagnosis: Lung adenocarcinoma T2a-3N1M1

Differential diagnosis: Pulmonary or digestive neoplasms, Cardiomyopathy

Conclusions

Digital clubbing is a sign caused by a deformity of the fingers and fingernails. It can be an isolated event or part of the hypertrophic osteoarthropathy syndrome. It is associated with neoplasms, mostly intrathoracic, digestive system and cardiovascular diseases. Once detected, the general practitioner should perform a complete physical examination and if necessary, complementary tests considering the severe pathologies that might involve.

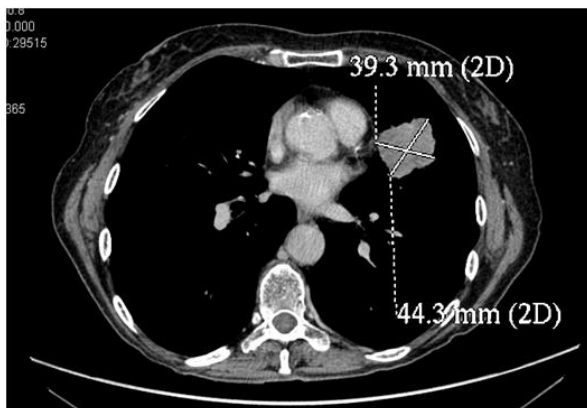
Keywords: hypertrophic osteoarthropathy, neoplasm metastasis, lung neoplasm

1



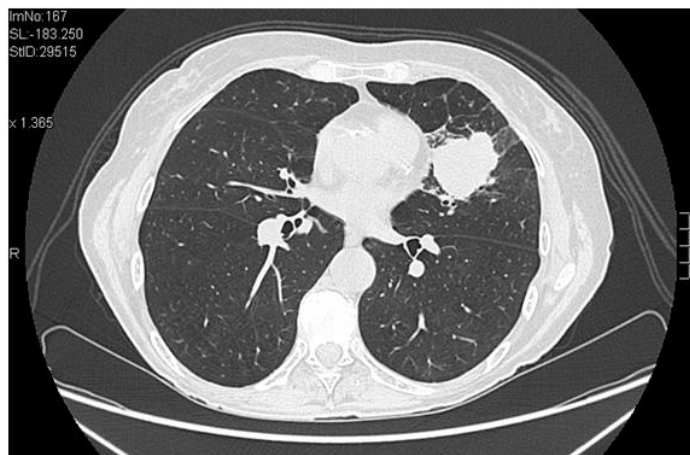
rx

2



CT scan

3



CT scan 2

P-1300

Aspirin in the prevention of recurrent pregnancy loss: what is the evidence?

Susana Sá¹, Joana Castanheira², Margarida Gameiro³

¹Unidade de Saúde Familiar Sem Fronteiras, Agrupamento de Centros de Saúde Entre o Douro e Vouga I, Portugal

²Unidade de Saúde Familiar Fiães, Agrupamento de Centros de Saúde Entre o Douro e Vouga I, Portugal

³Centro Hospitalar Entre o Douro e Vouga, Serviço de Ginecologia e Obstetrícia, Portugal

INTRODUCTION: Recurrent pregnancy loss (RPL) classically refers to the occurrence of three or more consecutive losses of clinically recognized pregnancies prior to the 22th week of gestation. The etiological investigation is important, but it is conclusive in about 50% of couples. An increased production of thromboxane A2 and decreased production of prostacyclin were verified in RPL, which may be the mechanism involved. Aspirin in low doses inhibits the synthesis of thromboxane A2, while preserving vasodilation and antiplatelet effect of prostacyclin.

OBJECTIVES: To determine if there is evidence for the use of aspirin in preventing RPL, compared with other treatments or placebo.

METHODOLOGY: It was made a research in Evidence Based Medicine Databases of articles published between January of 2004 and October of 2014, written in English and Portuguese. The Mesh terms were: "Recurrent miscarriage" AND "Aspirin". We used the Strength-of-Recommendation Taxonomy (SORT) of American Family Physician to established the levels of evidence and recommendation forces.

RESULTS: We identified 52 articles and, of these, selected 9 that met our inclusion criteria: 3 consensus guidelines (CGs), 2 meta-analysis (MA), 3 randomized controlled trials (RCTs) and one cohort study (CS). CGs recommended antithrombotic prophylaxis only in case of Antiphospholipid Syndrome (APS). Just a MA showed some evidence of combination therapy (heparin plus aspirin) in reducing abortions in women with APS and RPL, although not very consistent. The RCTs showed contradictory results. The CS concluded that antithrombotic prophylaxis should only be recommended in APS and RPL.

DISCUSSION: Accordingly to the available scientific evidence, the antithrombotic prophylaxis is not recommended in women with RPL and no history of APS/ Thrombophilias (SORT A). It can be considered, in women with APS and RPL, heparin in prophylactic dose and low-dose aspirin (SORT B).

Keywords: Recurrent pregnancy loss, Aspirin, Antiphospholipid Syndrome

RESULTS



CG	Recommendation	RF
1	Antithrombotic prophylaxis is not recommended in women with ≥ 2 miscarriages and no history of APS/ Thrombophilias	IB
2	Women with unexplained RPL have an excellent prognosis without pharmacological intervention; In APS: consider treatment with low dose aspirin + heparin	B
3	APS: consider treatment with heparin in prophylactic dose with or without low-dose aspirin	B
3	Antithrombotic prophylaxis is not recommended in the absence of APS	A

CS	Population	Intervention	Outcomes	EL
4	Liverpool; n = 636; 1986-2006 ≥ 2 miscarriages before 24 weeks of gestational age (unexplained/ + antiphospholipid antibodies [APA])	Unexplained miscarriage: ASA (n=146) VS ASA + LMWH (n=36) VS Untreated (n=294) Positive APA: ASA (n=98) VS ASA + LMWH (n=62)	Unexplained miscarriage: No significant differences between interventions + APA: Fewer abortions in the 1 st trimester with combined therapy [OR=0.4, CI 95% 0.2-0.7]	2

MA	Description	Intervention and Outcomes	EL
8	8 CRCTs ≥ 2 miscarriages before 24 weeks of gestational age, with or without hereditary thrombophilia	No evidence to support anticoagulation in preventing RPL in women with or without thrombophilia ASA vs Placebo / ASA vs LMWH + ASA / ASA vs ASA + LMWH vs Placebo → No significant difference in the number of live births among groups ASA vs LMWH → The number of live births with LMWH significantly increased only in the subgroup of women with primary recurrent abortion (RR=1.24; CI 95% 1.02-1.49)	1

CRCT	Population	Intervention	Outcomes	EL
6	Libyan; n = 150; Jan/2009 to Dec/2010 ≥ 2 consecutive miscarriages	ASA 75 mg/day (n=75) VS Enoxaparin (0.4mL/day) + ASA (75 mg/day) (n=75)	• Limitations: Unblinded; Without exclusion of thrombophilias/ APS/ endocrine factors; Small sample size • Strong points: Appropriate allocation; No follow-up losses; No statistically significant differences between groups Fewer miscarriages with the combination therapy (29% vs 47%, p < 0.001)	2
7	Iraq; n = 141; Sept/2007 to Aug/2010 ≥ 2 miscarriages before 20 weeks due to APS	Aspirin 100 mg/day (n=61) VS Bemiparin 2500IU/ 0.2mL/day (n=80)	• Limitations: Unblinded; Unclear allocation criteria; Without exclusion of thrombophilias; Small sample size. • Strong points: No follow-up losses; No statistically significant differences between groups Fewer miscarriages with bemiparin (86.25% vs 72.13%; p=0.045; CI 95% 0.08-0.274)	2
8	Netherlands; n = 364; Feb/2004 to Jan/2008 ≥ 2 miscarriages before 20 weeks, unexplained	ASA (80 mg/day) + Nadroparin (2850IU/day) (n=123) VS ASA (80 mg/day) + Placebo (n=123)	• Strong points: Multicenter study/ Sample size/ Appropriate allocation; Well-defined criteria for inclusion/ exclusion; Well-defined outcomes; Evaluation and inclusion of inherited thrombophilias; Double-blind; Intention-to-treat analyses; No statistically significant differences between groups (excluding alcohol, > placebo) No statistically significant differences between the groups regarding the number of live births/ miscarriages, both in the presence and absence of hereditary thrombophilia	1

MA	Description	Intervention and Outcomes	EL
6	6 CRCTs ≥ 2 miscarriages with positive anticardiolipin and lupus anticoagulant	• Unfractionated heparin (UFH) twice day + low-dose ASA appears to be effective in reducing abortions in women with positive APA and RPL without other causes identified • Further studies are needed to prove efficacy of LMWH ASA vs UFH + ASA → Significant reduction in the number of abortions with combination therapy ASA vs LMWH + ASA/ ASA vs Placebo / ASA vs Prednisolone + ASA: No significant differences in the number of abortions among groups.	2

P-1301

Unknown thyroid dysfunction in patients with thyroid nodule

Carmen Maria Cortes Salazar¹, Jose Carlos Fernández Garcia², Diana Domínguez Jiménez³, Isabel Mancha Doblaz²

¹Primary Care Centre of Badolatosa, Seville, Spain.

²Endocrinology Department, Virgen de la Victoria University Hospital, Málaga, Spain.

³Primary Care Centre of Estepa, Seville, Spain.

BACKGROUND & AIM: To evaluate the prevalence of unknown thyroid dysfunction in a cohort of patients with thyroid nodule from primary care.

METHOD: Retrospective cohort study including patients from primary care referred to a high-resolution thyroid clinic. All patients had and ultrasound diagnosis of thyroid nodule. Demographic and clinical characteristics were assessed, and a thyroid blood test was performed (thyroid-stimulating hormone [TSH] and free T4 [fT4]). Patients under treatment con L-Thyroxine or antithyroid drugs were excluded from analysis.

RESULTS: 785 patients were included in the analysis (mean age 48.3±14,3years, women 90.8%). 38.4% out of patients had family history of thyroid disease. 6.7% out of patients had hypothyroidism (5.9% subclinical hypothyroidism) and 0.9% had hyperthyroidism (0.7% subclinical hyperthyroidism).

CONCLUSIONS: In this cohort of patients with thyroid nodule from primary care the prevalence of thyroid dysfunction is elevated. This finding indicates that the determination of thyroid function in patients with thyroid nodule is highly advisable.

Keywords: thyroid dysfunction, thyroid nodule, TSH

P-1302

Don't hesitate to consult

Alexandru Claudiu Coman, Madalina Daniela Graure, Juana Flores Torrecillas, Florentina Guillen Cavas, Enrique Pagan Dato, Rosa Requena Ferrer, Encarnacion Esparza Perez
Cartagena Casco Health Center, Cartagena, Spain

• Background & Aim

A 55 year-old woman consults her general practitioner after noticing a nodule in the region of the neck around 2 months ago. She doesn't refer difficulty while swallowing.

Medical history: No smoker. Dyslipidemia. Menopause at 53 years. Amygdalectomy.

Clinical examination: Right thyroid lobe increased in size, with a nodule of around 1 cm.

• Method

Blood analysis: Cholesterol 272 mg/dl, Cholesterol HDL 88 mg/dl, Cholesterol LDL 172 mg/dl, Triglycerides 59 mg/dl y TSH 4.42 mIU/L, Antithyroglobulin antibody <244, Anti-thyroid peroxidase antibodies negative

Neck ultrasound: Enlarged right thyroid lobe that presents various nodules, the largest around 1.5 cm and two right lateral cervical lymphadenopathies (0.7 and 0.9 cm).

Fine-needle aspiration biopsy: papillary thyroid carcinoma with ganglion metastasis.

Surgery department: total thyroidectomy with extirpation of the lymphatic ganglions of the region.

After the surgery, an ablation with I-131 is performed and treatment with Levothyroxine 100 mg/daily is initiated.

• Results

Diagnosis: Papillary thyroid carcinoma pT3pN1b

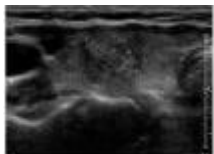
Differential diagnosis: Goiter, Thyroiditis, Lymphoma, Carcinoma

• Conclusions

Thyroid cancer represents the most frequent malignant pathology between the tumors of the endocrine system. It is more frequent in women, around 30-50 year-old. Has a slow developing, with the tendency to metastasize in the cervical lymph nodules, although sometimes affects pulmonary or bone tissues. Prognostic is good, with a survival rate of more than 90% in a 20 years range.

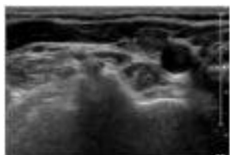
Keywords: thyroid, carcinoma, thyroidectomy

1

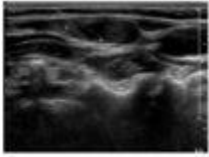


eco

2



eco2



eco3

P-1303

Physical Therapy for Bell's Palsy: effective or unnecessary health care costs?

Susana Sá, Susana Rios, Miquelina Redondo

Unidade de Saúde Familiar Sem Fronteiras, Agrupamento de Centros de Saúde Entre o Douro e Vouga I, Portugal

INTRODUCTION: Idiopathic facial paralysis, also called Bell's Palsy (BP), can dramatically change the life's quality of a person, affecting the eyes, facial expression, speech, chewing and swallowing. Physiotherapy is commonly used in the treatment of BP, with significant associated costs and unclear clinical outcomes.

OBJECTIVES: To determine if there is evidence on the effectiveness of physiotherapy in comparison to other treatments or expectant attitude for the improvement of the signs and symptoms associated with BP.

METHODOLOGY: It was made a research in Evidence Based Medicine Databases of articles published between January of 2004 and March of 2014, written in English, Spanish and Portuguese. The Mesh terms were: "Bell Palsy" AND "Physical and Rehabilitation Medicine". We used the Strength-of-Recommendation Taxonomy (SORT) of American Family Physician to established the levels of evidence (LE) and recommendation forces.

RESULTS: Of the 26 articles found, only 2 randomized controlled trials (RCTs) and one systematic review (SR) respected the established inclusion criteria. The RCTs compares treatment with prednisolone and antiviral drugs (acyclovir or valacyclovir) with or without physiotherapy. Taking into account certain criteria (severity of BP, timing of physiotherapy...), the groups who underwent physiotherapy had better and/or faster clinical recovery (LE 2). The SR includes 12 RCTs, of which only 4 fit the established inclusion criteria. It concludes that, although it seems to exist a more rapid clinical improvement associated with physiotherapy in some studies, the poor methodological quality and the inconsistency of the results can't support the use of physiotherapy in BP (LE 2).

DISCUSSION: There isn't consistent evidence that treatment with Physical Medicine and Rehabilitation is more effective when compared to other treatments or expectant attitude in Bell's Palsy (SORT B). The authors conclude that further studies are needed with rigorous methodologies to obtain more consistent data.

Keywords: Bell's Palsy, Idiopathic facial paralysis, Physical and Rehabilitation Medicine

RESULTS



Reference	Studies	Intervention	Studies description	Results	EL
Systematic Review Teixeira J et al 2010	12 RCTs (only 4 meet the inclusion criteria)	<ul style="list-style-type: none"> Exercises (mime therapy) Electrotherapy / infrared treatment Without treatment Pharmacologic treatment 	Beerskens 2005 •BP - House-Brackmann (HB) IV for at least 9 months •Blinding of assessors •Inadequate allocation •Follow up: 3 months •N=34 •Age=44±14 years-old •Mime therapy vs without treatment	The poor quality of the RCTs and the inconsistency of the results obtained do not support the conclusion that there is significant benefit of physical rehabilitation in Bell 's Palsy	2
			Feres 1996 •Without blinding of assessors •Allocation not described •Follow up: not described •N=149 •Age=33 (5-60 years-old) •Electrotherapy/ infrared treatment vs prednisone		
			Wien 2004 •Without blinding of assessors •Allocation not described •Follow up: 12 weeks •N=145 •Age=45 (7-74 years-old) •Conventional treatment + physiotherapy vs conventional treatment alone •Do not specified the conventional treatment		
			Barbora 2010		

Reference	Population	Intervention	Results	EL
RCT Maurizio Barbora et al 2010	Italy (n=20) (25 - 58 years old) Patients with BP HB ≥ III/VI	All (n=20) Acyclovir 400mg, tid, 15 days + Prednisolone 40mg, bid, 10 days + tapered within the next 5 days Group A (n=10) : Rehabilitation started from day 4 after BP onset, for 21 days Group B (n=10) : Without rehabilitation Group C (n=8) : Patient from Group B, without clinical improvement after 2 weeks from the BP onset; Rehabilitation started from day 15 after BP onset	Group A : the clinical improvement (by HB scale) was statistically significant between the 4 th and 15 th day (p=0,002) and between 7 th and 15 th day of treatment (p=0,04) The differences in terms of clinical improvement between Groups A and B were statistically significant only at 15 th day of treatment (p=0,028) – with better results in the Group A Group C : rehabilitation for 2 months. There was a clinical improvement (by the HB scale): Grade V → III (n=2), Grade IV → III (n=1); Grade IV → II (n=5)	2

Reference	Population	Intervention	Results	EL
RCT Alcoston M et al 2013	Italy (n = 87) (17 - 75 years old) Patients with BP	All (n=87) Prednisone (1mg/kg – 10 days) + valacyclovir (500 mg tid – 6 days) Group A (n=48) Without physiotherapy Group B (n=39) Physiotherapy	Follow up 6 months: 11 dropouts on Group A (23%) Intention-to-treat analysis House-Brackmann Scale •Clinical improvement: Group A: n=36 (75%) and Group B: n=33 (85%) p=0,27 •Stratification by the severity degree: •Grade V/VI → II, in 11 patients from Group A and 17 patients from Group B (p=0,038) •Grade IV → II, in all patients from both groups •The patients of Group B with BP HB V, achieved faster clinical improvement than in Group A with the same HB grade (p=0,04); no statistically significant differences between groups were found in patients with BP HB IV (p=0,44) Sennobrook Scale •There was clinical improvement over the time in both groups (p<0,001) and a greater clinical improvement in Group B, compared to Group A, on 4 th , 5 th and 6 th month (p=0,018, p=0,006, p=0,008 respectively) •Stratifying by the severity according to HB scale: using the SB scale, the differences between groups were only statistically significant in patients with BP HB V and VI (p=0,022) •No significant differences were found between groups for outcome at baseline	2

P-1304

Hidden Causes of Erythema Nodosum

Irene Pérez González¹, María Carmen Fernández Alonso², Sara Nieto Sánchez¹, Aventina De La Cal De La Fuente¹, Claudia Bujedo Ortiz¹, Eva Sierra Quintana¹, Susana Sánchez Ramón³, André Duque Chaux³, Sandra Casado De Andrés¹, Yolanda Silva González⁴, Miriam Martínez Fernández⁵

¹Centro de Salud Casa del Barco, Valladolid Oeste, España

²Gerencia Regional de Salud, Valladolid, España

³Servicio de Urgencias, Hospital Universitario Rio Hortega, Valladolid Oeste, España

⁴Centro de Salud Plaza del Ejército, Valladolid Oeste, España

⁵Centro de Salud José Aguado, León, España

BACKGROUND & AIM:

24 year-old-woman referred history of 6 months of evolution of red nodule in right pretibial location, and recent appearance of left supraclavicular adenopathy. She didn't recount fever or polyarthralgia.

Primary care physician requested blood test and thorax X ray, revealing widened mediastinum and elevated acute phase reactants.

She was admitted to Hematology, for further mediastinum mass study.

METHOD:

-Physical examination: Normal vital signs. Cardiopulmonary auscultation: Regular without audible murmurs; preserved vesicular murmur. Abdomen: depressible, painless, not masses. Left isolated supraclavicular adenopathy. Erythematous plaque on right pretibial surface, without ulceration.

-Blood test: leukocytes 9500/mm³ (81%N;18%); LDH311; PCR30; VSG420; ANA,ECA,ANCA,proteinogram,serology (VIH,VHC,VHB,VHS,VEB,CMV,rubella,toxoplasma,syphilis): negative.

-ThoraxXRy: Widened mediastinum, pulmonary parenchyma not affected.

-Cervico-Thoraco-Abdomino-Pelvic Scanner: Anterior mediastinal mass (5x5cm) suggesting lymphoma.

-Skin Biopsy: Panniculitis involving septa compatible with erythema nodosum (EN).

-Thoracic Adenopathy Biopsy by Mediastinoscopy: Nodular Sclerosis Hodgkin Lymphoma.

RESULTS:

EN related to Nodular Sclerosis Hodgkin Lymphoma.

She received chemotherapy, with complete remission, and has attended to Hematology reviews for 5 years.

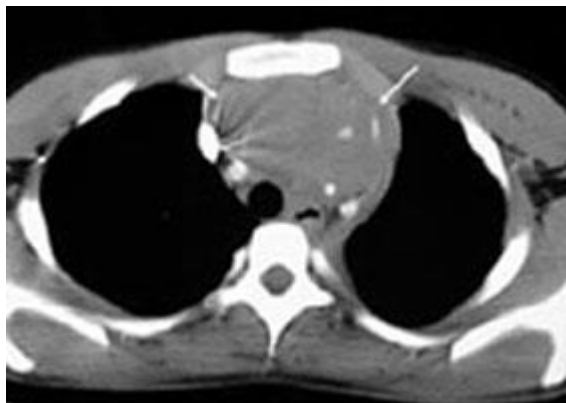
She contacted GP doctor 5 weeks ago because of right pretibial plaque, similar to previous EN, and was sent to Hematology. Several studies have been carried out to rule out different causes of EN, being attributed to pregnancy (gave birth 1 month ago).

CONCLUSIONS:

EN is characterized by red-violet subcutaneous nodules usually developed in pretibial location of women between 15 and 40. EN presumably represents delayed hypersensitivity reaction to antigens associated with infectious agents, drugs, diseases... although pathogenesis is unclear. It's important for primary care physicians to be alert of situations associated with EN (streptococcal pharyngitis, sarcoidosis, tuberculosis, histoplasmosis, Hodgkin Lymphoma, inflammatory bowel and connective tissue diseases, Behcet's and Whipple's diseases, gastroenteritis, pancreatitis, pregnancy, contraceptives, medications, SLE, HIV, syphilis, idiopathic...). Testing recommended to establish presence of associated diseases: blood test, liver enzyme, bilirubin, Antistreptolysin-O titer, serum creatinine and urea, plain chest radiograph, skin testing for tuberculosis.

Keywords: Erythema Nodosum, Hodgkin Lymphoma, Pregnancy

CERVICO-THORACO-ABDOMINO-PELVIC SCANNER



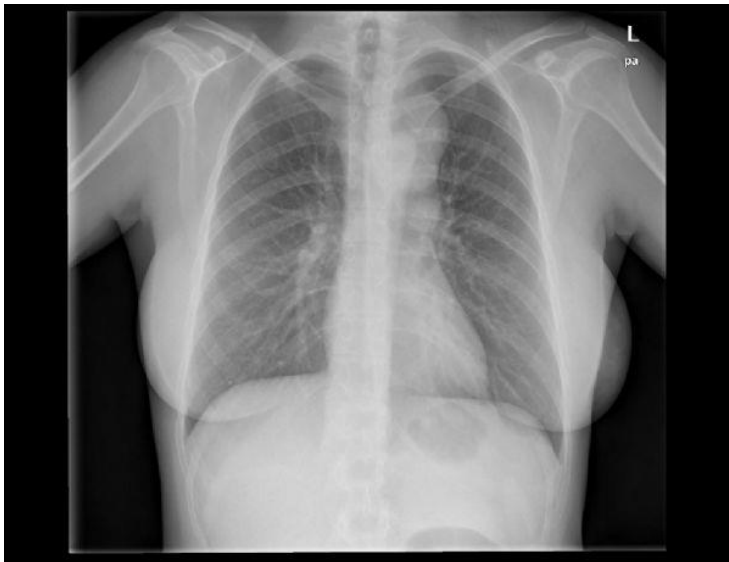
Mass in anterior mediastinum.

ERYTHEMA NODOSUM



Red nodule in pretibial region.

THORAX X RAY



Widened mediastinum.

P-1305

Identifying information needs of people with rare diseases

Svenja Schürerer, Martin Frank, J. Matthias Graf Von Der Schulenburg

Center for Health Economics Research Hannover (CHERH), Institute for Risk and Insurance, Leibniz University Hanover

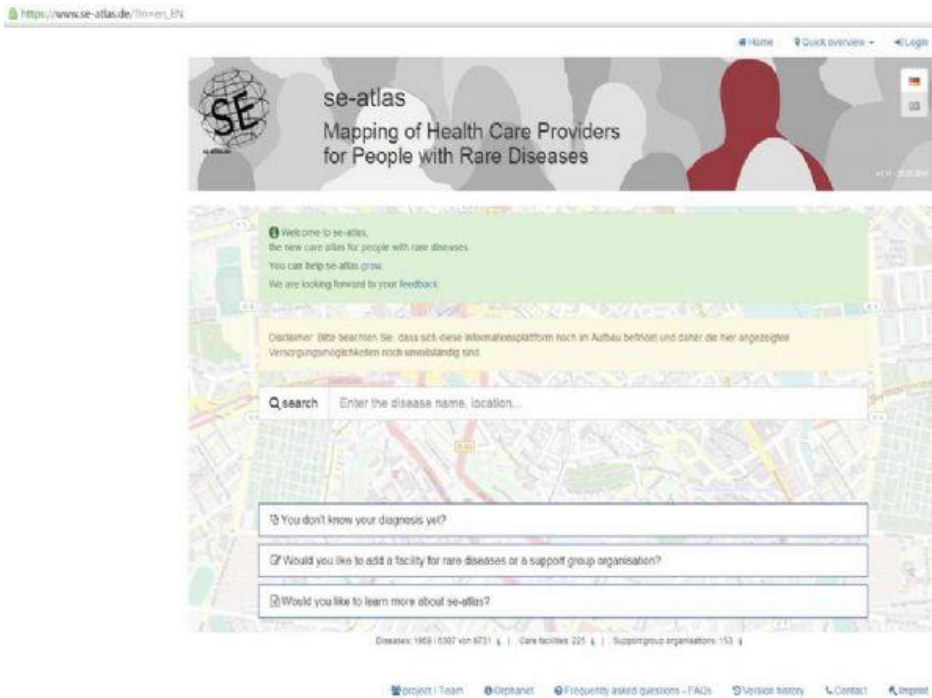
BACKGROUND & AIM: About 4 million people with rare diseases live in Germany. In 2013 a “National Action Plan” to improve patients’ health situation was adopted by the federal government. Establishing information systems is just one component of a broader set of measures to achieve this goal. Because family practitioners are often the first point of contact in patients’ health care, they are of great importance regarding their information needs. Therefore, the object of this study was to identify information needs of people with rare diseases and explore what role general practitioners play in information provision.

METHOD: A guideline for structured questioning was developed in order to detect patients’ experiences regarding diagnosis paths, information needs and information acquisition. Patients from eleven different groups of indications were taken into consideration. The evaluation followed the structured content analysis according to Mayring.

RESULTS: Interviews were conducted with 68 patients and family members. Several information needs could be derived from the interviews. Among other things, these include disease-related topics, regulations in health legislation as well as issues regarding daily life problems. For example, for some people therapeutic treatment options and details concerning disease progression are of potential interest. Moreover, respondents reported that general practitioners have little knowledge about rare diseases so that information had to be acquired from other sources.

CONCLUSION: To ensure an appropriate knowledge transfer for patients with rare diseases as well as their family members easily-comprehensible and needs-based information are required. This information must be adapted to peoples` needs regarding medical information, social law aspects and practical issues in everyday life. Due to the large number of rare diseases family practitioners do not have practical knowledge about all of them, but should be informed about reliable information sources and specialized institutions.

Keywords: Rare diseases, information needs, knowledge transfer, information portal



Experiences from patients and their relatives regarding family doctors



portal-se



P-1306

Weakness and lumbar pain

Paola Lievano, David Idoipe, Alvaro Irigoyen, Jesus Tenias, Carlota Canet, Miguel Lopez Del Pueyo, Sara Lainez, Jose Antonio Ibañez, Laura Urieta, Amparo Cantin, Oscar Zepeda, Miguel Rivas
Community & Family Medicine. Sector III. Hospital Clínico Universitario Lozano Blesa, Zaragoza, Spain.

Background & Aim

Weakness is a frequent nonspecific complaint that includes a wide differential diagnosis which include neurologic disorders and a variety of non-neurologic conditions.

The identification of potential life-threatening neurologic and neuromuscular processes involves a methodical, anatomic approach established upon a medical history, physical examination, and in determines cases, imaging studies.

Method

A case of a 75 year-old man, with weakness and paresthesias since two days ago, back pain, bilateral leg weakness and numbness. Examination shows urinary retention, Lhermitte's sign, hyporeflexia and decreased foot dorsiflexion, inversion and eversion, and mild weakness of leg abduction. He was sent to Emergency Department to study a possible spinal cord compression.

Results

CT and Bone scan show signs of disseminated skeletal metastatic disease and MRI with images of bone metastasis in T7-T8 and prostate asymmetry. Spinal cord compression could not be confirmed. A prostate biopsy evidenced a poorly differentiated adenocarcinoma. Current treatment in Oncology with a palliative treatment of advanced prostate cancer.

Conclusions

Frequent causes of cord compression are tumours, but abscesses and granulomas (e.g. in tuberculosis) are similarly capable of producing the syndrome.

Tumours that generally cause cord compression are lung cancer (oat cell type), prostate cancer, breast cancer, renal cell carcinoma, thyroid cancer, lymphoma and multiple myeloma. It was possible to standing involvement of prostate cancer. An effective and appropriate primary care focus it can be decisive to a right diagnosis.

Keywords: Back pain. Leg weakness. Spinal cord compression. Metastatic disease.

Bone scan 1



Multiple bone metastasis

Bone scan 2



Multiple bone metastasis

P-1307

"{"An Overview to Our Patient Profile "}"

Gülseren Oktay, Ramazan Tetikçok, Nagihan Yıldız Çeltek, Ufuk Ünlü
Department of Family Medicine, Gaziosmanpaşa University, Tokat, Turkey

""AIM: In our study we purposed to increase quality of providing policlinic service and to contribute to the family medicine specialty training by examining the demografic data,reference reasons, diagnoses,reference frequency and coming for checking of patients who refer to the Gaziosmanpasa University of Family Medicine Policlinic.

METHOD: Patients who refer to Gaziosmanpasa University of Family Medicine Policlinic between the date of 01.04.2013 -31.03.2014 were evaluated retrospectively, according to patients' demografic data, reference reasons, diagnoses, reference frequency and coming forchecking.

RESULTS: The avarage age of the patients was 29,436+13.66. Of our patients, 65,5 % were males and 14,3 % were instution staff. 79,06 % of the patients refered once in this one-year period. The most common 3 diagnoses were; 1. Upper respiratory infections, 2. General health examinations and demand health report, 3. Anemia (iron deficiency anemia, vitamin B12 deficiency anemia, etc.).

CONCLUSIONS: Patients who refer for health report and general health examinations are second the most encountered patient group. So, our patient profile is composed of healthy populations frequently. Finally, at the end of family medicine specialty training, it is aimed to graduate doctors who can detect normal and pathologic conditions, and redirect to relatd department when it is necessary. This can be enable only via specialty training which combined family medicine and rotations. "".

Keywords: Family medicine, Medical Record, Diagnosis

Gaziosmanpasa University Medical Faculty Hospital



Gaziosmanpasa University Faculty of Medicine



P-1308

Erectile dysfunction in Portugal: an uncovered reality

Diana Vaz De Miranda¹, Bruno Vaz Silva², Diogo Carvalho³, Vanessa Da Cunha Alejos³

¹Unidade de Saúde Familiar S. Nicolau, Guimarães, Portugal

²Unidade de Saúde Familiar Novos Rumos, Vizela, Portugal

³Unidade de Saúde Familiar Ara de Trajano, Guimarães, Portugal

BACKGROUND:

Erectile dysfunction (ED) is defined by the constant inability to obtain or maintain an erection, allowing sexual activity, for at least 3 months. In Portugal, the prevalence is around 10-48%. This problem remains a taboo, that affects men of any age, with a strong impact in their quality of life.

AIMS:

Determine the number of cases of ED in 3 Portuguese Units of Family Health (UFH) and compare it with the Portuguese reality.

Characterize the patients in terms of age, cardiovascular (CV) risk factors and events, depression and treatment for ED.

METHODS:

Observational, descriptive and transversal study.

The populational sample were male registered in the UFH, aged between 18-75 years-old diagnosed with the code Y07-Impotence NOS of the ICPC2.

Data were gathered in September 2014, from clinical records using the electronic medical record system SAM[®], and the statistical analysis was performed using Microsoft Excel 2007[®].

RESULTS:

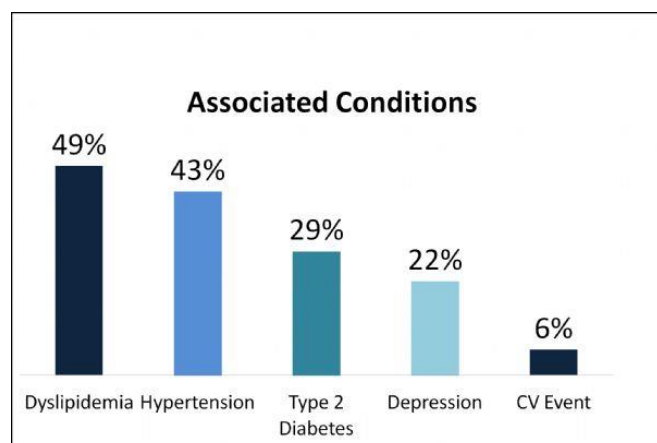
15568 patients were included in the study. The prevalence found was 1,13%, and the average age was 56 years-old. From these individuals, 49% presented with dyslipidemia, 43% hypertension and 29% with type 2 diabetes. 28% of them were smokers, 68% drank alcohol and 76% were overweight/obese. Approximately 6% have had a CV event and 22% present with depression. In 60% of the cases, no pharmacological treatment was prescribed and when it was, Tadalafil was the first choice (59%).

CONCLUSIONS:

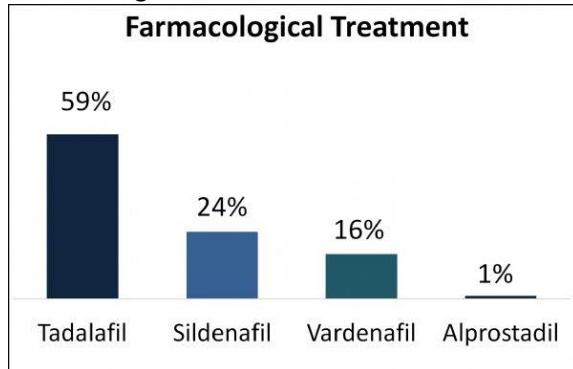
This study revealed a much lower prevalence than the national reality, wich may be explained by the restrain in approaching this pathology or in errors in the clinical registration. A higher prevalence of ED was found in patients over 50 years-old and a high prevalence of CV risk factors were associated with ED, which goes according to literature. It is imperative a reflection on this theme and its correct management in Primary Health Care.

Keywords: Erectile dysfunction, Prevalence, Portugal, Cardiovascular Risk Factors, Treatment

Associated Conditions



Farmacological Treatment



P-1309

Antibiotic Resistance Rates in Enterobacteriaceae Among Syrian Refugees Seeking Health Care in Turkey

Cahit Özer¹, Burcin Özer², Melek Inci², Funda Çimen², Kemal Jenedi², Nizami Duran²

¹Mustafa Kemal University School of Medicine Department of Family Medicine, Hatay, Turkey

²Mustafa Kemal University School of Medicine Department of Medical Microbiology, Hatay, Turkey

Background and AIM:

Hundreds of thousands of people became refugees because of civil war in Syria and moved mostly to cities near to Syrian border in Turkey. Of these, Hatay hosted approximately three hundred thousand people. This gross population movement might have some negative impacts on health of refugees and people in hosting countries. Not only diseases such as malaria, arbovirus infection, blood-borne viruses such as the human immunodeficiency virus, hepatitis but also multiresistant bacteria are a growing concern in these intercountry patients. We aimed to examine the antibiotic resistance rates among Syrian refugees, who sought asylum in Turkey and compare to Turkish patients.

METHODS:

In this cross-sectional study data of samples sent to microbiology laboratory of a university hospital from 2011 to 2013 was retrospectively analyzed. Antibiotic susceptibility rates in Enterobacteriaceae were compared according to nationality.

RESULTS:

Of the samples sent in three years period 1934 bacteria belong to Enterobacteriaceae were isolated. Two hundred forty eight (12.8%) of these were in Syrian. Almost 4/5 of the samples were sent from surgical departments in Syrian, while the ratio was 1/2 in Turkish. 155 (62.5%) of them were wound samples in Syrian, while 416 (64.9%) were urine in Turkish. Most isolated bacteria were Escherichia coli in both groups (66.5% vs. 70.6%).

Most antibiotic resistance rates in Enterobacteriaceae were observed against ampicillin, cefuroxime, ceftazidime, cefepime and ceftriaxone were 93.0%, 84.3%, 82.6%, 79.3% and 78.9% respectively in Syrian, while it was 84.0%, 57.0%, 52.4%, 49.7% and 49.8%, respectively in Turkish. All rates were higher in Syrian patients than Turkish ($p < 0,001$).

CONCLUSIONS:

Antibiotic resistance rates among Syrian refugees were higher than Turkish patients. That might be due to inappropriate use of antibiotics and wound infections during civil war. Transmission of resistance genes between populations should further discussed and studied.

Keywords: refugee health, antibiotic resistance, Enterobacteriaceae, asylum seeker

Antibiotic resistance rates according to nationality

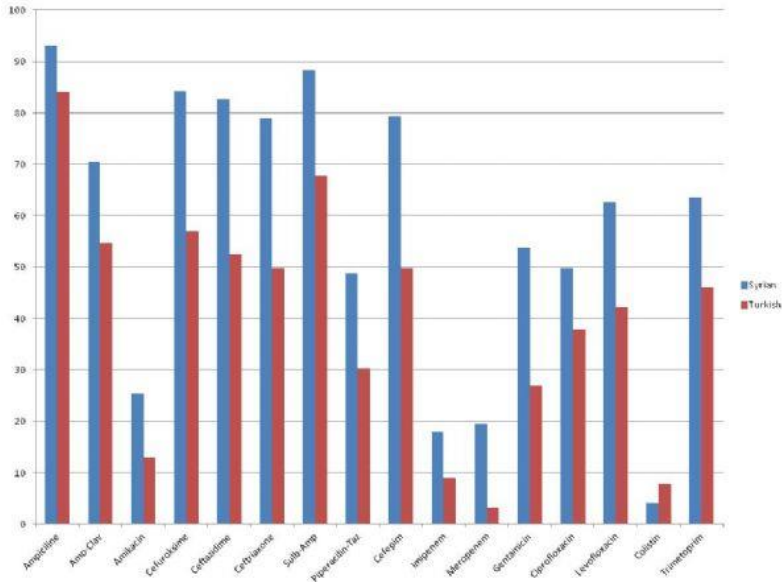


Table 1

Table 1. Samples according to clinics and nationality

Clinics	Syrian n(%)	Turkish n(%)	TOTAL
Surgical	132 (53.2)	796 (47.2)	928 (47.9)
Medical	36 (14.5)	753 (44.7)	789 (40.8)
Surgical Intensive Care Unit	71 (28.6)	57 (3.4)	128 (6.6)
Medical Intensive Care Unit	9 (3.6)	80 (4.7)	89 (4.6)
TOTAL	248 (100)	1686 (100)	1934 (100)

table 2

Table 2. Specimen types according to nationality

Specimens	Syrian n(%)	Turkish n(%)	TOTAL
Wound	155 (62.5)	416 (24.7)	571 (29.5)
Urine	49 (19.8)	1095 (64.9)	1144 (59.2)
Catheter	0 (0)	6 (0.4)	6 (0.3)
Blood	2 (0.8)	1 (0.05)	3 (0.2)
Tracheal aspirate	12 (4.8)	33 (1.9)	45 (2.3)
Vaginal swab	0 (0)	14 (0.8)	14 (0.7)
Cerebrospinal fluid	1 (0.4)	12 (0.7)	13 (0.6)
Bronchial lavage	0 (0)	14 (0.8)	14 (0.7)
Sputum	28 (11.3)	94 (5.6)	122 (6.3)
Peritoneal fluid	1 (0.4)	1 (0.05)	2 (0.10)
TOTAL	248 (100)	1686 (100)	1934 (100)

table 3

Bacteria	Syrian n(%)	Turkish n(%)	TOTAL
Citrobacter	2 (0.8)	7 (0.4)	9 (0.5)
Escherichia	165 (66.5)	1190 (70.6)	1355 (70.1)
Enterobacter	10 (4.0)	62 (3.7)	72 (3.7)
Klebsiella	63 (25.4)	307 (18.2)	370 (19.1)
Morganella	0 (0)	5 (0.3)	5 (0.3)
Proteus	6 (2.4)	89 (5.3)	95 (4.9)
Serratia	2 (0.8)	26 (1.5)	28 (1.4)
TOTAL	248 (12.8)	1686 (87.2)	1934 (100)

table 4

Antibiotics	Syrian n(%)	Turkish n(%)	p
Ampicilline	172 (93.0)	1176 (84.0)	0.001
Amoxicillin/Clavunate	131 (70.4)	163 (54.7)	<0.001
Amikacin	61 (25.3)	216 (13.0)	<0.001
Cefuroxime	156 (84.3)	782 (57.0)	<0.001
Ceftazidime	200 (82.6)	858 (52.4)	<0.001
Ceftriaxone	142(78.9)	691(49.8)	<0.001
Piperacillin tazobactam	116 (48.7)	442 (30.3)	<0.001
Cefepime	195 (79.3)	830 (49.7)	<0.001
Imipenem	44 (17.9)	151 (9.0)	<0.001
Meropenem	48 (19.6)	52 (3.1)	<0.001
Gentamicin	133 (53.8)	444 (26.9)	<0.001
Ciprofloxacin	106 (49.8)	418 (37.8)	0.001
Trimethoprim/sulfamethoxazole	153 (63.5)	768 (46.0)	<0.001

P-1310

VdGM Preconference - Lisbon 2014: the outcomes

Catarina Matias¹, [Ana Nunes Barata](#)², Rita Lopes³, Pedro Azevedo⁴, Nuno Jacinto⁵, Ana Margarida Cruz⁶

¹UCSP Juíz de Fora, Mortágua

²USF Amora Saudável

³USF Ouriceira

⁴USF Fânzeres

⁵USF Salus

⁶USF Bom Porto

BACKGROUND:

The Vasco da Gama Movement organises an annual meeting just a day before the WONCA Europe Conference, in which participants coming from all over Europe have the exceptional opportunity to communicate, convey their own points of view and broaden their horizons while learning from other countries, cultures and contexts.

AIM:

Present the outcomes of this PC, including the mini-exchange that took place.

METHOD:

Study and evaluation about number of mini-exchange and PC participants, as well as the results of a questionnaire distributed to them about the PC's activities.

RESULTS:

We've had 18 mini-exchange participants, and 144 participants: 92 at discussion groups, 29 in the Europe Council meeting, 11 facilitators, 3 speakers, 3 invited VdGM important personalities and 6 organizing committee members.

Participants answered some questions related to how they found about the preconference, their overall satisfaction and the one concerned with facilitators, aspects that were positive and the ones that should be improved.

This results will be presented with graphics and images in the poster.

It was presented de 10th anniversary celebration book of the VdGM as well as the Lisbon's statement from VdGM, according to the discussions that took place on the groups.

CONCLUSIONS:

Participants were very engaged with the goal of the PC and with each other. By the feedback given, it seems like the PC goals were fulfilled, besides the fact there are some points to be improved.

Suggestions for the future:

To give the opportunity to more and more trainees and young GPs to participate in this experience, and to optimize its organization, concerning the participant's needs and a flow work to help future organizing committees.

Keywords: VdGM, Preconference, Outcome

VdGM Preconference, Lisbon 2014



P-1311

Improving the communication by instant messaging in a health centre in Barcelona

Mireia Leal Negre, Carles Alvarado Montesdeoca, Cecilia Doménech Rodríguez, Arantxa Castillejos Ruiz, Cecilia Vidaurreta Gracia

Molí Nou, Institut Català de la Salut, Sant Boi de Llobregat, Barcelona, Spain

Having a well-established communication system is difficult for any business; however, it is key to success in the workplace.

The effectiveness of communication can be diminished by physical, physiological, or psychological noise, which can exist within either the sender, receiver, or channel.

Our health centre is composed by two different buildings and we are continuously interacting between patients, desk workers, general practisers, nurses, and other members of the staff. Something that happens very often is that while we are visiting our patients the process is not as correct as should be because it is being interrupted as the telephone rings or our colleges break into the room because some help is needed, which is very annoying and disappointing for the patient as this interruptions makes them feel that we are not focus on them. So, to improving both communications between the members of the team and with the patient we implemented the office communicator which allows us to communicate and collaborate easily with other members of the team in different locations by instant messaging in our computers and we analysed the results one year after the implementation with an anonymous survey.

The study shows that a 93,75% of our workers use the tool every day while a 6,25 use it weekly. There are no differences in using it by ages or occupational category (General practicers, nurses or desk staff). Office communicator achieve a score of 8,8 out of 10 points, and 81% prefers office communicator to telephone, a 16% prefers telephone and the other 3% does not matter.

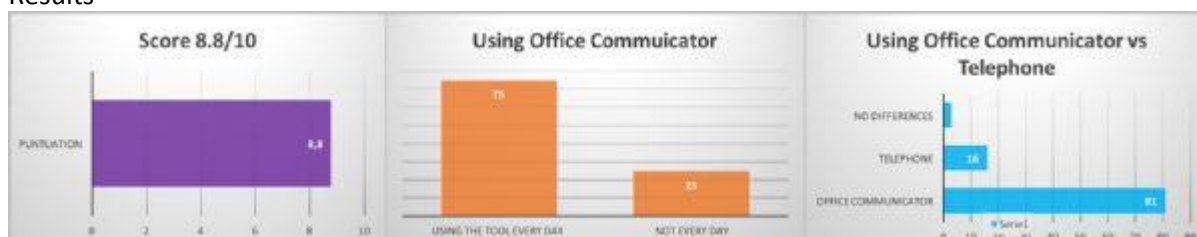
This way of communication has improved both communications, with our patients as the visit is not constantly interrupted by other professionals and with all the staff as it is a quick and non invasive way of talking while we are working.

Keywords: communication, instant messaging, interruptions, health centre

Office Communicator



Results



P-1312

The most common main reasons for patients visiting family medicine doctor

Sedina Bosankic¹, Samira Herenda², Dušanka Becirovic¹, Mirsada Pamukcic Crnogorcevic¹, Senada Hrcic¹

¹Department of family medicine, Health center, Zivinice, Bosnia and Herzegovina

²Department of family medicine, Health center, Tuzla, Bosnia and Herzegovina

INTRODUCTION: doctor visit is every patient contact with the doctor. The main reason is the reason for the visit by the evaluation of a doctor.

OBJECTIVE: To determine the most common reasons patients visit a doctor.

METHODS: The sample consisted of 354 (81 man i 273 woman) patients who during a calendar month visited a doctor. In the form of data collection was recorded each patient visit, the reason for the visit and the number of visits each patient.

RESULTS: A total of 478 visits. Because chronic diseases was 203 (42.47%) visits. A total 100 (20.9%) patients came with the new findings available to the (lab results, specialists) and 61 (12.76%) patient had come for a referral for a check-up at a higher level of care. The next most common reason is pain-22 patients (4,6%) and scheduled check-up – 12 patients (2,5%). All other causes (83 of them) are represented with a total of 17.2%. Most patients (257 to 72.6%) visited the doctor one time, but there were also those who have done it several times (two times occurred 63 (17.8%) patients, by 3 times occurred 20 (5, 65%) patients, 4 had 12 visits (3.39%) patients, and by 5 and 6 had a visit by one (0.28%) patient).

DISCUSSION: The study confirms the fact that the most common reason for doctor visits in Bosnia and Herzegovina chronic disease. Studies in other countries provide a variety of information: National Center for Health Statistics, USA that in the period 2006-2008. shows the main reason for visiting the doctor was acute illness, then prevention activities and chronic diseases are still in third place, research at the Mayo Clinic 2013th shows he of skin disease as the main reason doctor visits.

CONCLUSION: Chronic disease is the main reason for visiting the doctor.

Keywords: doctor visit, main reasons, chronical disease

P-1313

Knowledge and attitude among high school students in West Papua about HIV

Ade Irma P Baibaba¹, Indah Ein F Wainsaf¹, Devi A Iriyanti¹, Florensiana Patiran¹, Marlyn R Ayomi¹, Wisnu G Triwibowo¹, Samuel S Kamale¹, Trianggrid Sara Saa¹, Trevino Aristarkus Pakasi²

¹Faculty of Medicine Universitas Papua

²Division of Family Medicine, Department of Community Medicine, Faculty of Medicine Universitas Indonesia

Background. West Papua as part of Papua Island was high endemic of HIV, which had an impact to general population. It is important to do a promotion and prevention among the young generation to reduce the spreading. The study aimed to describe the existing knowledge and attitude prior to a health promotion done in a high school of Sorong, West Papua.

Method. A questionnaire was distributed to explore their knowledge related with HIV, prevention, and the disease including where to seek medical treatment, prior to a health promotion. The questioned was distributed afterwards to look at the improving knowledge. However this study only reported the first finding.

Result. There were 138 students filling in the questionnaire consist of 40% male and they lived with their parents (87%). About 6% students admitted pre-marital sexual relationship. Only 1 person admitted that had experience using intravenous drug. But 8% of the students were high risk since they were alcohol drinkers. Of all the questions, more than 90% already knew about the spreading of HIV and knew how to prevent it. About 40% only who knew how and where to seek medical treatment when suspected of HIV, and less than 50% knew the health facility, which could provide diagnosis HIV.

Conclusion. Though promotion of HIV has been spread all over West Papua, there were still people in the community who knew where to seek medical care, that might hinder the case finding.

Keywords: HIV, promotion, seeking medical care

P-1314

Reporting an adverse drug event - the case for pharmacovigilance

Luís Pinho Costa, Hélder Sousa

Unidade de Saúde Familiar de Fânzeres, Gondomar, Portugal

Most adverse drug reactions are found only after marketing authorization, stressing the need for pharmacovigilance. By collecting information once the drug is marketed, regulators can protect the population from emerging safety issues throughout a medicine's life cycle. Meanwhile, underreporting of adverse events (AE) is common across countries.

We hereby report two cases.

First, a 32 year old woman within a nuclear family in stage III of Duvall's life cycle; had history of two term pregnancies and had been taking desogestrel for the previous 15 months; informed us she got pregnant while on birth control pills; the couple had not planned but desired it, however feared malformations: due to low back pain she had an x-ray done and took diclofenac for a week, before finding she was pregnant. Pregnancy went without complications and a healthy baby was born.

Second case is a 29 year old woman within a nuclear family in phase II of Duvall's; no relevant medical history besides taking desogestrel+ethinyl estradiol since 2002. Came in due to pain in the lower abdominal quadrants for two days; feared being pregnant. She was requested an ultrasound that showed a ruptured ectopic pregnancy and underwent a laparoscopic salpingectomy with removal of tubal pregnancy. Surgery went without complications but may affect the couple's reproductive future.

In both cases there was no obvious cause for the pills' lack of effect. Absence of contraceptive effect is an AE and was notified; causality was deemed "possible" for the first case, and "probable" for the second.

Family doctors deal with AE regularly. Spontaneous reporting together with case reports/series contribute to a better understanding of drugs' safety profiles and generate the warning signs for possible epidemiological investigations and measures to minimize risks. This work aims to raise awareness among family doctors for their role in this process.

Keywords: Pharmacovigilance, Adverse Drug Reaction Reporting Systems, Drug-Related Side Effects and Adverse Reactions, Contraceptive Agents

The World Health Organization - Uppsala Monitoring Centre (WHO-UMC) causality assessment system

Causality term	Assessment criteria*
Certain	<ul style="list-style-type: none">• Event or laboratory test abnormality, with plausible time relationship to drug intake• Cannot be explained by disease or other drugs• Response to withdrawal plausible (pharmacologically, pathologically)• Event definitive pharmacologically or phenomenologically (i.e. an objective and specific medical disorder or a recognised pharmacological phenomenon)• Rechallenge satisfactory, if necessary
Probable/ Likely	<ul style="list-style-type: none">• Event or laboratory test abnormality, with reasonable time relationship to drug intake• Unlikely to be attributed to disease or other drugs• Response to withdrawal clinically reasonable• Rechallenge not required
Possible	<ul style="list-style-type: none">• Event or laboratory test abnormality, with reasonable time relationship to drug intake• Could also be explained by disease or other drugs• Information on drug withdrawal may be lacking or unclear
Unlikely	<ul style="list-style-type: none">• Event or laboratory test abnormality, with a time to drug intake that makes a relationship improbable (but not impossible)• Disease or other drugs provide plausible explanations

- | | |
|---------------------------------|---|
| Conditional/
Unclassified | <ul style="list-style-type: none"> • Event or laboratory test abnormality • More data for proper assessment needed, or • Additional data under examination |
| Unassessable/
Unclassifiable | <ul style="list-style-type: none"> • Report suggesting an adverse reaction • Cannot be judged because information is insufficient or contradictory • Data cannot be supplemented or verified |

*All points should be reasonably complied with.

P-1315

Clinical equivalence of Generic and Brand-Name Drugs used in Hypertension- a Systematic Review and Meta-Analysis

Ana Paula Fonseca, Isa Cruz, Márcia Soares

USF Cruz de Celas

Background and Aim

Regardless of the bioequivalence between the generic and brand-name drugs, concerns about their clinical equivalence remain unclear. We aim to conduct a systematic review and meta-analysis to summarize the evidence until now, to clarify the efficacy of both groups on blood pressure reduction, cardiovascular events prevention and adverse events rate.

Methods

The Cochrane CENTRAL and MEDLINE were searched to retrieve potential randomized trials, without using any linguistic or time restriction. We used a query that included terms relating to the type of study, drugs and disease of interest. Studies were included if they reported on a comparative evaluation of 1 brand-name drug and at least 1 generic version. Primarily bioequivalent studies were excluded.

A fixed effects meta-analysis was performed, using RevMan v5.2. Pooled results were presented as Mean Difference with 95% CI.

Results

The search done in October 2014 identified 1332 records. After removing overlapping citations and applying our exclusion criteria, 5 studies were included. All were crossover studies, involved 159 hypertension subjects and included Perindopril, Ramipril, Amlodipin, Valsartan and the association Bisoprolol/Hydrochlorothiazide. The systolic pressure Mean Difference between Generic and Brand-name groups was -1.04mmHg (CI 95% -4.04 to 1.97) on the first month and -0.22 mmHg (CI 95% -2.16 to 1.72) on the second month. In the same way, the diastolic pressure Mean Difference was -0.06 mmHg (CI 95% -2.19 to 2.07) on the first month and -0.90 mmHg (CI 95% -0.64 to 2.45) on the second month.

None of the included studies reported cardiovascular events or significant differences in the adverse events presented.

Conclusions

The majority of the studies we identified included small populations and were powerless to assess differences in clinical outcomes. Despite these limitations, our results suggest that it is reasonable for physicians to rely on generic drugs.

Keywords: Generic; Brand-name; Hypertension

Quality appraisal of the included studies

	Random sequence generation (selection bias)	Allocation concealment (selection bias)	Blinding of participants and personnel (performance bias)	Blinding of outcome assessment (detection bias)	Whether reporting (reporting bias)	Withdraw
A.I. Malyhina 2013	Y	Y	N	N	N	N
Martsevich 2013	Y	Y	N	N	N	N
S.Yu. Martsevich 2012	Y	Y	N	N	N	Y
Sang-Hyun K 2009	Y	Y	N	N	N	N
Tsinamdzgvrishvili 2008	N	N	N	N	N	Y

Main features of the included studies.

Study	Methods	Participants	Interventions	Outcomes
S.-H. Kim et al 2009	Randomized trial, cross-over, open-label, 8 weeks	n= 89. Mean age 48,9 years. Mild to moderate hypertension. Korean.	Generic Ramipril (Ramiprin®) or brand-name (tritace®) 5-10mg id. Hydrochlorothiazide if necessary.	Systolic and diastolic blood pressure at 4 and 8 weeks. Adverse events.
S.Y. Martsevich et al 2013	Randomized trial, cross-over, open-label, 18 weeks	n=30. Mean age 62,7 years. Hypertension grades I/II. Russia.	Generic Bisoprolol/Hydrochlorothiazide 6.25/2.5 mg (Bisangil®) or brand-name (Lodoz®). Higher doses(6.25/5mg) or amlodipine 5-10 mg if necessary.	Systolic and diastolic blood pressure at 2,4 and 6 weeks. Adverse events.
A.L. Malyhina et al 2013	Randomized trial, cross-over, open-label, 5 months	n= 40. Mean age 53,8 years. Hypertension grades I/II. Russia.	Brand-name Perindopril 2.5-5 mg (Prestarium A®) or generic 2-4mg (Parnavel®) Indapamide 2.5mg if necessary.	Systolic and diastolic blood pressure at 8 weeks. Adverse events.
S.Y. Martsevich et al 2012	Randomized trial, cross-over, open-label, 20 weeks	n= 30. Mean age 64,9 years. Hypertension grades I/II. Russia.	Generic Valsartan 80mg (Valsartan Valz®) or brand-name (Diovan®). Higher dose (until 160mg) or HTZ 12,5mg or if necessary.	Systolic and diastolic blood pressure at 2,4,6 and 8 weeks.
Tsinamdzgvrishvili et al 2008	Randomized trial, cross-over, open-label, 12 weeks	n= 20. Mean age 51,3 years. Hypertension grades I/II. Georgia.	Brand-name Amlodipine 5-10 mg (Norvasc®) and 2 generics (Normodipina® and Adipina®).	Systolic and diastolic blood pressure at 2 weeks. Adverse events.

P-1316

Organization of a VdGM Preconference step-by-step

Catarina Matias¹, Ana Nunes Barata², Rita Lopes³, Pedro Azevedo⁴, Nuno Jacinto⁵

¹UCSP Juíz de Fora, Mortágua

²USF Amora Saudável

³USF Ouriceira

⁴USF Fânzeres

⁵USF Salus

BACKGROUND:

The Vasco da Gama Movement organises an annual meeting just a day before the WONCA Europe Conference, in which participants coming from all over Europe have the exceptional opportunity to communicate, convey their own points of view and broaden their horizons while learning from other countries, cultures and contexts.

AIM:

To present a work flow concerning the organization of a VdGM's PC, as well as give the possibility to trainees/young GPs to be aware they can be a part of it as volunteers.

METHOD:

We are going to make a short description of the main aspects that an organizing committee has to have in mind in the different parts of the planning and organization process.

We will enhance the fact that more "hands" helping facilitates the process and it is enlightening for all parts: development of communication, organization, team work and leadership skills.

After the inicial description, we will present all the information in algorithm formats in order to make all the process easier.

CONCLUSIONS:

The work flow is now presented and can help other organizing committees in the future.

The algorithm structure can give the organizers a broader idea of all the process in a short time and make them realise it is not an "impossible mission".

This is also gather more trainees/young GPs and make them learn with each other, because they share experiences and ideas together - the VdGM's spirit!

To the future:

Enhance the fact that it is a continuing process: this presentation's aim is to be an inicial tool, that was to be kept updated.

Keywords: VdGM, Preconference, Organization

10th Anniversary VdGM Preconference



P-1317**The Association Between Body Mass Index and Serum Lipid Concentrations in Overweight and Obese Patients**

Nazli Sensoy, Gulsah Sari, Mehmet Yilmaz, Serdar Mingir

Department of Family Medicine, Afyon Kocatepe University, Afyonkarahisar, Turkey

AIM: Obesity is associated with hypertension and dyslipidemia caused by changing eating pattern, life style and activities. The aim of the study is to investigate correlation between body mass index and serum lipid concentrations of participants.

MATERIAL-METHODS: A total of 251 participants were enrolled in this study, which was conducted in Kocatepe University Hospital. In the present study, age, sex, height and weight demographics of participants were gathered, their body mass indexes (BMI) were calculated. According to their BMI participants were divided into 2 groups, overweight (BMI<30 kg/m²) and obese (BMI>30 kg/m²). Serum tryglyseride (TG), total-cholesterol (TC), high density lipoprotein (HDL), low density lipoprotein (LDL) and very low density lipoprotein (VLDL) cholesterol levels were measured in fasting blood samples and compared in both of the groups. For statistical evaluation, data was analyzed using SPSS 18.0 programme. Chi-square test, Kruskal Walls test, and Mann-Withney U test were used for analyses, p levels <0.05 were accepted as statistically significant.

RESULTS: According to our results, the mean of ages was 31.73± 0.75. Of all participants, 37.1% were overweight, 62.9% were obese. We have found that the main factors on obesity were age, occupation, education, marriage. There was statistically significant difference between overweight and obese with respect to the lipid parameter calculations (p<0.05). It was found that TG, TC, LDL, and VLDL values were relatively low in overweight group, however HDL values was high in overweight group in comparison with obese group (p<0.05). There was significant difference between age groups with respect to the lipid parameter calculations. Lipid values were lower in 17-24 ages groups than others ages groups.

CONCLUSION: There were significant differences in serum lipid concentrations between overweights and obese subjects. Because of wrong dietary habits and sedentary life, obesity develops followed by blood lipid abnormalities.

Keywords: Body Mass Index, Obesity, Serum Lipid Concentration

Table 1. Relationship between body mass index and lipid profile in participants

	BMI 25.0-29.9 kg/m ² (n=93)	BMI ≥30 kg/m ² (n=158)	p
FASTING BLOOD GLUCOSE	89.90±6.68	95.67±11,75	0.000
TOTAL CHOLESTEROL	168.48±37.22	180.16±36.96	0.004
HDL	52,35±14,31	48.04±11.76	0.029
LDL	105,20±33,06	117.17±30.74	0.001
VLDL	21,21±16,01	27.41±16.40	0.000
TRIGLYCERIDE	108.99±80.84	138.25±82.19	0.000

P-1318

The importance of self-exploration

Alexandru Claudiu Coman¹, Madalina Daniela Graure¹, Juana Flores Torrecillas¹, Florentina Guillen Cavas¹, Enrique Pagan Dato¹, Rosa Requena Ferrer¹, Emiliano Esteban Redondo², Encarnacion Esparza Perez¹

¹Cartagena Casco Health Center, Cartagena, Spain

²Occupational Health Department, University Hospital Santa Lucia, Cartagena, Spain

• Background & Aim

A 29 year-old male consults his general practitioner for discomfort in the right testicle in the last month, referring a little "bump". No other symptomatology.

Medical history: adenoidectomy. Familiar history: grandmother with uterus cancer, grandfather with urinary bladder cancer, aunt with breast cancer

Physical examination: the palpation of the right testicle was not painful, but there was a nodule of around 2 cm on the superior area. No inflammatory signs. Left testicle was normal.

• Method

Blood analysis: Alpha-fetoprotein (AFP) 1 ng/ml, Beta-HCG 0 mUI/ml, LDH 178 UI/L. The rest was normal
Testicular ultrasonography informs of a solid lesion 2.3X1.9X2 cm in the superior area of the right testicle, impressing of a primary tumor.

The patient is remitted to the Urology department where a surgical treatment is performed (right orchiectomy).

The Pathology report informs of embryonal carcinoma

To evaluate the extension a CT-scan of the thorax, abdomen and pelvis was performed, being the result normal.

• Results

Diagnosis: Embryonal carcinoma PT1N0M0S0 of the right testicle

Differential diagnosis: other testicular tumors, testicular torsion, epididymitis.

• Conclusions

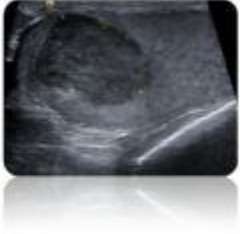
The testicular cancer is the most frequent malignant tumor of the young males. The survival rate at 5 years is around 74 % if it has extension to other organs (faraway), 96% if the extension is at near organs and 99% if it is limited at the testicle. The self-exploration is important because a great number of new cases are discovered by the own patients. The diagnosis is realized through ultrasound, and the extension using the CT and scintigraphy. The biopsy is forbidden due to the risk of dissemination. The blood analysis must include tumor markers.

Keywords: testicular embryonal carcinoma, ultrasonography, orchidectomy

1



2



echo

P-1319

When it's more than lower back pain - A Clinical Case

Diogo Silva¹, Diana Costa Marques², Jenny Duarte², Marisa Batarda², Ricardo Vicente²

¹USF Pedro e Inês, Alcobça, Portugal

²USF Tornada, Caldas da Rainha, Portugal

INTRODUCTION:

Lower back pain is a frequent complaint in Family Practice. More than 84% of adults present lower back pain at some point in their lives. In the majority of cases, these episodes are self-limited and the etiology is mechanical, although other underlying causes may be responsible.

CASE DESCRIPTION:

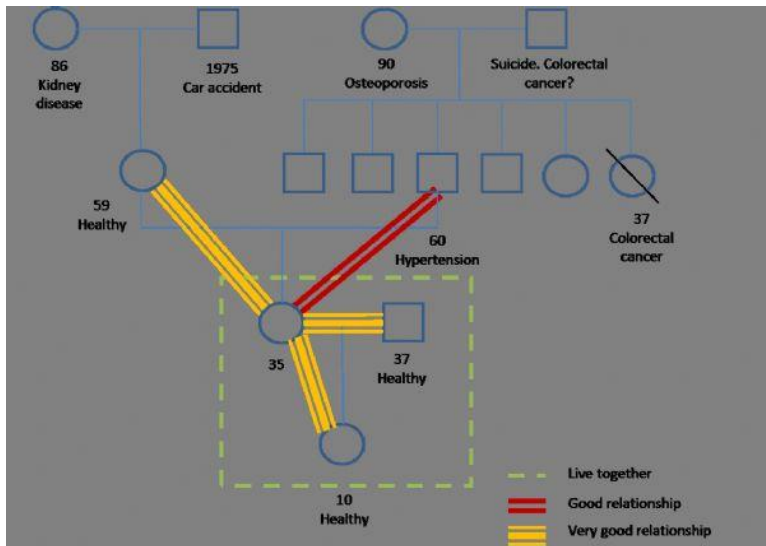
A thirty-five year old Caucasian female, with no previous medical history or any apparent medical indication undergoes both a mammary ultrasound and mammogram. Mammographic findings of the right breast showed a BI-RADS 3 category, recommending follow-up within eight months. Three months later, the patient presents lower back pain and symptomatic treatment is applied, with improvement. As the lower back pain persists, she resorts to an orthopedic physician. After performing various exams, the patient is diagnosed with a poorly differentiated, Invasive Ductal Breast Cancer of the right breast, with lymphatic, axillary and bone metastases and destruction of the L3 vertebral body. Despite undergoing pre-mastectomy chemotherapy and neo-adjuvant radiation, unilateral mastectomy of the right breast and post-mastectomy cycles of chemo-, radio- and hormonal therapy, the patient currently presents metastatic disease of the left scapula and right iliac crest.

DISCUSSION:

Although the majority of lower back pain complaints have a mechanical origin, it is crucial to also have in mind other possible causes, which despite being less common, present poorer prognosis. Moreover, the family physician is instrumental in the management and follow-up during the palliative course and stages of grief of this patient and her family.

Keywords: Lower back pain, Lower back pain etiology, Invasive ductal breast cancer, Breast cancer screening

Mitchell Family Genogram



Nuclear family, Duvall IV, Graffar: middle class, Low familial risk

Exams and Results

DATE	EXAME	RESULT
June/11	Mammogram	Micronodular pattern, of ductal prominence; Microcalcification groupings of the superior quadrant of right breast, one being crude and the others being finer, without secure signs of suspicion, suggesting however, due to the absence of anterior signs, a comparative study. Follow Up with caution within 8 months, to evaluate stability. Right Breast- BI-RADS 3; Left Breast- BI-RADS 2
June/11	Mammary Ultrasound	Small cystic formations, the larger one being elongated and near the left external areolar region
November/11	Magnetic Resonance Image (MRI)	Multiple lesions in T1, T2, D12, L3 and L5 with possible hypothesis of secondary deposits of neoplastic etiology.
December/11	Whole-body Bone Scan	A single bone lesion of the L3 vertebral body, considering as a first hypothesis a predominantly non-fixative /osteolytic lesion of secondary nature.
January/12	PET scan	Hypermetabolic lesions susceptible to: Primary neoplastic lesion of the right breast, with ganglionic disease of the same side; secondary lesions, osteo medullary located, multiple with osteolytic predominance; infracentimetric lesion sited on the liver.
January/12	Biopsy tissue result of right breast	Invasive ductal carcinoma, poorly differentiated (stage 3); Estrogen receptor search: Positive in about 95% of tumoral nuclei; Progesterone receptor search: Positive in about 25% of tumoral nuclei; Immunoreactivity search for HER-2/neu (c-erb-B2) gene and protein: Negative.
April/13	PET scan	De novo lesion of the spinal column as well as the left scapula and right iliac crest.
October/13	MRI	Pulmonary metastases

Case Study Timeline



P-1320

Insomnia: Management in Primary Health Care

Diogo Silva¹, Diana Costa Marques², Jenny Duarte², Marisa Batarida², Ricardo Vicente²

¹USF Pedro e Inês, Alcobaca, Portugal

²USF Tornada, Caldas da Rainha, Portugal

Background & AIM:

Insomnia is the most frequent sleeping disorder in adults and one of the most commonly underdiagnosed medical complaints. Generally it's the family physician whom the patient first resorts to, underlying the fundamental role of primary care physicians in the management of this disorder. The aim of this study is to understand what type of insomnia management is best in primary health care particularly from a therapeutic standpoint.

METHOD:

A bibliographic search was carried out, using Portuguese medical journals, medical databases and the UpToDate search engine, with the terms: insomnia, insomnia management and insomnia in primary health care. Only articles posterior to 2010 were selected.

RESULTS:

Insomnia is a problem that can impair an individual's normal functioning at a social and occupational level, as well during other daytime activities. It can be grouped as acute, chronic or transient insomnia. There are certain factors that increase the risk of developing insomnia as well as specific characteristics that are clinically unique to this disorder. A proper medical anamnesis and physical examination must constitute the patient initial assessment. The association of behavioral therapy with pharmacological treatment seems to demonstrate longer-lasting effects.

CONCLUSIONS:

Being extremely prevalent in primary health care, the adequate management of insomnia by family physicians is fundamental. Some non-pharmacological therapies play a crucial role in insomnia management and should be implemented. The use of drugs should be reserved to situations where non-pharmacological measures prove ineffective.

Keywords: Insomnia, insomnia management, insomnia in primary care, treatment of insomnia

Classification of insomnia

Acute	Chronic	Other types
The symptoms are present for less than 3 months accompanied by significant concern	Symptoms occur at least three times a week and for a period equal to or exceeding three months and not related to an inadequate opportunity for sleep or another sleep disorder	When the criteria do not fit in the other two types
The symptoms may be temporally associated with an identified stress factor		
It disappears when the stress factor is resolved or when the individual adapts to it		

Sleep hygiene recommendations and Stimulus controlling techniques

Sleep hygiene recommendations	Stimulus controlling techniques
<ul style="list-style-type: none"> ✓ Sleep just enough until you feel recovered and then get out of bed 	<ul style="list-style-type: none"> ✓ Go to bed only when sleepy
<ul style="list-style-type: none"> ✓ Avoid looking constantly for hours at bedtime <ul style="list-style-type: none"> ✓ Keep a regular sleep schedule ✓ Avoid forcing sleep 	<ul style="list-style-type: none"> ✓ Do not watch TV, read, eat or talk about concerns while in bed; use the bed only for sleeping or sex
<ul style="list-style-type: none"> ✓ Exercising regularly (at least 20 minutes), preferably 4 to 5 hours before bedtime <ul style="list-style-type: none"> ✓ Avoid caffeinated drinks after lunch ✓ Avoid alcohol close to bedtime ✓ Avoid smoking, especially at night ✓ Do not go to bed hungry 	
<ul style="list-style-type: none"> ✓ Adjust the environment in the room (quiet, dark, safe and comfortable) <ul style="list-style-type: none"> ✓ Deal with concerns before bedtime 	<ul style="list-style-type: none"> ✓ Set the alarm clock to wake up at a fixed time every morning, including weekends
<ul style="list-style-type: none"> ✓ Inform the patient about sleep variation throughout the life cycle 	
	<ul style="list-style-type: none"> ✓ Not perform naps during the day, especially if more than 20-30 minutes or occur in the late afternoon

Therapeutic options in the pharmacological approach of insomnia

Therapeutic options in the pharmacological approach of insomnia			
	Short acting	Triazolam	
Benzodiazepines	Intermediate acting	Estazolam, Lorazepam, Temazepam	Sedative, anxiolytic, myorelaxant and anticonvulsants properties. Decreases sleep latency and the number of nighttime awakenings. Improve length and quality of sleep.
	Long acting	Flurazepam, Quazepam	
Non-benzodiazepines GABA agonists	Zolpidem, zopiclone, zaleplon		Decreases sleep latency and the number of nighttime awakenings. Improve length and quality of sleep. Faster onset and shorter half-lives than the majority of benzodiazepines
Antidepressants	Doxepin		FDA approved at doses of 3 and 6 mg for the treatment of insomnia.
	Amitriptyline, mirtazapine, trazodone		They can be used in the treatment of insomnia when associated with depressive disorder.
Antipsychotics	Quetiapine, olanzapine		They can be used in the treatment of insomnia when associated with psychiatric pathology.
Barbiturics	Phenobarbital, primidone		Not recommended for the treatment of insomnia.
Anticonvulsants	Pregabalin, Gabapentin		Not recommended for the treatment of insomnia in isolation.
Antihistaminics	Not recommended for insomnia treatment. Can trigger psychomotor changes and have anticholinergic effects. Tolerance may developed.		
Melatonin	May be useful in cases where there is evidence of circadian rhythm disorders such as jet lag effect and in patients with reduced hormone levels.		
Melatonin agonists	Ramelteon		Not approved by EMA.
Orexin receptor antagonists	Suvorexant		Approved by the FDA in 2014 but not yet available for clinical use.
Natural products	Valerian		No available studies. Hepatotoxicity? Use is discouraged.

P-1321

Acupuncture therapies for chronic obstructive pulmonary disease

Ana Lopes Ferreira¹, Renata Almeida²

¹USF Santiago, Leiria, Portugal

²USF São Julião, Figueira da Foz, Portugal

Background & AIM: Chronic obstructive pulmonary disease (COPD) is a global health problem increasingly important, one of the major causes of morbidity and mortality. Is projected to be the third leading cause of death in 2030. Some well-designed studies have found a measured prevalence of COPD in Europe between 4% and 10% of adults in 2003. Acupuncture has been used for more than 2000 years to treat respiratory conditions and may treat COPD effectively.

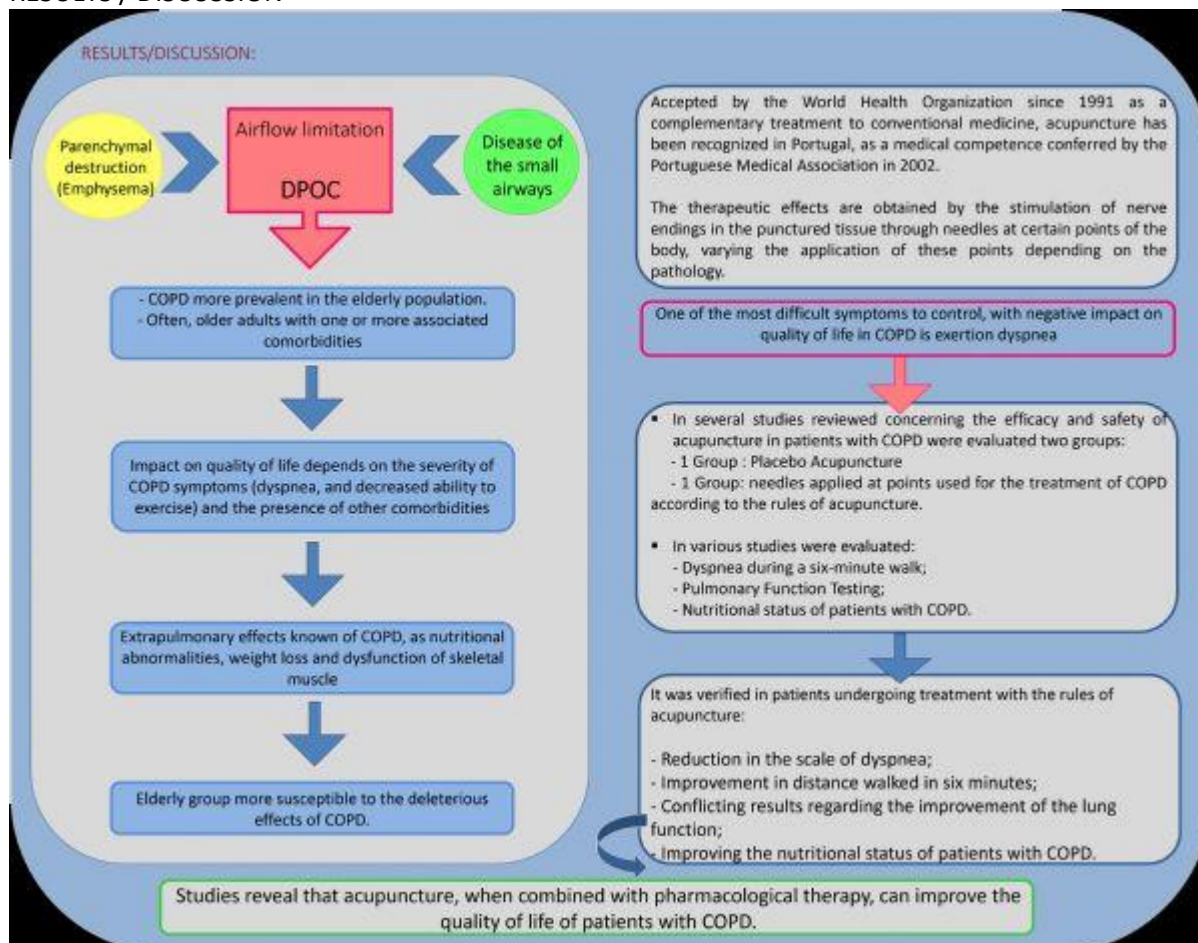
METHOD: The research team made a systematic literature search of scientific articles published in reference databases using the MeSH terms "Acupuncture therapy" and "COPD", of the last 10 years.

RESULTS: The articles found indicate a clinical improvement of dyspnea and quality of life of patients with COPD who performed acupuncture in addition to standard therapy. Other studies have shown that acupuncture can help to improve the nutritional status of patients with COPD, which is an important aspect that influences the prognosis of the disease.

CONCLUSIONS: The review carried out suggests that acupuncture may be an useful complement to standard medical treatment of COPD. However, further studies are needed to be concluded more clearly regarding its benefits, and hence its recommendation in the treatment of COPD.

Keywords: Chronic obstructive pulmonary disease, COPD, Acupuncture therapy

RESULTS / DISCUSSION



P-1322

Gastric cancer, a silent disease

Márcia Soares, Isa Cruz, Ana Paula Fonseca

USF Cruz de Celas, ACES Baixo Mondego, Coimbra, Portugal

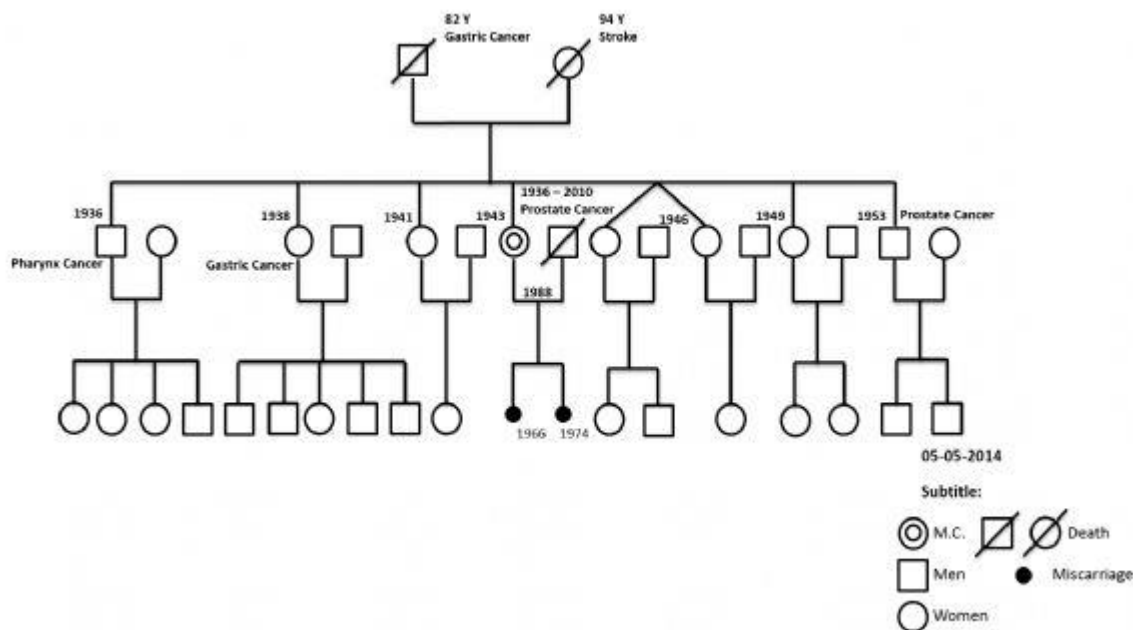
Gastric cancer is the 4th most common cancer worldwide and the 2nd deadliest. Portugal is among the first ten European countries, with the highest incidence and mortality from gastric cancer. This clinical entity in its early stages is, in most cases asymptomatic, whereas in advanced stage of its evolution nonspecific symptoms can be present.

M. C., female, caucasian and widow. Personal history: hypertension, dyslipidemia, overweight and porphyria. Family history: father, 82 years old, passed away with gastric cancer, sister diagnosed with gastric cancer at the age of 68, one brother diagnosed with cancer of the pharynx and the other brother with prostate cancer. In consultation of hypertension surveillance, in April 2014, the patient referred drooling complaint, denying other associated symptoms. The objective examination showed good general condition, normotensive, maintained weight (BMI: 26.8 kg / m²), skin and mucous stained and hydrated and further examination unchanged (particularly, oropharynx, neck, cardiopulmonary auscultation, abdomen). Besides clinical evaluation, an endoscopy was requested, revealing the existence of an "... ulcer in gastric antrum with raised edges and necrotic background of malignant aspect, where biopsy was performed...". The biopsy confirmed the diagnosis of "adenocarcinoma, well differentiated, intestinal type, ulcerated, infiltrating". The patient was at this point referred to surgery consultation, where she is still being followed.

This case reinforces the importance of family background on the context of clinical history, being this, one of the family doctor's task to be attentive to family patterns. In association, monitoring the patient over the years allows us to know the value of clinical complaints, integrated into the patient's personality. In conclusion, gastric cancer is a silent disease, which initial manifestation can be extremely nonspecific, leading sometimes to a late diagnosis.

Keywords: Gastric cancer, family history, family doctor

Genogram of Family



P-1323

A Clinical Case of Acute Hypocalcemia

Jenny Duarte¹, Diana Costa Marques¹, Diogo Silva², Marisa Batarida¹, Ricardo Vicente¹

¹USF Tornada, Caldas da Rainha, Portugal

²USF Pedro e Inês, Alcobaça, Portugal

INTRODUCTION

Acute hypocalcaemia can be a life threatening condition, requiring urgent treatment. However, before therapy can be initiated, it is essential to determine the underlying cause so that specific treatment may be carried out. Clinically, patients may be asymptomatic or develop symptoms and signs such as: paresthesia, positive Trousseau and Chvostek signs, spasms and tetany, ECG changes or seizure. Among the various causes of hypocalcemia, the most common is iatrogenic hypocalcemia after inadvertent removal or disruption of the parathyroid glands during total thyroidectomy.

CASE DESCRIPTION

A sixty-one year old female, seeks her family physician after experiencing muscle cramps of the inferior limbs and paresthesia of the hands and perioral region. Eight days before, the patient had been submitted to a total thyroidectomy due to multinodular goiter and was medicated with levothyroxine sodium. Laboratory work is carried out and reveals hypocalcemia and the patient is sent to the hospital emergency room for intravenous (IV) treatment with calcium carbonate. Two days later the patient returns to the emergency room due to paresthesia aggravation, presenting positive Trousseau and Chvostek signs upon physical examination. The patient is hospitalized, IV treatment is done and after receiving histological results of the thyroidectomized tissue, the presence of parathyroid glands confirms the diagnosis of iatrogenic hypoparathyroidism.

DISCUSSION

Iatrogenic hypoparathyroidism associated with a clinical presentation of acute hypocalcemia is a serious complication that should be suspected in a post-thyroidectomized patient. A thorough anamnesis and physical examination is required in order to differentiate between the various causes of hypocalcemia. In family practice a timely diagnosis is crucial in order to achieve a rapid and correct management of this situation.

Keywords: Acute hypocalcemia, Hypoparathyroidism, Parathyroidectomy

FIGURE 1- Genogram and Mitchell's Psico-figure

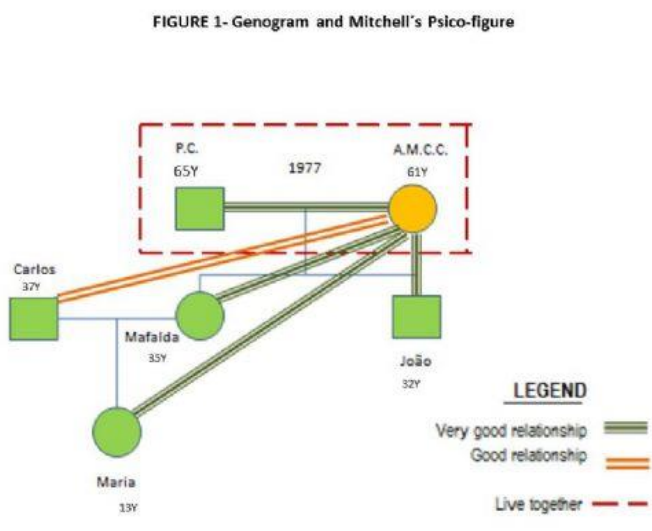
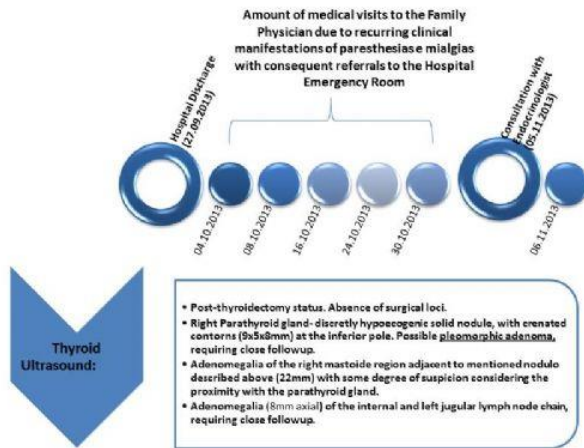


FIGURE 2- Timeline of Clinical Case and Medical Evolution after Hospital Discharge

FIGURE 2- Timeline of Clinical Case and Medical Evolution after Hospital Discharge



P-1324

"I have Macroglobulinemia, and now what?"

Susana Sá, Susana Rios, Miquelina Redondo

Unidade de Saúde Familiar Sem Fronteiras, Agrupamento de Centros de Saúde Entre o Douro e Vouga I, Portugal

INTRODUCTION: The erythrocyte sedimentation rate (ESR) is an analytical parameter which indicates the presence of inflammation. Marked elevations of this parameter should lead to further study, guided by anamnesis and clinical findings. The Waldenström Macroglobulinemia (WM) is a distinct clinical entity characterized by IgM Monoclonal Gammopathy (MG), being asymptomatic in about 25% of the cases. WM is considered incurable and the treatment of asymptomatic patients didn't show benefit in terms of mortality.

Case description: Female, 60 years old. In June of 2009, she recurred to her Family Health Unit and, in the context of the routine consultation, it was prescribed an blood analytical study. In this study, ESR had a value of 89 mm/h. One month after, ESR remained elevated, 94 mm/h. The further study revealed a IgM MG of 26g/L. The patient was sent for additional evaluation in the Haematology Service of the Hospital of the home area. In the course of the study, the patient showed increased anxiety and depressed mood due to the absence of a specific diagnosis. Finally, In April of 2011 the diagnosis of WM was established, but, in the absence of symptoms related to the disease, no treatment was offered. The patient remained anxious, depressed and reluctant in accepting the diagnosis of chronic disease and because of the absence of treatment offered. In March of 2015, the patient is stabilized in relation to her psychiatric health, with acceptance of the disease and reinitiated work activity.

DISCUSSION: The family physician has a crucial role not only in choosing the most appropriate complementary diagnostic exams for their patients, but also in dealing with the abnormal results of these exams. It's crucial not cause harm to the patients, avoiding consequently unnecessary exams. Sometimes, diseases don't have proper treatment, requiring more effort in clarifying and monitoring these cases.

Keywords: Complementary diagnostic exams, erythrocyte sedimentation rate, quaternary prevention

INTERNATIONAL PROGNOSTIC SCORING SYSTEM FOR WM (ISSWM)

INTERNATIONAL PROGNOSTIC SCORING SYSTEM FOR WM (ISSWM)	ISSWM risk factors (sum the nº of factors)		Determine risk category and prognosis			
			Nº of risk factors	Risk category	% of patients	Median survival (months)
	• Age > 65 years (advanced age alone = intermediate risk)		0 or 1 (except age)	Low	27	142
	• Hemoglobin ≤ 11,5 g/dL		Any 2, or age alone	Intermediate	38	99
	• Platelet count ≤ 100 x10 ⁹ /L		≥ 3	High	35	43
	• Serum B ₂ -microglobulin > 3 mg/L					
	• Serum monoclonal protein > 70 g/L					

P-1325

Agomelatine - what is the evidence?

Joana Relva¹, Sara Martins², Sílvia Alves³

¹Canelas Family Health Unit, Canelas, Portugal

²Espinho Family Health Unit, Espinho, Portugal

³Nova Salus Family Health Unit, Vila Nova de Gaia, Portugal

Background & Aim

Major depressive disorder (MDD) is one of the most prevalent diseases in primary health care, responsible for significant demands on service providers in terms of workload and a cause of disability. Therefore, it is urgent to invest in the treatment and prevention of MDD.

Available evidence demonstrates that antidepressants are the elected treatment and that different classes have similar efficacy.

Agomelatine was approved in 2009 in the European Union and has a different and apparently promising mechanism of action, as it is suggested that it improves symptoms by reestablishing circadian rhythm.

The aim of this evidence-based review is to assess agomelatine efficacy in the reduction of MDD symptoms in adults, compared to other antidepressants.

Method

Literature searches were performed in English language publications in several databases - National Guideline Clearinghouse, Canadian Medical Association: practice guidelines infobase, NICE, The Cochrane Library, Bandolier, DARE and Pubmed - from January 2005 to February 2014, using the MeSH terms agomelatine, depressive disorder. Only meta-analysis, systematic reviews, clinical randomized trials and clinical guidelines were included. To establish evidence levels and the strength of recommendation was used the Strength of Recommendation Taxonomy (SORT) scale from the American Family Physician.

Results

The review yielded an evidence base of 107 articles. After application of inclusion/exclusion criteria two meta-analysis were selected. Agomelatine did not seem to provide significant advantage in efficacy compared to other antidepressants (SORT B).

Conclusions

The heterogeneity, different and sometimes contradictory conclusions between published and unpublished studies lead to the conclusion that evidence for agomelatine may be influenced by publication bias. Furthermore, it is necessary to take into account the fact that most of the published studies were sponsored by the pharmaceutical company that manufactures agomelatine.

More studies are necessary to produce high quality data concerning the effects of agomelatine in MDD.

Keywords: agomelatine, depressive disorder, antidepressants

Guaiana G et al, 2013

Population	Intervention	Outcomes	Results	Level of evidence
<p>13 studies (published and unpublished) N = 4495</p>	<p>Agomelatine vs other antidepressants: - Paroxetine - Fluoxetine - Escitalopram - Sertraline - Venlafaxine</p> <p>The patients were followed for a period between 6 and 12 weeks</p>	<p><i>Primary</i></p> <p>- To determine the efficacy of agomelatine in the reduction/resolution of acute symptoms in patients with MDD (response to treatment defined as a 50% reduction score in the HAM-D or Montgomery scale)</p> <p><i>Secondary</i></p> <p>- Assess the acceptability of agomelatine - Assess the tolerability of agomelatine</p>	<p>Agomelatine does not seem to have clinical significant advantages or disadvantages in terms of efficacy for the response or remission during the treatment of acute symptoms of MDD, when compared to other antidepressants.</p> <p>Agomelatine seems to be better well-tolerated than venlafaxine and is similar to SSRIs.</p> <p>Agomelatine is associated with lower rates of dizziness than venlafaxine; and vomit, nausea or sexual dysfunction than paroxetine</p> <p>Inconclusive evidence concerning liver function (apparently with higher risk)</p> <p>Lower rates of drop-out over sertraline and venlafaxine, due to fewer side effects.</p>	2

Taylor D. et al, 2014

Population	Intervention	Outcomes	Results	Level of evidence
<p>20 studies (published and unpublished) N = 7460</p>	<p>Agomelatine vs placebo</p> <p>Agomelatine vs other antidepressants: - Escitalopram - Fluoxetine - Sertraline - Paroxetine - Venlafaxine</p> <p>N = 4559</p>	<p><i>Primary</i></p> <p>Change in rating scale score (HAM-D and Montgomery)</p> <p><i>Secondary</i></p> <p>Response and remission to depression (most defined response as 50% reduction in baseline rating scale measurements and remission as HAM-D ≤7 or MADRS ≤12).</p>	<p>Overall same efficacy of agomelatine comparing with other antidepressants but, individually:</p> <p>- agomelatine was significantly more effective than sertraline</p> <p>- trend for agomelatine to be less effective than paroxetine</p> <p>Published trials generally had more favorable results than unpublished studies.</p>	2

P-1326

Prevalence of pain in a Primary Care clinic consultation. Epidemiological descriptive, observational, retrospective and cross-sectional study

Antonia Espinosa Collado, Miguel Soto Casas

Servicio Andaluz de Salud, Andalucía, España

INTRODUCTION:

The pain, both chronic and acute, is one of the leading causes of healthcare demand. There are few studies that evaluate the real impact in a Primary Care with the rest of pathologies.

Objectives

Primary OBJECTIVE: Percentage of patients reporting pain as a cause of primary consultation and as other current query even if the main pathology.

Secondary objective: the type of pain (acute, chronic, acute or chronic), the source of pain (musculoskeletal trauma, atraumatic, ischemic pain, abdominal, etc) will be evaluated, whether they receive treatment and type of treatment received (paracetamol / NSAIDs, adjuvants, opioids and opioid older children), the use of scales for pain and if, yes, the average pain intensity.

Study design:

It is an epidemiological descriptive, retrospective study, which were collected from the medical history data for processing: Patients who attended the consultation for five days. Technically it is an epidemiological descriptive, observational, retrospective and cross-sectional, not experimental, not Postmarketing single-center study.

RESULTS:

During the analyzed period (5 days) have been a total of 321 patients from a total quota assigned to the Primary Care 1500, corresponding to 21.4% of the total.

Users who presented with pain as the main cause of consultation correspond to 22% of all reported cases. Those with pain as a cause of the current query rise to 42% of the total. Of this group, 43.4% had acute pain, chronic pain 29.4% and 23.5% exacerbation of chronic pain. 22% had no treatment for the pain to get the query and those who came with pain treatment, 79.4% received paracetamol and / or NSAIDs, 46.8% some form of adjuvant, 30, 6% lower opioid and opioid 12.6% higher.

89% of patients with pain has happened VAS scale for assessment of pain intensity. The mean was 6.71 EVA.

Keywords: pain, primary, eva, retrospective, opioid, NSAIDs

P-1327

Approaching asymptomatic microhematuria

Sara Martins, Catarina Fernandes

Espinho Family Health Unit, Espinho, Portugal

Background & Aim

Significant asymptomatic microhematuria (AMH) is a common incidental finding in routine urinalysis and family physicians are frequently the first ones to identify it.

The aim of this review is to provide a clinical framework of the best evidence available for the diagnosis, evaluation and follow-up of AMH in adults.

Method

Literature searches were performed on English language publications in several databases from January 2005 to February 2014, with selected exclusion criteria being applied.

Results

Microscopic urinalysis is the one reliable test for AMH diagnosis.

Careful history, physical and laboratory examination should be performed. After eliminating or controlling benign identifiable causes, microscopic urinalysis should be repeated. When positive, further investigation is necessary. The presence of dysmorphic erythrocytes, cellular casts, proteinuria and elevated creatinine level should raise suspicion for medical renal etiologies. Therefore, nephrologic referral is mandatory.

Contraindications to radiation, contrast media allergies and renal insufficiency should be assessed. To evaluate the upper urinary tract, multiphasic computed tomography (CT) is the elected imaging procedure. If there are contraindications or low risk factors for malignancy, ultrasonography, noncontrast CT or magnetic resonance urography should be an option. In both cases, urologic referral is necessary.

Cystoscopy is the main procedure for lower urinary tract evaluation.

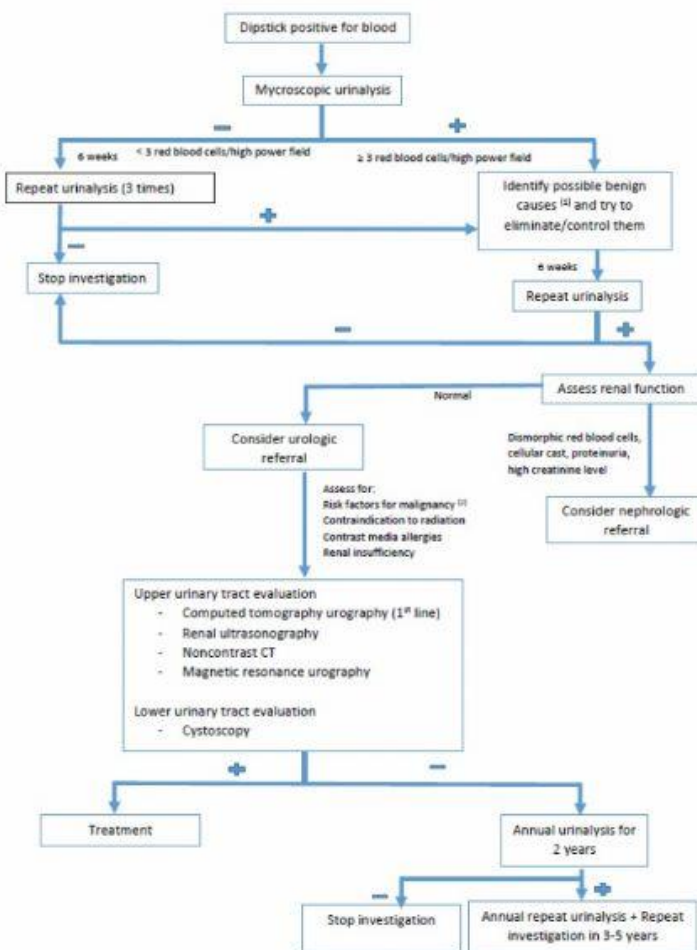
The general accepted timing for follow-up, if appropriate workup does not reveal specific causes, is annual urinalysis for at least two years. If AMH persists, a full repeated evaluation should be considered in three to five years.

Conclusions

There is still lack of evidence to support some of the steps described before. It is necessary to conduct more high quality studies that can clarify the differential radiological evaluation and follow-up timings. Also, one of the priorities should be to clearly define and incorporate a malignancy risk stratification in the clinical framework of the AMH.

Keywords: hematuria; asymptomatic disease; decision making; case management

Algorithm for the investigation of Asymptomatic Microhematuria



(1) More frequent benign causes for AMH

Urinary tract infection

Menstruation

Vigorous exercise

Medical renal disease

Trauma

Urological procedures

(2) Risk factors for malignancy

Age > 35 years

Male gender

History of smoking and/or analgesic abuse

Exposure to chemicals

History of gross hematuria

Chronic urinary tract infection

Exposure to carcinogenic or chemotherapeutic agents

Pelvic irradiation

Urologic disease

Chronic foreign body

P-1328

Renal Cell Carcinoma: Clinical or image. Discussion on the paradigm change of the renal cancer diagnosis approach

Renata Almeida¹, Ana Rita Feirreira², Joana L. Gonçalves¹

¹USF São Julião, Figueira da Foz, Portugal

²USF Santiago, Leiria, Portugal

INTRODUCTION:

Renal Cell Carcinoma (RCC) is about to 2 a 3% of all of the cancers. The incident peak is between 60 and 70 years old, with a ratio of 1,5:1 male to female. More than an half of the RCCs are actually accidentally diagnosed. This is an aspect that has been significantly changed on the approach of these patients during the last decades.

OBJECTIVES:

Literature review of the RCC diagnosis approach.

MATERIALS-METHODS:

Systematic research of the literature guidelines and of the published papers on the last 15 years.

RESULTS:

More than a half of the RCCs are asymptomatic until the diagnosis. Generally, they present small dimensions and in a first stage of evolution; unlike those symptoms of which only 6-10 % displays the classic triad of macroscopic haematuria, flank pain and palpable abdominal mass. Paraneoplastic symptoms (hypertension, weight loss, fever, anaemia) are found in 20-30% of patients with RCC. Since 30% of symptomatic patients already have metastatic disease at the time they are diagnosed. So far there are no screening tests recommended for RCC in people who do not present major risk factors.

DISCUSSION

The RCC is a type of cancer whose diagnosis is particularly difficult to manage during the natural clinical development, RCCs remain asymptomatic and non-palpable for a long period of time. However, in the last decades due to the increased use of imaging techniques, the "accidentally" diagnosis have been increased. It is not

always easy to direct the thinking to the RCC, as is their natural evolution remain asymptomatic for long periods of time, often manifested firstly for many acute situations.

We discuss the implications of diagnostic imaging versus clinical diagnosis.

Keywords: "renal cell carcinoma", "diagnosis", "Clinical", "Image"

P-1329

Congenital afibrinogenemia presenting with hemorrhage during pregnancy

Süheyl Asma¹, Soner Solmaz², Çiğdem Gereklioğlu¹, Aslı Korur¹

¹Başkent University, Department of Family Medicine, Adana, Türkiye

²Başkent University, Department of Hematology, Adana, Türkiye

BACKGROUND: Congenital afibrinogenemia is a rare coagulation disorder with autosomal recessive inheritance. There is a strong association between fibrinogen activity level and the severity of hemorrhage. In this case report, we presented a patient who was admitted with widespread ecchymosis and worsening general condition and diagnosed with congenital afibrinogenemia.

MATERIAL-METHOD: A 25-year-old patient was admitted to our hospital due to widespread spontaneous ecchymosis and poor general condition at 24.week of gestation. No obstetric problems were detected in her initial evaluation however aPTT and INR values were elevated, D-dimer was normal, fibrinogen could not be detected. She was administered fresh frozen plasma, fibrinogen and antibiotic. Rest curettage was applied due to developing vaginal hemorrhage and abortion. Her treatment continued in intensive care unit due to hypoxia and tachycardia, fibrinogen support maintained.

RESULTS: The patient was discharged as hemorrhage did not continue. She is being followed up unproblematically with aPTT >160 sec, INR>11, fibrinogen <0.80 gr/L.

CONCLUSION: Clinical findings of afibrinogenemia varies between minimal and severe hemorrhage. Fibrinogen cannot be detected or minimal in plasma and platelets in afibrinogenemia. Fibrinogen replacement therapy was generally effective in preventing or treating bleeding in doses adequate to achieve and maintain fibrinogen activity above 50-100 mg dL (non-surgical and obstetric use) or 100-200 mg dL (surgical prophylaxis). Obstetric outcomes were optimized when fibrinogen replacement was initiated prior to conception. Uncontrolled hemorrhage, allergic reactions and antibody formation are rare adverse events. Congenital afibrinogenemia should be suggested in patients who have hemorrhage, prolonged PT, PTT. It is of great importance to examine these parameters prior to any surgical intervention.

Keywords: hemorrhage, pregnancy, congenital afibrinogenemia

P-1330

Investigation Of Some Herbal Extracts' Cytotoxicities

Betül Battaloğlu Inanç

Muğla Sıtkı Koçman University, Faculty of Medicine, Family Medicine Department

AIM: Completely using vegetable oils, non-chemicals and non-alcoholic ingredients, an anti-mosquito repellent, non-irritant for skin and environment, was planned to produce. As a first step, our aim was to investigate the renal cytotoxicity of these extracts which will be used as insecticides was aimed.

METHODS: The all-natural oils obtained from the market were used in 100% concentration. Extracts were prepared, cytotoxicity tests were performed at Istanbul University Faculty of Pharmacy, Laboratory of Toxicology. Extracts were applied to rat kidney epithelial cells to determine the cytotoxicity with MTT test (3-4,5-dimethyl-tiazolil-2,5-difeniltetrazolium bromid).

RESULTS: 0.625% concentrations of 1st, 2nd and 3rd extracts' caused cell death in 93%, 89% and 89%, respectively. Their IC50 doses -inhibitory concentration causing a 50% decrease in cell proliferation- were found 0.265%, 0.256% and 0.041%, respectively.

CONCLUSIONS: First of all, 'If it is herbal, it is safe to use' concept must be once more questioned, and they must be very carefully handled especially if these agents will be used for the humans. Under the IC50 concentrations, the extracts were safe in our study. The repelling time of the extracts produced in these values must be investigated and this periods must be clear. Further studies should be performed in order to use these extracts as new insecticid agents with low toxicity on normal cells.

Keywords: Anti-mosquito repellent, natural, human

P-1331

Important Differential Diagnosis Of Back Pain: Metastasis

Fatih Bağcier, Akın Erdal

Atatürk University Faculty of Medicine, Department of Physical Medicine and Rehabilitation, Erzurum

INTRODUCTION: Acute low back pain is one of the most common reasons for people to see a family doctor. Pain may originate from a variety of musculoskeletal tissues or present as referred pain from adjacent pathology, such as peptic ulcers, pancreatitis, pyelonephritis, aortic aneurysm, and more. Although most patients recover with symptomatic care and physical therapy, proper evaluation is imperative to identify rare cases of serious underlying pathology. We aim to present patient who has low back pain, was diagnosed gastric tumor metastasis. CASE: 65 –year-old female patient was admitted to our clinic with low back pain. Pain did not decrease with rest. She had surgery from stomach cancer three years ago. There was no history of trauma and other diseases. On physical examination thoracolumbar junction was sensitive to palpation. Lumbar disc herniation examination was normal. Atypical appearance was observed in the thoracolumbar junction in conventional radiography. Magnetic resonance imaging T12 and L1 level was consistent with the view of metastatic. Scintigraphy revealed an increase in the level of metabolic activity. As a result spinal metastasis of gastric cancer was diagnosed and were referred to medical oncology.

Introduction: Serious, life-threatening diseases are uncommon causes of back pain; malignancy, ankylosing spondylitis. However, missing such a critical diagnosis represents a serious concern for every practitioner; thus complaints of back pain often lead to multiple imaging studies and consultations. In close to 15% of oncology patients, the primary presenting symptoms of malignancy are related to spinal metastases. In these patients, the most common underlying pathology is lung cancer, followed by breast cancer in females and prostate cancer in male patients. In our clinical practice patient who has history of malignancy, presenting with low back pain; spinal metastases should be considered in differential diagnosis.

Keywords: low back pain, metastasis, gastric cancer

Figure 1



Atypical appearance was observed in the thoracolumbar junction in conventional radiography

Figure 2



Magnetic resonance imaging: T12 and L1 level was consistent with the view of metastatic

P-1332

Complex Regional Pain Syndrome: A Case Report

Fatih Bağcıer, Emine Esra Ergül, Ayhan Kul, Meltem Alkan Melikoğlu

Atatürk University Faculty of Medicine, Department of Physical Medicine and Rehabilitation, Erzurum

INTRODUCTION: Complex regional pain syndrome is a symptom complex including severe pain which is disproportioned by the initiating event. It typically affects hand and wrist on the upper extremity. Diagnosis is made according to the history, symptoms and physical findings of the patients. We aim to present patient who has trauma history, had posttraumatic shoulder, hand pain and was diagnosed complex regional pain syndrome.

CASE: 45 year-old male patient was admitted to our clinic because of wrist pain, swelling and limitation of movement. Left forearm of the patient was taken plaster due to the high fracture after falling three months ago. In the physical examination marked edema in the left wrist was observed, while touch was sensitive and joint movement restricted. Conventional X-ray showed osteoporosis in the wrist joints. As a result patients with complex regional pain syndrome was diagnosed. Physical therapy modalities, range of motion, stretching exercises and medical treatment was performed. Patient 's pain reduce and range of motion was normalized.

CONCLUSION: Complex regional pain syndrome is a syndrome that basically contains various traumas in its etiology and the pathogenesis is not fully understood. There are two types of complex regional pain syndrome. Complex regional pain syndrome type 1 (reflex sympathetic dystrophy) occurs after a minor trauma of the extremities whereas type 2 (causalgia) occurs following peripheral nerve injury. Patient education, physical therapy and medical treatment (nsaid, antidepressants, calcitonins, vasodilators, local anesthetics) are effective for treatment. Our patients had a history of trauma and were evaluated as type one. He had seen significant benefit from medical treatment and physical therapy modalities. As a result, in our clinical practice patient who has history of trauma, presenting with severe pain in the hand and shoulder area; complex regional pain syndrome should be in the differential diagnosis

Keywords: wrist pain, shoulder pain, trauma

Figure 1



X- ray: Showing osteoporosis around small joints of the wrist

Avascular necrosis of the knee: a rare case

Fatih Bağcıer, Meltem Alkan Melikoğlu

Atatürk University Faculty of Medicine, Department of Physical Medicine and Rehabilitation, Erzurum

Introduction: Avascular necrosis result of many conditions leading to death of bone cells by the impairment of blood supply. Although associated diseases and conditions (steroid administration, alcoholism, systemic lupus erythematosus, etc.) are well known, avascular necrosis is thought to arise from a multifactorial etiology of mechanical, hormonal and hematologic factors. Although osteonecrosis (ON) is a well-known complication of systemic lupus erythematosus (SLE), the diagnosis is generally delayed. Steroid treatment is considered the major risk factor for the development of ON in SLE. In this report, a patient with SLE who developed avascular osteonecrosis of knee is presented.

CASE: Thirtyfive years old woman who with a known diagnosis of SLE five years was admitted to our clinic with complaints of pain in both knees. Her pain began two weeks ago, there was no history of trauma and accident patients who use hydroxychloroquine day 2x1 posology. Physical examination in both knee medial and lateral epicondyle apparent sensitivity was present. Grade three gonarthrosis was determined in the conventional radiography. Patient's magnetic resonance imaging in both knee osteonecrosis of the femoral diaphysis and distal showing continuity along the medial epicondyle was reported. As a result SLE related secondary osteonecrosis was diagnosed. Twenty sessions physical therapy and medical treatment were underwent. Quadriceps strengthening exercise program was given. Patients were discharged who responded to conservative treatment, decrease in pain and physical examination findings.

CONCLUSION: In patients with systemic lupus erythematosus (SLE) avascular osteonecrosis can occur either because of a complication of treatment (STEROID) or association with antiphospholipid antibody. MRI should be used as first-line diagnostic methods. But may not give finding at an early stage. Early stage it is possible to achieve good clinical results with conservative treatment in patients with secondary osteonecrosis

Keywords: systemic lupus erythematosus, osteonecrosis, steroid

Figure 1



Right knee MRI: bone marrow necrosis and avascular necrosis

Figure 2



left knee MRI: bone marrow necrosis and avascular necrosis

P-1334

Ankylosing Spondylitis Family: A Case Report

Fatih Bağcıer, Ayhan Kul, Mahir Uğur

Atatürk University Faculty of Medicine, Department of Physical Medicine and Rehabilitation, Erzurum

Introduction: Spondyloarthropathies are characterised by inflammation of vertebrae, peripheral joints and periarticular tissues. Diseases in this group present with similar clinical features. Etiology is unknown but genetical tendency, infectious agents and environmental factors may play a role. Among many HLA and non-HLA genes, HLA-B27 plays a major role in its etiopathogenesis. Suggested hypotheses for HLA-B27's role in the pathogenesis of AS can be summarized as presentation of arthritogenic peptides to cytotoxic T cells, those peptides presented to T cells which are derived from HLA-B27 itself being arthritogenic, and inflammation due to specific biological characteristics of the HLA-B27 molecule. Here we aim to present the case two of whom were boys axial ankylosing spondylitis and peripheral ankylosing spondylitis was diagnosed mother in our clinic.

CASE: 30 year old female was admitted to our clinic due to a family history in order to have the HLA-B27 genetic test. Patient had no history of active joint pain patients, back pain, heel pain, psoriasis and inflammatory bowel disease. There was no feature in the CV. Both boys had ankylosing spondylitis in family history. When patients present with genetic results after three weeks had active arthritis in his left ankle. HLA-B27 positive. heel spurs were detected in X-ray. As a result, the patient was diagnosed with peripheral ankylosing spondylitis.

Indomethacin treatment was started in 3x1 posology. Regular follow-up was recommended.

CONCLUSION: Questioning the family history in rheumatic diseases as our case is very important. In our clinical practice, patients who have a family history of rheumatic diseases, physical examination, medical history, and family history of inquiry must be made in more detail. Admission even if they are asymptomatic should be monitored regularly.

Keywords: arhrtitis, HLA-B27, genetic

P-1335

A Rare Etiology Of Atraumatic Chest Pain: Tietze Syndrome

Fatih Bağcıer, Mahir Uğur

Atatürk University Faculty of Medicine, Department of Physical Medicine and Rehabilitation, Erzurum

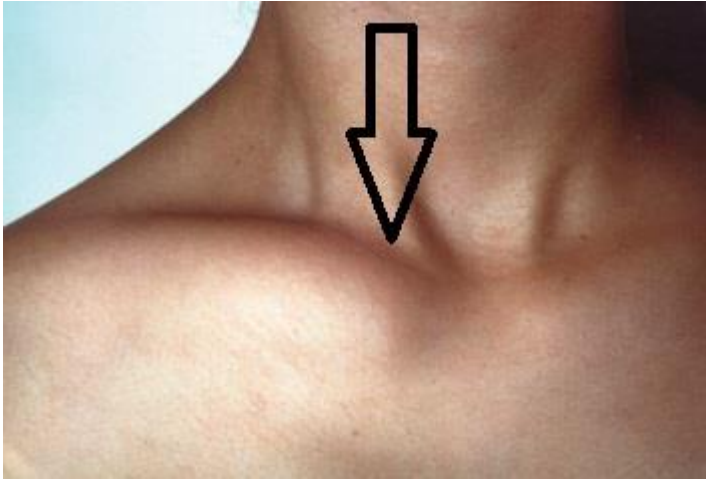
INTRODUCTION: Tietze syndrome(TS) is a benign inflammation of the costal cartilages. The etiopathogenesis of this syndrome is unknown. The diagnosis relies on clinical manifestations and the exclusion of other conditions that affect costal cartilages such as infection, malignancy, relapsing polychondritis and other autoimmune disease processes. We aim to present in this case the patient who has localized chest pain, swelling and diagnosed TS.

CASE: Twentyfive years old college student man was admitted to our clinic with localized pain and swelling in the chest. Patient's who had no known history of trauma, pain was for approximately two weeks. On physical examination, the left sternoclavicular joint redness, tenderness, swelling was observed. Biochemical analysis: Sedimentation: 15mm/saat, CRP: 12 mg / dl, HB: 13,6mg / dL, ALT: 20IU/ml, Creatinine: 0,7mg / dl. RF and ANA were analyzed for differential diagnosis of the autoimmune diseases and resulted in normal. Chest X-ray pathology was detected.Cervical CT showed left sternoclavicular joint narrowing and asymmetry. The patient was diagnosed as TS with these findings. Treatment was begun with nonsteroidal anti-inflammatory drugs. Ten days later in control of paitent who pain and swelling of ongoing, local steroid injection was planned. Pain and swelling reduced significantly and physical examination was normal after injection.

CONCLUSION: TS is characterized by painful non-suppurative swelling of the cartilaginous articulations of the anterior chest wall. This syndrome often mistaken for heart disease. It often results from a physical strain or minor injury, such as repeated coughing, sneezing, vomiting, or impacts to the chest. Patients who have had radiation therapy to the chest/breast will often experience this syndrome which can occur shortly after therapy or years later. Treatment is usually symptomatic. Nonsteroidal anti-inflammatory drugs, ultrasound -guided local steroid injections may effective. Patients who do not benefit from the medical treatment, surgical treatment should be considered.

Keywords: costochondritis, chest pain, Injection

Figure 1



P-1336

Vitamin B12 Deficiency Along With Severe Anemia

Mehmet Temurtaş¹, Havva Üsküdar Teke², Uğur Bilge¹, İlhami Ünlüoğlu¹

¹Department of Family Medicine, Eskişehir Osmangazi University, Eskişehir, Turkey

²Department of Internal Medicine, Eskişehir Osmangazi University, Eskişehir, Turkey

INTRODUCTION: Vitamin B12, which is also known as cobalamin, was first identified in 1948 and subsequently was proved to be effective in pernicious anemia. Vitamin B12 deficiency is an endemic cause for macrocytic anemia and elderly population is one of the risk groups in terms of vitamin B12 deficiency.

CASE: 64-year-old male patient. The patient consulted to the epicenter with malaise during the last one week. The patient was referred to our Hematology clinic after his examination resulted as Hgb:3gr/dl Hct:8,8 % mcv:106 fL plt:52000/mm³. Being monitored for anemia etiology investigation and with hemolytic anemia prediagnosis. He did not have any known chronic disease. In the physical examination, no positive symptom was detected except pallor of skin and conjunctiva and subicteric sclera. The patients' examinations in our hospital were resulted as; Hgb:4,4 gr/dl (after 2 units of erythrocyte suspension replacement) Mcv:100fL Mch:33 plt:30000/mm³ T.bilirubin:2,45 mg/dl D. bilirubin: mg/dl Vit B12:45 pg/ml folat:3,5 ng/ml LDH:4348 IU/L direct coombs (-), reticulocyte:3.35% ret index:0,02. In the abdominal USG, biliary sludge was positive (+) and spleen size was normal, additional findings were not detected. Haptoglobin, Alkaline Phosphatase, uric acid, beta-2 microglobulin levels were in normal ranges. Salmonella and brucella examinations were evaluated as negative. Patient was diagnosed as megaloblastic anemia related to Vitamin B12 deficiency, intramuscular cyanocobalamin and folic acid tablet supplementation were given. Erythrocyte suspension replacement was repeated after further examinations. The patient's general condition were evaluated as recovering and his blood values have increased (hgb:7,5gr/dl). The patient was discharged from the hospital with polyclinic follow-up suggestion.

Keywords: Vit B12 deficiency, Severe Anemia, elderly population

45 Years and Older Patients' Evaluation Of Peripheral Artery Disease With Ankle Brachial Index And Of Quality Of Life With Sf-36: Reliability And Validity Study Of WIQ

Ayla Kara¹, Nilgün Özçakar²

¹Ağlasun Family Health Center, Ministry of Health of Turkey, Burdur, Turkey

²Dokuz Eylül University, Medical Faculty, Department of Family Medicine, Izmir, Turkey

Background&AIM: It was aimed to assess Peripheral Arterial Disease (PAD) with Ankle Brachial Index (ABI) and quality of life with the SF-36 and determine the validity and reliability of Turkish "Walking Impairment Questionnaire" (WIQ).


METHOD: Volunteered 283 participants at a family health center in Izmir Balçova participated in this research. Following the history and physical examination methods by the researcher; ABI values were calculated, determining whether peripheral arterial disease (PAD) and the quality of life were evaluated with scale of the SF-36. By applying WIQ, adapted to Turkish, questionnaire twice with an interval of 2-4 weeks, test-retest analyzes were conducted. And SF-36 was calculated for the relationship between WIQ validity, internal consistency, Cronbach's alpha was calculated. SPSS 15.0 software was used for analysis and p <0.05 was considered significant.

RESULTS: The 11.7% of the patients (33) is found ABI <0.90 is considered as PAD. WIQ compared with SF-36 physical function subscale the relationship was strong, the emotional subscale had weak role and the other subscales were moderately correlated. Cronbach's alpha for internal consistency WIQ the total score was 0882.

CONCLUSIONS: As a result of this study; Turkish version of WIQ was found to be a reliable, valid clinical tool for the assessment of the decrease in walking function of patients with peripheral arterial disease.

Keywords: Peripheral Arterial Disease, Ankle brachial index, WIQ, SF-36

Walking Impairment Questionnaire



Walking Impairment Questionnaire (WIQ)

Patient Name: _____

Tacoma (253) 572-7320
 Puyallup (253) 841-4347
 Lakewood (253) 588-7778
 Gig Harbor (253) 851-0404
 Covington (253) 630-3300

Date of Birth: _____

Walking Impairment: These questions ask about the reasons why you are having difficulty walking. We would like to know how much difficulty you had walking during the past week. By difficulty, we mean how hard it was or how much physical effort it took to walk because of each of these problems.

Peripheral Arterial Disease (PAD) Specific Questions

		Degree of Difficulty				
		None	Slight	Some	Much	Very
Pain, aching or cramps in your calves or buttocks?	Right Leg	4	3	2	1	0
	Left Leg	4	3	2	1	0
	Both Legs	4	3	2	1	0

Differential Diagnosis

	Degree of Difficulty				
	None	Slight	Some	Much	Very
1. Pain, stiffness or aching in your joints (ankles, knees or hips)?	4	3	2	1	0
2. Weakness in one or both of your legs?	4	3	2	1	0
3. Pain or discomfort in your chest?	4	3	2	1	0
4. Shortness of breath?	4	3	2	1	0
5. Heart palpitations?	4	3	2	1	0
6. Other problems (please list)	4	3	2	1	0

Walking Distance: Report the degree of physical difficulty that best describes how hard it was for you to walk on level ground without stopping to rest for each of the following distances during the last week.

Distance

	Degree of Difficulty				
	None	Slight	Some	Much	Very
1. Walking indoors such as around your home?	4	3	2	1	0
2. Walking 50 feet?	4	3	2	1	0
3. Walking 150 feet (1/2 block)?	4	3	2	1	0
4. Walking 300 feet (1 block)?	4	3	2	1	0
5. Walking 600 feet (2 blocks)?	4	3	2	1	0
6. Walking 900 feet (3 blocks)?	4	3	2	1	0
7. Walking 1500 feet (5 blocks)?	4	3	2	1	0

Walking Speed: Report the degree of difficulty that best describes how hard it was for you to walk one city block on level ground at each of these speeds without stopping to rest during the last week.

Speed

	Degree of Difficulty				
	None	Slight	Some	Much	Very
1. Walking one block slowly?	4	3	2	1	0
2. Walking one block at an average speed?	4	3	2	1	0
3. Walking one block quickly?	4	3	2	1	0
4. Walking or jogging one block?	4	3	2	1	0

Stair Climbing: For each of these questions, report the degree of physical difficulty that best describes how hard it was for you to climb stairs without stopping to rest during the past week.

Stairs

	Degree of Difficulty				
	None	Slight	Some	Much	Very
1. Climbing one flight of stairs?	4	3	2	1	0
2. Climbing two flights of stairs?	4	3	2	1	0
3. Climbing three flights of stairs?	4	3	2	1	0

3/22/07 wk - New Pt

Walking Impairment Questionnaire Comparison of Test-Re-Test Mean Scores

Table. Walking Impairment Questionnaire Comparison of Test-Re-Test Mean Scores

WIQ subscales		Walking Impairment Questionnaire Mean Scores					
		Test Mean±SD	ReTest Mean±SD	r	p	t	p
Subscales	Distance Score	60.23±39.11	59.76 ±38.03	.922	.000	0.220	0.826
	Speed Score	55.07 ±26.46	61.71 ±25.18	.848	.000	-3.297	0.002
	Stairs Score	60.92 ±32.84	63.33 ±33.46	.897	.000	-1.133	0.263
Total Score		58.74±30.15	61.60 ±29.27	.945	.000	-2.053	0.045

Relation between WIQ subscale scores and PAD status

Table. Relation between WIQ subscale scores and PAD status

		Not PAD Mean±SD	PAD Mean±SD	P
Subscale scores	Distance Score	73.38 ± 33.68	49.69 ± 39.57	0.001
	Speed Score	62.67 ± 25.63	49.90 ± 26.17	0.004
	Stairs Score	76.45 ± 31.51	54.04 ± 29.71	<0.001
Total Score		70.83 ± 26.11	51.21 ± 29.14	<0.001

Correlation of Sf-36 and Walking Impairment Questionnaire

Table. Correlation of Sf-36 and Walking Impairment Questionnaire

		Distance Subscale	Speed Subscale	Stairs Subscale	Total Score
SF-36 Physical Functioning	r	0.762	0.661	0.717	0.822
	p	<0.001	<0.001	<0.001	<0.001
SF-36 Physical Role Functioning	r	0.427	0.347	0.395	0.451
	p	<0.001	<0.001	<0.001	<0.001
SF-36 Pain	r	0.494	0.454	0.386	0.510
	p	<0.001	<0.001	<0.001	<0.001
SF-36 General Health Status	r	0.478	0.508	0.480	0.557
	p	<0.001	<0.001	<0.001	<0.001
SF-36 Vitality	r	0.394	0.384	0.389	0.446
	p	<0.001	<0.001	<0.001	<0.001
SF-36 Social Role Functioning	r	0.383	0.333	0.332	0.402
	p	<0.001	<0.001	<0.001	<0.001
SF-36 Emotional Role Functioning	r	0.100	0.128	0.164	0.148
	p	0.092	0.032	0.006	0.012
SF-36 Mental Health	r	0.328	0.299	0.287	0.350
	p	1.000	<0.001	<0.001	<0.001

P-1338

Cheap, Available Inflammatory Marker: Main Platelet Volume(Mpv)

Fatih Bağcier, Meltem Alkan Melikoğlu

Atatürk University Faculty of Medicine, Department of Physical Medicine and Rehabilitation, Erzurum

Introduction: C-reactive protein (CRP) and erythrocyte sedimentation rate (ESR) are commonly used assays for measuring acute phase response, but CRP and ESR are influenced by several factors unrelated to inflammation. Mean platelet volume (MPV) is a simple marker of subclinical inflammation. In this study, we aimed to investigate the correlation between MPV and clinical activity indices, namely Systemic Lupus Erythematosus Disease Activity Index SELINA in patients with SLE.

MATERIALS-METHODS: 48 SLE patients (16 active, 32 inactive) were enrolled in the study. Disease activity was determined by Systemic Lupus Erythematosus Disease Activity Index in SLE patients. MPV, PDW, PTC parameters were evaluated. Age and gender- matched 37 healthy subjects were used as the control group.

CONCLUSION: In total, 48 patients (1 males and 47 females) were enrolled in this study. The patients were grouped as Group 1 with control group and Group 2 under remission and group 3 active disease. There were 37 (43,5%) patients in Group 1, 32 (37,6%) patients in Group 2 and 16(%18,8) patients in group 3. The plateletcrit, MPV and PDW values were not seemed to be higher or lower during active disease. In our data unlike the studies of the literature, PTC was not found to be a positive acute phase reactant and MPV and PDW were not negative acute phase reactants in patients with active SLE.

DISCUSSION: These new platelet indices are now widely available and are also cheap, clinicians should wonder about their importance. In our retrospective trial, we analyzed 48 patients with SLE and compared their results with 37 healthy patients. Unlike was expected, these new indices were not valuable parameters for active disease. New trials should be done to support these results. We believe results of our study would be meaningful to do greater number with the patient.

Keywords: Main Platelet Volume, C-reactive protein, erythrocyte sedimentation

P-1339

May Be A Sign Of Systemic Disease: Erythema Nodosum

Fatih Bağcıer¹, Ayhan Kul¹, Murat Alkan², Nilgün Özçakar²

¹Atatürk University Faculty of Medicine, Department of Physical Medicine and Rehabilitation, Erzurum

²Dokuz Eylül University Faculty of Medicine, Department of Family Medicine, İzmir

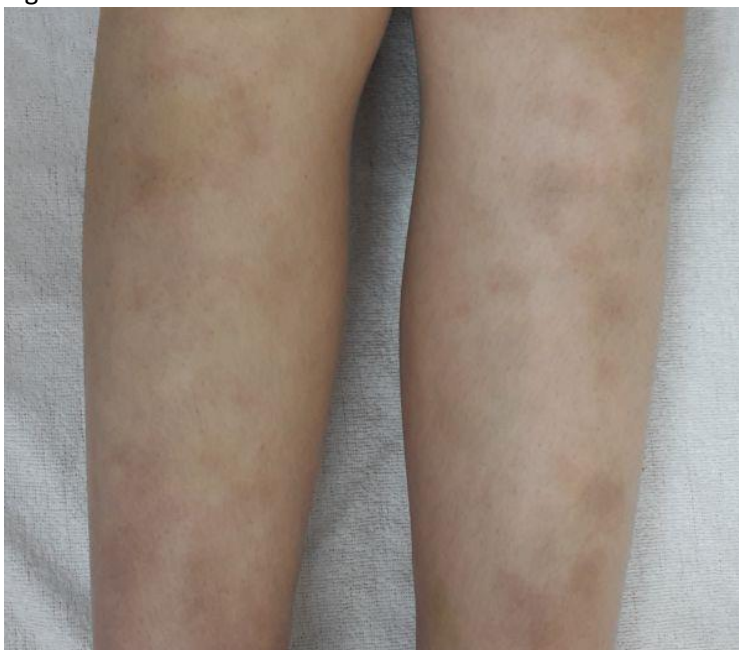
INTRODUCTION: Erythema nodosum (EN) is the most frequent form of panniculitides. EN is associated with many underlying etiological conditions. In about 30-50% of cases, the cause of EN is unknown EN may also be due to infection, autoimmune disorders, pregnancy, medications, cancer. We report a case of EN etiology can not be determined.

CASE: A 15-year-old male patient presented with multiple painful, coin-sized, erythematous nodules over extensor side of bilaterally lower leg for a week. He was referred to the our clinic by the family physician for rheumatic diseases. There was no concomitant fever, hair loss, or joint pain. facial erythema, dryness of eyes and mouth, and oral ulcers, photosensitivity, raynaud's phenomenon, genital ulcers, and serious inflammation of eyes were never noted. The patient denied any major systemic disease in the past. She was not taking any medication when she presented at the outpatient clinic. Physical examinations were unremarkable, except for a tender erythematous induration, about 1 cm in diameter, over the extensor side of bilaterally lower leg. Urinalysis and serial blood tests, including complete blood count/differential count, erythrocyte sedimentation rate, C-reactive protein, antistreptolysin-O and autoimmune markers were all negative. Erythema nodosum was diagnosed. Anti-inflammatory drugs and rest was recommended.

CONCLUSION: EN is associated with a wide variety of conditions such as infection(Streptococcal infection, tuberculosis, mycoplasma pneumoniae), autoimmune disorders(inflammatory bowel disease, behçet's disease, sarcoidosis), pregnancy, medications(sulfonamides, penicillins, oral contraceptives), cancer(non-hodgkins lymphoma carcinoid tumours, pancreatic cancer). But in about 30-50% of cases, the cause of EN is unknown. Erythema nodosum is self-limiting and usually resolves itself within 3–6 weeks. Treatment should focus on the underlying cause. Symptoms can be treated with bedrest, leg elevation, compressive bandages, wet dressings, and nonsteroidal anti-inflammatory agents. in our clinical practice in patients with EN systemic questioned and physical examination must be evaluated carefully.

Keywords: Erythema nodosum, systemic disease, autoimmun diseases

Figure 1



Erythema nodosum classically located on pretibial surface of lower extremity.

P-1340

A case of beta blocker induced psoriasis

Selçuk Akturan

Family Medicine Polyclinic, Tercan State Hospital, Erzincan, Turkey

36 years old men, a Coronary Artery Disease patient and he had coronary artery bypass surgery 2 years ago (2013). He had a history of psoriasis lesions after using metoprolol after CABG, so he had stopped to use metoprolol. After that atorvastatin, clopidogrel were given to him, than he had used regularly these medications. In September 2015, another beta blocker, nebivolol was started to him. One month later, he consulted Tercan State Hospital Family Medicine Polylinic because of erythematous, itchy, swollen, white psoriasis plaques on both of eyelids, external surface of both arms for 3-4 days. Psoriasis is a chronic, inflammatory, immun-mediated skin disorder. Some factors known to trigger psoriasis include smoking, alcohol, body mass index, infection, endocrine disorders, drugs, and acute withdrawal of corticosteroids. Some of the most common medications know to trigger or worsen existing psoriasis include lithium, gold salts, beta blockers, ACE inhibitors, chloroquine, and NSAIDs. We stopped to use nebivolol and 2 weeks later we observed that the lesions were improved. We added a calcium channel blocker medication instead of beta blocker.

Keywords: beta blocker, psoriasis, medication

P-1341

Approach to the Patients Who Applied to Atyam (Alternative and Complementary Medicine Center)

Sultan Oksuz Zortul¹, Abdulsemet Zortul², Yasemin Çayır¹, Fatih Akçay³, Özlem Özer¹

¹Department of Family Medicine, Ataturk University, Erzurum, Turkey

²Department of Radiation Oncology, Ataturk University, Erzurum, Turkey

³Department of Biochemistry, Ataturk University, Erzurum, Turkey

Acupuncture is a form of alternative medicine involving the stimulation of specific acupuncture points along the skin of the body using thin needles. It can be associated with the application of heat, pressure, moxibustion or laser light to these same points. Clinical practice varies depending on the country. According to the theories of traditional chinese medicine (TCM), stimulating acupuncture points corrects imbalances in the flow of Chi through channels known as meridians.

We aimed to show conditions that acupuncture are preferred.

A retrospective review was performed of the medical records of conditions that acupuncture are preferred. We examined data derived from 180 patient who had experienced at least 1 session of acupuncture at ATYAM.

Of 180 patient records identified. % 72 female (n=130), % 28 male (n=50), mean age was 44±14, mean number of session was 9±7, % 55 (n=111) healed, %52 (n=95) continued to treatment.

TCM explains acupuncture as a technique for balancing the flow of energy or life force (Chi). It's based on the theory that energy flows through and around your body along pathways called meridians. Acupuncturists believe that illness occurs when something blocks or unbalances Chi. Acupuncture is a way to unblock or influence Chi and help it flow back into balance. Acupuncture is practiced worldwide both as a primary and adjunctive treatment for a wide range of conditions. Some of the more commonly treated conditions are; pain in the body including headaches, migraines and trauma, psychological related conditions such as depression, anxiety and insomnia, menstrual issues such as premenstrual syndrome, amenorrhea, irregular menstruation, asthma and allergy issues. Pain may be resolved not only through antinociceptive effects but also by reversing the emotional feeling of pain from unpleasant to pleasant. We have found similar datas (figure-1,2). Acupuncture was preferred mostly for diseases; migrain and mechanical pain.

Keywords: Alternative medicine, Acupuncture, Complementary medicine

P-1342

Teleophthalmology and ophthalmologic pathologies in diabetic patients

M Yolanda Valpuesta Martín¹, M Isabel López Gálvez¹, Jose Carlos Pastor Gimeno¹, Yrbani Lantigua Dorville¹, Lourdes Larrañaga Larrañaga¹, Susana Hernández Santamaría¹, Monserrat Piriz Veloso¹, Juan Francisco Sanz Valentín¹, Sara García Vaquero¹, Susana Sánchez Ramón¹, Sonia Herrero Velázquez¹, Carmen Fernández Alonso¹, Raquel Gómez Bravo¹, Marta Lasheras Valpuesta², Carolina Guadarrama Guerra², Juan Pablo Rodríguez Arias², Laura Sanz Rueda², Beatriz Torres Blanco², Paloma Recio Gonzalez Muriel², Luis Carrera Gómez¹

¹Sacyl. Spain.

²University of Valladolid. Faculty of Medicine

The most spread teleophthalmology application is retinopathy screening in diabetic patients.

Its main objective is to prevent blindness, the most severe ophthalmologic complication of diabetics and, on the other hand, to improve patient accessibility to the diagnostic tests and to their reference ophthalmologists. Besides, diabetic retinopathy screening allows the diagnosis of other prevalent ophthalmologic pathologies in our diabetics as cataracts, age related macular degeneration, papillary abnormalities, epiretinal membranes, nevus... An experience of a diabetic retinopathy screening programme applied to 400 patients in a rural health area is presented. The exploration of the ocular fundus with non-mydratic retinograph, under pharmacologic mydriasis, allows the diabetic retinopathy diagnosis, its type and its severity degree, allowing also to establish its interrelationship with the two most important progression factors, time of diabetes evolution and illness metabolic control degree.

On the other hand, teleophthalmology allows new possibilities on the approach of ophthalmologic pathology in rural primary care health centres, avoiding unnecessary patient referrals to ophthalmologists. It would be desirable a suitable equipment in primary care health centres, consisting of optotypes, tonometer, grid Amsler and retinograph, as well as an appropriate ophthalmologic training of the professionals and besides, interdisciplinary work among professionals of the different assistance levels to improve the quality of the assistance patients receive and to improve their satisfaction level.

Keywords: Teleophthalmology, screening, diabetic retinopathy

ASPECT OF THE OCULAR FUNDUS IN A DIABETIC PATIENT WITH CATARACT



NON-MYDRATIC RETINOGRAPH



ABNORMAL PAPILLARY EXCAVATION IN A DIABETIC PATIENT



NORMAL OCULAR FUNDUS IN A YOUNG DIABETIC PATIENT



ASTEROID HYALOSIS



EPIRETINAL MEMBRANE



P-1343

Prevalence and characteristics of musculoskeletal injuries in Lebanese elite track and field athletes

Lana El Osta, Abdo El Helou, Habib Aimé Hatem, Nazek Saadallah, Nada El Osta

Department of Public Health, School of Medicine, Saint-Joseph University, Beirut, Lebanon

BACKGROUND AND AIM: Sports participation involves a certain risk of injuries that might lead to long-term or even permanent disability. It is interesting to acquire knowledge regarding sports injuries, to help planning injury prevention programs.

This study aims to determine the prevalence and to describe the characteristics of musculoskeletal disorders among Lebanese elite track and field athletes.

METHODS: A retrospective cross-sectional survey was conducted among an eligible study population of 250 athletes. Data were collected through an anonymous structured questionnaire assessing self-reported injury data from participants. An athletics injury was defined as musculoskeletal condition that made the athlete partially or completely abstain from training or competition in track and field for a 1-week minimum injury period during the past year.

RESULTS: A total of 210 athletes completed the questionnaire (response rate: 84%): 60.5% were male, and the mean age was 25.51±6.71 years. The participants were categorized into event groups: sprints (17.6%), middle and long distances (49.5%), throws (10.5%), jumps (11.9%), and combined events (10.5%). The 1-year retrospective injury prevalence was 51.9% (95% confidence interval, 45.14%-58.66%). Thirty-one respondents reported injuries to 2 body regions, and 5 others reported injuries to more than 2 regions. Most of the damages affected the lower extremities (85.3%), mainly hip, groin and thigh (34.0%), and were associated with a sudden onset (66.7%). The most frequent types were contractures (35.33%) followed by sprain/strain/rupture (28.0%).

The multivariate analysis showed a significant association between the occurrence of the injury and the event practiced by the athletes (-p-value=0.003), their participation in a high-level regional/international championship (-p-value=0.046), and whether or not they take chronic medications (-p-value=0.032).

CONCLUSIONS: Unfortunately, musculoskeletal injuries are prevalent in our population. Future prospective studies in track and field are needed to identify groups of athletes at increased risk, in order to establish appropriate injury prevention strategies.

Keywords: Musculoskeletal injuries, Injury prevalence, Track and field, Lebanese athletes, Sports medicine

Characteristics of musculoskeletal disorders among Lebanese elite track and field athletes (N=150 reported musculoskeletal injuries)

Body region	GRADUAL ONSET PAIN				SUDDEN ONSET PAIN				
	Stress fracture	Tendinitis	Other	Fracture	Joint derangement	Contusion	Sprain, Strain, Rupture	Cramp, Contracture	Unclassified
1. Vertebral column									
- Cervical, thoracic	0 (0.0)	0 (0.0)	1 (4.5)	0 (0.0)	0 (0.0)	0 (0.0)	1 (2.4)	0 (0.0)	0 (0.0)
- Lumbar, sacrum, pelvis	0 (0.0)	2 (9.1)	3 (13.6)	0 (0.0)	0 (0.0)	0 (0.0)	2 (4.8)	6 (11.3)	1 (100.0)

2. Upper
extremities

- Shoulder

- Upper

arm,	0 (0.0)	1 (4.5)	0 (0.0)	0 (0.0)	1 (100.0)	0 (0.0)	1 (2.4)	0 (0.0)	0 (0.0)
elbow	0 (0.0)	1 (4.5)	0 (0.0)	0 (0.0)	0 (0.0)	0 (0.0)	1 (2.4)	0 (0.0)	0 (0.0)
- Forearm, wrist, hand	0 (0.0)	0 (0.0)	0 (0.0)	0 (0.0)	0 (0.0)	1 (100.0)	0 (0.0)	0 (0.0)	0 (0.0)

3. Lower
extremities

- Hip,

groin,

thigh

- Knee, lower leg	3 (50.0)	4 (18.2)	14 (63.6)	0 (0.0)	0 (0.0)	0 (0.0)	13 (31.0)	31 (58.5)	0 (0.0)
- Achilles tendon, ankle, foot/toe	3 (50.0)	8 (36.4)	4 (18.2)	2 (100.0)	0 (0.0)	0 (0.0)	16 (38.1)	0 (0.0)	0 (0.0)

TOTAL	6 (100.0)	22 (100.0)	22 (100.0)	2 (100.0)	1 (100.0)	1 (100.0)	42 (100.0)	53 (100.0)	1 (100.0)
-------	-----------	------------	------------	-----------	-----------	-----------	------------	------------	-----------

Data are expressed as n (%)

P-1344

Demographic factors and colorectal cancer screening

Gintare Jakstaite¹, Neringa Burokiene¹, Virmantas Kvedaras²

¹Clinics of Internal Diseases, Family Medicine and Oncology, Faculty of Medicine, Vilnius University, Vilnius, Lithuania

²Department of Econometric Analysis, Faculty of Mathematics and Informatics, Vilnius University, Vilnius, Lithuania

BACKGROUND: To evaluate rate of colorectal cancer screening in relation to age and sex in Vilnius University Hospital Santariskiu Klinikos Family Medicine Center. Colorectal cancer screening is for patients who are 50-74 year old. IFOBT and if needed colonoscopy are performed.

METHODS: 530 health's histories were analyzed retrospectively. The participation in the colorectal cancer screening was assessed on July 2009 – September 2013. The impact of sex and age to this program's results was interpreted statistically. Sensitivity and specificity were calculated for this program.

RESULTS: In colorectal cancer screening program females participated more often than males (p =0,067). This research found that oldest patients (over 70 year old) had significantly lower participation rate (4.42e-07). Sensitivity was found 83% and specificity was 81%.

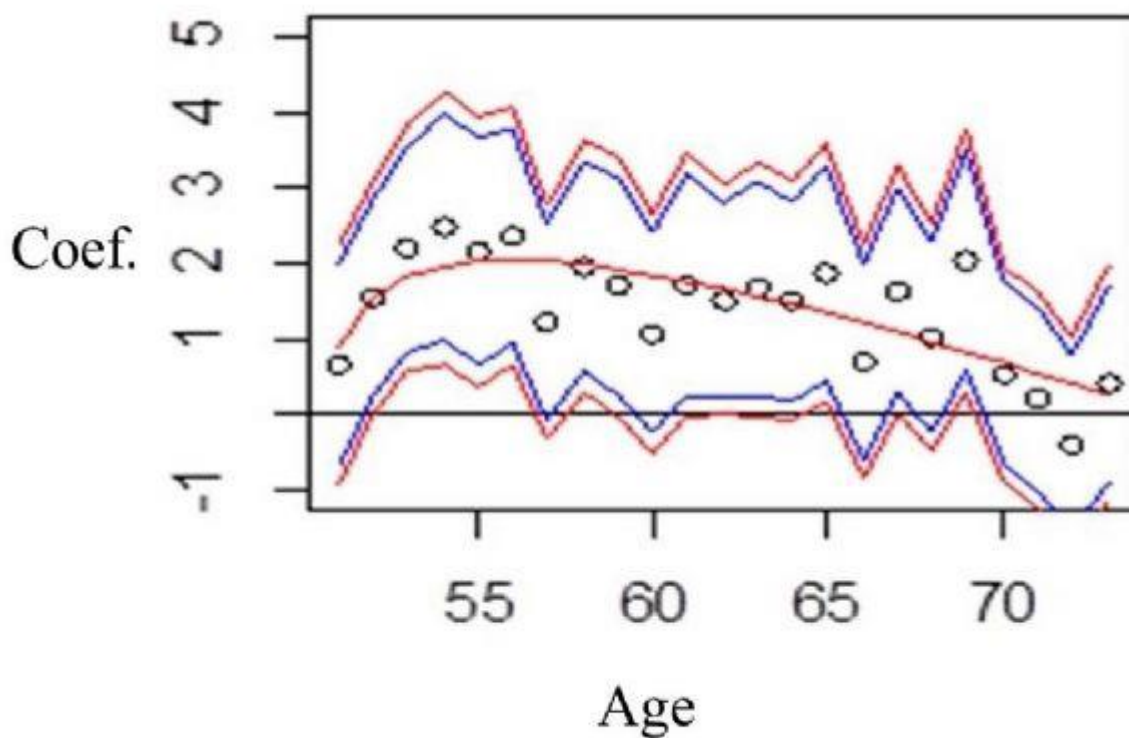
CONCLUSION: Although men have higher risk of colorectal cancer, females were more active in screening than males. Patients over 70 year old should be more involved in the program.

Keywords: colorectal cancer ifobt colonoscopy sex age

Table 1. Results of the research.

Factor	Parameter estimation	Standard error	z criteria	Significance
Gender	0.35135	0.19233	1.827	0.067
Age	-0.23517	0.04657	-5.050	<0,0005
Log(Age-49)	1.69131	0.41807	4.046	<0,0005

Figure 1. The relation between age and probability of participation in the screening.



P-1345

A Very Rare Association: Male Breast Cancer and Neurofibromatosis Type 1

Kamil Başköy¹, Seyid Ahmet Ay¹, Yusuf Haçerli², Yusuf Akyüz³, Ferhat Deniz¹, Arif Yöнем¹

¹Department of Endocrinology and Metabolism, Gulhane School of Medicine, Haydarpaşa Training Hospital, Istanbul, Turkey

²Department of Internal Medicine, Gulhane School of Medicine, Haydarpaşa Training Hospital, Istanbul, Turkey

³Department of Family Medicine, Gulhane Military Medical Academy, School of Medicine, Ankara, Turkey

INTRODUCTION: Breast cancer in men is a rare disease, accounting for less than 1% of all breast cancers.

Neurofibromatosis (NF) Type1 is an autosomal dominant disease caused by mutations in the NF gene and it is associated with many benign tumors (neurofibromas). The prevalence of certain malignancies is increased in these patients. Among these malignancies, breast carcinomas are quite rarely observed. We present here a very rare case of male NF Type1 and breast cancer association.

CASE: A 52-year-old male patient with a history of NF type1 presented with a painful swelling in his right breast for 2 weeks. He had bilateral gynecomastia. Breast ultrasonography showed that there were some areas, which were compatible with the fibroglandular tissues, measuring 42x7mm on the right breast periareolar area and 39x7mm on the left breast periareolar area. Milimetric cystic openings and focal ductal dilatations in the lower outer quadrant of the right breast were observed as well. Complete blood count, routine biochemistry and hormones panel were all in normal ranges. Pathologic examination of excisional right breast biopsy was reported as “right breast invasive ductal carcinoma”. Modified radical mastectomy and axillary lymph node dissection were performed. Tumor was reported as “invasive ductal carcinoma grade II”. Immunohistochemical staining showed that nuclear estrogen receptor protein and nuclear progesterone receptor protein expression was strongly positive. Patient was referred to medical oncology clinic for evaluation for chemotherapy-radiotherapy.

CONCLUSION: Breast cancer and its association with NF1 is rare. We believe that germline mutations may play a role for the combination of NF1 and BRCA1/2. Here we present this case due to the fact that NF1 is quite a rare disease and this was the first case ever to be seen with the combination of NF1 and male breast cancer in our country.

Keywords: Neurofibromatosis Type 1; Breast Cancer

P-1346

Botulism. A rare but life-threatening and emergency disease. A case report

Maria Bakola, Olga Igropoulou, Maria Bolosi, Athanasios Margaritis, Urania Mousafiri, Konstantinos Milios
Intensive Care Unit, General Hospital of Ioannina „G.Hatzikosta“, Ioannina, Greece

Background & AIM: Botulism is a rare but serious paralytic illness which is caused by a nerve toxin that is produced by *Clostridium botulinum* a spore forming, anaerobic bacterium that can contaminate commercially and home canned foods. The aim of this case is to remind family physicians and primary care providers of a rare and life-threatening disease, as well as to highlight the problems arising for the confirmation of the disease and the antitoxin administration.

METHOD: A 21 year old man, came to the emergency room with symptoms of dysphonia, dysarthria and dysphagia, 12- 18 hours after he had consumed canned foods.

RESULTS: The clinical examination revealed no fever, good level of consciousness, very good motility of the legs and pathological findings from the respiratory and the cardiovascular system. Computed tomography, magnetic resonance imaging and lumbar puncture were negative. The next few hours there was a gradual worsening of the previous symptoms, and new symptoms such as ophthalmoplegia (paralysis or weakness of the eye muscles), mydriasis and blepharoptosis (dropping of the upper eyelid) were developed. The aforementioned symptoms and a careful history established a diagnosis of botulism. The patient was intubated, transferred to the Intensive Care Unit and put on a mechanical ventilator for respiratory support. Purified IgG, cortisol and pyridostigmine was administered and Botulinum Antitoxin was ordered. After the sedation cessation, tetraparesis (weakness of all four limbs) and paralytic ileus were observed. Communication with him was done by moving the fingers of his right foot. Everyday rehabilitation helped him to have a slowly progressing and stable recovery.

CONCLUSIONS: Although the disease is very rare, family physicians and primary care providers should obtain a thorough history and always have in mind the symptomatology of this disease, because time is life!

Keywords: Botulism, Dysphonia, Dysarthria, Dysphagia, Ophthalmoplegia, Mydriasis, Blepharoptosis

Figure 1



Canned- Food (Photograph was taken from www.canned-fresh.com)

Figure 2



Botulinum antitoxin (Photograph was taken from www.foodpoisonjournal.com)

P-1347

Bad smell, bad life... Halitosis Approach in Primary Health Care

Carla Pina¹, Célia Mata², Fernando Charrão³

¹USF Cuidar, ACeS EDV I, Santa Maria da Feira, Portugal

²USF Santiago, ACeS Pinhal Litoral, Leiria, Portugal

³USF Esposende Norte, ACeS Cávado III, Esposende, Portugal

Introduction and Aim

Halitosis is a common health problem with psychological, social and economic impact. The General Practitioner (GP) should be alert to this problem and be aware of its causes and consequences on the patient's life quality. This study aims to review the available evidence on the diagnosis and therapeutic management of halitosis by GP.

Methods

This work is a classical literature review employing the Mesh term "halitosis", "primary care" and "adults" and using textbooks, review articles published in major databases and standards of clinical guidance of national and international societies.

Results

Studies indicate that a moderate halitosis occurs in approximately 25% of the population worldwide. The pathophysiological mechanism is still poorly understood. There are systemic and local conditions associated with oral cavity problems in the source of halitosis. However, in its etiology more serious, but less frequent, underlying causes such as otorhinolaryngological, respiratory and gastrointestinal diseases, as well as renal and liver impairment or metabolic syndromes may occur.

Conclusion

Significant costs are associated with the diagnosis and treatment of halitosis, including specialist evaluation and diagnostic tests. These costs would be minimized by the primary health care adopting an evidence based anamnesis and appropriate referral justified by clinical suspicion.

The role of the GP in the presence of a patient with halitosis should go beyond the underlying cause and it is important to understand and appreciate its psychosocial implications.

Keywords: halitosis, primary care, adults

Table 1. The etiology of halitosis

PERIODONTAL INFLAMMATION	Microorganisms and inflammatory products present in gingivitis/periodontitis are capable of producing odoriferous substances.
TONGUE COATING	Tongue coating including bacteria, desquamated cells and saliva, among others, is one of the important etiological factors of halitosis.
MICROBIOLOGY	Bacteria in saliva, soft and hard tissues produce odoriferous substances in vitro.
NON-ORAL CAUSES OF HALITOSIS	Ear-nose-throat problems such as tonsillitis, sinusitis, the presence of strange body material and rhinitis were frequently associated with non-oral halitosis. The gastro-intestinal tract can only indirectly (haematogenic) influence bad breath. A majority of patients and physicians still abusively believes that halitosis originates from the stomach. The latter is only correct in 0.5% of the cases. Stressful situations also might contribute to increased halitosis. Halitophobia is a paradoxical situation that affects 15% of patients referring halitosis symptoms. Psychogenic cause has an important impact in patients life quality due to obsessive idea of a bad breath. Rare causes: metabolic disorders, hepatic and endocrine situations.
MEDICATION	Some medications result in a dry mouth; recently was verified that the use of bisphosphonates can contribute to oral malodour.

Table 2. The treatment of halitosis

Table 2. The treatment of halitosis	
PERIODONTAL THERAPY	Periodontal treatment decreases halitosis.
APPROACHES DIRECTED TO TONGUE COATING	Several studies have demonstrated that reducing bacteria on the dorsum of the tongue will diminish halitosis.
ANTIMICROBIALS	Since the presence of microorganisms from oral biofilms is responsible for producing malodor, any type of treatment approach that has impact in the oral microbiota has the potential of reducing halitosis.
MEDICAL APPROACHES	If oral approaches are not successful in reducing/eliminating halitosis, patients should be referred to a physician. If the medical causes cannot be suspected, the first professional to be referred is the otorhinolaryngologist, followed by the gastroenterologist. If halitophobia is considered, a psychologist or psychiatrist should be included.
MASKING AGENTS	The use of chewing gum may decrease halitosis, especially through increasing salivary secretion. Mouthrinses containing chlorine dioxide and zinc salts have a substantial effect in masking halitosis, not allowing the volatilization of the unpleasant odor.

P-1348

Integration of information in our Medicine consultation of Family, with regard to a case of Syndrome of Good

Samuel García Moreno, Carmen María Jimenez Herrera, Sandra Roldan García

Centro de Salud Nuestra Señora de La Oliva. Alcalá de Guadaira. Sevilla.

REASON FOR CONSULTATION: Patient 75 years old, male, who consults by fever.

PERSONAL ANTECEDENTS: Chronic diarrhea, months of evolution followed by private doctor, who was diagnosed with recurrent intestinal giardiasis. Respiratory infections of repetition.

PRESENT DISEASE: Intermittent fever of three days of evolution, cough, expectoration whitish and difficulty to breathe. He refers anorexia, asthenia and he tells us a loss of 37 kg during the last year, which was attributed to his chronic diarrhea and anorexia. Before the clinic started constitutional study box.

COMPLEMENTARY EXPLORATION AND TESTS:

Good general condition. Great thinness, without cachexia.

Pulmonary Auscultation: abundant mucus of upper respiratory tract, vesicular murmur preserved.

Abdominal exploration, digital rectal examination, exploration normal neurological.

Hemogram, coagulation and biochemistry, analytical thyroid, normal antinuclear antibodies and anticeliac quía. Negative lactose curve. Serology of infectious diseases normal.

Stool culture positive for G.lambdia.

Urine cultures and negative blood cultures.. Culture of sample obtained with bronchoscopy: E.coli.

Proteinogramme: severe hypogammaglobulinemia of all the immunoglobulins, especially the immunoglobulin G.

Normal Endoscopy. Gastroduodenal transit demonstrated malabsorption.

TAC: injury in anterior mediastinum compatible with thymoma, without lymph node involvement, and bronchiectasis.

CLINICAL TRIAL:

- Syndrome of Good (humoral immunodeficiency associated with thymoma)
- Chronic diarrhea (malabsorption, malnutrition severe, recurrent infections)
- Respiratory Infection by E.coli.

DIFFERENTIAL DIAGNOSIS:

- Síndromes of malabsorption, celiac disease.
- Taking of anorexígenos, alcoholism, diabetes or hyperthyroidism
- Autoimmune diseases.
- Neoplasms.
- H.I.V.

TREATMENT:

Immunoglobulins for the treatment of humoral immunodeficiency and antibiotic therapy for the treatment of

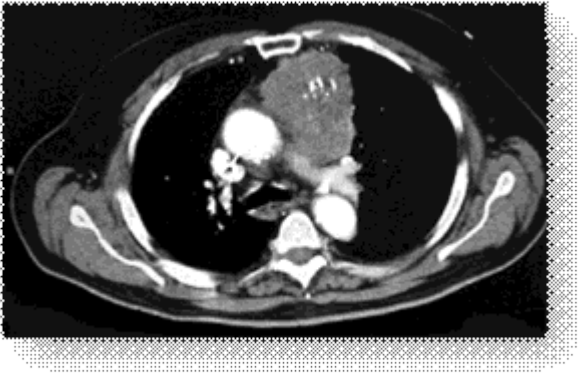
chronic diarrhea.

FINAL COMMENT

Good syndrome is a rare disorder that treatable associated humoral immunodeficiency and thymoma (benign) without known etiological relationship. It is associated with repeat infections and chronic diarrhea due to the humoral immunodeficiency.. This case shows the importance of the comprehensive approach to a patient as well as the overall vision of the symptoms to reach the correct diagnosis.

Keywords: Syndrome of Good, thymoma, diarrhea

TAC



TAC: thymoma, without lymph node involvement, and bronchiectasis.

P-1349

Wegener's Granulomatosis: A Case Report

Irene Pérez González¹, [María Carmen Fernández Alonso](#)², Sara Nieto Sánchez¹, Aventina De La Cal De La Fuente¹, Claudia Bujedo Ortiz¹, Eva Sierra Quintana¹, Susana Sánchez Ramón³, Juan Carlos Sánchez Rodríguez³, André Duque Chau³, Sandra Casado De Andrés¹, Yolanda González Silva⁴, Sandra Jiménez Asensio⁵, Miriam Martínez Fernández⁶

¹Centro de Salud Casa del Barco, Valladolid Oeste, España

²Gerencia Regional de Salud, Valladolid, España

³Servicio de Urgencias Hospital Universitario Río Hortega, Valladolid Oeste, España

⁴Centro de Salud Plaza del Ejército, Valladolid Oeste, España

⁵Centro de Salud La Almozara, Zaragoza II, España

⁶Centro de Salud José Aguado, León, España

BACKGROUND@AIM:

17year-old-woman without allergies and previous diseases, referred history of 6months characterized by anorexia, weight loss of 5Kg and arthralgias. She recounted fever, rhinorrhea and oral ulcers the previous week. Primary care physician requested urgent blood test and thorax Xray, revealing bilateral infiltrates, hilar adenopathies, elevated acute phase reactants (VSG, PCR), leukocytosis and thrombocytosis. She was admitted to Internal Medicine for further study.

METHOD:

-Physical examination: Blood Pressure 108/68, Heart Rate 102, Oxygen Saturation 93%, FR 20. Cardiopulmonary auscultation: Tachycardia, regular rhythm without audible murmurs; decreased vesicular murmur in both bases.
-Blood test: leukocytes 14500/mm³; Platelets 452000/mm³; Hemoglobin 10,6g/dl; PCR 56; VSG 520; PR3-ANCA: positive; serum creatinine 1,9mg/dL, serum urea 47mg/dL. ANA, C3, C4, Cryoglobulins, hepatic and HIV serology, liver function: negative.
-Urinalysis: microscopic hematuria and proteinuria.

- ThoraxX Ray:diffuse opacities,fleeting bilateral pulmonary infiltrates,hilar adenopathies.
- Thoracic Scanner:nodules in bases of both lungs,signs of cavitation,stenotic lesions. Bilateral pleural effusions.
- Skin Biopsy: nonspecific leukocytoclastic vasculitis(no complement and immunoglobulin on immunofluorescence).
- Transbronchial Lung Biopsy:granulomatous inflammation.
- Kidney Biopsy:pending.

RESULTS:

Given symptoms and results of additional testing, patient was diagnosed with Wegener Granulomatosis(small vessel vasculitis).Patient meet several clinical criteria:nasal and oral inflammation,abnormal chest radiograph and urinary sediment,granulomatous inflammation on biopsy of perivascular area.

Being hospitalized presented self-limited hemoptysis,dyspnea,and pericarditis.She also presented purpura in lower extremities without necrosis or ulceration.

She was treated with high doses of ciclophosphamide and prednisone,with good therapeutic response.

CONCLUSIONS:

Wegener's Granulomatosis consists of granulomatosis with polyangiitis.It occurs in older adults (reported at all ages).Both genders are affected.More common among white individuals.

Patients present with constitutional symptoms which may last for months without specific organ involvement.Several organs may be affected(ear,throat,nose,lung,kidney, skin,eyes,nervous system,gastrointestinal and lower genitourinary tract,heart,parotid glands,thyroid and liver).

Prompt diagnosis is important to initiate therapy that may be life saving and organ sparing.This may be difficult since presenting symptoms are hard to distinguish from those of non-vasculitic processes(infection or malignancy).Positive ANCA strongly suggests vasculitis.Histologic examination of affected organ is required for definitive diagnosis.

It's important for primary care physicians high index of suspicion to avoid missing this disease,when attending patients with multisystem symptoms.

Keywords: Granulomatosis, Polyangiitis, Hemoptysis, Arthralgias, Lung Infiltrates, Oral Ulcers.

ORAL ULCERS



PURPURA IN LOWER EXTREMITIES



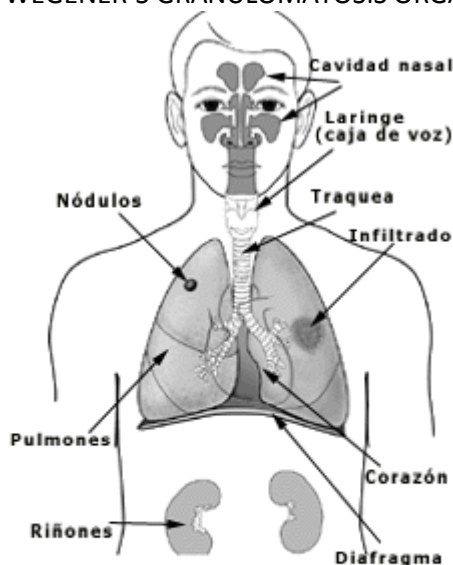
THORAX SCANNER



THORAX X RAY



WEGENER'S GRANULOMATOSIS ORGAN AFFECTATION



La granulomatosis de Wegener afecta normalmente al sistema respiratorio superior (cavidades nasales, nariz y traquea), los pulmones y los riñones. No todos los pacientes tendrán afectados todos los puntos.

P-1350

Patients Satisfaction for Social Security Administration in Community Health Center of Manado City

Henry Palandeng, Iyone Siagian, Feicy Gaghana

Department of Community Medicine, Faculty of Medicine, Sam Ratulangi University, Manado, Indonesia

Introduction

The government of Indonesia is trying to provide healthcare for all the people by social security administration known as Badan Penyelenggara Jaminan Sosial (BPJS) and Manado city is one of the cities which has to be in line with the government to organize the program. BPJS Program is devoted to the public good for Manado Citizens in order to have the right to receive healthcare and improve community health status in Manado.

Patient satisfaction provides information whether the healthcare that provided by the community health center is satisfied for its use. The purpose of this research is to determine level of patient's satisfaction for health care in Tuminting community health center.

Methods

Descriptive research. Sample size using purposive sampling technique is 106 patients. Questionnaires used to interview respondents. We asked five dimension of quality of services which are; reliability, responsiveness, assurance, empathy, tangibles and patient overall satisfaction. To measure respondents' satisfaction assessment services given the Likert's scale is considered suitable.

Results

The results shows 50,9% patients satisfied with reliability, 54,7% patients satisfied with responsiveness, 77,4% patients satisfied with assurance, 55,7% patients satisfied with empathy, And 66% patients satisfied with tangible. The overall patient satisfaction rate for healthcare is 51,9%.

Conclusions

The health care given by Tuminting community health center to patients goes along with the order that satisfies patient the most is assurance, tangibles, empathy, responsiveness, and reliability.

1. Patient registration system needs to be improved.
2. Physicians need to pay more attention to the provision of information about the diseases and patient's explanation. Nurses should also be more friendly and polite.
3. Administrators need to optimize their duties and functions.
4. The attention given by health professionals to patients needs to be improved further.
5. More attention to the cleanliness of the reception area and the surrounding environment

Keywords: satisfaction, health care, community health center

Table 1

Characteristic	Total (respondent)	Percentage (%)
Age		
17-24	7	6.5
25-35	44	41.5
36-45	27	25
46-55	18	18
>55	10	10
Gender		
Women	75	70.8
Men	31	29.2
Education		
No Education	1	0.9
Elementary	20	18.9
Junior High	37	34.9
High School	41	38.7
Graduate	7	6.6
Employment		
Housewife	64	60.4
Entrepreneur	22	20.8
Retired	1	0.9

Distribution of Respondents by Age, Gender, Education and Employment

Table 2

Patient satisfaction rate for health care	Total (respondent)	Percentage (%)
Unsatisfied	51	48.1
Satisfied	55	51.9
Total	106	100

Distribution of Patient Satisfaction in Community Health Center Manado

P-1351

The Importance of Calcitonin Measurement in Thyroid Nodules: A Case of Medullary Thyroid Cancer With Benign Fine Needle Aspiration Biopsy But Elevated Serum Calcitonin

Seyid Ahmet Ay¹, Kamil Başköy¹, Yusuf Hançerli², Yusuf Akyüz³, Ferhat Deniz¹, Arif Yönel¹

¹Department of Endocrinology and Metabolism, Gulhane School of Medicine, Haydarpaşa Training Hospital, Istanbul, Turkey

²Department of Internal Medicine, Gulhane School of Medicine, Haydarpaşa Training Hospital, Istanbul, Turkey

³Department of Family Medicine, Gulhane Military Medical Academy, School of Medicine, Ankara, Turkey

INTRODUCTION: The prevalence of thyroid nodules detected by imaging methods is around 20-76%. When thyroid nodules are detected, echogenicity, presence of calcification, size of nodule, and Doppler blood-flow patterns should be evaluated thoroughly in terms of malignancy potential and, if necessary, thyroid fine needle aspiration biopsy (FNAB) should be performed as well. In addition, if the nodule is detected in a patient for the first time, calcitonin level should be checked in order to confirm or rule out the medullary thyroid cancer (MTC). MTC, a rare cancer constituting 4% of thyroid tumors, originates from calcitonin-secreting parafollicular C cells. About 75% of MTCs are sporadic while the remaining 25% of MTCs are hereditary. RET proto-oncogene is responsible for the genetic transition of the disease. We present here a case of MTC previously had a benign FNAB report, but later, with the finding of increased serum calcitonin, repeat biopsy revealed MTC.

CASE: A 49-year-old female patient was referred to endocrinology clinic after incidental thyroid nodule detection by neck ultrasound (US). Thyroid US revealed a solitary hypoechoic nodule, measuring 4x2 cm in the right inferior lobe extending into the retrosternal region. Her thyroid function tests were normal. FNAB of the nodule was reported as benign cytology. Since it was the first nodule evaluation for the patient, calcitonin levels were checked as well and were found to be 28000 pg/ml (reference: 0-5 pg/ml). Her repeated calcitonin, as well as CEA level, was found to be increased. MTC was strongly suspected and repeat FNAB revealed malignancy. RET gene mutation analysis was positive. Screening for hyperparathyroidism and pheochromocytoma showed no related abnormality. Patient was screened for metastasis due to the fact that her calcitonin level was above 500. Metastases were observed in the mediastinum and lumbar spine by computerized tomography. Patient was considered as stage 4 MTC, total thyroidectomy and then radiation therapy was scheduled.

CONCLUSION: We want to emphasize here with this case, how important and necessary it is to check calcitonin levels at least once, regardless of the size of the thyroid nodules or FNAB results.

Keywords: Thyroid nodule; Medullary Thyroid Cancer; Calcitonin

P-1352

Efficacy of ultrasound therapy with Fastum gel on patients with gonarthrosis

Žani Banjanin¹, Ljubomir Šormaz¹, Jadranka Pešević Pajčin¹, Radmila Ubović², Brankica Galić³

¹Health centre "Dr Mladen Stojanović", Laktaši, Bosnia and Herzegovina

²Institute of Occupational Medicine and Sports Republic of Srpska, Banja Luka

³Health centre, Prijedor, Bosnia and Herzegovina

OBJECTIVE: Osteoarthritis is a degenerative joint disease, characterized by progressive destruction of articular cartilage. The main clinical manifestation is pain and progressive functional disability.

The aim of this study was to examine the effectiveness by applying Fastum gel (ketoprofen) in patients with gonarthrosis

METHOD: We examined 60 patients, aged 50-83, with clinical-radiological diagnosis of knee OA. Fastum gel was applied by phonophoresis to 30 patients. To the remaining 30 patients, a neutral contact gel was applied. Application was performed 2 times a day for 14 days. Ultrasound intensity was 1.0 W/cm². Besides phonophoresis, all examinees had kinezotherapy. We used the WOMAC Osteoarthritis Index to compare the results between two analysed groups. All subjects were asked to fill out the questionnaire at the beginning and at the end of the therapy.

RESULTS: After 14 days of application of Fastum gel, Womac subskor for pain decreased by 22.03%, functional capacity subscore decreased by 6,50%, and subskor for stiffness decreased by 25.27%. In patients treated with a neutral gel, after 14 days, Womac subskor for pain decreased by 3.69%, subskor for reduced functional ability decreased by 1.18%, and subskor for stiffness decreased by 14.12%.

CONCLUSION: There was a significant improvement of functional capacity, reduced stiffness and pain in the knees after the ultrasound treatment of Fastum gel in patients with knee OA.

Keywords: Gonarthrosis, Fastum gel, WOMAC OA index.

Basic demographic characteristics and classification of OA

	Fastum gel	Neutral gel	Total
Number of respondents	30	30	60
Demographics			
Age (SD)	69.1±7.9	66.6±8.6	67.85±8.3
Gender (%)			
Men	10 (33.3%)	13 (43.3%)	23 (38.3%)
Women	20 (66.7%)	17 (56.7%)	37 (61.7%)
Classification of OA according to Kellgren-Lawrence scale			
Level II	19 (63.3%)	16 (53.3%)	35 (58.3%)
Level III	11 (36.7%)	14 (46.7%)	25 (41.7%)

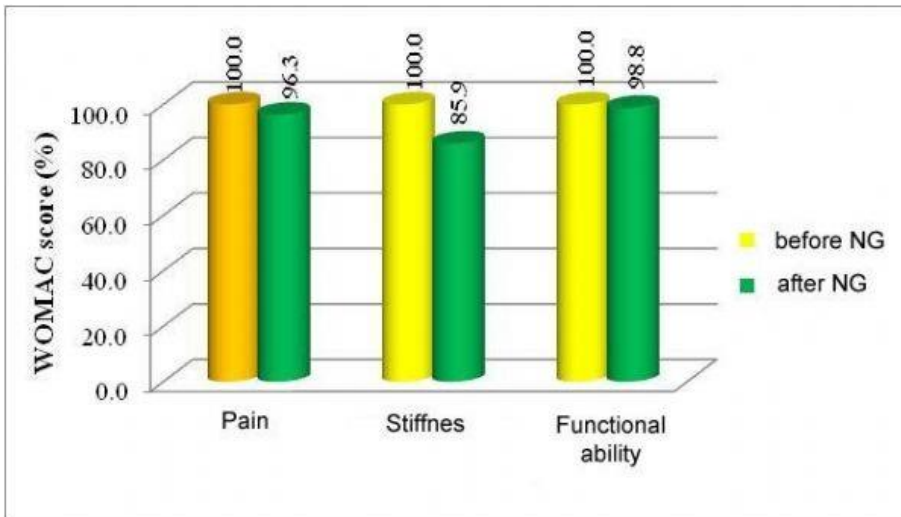
The study included 60 patients with an average age of 67.85 years. 30 patients were treated with a neutral gel and 30 with Fastum gel. Significant differences for the observed size before treatment between the groups were found for age and gender. The representation of patients with varying degrees of OA was very similar in both groups.

Analysis of differences WOMAC score before and after therapy

WOMAC index	Pain	Stiffness	Functional ability
Fastum gel group			
WOMAC score before treatment	13.5±3.3	6.1±1.3	42.6±13.6
WOMAC score after treatment	10.5±3.9	4.5±1.2	39.8±14.0
T-value	5.24	4.74	5.32
p-value	p<0.01	p<0.01	p<0.01
Neutral gel group			
WOMAC score before treatment	13.5±3.2	5.9±1.3	42.4±13.4
WOMAC score after treatment	13.0±3.2	5.1±1.5	41.9±13.2
T-value	2.19	3.15	2.29
p-value	p<0.05	p<0,01	p<0,05

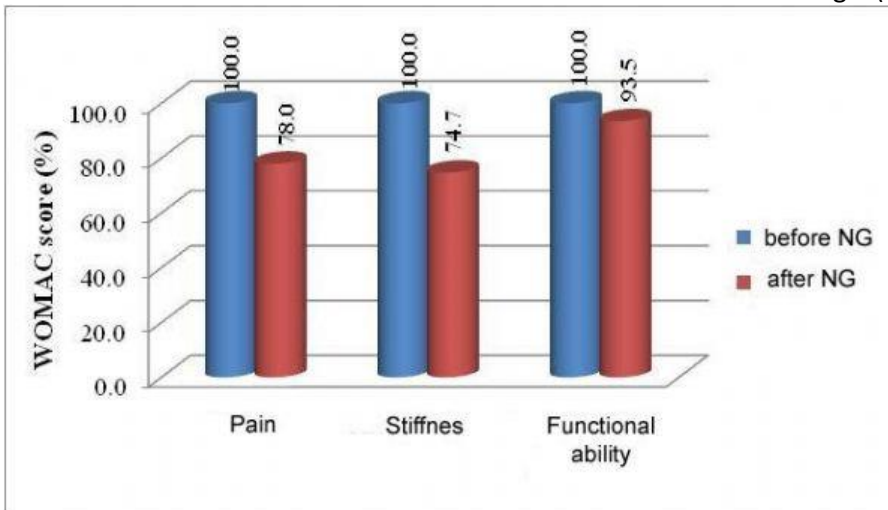
After applying Fastum gel was statistically highly significant improvement in functional abilities of the subjects, a reduction in pain and stiffness (p <0.01). Improving functional ability and reducing pain in subjects which we applied a neutral gel was statistically significant (p <0.05) and decrease stiffness was statistically highly significant (p <0.01).

WOMAC subskor before and after ultrasound treatment with a neutral gel (NG)



In patients treated with neutral gel, after 14 days, subscore WOMAC pain was lowered to 3.69%, subscore for functional capacity was lowered to 1.18% and subscore for stiffness for 14.12%

WOMAC subscore before and after ultrasound treatment with Fastum gel (FG)



After 14 days of application Fastum gel subscore WOMAC pain decreased by 22.3%, subscore for functional capacity was lowered to 6.50%; and subscore for stiffness for 25.27%.

P-1353

Synkinesia And Hemifacial Spasm Developed After Bell's Palsy: A Case Report

Esra Meltem Koç¹, Ali Murat Koç², Duygu Ayhan Başer³, Rabia Kahveci⁴

¹Department of Health Technology Assessment, Ministry of Health, Ankara, Turkey

²Department of Radiology, Gazi University, Ankara, Turkey

³Directorate of Public Health, Kocaeli, Turkey

⁴Department of Family Medicine, Ankara Numune Training and Research Hospital, Ankara, Turkey

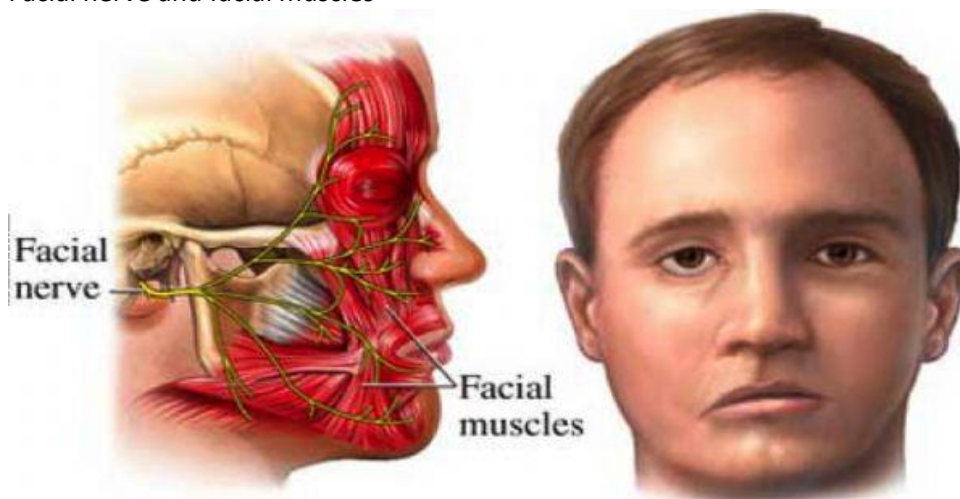
INTRODUCTION: Bell's palsy is an acute started, limited time continued palsy with unclear etiology. It seems 1/60 risks and 11-40/100,000 per years incidence throughout their lives.

CASE: A 26-year-old female patient was admitted to our hospital with complaints of decrease of the right eye and right shift of mouth, facial swelling on the right half and mild numbness and weakness. There was idiopathic facial paralysis history at the right eye about a year ago. We detected ptosis at the right eyelid and edema at the right half of face at our physical examination and we started antiviral and oral prednisone 1mg/kg/day treatment with thinking recurrent the right facial nerve paralysis in patient. At our control examination 10 days after patient said there was no reduction at her complaints by using therapy and complaints in the form of spasms get started at right half of the face and learned that watery eyes tearing, a right frotoorbital headache get started. On top of that the patient was referred to the Ear Nose Throat-ENT-Diseases. ENT did not think peripheric facial paralysis in patients; suggested to investigate the etiology of ptosis. Patient was referred to neurology. Routine laboratory studies and serological tests were within normal limits. Temporal MR and MR sistenograf examinations normal. Patient evaluated with EMG. Nerve damage secondary to previous facial paralysis was thought. Carbamazepin started for hemifacial spasm and synkinesia. Botulinum Toxin A injection started due to complaints were continuing after 1 month therapy. By this therapy complaints of patient were reduced. Patient continuing her treatment with 3-6 months periods.

DISCUSSION: Improvement in the facial nerve paralysis is expected up to one year. Spontaneously and full recovery was observed in approximately 80-85% of patients within the first three months, while 15-20% lighter, 5% may be serious nerve damage. Synkinesia and facial spasms in partially improved facial nerve paralysis can be treated successfully with the subcutaneously or intramuscularly applied botulinum toxin.

Keywords: Synkinesia, Hemifacial Spasm, Bell's palsy

Facial nerve and facial muscles



Botulinum Toxin A



Botulinum Toxin A injection



P-1354

charles bonnet's syndrome: a case presentation

Sema Erdogmus¹, Osman Aga Onal², Aylin Ardagil Akcakaya³, Hasan Huseyin Mutlu¹, Zuhal Aydan Saglam¹

¹Family Medicine, istanbul medeniyet university goztepe training and research hospital, istanbul, turkey

²Department of Psychiatry, istanbul medeniyet university goztepe training and research hospital, istanbul, turkey

³Department of Ophthalmology, istanbul medeniyet university goztepe training and research hospital, istanbul, turkey

INTRODUCTION: Charles Bonnet's syndrome(CBS) is rare disease which is characterized with vision loss,visual hallucination and preservation of cognitive status following ocular pathology.

CASE: H.B aged 91,has 2 children,literate and living with daughter was operated 3 years ago due to globe rupture in her left eye.Phthisis bulbi occurred subsequently in left eye and visual acuity level was reported as p+(can only recognize light).However,2 years after this case,following the occurrence of secondary choroidal neovascular membrane over macular degeneration.While on May 2014,due to preretinal bleeding in the right eye,visual acuityit declined to counting fingers from 1 meter which was 18 letters/4 meter.Patient was referred to psychiatry department when she reported visualizing/seeing imaginary colorful images bilaterally–mostly in front of her right eye.During psychiatric evaluation,she was conscious,cooperation was sufficient and tendency was normal.Her cognitive function was sufficient,psychomotor activity was normal.Affection was depressive,perception was shallow,while content and flow of thought was normal.She was suffering from a pain covering of her body and was scared of becoming blind and death.She had been getting psychiatric drugs since her husband died and was still under duloxetine and -if required- alprazolam.When she first started complaining 6 months ago she stated that she saw colorful lines and transitions,but on following day she began to see a forest,moving objects and objects without actual colors.It was observed that visual hallucinations of the patient was simple at first but by time it got complex.Surprisingly,she was aware of the fact that she was experiencing hallucinations.She was diagnosed as CBS and mirtazapine was added for treatment of sleep disorder and anxiety.At the next appointment,hallucinations,distress,fear and concern were decreased.

DISCUSSION: Macular degeneration,glaucoma,cataract and decollement are mostly seen concurrently CBS.Patients become anxious when hallucinations start,our patient stated that she was happy with colorful hallucinations.With this case presentation,we aimed to report a rare syndrome presenting with sensual loss at an old woman.

Keywords: charles bonnet's syndrome, visual halusination, macular degeneration, preservation of cognitive status

P-1355

On Eugene Garfield And Indexing: A Biographical Review

Onur Öztürk¹, Betül Ozcan Dost², Emrah Dost³, Bektas Murat Yalcin⁴, Mustafa Unal⁴

¹Atakum Community Health Center, Samsun, Turkey

²Ondokuz Mayıs University School Of Foreign Languages, Samsun, Turkey

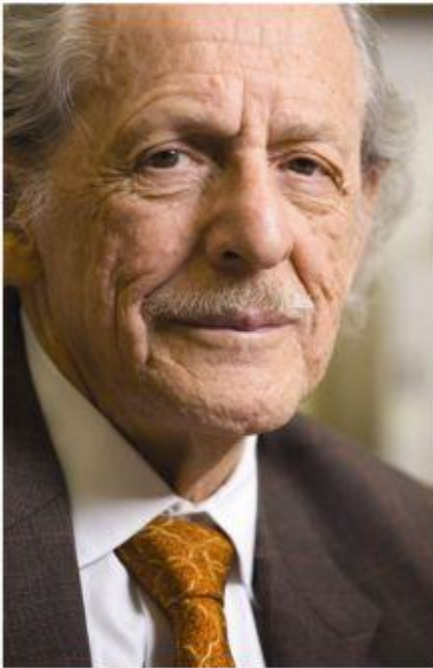
³Ondokuz Mayıs University Faculty of Medicine, Department of Family MedicinePublic Health, Samsun, Turkey

⁴Ondokuz Mayıs University Faculty Of Medicine, Department Of Family Medicine, Samsun, Turkey

Eugene "Gene" Garfield was born in September 16, 1925 in New York City, New York, United States. He is a world-wide known American scientist. He is also one of the founders of bibliometrics and scientometrics, an art lover, a multilinguist, an entrepreneur, a musician and a prolific author. Garfield, who graduated from Department of Chemistry at Columbia University in 1949 and received his M.S. Library Science in 1954 and his Ph.D. degree in Structural Linguistics at the University of Pennsylvania in 1961, is mostly known around the world for ISI. Thanks to ISI, created by Garfield, researchers from all disciplines have been benefiting from a more systematic, faster, objective, interdisciplinary and extensive system while carrying out their researches and this index has enabled them to track down the origins of a scientific idea and led to creation of other information retrieval algorithms.

Keywords: Eugene Garfield, ISI, Indexing

Eugene Garfield picture



P-1356

Determination Of The Knowledge Levels, Attitudes, And Behaviors Of Islamic Religious Officials Toward Blood Donation

Hamit Sırrı Keten¹, Oğuz Işık², Celal Kuş², Özgür Ersoy³, Soner Ölmez⁴, Fatiş Yıldırım², Mustafa Çelik²

¹Department of Family Medicine, Kurtul Family Health Center, Kahramanmaraş, Turkey

²Department of Family Medicine, Medical Faculty, Kahramanmaraş Sutcu Imam University, Kahramanmaraş, Turkey

³Department of Public Health, Medical Faculty, Cukurova University, Adana, Turkey

⁴Department of Family Medicine, Samsat Family Health Center, Adıyaman, Turkey

BACKGROUND: The aim of the present study was to determine knowledge level, attitudes, and behaviors of Islamic religious officials toward blood donation.

METHOD: This study included 334 religious officials rendering service in the province of Kahramanmaraş, located in the Mediterranean region of Turkey. A questionnaire was administered to gather sociodemographic data of the participants and their knowledge levels, attitudes, and behaviors toward blood donation. The questionnaire consisted of 11 questions that yielded a total of 11 points.

RESULTS: The religious officials in the study included 206 imams (61.7%, males) and 128 Quran course instructors (38.3%, females). Of study participants, 134 (40.1%) reported a previous experience of blood donation and 200 (59.9%) denied previous experience of blood donation. The mean knowledge score was 7.09 ± 2.54 points for males and 6.89 ± 2.18 points for females. Male and female participants achieved comparable scores ($p=0.476$). Of the participants, 291 (87.1%) agreed and nine (2.7%) disagreed with the expression, "Blood donation is permissible in Islam;" 34 (10.2%) participants had no idea. Of the participants, 303 (90.7%) agreed and 12 (3.6%) disagreed with the expression, "Blood donation important for one's survival;" 19 (5.7%) participants had no idea.

CONCLUSIONS: The present study revealed considerable deficiencies in knowledge about blood donation among religious officials. In addition, the rate of blood donation and willingness to donate blood were low among religious officials. Although the level of knowledge about blood donation was similar in males and females, it was an interesting finding that the blood donation rate was significantly higher in males than in females. A high proportion of religious officials deemed blood donation permissible in Islam.

Keywords: Religious official, Islam, imam, blood, blood donation

P-1357

Determination Of Prevalence Of Oral Candida Carriage And Candida Species Among Cigarette And Smokeless Tobacco (Maras Powder) Users

Hamit Sırrı Keten¹, Derya Keten², Hüseyin Üçer³, Fatiş Yıldırım³, Hakan Hakkoymaz⁴, Oğuz Işık³

¹Department of Family Medicine, Kurtul Family Health Center, Kahramanmaraş, Turkey

²Department of Clinical Microbiology and Infectious Diseases, Necip Fazil City Hospital, Kahramanmaraş, Turkey

³Department of Family Medicine, Medical Faculty, Kahramanmaraş Sutcu Imam University, Kahramanmaraş, Turkey

⁴Department of Emergency Medicine, Medical Faculty, Kahramanmaraş Sutcu Imam University, Kahramanmaraş, Turkey

BACKGROUND: The aim of this study was to determine the prevalence of Candida carriage and Candida species among cigarette and Maras powder (MP) users.

METHOD: This study was conducted on 180 volunteering men in 20 cafes in the city of Kahramanmaraş, Turkey. The sociodemographic characteristics of the participants and the behaviors of MP and cigarette usage were noted down. Culture specimens were obtained from bilateral buccal mucosa and dorsum of the tongue with a sterile cotton-tipped swap.

RESULTS: The specimens were inoculated into Sabouraud Dextrose Agar. The mean age of the participants was

40.49 ± 12.89 years (min = 18, max = 87). Fifty-eight percent of the cigarette users, 56.7 % of the MP users, and 36.7 % of the control group were Candida carriers. The difference of Candida carriage between cigarette and MP users and the control group was statistically significant (P = 0.018 and P=0.029 respectively). The prevalence of Candida carriage was similar between cigarette and MP users (P=0.854). The most frequently isolated species was Candida albicans at a rate of 30 % in the cigarette users' group, 28.3% in the MP users' group and at a rate of 18.3% in the controls. The prevalence of Candida tropicalis carriage was found to be at a rate of 20% in cigarette and 21.7% in the MP users' group compared to 11.7% in the nonusers.

CONCLUSIONS: In the present study we found that the prevalence of oral Candida carriage was significantly higher among cigarette and MP users.

Keywords: Smoke, smokeless tobacco, candida

P-1358

Temporomandibular Joint Pain – Diagnostic challenges

Angela Amorim

USF Santa Maria, Tomar, Portugal

Background and AIM:

Rheumatoid arthritis (RA) is an autoimmune disorder characterized by joint inflammation, erosive properties and symmetric multiple joint involvement. Temporomandibular joint (TMJ) arthritis is frequent in patients with RA, but is seldom the first joint affected. This case consists of a female with undiagnosed RA who first presented with signs and symptoms in the TMJs. It highlights the importance of professional awareness of such occurrences.

METHOD:

Data was collected during office visits with patient; analysis was made of patient's clinical records including medical history, physical examination, diagnostic procedures, treatment and evolution. A review of literature regarding TMJ arthritis was performed.

RESULTS:

19-year-old female patient visited Family Physician (FP) complaining of bilateral TMJ pain over 2 months. On eliciting the history, patient had pain during jaw movement and limitation of maximal mouth opening. Clinical examination revealed bilateral tenderness on TMJ palpation and limited TMJ range of motion. No joint sounds or tenderness on masticatory muscle palpation were identified. TMJ tomography images revealed erosion of cortical bone of both condyles, with apparent partial erosive amputation, relative bone sclerosis of the posterior joint eminence. Blood analysis revealed slight anemia, elevated C-reactive protein and sedimentation rate. Referred to maxillofacial surgery and later to autoimmune diseases consult where the diagnosis of RA was made. Medicated with methotrexate and prescribed physical therapy and speech therapy in an attempt to recover TMJ movements. Due to great distance of patients' residence to hospital, it was suggested that the FP collaborate in future care.

CONCLUSION:

General practitioners are constantly faced with common signs and symptoms of an apparently benign nature that may be in reality the initial presentation of more complicated conditions. Therefore a holistic approach to the patient is imperative, including an accurate clinical history and clinical examination, complemented by appropriate auxiliary diagnostic tests.

Keywords: arthritis, temporomandibular joint, autoimmune

P-1359

A Case of Nicotine Addiction due to Smokeless Tobacco Use for Hemorrhoids

Mustafa Haki Sucakli, Yasar Kosar

Department of Family Medicine, Kahramanmaras Sutcuimam University, Medical Faculty, Kahramanmaras, Turkey.

Introduction

Maras powder, a kind of smokeless tobacco, is composed of leaves of a plant called *Nicotina Rustica* Linn, grown in the East Mediterranean region of Turkey and called "madness" by local people. It is known that tobacco has been used to treat various diseases. In this report, a case of nicotine addiction due to Maras powder use for the treatment of hemorrhoids will be presented.

Case

A 54-year-old woman presented to our outpatient clinic for the treatment of Maras powder addiction. She had been using Maras powder for 24 years. She first used Maras powder to stop her rectal bleeding and pain due to hemorrhoids when her sister suggested using it 25 years ago. She reported that the powder relieved her pain and stopped her bleeding for a while, but that her complaints recurred later. The patient, who had not told any doctors about her 24-year history of Maras powder use, admitted her habit when she presented to our outpatient clinic. When she told to use a packet of the powder every day, she was admitted to the outpatient clinic for the treatment of her addiction.

Familial history showed no pathological conditions. History and physical examination revealed nicotine addiction and stage two internal hemorrhoids.

Discussion and Conclusion

The patient reported here also used a kind of tobacco, i.e. Maras powder, to treat her hemorrhoids and she benefited from vasoconstrictor effects of nicotine and relieved her symptoms. However, she became a nicotine addict. Family physicians should adopt a biopsychosocial approach to achieve an effective therapy of tobacco addiction. They should create an appropriate environment which will allow them to diagnose and treat similar cases to the one presented here. They should also help society to become aware that nicotine products cannot treat any diseases.

Keywords: Maras powder (Smokeless Tobacco), nicotine, family physicians

P-1360

Relationship Between Social Tendencies And Depression Scores In Age Of 11-17 Adolescent

Elif Cirit, Ismail Arslan, Nuri Şengüleroğlu, Oğuz Tekin

Department of Family Medicine, Ankara Training and Research Hospital, Ankara, Turkey

Background & AIM: Adolescence is a period that remarkable biological, psychological and social changes happen. In the socialization process, adolescents adapt with many situations to reach the adult model. This adaptation is established with family, friends, schoolmates and other people. One of the most difficult development task in adolescence is related to social consistency. We aimed to investigate the relationship between social tendencies of adolescents and depression scores in the 11-17 age range in our study.

METHOD: In our study, 280 adolescents, were included who admitted to family medicine department of Ankara Training and Research Hospital on 01 September to 30 November 2014. Participants filled informed consent form. Fatih-Scale of Social Tendencies-Adult version and Depression Scale for Children were performed to adolescents.

RESULTS: The participants were 111 men and 169 women. The average age was 15 ± 2 years for men and 15.3 ± 1.8 years for women. Three factors of Fatih-Scale of Social Tendencies-Adult version (Social adaptation & status $p=0.29$, avoiding of violence $p=0.02$, aims & ideas $p=0.23$) were significantly higher in women. Negative correlation was detected between childhood depression scale scores and Fatih-Scale of Social Tendencies-Adult version scores. (social adaptation&status $N=280$ $r=-0.387$ $p<0.001$, avoiding of substance $N=280$ $r=-0.335$ $p<0.001$,

avoiding of violence N=280 $r=-0.399$ $p<0.001$, school status N=280 $r=-0.490$ $p<0.001$, family status N=280 $r=-0.491$ $p<0.001$, aims & ideas N=280 $r=-0.330$ $p<0.001$)

CONCLUSIONS: Social consistency scores were higher in women and this may suggests that male gender is a risk factor for social consistency. Increased depression scores were observed with decreased social consistency. For this reason, it is really important to early diagnose and treat depression; and likewise depression is a considerable diagnosis for adolescents who have lower social consistency.

Keywords: Adolescent, Social Tendencies, Depression

P-1361

Scale Adjustment for the Examination of the Relationship between the Emotional State of an Individual and Having a Pet

Kürşad Akkaya, Dilek Güldal

Department of Family Medicine, Dokuz Eylül University, Izmir, Turkey

Throughout the history, pets played an important role in human life. Even though domestic and friendly animals exist in people's lives for a long time, thoughts on pets' effect on human health have come about only recently. In the studies of treatments with animal support, the benefits of interaction with friendly, trained and well-groomed animals are shown. Despite the contradictory results, it was observed that people who have dogs have better health than people who don't due to walks they have with their dogs. The objective of this study was to find out the validity and reliability of the Poresky's "companion animal bonding scale" in Turkish language.

METHOD: In this methodological study, translation and a re-translation was performed. The data was analyzed in SPSS 15 program. In order to measure the external validity, Lexington Attachment to Pets scale was used. Reliability and validity in Turkish language of latter scale was done by Hacer Karameşe. For measuring reliability, split half and cronbach alpha analyses were used.

RESULTS: In order to measure the scale validity and reliability our survey was applied to 46 pet owners. For external validity, the correlation analysis between two scales was done and the Pearson correlation value was found to be -0.568. The reason of the negative result was because in one of the scales the dependence increases as the points increase but in the other one dependence decreases as the points increase. Regarding reliability tests; the Split half Spearman-Brown value was 0.855 and the Cronbach alpha value was 0.818.

CONCLUSION: The companion animal bonding scale was concluded to be highly reliably and valid in Turkish.

Keywords: pet, scale adjustment, emotional state

P-1362

Do Literacy Levels Effect Use of Primary Care in Adults with Acute Diseases?

Selami Doğan¹, Nuray Doğan², Erdiñç Yavuz³, Erol Yayla⁴, Raziye Şule Gümüştakım⁵

¹4th Family Healthcare Center Bayraklı İzmir Turkey

²Digor State Hospital Kars Turkey

³1st Family Healthcare Center Rize Turkey

⁴5th Family Healthcare Center Afyon Turkey

⁵Sarıselvililer State Hospital Karaman Turkey

Primary care in Turkey has undergone a substantial change since 2010 and now approximately 22.000 family physicians serve whole nation at 6.756 family health care centers. It was reported that use of healthcare systems was affected by patients' socioeconomic status, their previous experience related to health care, whether they have social security, distance to health care facilities, reputation of these facilities. In this study we aimed to investigate the effect of literacy on use of health care for acute illness which we considered that it may be better related with health perception of the individuals.

The study design was retrospective. Adults 18 years of age or older who admitted to Bayraklı Healthcare Center between 1.10.2010-1.1.2014 for acute reasons were included in the study. Patients with chronic diseases were excluded. WHO definition of chronic disease was used. Literacy levels of the study patients were divided into eight individual groups from illiterate to post-graduate and compared with the number of their and the number of drugs prescribed.

Mean age of the patients was 35,84 years; 55,5% of them were male and 44,5% of them were female. Majority of the patients were graduated from elementary school (54,6%). Only 6,8% of the patients had a university degree. The percentage of illiterate patients was 1,2%. Our results showed that as age increased frequency of admittance was also increased but this difference did not reach statistical significance ($p=0,388$). As age increased the number of drugs prescribed also increased ($p=0,0001$). Our results showed that as literacy levels declined the number of drugs prescribed increased and it was statistically significant between all literacy levels. The frequency of admittance also increased but this difference did not reach statistical significance ($p=0,150$).

Keywords: literacy levels primary care

P-1363

69th years old man with different diseases in relation with only one diagnose

Sandra Murgui Betran, Laia Gené Huguet, Amparo Hervas Docon
CAPSE, CAP Comte Borrell, Barcelona, Spain

CASE SCOPE:

Primary Health Care, Specialized Care and Emergency.

REASONS FOR CONSULTATION

The patient has had cough, fever and asthenia during some days; he was visited by his private pneumologist, in the Primary Health Center and in emergency room for several times. He did not improve despite the treatments recommended.

CLINICAL HISTORY

Individual approach

Personal BACKGROUND: Bronchial allergic asthma of 5 years of evolution, nasal severe polyposis during 10 years, and two vein profound thrombosis in the last year.

Anamnesis: 69th years old man affected for cough, fever, arthralgia and asthenia that need a lot of medical visits.

Physical exploration: Few pitting edemas, 37.6°C fever, anodyne the rest.

Complementary explorations: Chest radiography normal; urine test with proteins, hemoglobin and kappa light chains; test blood with rise PCR, VSG and eosinophils, monoclonal gammopathy with kappa IgG chains, rheumatoid factor positive, lupic anticoagulant positive, IgG anticardiolipine positive, IGM anticardiolipine negative; biopsy inform of nerve with necrotic vasculitis with fibrinoid necrosis affecting medium diameter vein, muscle with denervation phenomenon and re innervation; electromyogram inform of axonopathic polyneuropathy with severe sensitive affection.

CLINIC JUDGEMENT, DIFFERENTIAL DIAGNOSIS, PROBLEMS IDENTIFICATION

After several urgency visits for his symptomatology, with abnormal test results, and with the pathological background of the patient, it suggests the possibility of a vasculitis. The diagnose is confirmed for Churg-Strauss syndrome.

TREATMENT, ACTUATION PLANS

Follow-up and pharmacological treatment is carried out by autoimmune diseases service of internal medicine in the hospital.

EVOLUTION

Currently, the patient is stable, even though worsening of respiratory episodes and peripheral neuropathy.

CONCLUSIONS

The applicability for Family and Communitarian Medicine is based in the opportunity for a evaluation with a global vision of all the background, symptoms and different diseases of one patient, thus allowing the realization of a single diagnosis.

Keywords: S Vasculitis, Churg-Strauss syndrome, eosinophilia.

Diagnosis criteria

American college of rheumatology criteria*

Asthma (a history of wheezing or the finding of diffuse high-pitched wheezes on expiration)

Eosinophilia >10 percent on differential white blood cell count

Mononeuropathy (including multiplex) or polyneuropathy

Migratory or transient pulmonary opacities detected radiographically

Paranasal sinus abnormality

Biopsy containing a blood vessel showing the accumulation of eosinophils in extravascular areas

*Four of the six criteria needed and biopsy evidence of vasculitis

P-1364

Acenocumarol management in primary care

Jose María Fernandez Gonzalez¹, Pedro Guijo Gonzalez², Inmaculada Saucó Colon³

¹HEALTH CENTER OF LA GRANJA-MANUEL BLANCO, HOSPITAL OF JEREZ DE LA FRONTERA.

²INTENSIVE CARE UNIT HOSPITAL OF JEREZ DE LA FRONTERA

³HEALTH CENTER OF SAN BENITO, HOSPITAL OF JEREZ DE LA FRONTERA.

OBJECTIVE:

To describe the INR values of patients of two health centers (HC) anticoagulated with Acenocumarol.

MATERIAL AND METHODS

Retrospective cross-sectional study.

Scope: Primary Care. N: 45000.

Inclusion: Patients on anticoagulant therapy during a year in monitoring in Primary Care

Main variables:

- INR values.
- Anticoagulant Treatment: acenocumarol.
- Secondary Variables: sex, age range
- INR in therapeutic range (TR): 2-3;
- Patients with appropriate control INR: INR values in TR above 60% in 6 months (depending on the Spanish Agency for medication).

Registration: Excel table. Analysis: statistical program IPSS.

Description variables: quantitative measures central tendency and dispersion.

Qualitative: proportions; comparison: quantitative: t-student; qualitative chi-square.

Registration-based study in medical history with limitations of possible miss registration.

Anonymous data and treaties jointly

RESULTS

Patients In treatment with acenocumarol =734, Women: 468 (55 %), mean age 78 years.

Number controls INR=2852. arithmetic mean INR Average: 2.6. Women 78 % (2225); Men 22 % (627)

Percentage of controls with INR in RT according to sex: Women 48 %, men 45% (p: 0.1751)

Percentage of controls with an INR in RT according to age range: less than 70 years=3.2 %, between 70-90 years=64.3 %; older than 90 years=32.5 % (p: 0.0001).

Number of patients with registration of INR= 172 (23.4 %)

Of 172 patients, 114 (66 %) have the average of INR on TR.

Number of patients with more than 6 records of INR= 125, represents the 17% (125/734) of the patients.

With adequate control of INR (of 125) = 30 (24 %)

CONCLUSION

We are more controls of INR in women, but there isn't difference in the percentage of INR in therapeutic range.

25% of our patients has a INR control appropriate according to the Spanish Agency for medication.

Keywords: ACENOCUMAROL, PRIMARY, CARE

P-1365

Implementing an ultrasound service in primary care

A Carolina Berengue González, Adriana Ramos Ordoñez, Esther Casanovas Cuquet, Raquel Masvidal Moreno

Institut Catalá de la Salut, ABS Pineda de Mar, Barcelona, Spain

In 2014, was carried out a project called "EcoAP Project" which was based on abdominal ultrasound implement a Primary Care Team (PCT).

OBJECTIVE: Implement the abdominal ultrasound service in PCT.

Inclusion criteria was performed answering the following questions in order to select the suitable patients for being include in the Project:

- Nephritic colic: Discards / confirms obstructions?
- Gallstones: Discards / confirms stones / biliary obstructions?
- Hematuria: Discards / confirmed bladder injuries?
- Liver -Study: Discards / confirmed hepatic steatosis?
- Benign Prostatic hyperplasia: volume and voiding residue. Help therapeutic and management?

The work plan of the Project was focused in two phases:

The first phase, was focused in training a medical team to performe an abdominal ultrasound in order to track the patients by a sonographer, and to valorate if they have to referral at the hospital, where they were consulted in case of any doubts.

The second phase consisted in to implement the first 50 cases that were monitored with final assessment.

RESULTS:

- EcoAP cited: 54
- EcoAP made: 52
- EcoAP reasons:
 - Nephritic colic: Discards / confirms obstructions? 14
 - Gallstones: Discards / confirms stones / biliary obstructions? 5
 - Hematuria: Discards / confirmed bladder injuries? 3
 - Liver -Study: Discards / confirmed hepatic steatosis? 21
 - Benign Prostatic hyperplasiatate volume and voiding residue. Help therapeutic and management? 9
- EcoAP normal: 20
- EcoAP pathological: 32
- EcoAP: technical difficulty 5

CONCLUSIONS:

Each EcoAP made was sent to their referring doctor for follow up.

The primary care team has aimed to continue growing, increasing EcoAP template and stimulate new tecnologies applicable to primary care.

Keywords: EcoAP, abdominal ultrasound, primary care team,

The ultrasound in our Primary Care Center



The ultrasound in our Primary Care Center

EcoAP performed

EcoAP normal 20

EcoAP pathological 32

EcoAP: technical difficulty 5

Are the EcoAP performed during the implementation

The ultrasound in our Primary Care Center



The ultrasound in our Primary Care Center

EcoAP reasons

Nephritic colic: Discards / confirms obstructions? 14

Gallstones: Discards / confirms stones / biliary obstructions? 5

Hematuria: Discards / confirmed bladder injuries? 3

Liver -Study: Discards / confirmed hepatic steatosis? 21

Benign Prostatic hyperplasia volume and voiding residue. Help therapeutic and management? 9

The EcoAP with the inclusion's criteria

P-1366

Patient with hyperglycemia in a hospital emergency department

Jose María Fernandez Gonzalez¹, Cristina Bitaube Mata², Mauricio Ramirez Temblador³

¹HEALTH CENTER OF LA GRANJA-MANUEL BLANCO, HOSPITAL OF JEREZ DE LA FRONTERA.

²EMERGENCIAS HOSPITAL SERVICIO ANDALUZ DE SALUD DE JEREZ DE LA FRONTERA

³EMERGENCIAS HOSPITAL PUERTA DEL SUR JEREZ DE LA FRONTERA

OBJECTIVES

The hyperglycemia is an important health problem both because of its high prevalence and the associated complications.

OBJECTIVES: To describe the clinical profile of the sick consultation at a Hospital Emergency Department by hyperglycemia and analyze the actions on the treatment to the hypoglycaemic high.

MATERIAL AND METHOD

Retrospective study conducted at the Emergency Department. Consecutive patients were included served during a period of six months by hyperglycemia.

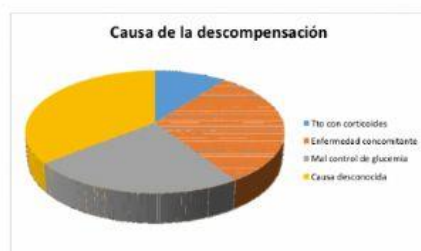
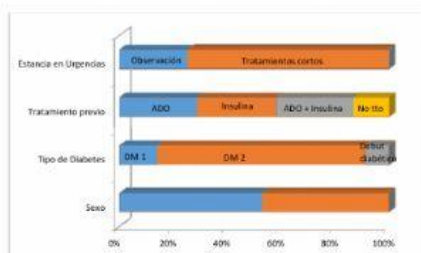
RESULTS

A total of 115 patients were analyzed, 70 women and 45 men. The mean age was 60.5±18.9 years. 16 Patients had a diagnosis of type 1 DM (13.9 %), 89 DM type 2 (77.4 %) and 10 diabetic presented debut (8.7 %). The average blood glucose level was 422.9 ± 132.8 mg/dL[196-963]. The 28.7 % were treated with oral antidiabetic agents. The 29.6 % with insulin, and 28.7 % in combined treatment. A 13% did not treatment. 29 (25.2 %) went to observation, 13 (11.3 %) presented ketoacidosis. The 10.4 % were previously treated with corticosteroids; 30.4 % had a concomitant disease; 23.5 % had poor control of your blood sugar and a 35.7 % did not know the cause of decompensation. 65 Patients (56.5 %) were referred to your primary care physician, 17.4 per cent to his home and a 19.1 % required hospitalization. The remaining 7% was allocated to external consultations or another hospital. Only 22,6 % introduced a modification of the antidiabetic treatment to the usual high.

CONCLUSIONS: patients with hyperglycemia seen in the Emergency Room are derived in its majority to your primary care physician for further control. The predominant clinical profile was women with type 2 diabetes mellitus and pre-treatment. Most of the treatments were not modified.

Keywords: Hypoglycemic Agents, Diabetes mellitus

IMAGE 1



P-1367

Three Cases of Allergic Contact Dermatitis Induced by Nitrofurazone

Gülben Sarıcı¹, Yasemin Korkut²

¹Department of Dermatology, Dumlupınar University, Kütahya, Turkey

²Department of Family Medicine, Dumlupınar University, Kütahya, Turkey

AIM:

Topical nitrofurazone frequently causes severe allergic contact dermatitis(ACD),necessitating hospitalization.ACD is a delayed–type hypersensitivity reaction that is elicited when the skin comes in contact with a chemical to which an individual has previously been sensitized.

Case 1: 40-year-old patient whose hands burned by hot water a month ago was admitted to our clinic due to the not healing of the burn area and severe pruritus.Hand was covered with erythematous vesicles except burned areas in the examination of the patient undergoing dressing with nitrofurazone ointment(Furacin®)since the first day. It was considered that ACD was depending on nitrofurazone.Nitrofurazone treatment was terminated.The patient was hospitalized and then systemic methylprednisolone 40 mg was started.Improvement in symptoms was observed after one week.Steroid therapy is gradually reduced and stopped.

Case 2: There were pruritic,erythematous,squamous plaques spreading to the whole body from the nail of the patient using nitrofurazone ointment due to ingrown nail.It was prominent on the face.Nitrofurazone treatment was terminated.The patient's symptoms were decreased with systemic methylprednisolone.

Case 3: The patient whose right toes amputated due to diabetic foot have begun to pruritus 3 days after starting dressing with nitrofurazone ointment for wound site and it was gradually spread.Nitrofurazone treatment was terminated.The patient was hospitalized and then systemic steroid therapy was started.The symptoms of patients were decreased after 1 week.

CONCLUSION: The use of nitrofurazone was abandoned in most countries due to high in the incidence of contact sensitivity. This topical antibiotics which has a high chance of developing ACD is still used in many countries because it is cheaper and easily accessible.It is necessary to pay attention to such side effects because the use of this agent which causes generalized lesions,usually requires hospitalization and systemic steroids for the treatment of patients is common among family physicians.

Keywords: Nitrofurazone, Dermatit, Patch test

Photo 1: ACD on the hand after burn injury



Photo 2: ACD after ingrown toenail



P-1368

From hiccups to a hidden diagnosis

Melahat Argun¹, Pakize Sucu², Bircan Kanyilmaz¹, Emin Pala¹, Sema Basat³

¹Department of Family Medicine, Umraniye Training and Research Hospital, Istanbul, Turkey

²Department of Pulmonology, Sureyyapasa Center for Chest Diseases and Thoracic Surgery Training and Research Hospital, Istanbul, Turkey

³Department of Internal Medicine, Umraniye Training and Research Hospital, Istanbul, Turkey

A 36 year old man presented to the family medicine clinic with a seven day history of persistent hiccups. He had no history of chronic diseases. On auscultation of the lungs, decreased breath sounds in lower lobes of the right lung were noted. A chest x-ray suggested pleural effusion with a blunting of the costophrenic angle of the right lung. Also there were suspicious opacities in the apical segments of the right upper lobe. For further investigation a computerized tomography was ordered and the result also verified pleural effusion and small calcified opacities and nodular lesions. Having considered the patient's young age, apical calcified lesions and same sided pleural effusion, tuberculosis is suspected and the patient is directed to a thoracic diseases specialized hospital for a comprehensive investigation.

Hiccups are usually precipitated by irritation of the diaphragm and/or stimulation of the vagus nerve. In this patient, irritation of the diaphragm by pleural effusion is resulted in hiccups. Persistent hiccups should be taken serious and investigated carefully to diagnose any hidden pathological cause. Although persistent hiccup is a very rare presentation of tuberculosis, it should not be dismissed since tuberculosis is still a major health problem in developing countries including Turkey. Primary health care physicians should keep in mind that a common symptom such as hiccup could be the tip of the iceberg.

Keywords: hiccups, pleural effusion, pulmonary tuberculosis

Figure 1



Pleural effusion with a blunting of the costophrenic angle of the right lung.

Figure 2



Pleuroparenchymal fibrotic lung sequelae, small calcified opacities and nodular lesions can be seen on chest computed tomography.

P-1369

Assessment of The Forensic Cases Consulting to a University Hospital

Gökhan Eminsoy, Sinem Aydemir, Fisun Sözen, Altuğ Kut

Department of Family Medicine, Baskent University, Ankara, Turkey

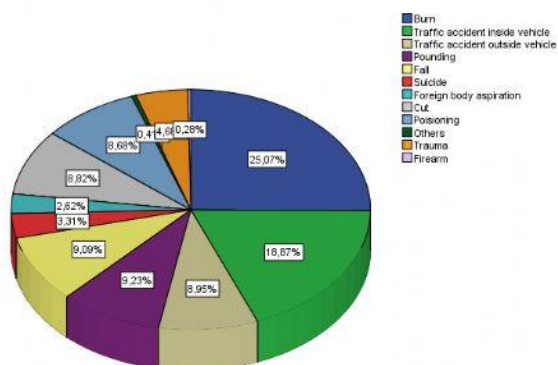
Background & AIM: Family medicine deals with cases involving both the legal and medical aspects of patient care. The aim of this study was to investigate the features related with the referral reasons, sociodemographic features, judicial profiles and occurring date and time of all the child and adolescent forensic cases who were referred to university hospital. In this study, we aimed to draw attention to the forensic issues by retrospective investigation of 726 forensic cases.

METHOD: This retrospective study was conducted in a university Family Medicine Department in Ankara, Turkey. The data were collected from official hospital forensic reports. Patients' forensic sheets who applied to Başkent University Ankara Hospital in October 2013 and January, April and July 2014 were investigated for referral reasons, sociodemographic features, judicial profiles and occurring date and time.

RESULTS: 726 forensic cases admitted to Baskent University Hospital were evaluated. 25,1% were burns, 17,9% were traffic accidents, 16,7% were industrial accidents, 9,2 were beaten, 9,1 were falling down and 22% were the others like finger cuts, poisonings, traumas, suicides, object aspirations and gunshot wounds. 31,3% of the burn

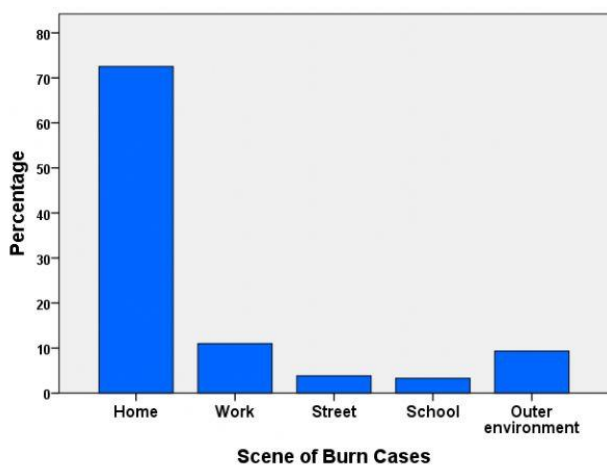
cases were tea scalds, median age was 15 (min:2;max:80) and 43,8% of them occurred between 18:01-24:00 pm.
CONCLUSIONS: The causes, referral reasons, sociodemographic features, judicial profiles and occurring date and time of forensic cases are very important when evaluating patient in Family Medicine practice. Primary care physicians have to handle both medical and forensic needs of their patients.
Keywords: Family medicine, forensic medicine, burns, accidents, violence, suicide, poisoning.

Figure 1



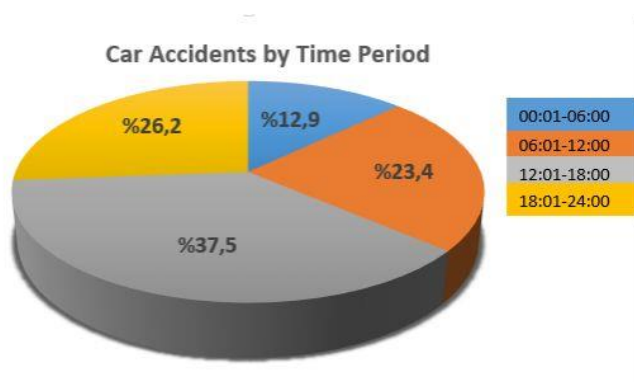
Distribution of cases according to the cause of urgency attending BaÅŸkent University Emergency Room

Figure 2



Percentage of tea scald burns by the scene

Figure 3



Car accidents by Time Period

P-1370

Status of health workers to join a union, Status of Anxiety And Job Satisfaction Study: First Results

Muhteber Çolak¹, Özden Gökdemir¹, Ergün Akyol², Nilgün Özçakar¹

¹Dokuz Eylül University, Medical Faculty, Family Medicine Department, İzmir, Turkey

²Menderes Public Health Center, İzmir, Turkey

Background&AIM:

Workers are struggling to provide safe and healthy working environment for many years. Unions at the forefront in this regard, have been emerged to cover and protect economic, social and political rights of all employees. All employees are influenced by the situation in the working environment vice versa work environment, job satisfaction, work satisfaction levels also affects working environment.

For better working conditions and health workers' being healthy, it's necessary to define the perspectives of employees objectively.

Our aim is to determine health care workers' being a union member or not, their level of job satisfaction and anxiety.

Methods

Volunteered health workers working at a university hospital included this cross-sectional descriptive study to determine job satisfaction by "Minnesota Job Satisfaction Questionnaire(MSQ)", and anxiety by "State-Trait Anxiety Inventory(STAI)".

Descriptive statistical analysis of the data was performed using SPSS 15.0 software as well as the chi-square and t tests. $p < 0.05$ was considered significant.

Results

According to initial findings of the participants 53(55%) were female, 44(55%) were married and mean age was 35.71 ± 8.47 (min:24-max:60)($n=80$). Mean of years worked is found 11.25 ± 8.84 (min:1-max:32). Doctors' (53)66.3% were more than nurses (8)10%.

Majority of them (58)72.5% stated that they are member of a union. Causes of being a member were stated as "to be organized", "defend my rights and to be strong together" and "to be contributions to the professional development".

Being not a member of a union was stated as "undecided", "do not trust the community," "I find it unsatisfactory".

MSQ total score mean was 3.4(min:2.15-max:4.60). STAI mean scores were 40.98 ± 9.84 (min:22-max:68) and 42.26 ± 7.56 (min:27-max:60) respectively.

Conclusion

Health care workers' job satisfaction and status of anxiety were moderate according to initial results. There was no difference between being a union member, age, gender, education level and job satisfaction or status of anxiety ($p > 0.05$).

Data collection is ongoing.

Keywords: union membership, anxiety, job satisfaction, health workers

P-1371

Common Mental Disorders amongst Migrant Factory Workers in Urban, Mainland, China

Kendall Anne Searle

Department of Primary Health Care, Monash University, Melbourne, Australia

Background

Over 173 million adults live with some type of mental disorder in China. Estimates suggest that 91% of these adults have never received professional care for their condition. Migrant are particularly unlikely to receive mental health care. This is despite the fact that the nature of their employment (physically demanding; repetitive; long hours; poor conditions; and low wage) and isolation from their usual support network puts them at high risk of developing these complaints.

Objectives: To conduct a systematic review according to the PRISMA 2009 guidelines

Methods: Medline/Ovid SP, EMBASE/Ovid SP, PsychINFO/EBSCO, CINAHL/EBSCO and reference lists were searched for English only articles to May 2014. Inclusions:- i) identified "Migrant Factory Workers" ii) investigated any "common mental disorder" as diagnosed by an internationally recognized standard or a "well-being" proxy marker for good mental health; c) primary research conducted in urban mainland China; d) participants of 16+ years. Exclusions:- Reviews; editorials; letters; commentaries; and PhD reports. All titles, abstracts, and full text articles were independently reviewed by two researchers with non-agreement resolved through discussion. A descriptive data analysis and assessment of bias was performed.

Results: The search yielded 542 articles of which 16 studies (24 articles) were included representing findings from 40,658 participants overall and 30,471 "migrant workers". Factory workers were recruited as part of a household, occupational, community-based or hospital sample or targeted at a factory (6 studies). Guangdong was a key provincial research site with all factory-specific research being conducted in Shenzhen. Research sought to identify risk/protective factors or obtain prevalence estimates. All studies were observational in nature. Prevalence values could not be pooled due to diversity of screening tools, participant profiles, sampling approaches and innate bias from cross-sectional study design. Collectively, these studies identified 29 different risk factors potentially associated with poor mental health outcomes in this population.

Keywords: Migrant Factory Workers; Common Mental Health Disorders, China

Fig 1 Systematic Review Selection Process

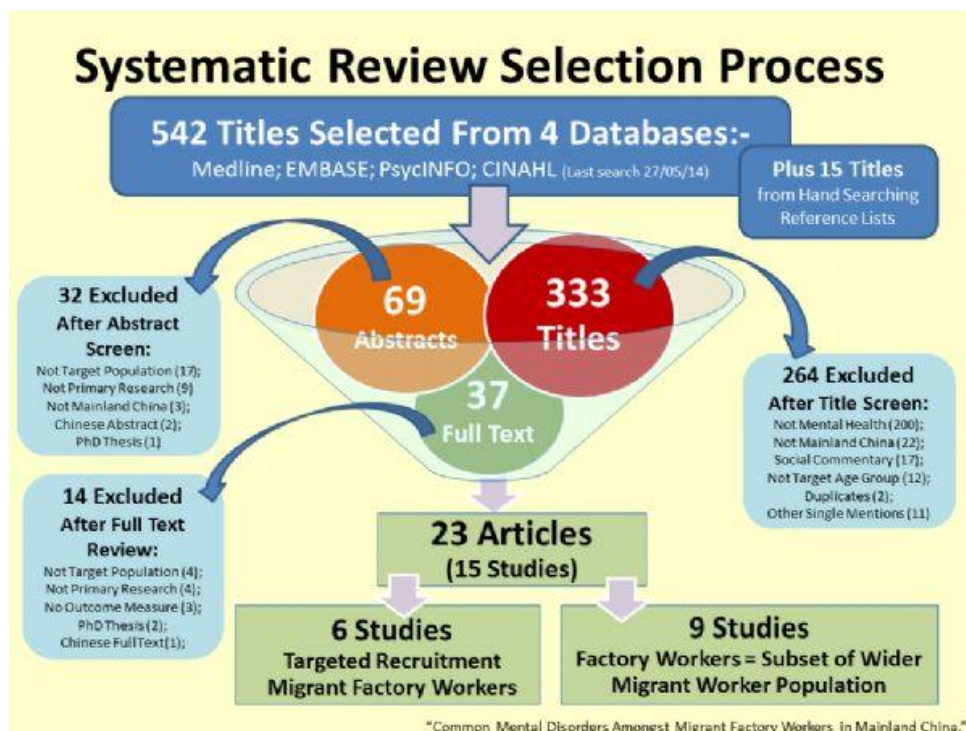


Fig 2 Research Coverage

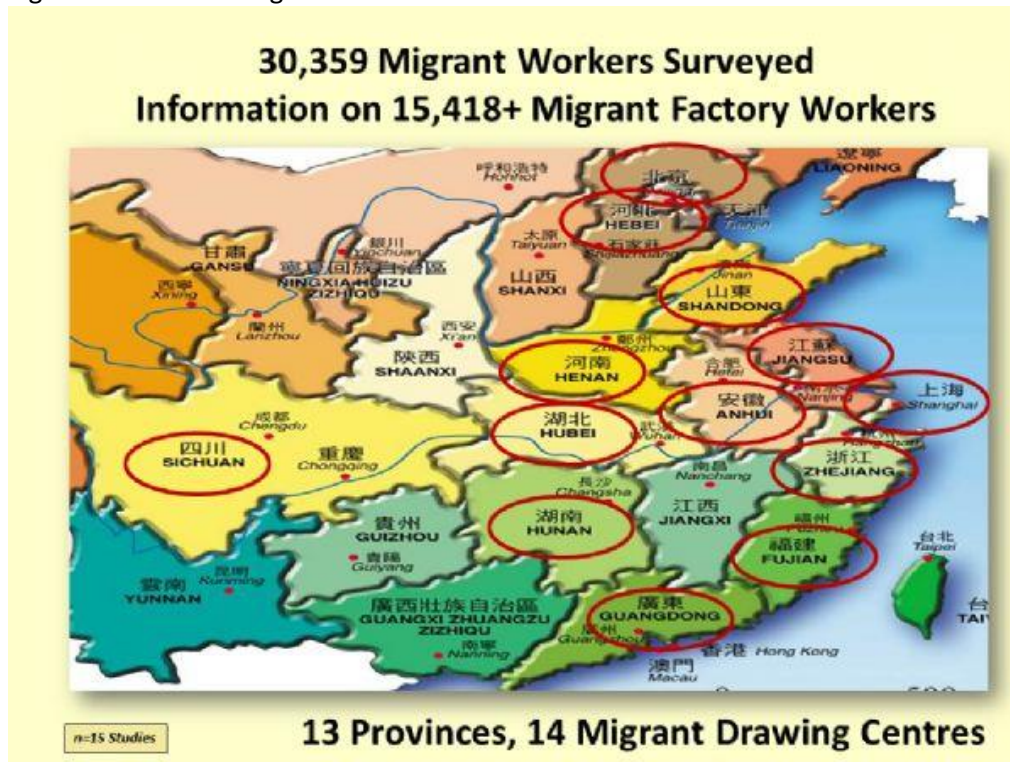


Fig 3 What do we know about the mental health of these migrants?

What do we know about the mental health of migrants working in electronics & textile factories in mainland China?

Prevalence of a Common Mental Disorder

- **Established migrants:**- 21.4% clinically relevant depression symptoms based on CES-D Score (Weissman cut-off of 16).
- **Female only, exclusively dorm-based:**- Lower SF-36 (70.5) than Chinese Female norms (75.5).
- **Female only, majority dorm-based:**- 35% Mentally unhealthy* based on BSI (Ritsner GSI thresholds).
- **Males & females, medium-sized factories:**- More symptoms on SCL-90 (7.71) than permanent residents (2.57).

Risk Factors With Positive Associations (s=15):

- **Demographics:**- young/old; single/married; low/high educational level
- **Migration:**- act of; number of; isolation; separation from partner; increased time in host city;
- **General Health:**- digestive/urinary/gynaecological disease; anaemia; low 2-week morbidity rate; muscular soreness
- **Work Related:**- manual work; long hours; low salary; stress; money difficulties; perception of other workers' salary
- **Interpersonal:**- tensions/conflicts; discrimination; stigma
- **Lifestyle:**- casual smoker; poor social life

1. Mou, J. et al 2011; S=4,088; 2. Zhu, C. et al 2012/13; S=5,084; 3. He, X. et al (2001); p S=958; 4. Shen, Q. et al 1998; S=471

Fig 4 References for Articles Included in this Systematic Review

References For Articles Included in the Systematic Review

1. Akay A, Bargain O, Zimmermann KF. Relative concerns of rural-to-urban migrants in China. *Journal of Economic Behavior & Organization* 2012; **81**(2): 421-41.
2. Chen J. Perceived discrimination and subjective well-being among rural-to-urban migrants in China. *Journal of Sociology and Social Welfare* 2013; **40**(1): 131-56.
3. Chen X, Stanton B, Li X, Fang X, Lin D. Substance use among rural-to-urban migrants in China: A moderation effect model analysis. *Substance Use & Misuse* 2008; **43**(1): 105-24.
4. He X, Keung Wong DF. A comparison of female migrant workers' mental health in four cities in China. *International Journal of Social Psychiatry* 2013; **59**(2): 114-22.
5. Li L, Wang H-m, Ye X-j, Jiang M-m, Lou Q-y, Hesketh T. The mental health status of Chinese rural-urban migrant workers: Comparison with permanent urban and rural dwellers. *Social Psychiatry and Psychiatric Epidemiology* 2007; **42**(9): 716-22.
6. Lu L, Zou G, Zeng Z, Han L, Guo Y, Ling L. Health-related quality of life and its correlates among Chinese migrants in small-and medium-sized enterprises in two cities of Guangdong. *PLoS ONE* 2014; **9**(1).
7. Mou J, Cheng J, Griffiths SM, Wong SY, Hillier S, Zhang D. Internal migration and depressive symptoms among migrant factory workers in Shenzhen, China. *Journal of Community Psychology* 2011; **39**(2): 212-30.
8. Nielsen I, Smyth R, Zhai Q. Subjective well-being of China's off-farm migrants. *Journal of Happiness Studies* 2010; **11**(3): 315-33.
9. Qiu P, Caine E, Yang Y, Chen Q, Li J, Ma X. Depression and associated factors in internal migrant workers in China. *Journal of Affective Disorders* 2011; **134**(1-3): 198-207.
10. Shen Q, Lu YW, Hu CY, et al. A preliminary study of the mental health of young migrant workers in Shenzhen. *Psychiatry & Clinical Neurosciences* 1998; **52** Suppl: S370-3.
11. Wong DFK, Chang Y-L. Mental health of Chinese migrant workers in factories in Shenzhen, China: Effects of migration stress and social competence. *Social Work in Mental Health* 2010; **8**(4): 305-18.
12. Wong DFK, He X, Leung G, Lau Y, Chang Y. Mental health of migrant workers in China: prevalence and correlates. *Social Psychiatry and Psychiatric Epidemiology* 2008; **43**(6): 483-9.
13. Yang T, Xu X, Li M, Rockett IR, Zhu W, Ellison-Barnes A. Mental health status and related characteristics of Chinese male rural-urban migrant workers. *Community Mental Health Journal* 2012; **48**(3): 342-51.
14. Zhang J, Li X, Fang X, Xiong Q. Discrimination experience and quality of life among rural-to-urban migrants in China: The mediation effect of expectation-reality discrepancy. *Quality of Life Research: An International Journal of Quality of Life Aspects of Treatment, Care & Rehabilitation* 2009; **18**(3): 291-300.
15. Zhu C, Geng Q, Yang H, Chen L, Fu X, Jiang W. Quality of life in China rural-to-urban female migrant factory workers: a before-and-after study. *Health & Quality of Life Outcomes* 2013; **11**: 123

P-1372

Reviewing The Specific Problem Solving Core Competency of Family Medicine Discipline with a Case Example

Yelda Zeliha Özer, Hatice Kurdak

Department of Family Medicine, Cukurova University, Adana, Turkey

AIM: A case will be discussed in the context of specific problem solving core competency.

METHOD: A twenty-nine years old man applied to our clinic. His request: getting a medical certificate, his concern: getting it in a short time. He didn't have any active complaints or previously detected diseases. Upon further acquaintance, it was discovered that he was an international-postgraduate student hurrying to report his medical forms to extend his stay in the country (the context). There were no special circumstances regarding his medical history. His physical examination was normal except for a 0.5x0.5cm mobile non-rigid bilateral submandibular lymphadenopathy.

RESULTS: Blood tests were performed according to the medical certificate and mild neutropenia was detected. After this a peripheral blood smear was done where the results were normal and no atypical cells were observed (Crombie's eliminative diagnosis). When valid evidence that is relevant to this situation was searched, it was discovered that Benign Ethnic Neutropenia had high prevalence in Africans (patient-oriented evidence that matter-POEM). After a hematology consultation the tests were repeated one month later and the results were approximately the same (Table 1).

DISCUSSION: This case is a good example of "low prevalence medicine" and "quaternary protection". Neutropenia diagnosis includes an algorithm ranging from complete blood count to bone marrow aspiration biopsy. Understanding the applicants' contexts and using POEM may protect them from unnecessary examinations and being labeled as 'patients'. This core competency requires the ability of relating specific decision making processes to the prevalence/incidence of illness in the community; selectively gathering and interpreting information and applying it to an appropriate management plan in collaboration with the patient; adopting incremental investigation, using time as a tool and tolerating uncertainty; intervene urgently when necessary; making effective and efficient use of diagnostic and therapeutic interventions.

Keywords: Neutropenia, specific problem solving, low prevalence medicine, quaternary protection.

Table 1

	Initial	Control
White Blood Cell	3.3 μ /L	3.5 μ /L
Neutrophil	39.8%	41%
Lymphocyte	47.3%	46.5%
Hemoglobin	14 g/dL	14.5 g/dL
Hematocrit	41.4%	44%
Red Blood Cell Distribution Width	14%	13.7%
Fasting Plasma Glucose	99 mg/dL	
BUN	9 mg/dL	
Creatinine	1.01 mg/dL	
AST	13 U/L	
ALT	6 U/L	
HBsAg	(-)	
Anti-HBs	(-)	
Total HAV-Ab	(+)	
Anti-HIV	(-)	
Fe+2		101 μ gr/dL
Ferritin		28.6 ng/mL
Vitamin B12		416 pg/mL
Folic acid		6.36 ng/mL
Sedimentation	Within the normal limits	
Urinalysis	Within the normal limits	

Blood analysis results

Patient Oriented Medical Record in SOAPE style

POMR

Progress Note

Date: 12.12.2014

Age: 29

Name: M. H.

Problem# 1

Problem title: Neutropenia

S
ubjective Information

1. Getting a medical report (urgently)
2. Deportation concern

O
bjective Information

1. Submandibular, non-rigid, bilateral lymphadenopathy ($\approx 0,5 \times 0,5$ cm)
2. Low BMI (Body Mass Index)
3. HBsAg (-) and Anti-HBs (-)
4. Benign Ethnic Neutropenia (BEN) preliminary diagnosis

A
ssessment

Diagnosis: BEN

P
lan

1. Examinations: Complete blood count, plasma iron, iron binding capacity, ferritin, folate, vitamin B12
2. Rp: The second dose of hepatitis B vaccine
3. Setting a date for the third dose of vaccine
4. Healthy nutrition and exercise counseling

E
ducation

About BEN, immunization, healthy nutrition and exercise

P-1373

Awareness of Late Adolescents With a Diabetic Family Member of Their Health Risks

Zeliha Özbakır, Altuğ Kut, Yasemin Çetinel, Fisun Sözen, Sinem Aydınay

Department of Family Medicine, Başkent University, Ankara, Tukey

BACKGROUND: Late adolescence is thought to be a period an adolescent establish the way of thinking and attitude. A diabetic member in a family influences the others as well, mostly the children and adolescents. The aim of this study is to assess the awareness of late adolescents who has a diabetic relative of the health risk factors related to this.

METHODS: This is a sectional type epidemiological study. This study is conducted in Ankara Baskent University with randomly chosen voluntarily participated 385 late adolescent between January 2015 and March 2015. Participants were given a questionnaire of 33 questions which aimed to determine their demographical characteristics, their habits related to diet and exercise and their knowledge, attitude and behavior about diabetes mellitus together with short form of Health Anxiety Scale. The participants were grouped into two as the ones with a diabetic member in their family and ones without. Data analysed via SPSS (Statistical Package For Social Sciences for Windows v.22,0, SPSS Inc. Chicago, IL) In addition to descriptive analysis Chi-square test, Yates corrected chi-square test and Fischer’s exact test are used with a statistical significance level of $p < 0.05$.

RESULTS: The healthy snack food choices of the late adolescents with a diabetic member in their family were significantly different from the other group’s. ($p < 0.001$) Attitude of the late adolescents who have a diabetic member in their family towards “The things a person with a risk of diabetes mellitus should care about his diet to decrease the risk” was significantly more correct from the other group ($p = 0.004$).

CONCLUSION: Late adolescents with a diabetic family member are not sufficiently aware of the health risks they have due to this. Improvement of the awareness and behavior of the late adolescents with a diabetic family member will be a preventive action towards diabetes mellitus.

Keywords: Diabetes Mellitus, Late Adolescent, Health Risk, Awareness

Table 1. Demographic Characteristics, diet and exercise of those late adolescence by family DM Assets

	DM Family Assets		
	Yes (n=229) Number (%)	No (n=156) Number (%)	
Sex			
Man	65 (28,4)	51 (32,7)	0,366
Woman	164 (71,6)	105 (67,3)	
Living situation together with the family			
Lives	118 (51,5)	78 (50,0)	0,768
Do not live	111 (48,5)	78 (50,0)	
Presence of Chronic Diseases			
Yes	41 (17,9)	25 (16,0)	0,631
No	188 (82,1)	131 (84,0)	
Smoking			
Yes	73 (31,9)	48 (30,8)	0,818
No	156 (68,1)	108 (69,2)	
Alcohol Use			
Yes	86 (37,6)	61 (39,1)	0,759
No	143 (62,4)	95 (60,9)	
Motivations Health Check Availability			
Yes	217 (94,8)	148 (94,9)	0,998
No	12 (5,2)	8 (5,1)	
Have Weight Problems Thinking			
Yes	89 (38,5)	60 (38,5)	0,936
No	140 (61,1)	96 (61,5)	
Diet program implementation			
Yes	65 (28,5)	41 (26,3)	0,632
No	163 (71,5)	115 (73,7)	
Sedentary Status			
Yes	103 (45,0)	85 (54,5)	0,067
No	126 (55,0)	71 (45,5)	
Snack Making Status			
Yes	150 (60,7)	97 (62,3)	0,504
No	79 (34,2)	59 (37,7)	

Table 2. Distribution of late adolescents snack options

DM Family Assets			
	Yes (n=229)	No (n=156)	P
	Number (%*)	Number (%*)	
Snack choices (n=381)			
<u>Waffles, bagels, pastries, pies, etc.</u>	81 (57,9)	59 (42,1)	
Fruit with milk or yogurt	102 (73,9)	36 (26,1)	<0,001
<u>Only fruit / dried fruit</u>	34 (39,5)	52 (60,5)	
<u>Fizzy drinks / Fruit Juices</u>	10 (58,8)	7 (41,2)	

Table 3. The distribution of responses given by late adolescents to questions about knowledge, attitude and behavior

DM Family Assets			
	Yes (n=229)	No (n=156)	P
	Number (%*)	Number (%*)	
Knowledge Questions			
Symptoms which don't point out DM particularly (n=385)			
Those who know	151 (65,9)	91 (58,3)	0,129
Those who do not know	78 (34,1)	65 (41,7)	
People who are under risk especially for DM (n=385)			
Those who know	48 (21,0)	26 (16,7)	0,294
Those who do not know	181 (79,0)	130 (83,3)	
Attitude Questions			
The frequency of applying to PhD of people who have DM risk (n=385)			
Those who know	22 (9,6)	12 (7,7)	0,516
Those who do not know	207 (90,4)	144 (92,3)	
The frequency of exercise that of people who have DM risk must do (n=385)			
Those who know	94 (41,0)	55 (35,3)	0,252
Those who do not know	135 (59,0)	101 (64,7)	
The things that must be taken care of by people who have DM risk (n=385)			
Those who know	181 (79,0)	103 (66,0)	0,004
Those who do not know	48 (21,0)	53 (34,0)	
Behavioral Questions			
The behavior which is not seen as important to reduce DM (n=385)			
Those who know	40 (17,5)	23 (14,7)	0,478
Those who do not know	189 (82,5)	133 (85,3)	
The planning method of feeding (n=385)			
Those who know	59 (25,8)	45 (28,8)	0,504
Those who do not know	170 (74,2)	111 (71,2)	
The behaviors to reduce the risk for becoming DM (n=385)			
Those who know	137 (59,8)	104 (66,7)	0,173
Those who do not know	92 (40,2)	52 (33,3)	

Table 4. The distribution of adolescent Health Anxiety Inventory scores

Health Anxiety Inventory Scores			
DM Family Assets	Normal	High	p
Yes	180 (% 58,1)	49 (% 65,3)	
No	130 (% 41,9)	26 (% 16,7)	

P-1374

Vaccination After Chemotherapy

Burcu Başaran¹, Çiğdem Apaydın Kaya¹, Perran Boran²

¹Department of Family Medicine, Marmara University, Istanbul, Turkey

²Department of Pediatrics, Marmara University, Istanbul, Turkey

BACKGROUND: Cancer affects children of all ages who may be at any stage of the childhood immunization schedule. Children who have not completed primary immunizations due to cancer and chemotherapy are particularly susceptible to vaccine-preventable infections. Chemotherapy causes immune depression in children and the vaccine activity is reduced. We present a case whose vaccination schedule have not completed due to cancer and chemotherapy.

CASE: A child, 4 years 4 months old, diagnosed as neuroblastoma stage 3 while he was 18 months old, came to the healthy child department after finishing his chemotherapy and radiotherapy; to complete the missing vaccinations. He had his last chemotherapy while he was 3 years 3 months old. The last vaccination had done while he was 12 months. After hemogram control, as it was normal; we decided to go on by the rutin vaccination schedule, and we planned to do 18 months vaccines diphtheria-tetanus-pertussis, haemophilus influenza and inactive poliomyelitis (DaPT-Hib-IPV). After serology control as Anti-HBS was negative, Hepatitis B virus vaccine was done as 3 dose. Because of we had done inactive poliomyelitis vaccine (IPV) before we haven't done oral poliomyelitis vaccine (OPV). We repeated conjugated pneumococcus vaccine. We have done Influenza vaccine. As the result of serology was negative we have done varicella and measles-mumps-rubelle (MMR) vaccines. Then 2 doses of Hepatitis A virus vaccine was done 6 months apart.

DISCUSSION: Vaccination is a complicated problem for oncology patients. There are lots of different implementation on literatures. Family physicians should plan the revaccination program special for each patient. Additionally special precautions about doses and duration of vaccines after chemotherapy should be noted. Vaccination of the hosts and care givers also should be considered.

Keywords: vaccination, chemotherapy, cancer

Recommendations for paediatric patients during and after chemotherapy

Vaccine	During Chemotherapy Concise Recommendation	After Chemotherapy Concise Recommendation
Poliomyelitis	Benefit of herd immunity Postpone if lymphocyte count $<1.0 \times 10^9/L^{**}$	Booster or vaccination 6 months after stopping chemotherapy
Diphtheria	As above, passive immunoprophylaxis and antibiotic prophylaxis in case of epidemic	Booster or vaccination 6 months after stopping chemotherapy (adult type vaccine for age >6 years)
Tetanus	Postpone if lymphocyte count $<1.0 \times 10^9/L^{**}$ Passive immunoprophylaxis, thorough washing and disinfection of wound, and antibiotic therapy for wounds at risk	Booster or vaccination 6 months after stopping chemotherapy
Pertussis	Postpone if lymphocyte count $<1.0 \times 10^9/L^{**}$ Passive immunoprophylaxis and antibiotic prophylaxis in case of epidemic	Booster or vaccination 6 months after stopping chemotherapy
Hepatitis A virus	Vaccination of the seronegative patients before starting chemotherapy in highly endemic areas; alternatively, passive immunoprophylaxis	Booster or vaccination 6 months after stopping chemotherapy
Hepatitis B virus*	As above	Booster or vaccination 6 months after stopping chemotherapy
Influenza	Vaccination yearly during fall; postpone if lymphocyte count $<1.0 \times 10^9/L^{**}$ Vaccination of family members Not administered to infants <6 months of age	Fall Season vaccination after 3 months from stopping intensive chemotherapy Not administered to infants <6 months of age
Meningococcus	Recommended vaccination prior to splenectomy Postpone vaccination if lymphocyte count $<1.0 \times 10^9/L^{**}$ Not administered if age <2 years	Not administered if age <2 years Booster or vaccination 6 months after stopping chemotherapy Booster after 3 years if vaccinated at age of 2-6 years
Haemophilus influenzae	Not administered if age <2 months Recommended vaccination prior to splenectomy Postpone vaccination if lymphocyte count $<1.0 \times 10^9/L^{**}$	Not administered if age <2 months Booster or vaccination 6 months after stopping chemotherapy
Pneumococcus	Recommended vaccination prior to splenectomy Postpone vaccination if lymphocyte count $<1.0 \times 10^9/L^{**}$	Booster or vaccination 6 months after stopping chemotherapy
Measles, Mumps, Rubella	Not administered if age <12 months Passive immunoprophylaxis in case of contact Vaccination of seronegative family members	Not administered if age <12 months Booster or vaccination 6 months after stopping chemotherapy
Measles	In case of epidemic, patient vaccination if adequate CD4+ immune recovery [†]	
Varicella	Postpone if lymphocyte count $<0.7-1.2 \times 10^9/L^{**}$ or the patient is not in remission for 12 months or is doing radiotherapy Not administered if age <12 months Vaccination of family members at risk; Postexposure prophylaxis within 96 hours from contact: hyperimmune Ig (0.2 mL/kg, max 10 mL) 96 hours after contact Acyclovir 4×20 mg/kg/day from the 7th to 21st days ^{**}	Not administered if age <12 months Booster or vaccination 6 months after stopping chemotherapy
Human papilloma virus	No data	Not administered if age <9 years Booster or vaccination 6 months after stopping chemotherapy
Rotavirus	No data	No data

Legend: *Observe a 4-week interval between 1st and 2nd doses and 3-month interval between the 3rd and 4th doses of vaccine for hepatitis B virus. Meningococcal and pneumococcal polysaccharide vaccines are not effective in children <2 years. Minimum age for conjugated vaccine is 6 weeks of age. Use pneumococcal conjugate vaccine followed, after at least 2 months, by the 23 polysaccharide vaccine. In case of splenectomy, give a booster after surgery. †Threshold level of CD4+ recovery for MMR vaccination: CD4+ $> 0.75 \times 10^9/L$ for children <12 months; CD4+ $> 0.5 \times 10^9/L$ for children aged 1-5 years; $>0.2 \times 10^9/L$ for children >6 years old and adults. **As suggested. ††Expert panel opinion. The use of acyclovir as postexposure prophylaxis has been successfully reported in immunocompetent host contacts with VZV. Reference:

<http://www.hindawi.com/journals/bmri/2014/707691/>

<http://www.hindawi.com/journals/bmri/2014/707691/tab2/>

P-1375

Aortic aneurysm in young adult, an entity underestimated

Roldan García Sandra¹, García Moreno Samuel¹, Jiménez Herrera Carmen María¹, Muñoz Maya Ruth²

¹Centro de Salud Nuestra Señora de La Oliva. Alcalá de Guadaira. Sevilla.

²Centro de Salud Don Paulino García Donas, Alcalá de Guadaira. Sevilla

REASON FOR CONSULTATION: 32 year old man who consults for pain center-chest.

PERSONAL HISTORY: No cardiovascular risk factors. No toxic habits (alcohol, tobacco)

Family history: father died at age 54 of myocardial infarction.

CURRENT DISEASE: Pain center-chest radiating to intermittent left arm unleashed with the physical effort, without vegetative symptoms or dyspnoea. As happens in many cases for years, but in the last few days has increased in intensity and frequency, appearing progressively lesser efforts.

ADDITIONAL EXPLORATION AND TESTING

Good general condition, eupneic. Mild Engorgement jugular. peripheral pulses symmetrical.

Cardiopulmonary auscultation systolic murmur III/VI and diastolic III/VI aortic in focus.

Abdomen anodyne. MMII without edema or signs of Deep Venous Thrombosis. Rest exploration without findings.

Analytical: including D-dimers and cardiac markers

Chest radiography: normal.

Electrocardiogram: sinus rhythm to 70bpm, signs of growth in left ventricle with peaked T waves in chest.

Echocardiogram aortic aneurysm of 10cm to stretch upward. Aortic Valve trivalva with severe functional aortic insufficiency.

Angio-CT thoracic aortic dissection: type A Stanford with aneurismal dilatation of ascending aorta,

CLINICAL TRIAL

Type A Aortic Dissection of Stanford with ascending aorta aneurysm

DIFFERENTIAL DIAGNOSIS

- Musculoskeletal problems
- Pericarditis
- Ischemic Heart
- Pulmonary thromboembolism.

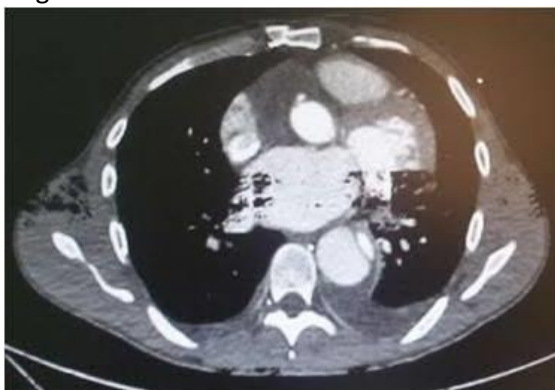
TREATMENT: Surgery, stents of ascending aorta.

FINAL COMMENT

- Abdominal Aortic Aneurysms are more frequently than the thoracic. Most are asymptomatic, you need a high index of suspicion, thorough medical history, risk factors, appropriate physical examination and imaging techniques. Chest pain is the main symptom of symptomatic aneurysms which tend to be very large and have a higher risk of rupture, by partnering with high mortality rates. May be suspected with chest x-ray, transesophageal ultrasound, Axial Computerized Tomography and Nuclear Magnetic Resonance of choice.

Keywords: Aortic Aneurysm, Chest pain, Aortic dissection

Angio-CT thoracic



Angio-CT thoracic aortic dissection: type A Stanford with aneurismal dilatation of ascending aorta

Chest radiography



Chest radiography: no pathologic signs

P-1376

Quality And Popularity Of Turkish Health Web Sites

Selçuk Yıldız¹, Yusuf Üstü², Ebru Yılmaz¹, Sevim Öğülmüş¹, Ahmet Keskin², Mehmet Uğurlu²

¹Family Medicine, Ankara Atatürk Training and Research Hospital, Ankara, Turkey

²Family Medicine, Yıldırım Beyazıt University, Ankara, Turkey

Background and AIM:

Internet has been the way which is most commonly used to access information. Patients and their families search information about diseases and treatment methods on web. According to the data gathered in 2014 by the Turkish Institute of Statistics, Internet access in our country is about 60,2%.

METHOD:

Websites were identified by entering health-related key-words selected from the diseases that is common in the public. Diabetes, cervical cancer, asthma, hypertension, dementia, anemia, congenital hypothyroidism, hemorrhoids were entered as a keyword into two most popular search engines of Turkey based on the time of study: Google and Yandex. Analyzed websites were limited to the sites listed in the first three pages (30 sites) per search engine. At first, a list of 480 websites was generated. In the next step, by refining our search results 125 websites were duplicated, 30 weblogs, 77 websites in non-health related sites, 4 websites with presented technical problems were excluded. Then, 168 websites were included by tracking relevant link sites on the selected websites. Website assessment was performed by The Bomba and Land Index (version 2). Also we use Google PageRank to evaluate websites for popularity.

RESULTS:

The total Bomba score was $11,9 \pm 2,5$ (min.:5,2, max.:17,3). Most websites were in the moderate category ($8 \leq x \leq 11,99$). And Google PageRank mean score was 2,48 (min.:0, max.:8). There was no statistically significant association between Google PageRank with Bomba index variables.

CONCLUSIONS:

We think that our study will be followed by similar studies and thus we will have more data about the reliability of the information on Turkish-language websites which is about health.

Keywords: Health, Health Web Site Quality, web site popularity, internet

P-1377

Cutaneous complications due to hirudotherapy: a case report

Sevim Ogulmus¹, Ebru Yilmaz¹, Irep Karatas Eray¹, Selcuk Yildiz¹, Aylin Baydar Artantas¹, Havva Sahin Kavakli²

¹Department of Family Medicine, Atatürk Training and Research Hospital, Ankara, Turkey

²Department of Emergency, Yenimahalle State Hospital, Ankara, Turkey

INTRODUCTION: *Hirudo medicinalis* (leech) is an example of alternative therapeutics and have been used in the treatment of certain diseases since ancient times. The primary care physician should be aware of the cultural differences including religion and politics of her referred population so that she can be the mediator between medicine and the society. This study reports the case of a patient who showed cutaneous problems after leech therapy.

CASE: A 47-year-old woman contacted emergency services complaining about fever, nausea, anorexia, fatigue, cutaneous lesions which appeared two days prior. Six days before her current visit, she went to a different medical center complaining of varicose veins. The leech therapy was applied two days ago. Blood pressure:110/60mmHg, heart rate:85 beats per minute, respiration rate:18 per minute, temperature:38.6°C. At both sides of her legs, multiple erythematous and oedematous skin lesions were present. The largest one was 5cm in diameter. The center of the erythematous lesion was indurated which coincided with the site of the leech bite. WBC:10770/mm³, PLT:211000/mm³, PT:13.48 seconds, aPTT:30.9 seconds, INR:0.9. We consulted with The Clinic of Infectious Disease and they suggested starting an oral antibiotic treatment, wound dressing with antiseptic solution and elevation.

DISCUSSION: Today medicinal leeches are used in the treatment of various diseases such as thrombophlebitis, hypertension, varicose ulcer, skin and musculoskeletal diseases, in various surgical and traumatic conditions such as re-attachment of severed extremities, fingers, toes and ears. Infection is the most common complication of leeching(2-36%). Local hypersensitivity conditions including itching, blister formation, ulcerative necrosis, local tissue damage blood loss due to prolonged hemorrhage and skin marks left behind by impaired healing of leech bites are reported as postleeching complications. Further investigations are required to assess leech efficacy and safety in the treatment of disease. It is necessary to develop standart procedures for decreasing the complication rates.

Keywords: hirudotherapy, cutaneous complication, family medicine

Figure 1:Cutaneous lesions secondary to hirudotherapy



Figure 2:Cutaneous lesions secondary to hirudotherapy



P-1378

A case diagnosed with neurofibromatosis type 2 after three decades

Fikret Merter Alanyalı¹, Suphi Bulğurcu², Berk Geroğlu¹, Ibrahim Çukurova²

¹Family Medicine Clinic, Tepecik Training and Research Hospital, Izmir, Turkey

²Ear, Nose and Throat Clinic, Tepecik Training and Research Hospital, Izmir, Turkey

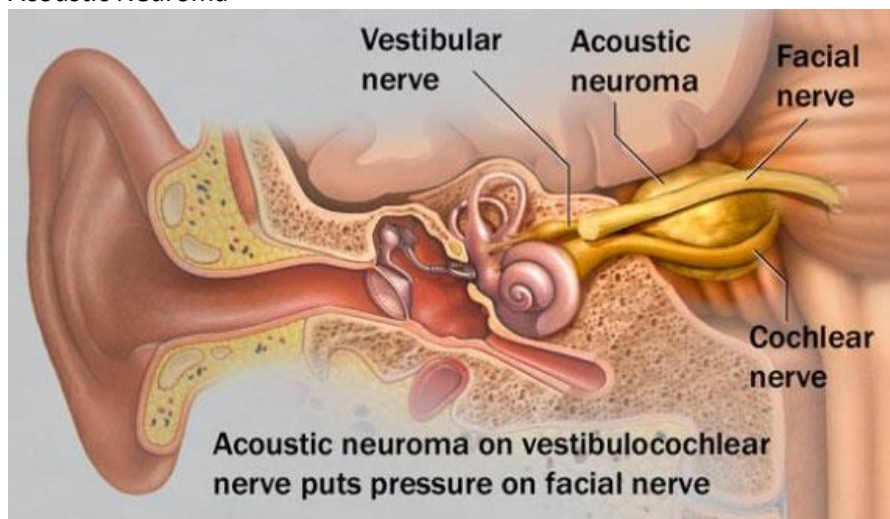
INTRODUCTION: Neurofibromatosis type 2 (NF2) is a hereditary condition most commonly associated with bilateral vestibular schwannomas, also known as acoustic neuromas. These are benign (noncancerous) tumors that occur on the nerves for balance leading to the inner ear. Although these tumors are benign, they can cause hearing and balance problems.

CASE: A woman aged forty-four years presented into our clinic with a mass of 10x10 centimetres on her left side of throat's fifth division, toughness on left cheek and abducens nerve paralysis on her right eye. At presentation; her complaints were vertigo and mass on her throat. When we checked her history, we have found that she had been operated several times; from her right eye due to strabismus at age 12, from her both feet due to numbness and operated with total laminectomy and found neurofibroma and intramedullary tumor at age 23 and also a mass on her abdomen at age 23 but there was no diagnose. At age 32 a mass began to appear at her throat's left side but even the doctor's offerings our patient didn't want to have the surgery from her throat. After years passed, for the last two months there was a mass on her left cheek and the patient presented into our clinic. We have done fine needle aspiration from the mass but it was unidentified cytology. When we checked on radiologic imaging there were bilateral acoustic neuroma besides masses on her head. And finally we diagnosed the patient Neurofibromatosis type 2.

CONCLUSION: Even though the tumors are benign seen with Neurofibromatosis type 2, there could be severe damages and could effect life quality after years. If we check all systems on body, we could diagnose much early, prevent these conditions and treat them with drugs and radiotherapies.

Keywords: Neurofibromatosis type 2, bilateral acoustic neuroma, throat mass.

Acoustic Neuroma



P-1379

Brucellosis Like's Joints: A Case Report

Fatih Bağcier, Ayhan Kul, Meltem Alkan Melikoğlu

Atatürk University Faculty of Medicine, Department of Physical Medicine and Rehabilitation, Erzurum

INTRODUCTION: Brucellosis which is a endemic in Turkey, is a systemic infection which can affect any organ or system in the body. Since signs and symptoms of brucellosis resemble many other diseases, misdiagnosis and related increase in morbidity rate, are common. It most commonly involves the musculoskeletal system. We aimed to present a case who admitted with acute pain in the left hip area and was diagnosed of brucellosis sacroiliitis.

CASE: 27 year-old male patient was admitted to our clinic pain in the left hip area for a week. The pain did not decrease with rest and was intensifying at night. Fever was intermittent character rise up to 38,5. On physical examination left side FABER +, FADIR+. There was no history of trauma and comorbid disease. Joint movement was limited and tenderness. Other system examination findings were normal. **Laboratory FINDINGS:** hb:13,6mg/dl, sedim:20mm/saat, CRP:12 ALT:10iu/ml, creatinine:0,7mg/dl. Rose bengal:positive Wright: positive. Sacroiliac joint pathology was seen in pelvic radiographs. MRG: sacroiliitis was observed in the left joint. As a result brucella were detected in patients with sacroiliitis. Antibiotic therapy was given. The patient's pain reduced significantly. Physical examination was normalized.

CONCLUSION: Brucellosis often affects the musculoskeletal system. Osteoarticular complications of brucellosis occur in 10%-85% patients. Brucella infection may sacroiliitis, spondylitis, spondylodiscitis, arthritis, osteomyelitis, tenosynovitis or bursitis. The spine is the most common affected site and back pain is the most common clinical manifestation of brucellosis. Sacroiliitis of brucellosis usually occurs unilaterally in young patients. With appropriate treatment, recovery is observed in 60-90% of patients. Our case had been presented with unilateral sacroiliitis in accordance with literature. Extraarticular involvement was not seen. Brucellosis should be considered in the differential diagnosis of patients who present with musculoskeletal complaints in regions where brucellosis is endemic.

Keywords: Brucella, sacroiliitis, hip pain

Figure 1

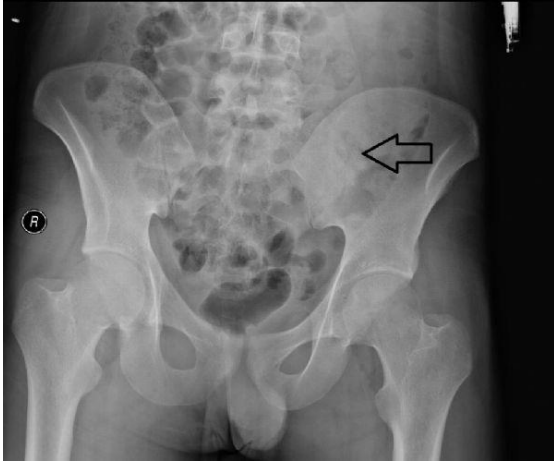
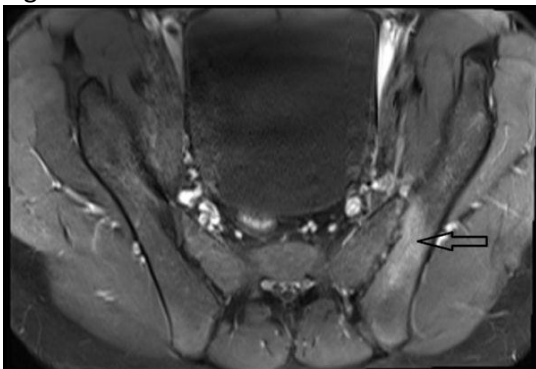


Figure 2



P-1380

A 81 year-old female patient with left ptosis and drowsiness

Garrido Laguna Maria Cristina, Arrillaga Ocampo Idoia, Padial Reyes Irene, Navarro Robles Cristina, Fernandez Zambrano Maria

Las Lagunas Health Center, Mijas Costa, Malaga, Spain

CASE: Female patient, 81 years old, consults the primary care doctor, for mild left ptosis and drowsiness.

Personal medical history: hypertension, dyslipidemia, type 2 diabetes mellitus, chronic kidney disease stage 3B-A3, primary hypothyroidism, morbid obesity.

Previous surgery: cholecystectomy, hernia repair, bilateral faugetomia. No toxic habits.

During the first examination a left eyelid ptosis and a tendency to sleep is observed.

EXPLORATION AND INVESTIGATIONS:

Physical examination: normotensive, afebrile, drowsiness. Head and neck, cardiopulmonary auscultation and abdomen without abnormalities. Isochoric and normoreactive pupils, with left eyelid ptosis and limitation to move the eyeball vertically. Rest of cranial nerves without abnormalities. Symmetrical tendon reflexes present. Negative Babinsky.

Additional tests: general analysis results, including blood count, biochemistry, coagulation, TSH, vitamin B12, folic acid, autoimmunity, syphilis serology, Rickettsia, Borrelia, Brucella, Epstein-Barr virus, cytomegalovirus and human immunodeficiency virus are negative. Cranial CT (summary): cortico-subcortical lacunar infarcts and chronic atrophy. Cranial Magnetic Resonance (summary): moderate cortico-subcortical atrophy. Presence of acute stroke that affects the anterior portion of the midbrain and anterior nuclei of thalamus, of the artery of Percheron territory (midbrain and bithalamic)

DIAGNOSIS: acute / subacute infarction in the territory of artery of Percheron.

DIFFERENTIAL DIAGNOSIS: First is essential to consider a neurological process within the neurological processes that we study in this case are:

1. Massive subarachnoid hemorrhage: explosive characterized by headache, cerebrospinal fluid xanthochromia.
2. Myocardial blood bithalamic: Establishment of no subacute arterial territory.
3. Botulism: Vegetative signs, progressive downward paresis.

CONCLUSIONS: Given the neurological symptoms that the patient presents with involvement of the third cranial pair, in the differential diagnosis we need to consider the possibility of a stroke in the artery of Percheron. The diagnosis of this kind of stroke is based on clinical research and the scans results. The Nuclear magnetic resonance image shows in sequence T2 hyperintensity thalamus.

Keywords: Infarction, Percheron, thalamus

P-1381

Antibiotic resistance of Neisseria Gonorrhoea

Gülşah Yiğit

Department of Family Medicine, Marmara University Medical School, İstanbul, Turkey

INTRODUCTION: Neisseria gonorrhoeae is the etiologic agent of “gonorrhoea” which causes pelvic inflammatory disease, female infertility, neonatal ophtalmitis, transferred by sexual or perinatal way, effecting mostly mucous membranes of urethra, endocervix, less commonly rectum, scenes, vulva, oropharynx and conjunctiva.

Uncomplicated gonococcal infections are treated with 3rd generation cephalosporins; macrolide or tetracycline are added if non gonococcal urethritis co-exists.

Studies demonstrate that cephalosporins are the most effective antibiotics for N.gonorrhoeae and 250 mg single dose cephtriaxone is sufficient and no additional evidence exists for the use of higher doses. For combined therapy azitromycine is preferred to doxycycline due to anti-microbial resistance to tetracyclines. As floroquinolone resistance is low in Turkey single dose oral 500 mg ciprofloxacin or 400 mg ofloxacin or 500 mg levofloxacin is preferred. Unnecessary and inappropriate antibiotic use, risky sexual behaviors, iv drug use, homosexuality, genetic material exchange of the microorganisms at mucosal surfaces like pharynx, rectum are the factors well known to cause antimicrobial resistance.

AIM: In Turkey, gonorrheal infections are treated based on symptoms. This review is performed to investigate the studies related to antibiotic resistance of N.gonorrhoea in Turkey

METHOD: Turkish data base and pub med were searched by using the key words: “N.gonorrhoea, antibiotic resistance”. As the number was limited all the studies found were reviewed and analyzed.

RESULTS: The studies demonstrated 22-71% resistance for penicillin, 4,8-22% for tetracyclin, %5 for ciprofloxacin and ofloxacin and almost none for cephtriaxone, cephixime and cefuroxime.

CONCLUSION: To raise the success of ampic treatment, to follow antimicrobial resistance development and to develop up-to-date guidelines in Turkey, national surveillance programme and screening and antimicrobial sensitivity researches for gonococcus is necessary.

Keywords: neisseria gonorrhoea, antibiotic resistance

Table 1- Antibiotic resistance of Neisseria gonorrhoeae in Turkey

Study Year	Penicillin Resistance	Tetracycline Resistance	Betalactamase Resistance	Chinolone Resistance	Cephalosporin Resistance
	(%)				
1965 ⁽²⁾	25,7	13,3			
1984 ⁽³⁾	25	4,8	Yok		
1989 ⁽⁴⁾	71(55/78) highest			5 Ciprofloxacin & Ofloxacin	
1990 ⁽⁵⁾			% 5		
1991 ⁽⁶⁾	26,6				
1992-1994 ⁽⁷⁾	22 (23/105)	4,8 (5/105) (+penicillin resistance)	6,7 (7/105)	32 (34/105) Erythromycin No resistance to Spectinomycin Ciprofloxacin Decreased sensitivity to Ofloxacin in 2 strains	22 (23/105) Cefoxitine No resistance to Ceftriaxone
1996-2001 ⁽⁸⁾	39 (52/132) 2001'de 55 1999'da 29	22 (1996'da 14, 2001'de 36) (highest Tetracycline resistance in Turkey)	19 (26/132) (betalactamase positivity in Penicillin resistant strains 26/52= 50 1996'da 85 2001'de 8.	No resistance to Ciprofloxacin	No resistance to Ceftriaxone, Cefotaxime, Cefuroxime
2006 ⁽⁹⁾	46,6 (14/30)	10 (3/30)	33 (10/30)	3,3 (1/30)	No resistance to Ceftriaxone, Cefixime

P-1382

Disabled children and their impact for the parents

Millena Gomes Pinheiro Costa, Camilo Franco Ribeiro Koleilat, [Lara Louise Guimarães](#)
University Federal of Goiás, Goiânia, Brazil

BACKGROUND: The birth of a child brings a lot of changes on the family structure, in which the parents feel all of them on so many different everyday moments. They create expectations around the baby: witch sex it will be? What career it will follow? And according to what they want they project their “perfect” baby in their minds. The birth of a disabled child is an expect situation and confronts all that hope in a bigger way. **METHOD:** The paper is a literature review based on full texts published in Portuguese and English in the last years. The search was performed in Pubmed and Scielo using “disable children” and “parents”. **RESULTS:** One of the first worries with a disable child is to know and understand what that deficient is and what it’s prognostic. But independent of this disable, the child will need atention and careful beyond than expect. And brigis a lot of preoccupation with the future of the kid, if he or she will be able to support it self. The denial of the parents can also be a big problem, because makes they look for help and treatment, if it’s necessary, late. All of this factors cause psychologically difficult to the parents, like afraid to fail with the education, angry because it’s happening to them, confuse with the unknown. **CONCLUSION:** Having a disable baby can bring a lot of changes in the family, and both parents and siblings go to challenges. So that they succeed they need the most help as possible, like health professionals that can guide the family how is the best way to lead with the situation, and that a disable child, even with all it’s limitations can return love and becomes part of the family.

Keywords: disabled children, child, parents, family

P-1383

A Giant Fetal Cystic Hygroma: A Case report

[Vasfiye Demir](#)¹, Mehmet Siddik Evsen², Senem Tunç², Pakize Gamze Bucaktepe¹, Kübra Dursun²

¹Department of Family Medicine, Dicle University School of Medicine, Diyarbakır, Turkey

²Department of Obstetrics and Gynecology, Dicle University School of Medicine, Diyarbakır, Turkey

Cystic hygromas(CH) are congenital malformations of the lymphatic system appearing as single or multiloculated, fluid-filled cavities found mainly in the neck and axilla region. % 80 percentages of CH are located at the posteriolateral part of fetal neck. We presented a case which has giant cyctic masses both on the neck, arm,shoulders and thorax.

A 33 year old woman, gravida 7 parity 5 abortus 1 presented to obstetrics policlinic with labor pain. Patient went under ultrasonography(USG) and a single female fetus with anhydramnios detected at the examination. Biparietal diameter and head circumferences were compatible with 32 gestation week while abdominal circumferences was 36 week. USG detected multiseptated giant masses located both at the neck, shoulders, arms, back and surrounding chest wall. The diameter for cystics were fluctuating between 5cm to 20 cm. Woman had no family history of congenital abnormalities.

Cesarean section had recommended to woman. Due to woman’s request a vaginal birth take place and a female infant was delivered with a Apgar index of 0 at 1 min and 4 at 5 min. Infant was resusiated for two minutes and then transfered to new born intensive health care unit but died in two days Infant’s weight was 5000 gr and height was 55 cm. Physical examination revealed huge cystic masses at the neck, upper trunk and upper the limbs and also polidaktili at the left hand. At the postnatal USG examination findings were compatible with CH and no other abnormalities except polidactili was detected at the examinations.

% 50-80 of CH cases are presented together with chromosomal abnormalities. A fetus with CH need to be screened for other anomalies. Antenatal screening is crucially important to detect this abnormalities and also making a decision about the way of deliver and give the decision of terminating the pregnancy.

Keywords: Cystic Hygroma, Giant, Fetus, Pregnancy



Huge cystic masses at the neck, upper trunk and upper the limbs

figure 2



Giant cystic masses at the chest wall

P-1384

The Evaluation of The Residents' and The Final-Grade Medical Students' Knowledges, Attitudes and Views Regarding Forensic Report Writing

Vasfiye Demir¹, Tahsin Çelepkolu¹, Cem Uysal², Mustafa Korkmaz², Pakize Gamze Bucaktepe¹, Yılmaz Palancı³, Adil Bucaktepe⁴

¹Department of Family Medicine, Dicle University Faculty of Medicine, Diyarbakır, Turkey

²Department of Forensic Medicine, Dicle University Faculty of Medicine, Diyarbakır, Turkey

³Department of Public Health, Dicle University Faculty of Medicine, Diyarbakır, Turkey

⁴Department of Administrative Law, Dicle University Faculty of Law, Diyarbakır, Turkey

Forensic report is an official paper submitted to state offices documenting the questions answered by a physician as well as the opinion of the physician regarding the medical state of the person. Errors in forensic report writing may lead to irreversible results and delays in forensic practices and also may result in legal liability for the physician.

The aim of this study was to evaluate and compare the knowledge, attitudes, and views of the residents specializing at medical sciences and the final-grade medical students (FGMS) regarding forensic report writing. The study had a cross sectional descriptive research design and was approved by the local ethics committee. The study included 175 residents and 94 FGMS who are studying in Dicle University School of Medicine. The participants were administered a 28-item questionnaire between December 1, 2014 and June 1, 2015. Data were analyzed using SPSS 22.0.

The results revealed that 94% of residents and 100% of FGMS regarded themselves as incompetent in forensic medicine ($p < 0.000$), and only 30% of residents and 5% of FGMS indicated that their forensic medicine education was sufficient ($p < 0.000$).

It was also revealed that 89% of residents received no forensic medicine education after graduation, whereas 65% of residents and 73% of FGMS declared that they were willing to receive further forensic medicine education ($p = 0.357$).

Moreover, 30% of residents and 77% of FGMS indicated that they had no information regarding the legal liability of forensic reports and 34% of residents ($p < 0.000$) and 73% of stated that they had no information regarding the effectivity of forensic reports on legal proceedings ($p < 0.000$).

The study revealed that most of the physicians consider themselves as incompetent in forensic medicine. The study also demonstrated that pre-graduation forensic medicine education should be intensified and also post-graduation education programs should be designed.

Keywords: forensic science, forensic science report, education

P-1385

Investigation of Factors That Effect The Relationship Between Body Mass Index and Self Esteem In University Students

Nida Şebnem Altun¹, Berrin Telatar², Can Öner², Funda Elmacioğlu¹, Adnan Aydın¹

¹Istanbul Bilim University, School of Health, Nutrition and Dietetics Department, İstanbul, Turkey

²Istanbul Bilim University, School of Medicine, Family Medicine Department, İstanbul, Turkey

Introduction and AIM:

Self-esteem is a person's self awareness, his love against himself, respect and trust feelings. There are studies indicating that in obesity self-esteem is decreased. Our study is designed to investigate the factors that influence the relationship between body mass index (BMI) and self esteem.

MATERIAL-METHOD:

This descriptive study is conducted with students who attend Vocational School for Health Services in a private university in Istanbul between March - May 2015. There were totally 1388 students but 458 students accepted to participate in this study. A demographic questionnaire and Rosenberg self-esteem measuring scale of ten questions was applied.

In the calculation of the Rosenberg self esteem scale, it was defined as high (0-1 scores), mid (2-4 score scores) and low (5-6 scores). Data was analyzed with SPSS 15.0 software package.

RESULTS:

253 (55.2%) person was female and 200 (43.7%) were male. 58 (12.6%) was weak, 324 (70.7%) was normal, 59 (12.8%) was slightly overweight and 17 (0.3%) was obese. The average self-esteem score was 1.35 ± 0.53 . 308 (67.2%) individuals had high self-esteem, 138 people (30.1%) had medium self-esteem only 12 people (2.6%) had low self-esteem. There was no significant association between self-esteem and BMI; self-esteem and gender. There was no significant relationship between self-esteem and individually described weight, the number of people living together, income statement, cigarette use ($p > 0.05$).

In our study, none of people with the low self-esteem were detected obesity and was not detected decrease in self-esteem scores in any of the obese persons.

CONCLUSIONS:

A significant association between BMI and self-esteem could not be determined. It will be appropriate to conduct this study in crowded obese and in older groups and investigate not only obesity but also psychosocial factors in those with low self-esteem.

Keywords: BMI, University students, Rosenberg self-esteem scale

Table: Comparison of scores received from the Rosenberg self-esteem scale and sociodemographic characteristics

		0-1 points		2-4 points		5-6 points		p
		(n)	%	(n)	%	(n)	%	
Gender	Female	171	67,6	75	29,6	7	2,8	0,969
	Male	134	67	61	30,5	5	2,5	
Monthly income of the family	<2000 TL	136	46,1	64	47,8	5	41,7	0,897
	>2000 TL	159	53,9	70	52,2	7	58,3	
Cigarette smoking	Yes	102	33,2	46	33,6	6	50	0,453
	No	205	66,8	91	66,4	6	50	
Body Mass Index (BMI)	Underweight	39	67,2	17	29,3	2	3,5	0,862
	Normal	214	66,0	101	31,2	9	2,8	
	Overweight	41	69,5	17	28,8	1	1,7	
	Obese	14	82,4	3	17,6	0	0	
To describe themselves in terms of weight	Underweight	45	67,2	21	31,3	1	1,5	0,240
	Normal	193	70,2	76	27,6	6	2,2	
	Overweight	52	57,2	34	37,3	5	5,5	
	Obese	17	70,8	7	29,1	0	0	
The number of people living together	≤4	240	81,9	93	69,9	11	91,7	0,11
	>4	53	18,1	40	30,1	1	8,3	

P-1386

Does smoking status change the mean platelet volume levels?: A retrospective case-controlled study

Oğuzhan Tezcan, Hülya Yıkılkan, Cenk Aypak, Derya İren Akbıyık, Süleyman Görpelioğlu
Department Of Family Medicine, Dışkapı Yıldırım Beyazıt Training and Research Hospital, Ankara, Turkey

BACKGROUND & AIM:

Platelets play a crucial role in the inflammatory processes via secreting proinflammatory factors, growth factors and chemokines. Mean platelet volume (MPV) have been reported as a platelet activation marker. MPV can be easily measured by routinely used automated hemocytometers and is included as a parameter in complete blood cell (CBC) analysis. The correlation between MPV and various diseases such as acute coronary syndrome, peripheral artery disease, Alzheimer's disease, psoriasis vulgaris etc. have been reported. The aim of our study was to investigate MPV levels in non-smokers, passive smokers and smokers and to evaluate association between MPV and the smoking status.

METHODS:

This was a retrospective case-controlled study. Total of 118 patients who visited Dışkapı Yıldırım Beyazıt Training and Research Hospital Family Medicine Department Outpatient Clinics in 2015 were enrolled in our study. The study was designed in three groups, non-smokers (n:37), passive smokers (n:40) and smokers (n:41). MPV values were gathered from patients previous CBC results and were compared between these groups.

RESULTS:

The mean age was 47.9±18.1 (min:18,max:79) years. Of all patients, 48.3% (57) were females, 51.7% (61) were males. MPV mean values for non-smokers, passive smokers and smokers were 8.73±1.0 fL (6.7-10.9); 8.8±1.4 fL (6.6-11.6), 9.1±1.5 fL (6.3-12.0) respectively. There was not a statistically significant difference in terms of mean MPV levels between these three groups (p>0.05).

CONCLUSIONS:

The MPV did not differ with smoking status in our study. Further studies with higher sample sizes are needed in order to confirm our study results.

Keywords: Mean platelet volume, smoking, passive smoking

Comparison of mean platelet volume values between non-smokers, passive smokers and active smokers

Table 1. Comparison of mean platelet volume values between non-smokers, passive smokers and active smokers

	Non-smokers (n:37)	Passive smokers (n:40)	Active smokers (n:41)	p value
MPV (fL) (mean ± SD)	8.7±1.0	8.8±1.4	9.1±1.5	0.39

P < 0.05 is statistically significant

P-1387**Rapidly Progressive Glomerulonephritis (RPGN): a case-report**

Muhammed Atmaca¹, Sevim Ogulmus¹, Irep Karatas Eray¹, Yusuf Ustu², Mehmet Ugurlu²

¹Department of Family Medicine, Atatürk Training and Research Hospital, Ankara, Turkey

²Department of Family Medicine, Yıldırım Beyazıt University Faculty of Medicine, Ankara, Turkey

INTRODUCTION: Together with the technological development, test results could easily take the place of medical history and clinical examination during patient administration. Sometimes, minimal changes in lab findings could be normalised as "limit value", or many diagnosis could be bypassed due to alack of correlation between clinical and test results. Here, a case of RPGN diagnosed lately due to the ignored clinical findings is presented.

CASE: 50 years old lady was applied to the gastroenterology clinic with nausea, swelling in face and legs ongoing for one month. The general condition was good and the vitals were stable. There was a tenderness in the lower right quadrant and bilateral pretibial edema (+/+).

Creatinine was 1,8 mg/dl and urea level was 60 mg/dl in lab examination. No pathology was evident in upper abdominal USG. Peptic ulser therapy was started. The patient was back with ongoing complaints with the addition of fatigue, vomiting and hematuria. The blood pressure was 140/80 mm Hg. The pretibial edema was then ++/++ and creatinin was 9,2 mg/dl. The patient was consulted to the nephrology clinic and hospitalized and dialyzed. ANA and PANCA was positive with advanced diagnostic procedure. The biopsy result was glomerulosclerosis compatible with RPGN and steroid therapy was started.

DISCUSSION: RPGN is characterised with rapid and progressive loss in kidney functions and progresses to terminal kidney failure in weeks or months. The prevalence is 0,2-7 in a million. Though it is rare for family physicians, it is a disease of probable viral aetiology and high-mortality. Early the high level of creatinine is diagnosed, better the prognosis and survival are.

CONCLUSION: Family physicians meet dissociated disorders frequently, so they should use not only the test results, but the clinical findings as well, together with better evaluation of medical history and physical inspection findings.

Keywords: RPGN, Family physicians, early diagnosis

P-1388**Family medicine core competencies: What is the meaning of "Community Orientation"?**

Elif Altunbaş Ateş, Turan Set

Karadeniz Technical University Medical Faculty, Department of Family Medicine, Trabzon, Turkey

BACKGROUND&AIM: To understand the basic features of the discipline of family medicine is important for practices. In this study, it is intended to explain core competency of family medicine "Community Orientation".

METHODS: Textbooks, Articles in the PubMed&Google search, The European Definition of General Practice/Family Medicine-2011 sources have been read and commented.

RESULTS: There are 12 main features of the discipline of family medicine defined (Figure 1). They can be clustered into six core competencies. According to community-oriented model, family doctors should consider individual problems in the context of the health needs of the community and other professionals and agencies. The discipline recognizes that it has a responsibility both to the individual patient and to the wider community in dealing with health care issues.

DISCUSSION: Patients who didn't apply to office (eg. unvaccinated, blood pressure was not measured at all) should be addressed for care as the applied ones for well-child examinations, immunizations, acute and chronic diseases of all kinds.

Community-oriented Primary Care process occurs by accomplishing the following steps:

- Defining and characterizing the community
- Identifying community health problems
- Developing emphasis programs to focus the resources of the practice on the most common community health problems
- Monitoring the impact of each program and making modifications to better address the need.

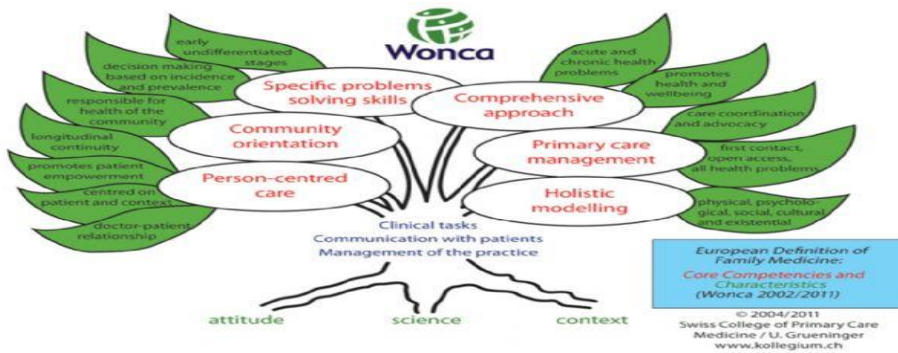
Family doctors should manage diseases most commonly seen at their population. Family doctors working in Turkey should not know 'Rocky Mountain Spotted Fever'. But they have to define 'Behçet's Diseases' because of the prevalence.

CONCLUSION: Community oriented care by a family doctor work must first begin by defining its population. They should be aware of being a part of the health care providers network. They should know the community health resources and these resources should be used for the benefit of both the patient and the community.

Keywords: Family doctors, core competencies, community-oriented

Sekil 1. Wonca agaci cekirdek yeterlilikler.

Figure 1. Wonca tree core competencies.



P-1389

Tinea incognita a case report

Nazlı Dizen Namdar¹, Yasemin Korkut²

¹Department of Dermatology, Dumlupınar University, Kütahya, Turkey

²Department of Family Medicine, Dumlupınar University, Kütahya, Turkey

Introduction

Tinea incognita arises due to wrong diagnosis by the application of topical or systematic corticosteroid to the dermatofit infected zone. Lesion, as generally asemptomatic, may be accompanied by itching and pain. On the dark red or violet colored lesion, papules and pustules can be observed. Systemic antifungal is required for the treatment. The case in here presented is a tinea incognito diagnosis.

Case

40 years old man presented with pruritic, erythematous patch located on the inguinal area. The patient had a history of intermittent topical corticosteroid (clobetasol propionat) use for 2-3 years. The dermatologic examination revealed bilateral, sporadically and slightly squamous, erythematous, sharp edged and edge activated plaque form lesion. No pathology was detected in other systemic examinations and routine laboratory tests proved normal. The requested dermatology consultation with the microscopic examination of lesion showed fungal hyphae and spores. The patient was treated with 250mg/day oral terbinafine and topical antifungal for a month. The examination after two weeks presented nearly total recovery in the lesion.

Discussion

Superficial fungal infection often encountered by doctors causes serious trouble in diagnosis and treatment for same cases. Incorrect diagnosis and treatment suspends recovery process. The delay due to incorrect diagnosis

raises treatment costs and results with difficulties. Besides, wrong medication generates sides effects on the patients, prolonged disease and treatment process decrease the life quality of patients. So many people consult to Family Medicine departments with dermatological lesions and to prevent incorrect diagnosis and treatment these lesions should be examined seriously.

Keywords: Tinea incognito, Superficial fungal infection, malpractice

tinea incognito inguinal region



P-1390

Nickel Contact Dermatitis On The Earlobe And Secondary Bacterial Infection: A Case Report

Oğuzhan Tezcan, Hülya Yıkılkan, Cenk Aypak, Derya İren Akbıyık, Süleyman Görpelioğlu
Department Of Family Medicine, Dışkapı Yıldırım Beyazıt Training and Research Hospital, Ankara, Turkey

INTRODUCTION: Allergic contact dermatitis is characterized by the delayed hypersensitivity reaction that occurs when an allergen comes into contact with previously sensitized skin. Signs and symptoms of the disease include rash, itching, dry, cracked, scaly skin, blisters, swelling, burning, tenderness. Skin dryness and damage of outer layer of skin by itching increases the secondary bacterial infection risk. The patch test is used to identify the causative allergen and can also detect metal hypersensitivity for nickel, gold, chrome and cobalt.

CASE: A 21-year-old man presented with painful swelling on his right earlobe after starting to wear nickel earring. He reported that it started as a pruritic rash and after 5 days it swelled and became very tender. Purulent fluid was coming from the spontan laceration occurred on the posterior side of the lesion. Vital signs were normal. On examination, there was a 2x2 cm painful, cystic soft tissue swelling with edema and erythema on the right earlobe, bilateral external auditory canals and tympanic membranes were found normal. There was no sign of anaphylaxis. Lab results revealed WBC:5800/mm³, hemoglobin:14,1g/dl, platelet:237.000/mm³, BUN:39 mg/dl, serum creatinine:0,9 mg/dl, ALT:23U/L, AST: 26U/L, sedimentation:6mm/hour, CRP:1.8mg/L. Spontan laceration on lesion was extended by using a lancet for drainage. Antibiotic therapy with amoxicillin/clavulanic acid and ciprofloxacin was begun empirically. Purulent fluid culture was performed and resulted positive for Staphylococcus aureus which is susceptible to amoxicillin. 7 days after antibiotic therapy tenderness, redness and swelling was gone. The patient was referred to dermatology department for patch test and results came positive for nickel and gold. The patient was informed about materials, domestic items or clothings that may possibly contain nickel or gold and adviced to avoid contact with the those causative substances.

CONCLUSION: Jewelry items such as ring, bracelet, necklace, earring, zippers or buttons of clothings, key chains, coins, metal chairs or tables, metal eyeglass frames and cooking pans which are commonly used in daily life may contain nickel. Detailed anamnesis should be obtained from patients when considering allergic contact dermatitis and all possible causes should be questioned.

Keywords: Allergic contact dermatitis, Nickel, Gold, Patch test, Secondary bacterial infection

Picture-1



Sağ kulak memesinde 2x2 cm boyutlarında üzeri kızarıklık, ödemli, palpasyonda hassas, yumuşak kıvamda şişkinlik 2x2 cm cystic, tender to palpation soft tissue swelling with edema and erythema on the right earlobe

P-1391

An Atypical Presentation Of Helicobacter Pylori Infection: A Case Report

Oğuzhan Tezcan, Hülya Yıkılkan, Cenk Aypak, Derya İren Akbıyık, Süleyman Görpelioğlu
Department Of Family Medicine, Dışkapı Yıldırım Beyazıt Training and Research Hospital, Ankara, Turkey

INTRODUCTION: Helicobacter pylori(HP) infection is a major cause of gastritis and peptic ulcer disease and is a considerable source of morbidity and mortality. Proton pump inhibitors(PPIs) which are used in the treatment of HP infection have different pharmacokinetics and pharmacodynamics. CYP2C19 polymorphism may markedly affect the metabolism of PPIs. Homozygous CYP2C19*17 allele may cause 60-70% reduction in the area under the plasma drug concentration-time curve(AUC) of some PPIs such as omeprazole and lansoprazole by causing ultra rapid drug metabolism.

CASE: A 28-year-old woman visited our hospital with ongoing symptoms of nausea for several weeks. She denied heartburn, chest pain, acidic taste in her mouth, problems at swallowing, vomiting, diarrhea or constipation. Her weight was stable. She did not notice any blood in stool or dark stool recently. She reported that she had only taken pantoprazole 40 mg once daily for 6 weeks. At second visit to her doctor after 6 weeks, HP IgG serology test was performed and the result was negative. PPI administration was switched by her doctor firstly to lansoprazole(30 mg twice daily for 6 weeks), and then to rabeprazole(20 mg once daily for 4 weeks). Physical examination were normal. Rabeprazole relieved nausea partially but she was still symptomatic, thus we referred the patient for upper endoscopy. Endoscopic biopsy results showed metaplasia and HP infection. The patient was treated with 14 days therapy of amoxicillin, clarithromycin and rabeprazole. Three weeks after eradication therapy symptoms of patient disappeared. It is thought that the patient had CYP2C19 ultra-rapid metabolizer genotype.

CONCLUSION: In patients with HP infection nausea may be the only symptom. CYP2C19 polymorphism, especially in the presence of homozygous CYP2C19*17 allele ultra-rapid metabolizer genotype, may significantly reduce patients' response to the different PPI treatment options. In clinical practice, it should be kept in mind that lack of symptomatic response to PPI therapy does not always exclude the diagnosis of gastritis, peptic ulcer disease or HP infection.

Keywords: Helicobacter pylori, Proton Pump Inhibitor (PPI), CYP2C19 polymorphism, Ultra-rapid metabolizer genotype, Atypical

Tablo 1. Proton pompa inhibitörlerinin farmakokinetik özellikleri
Table 1. Pharmacokinetic properties of proton pump inhibitors

	Lansoprazole	Pantoprazole	Omeprazole	Esomeprazole	Rabeprazole
Bioavailability (%)	80-85	77	30-40	50-68	52
Plasma elimination half-life (h)	1.3–1.7	1.0–1.9	0.5–1.0	1.3	0.7–1.5
Protein binding (%)	97	98	95	97	96
Metabolism	Hepatic [CYP2C19 (primarily) / CYP3A4]	Hepatic [CYP2C19 (primarily) / CYP3A4]	Hepatic [CYP2C19 (primarily) / CYP3A4]	Hepatic [CYP2C19 (at a slower rate) and CYP3A4]	Nonenzymatic reduction (primarily), hepatic (CYP2C19/ CYP3A4)
Metabolites	5-hydroxy-lansoprazole, 5-hydroxy-lansoprazole sulfone, 5-hydroxy-lansoprazole sulfide, lansoprazole sulfone, lansoprazole sulfide	5-hydroxy-pantoprazole, pantoprazole sulfate, pantoprazole sulfone, pantoprazole sulfide	5-hydroxy-omeprazole, 5-hydroxy-omeprazole sulfone, omeprazole sulfone, omeprazole sulfide	5-hydroxy-omeprazole, 5-hydroxy-omeprazole sulfone, omeprazole sulfone, omeprazole sulfide	Thioether rabeprazole (nonenzymatic reduction), desmethyl rabeprazole, desmethyl thioether rabeprazole, rabeprazole sulfone
Urinary excretion of oral dose (%)	14–23	71–80	77	80	30–35

CYP2C19: Cytochrome P450 2C19, CYP3A4: Cytochrome P450 3A4

Tablo 2. CYP2C19 izoenziminin genetik polimorfizmi
Table 2. Genetic polymorphisms of the CYP2C19 isoenzyme

CYP2C19 allele	Nucleoside change	Effect	Enzyme activity
*1	None	Wild-type	Normal
*2	G681A point mutation in exon 5	Splicing defect in exon 5	None
*3	G636A single base transition	Premature stop codon	None
*17	-806C>T, -3402C>T	Increased CYP2C19 gene transcription	Ultrarapid metabolism

CYP2C19: Cytochrome P450 2C19, G: Guanine, A: Adenine, C: Cytosine, T: Thymidine

P-1392

Attention; It May Be Takayasu- A Case Presentation

Onur Öztürk¹, Gülsah Öztürk², Mustafa Yasin Selçuk², Fusun Artıran İğde², Mustafa Fevzi Dikici²

¹Atakum Community Health Center, Samsun, Turkey

²Department of Family Medicine, Ondokuz Mayıs University Faculty of Medicine, Samsun, Turkey

Takayasu Arteritis (TA) is a chronic large vein vasculitis characterized by elastic artery involvement such as aorta, main aorta branches and pulmonary arteries mainly. Yearly frequency is 2.6/million and mostly seen in 20-30 year-old females. Morbidity is related to arterial stenosis-related organ ischemia development. In this presentation, we will refer to TA in a muscle pain case.

20 year-old male patient applied to OMUTF Family Practice clinic in January 2015 with a two-month long back and shoulder pain. In physical examination, arterial blood pressure was 105/65 in the right, 90/60 mmHg in the left arm and systematic inspections were normal. Background and family risk factors were not present. Examination results were Hb: 10,7 g/dL, WBC: 9,20 x10⁹/L, PLT: 503 x10⁹/L, MCV: 79 fL, RDW: 15 %, Fe: 18 µg/dL, iron-binding capacity: 189 µg/dL, ferritin: 1219 ng/mL, CRP: 271 mg/L, Sedimentation: determined as 102 mm/h. The examination of the patient transferred to rheumatology was evaluated as waist ROM clear-painless, right shoulder ROM clear-painful, left shoulder ROM clear-unpainful, sacroiliac compression-/- and pelvis graphy was normal. The patient lost weight and was over-sweating in the last three months and there was a swelling in the right ankle two weeks ago and in the left ankle four days ago which disappeared. Diagnosis was TA as diffuse wall-thickening in bilateral CCAs and subclavian arteries in neck CT and also in ascending and descending thoracic aorta, brachiocephalic artery and subclavian artery on the right, CCA and subclavian arteries on the left in thorax CT and abdominal aorta wall diffuse thickening in upper-lower abdomen CT were noticed. The patient was discharged after starting Azathioprine 50 mg 3*1, Prednisolone 16 mg 3*1 and Lansoprazole 1*1 treatment. When he was controlled a week later, monthly control was recommended as there were no active complaints and laboratory results were normal.

Keywords: Takayasu, Arteritis, Ischemia, Muscle pain

Thoracic CT: arterial thickening



P-1393

Anxiety Symptom Level of the Cardiology Clinic Patients and Related Factors

Özgür Alavcı¹, Umut Gök Balcı², Nazlı Soysal³, Barış Kılıçarslan⁴, Kurtuluş Öngel⁵

¹Bitlis Public Health Directorate

²İzmir Tepecik Education and Research Hospital, Department of Family Medicine

³Karşıyaka 24. No Family Health Center, İzmir

⁴İzmir Tepecik Education and Research Hospital, Clinic of Cardiology

⁵İzmir Katip Çelebi University, Faculty of Medicine, Department of Family Medicine

AIM: Persons who have anxiety symptoms such as chest pain and palpitation, often reason of admission to cardiology inpatient clinics, cardiology outpatient clinics and emergency services. Aim of this study is to determine level of anxiety symptoms of patients who admitted to cardiology clinics, to understand distribution of symptoms and research related factors.

MATERIAL-METHODS: This is a basic, sectional and descriptive study. Stationary population of this study was patients who were admitted to cardiology inpatient and outpatient clinics of Tepecik Educational and Research Hospital between 01.06.2013 and 31.07.2013. Sociodemographic findings questionnaire and Turkish version of Hamilton Anxiety Scale (HAS) were administrated to patients by interviewer. Statistical analyses of data were performed by SPSS 15.0 programme.

RESULTS: There were 101 participants in this study. Participants were between 18-65 years old. 50 of them were men (49,5%) and 51 of them were women (50,5%). Mean age of the participants was 48,49±11,59 (min:18, max:65). Mean of BMI's of participants was 27,41±4,88 (min:16.8,max:38.7). 79,2% of participants who were included to study had ischemic heart disease. Mean of HAS points of participants was 10,28±6,21 (min:0,max:26). 27 participants (%26,7) had no anxiety and their HAS scores were between 0 and 5 points. 49 (%48,5) participant's HAS scores were between 6 and 14 and they had mild or moderate anxiety and 25 participants had severe anxiety and their HAS scores were 15 and/ or higher 15.

CONCLUSION: Psychologic conditions affect coronary heart disease's progression negatively. Anxiety disorders are more common in patients who have coronary heart disease (CHD).

Keywords: Anxiety levels, Cardiovascular disease, Hamilton Anxiety Scale.

P-1394

Right Valve Endocarditis And Hepatitis C Coupling

Derya Keten¹, Mustafa Azmi Sungur², Evrim Gülderen¹, Hamit Sırrı Keten³

¹Department of Clinical Microbiology and Infectious Diseases, Necip Fazil City Hospital Kahramanmaraş, Turkey

²Department of Cardiology, Necip Fazil City Hospital Kahramanmaraş, Turkey

³Department of Family Medicine, Kurtul Family Health Center, Kahramanmaraş, Turkey

BACKGROUND AND AIM: We aimed to increase the delicacy of the matter and inform the healthcare professionals by presenting a case who was addicted to intravenous drugs and developed complications due to this.

CASE: A 35-year-old male patient was initially diagnosed with pulmonary thromboembolism and treatment was planned. As the body temperature continued to be high on the fourth day of treatment, the patient was reevaluated and it was determined that he was addicted to intravenous drugs. Body temperature was 39°C. In the physical examination, there were bilateral rales at the basal parts of both lungs and a 3/6 systolic murmur was heard, which was more prominent in the tricuspid area; hepatomegaly and splenomegaly were detected. Laboratory parameters were as follows: leukocyte: 18,500/μL (neutrophil: 92.6%), CRP: 73 mg/l, AST: 73 U/L, and ALT: 57 U/L. In the pulmonary CT angiography, bilateral massive pleural effusion and multiple foci of abscess, the largest forming cavitation in the central part of the left lung, were detected. The blood culture showed methicillin-sensitive Staphylococcus aureus growth. In the echocardiography, hyper echogenic multiple mass images and cord rupture were detected in the tricuspid valve. Combined linezolid and meropenem therapy was

initiated. Hepatitis markers were determined as Anti-HCV (+), HCV RNA value of 776 065 IU/ml, and HCV genotype 3. Upon the follow-up of the patient, the vegetations disappeared. As the patient had an active HCV infection, the valve replacement surgery was left until after the treatment of the HCV infection.

CONCLUSIONS: It is important to struggle with drug addiction, which is gradually becoming widespread in Turkey and around the world, and their accompanying infectious risks. The high rate of HCV genotype 3, which is accompanied by drug addiction in the current study, presented the severity of this situation.

Keywords: Right Valve Endocarditis, hepatitis C, Intravenous drugs

P-1395

Evaluation Of Social Anxiety In The Individuals With As Weak For The Body Mass Index

Soner Ölmez¹, Emel Zorlu Ölmez², Mustafa Çelik³, Mustafa Haki Sucaklı³, Hamit Sırrı Keten⁴, Caner Ölmez⁵, Selçuk Kardaş⁶

¹Department of Family Medicine, Samsat Family Health Center, Adıyaman, Turkey

²Department of Dietician, Gaziantep Şehit Kamil State Hospital, Gaziantep, Turkey

³Department of Family Medicine, Medical Faculty, Kahramanmaraş Sutcu Imam University, Kahramanmaraş, Turkey

⁴Department of Family Medicine, Kurtul Family Health Center, Kahramanmaraş, Turkey

⁵Department of Public Health, Medical Faculty, Gaziantep University, Gaziantep, Turkey

⁶Department of Psychiatry, Medical Faculty, Kahramanmaraş Sutcu Imam University, Kahramanmaraş, Turkey

BACKGROUND: Having a weak body appearance can affect the individual's body perception negatively, so may cause social anxiety. Due to this thought, in this study, we aim to determine the frequency of the social anxiety, in the individuals who are classified as weak for the body mass index (BMI).

METHOD: The 80 patients; who have not any known chronic and psychiatric diseases and classified as weak for the BMI, came to the diet polyclinics of Kahramanmaraş Sütçü İmam University Medicine Faculty Hospital and Gaziantep Şehit Kamil State Hospital between 06.12.2013 and 30.05.2014, have participated to this study. The control group was selected the 81 patients who have also not any known chronic and psychiatric diseases. At the first part of the survey form, there are the sociodemographic informations about the patients, like age, sex, economic income, job, length and weight. Liebowitz Social Anxiety Signs Measure is found at the second part.

RESULTS: 78 (%48.4) of the 161 patients who participated to the study were male, and the rest 83 (%51.6) patients were female. The mean age of the participants was 22.06±3.4 (min.=18, maks.=33). The mean of the total points of the whole participants taken from measure (scary point +avoiding point) was 55.11±19.35 (min.=1.0, maks.=104.0). Although the mean of total points of the Patient Group was 55.26±18.02, The Control Group's was 54.97±20.7. Any meaningful difference haven't detected between two groups' total points (p=0.925), also mean avoiding points (p=0.345) and mean scary points (p=0.430).

CONCLUSIONS: The negative body perception which formed by the weakness; likely the cause of social anxiety signs, should be estimated biopsychologically like a multi-faceted approach.

Keywords: Body Perception, Social Anxiety, Body Mass Index, Weakness

P-1396

The Level of Knowledge, Attitude, and Behavior of Physicians Toward Organ Donation

Hamit Sırrı Keten¹, Oğuz Işık², Hüseyin Üçer², Derya Keten³, Özgür Ersoy⁴, Soner Ölmez⁵

¹Department of Family Medicine, Kurtul Family Health Center, Kahramanmaraş, Turkey

²Department of Family Medicine, Medical Faculty, Kahramanmaraş Sutcu Imam University, Kahramanmaraş, Turkey

³Department of Clinical Microbiology and Infectious Diseases, Necip Fazil City Hospital Kahramanmaraş, Turkey

⁴Department of Public Health, Medical Faculty, Cukurova University, Adana, Turkey

⁵Department of Family Medicine, Samsat Family Health Center, Adıyaman, Turkey

BACKGROUND: The aim of the present study was to determine the level of knowledge, attitude, and behavior of physicians toward organ donation.

METHOD: The present study was conducted in Kahramanmaraş province located in the Mediterranean region of Turkey. The study was conducted on physicians working at Kahramanmaraş Sütçü İmam University Medical Faculty Hospital, Necip Fazil State Hospital, and Family Health Centers between March 1st 2015 and June 9th 2015. A questionnaire was administered to gather sociodemographic data of the participants and their knowledge level, attitude, and behavior toward organ donation.

RESULTS: Of study participants, 160 (59.9%) were males and 107 (40.1%) were females, and the mean age was 34.91±6.98 years (min=24, max=55). Of participants, 33 (12.4%) had organ donation ID card and 234 (87.6%) did not have organ donation ID card. Of physicians, 128 (47.9%) showed willingness toward organ donation, 44 (16.5%) did not show willingness, and 95 (35.6%) had no idea. The participants were mostly aware of liver (n=253, 94.8%), kidney (n=249, 93.3%), cornea (n=245, 91.8%), and heart and heart valves (n=240, 89.9%) among all other donatable organs and tissues. Only 27 participants (10.1%) reported that physicians provided sufficient information about organ donation and transplantation. In addition, 170 physicians (63.7%) reported that organ donation was permissible in Islam.

CONCLUSION: The present study revealed considerable deficiencies in the knowledge about organ donation in physicians. In addition, the rate of registration for organ donation and the willingness toward organ donation was low in physicians. It was found that physicians did not have exhibit positive attitude to widespread acceptance of organ donation.

Keywords: organ donation, physicians, knowledge

P-1397

Evaluation of the Level of Knowledge, Attitude, and Behavior Toward Hepatitis B Virus (HBV) and Hepatitis C Virus (HCV) Infection in Barbers

Hamit Sırrı Keten¹, Hüseyin Üçer², Numan Güvenç², Derya Keten³, Celal Kuş², Mustafa Çelik²

¹Department of Family Medicine, Kurtul Family Health Center, Kahramanmaraş, Turkey

²Department of Family Medicine, Medical Faculty, Kahramanmaraş Sutcu Imam University, Kahramanmaraş, Turkey

³Department of Clinical Microbiology and Infectious Diseases, Necip Fazıl City Hospital Kahramanmaraş, Turkey

BACKGROUND: The aim of the present study was to evaluate the level of knowledge, attitude, and behavior toward HBV and HCV infection in barbers in order to make contribution to public health policies.

METHOD: The study included 165 barbers in Kahramanmaraş city center between March 3rd 2015 and June 10th 2015. The teachers were informed of the study and those who provided written consent were included in the study. A questionnaire that was prepared in accordance with the literature knowledge was administered to measure the level of knowledge about hepatitis B virus (HBV) and hepatitis C virus (HCV) infection in barbers.

RESULTS: The mean age of the participants was 27.33±10.87 (min=10, max=67) years. The total time spent in the occupation was 14.48±10.68 years (min=1, max=50). It was found that 78 barbers (47.3%) had taken the HBV vaccine. Of participants, 76 (46.1%) previously received training on HBV and HCV. Of these barbers, 117 (70.9%) were aware of HBV infection and 100 (60.6%) were aware of HCV infection. Of participants, 128 (77.6%) reported that hepatitis infections were contagious and 17 (10.3%) reported that hepatitis infections were not contagious, and 20 (12.1%) had no idea. Of the barbers, 101 (61.2%) reported that they had sufficient level of knowledge about the routes of transmission for HBV and HCV and 64 (38.8%) reported that they did not have sufficient level of knowledge. Of participants, 97 (58.8%) had taken the HBV vaccine to protect against the infection.

CONCLUSION: The study showed that barbers have insufficient level of knowledge about HBV and HCV infections. It is of particular importance to deliver training to barbers, which constitute an important occupational group for HBV and HCV carriage.

Keywords: Barbers, Hepatitis B Virus, Hepatitis C Virus, Knowledge

P-1398

An HIV-negative Case With Kaposi Sarcoma

Mehmet Altuğ¹, Melahat Akdeniz²

¹Beyşehir 3rd Görgün Yavuz Family Health Center, Konya

²Akdeniz University, Department of Family Medicine, Antalya

INTRODUCTION:

Kaposi Sarcoma (KS) was originally described by Moritz Kaposi in 1872 as "idiopathic, multiple, pigmented hemorrhagic sarcoma of the skin". It has varying clinical course ranging from minimal mucocutaneous disease to diffuse organ involvement. It is categorized in 4 types as AIDS-related endemic type, KS in iatrogenically immunosuppressed patients, classic or sporadic type and Africa endemic type. Sporadic type KS is usually seen in Mediterranean or East Europe countries, in men over the age of 50.

The lesions of KS can be observed in skin, oral mucosa, lymph nodes and visceral organs. Majority of patients present with skin lesions. These skin lesions can start at any region but they typically condense at lower extremity, head and neck region. Lesions can be in the form of macules, papules, nodules or plaques.

THE CASE:

A 56 years old male patient presented to family health center with purple lesions that started at his toes nearly six months ago and spread to his feet later. In his physical examination, his overall condition was good, he had

diffuse lesions at his feet with uncertain borders. His medical history was featureless. According to his family history, his uncle had Kaposi sarcoma. The patient was consulted with cardiovascular surgery and and dermatology clinics with initial diagnoses of venous insufficiency, angio-dermatitis and Kaposi sarcoma. The patient was diagnosed with HIV-negative Kaposi sarcoma. This form of the disease is a vascular proliferation characterized with painless, purplish lesions that occur especially at lower extremities. There is no cure for the disease: however, antiviral and antineoplastic drugs can be used either alone or in combination.

CONCLUSION: As well as the commonly occurring diseases, rare diseases, also called the "zebra"-type diseases are also encountered in primary healthcare. Obtaining family history appropriately is useful for family physicians in making the diagnosis.

Keywords: Family medicine, Kaposi sarcoma, HIV

Lesions in the feet



Lesions in the feet



P-1399

A Burkitt Lymphoma Case Presenting With Cervical Lymphadenopathy

Mehmet Altuğ¹, Melahat Akdeniz²

¹Beyşehir 3rd Görgün Yavuz Family Health Center, Konya

²Akdeniz University, Department of Family Medicine, Antalya

INTRODUCTION:

Lymphadenopathy (LAP) is a commonly observed finding during physical examination by family physicians. They are mostly benign and related to infections, responding to antibiotic treatment. Very few are related with cancers such as leukemia and lymphoma, and cancer metastases. The most common error related with LAP cases in Turkey is monitoring with repetitive antibiotic treatment. Cervical LAP can be caused by non-Hodgkin lymphoma (NHL) of the lymphatic system. NHL can arise in immunosuppressed patients and patients who receive immunosuppressive drugs. Burkitt lymphoma (BL) is a relatively rare and aggressive type of NHL. This disease mostly occurs in the face; 55-75% of the patients have involvement of the face. At the time of diagnosis, 30-50% of the patients have disease in its advanced stage. In Turkey, abdominal involvement is common, with a rate of 70%.

THE CASE:

A 32 years old female patient presented to the family health center with a painless mass that started below her mandible three weeks ago and enlarged gradually. Despite taking antibiotics for a week, the mass did not regress in size. In her physical examination, her overall condition was good, there was a mobile and painless lymphadenopathy, 3x4 cm in size at cervical region. The patient was consulted with ear nose throat clinic. An excisional biopsy revealed a diagnosis of NHL-Burkitt lymphoma and chemotherapy was initiated.

CONCLUSION:

Cervical LAP in adults is frequently encountered in family medicine practice. Presence of a lymphadenopathy in cervical region should be thoroughly investigated in all patients with consideration of the rare diseases, and differential diagnosis should be made. Recognition of the rare but vitally-critical diseases and appropriate management by family physicians is essential for treatment of the disease in its early stage.

Keywords: Family medicine, Burkitt, lymphadenopathy, non-Hodgkin lymphoma

Cervical LAP



P-1400

Efficacy and tolerance of chronotherapy in hypertensive patients using a 24h AMBP measurement

Manuel José Viana¹, Ana Margarida Correia², Paulo Rui Pessanha², Susana Bertoquini⁴, Ana Iva Costa², Jorge Polónia³

¹Faculdade de Medicina da Universidade do Porto

²USF S. João do Porto – ACeS Porto Ocidental

³Hospital Pedro Hispano

⁴Faculdade de Psicologia e Ciências da Educação da Universidade do Porto

Background & AIM: To achieve the best antihypertensive drug administration time, day or night, evaluating the tolerance and efficacy of the drug administration in two schedules.

METHOD: Crossover, clinical randomized trial, including 32 hypertensive patients, aging 18-75 years old, taking at least one antihypertensive drug. Patients were divided in two groups, taking antihypertensive drugs by morning or by night. After six weeks, each patient was submitted to a 24h-ambulatory measurement of blood pressure (AMBP) and a 24h-urine test (microalbumin, creatinine, sodium excretion), switching the schedule to night and morning, respectively. After six weeks they were evaluated again (24h AMBP, urine test, quality questionnaire).

RESULTS: Morning drug administration data: 24h blood pressure (BP) - 125/76 + 12/9mmHg; daytime BP - 129/79 +12/9mmHg; nighttime BP - 116/69 + 15/9mmHg; morning BP peak, night fall BP and % of systolic BP of 17 + 18 mm Hg; 9 + 6%. Night administration data: 24h BP - 126/77 + 11/8 mmHg; daytime BP - 129/80 + 11/9 mmHg; nighttime BP - 117/69 + 15/9 mmHg; morning BP peak, night fall BP and % of systolic BP of 21 + 11mmHg; 9 + 7%. All of the results had a $p>0.12$. 87.5% of the urine samples were validated, with a medium salt intake of 16.25g/day.

CONCLUSION: There was not a statistical difference between the two schedules of administration (absolute BP, BP night fall, morning peak in the systolic BP). Salt intake was much higher than recommended by WHO. Each patient should be given an individual treatment, concerning patient's preferences.

Keywords: Blood Pressure Monitoring, Ambulatory; Drug Chronotherapy; Hypertension

P-1401

Physician-patient relationship in the treatment arrangements, shared decision-making and patient satisfaction

Fatıma Yüce¹, Nilgün Özçakar²

¹Department of family medicine, Ankara university, Ankara, Turkey

²Department of family medicine, Dokuz Eylül university, İzmir, Turkey

Background & AIM: To expose patient-physician relationship, patients' thoughts and expectations about shared decision making in treatment process and relation between these topics and patient satisfaction.

METHOD: This is a cross-sectional study which participants were prescribed outpatients applied to primary care center (PCC) in 1-31 December 2013. A questionnaire including demographic information, patient' opinions and Turkish form of EUROPEP (Patients Evaluate General/Family Practice) scale was administered by the researcher face to face. SPSS 15.0 software, chi-square,t-test and ANOVA were used in evaluation of the data.p<0.05 was considered significant.

RESULTS: Of respondents 66.7% were female, 64.0% percent were high educated and the mean age 45.92±13.83. Totally 300 patients had prescribed in a PCC were included in the study. Preferences of patients in treatment organizing process were categorized in three groups. "shared decision making with the physician"(63,3%), "physician should decide"(32,0%), "physician should offer treatment options and I should decide"(4,7%). Total patient satisfaction scale mean score was 89,9±18,23. Clinical behavior subscale score was 64,80±13,43.Service organization subscale score was 25,15±6,80. Patient satisfaction scale scores were high who had asked ideas while had been prescribing and had given information about drugs and their side effects(p<0,05).

CONCLUSION: Shared decision making as patient centered approach in the process of treatment, affects positively the patient-physician relationship. This fact is also effective on satisfaction of patients in medical care. We believe that this approach which is quite valuable for medical care should have been adopted and participated in treatment process by the family physicians

Keywords: Patient-physician relationship in treatment process, Shared decision making, Patient satisfaction

P-1402

Antibiotic use in children of mothers SITUATION AND KNOWLEDGE LEVEL

Ceren Karaman Kenesari¹, Nilgün Özçakar²

¹ceren KARAMAN KENESARI,Dokuz Eylül Üniversitesi,İzmir,Türkiye

²Nilgin ÖZÇAKAR,Dokuz Eylül Üniversitesi,İzmir,Türkiye

Antibiotic resistance is defined as; a certain strain of microorganism species not influenced by the antibiotic or antibiotic-sensitive strains which has become resistant with various resistance mechanisms. The wrong or unnecessary use of antibiotics is the most important factor that led to the rapid spread of resistant bacteria. In our study we aimed to evaluate the level of knowledge of mothers about antibiotics and contribute to limiting the unnecessary use of antibiotics.

Our research was carried out in November 2013 in Hatay, İzmir, health care center with number 24. Study data is collected by a face to face survey with mothers who have at least one preschool age child. Mothers were asked 6 questions including sociodemographic information, 6 questions related to knowledge about antibiotics, 10 questions related with behavior and also 3 questions to assess their attitudes. After the survey, there was brief information to mothers about the rational use of antibiotics. A month later, the mothers were surveyed by telephone with the same questionnaire. We viewed whether the difference between the two groups before and after the information was. Data were analyzed with SSPS 15.0. Mc Nemar analysis performed. P <0.05 was considered as statistically significant. We have created an awareness of the true knowledge of the intended use of antibiotics at the end of our study. The most important contribution of this study for mothers was the

improvement of knowledge about antibiotic side effects. By this study we aim to create awareness about the correct use of antibiotics and rational drug use. With brief information we have provided difference on certain issues. Rational antibiotic use is still an important health issue in our country.

Keywords: antibiotics, children, rational drug use

P-1403

Reaching Out to the Youth of South-West Uganda: Sex-Education

Emma King¹, Clare Goodhart², Jonathan Graffy³, Sarah Uwimbabazi⁴

¹Tower Hamlets, London, United Kingdom

²Cambridge, United Kingdom

³Cambridge, United Kingdom.

⁴Bwindi Community Hospital, Uganda

Our aim was to test the feasibility of a church outreach sex-education programme for youth aged 14-20 years aimed at preventing HIV and teenage pregnancy. An additional objective was to collect data to ensure the programme is responsive to the needs of the target population.

We targeted 5 locations across 3 sub counties in south-west Uganda. The sessions included condom demonstrations and 3 health talks; "HIV", "Teenage Pregnancy" and "Periods and Personal Stuff".

Overall, 516 youths attended and 453 completed a baseline knowledge quiz. The results of the quiz demonstrated which topics were best and least understood. 81% knew that HIV could be treated but 51% did not know about the risk of mother to child transmission. 39% thought that contraceptives could cause permanent infertility.

Throughout the sessions, anonymous written questions were invited and answered. These questions indicate the concerns and misconceptions of the target group.

A feedback questionnaire asked participants to write two learning points and suggest one thing they wished we had taught them. This gave us insight into what they had gleaned from the sessions and the topics we had missed, such as more about contraception and other STIs.

This pilot programme acted as a thorough needs assessment for providing sex-education to the target group. The data collection tools embedded within the programme will continue to help it respond to the needs of this group. This approach is relevant to similar programmes in a multitude of settings.

Keywords: Youth, sex education

AUTHOR INDEX

A Siddiqui Muhammad P-0928
Aarendonk Diederik WS-039, WS-046
Aaron José Alcibiades Durán P-0033, P-0083
Abajo Llama Susana OP-077
Abanonu Gül Babacan P-0358
Abbak Hilal P-1120
Abbott Sydney P-0645
Abd Elstaar Taher E. Abd Elstaar Eid OP-036
Abdul Jabar Maryam P-0928
Abdul Malek Khasnur P-0456
Abdul Rahman Abdul Rashid P-1058
Abdul Rashid Aneesa P-0453, P-1058
Abdulhalikov Turyan P-0360
Abdullah Laila P-1257
Abi Rizk Grace OP-184, OP-268, WS-019
Abolfotouh Mostafa P-0408
Abon Alejandro OP-163, OP-187
Abrantes Arnaldo P-1173
Abreu Ana Filipa Leite P-0112, P-0734
Abreu Cecilia Oliveira P-0177
Abreu Diogo P-0824
Abreu Frederico P-0520
Abreu Maria João P-0090, P-0392, P-0520, P-0615, P-0730, P-1054, P-1057
Abreu Raquel Cardoso P-0093, P-0130, P-1253
Abreu Mendes Ines P-0049, P-0565
Abu Bakar Ahmad Ihsan P-0456
Abu Hanna Ameen P-1221
Abu Zuhairah Ammar R OP-141, OP-142
Abuladze Nino OP-087
Abusarhan Nawal OP-205, P-0940
Abuznadah Wesam P-0948
Acar Ethem P-0755
Acar Muhammed Sefa P-0473
Acar Yeliz P-1160
Acebron Sanchez Fortun Carmen P-0034
Acevedo Javier Arnes OP-132, P-0714, P-0895
Achmed, Gp Marwa WS-013
Açıkgöz Yonca P-1165
Ackermann Anne Marie P-0348
Ada Sibel P-0056
Adrega Tiago OP-024, OP-027, P-0096, P-0097
Adriyanov Kostov Belchim P-0838
Afonso Mariana P-1231
Afonso Mélanie OP-106, P-0139, P-0515
Afyoncu Erkut P-0429
Agadayı Ezgi P-0081
Agadayı Sıtkı P-0081
Agafonov Boris Valentinovich OP-160
Ağaoglu Hasret OP-034
Agbektas Rumeysa P-1174, P-1177
Agostinho Milena Rodrigues OP-174, P-0855, P-0856
Agreus Lars WS-058
Águeda José Pedro OP-155
Agueros Fernandez Maria Jose OP-198, OP-199, P-0241, P-0370, P-0972, P-0976, P-0979, P-0031
Aguilera Samaniego Patricia Noemi OP-199, P-0241, P-0972, P-0976, P-0979
Ahip Sally Suriani P-1002

Ahmad Adeel Nazir BR-059
Ahmad Tajuddin Nur Amani Natasha P-0456
Ahmadi Far Mehdi P-0982
Ahmed Almoutaz Alkhier OP-151, P-0948
Ahmed Maryam P-0217
Ahresen Jette SYM-010
Ajmi Thouraya P-1289
Ak Filiz WS-038, P-0462, CON-010
Ak Mehmet P-0122, P-0135, P-0741
Ak Muharrem P-1012
Akan Hülya OP-078, OP-117, OP-281, BR-074, P-1111
Akay Ayse OP-225
Akbaba Özgür OP-194
Akbayın Zelal WS-113
Akbayram Hatice Tuba OP-207
Akbiyık Derya İren OP-278, P-1390, P-1391, OP-115, P-0468, P-0501, P-0542, P-0568, P-0724, P-1038, P-1075, P-1386
Akbulut Halil P-0122, P-0135, P-0723, P-0741
Akca Fatih P-0225, P-0226, P-0543
Akca Ömer P-0055, P-0257, P-0258, P-1154
Akcan Mediha P-0234
Akçay Ahmet P-0354
Akçay Fatih P-1341
Akdemir Hakan OP-282
Akdeniz Melahat P-0438, P-0529, P-0700, P-1237, P-1398, P-1399
Akdoğan Mehmet Fatih P-0358
Aker Servet P-0674, P-0675, P-0676, P-0677, P-0701
Akgedik Recep P-1105
Akgün Ali Emre P-1121
Akgün Hüseyin OP-075
Akhtar Ziti P-1002
Akici Narin P-0434
Akıcı Sara P-0386
Akıl Ata OP-017
Akıllı Hakan P-0360
Akin Sibel P-0989
Akın Efsun OP-287
Akın Yasemin OP-069
Akkan Esra P-1201
Akkaya Kürsad OP-111, P-1361
Akkaya Ufuk P-0222
Akkoca Ayşe Neslin P-0211, P-0212
Akkoca Esra P-0229
Akkus İbrahim Halil P-0748
Akman Mehmet OP-078, OP-271, WS-039, WS-049, WS-064, PNL-010, SYM-025, P-0215, P-0355, P-0376, P-0951
Akman Usguloglu Zeliha P-0861
Akpınar Yakup OP-073, OP-081, P-0369, P-0429, P-0430, P-0440
Aksoy Hilal P-0321
Aksoy Sevim OP-065, P-0709
Aksoy Kartçı Sevim P-0338, OP-090
Aksoyek Aydan P-0695
Aktan İbrahim Hakkı OP-079, P-0386
Aktas Gülali P-0210, P-1105
Aktas Rabia Adeviye BR-046
Aktaş Güney WS-119
Aktimur Recep P-0977

Akturan Selcuk WS-049
Akturan Selçuk P-1340
Aktürk Zekeriya WS-101, P-0981, P-1048, P-1049, P-1053, P-1183
Akyol Elif P-0075
Akyol Ergun OP-233, P-1370
Akyol Gamze OP-066, WS-037, P-1137, P-1144
Akyüz Yusuf P-0750, P-0853, P-1345, P-1351
Akyüz Özkan Esra P-0211, P-0212
Al Habbal Khairat WS-076
Al Odhayani Abdulaziz P-0652
Alacacıoğlu Ahmet P-0789
Alagöz Pınar P-0225, P-0226
Alagöz Yasemin P-0161, P-0171, P-0337, P-0744, P-0815
Alagüney Mehmet Erdem P-0189, P-0190
Alamo Dolores P-0865
Alan Hakan P-1101
Alanyalı Fikret Merter OP-152, P-0862, P-0939, P-0959, P-1378, P-0872
Alarcón Pariente Enrique P-0275
Alassa Israa OP-205, P-0940
Alastrue Violeta P-1270
Alataş Ömer Doğan P-0755
Alavcı Özgür P-1167, P-1168, P-1393
Alavere Helene P-0662
Albaladejo Blanco María P-0282, P-0284, P-0285
Albayrak Canan P-0433
Albayrak Davut P-0433
Albayrak Turgay P-0055, P-1154
Albelda Vendrell Rosa P-0166
Alcantud Eva Fernández OP-144
Alcantud Lozano Pilar OP-224
Alcaraz Rosa P-0509
Aldana Daniel Rey P-0001, P-0144, P-0145
Aldawood Kasim Mohammed OP-141, OP-142
Aldaz Pablo OP-010, P-0330, P-0341
Aleixo Sérgio P-0196
Alem Fasika OP-255
Alenius Heidi P-0291
Alepidis Dimitrios WS-097
Alexandropoulou Parthenopi P-1071
Alexiu Sandra WS-024, WS-026, SYM-013
Alexiu Sandra Adalgiza OP-118, WS-025, PNL-001, P-0936
Alghamdi Saad Abdulrahman OP-151, P-0948
Alguacil Ramos Ana Maria P-0570, P-0571
Alhaqwi Ali OP-235
Ali Norsiah OP-259
Alibasic Emir P-0013, P-0019
Alibasic Esad P-0013, P-0019, P-0051, P-0555, P-0557, P-0973, P-0986, P-0992
Alić Alma Smailkadić P-0015
Alic Pasalic Enisa P-0057
Alıcı Ömer P-0977
Alimanović Esad P-0015
Alkan Çiğdem P-0464
Alkan Murat P-1339
Alkan Melikoğlu Meltem P-1332, P-1333, P-1338, P-1379
Allen Justin WS-057
Almansa Cristina P-0733

Almeida Joana P-0147, P-0324
Almeida Miguel Ângelo P-0223
Almeida Renata P-0526, P-1321, P-1328
Almeida Rita P-0412
Almeida Sara Generosa OP-155, P-1014
Almendro C Eulalia Almendro OP-144
Almendros Plana Laura P-0595, P-0842, P-0843, P-1217
Alonso Carmen Fernández P-1342
Alonso Esther Bracero P-0009
Alonso Ramón J. Gonzalez P-0240
Alonso Yolanda P-0539
Alonso Flores Álvaro P-0618
Alonso Garcia Concepción P-0323, P-1247, P-1252
Alonso Gonzalez Antonio OP-198, OP-199, P-0972, P-0979
Alonso Lopez Fernando WS-102
Alonso Montoto Miguel P-0556
Alper Züleyha WS-070
Alper Gurz Ayşenur P-0102, P-0263, P-0474, P-0898
Alqurashi Abdulelah Mutlaq OP-151
Alrowaily Mohammed Abdullah P-0408
Alsancak Yakup P-0350, P-0407, P-1097
Alsaudi Lubna OP-205, P-0940
Alshatri Hind P-0408
Altaba Ana M^a P-0048, P-1032
Altan Selim OP-139
Altayeva Akmaral Mukhanbetovna OP-189
Altimiras Rovira Silvia P-0595, P-0842, P-0843, P-1217, P-1218, P-1240
Altınbaş Zuhâl P-1124
Altiner Attila P-0343
Altınok Ali P-0708
Altıparmak Duygu BR-029
Altuğ Mehmet P-0438, P-1398, P-1399
Altun Abdurrahman P-0708
Altun Aylın OP-196
Altun Nida Şebnem P-1385
Altunbaş Ateş Elif P-0045, P-0047, P-0146, P-0236, P-0259, P-0445, P-0485, P-0660, P-0717, P-1149, P-1159, P-1388
Altunkaya Tuğba P-1255
Altuntaş Murat BR-037, P-0225
Altuntop Mustafa P-1101
Alvarez Carmen P-0563
Alvarez Marta P-0896
Alvarez Silvia P-0084, P-0141
Álvarez Silvia Álvarez OP-144, P-1151
Alvarez Jimenez Pablo P-0779
Alvarez Porta Enrique P-0626
Alvero Cruz Jose Ramon P-0728
Alves Ana Sofia P-0319, P-0320
Alves Bernardo Lago P-0017
Alves Diogo P-0266
Alves José Verdelho P-1274
Alves Pedro Filipe P-0398, P-0766, P-0565, P-0619
Alves Sílvia P-1325
Alves Sofia P-1280
Alves Thiago Pimenta OP-131
Alzamora M^a Teresa P-0048, P-1032

Alzamora Maria Teresa P-0202
Amaral Daniel Rosa OP-220, P-0891
Amaral Patrícia P-0514
Ambareva Zornitsa P-0108, P-0110, P-0916
Ambigapathy Subashini OP-029
Ameijeiras Álvaro Hermida P-0144
Amin Niro WS-063
Amorim Angela P-1358
Amorim Gustavo Aguilar Alvarenga OP-005, OP-108, OP-131, OP-252, P-0757, P-0772, P-1178, P-1180
An İsa P-0363
Ana Abdiana P-0846
Ana Gangoso OP-187
Ana Isabel Villimar OP-187
Andersson Gudrun P-0100
Andersson Inga Lena P-0100
Andrada Gomez Estefania P-0794
Andrade Sara Isabel P-0811
Andreasson Anna Nixon OP-070
Andreou Martha P-0029
Andrieu Sandrine OP-091, OP-092
Andriopoulos Panagiotis OP-072, WS-009, SYM-008, P-0312
Angelidi Angeliki P-1068
Angghada Fernaldi OP-113
Angier Elizabeth SYM-002, SYM-003, SYM-009
Angın Doğukan Ali OP-064, OP-130
Angstman Kurt P-0016, P-0080
Anguelova Valentinova Lia P-0335, P-0830
Anık Ahmet P-0775
Anindya Dahniar OP-113
Anjos Diogo Pena Dos P-0913
Ansaldo Pérez Ma Del Mar P-0559
Antón García Francisco OP-095
Antón Sanz María Carmen P-0044
Antoun Joumana P-1147, P-1148
Antunes Ana Rita OP-159
Antunes Andrea Pova P-0622
Antunes Maria Inês Araújo P-0112, P-0734
Antunes Ricardo P-0283
Apaydın Kaya Çiğdem OP-090, WS-049, SYM-011, P-0138, P-0338, P-0694, P-0768, P-0769, P-1374
Appleton Amber P-0935
Aprile Silvia P-0098
Aracı Kadir P-0378
Aragó Vidal Carme P-0857
Araki Takashi OP-218
Aran Tolga Nasuh WS-075
Aranauskas Ramunas P-0827
Araújo Carla Santos OP-176, P-1295
Araújo Joana P-0130
Araujo Marquez Laura P-0349
Araz Caner P-0423
Arbaizar Ana P-0896
Arbaud Gladys OP-051
Arboix Judit Llussà OP-046
Arbolí Marta P-0650
Arca Pichel Carmen P-0556, P-0601, P-1043
Arcarons Marta P-0199, P-0200

Ardagil Akcakaya Aylin P-1354
Arderiu Elisenda Sant P-1151
Ardey Rajeev OP-182
Ardey Rashmi OP-182
Ardıç Aykut BR-032
Ardini Witri OP-245
Arfaj Ghada A. Al P-0652
Argueta Armenta Rogelio P-0539
Argun Melahat P-1368
Arguvanli Sibel P-0989
Arias Andres A. Martínez P-0244
Arias Juan Pablo Rodriguez P-1342
Arica Seçil P-0201, P-0420, P-0436, P-0441, P-0447, P-0996, P-1011, P-1052, P-1115, P-1172, P-1258
Arıcı Gülay P-1115
Arija Val Victoria OP-077
Arik Yunus OP-216
Arıkan Güliz Dirimen P-1186
Arisanti Nita OP-170, P-0522
Armero Juan Miguel P-0884
Arnau Perramon Gemma P-0794
Arnould Benoit OP-116
Arnould Pascale OP-116
Arribas Álvaro Pilar P-0040, P-0044
Arrillaga Ocampo Idoia P-0606
Arroyo Moreno Victor P-1084
Arseni Georgia P-0379, P-0497, P-0847, P-0968, P-1279
Arslan Bahriye P-0178, P-0663
Arslan Çağla P-0952, P-0958
Arslan Caner P-1211
Arslan Goncagül P-0951
Arslan Gülay P-1160
Arslan İbrahim P-0182
Arslan İsmail OP-028, P-0458, P-0710, P-0978, P-1039, P-1094, P-1097, P-1134, P-1198, P-1360
Arslan Mehmet P-0729
Arslan Mutluay P-1114
Arslan Müzeyyen P-0075
Arslan Necmi OP-017, P-0173, P-0541, P-0825, P-0944, P-1117, P-1268
Arslan Serap Yurdagül P-0151, P-0152, P-0825
Arslan Özkul Seda P-0138, P-0694
Arslantas Inan OP-111
Arslantaş İnan OP-246
Arsov Stefan P-0067
Artıran İğde Füsün Aysin P-0102, P-0263, P-0364, P-0474, P-0588, P-0589, P-0590, P-0602, P-0898, P-0907, P-0909, P-0949, P-0950, P-1021, P-1107, P-1138, P-1140, P-1392
Arts Derk L OP-026, WS-098, P-1221
Arvanitidou Malamatenia P-1025
Arvonen Tuula P-1216
Arya Insi Farisa Desy OP-170
Asar Semsettin Can OP-225
Asenova Radost SYM-010, SYM-023, P-0108, P-0110, P-0916
Asimakopoulos Antonis P-1296
Aşkar Tünay Kontaş P-0409
Askın Meryem OP-225
Aslan Aslı P-0385
Aslan Burcu P-0352, P-0464, P-1113
Aslan Deniz OP-053, P-0538

Aslan İlknur OP-017
Aslan Müslüm P-0870
Aslan Senem OP-031
Aslan Şeyda P-1242
Aslan Ümit P-1189
Aslan Aydoğdu Zehra P-0045, P-0259
Aslanhan Hamza P-0173, P-0363, P-0541, P-0647, P-0825, P-0944, P-1117, P-1268
Asma Süheyl P-0072, P-0148, P-0154, P-0523, P-0689, P-0720, P-1090, P-1111, P-1329
Aspley Sue P-0255, P-0260
Assadi Hamza P-0657
Assis André Vinicius Batista De P-0892
Asyifa Aliefa OP-245
Atal Sefa Semih OP-196
Atalay Cemal Reşat P-0478, P-0765
Atalay Süheyla P-0426, P-1018
Ataoglu Hayriye Esra P-0005
Ataş Aslan Ebru P-0365
Ateş Hale P-0020
Ateş İhsan P-0020, P-0021, P-0022, P-0055, P-0257, P-0258
Ateş Tuba Dilek P-0056, P-0930
Atmaca Işıl P-0703
Atmaca Muhammed P-1387
Atmaca Murat P-0155, P-0237
Atsız Seyma OP-177
Atsız Sezik Handan P-0457, P-0789
Auad Natalia Jacomo OP-005, OP-131
Aubart Monique OP-123, WS-001, P-0965
Avellaneda Fernandez Alfredo OP-198, OP-199, P-0241, P-0370, P-0972
Avino Rosa WS-034, P-0805, P-0894, P-0945
Aviño Jose Espuig P-0176
Avramovic Gordana OP-247
Avsar Ayse Filiz Yavuz P-1083
Avşar Fatma Zehra P-0461, P-0699
Awg Dzulkarnain Dayangku Hayaty OP-019, P-0453, P-0594
Axelsson Mette P-0100
Ay Emre P-0708
Ay Pinar P-0685
Ay Pınar P-1236
Ay Sedat P-0608, P-0609
Ay Seyid Ahmet P-1345, P-1351
Ay Zeynep OP-177, P-0457, P-1112
Ayala Carreño Cristian P-1265
Ayata Şule Nurşah P-0434
Ayaz Emre P-1141
Ayaz Gürkan P-0215
Aybek Yılmaz Arzu OP-177
Ayça Burak OP-283, P-0584
Aydemir Birsan P-1078
Aydemir Nurcihan OP-277
Aydemir Sinem OP-120, P-0578, P-1155, P-1369
Aydın Adnan P-1385
Aydın Mehmet P-0533
Aydın Tuba P-1169
Aydınay Sinem P-1373
Aydoğan Timucin P-0182

Aydođan Ümit OP-012, Course-010, PNL-010, P-0122, P-0131, P-0135, P-0295, P-0394, P-0723, P-0741, P-0750, P-0807, P-1114
Aydođdu Aydođan P-0807
Aygün Canan P-1194
Aygün Kemal P-1288
Aygün Olgu OP-177, OP-203, WS-007, WS-116, P-0197, P-0924, P-1070
Ayhan Bařer Duygu OP-062, WS-104, P-0316, P-0321, P-0350, P-0407, P-1226, P-1243, P-1266, P-1353
Ayiomamitis George P-1069, P-1073
Aykanat Burcu P-0045, P-0660
Aynaođlu Özlem P-0952, P-0958
Ayomi Marlyn R P-1313
Ayoob Sahar Sami OP-070
Aypak Cenk OP-115, OP-278, P-0468, P-0490, P-0501, P-0542, P-0568, P-0724, P-1038, P-1075, P-1201, P-1386, P-1390, P-1391
Ayraler Arzu OP-117
Ayrancı Ahmet P-0708
Ayře Uzuner P-0696
Aytekin Seda P-1136
Ayude Diaz Sandra Mª P-0508
Ayuso Maria Candelaria OP-083, OP-085, OP-224, P-0884, P-0897, P-1066
Azenha Ana Sofia OP-155, P-1014
Azevedo Cristiana OP-190
Azevedo Joāo P-0510
Azevedo Pedro OP-190, P-1310, P-1316
Aznar Pilar P-0159
Azorín Ras Milagros OP-224
Azzam Adam P-1223
Baba Alper P-0735
Babaođlu Ulken P-0990
Babic Ivana WS-083, WS-097, P-0881, P-0908
Bacchus Lorraine WS-033
Baccifava Gabriele P-0579
Bachir Hebab Saas Bob P-0003, P-0083
Bäckström Helena WS-062
Badea Gabriela Cristina Elena BR-064
Badenbroek Ilse OP-100
Baena Díez José Miguel P-0599, P-1034
Bærheim Anders OP-242
Bađcier Fatih P-1331, P-1332, P-1333, P-1334, P-1335, P-1338, P-1339, P-1379
Baghele Vishal Mallusingh BR-010, BR-053, P-0410
Bađrıyanık Yusuf Ökkeř P-0431
Baguet Lula P-0657
Bahadır Adem P-0055, P-0257, P-0258, P-0690, P-1154
Bahadır Anzel P-1126
Bahk Hyun Jung P-0573
Bahs Guntis P-1009
Baibaba Ade Irma P P-1313
Bailee Thanawan P-0042
Bajraktarevic Amila P-0973
Bak Kirk Ulrik WS-113
Bakalis Ioannis P-1071
Bakar Cořkun P-0990
Bakir Zeynep P-1145
Bakır Binnur OP-078
Bakola Maria P-1064, P-1284, P-1285, P-1346
Bal Ceylan P-0184, P-0189, P-0190, P-0192

Balabayeva Gulsara P-0309, P-0389
Balçı Umut Gök P-0795, P-1393
Balçı Yasemin P-0755
Baldemir Ercan P-0869
Balık Gurcan P-1137
Balkan Salih Mujdat P-0723
Bally Bruno OP-168
Baltacı Davut P-1126, P-1136
Baltuille Aller María Camino P-0040
Ban Toskic Natasa OP-179
Bandrés Marta P-0664
Baneviciute Domarkiene Ruta P-0060, P-0061, P-0062, P-0064, P-0076, P-0078, P-0086
Banjanin Žani P-1352
Baonza Eva P-0537
Baptista Ana P-0196
Baptista Joana Oliveira P-0969
Baptista Juliette OP-009
Baptista Sofia P-0639
Baquer Sahun Cristina Ana P-0186
Baraga Dušan P-0220
Barai Kushal P-1220
Barata Ana P-0894, P-0945
Barata Ana Nunes OP-048, WS-007, P-0499, P-1310, P-1316
Barba Maria P-0611
Barbacariu Liliana WS-027
Barbieri Ana Rita OP-156, OP-158
Barbosa Eduardo Rafael De Lucena Costa OP-176
Barbosa Manuel Ángel P-0759
Barbosa Manuel Maria P-1269
Barbu Cristina WS-024, WS-026, PNL-001, SYM-013
Barbu Cristina Vasilica P-0936
Bárcena Atalaya Ana Belén P-0960
Barcin Cem OP-012
Bariliene Sonata P-0716, P-0732
Barış Şule P-0726
Barkley Shannon WS-042
Barnard Amanda WS-033, WS-036, WS-048, WS-089, P-0887
Barnhoorn Pieter WS-072, WS-073, P-1282
Barra Tiago P-0697
Barranco Arancha P-0832
Barranco Cozar Lluisa P-1218
Barreiros Rafael Nascimento P-1295
Barrio Jaime P-0832
Barrio Ruiz Carmen P-0502
Barror Suzanne OP-269, WS-068
Barros Bethânia Peccini P-0926
Barros Joana Andrade P-0120, P-0395, P-0736, P-1274
Barros Maria Elizabeth Barros De OP-136
Barros Nuno P-0632
Barry Vince P-1232
Barth Marie OP-123
Barzdenis Ignas P-1028
Barzdenyte Mante P-1028
Baş Aykan Baş P-0142
Baş Funda Yıldırım P-0178, P-0663
Başak Okay OP-239, WS-120, P-0924

Başak Özbalcı Aysu P-0977
Basar Cengiz P-1126, P-1136
Başar Günnur Şerife Course-012
Başaran Burcu OP-065, BR-070, P-0477, P-0709, P-1374
Başaran Çağlar Mehmet P-0431
Başaran Mustafa OP-128, P-0471
Basat Okcan P-0455, P-0608, P-0609
Basat Sema P-1368
Başçı Semih P-0326
Başdemir Bayram OP-017
Başer Aysel WS-121
Başer Serdar P-0316, P-0321
Başhan İbrahim P-1111
Başköy Kamil P-1345, P-1351
Basora Gallisa Josep OP-077
Basora Gallisa Teresa P-1228
Basso Josué P-0856
Basto Cláudia P-0309, P-0389
Bastos Catarina P-1173
Bastos Cristina Maria P-0811
Bastos João Silva P-0114
Bastos Teresa P-1277
Baştürk Abdulkadir P-0161, P-0163, P-0171, P-0188, P-0191, P-0198
Batarda Marisa P-0132, P-1319, P-1320, P-1323
Batic Mujanovic Olivera P-0013, P-0015, P-0019, P-0051, P-0057, P-0555, P-0557, P-0925, P-0973, P-0986, P-0992, P-1030, P-1088
Battal Hilal P-1197
Battaloğlu İnanç Betül OP-274, OP-275, OP-277, OP-289, PNL-011, P-0432, P-0648, P-0649, P-0814, P-0869, P-0962, P-1187, P-1330, OP-053, P-0538
Batzios Spiros P-0418
Bau Rawa P-1002
Baudendistel Ines OP-257
Baužienė Indrė P-0374, P-0572, P-0828, P-0834, P-1022
Bayad Ayşegül OP-175, P-0181
Bayad Serkan P-0667
Bayazıt Onur P-0854
Baydar Aylin P-0143, P-0203, P-0742, P-1176, P-1179, P-1184, P-1243, P-1377
Baydur Hakan OP-052
Baykam Esra P-0429
Baykan Esra P-0428
Bayrak Özdin Sukriye P-0907, P-0909, P-0801
Bayrakçı Nergiz P-0021
Bayraktutar Zeynep P-0774
Bayram Ayşen P-0431
Bayram Tefik P-0461, P-0699
Bayram Değer Vasfiye OP-274, P-0962
Bayram Kayar Nuket P-0156, P-0584, P-0656, P-0867
Baysöz Halil P-0431
Bazighifan Rasha Saleh P-1079
Beca María Teresa P-0832
Beça Helena P-0637
Becarevic Munevera P-0051, P-0555, P-0557, P-0986
Becirovic Dusanka P-1081, P-1312
Becirovic Jasminka P-0986
Beck Thomas P-0821
Bednar Jachym WS-054, WS-055

Beganlic Azijada P-0007, P-1015, P-1016, P-1030, P-1088
Begg Soleman P-0293, P-1223
Beijaert Roy WS-020
Beiro Piñeiro Ana Isabel P-0556, P-1043
Beishuizen Cathrien R OP-092
Bejarano Moguel Veronica P-0349
Beleza Lia Rafaela P-0668
Belgin Gülten P-1172
Belinchon Sara WS-034, WS-107, P-0805
Belmont Sara P-1240
Beltrán Angela María OP-146, P-1047
Benas Betül OP-285
Benavent M Teresa P-1099
Benavent Teresa P-0659
Bendeković Zvonimir P-0581
Bendova Jana P-0591
Benedicto Pañell Carla P-0509
Benigni Elena BR-025, WS-018, WS-111
Benítez De La Poza Agustín P-0606
Benli Ali Ramazan P-0005, P-0345, P-0534, P-0682, P-0683, P-0761, P-0858
Benmejahed Khadra OP-116
Benos Alexis P-0942
Bento Celeste P-0371
Bento Inês P-0638, P-1122
Berendsen Annette WS-030
Berengue González A Carolina P-0221, P-1365
Berger Marjolein Y. OP-206
Berghem Nora P-0291
Bergqvist Yngve P-0763
Beristain Andoni P-1032
Berker Dilek Şensöz P-0765
Bermejo Garcia Begoña P-0972
Bernal Peinado María Dolores WS-109
Bernaldo De Quiros Andrés Sotojove P-0001
Bernard Matthew E. OP-012
Bernardo Maria Manuela P-0129, P-0310, P-0398
Berova Kandemir P-0644
Bersani Camilla P-0158, P-0331
Bertens Loes C OP-208
Bertoquini Susana P-1400
Berven Nina OP-157
Besli Feyzullah P-1126
Besserglik Pnina OP-039
Bettencourt Catarina P-0216
Beyazcicek Tugba P-0543
Beyazçicek Funda P-0543
Beyazçicek Tuğba OP-238, P-0193, P-0238, P-0339
Beyazova Ufuk P-0407
Beydilli Halil P-0755
Bezerra Vinicius Neves P-0836
Bezirgan Sarigüzel Feyza OP-041, OP-057
Bhais Mahmoud P-1292
Bhutta Zulfiqar OP-229
Bianco Anna Chiara P-0579
Bica Catarina P-0631, P-0632, P-0738
Bıçak Suat P-0238

Bıçakçı Burcu P-0351
Bıçakçı Nilüfer P-0977
Biçer Hatice Selcen P-0175
Biçici Özten P-1160
Biessels Geert Jan OP-015
Bilge Uğur OP-239, OP-261, P-1143, P-1336
Bilgiç Cem OP-194
Bilgiç Dalkıran Serap OP-283
Bilgin Burcak OP-177
Bilgin Gizem P-0691
Bilgin Gulden P-1039
Bilgin Muzaffer P-1143
Bilgin Buyukkarabacak Yasemin P-0263
Bilginc Mesut P-1145
Bilginer Reyhan P-0534
Bilyay Hilal Ikbal OP-177
Bircan Mustafa Arslan OP-115, P-0490, P-0501, P-1075
Birinci Seyhan P-0443
Birlik Nuriye P-1160
Birtane Nihat P-0769
Bisbal Navarro Catalina Isabel P-0626
Biscaia André OP-159, P-0829, P-0845
Bitaube Mata Cristina P-1366
Biten Hilal P-0961
Bıyıklıoğlu Tuğrul OP-044
Bjerrum Lars P-1215
Blahova Beata P-0591
Blanc Stephanie P-0517
Blanco Beatriz Torres P-1342
Blanco Díaz Alicia P-0264
Blane David WS-090
Blanes Monllor Almudena P-0025, P-0026
Blanquez Cristina P-0905
Blasche Gerhard P-1156
Blasco Isabel P-0563, P-0733
Blasco Mariano OP-085
Blasco Pablo Gonzalez WS-066, PNL-005
Blendea Cristina Sandu OP-046
Bloch Mark P-0255
Blom Jeanet W. OP-049
Boba Isabel P-0091, P-0635
Bodoutchian Ani P-0549, P-0551
Bodur Hatice P-0081
Boels Anne Meike OP-080
Boerma Wienke SYM-025
Bojaj Gazmend P-1203
Bojčić Ana Borivoje P-1290
Bokhoven Loes Van OP-038
Boks Marco P OP-254
Bolanovska Kamila P-0591
Boler Ilker OP-007
Bolosi Maria P-1346
Bolt Eva Elizabeth OP-266, OP-267
Bolty Samer Ali OP-036
Bölükbaşı Selçuk P-0367
Bond Christine OP-157

Bongers Frans OP-171, OP-172
Bonig Trigueros Irene P-0666
Bonnet Fabrice P-0515
Bonnet Pierre André OP-022
Bontempelli Ivette Fabián P-1047
Boogaerts Eveline WS-078
Boonnontae Siwaporn P-0042
Boran Perran P-1374
Borel Ferraz Isaac Sanglard P-0806
Boreu Quinti Foguet SYM-010
Borges Ana Luísa P-0223
Boros Melinda OP-118
Borras Ana Domenech OP-144
Bos Touwen Irene OP-040, P-0077
Bosak Tamara P-0133
Bosankic Sedina P-1081, P-1312
Bosch Van Nuenen Annemiek OP-171, OP-172
Bosnic Anticevich Sinthia OP-241
Bosqued Laura P-0101
Botelho Rick WS-004
Bou Abboud Naaman Nada P-0487
Bou Abdo Lara OP-268
Bouazziz Nassima P-0657
Bougmiza Iheb P-1289
Boukhors Gary OP-167
Boullosa Estevez Margarita P-1044
Bouma Margriet WS-095
Bouvy Marcel P-1219, P-1222
Boyacıoğlu Emrah P-0807, P-1114
Boz Sevinç P-0952
Bozan Turgut P-0651
Bozdağ Selin OP-145
Bozdemir Nafiz OP-003, OP-237, P-0164, P-0558, P-0804, P-1090, CON-009
Bozhinovska Elizabeta Tome P-0684
Bozhüyük Ali P-0558
Bozkurt Betül P-0717
Bozkurt Bülent P-0020
Bozkurt Hayri OP-073, P-0369, P-0422, P-0429, P-0550
Bozkurt Nurgül P-1050
Bradley Colin Patrick OP-234, OP-248, P-0014, P-1163
Brais Andre OP-084
Bralic Lang Valerija BR-004
Brami Jean OP-168
Branco António P-0617
Brankovic Marina Slobodan P-0087, P-0315, P-1055
Brau Albert P-0084
Bravo Maria Victoria P-0563
Bravo Raquel Gomez PNL-003
Bravo Raquel Gómez OP-137, P-1342
Bravo Victoria P-0733
Brayne Carol OP-092
Bresco Xavier Castro P-0085
Breva Aymerich Joaquín OP-077, P-1228
Brichs Claustre Solé OP-144
Brigas Diana P-1100, P-1234
Brinza Ileana WS-027

Briones Través Adela P-0025, P-0026
Brito Luciana Stoimenoff P-0841
Brito Zerón Pilar P-0838
Briva Oriol Huguet P-0085
Brkic Milica P-0268
Brochado Rita P-0617
Brodersen John P-1037
Broek Stijn Van Den OP-183
Brölmann Hans OP-223
Brown Paul Irving BR-011
Browne John Patirick OP-234, OP-248, P-1163
Brull Jennifer Lynne OP-154
Bubnič Sotošek Katerina P-0620
Bucaktepe Adil P-1384
Bucaktepe Gamze P-0944
Bucaktepe Pakize Gamze OP-017, P-1383, P-1384
Buchanan Jo WS-057
Budiu Ioana OP-045
Bueno Garcia Virginia P-0349
Bueno Ortiz Jose Miguel P-1247, P-1252
Bueno Ortiz José Miguel OP-001, WS-002, P-0323
Buffels Johan WS-078
Buğdaycı Senem BR-072, P-0957
Buijs Peter WS-050, SYM-022
Buitrago Ramirez Francisco P-0349, P-0353
Bujedo Ortiz Claudia P-0311, P-1304, P-1349
Bülbül İskender P-0055, P-0257, P-0258, P-1154
Bülbüloğlu Ertan P-0711
Bulc Mateja WS-005, WS-022, WS-023, WS-032
Bulğurcu Suphi P-1378
Bulut Rahşan OP-238, P-0193, P-0543, P-0756
Bulut Selin P-1106
Bulut Ülkü OP-145, OP-236, WS-007, WS-037, WS-116, P-0531, P-0789, P-0799, P-0819, P-0924, P-1288
Bulut Yasin P-0365, P-0439
Bulut Çelik Sercan OP-017
Buntinx Frank OP-217
Buono Nicola OP-088, WS-079, SYM-010, SYM-023
Burazeri Genc P-1203
Burden Anna OP-241
Burkes Matt WS-076
Burokiene Neringa P-0604, P-0605, P-1344
Busschers Wim B OP-092
Busser Guus WS-013
Bussotti Alessandro P-1212
Bustamante Encarnacion P-0031
Busygina Olga S P-1110
Buszewicz Marta P-0935
Butiop Herlina P-1162
Büyükçek Özlem P-1050
Büyükşekerci Murat P-0183, P-0184, P-0189, P-0190, P-0192
Caballero Martinez Jose Eduardo P-1247, P-1252
Cabello Chanfreut Adriana OP-228, P-1080
Cabello Iguar Pilar P-0040, P-0044
Cabrera Vélez Roberto P-0040
Çabuk Caner OP-101
Çadircı Dursun OP-250, Course-010, WS-103, P-0182, P-0424

Cadogan Sharon L P-1163
Cadogan Sharon Louise OP-234, OP-248
Caetano Francisca P-0320
Caetano Pedro BR-063, P-0893, P-1263, P-1286, P-1287
Caetano Pedro Pinho P-0585, P-0586
Çağaç Özgür OP-042
Çağaydın Melike WS-037, P-1245
Çağrı Çukadaroğlu P-0696
Cahill Mary Rose OP-234, OP-248, P-1163
Caires Odara Ribeiro Miranda OP-176
Çakır Lütfullah P-0210, OP-067, P-1105, P-1191
Çakır Nahide Gökçe P-0236
Çakır Özlem P-0161
Çakırlar Hasan Ayberk P-0050, P-0584
Çakmur Hülya P-0498
Çalışkan Ahmet P-1158
Çalışkan Bahar P-0299
Çalışkan Belma P-0956
Çalışkan Şule P-1132
Çalışkan Özçelik Dilek P-0961
Calleja Cartón Luis Antonio P-0280, P-0294, P-0297, P-0300
Callis Privat Maria P-1218
Calvet Mireia Valle P-0803
Calvo Sardón Sandra P-0311
Çam F. Sırrı OP-139
Çamoğlu Tuğçe P-0536
Campa Francisco P-0897
Campamà Tutusaus Imma P-0539
Campos Antonio Carpintero P-0009, P-0791
Campos Isidoro Rivera P-0001
Campos Joan P-0650
Can Atilla P-0171
Can Hüseyin OP-017, OP-177, P-0385, P-0457, P-0729, P-0789, P-1112
Can Kübra OP-240, P-1135
Can Çelik Yeşim P-0964
Can Turhan Zeynep OP-124
Cañada Cámara Esther P-0342
Canak Maja P-1264
Cañas Davinia Blanco P-0009, P-0791
Canatar Taner P-0695
Canbal Metin OP-134, P-0075, OP-028
Canbaz Merve P-0460
Canbey Göret Ceren P-0212
Cancela Miguel P-0309, P-0389
Candar Ali OP-071, OP-073, OP-081, P-0369, P-0428, P-0429, P-0430, P-0440, P-0550
Canet Carlota P-0101, P-0611, P-1270, P-1306
Canet Lina P-0896
Cankurtaran Yılmaz P-1106
Cannon Rebecca P-0645
Cano Izza Dantas P-0598
Cano Gonzalez Ana Isabel OP-198
Cantin Amparo P-0101, P-0611, P-1270, P-1306
Cantista Pedro P-0585, P-0586
Canton Cuadrado Nerea P-0274, P-0279
Cantürk Irem P-1042, P-1120
Canyılmaz Emine P-0236

Capitão Maria Inês P-0511
Caracioli Andrea P-0549
Caramelo Rui P-0329
Cararach Salami Daniel P-0838
Carbajosa Rodríguez Virginia P-0311, P-0739
Cardoso Ana Paula OP-103, P-0124, P-0127, P-0286, P-0614
Cardoso Vítor Portela OP-231, P-0400, P-0787, P-1086
Cardoso Ferreira Pedro P-0402, P-0640
Carelli Francesco WS-055, WS-054
Cariello Thadeu Felix P-0017
Carmen María Jiménez Herrera P-1375
Carmienke Solveig P-0945
Carmona María Ortega P-0886
Carneiro Joana P-0669, P-1122
Carneiro Joana Pinto P-0638
Carpinisan Adriana P-1056
Carrazoni Carmen P-0782
Carreiras Virgínia P-0127
Carrera Manoella Garcia P-0913
Carreras Carla P-0650
Carrier Hélène OP-022, OP-169
Carrillo Alfredo Pérez P-0003, P-0030, P-0033, P-0083
Carroll Breda OP-197
Carroll Robert OP-023
Carrozzo Maria Alessandra P-0098
Carta Ana P-0831
Carta Anna SYM-017
Carter Victoria OP-241
Carvalho Ana Catarina P-0535
Carvalho Diogo P-1308
Carvalho Fernando P-0391
Carvalho Isabela P-0113
Carvalho José P-0641, P-0697
Carvalho José Lucas P-0902
Carvalho Liliana P-0631
Carvalho Rute P-0412
Carvalho Vanessa WS-114, P-0619, P-1173
Carvallo Maria Dolors P-0650
Casabella Juan Emilio P-0384
Casado Bech Ángel P-0099
Casado De Andrés Sandra P-0311, P-1304, P-1349
Casano Carnicer María Cecilia P-0621
Casanova Ludovic OP-022, OP-107, OP-169
Casanovas Cuquet Esther P-0221, P-1365
Casas Clara P-0091, P-0635
Casas Isabel Zamora P-0240
Casas Roser P-0782
Casaseca Calvo Teresa Fátima P-0044
Casco Silvia Sánchez P-0328
Cascudo Natalia Carasek Matos OP-005, OP-131, OP-252, P-0757, P-1178, P-1180
Caselli Rodrigo Belem P-0841
Caselli Rodrigo Belém P-0840
Casey Sheila P-0421
Cassasas Meritxell P-1240
Cassimos Dimitris P-0418
Casson Ian BR-002, P-0587

Castan Silvia P-0159
Castaneda, Md Melissa P-0783
Castanheira Joana P-1300
Castaño Carmen OP-222
Castel M Victoria OP-050
Castillo Ramos Eva OP-146
Castro Elisabete OP-190
Castro Iballa OP-037
Castro Pedro P-0639
Castro Pedro Moreira P-0510, P-0627, P-0719
Çatak Binali OP-059, P-0450, P-0451, P-0721, P-0722
Catarino Susana P-0668
Cavusoglu Coskun P-1078
Çayır Yasemin P-0981, P-1341
Çayırılı Yusuf Burak P-0769
Cebeci Asiye Betül P-0708
Cebeci Saide Eda OP-007, OP-067, OP-194, P-0355, P-1191
Cebeci Sevsen OP-028, OP-134, P-0075
Çeçen Refik Emre P-0234
Cekic Ahmet P-1106
Celada Roldán Carmen P-0342
Celebi Evrim P-0817
Çelenlioğlu Alp Eren P-0376
Çelepkolu Tahsin OP-004, OP-017, P-0151, P-0152, P-0825, P-1384
Çelik Feyza OP-115, P-0490, P-0501, P-1075
Çelik Mustafa P-0354, P-0416, P-0492, P-0711, P-0954, P-1170, P-1171, P-1189, P-1356, P-1395, P-1397
Çelik Nazlı P-1275
Çelik Sercan Bulut OP-239
Çelik Ümit P-0404
Çelik Banu P-0215
Çelikkalkan Nil P-0431
Çelikkaya Demet OP-145
Cengiz Türkan P-1255
Cengiz Balyen Yeşim OP-004, P-0151, P-0152, P-0825
Centeno Cabrera Mirna Lizzeth P-0976
Cepas Fernando Leiva P-0553
Ceren Avcı Kübra P-0696
Cerni Obrdalj Edita P-0057, P-1088
Cerqueira João Julio P-0638
Cerqueira Mafalda P-0177
Cerrah Gokcen P-1123
Cerutti Bernard P-0633, P-0906
Cervero Mercedes P-0101
Cervilla Suarez Francisco Jose P-0269, P-0270, P-0271, P-0272, P-0274, P-0275, P-0277, P-0278, P-0279, P-0298, P-0301
Cesur Özkan P-0005, P-0761
Cesur Yağız Fulya OP-134
Çetin Adil P-1134
Çetin Tuğba P-1242
Çetin Ayhan Sema P-0371, P-1021
Çetin Benli Neriman P-0005, P-0761, P-0858
Çetin Kargın Nisa P-0708, P-0859, P-0860
Çetinel Yasemin P-0578, P-1152, P-1373
Çetinkalp Şevki P-0010, P-1248
Cevizci Sibel OP-082, P-0990, P-0999
Ceyhan Mustafa Nuri OP-053, P-0538

Ceyhun Peker Ayşe Gülşen OP-011, P-0251, P-0357, P-0482, P-1175
Ceyhun Peker Gulsen SYM-010, OP-096, OP-129, P-0462, P-0749
Ceylan Esra P-0358
Chacori M. Mar Forés P-0240
Chaleckaja Ana P-1028
Chalkidou Maria P-1284, P-1285
Challal Basma P-0657
Chan On Ying A. OP-049
Chang Adrienne P-1156
Chanos Anestis P-0866
Chao Li Lin P-0208
Charrão F. P-0116
Charrão Fernando P-1347
Chatziioannidou Chariklia P-0195
Chaufan Claudia WS-044
Cheade Maria De Fátima Meinberg OP-158
Chen Ming Chen P-0037
Chen Ying OP-201
Chetty Ula Course-008
Chi Cheng Lin P-0208
Chih Kang Tung P-0208
Ching Siew Mooi OP-259
Chinopoulou Nectaria P-0418
Cho Hee Jeong P-0998
Cho Hong Jun P-0065
Choi Eunjeong P-1267
Choi Jae Kyoung P-0573
Choi Ji Ho OP-210
Choi Js P-0548
Choi Na Eun P-1004
Choi Whan Seok P-1004, P-1005
Chourdaki Aikaterini P-0968
Chowdhury Shaheen OP-021
Christofilidis Georgios P-1068
Christoforidis Athanasios P-0418
Chrystyn Henry OP-241
Chuang Hung Yi P-1008, P-1008
Churproong Seekaow P-0042
Çiçek Gizem P-0401
Çifçi Sema OP-274, P-0962
Çifçili Saliha Serap WS-120, PNL-009, P-0209
Çifçili Serap OP-065, Course-004, SYM-007, SYM-011, P-0957
Çiflik Bolluk Aslıhan P-0252
Çiftçi Fatih OP-071, OP-073, P-0369, P-0429, P-0430, P-0440, P-0550
Çiftçili Saliha Serap P-0505
Cigdem Kevser Ates OP-112
Cigerli Ozlem P-0692, P-0695
Cihanbeylerden Melek P-0758
Cikac Tatjana P-0133
Çil Timuçin P-1089
Cim Abdullah P-1012
Çimen Funda P-1309
Çınar Abdurrahman P-0038, P-0513
Cingi Cemal OP-261
Çinkit Berfu P-0231
Cique Herráinz Juan A. P-0040

Ciria De Pablo Cristina P-0040, P-0044
Cirillo Pietro OP-204
Cirit Elif P-1039, P-1360
Çitil Medine P-0964
Clark Emily BR-050, P-0465
Clave Pere SYM-024
Clavería Ana P-0759
Clemente Jiménez Lourdes OP-221
Clements Deborah Smith OP-154
Climaco Maria Isabel OP-165, P-0850
Çoban Gonca P-0689
Coiduras Charles Alicia P-0034
Coindard Guillaume OP-116
Cojic Milena SYM-029
Çolak Muhteber P-0197, P-1370
Coles Jan WS-036
Collar Pastor Pilar P-0025, P-0026
Collard Pascal P-0454
Collier Dorcas OP-215
Collins Claire OP-215, SYM-023
Collins Clarie SYM-010
Çöllüoğlu İnce Tuğçe P-1244
Colucci Enza OP-204, P-0489
Colucci Giovanni OP-204, P-0489
Colucci Vitantonio OP-204, P-0489
Colungo Cristina P-0141
Çomak Yasemin P-0461, P-0699
Coman Alexandru Claudiu P-0342, P-1063, P-1084, P-1298, P-1299, P-1302, P-1318
Comas Arnau Gemma P-0221
Çömçe Muhammet P-0584
Cömert Serdar OP-069
Cömert Okutucu Ayşegül OP-129
Comet Dolors P-0865
Comnea Laura T OP-061
Comnea(herdea) Laura T P-0397
Conceição Karoline Barros P-1295
Conde Ananda Dos Santos P-0600, P-1041
Conde Sara WS-034
Conde Valvis Fraga Elena P-0805
Consortium Phameu SYM-025
Consortium Qualicopc SYM-025
Contreras Mar P-0832
Cop Renata P-0133
Cording Susanne WS-010
Cordoba Gloria P-1037
Cordobés Millán María P-0599, P-1034
Cordon Simon P-0821
Coretti Silvia OP-157
Coronha Ana Matos P-0124
Correia Ana Margarida P-1400
Correia Adélia Delfina Da Motta Silva P-0878
Correia Janine P-0214
Correia Nádia P-1014
Correia Nádia Fernandes OP-155
Correia Raquel P-0585
Correia Rui P-0641, P-0697

Correia De Sousa Jaime Course-010
Cortaredona Sebastien OP-169
Cortes Salazar Carmen Maria P-0082, P-0104, P-0106, P-0107, P-0111, P-1294, P-1301
Cortuk Mustafa P-0345, P-0683, P-0858
Cos Frances Xavier Course-003
Coşgun Süleyman P-0232
Coskun Seda P-1175
Coşkun Funda P-0168
Coşkun Seda Course-010, P-0462
Costa Ana Iva P-1400
Costa Angelo P-0088, P-0824
Costa Carla P-0320
Costa Daniela Pedrosa P-1185
Costa Luciana Rodrigues P-0387
Costa Luis De Pinho PNL-003
Costa Millena Gomes Pinheiro P-1382
Costa Sandrina P-0344
Costa Sara Neves P-0784, P-0785, P-1091
Costa Sergio P-0657
Costa Sónia Lima WS-074
Costa Atienza Engracia P-0595, P-0842, P-0843, P-1217, P-1265
Costiug Emiliana WS-027
Couceiro Rosa P-1283
Couto Ana Filipa P-0520
Couto Luciana P-0303, P-0921
Cramer Maarten J OP-208
Cramp Vinaixa Mireia P-1228
Crespo Blas Sílvia P-0599, P-1034
Cristina Navarro Robles P-1380
Crnogorcevic Pamukcic Mirsada P-1081
Croft Peter OP-201
Crofts Janice WS-076
Cruz Ana Margarida P-1310
Cruz Isa P-1074, P-1230, P-1315, P-1322
Cruz Isa Maria P-1227
Cruz Mario WS-015, P-1082
Cruz Steve Ines OP-202
Cubells Enrique Almenar P-0176, P-0334, P-1102
Çubukçu Mahcube P-0235, P-0801, P-1027, P-1033, P-1095, P-1096, P-1101
Cuenca Laura Ubeda OP-132
Cuevas Cruces José OP-228, P-1080
Çukurova İbrahim P-1378
Cullen Cathy WS-068
Cunha Ana Raquel P-0344
Cunha Igor Almeida P-0903
Cunha Patrícia P-1100
Cunha Patrícia Rodrigues P-1234
Cunha Sara P-0402
Cunha Sara Conceição P-0969
Cunha Sara Margarida P-0336
Cunniffe John OP-215
Cura Ecevit Püren P-0417, P-0419, P-0760
Curran Margaret OP-215
Currie Claire P-1220
Curry Natasha P-1220
Cus Breda P-0686

Cvejanov Kezunovic Ljiljana SYM-029
Cvetko Tatjana P-0220, P-0544
Cvijetinovic Milija P-1208
Czabanowska Katarzyna P-1203
D`angelo Maria Giovanna P-0601
Da Costa Stenio Wagner Sacramento OP-176
Da Cunha Alejos Vanessa P-1308
Da Silva Artur Alves OP-176
Da Silva Cátia Pereira P-0319, P-1280, P-1283
Da Silva José Everton Fagundes OP-176
Da Silva Nathia Maria Lorena OP-176
Dağcioğlu Basri Furkan P-0143, P-0203, P-0346, P-0481, P-0742, P-1179, P-1184
Dağcioğlu Furkan P-0160, P-1108, P-1181
Dağdeviren Tanyel Sema P-0525
Dagli Zeynep OP-225
Dağlı Zehra OP-011, OP-129, WS-038, WS-070, P-0357, P-0482, P-0646, P-0774, P-1175
Dahlhaus Anne P-0613
Dahlström Tobias P-0100
Đaković Marinela P-0984
Daldal Zeynep Bayraktutar P-0646
Dalgakıran İlayda P-1072
Dalkilic Serdar P-0644
Dallas Anthea P-0875
Damar Abdulkerim OP-177
Damas Pérez Idaira P-0559
Damasceno Vinicius Bernardes Mendonça OP-005, OP-131, OP-252, P-0757, P-0772, P-1178, P-1180
Damjanac Natasa P-0993
Danalioglu Ahmet P-0656
Dane Kocasaraç Rabia P-0235, P-0801
Dannesbo Mads WS-069, P-0888, P-0889
Dantsi Fotini P-1025, P-1296
Danyliuk Svetlana P-0230
Daou Remi OP-268
Daponte Angueira Sandra P-1029
Dardavesis Theodoros P-1025
Darmawan Irene P-1239
Dasman Hardisman OP-030, BR-028, P-0844
Davies Alisha P-1220
Davies Nathan P-0777
Davies Sara P-0084, P-0650
Davy Jean Marc P-0527
De Almeida Bruno António Covelo OP-230, P-0625
De Angulo Andrea P-1142
De Barros Michel Neri OP-176
De Bont Antoinette OP-157, OP-186, P-1219, P-1222
De Burghgraeve Tine OP-217
De Carvalho Wander Alysson Santos P-0383, P-0388
De Castro Peral Lázaro OP-132, OP-263, P-0714, P-0895
De Franceschi Camille P-0327
De Gier Han P-1219, P-1222
De Haseth Dinky P-0945
de Jong Marieke H. WS-073
De La Cal De La Fuente Aventina P-1304, P-1349
De La Cruz Herrera Mercedes P-0794
De La Poza Mariam P-0091, P-0635
De La Torre Carpente M^a Del Mar P-0739, P-0812

De La Torre Carpenete Mar P-0518, P-0818
De La Torre Lima Javier P-0592
De Labaig Ramos Patricia P-0167
De Leeuw Elke P-0069
De Looze Fred P-0255
De Maeseneer Jan WS-039
De Miranda Diana Vaz P-1280, P-1283
De Moraes Láyla Moanna Araujo OP-176
De Moura Luana Jonata Nunes OP-174
De Oliveira Elise Botteselle OP-174
De Oliveira Olga Messias Alves P-0836, P-0839, P-0841
De Pablo Epifania Rodrigo P-1047
De Paula Ieda WS-114, P-0049, P-0565, P-0619
De Pinho Costa Luis OP-143
De Pinho Costa Luís OP-190, WS-107, P-1314
de Silva Debra P-1210
De Sousa Jaime Correia Course-001, SYM-001
De Sousa Nerea P-1000
De Souza Camila Garcia OP-005, OP-131, OP-252, P-0757, P-0772, P-1178, P-1180
De Souza Felipe Augusto Morais OP-176
De Unamuno Lumbreras Lorea P-0380, P-0727, P-1291
De Villasante Nuria P-0199, P-0200
De Wit Nicolaas J WS-084
De Wit Niek OP-040, OP-047, OP-100, OP-185, OP-186, OP-216, WS-008, P-0077, P-1006, P-1007, P-1026, P-1219, P-1222
Deckx Laura OP-217
Dede Fatih P-0021
Deeg Dorly OP-266
Defranceschi Camille BR-009
Dekker Janny H. OP-206
Dekker Nicole WS-104
Deksnyte Aušra P-0488, P-0827
Del Campo José María OP-083, OP-085
Del Cerro Álvarez Noemi WS-002
Del Val Jose Luis P-0105
Deleanu Anca WS-024, WS-026, PNL-001, SYM-013, P-0936
Delgado Ana Palhares OP-155, P-1014
Delgado Concepción Martínez P-0003, P-0030, P-0033, P-0083
Delgado Pilar P-1032
Delgado Diestre Carmen P-0539
Della Vedova Roberto OP-093
Demarzo Marcelo WS-052
Demeaux Jean Louis OP-106, OP-125, P-0139
Demir Cemil P-1187
Demir Esra P-0185, P-1184
Demir Faruk P-0362
Demir İlknur OP-079
Demir Kamil P-0441
Demir Kübra Nur P-0209, P-0338, P-0545
Demir Nevgül P-0525, P-0643, P-0743
Demir Osman P-0427, P-0536
Demir Sinan OP-014
Demir Ulku Elif OP-014
Demir Vasfiye OP-004, P-0151, P-0152, P-0173, P-0363, P-0825, P-1383, P-1384
Demir Akça Ayşe Semra OP-238, P-0193, P-0225, P-0226, P-0238, P-0339, P-0543, P-0756, P-1251
Demir Alsancak Aybüke OP-062, P-0316, P-0350, P-0407, P-1097

Demir Yazıcı Şenay P-0345, P-0682, P-0858, P-1160
Demirag Nilgun Guvener P-0692
Demirağ Mehmet Derya P-0012, P-0977
Demiraran Yavuz P-0467
Demiray Damla P-0229
Demirbaş Beyza OP-071, P-0368, P-0428, P-0429, P-0550
Demirbaş Burcu P-1275
Demirbaş Zafer Erdin P-0616
Demirbilek Hüseyin P-0071, P-0073
Demircan Nejat OP-238, P-0193, P-0339, P-0479, P-0543, P-0756
Demirci Aylin OP-074
Demirci Hakan OP-071, OP-073, OP-081, P-0222, P-0368, P-0369, P-0422, P-0428, P-0429, P-0430, P-0440, P-0550, P-0971
Demirci Seden P-0178
Demirdamar Tolunay OP-031, OP-194
Demirel Başak P-0815
Demirel Levent Oğuzhan Demire P-0142
Demirel Yasemin Ceren OP-177
Demirel Yeltekin P-0683
Demireloğlu Ebubekir P-0758
Demirhan Beytullah İsmet P-1085
Demirin Hilmi P-1126
Demirkiran Gokhan OP-265
Demirkiran Dua Sümeyra OP-265
Demiröz Halime Pınar P-0406, P-0616
Demirpolat Eyyup P-0157
Demirtas Unal P-0853
Demirtaş Hatice Füsün OP-239
Demirtunç Refik P-0155, P-0670
Den Elzen Wendy P.j. OP-049
Deneys Lidwuina P-0657
Denis François OP-116
Deniz Ferhat P-1345, P-1351
Deniz Safak Elif P-0989
Denizeri Sabiha Banu P-0185
Deusdará Rodolfo P-0017
Diamanti Maria P-0782
Dias Ana Bastos P-0770
Dias Ana Filipa P-0214
Dias Hugo P-0617
Dias João P-0629
Dias Mara Matos P-0194, P-0415, P-0530
Dias Tânia P-1014
Dias Tânia Martins OP-155
Díaz Alicia María P-1240
Díaz Carlos Piñeiro P-0001
Díaz Eduardo P-0759
Díaz Jose Luis OP-010, P-0330, P-0341
Diaz Gago Maria Jose P-0370
Díaz Gete Laura OP-221, OP-222, P-1046
Díaz Salcedo Esther P-0264, P-1224
Dieleman Marjolein OP-223
Diez Alvaro P-0733
Díez Pérez María Cruz P-0040
Dijk Anneke Van OP-038
Dikici Mustafa Fevzi P-0433, P-0474, P-0588, P-0602, P-1045, P-1107, P-1138, P-1139, P-1140, P-1392

Dikililer Mehmet Aytug P-0131, P-0295
Dikmen İsmail P-0461, P-0699
Dilber Salih P-0710
Dilek Işcan Gökçe P-0710
Dilşad Save P-0696
Dimambro Floriana P-0489
Dimitriadou Cornilia P-1279
Dimoliatis Ioannis P-0938
Dinc Demet WS-077
Dinç Mustafa P-0750
Dinçer Gökhan OP-062, P-0316, P-0350, P-0407, P-1094, P-1097, P-1134
Dinçkal Mustafa Hakan OP-016, P-0050, P-0584
Dindar Fatma OP-075, P-0545
Dinnall Annette OP-035, P-0165
Dişçigil Güzel OP-285, BR-021, PNL-009, SYM-011, P-0533, P-0705
Dislian Valentine P-0029
Dixon Kate P-0947
Dizdar Mustafa Gökhan P-1112
Dizen Namdar Nazlı P-1389
Djuhaeni Henni OP-170
Do Nascimento Davi Rios OP-176
Do Vale Adson Gileade Cavalcante OP-176
Do Vale Marcela Amorim OP-176
Dobbs Bonnie OP-025, WS-094
Docón Amparo Hervás P-0886, P-1151
Doğan Buket Eylem OP-033
Doğan Burcu OP-013, P-0023, P-0024, P-0043
Doğan Doğukan P-0871
Doğan Fatma Gönül OP-016, OP-283, P-0584, P-0773
Doğan Meryem P-0212
Doğan Nuray P-1362
Doğan Nurhan P-0725
Doğan Selami OP-067, P-0457, P-1362
Doganer Yusuf Cetin OP-012, P-0016, P-0080, P-0394, P-0723
Doğruel Doğukan OP-115, P-0490, P-0501, P-1075
Doğrusöz Yeşim P-0151, P-0152
Dolader Olive Sonia P-0509
Domingo Jaime P-0537
Domingo Jose Vicente Alcaide P-1102
Domingo M^a Mar P-0048, P-1032
Domingo Mar P-0105
Dominguez Jimenez Diana BR-035, BR-061, P-0027, P-0082, P-0104, P-0106, P-0107, P-0111, P-0243, P-0504, P-0960, P-1294, P-1301
Dominguez Piriz Laura P-0353
Dominicé Dao Melissa WS-003, WS-071, P-0906
Doner Pinar WS-014
Döner Pınar OP-265
Donker Gé A OP-232
Donnell Patrick O WS-067, WS-068
Doohan Noemi WS-105
Dornan Ceri WS-059, WS-060
Dorville Yrbani Lantigua P-1342
Dos Santos Carlos Filipe Martins P-0140
Dost Emrah P-1355
Dostalova Katarina P-0491, P-0496
Doukareli Chrysanthi P-0195

Dowling Stephanie OP-270
Dowrick Christopher SYM-016
Draijer Willem WS-011
Draskovic Tamara P-0332, P-0661
Drenthen Ton WS-020, WS-022
Drontsos Anastasios P-1025
Drosos Alexandros P-1064
Drosos Evangelos P-1025
Drwiła Dominika OP-084
Drymiotou Stephanie WS-063
Duarte Ana P-0759
Duarte Diana Sofia P-0114, P-0115, P-0622
Duarte Jenny P-0132, P-1319, P-1320, P-1323
Duarte Júlia Maria De Oliveira P-0839, P-0840
Dubas Katarzyna WS-057
Duerden Martin P-0343
Duhamel Sylvie OP-125
Duhot Didier OP-116
Dukic Dijana P-0564, P-1206
Dülek Hatice P-0434
Dülger Hatice Rümeyza P-1166
Dumitra Gheorghe Gindrovel A WS-024, SYM-013
Dumitra Gindrovel WS-026, PNL-001, P-0936
Dündar Ahmet Said P-0215
Dündar Eyüb P-0431
Dupie Isabelle WS-096, WS-099
Duque Chaux André P-0311, P-1304, P-1349
Duran Nizami P-1309
Duran Ramazan P-0708
Durán Tejada María Rosario P-0044
Durbin Janet P-0587
Durdu Tuğba P-1031, P-1211
Durmus Ayse Birsen P-0817
Durmuş Esra P-0468, P-1038, P-1201
Duro Robles Rosa P-0626
Dursun Hüseyin P-1244, P-1288
Dursun Kübra P-1383
Durup Ferhat P-0036
Duyan Gülsüm OP-028
Duyan Çamurdan Aysu OP-062
Dvareckyte Daiva P-0751, P-0752, P-0753, P-0754
Ebiloğlu Aslı P-0122, P-0135, P-0741
Ece Çavuş P-0769
Ecirli Samil OP-124, P-0161, P-0163, P-0171, P-0198
Eder Jožica P-0607
Efeoglu Efe P-0861
Efstratiadis Froso P-1068
Efthimiadou Elpida P-1296
Egan Aisling OP-109
Eich Krohm Astrid P-1128
Eijk Jacques Van OP-038
Ekayanti Fika OP-113, OP-245, P-0658
Eker Salih OP-013
Ekici Serpil P-1193, P-1199
Ekim Meral P-0211
Ekim Yardım İlke P-1144

Ekim Yardım Sabire Ilke OP-066
Ekimci Deniz Funda OP-238, P-0193, P-0339, P-0756
Ekin Murat P-0469
Ekinci Ferhat OP-042, OP-064, OP-130, OP-271
Ekinci Tuba P-0443
Ekinozu İsmail P-1136
El Gemayel Maria P-0162, P-0941
El Ghardallou Meriam P-1289
El Helou Abdo P-1343
El Osta Badi P-0162, P-0576, P-0747
El Osta Lana P-0162, P-0487, P-0576, P-0747, P-0874, P-0941, P-1343
El Osta Nada P-0162, P-0487, P-0576, P-0874, P-0941, P-1343
El Sharif Omneya WS-033
Elbarbary Walaa Mohamed OP-105
Elbi Hüseyin OP-139, Course-010
Elbüken Gülşah P-0012, P-0977
Elevli Murat P-0299
Elias Fernando Javier OP-032, OP-087
Elliot Robbert OP-157
Elmacioğlu Funda P-1385
Elnaeim Salwa Elsanousi Hussein OP-149
Emile Stacy P-0549
Eminsoy Gökhan OP-043, OP-120, P-0355, P-1152, P-1369
Eminsoy M. Gökhan P-0578
Encarnación Max Alexander P-0174, P-0664
Enginyurt Ozgur P-0210, P-1105
Enters Weijnen Catherine Friderieke WS-084
Envia Gonçalo P-0617
Er Mükremin P-1108
Eraslan Ayşe Melike P-0939
Erayman Demirbaş Sule OP-128, P-0198, P-0161, P-0163, P-0171, P-0191, P-0815
Erbas Gamze Bal P-0691
Ercan Önder P-0470, P-0767
Erdal Akın P-1331
Erdal Rengin P-1155
Erdal Verda P-1160
Erdem Gizem P-0461, P-0699
Erdem Murat P-0122, P-0135, P-0741
Erdem Ozgur OP-112
Erdem Özgür OP-017
Erdogan Merve P-0744
Erdoğan Ahmet Ferit P-1111
Erdoğan Ayşegül P-0711
Erdoğan Cenik Elif P-0235, P-0801
Erdoğan Gizem P-1157
Erdoğan Sema P-0004, P-1123, P-1354
Erdoğan Mergen Berna P-0463, P-0798
Eren Ayşe P-0215
Eren Gül P-0075
Eren Şükrü Ümit P-0710, P-0978, P-1094, P-1198
Ergen Nilay P-0692
Ergenc Hasan P-0043
Ergönen Akça Toprak OP-052, WS-037
Ergüder Toker PNL-002
Ergül Emine Esra P-1332
Ergüven Müferet P-0414, P-0426

Erickson Jacob P-0080
Erik Duman Leyla OP-004
Erinc Sinem OP-157
Erken İlyas OP-089, OP-253, P-0712, P-0713, P-1245
Erkuran Neslihan OP-280, P-0472, P-0764
Erođlu Mücahit OP-075
Erol Sultan P-1233
Eroles Mallolas Laura P-0621
Eroz Recep P-1126
Errami Hassna P-1297
Ersen Gamze P-0478
Ersoy Emrah P-1150
Ersoy Özgür P-0416, P-0954, P-1170, P-1356, P-1396
Ersoy Ozlem P-0467
Ersü Abdurrahman P-0463
Ertaş Dilber P-0222
Ertaş Rasim Volkan P-1125
Ertekin Hülya P-0442
Ertekin Yusuf Haydar OP-034, OP-082, OP-225, P-0028, P-0442, P-0990, P-0999, P-1035
Erten Bucaktepe P Gamze OP-004, P-0151, P-0152, P-0173, P-0825
Ertugrul De Graaf Inge P-0077
Erturhan Selman P-0534, P-0682, P-0683
Ertürk Ayşe P-1193
Esaily Heba Gamal OP-036
Escobar Francisco OP-083, OP-085, P-0884, P-0897
Escobar Rabadán Francisco OP-224
Escrache Xavier Flor OP-144, P-1151
Escrivá Ferrairó Rosa Ana P-0044
Escurriola Mireia Fábregas OP-221
Esen Ayşe Didem P-1115, P-1172
Esen Elif Serap P-0512
Esen Erdinç P-0367
Esen Melike P-1184
Esen Arslan Merve P-0237, P-0670
Eser Büşra P-1272
Eser Utku P-0871, P-0872, CON-007
Eslami Saeid P-1221
Esparza Perez Encarnacion P-1302, P-1318
Espinosa Ana Belen P-0868
Espinosa Collado Antonia P-1326
Espinosa Nieto Yolanda P-0264
Esteban Redondo Emiliano P-1299, P-1318
Esteves Vitor P-0216
Estríbio Vanda P-0514
Ettinghausen James Diego OP-032
Evaltaite Budvytiene Inga P-0716
Evangelou Angelos P-1069, P-1073
Evliyaođlu Taşkesen Arzu OP-017
Evsen Mehmet Siddik P-1383
Eyi Yusuf Emrah P-0032, P-0372, P-0373, P-0780
Fabijanskiene Audrone P-1098
Fabrellas Núria P-0034
Fadhilah Marita OP-113, OP-245
Fahmi Idqan OP-054, P-0917
Fakirullahođlu Pınar P-0406
Falcão Amanda Passini Fraga P-0890

Falcoff Hector WS-096
Farahat Taghreed Mohamed P-0035
Fargas Moreno Francisco Josep OP-077
Farghadani Hirsá PNL-004
Faria Bruno De Souza P-0598, P-0806
Faria Filipa P-1010
Faria Sofia Maria P-1260
Farrés Creus Rosa P-0794
Farrington Rebecca WS-013, WS-014
Fathurrohman Irvan OP-245
Fe Pascual Antonia P-0626
Feder Gene Course-011, WS-032
Feirreia Ana Rita P-0526, P-1328
Felici Claudia P-0920
Feraz Luísa P-0730
Ferizovic Neda P-0041, P-0577, P-1023
Ferjan Barbara P-0109
Fernandes Andreia P-0130
Fernandes Andreia Filipa Lopes P-0093, P-0140, P-1253
Fernandes Catarina P-0637, P-1327
Fernandez Guadalupe P-0635
Fernandez Maria Del Carmen P-0054, P-0812, P-1161
Fernandez Marielle Fernndez P-0240
Fernández Carmen Course-011, P-0311
Fernández Javier Aracil P-0003, P-0030, P-0033, P-0083
Fernández Joaquim P-0048, P-1032
Fernandez Alonso M Carmen P-0818, P-0821
Fernández Alonso Carmen WS-032, WS-033, P-0518, P-0739
Fernández Alonso María Carmen P-1304, P-1349
Fernandez Calsalderrey Carmen P-0896
Fernandez Galanche Carlos P-0976
Fernández Garcia Jose Carlos P-0104, P-0106, P-0107, P-0111, P-1294, P-1301
Fernández García José Ángel OP-228, P-1080
Fernández García Maria WS-002
Fernandez Gonzalez Jose Maria P-0089, P-0206, P-0276, P-0679, P-1213, P-1238
Fernandez Gonzalez Jose Maria P-0680, P-0681, P-1261, P-1278, P-1364, P-1366
Fernández González José María P-0253, P-0254
Fernández Guillén María Del Socorro P-0342
Fernandez Lorencio Jesus P-1247
Fernández Lorencio Jesús P-0323, P-1252
Fernandez Revuelta Araceli P-0186
Fernández Zambrano María P-0592, P-0606
Ferrando Purificación Jordana P-0244
Ferrante Donatella OP-093
Ferraz Luísa P-1054, P-1057
Ferreira Ana Lopes P-1321
Ferreira Diana Almeida P-0224, P-0302, P-0313
Ferreira Helena P-0615
Ferreira Ines Dias WS-015, P-1082
Ferreira Kássio Costa OP-158
Ferreira Leonardo Dos Santos P-0836
Ferreira Marta P-0130
Ferreira Miguel Marques P-0114, P-0115, P-0622
Ferreira Paula P-0130
Ferreira Pedro Cardoso P-0824
Ferreira Regina P-0017

Ferreira Sara Daniela P-1260
Ferrer May Helena P-0265, P-0899
Ferreras José María OP-085
Ferro Melanie P-0216
Feyizoglu Güneş P-0023
Fhärm Eva P-0987
Fianco Bruno P-0910
Fidan Cihan OP-226
Fidancı Aslihan P-0458
Fidancı İzzet P-0458, P-0710, P-0978, P-1094, P-1198
Fierro María José OP-010, P-0330, P-0341
Figueiredo Ana Beatriz P-0129, P-0310, P-0398
Fijacko Blazenka P-0133
Fileli Efcharis P-1284
Filipe António P-0641, P-0697
Finegan Pearse OP-215
Firat Ugur P-1117
Fisekci Oktar Sevil P-0198
Flegg Karen WS-088
Flik Carla E P-1006, P-1007
Flor Xavier P-0084, P-0141
Flores Favio P-0384
Flores Pedro Alejandro P-0328
Flores Copete María OP-224
Flores Torrecillas Juana P-1063, P-1084, P-1298, P-1299, P-1302, P-1318
Florou Chrysoula P-0671
Flynn Nicola OP-270
Fofana Fatoumata OP-116
Fondevila Jessica Sánchez OP-222
Fonseca Ana Paula P-1074, P-1227, P-1230, P-1315, P-1322
Fonseca Mariana P-0610, P-0731
Font Alonso M Jose P-0221
Forcada Jordi P-0202
Forcada Arcarons Anna P-0595, P-0842, P-0843, P-1217, P-1218, P-1265
Forés Rosa P-0048, P-1032
Forés Chacori María Del Mar P-0174
Foreva Gergana Hristeva P-0108, P-0110, P-0916
Fornell Laia Lamarca OP-144
Fortenberry Katherine P-0645
Foussas Stefanos P-1060
Fousteris Evangelos P-1060, P-1068, P-1069, P-1071, P-1073
Fowler Josephine Rebecca P-0476, P-1182
Fox Hannah WS-086, P-0781
Fragkoudi Foteini P-1040
Frahat Faisal OP-151
Franca Maria Eugênia Chaves OP-176
Franch Josep P-0199, P-0200
Franco Selma Cristina P-1214
Frank Martin P-1305
Frasto Zlata P-0577
Frasto Zlata Mustafa P-1023
Freemantle Nicholas OP-093
Freitas Marília Branco OP-176
Fremenville Humbert De OP-153
Frese Thomas OP-088, SYM-010
Frigola Eva P-0105

Friska Dewi OP-258
Frolova Elena WS-054, WS-055
Fuentes María Ángeles Castaño P-0079, P-0596, P-0597
Fuertes María Teresa P-0199, P-0200
Fukuda Robson Yutaka OP-156
Gabriel Joana P-1091
Gaghana Feicy P-1350
Gagnon Suzanne WS-014
Gago Bustamante Monserrat P-0241
Gago Bustamante Montserrat OP-198, P-0972, P-0976, P-0979
Gaidamovic Rima P-0827
Gajria Camille WS-086
Galić Brankica P-1352
Gallais Jean Luc OP-116
Gallardo Sánchez Cristina P-0264, P-1224
Gálvez M Isabel López P-1342
Gama Céline Raposo P-0336, P-1260, P-1269
Gameiro Margarida P-1300
Gameiro Mendes André P-1029
Gamero Samino Maria Jose P-0349, P-0353
Gandara Revuelta Maria Antonia OP-198, OP-199, P-0241, P-0370, P-0972, P-0976, P-0979
Gangoso Feroso Ana P-0074
Ganotopoulou Asimina P-1068
Garbayo Jesus P-0650
Garcés José Damián P-0563, P-0733
García Ana P-0650
García Ana Marta P-0698, P-0824
García Natalia Peralta OP-144
García Pilar OP-163
García Rosa Alcolea P-0150, P-0803
García Kristina P-0832
García M Dolores Moriano P-0240
García María Dolores Vazquez P-0003, P-0033, P-0083
García Sandra Roldan P-1348
García Tomás P-0537
García Bermejo Pedro P-1099
García De León Chocano Sebastián P-0025, P-0026, P-0566
García Delgado Esther WS-002
García Fernández David P-0621
García Fernández María Eugenia P-0040, P-0044
García Garcerán Jose Antonio WS-002
García Guerrero Maria Lucia P-1247, P-1252
García Gutierrez Maria Teresa OP-199, P-0979
García Jordan Maria Jesus P-0085, P-0857
García Lareo Manel P-1034
García Lopez Juan Maria P-0727
García López Juan Manuel P-0092, P-0288, P-0289, P-0380, P-1291
García Martín Elvira WS-109, P-0347, P-0960, P-1241
García Moreno Anna Maria P-1218
García Paine Juan Pablo P-0273, P-0275, P-0278, P-0280, P-0294, P-0297, P-0298, P-0300, P-0301
García Pineda Atanasio P-0626
García Ramos José Antonio P-0539
García Redondo María Rosa P-0044
García Romero Jeronimo P-0728
García Rupérez Inmaculada P-0739
García Sanchez Ines SYM-017, P-0831

García Villasur María Paloma P-0044
Garrett Gerard OP-197
Garrido Laguna María Cristina P-0592, P-0606
Gato Nuñez Crisitna P-0353
Gato Nuñez Cristina P-0349
Gavana Magda P-0942
Gavin Sinead OP-197
Gavran Larisa P-0015, P-0051, P-0057, P-0555, P-0557, P-0986, P-1088
Gay Belen P-0159, P-0611
Gay Bernard OP-106, OP-167, P-0139, P-0515
Gayef Albena P-0137
Gayo Mariana P-0129, P-0310, P-0398
Gazdik Peter P-0591
Geahchan Negib P-0487
Geçkil Ali Ümit OP-043, P-0425, P-1152, P-1155
Geerlings Suzanne OP-026
Gelmez Tas Beray P-0495
Gemmill Meg P-0587
Gencer Mehmet Ziya P-0201, P-0420, P-0436, P-0441, P-0447, P-0996, P-1258
Gencer Vedat P-0163
Gentile Nelson P-0158, P-0331
George Carolin Elizabeth OP-021
Georgilas Anastasios Theodosios P-1060
Gereklioğlu Çiğdem P-0072, P-0148, P-0154, P-0404, P-0523, P-0689, P-0720, P-0930, P-1050, P-1089, P-1090, P-1111, P-1131, P-1132, P-1157, P-1197, P-1329
Gerez Rosa P-0031
Gerhards Leo J OP-098
Geroğlu Berk OP-152, WS-115, P-0862, P-0908, P-0939, P-0959, P-1378
Geylani Güleç Seda P-0455
Ghandour Fabre Fátima OP-263
Ghionaru Raluca WS-027
Ghiris Mihai OP-227
Giannakopoulos Stathis P-0942
Gianniki Maria P-1064
Giannopoulou Evangelia P-0968
Gianouza Eyfrosyni P-1285
Giesbrecht Patrícia Caldeira Penna P-0885
Gikas Aristofanis P-0195
Gil Ángel OP-010, P-0330, P-0341
Gil Diana Diaz P-0176, P-0334, P-1102
Gil Inmaculada P-0635
Gil Monica Rebollar OP-144
Gil Latorre Francisca P-0896
Gilat Izhak OP-039
Gilson Richard OP-147
Gimenez María Huertas Vidal P-0030, P-0033, P-0083
Giménez García Rosa María P-0518
Gimeno Jose Carlos Pastor P-1342
Giner Galvañ Vicente P-0666
Gintere Sandra P-0810
Giovannoni Stefano P-1212
Girona Anna P-0048, P-1032
Glaudemans Jolien J. P-0985
Gledo İbrahim P-0015
Gligor Madalina OP-227, P-1067
Gllareva Bashkim P-1129

Göcen Ömer P-0363
Gocer Semsinur P-0989
Godoy I Garcia Pere OP-202
Gogia Atul OP-209
Göğüş Burçin P-0769
Gök Balcı Umut P-0797
Gök Gökçe Nur P-0478
Gök Balcı Umut Course-010, P-1160, P-1167, P-1168
Gök İncikli Sibel P-1193
Gök İncikli Sibel P-1199
Gökçeimam Pınar Şen P-0358
Gökdemir Özden OP-236, OP-243, WS-007, WS-037, WS-116, P-0010, P-0197, P-0356, P-0401, P-0531, P-0819, P-0924, P-1244, P-1248, P-1288, P-1370
Gökgöz Durmaz Funda P-0486, P-0647
Gökşin Cihan Fatma OP-124, OP-128, BR-022, WS-103, P-0211, P-0212, P-0337, P-0471, P-0647, P-0718, P-0815, P-0946, Course-010
Göktaş Olgun WS-066, PNL-005, SYM-029
Gomes Ana Luísa P-0381
Gomes Grace Evelyn Sarinho OP-176
Gomes Mileta P-0049, P-0565, P-0619
Gomez Carlos Calvo P-0144
Gómez Luis Carrera P-1342
Gómez Pablo P-0832
Gómez Bravo Raquel OP-123, Course-011, WS-032, WS-034, WS-113, P-0380, P-0518, P-0727, P-0739, P-0812, P-0818, P-0821
Gómez Quintero Ana María OP-222
Gómez Rubio José P-0960
Gomez Valdes Marta OP-198
Gómez Vizcaino Ana Maria WS-002
Gomiscek Bostjan P-0665
Gömlersiz Mehtap OP-071, P-0368, P-0422, P-0429
Gonçalves Andreia P-0631, P-0632, P-0738
Gonçalves Crhistine Cavalheiro Maymone OP-156, OP-158, P-0878, P-0892
Gonçalves Joana L. P-0526, P-1328, P-0196
Gonçalves Mafalda P-0610
Gonçalves Maria Do Carmo P-0318
Gonçalves Susana Reis WS-074
Gonçalves Victoria Veiga Ribeiro P-0600
Gondodiputro Sharon OP-170
Gönenç Işık Course-006, Course-007, WS-029, SYM-014, P-0155, P-0237, P-0547, P-0670
Gonfaus Mercè Solà OP-146
Gonzales Flores Pedro Alejandro OP-018, P-0058, P-0059, P-0063
Gonzalez Junec P-1000
Gonzalez Roberto P-0159
González Benito Limeres P-0001
González Cristina P-0733
González Gaila Calvo P-0144
González José López OP-001
González Marta Navarro P-1151
González De La Ballina Enrique P-1029
González Fernández Conde M^a Del Mar P-0812
González Irigoyen Maria Josefa OP-006
Gonzalez Muriel Paloma Recio P-1342
Gonzalez Roma Vicente P-0896
Gonzalez Sánchez Jose M^a P-0353
González Silva Yolanda P-0311, P-0739, P-1349

Gonzalo Maria Del Carmen P-0001
Goodhart Clare P-1403
Göret Nuri Emrah P-0212
Görpelioglu Süleyman OP-115, OP-278, P-0468, P-0490, P-0501, P-0542, P-0568, P-0724, P-1038, P-1075, P-1201, P-1386, P-1390, P-1391
Görükmez Sündüs P-0322
Gouveia Maria Do Castelo P-0850, OP-165
Gouwy Nevhayat P-0743
Gozutok Vusale P-0656
Gracia Cecilia Vidaurreta P-1311
Graell Riera Teresa P-0099
Graf Von Der Schulenburg J. Matthias P-1305
Graffy Jonathan P-1403
Graham Dudley James WS-048
Grammenandi Emilia P-0213
Granata Lucio Giuseppe BR-013
Graure Madalina Daniela P-0342, P-1063, P-1084, P-1298, P-1299, P-1302, P-1318
Greene Laurie P-0587
Grier Elizabeth P-0587
Grilo Lourenço Susana P-0136, P-0304, P-0314, P-0459, P-0634
Grissom Maureen P-0551
Grobbee Diederick E. WS-084
Groenewegen Peter SYM-025
Groenhof Feikje OP-206
Gruffydd Jones Kevin OP-241
Güçlü Yasin P-0430, P-0440, P-0550
Güçlü Yusuf Adnan OP-175, P-0181, P-0789, P-0795, P-0796, P-0797, P-0802, P-0862
Gücük Sebahat OP-280, P-0472
Güdücü Nilgün OP-069
Guedes Maria Cândida P-0630
Guedes Marta P-1277
Guerra Carolina Guadarrama P-1342
Guerra Joana P-0088
Guerra Nuno P-0147, P-0324
Guerrero Yamileth P-0101
Guerrero Diaz Beatriz P-1247
Guerrero Díaz Beatriz P-0323
Guerrier Keasha P-0551
Guijarro Laura Ruiperez P-1047
Guijo Gonzales Pedro P-0089, P-0253, P-0254, P-0276, P-0681, P-1213, P-1261, P-1278, P-1364
Guillamon Silvia Penalva OP-144
Guillen Carmen P-0563
Guillen Cavas Florentina P-1063, P-1298, P-1299, P-1302, P-1318
Guillén Pérez José Jesús OP-001
Guimarães Gilberto P-0219
Guiomar Ana P-0514
Gul Kamile P-0068
Gülbahar Merve P-0980
Güldal Azize Dilek OP-126, OP-251, P-0038, P-1112
Güldal Dilek OP-066, OP-119, OP-145, OP-236, OP-246, OP-253, OP-260, WS-007, WS-025, WS-116, P-0538, P-0678, P-0924, P-0963, P-1133, P-1135, P-1137, P-1144, P-1361
Gülderen Evrim P-1158, P-1394
Guler Hatice P-0744
Güler Hüseyin P-1101
Güler Seda P-1143
Gülin Kaya P-0696

Gümüş Aziz P-1199
Gümüş Enes P-0458, P-0978, P-1097
Gümüş Demirel Beril P-1251
Gümüştakım Raziye Şule OP-067, P-1191, P-1362
Günaştı Özgür P-0168
Günaydın Burcu Sena P-1272
Günaydın Sefer P-1052
Gündoğan Rana P-0239, P-0352, P-0361, P-0464, P-0706, P-1133, P-1169
Gundogan Gunes Nur P-1235
Gündüz Orhan P-0735
Gündüzöz Meşide P-0183, P-0184, P-0189, P-0190, P-0192
Güneş Damla P-0819
Güneş İbrahim P-0401
Güneş Selbinaz P-1225
Güney Engin P-0204
Gungor Selen OP-034, OP-225
Güngör Kaan P-1062
Günher Arıca Seçil P-0299, P-0322
Günvar Tolga OP-066, OP-260, OP-287, WS-120, SYM-030, P-0963, P-1144
Günyaşar Tefvik P-1078
Gupta Dhiren P-0410
Gürakar Elif OP-251
Gürbüz Özge Berfu P-0706, P-0991, P-1133, P-1169
Gürel Yunus P-0204
Gürhan Burcu OP-011, OP-044
Guiz Selcuk P-0263
Gusseklou Jacobijn OP-049
Gutierrez Revilla Jose Ignacio P-0370
Güven Fatma OP-238
Güven Furkan Batuhan P-0215
Güven Şirin P-0423
Güven Vasfiye OP-279, P-0433
Güvenç Numan P-0068, P-0416, P-0767, P-1189, P-1397
Guvendi Gülnihal OP-272, OP-273
Guzel Eda Celik P-1078
Guzel Savas P-1078
Güzelçiçek Ahmet P-0424
Güzeloğlu Eren P-0356
H Henrichsen Svein OP-241
Haag Max OP-123
Haas Nico WS-001
Haddad Hele Nice Faria Santos Alves P-0913
Hadley Lesca P-0494, P-0783
Hadley Lesca Cherise OP-160
Hadley Brown Martin SYM-006
Haidich Anna Bettina P-1025
Haignere Charlotte P-0517
Hakan Muzaffer Ece P-1255
Hakkoymaz Hakan P-1357
Halasa Wafa P-1246
Halıcı Elif Can P-0939
Haliloğlu Selin P-1052
Haller Dagmar M OP-009, P-1020
Halligan Paddy P-0466
Halligan Patrick Paddy Course-005, WS-012
Hamden Lenny Martini P-1002

Hamilton Fergus OP-023
Hamilton Willie OP-023
Hamzeh Maher P-0552
Han Seongho P-0548
Hançerli Yusuf P-1345, P-1351
Hande Gürün P-0696
Hanim Hassoune WS-107
Hanratty Mary M WS-056
Hansen Dorte Gilså WS-030
Hanzevacki Miro SYM-010
Hardal Çiğdem P-0413, P-0414
Harmankaya Ahmet Muhammed P-0431
Harmankaya Kaptanoğulları Nazmiye Özlem OP-277
Hart Huberta OP-080, P-0069
Harzheim Erno OP-174, P-0855, P-0856
Hashim Haniza OP-056
Hassan Faezah OP-259
Hatem Habib Aimé P-1343
Hatipoglu Nur Sehnaz BR-045
Hatipoglu Sehnaz OP-126
Hatipoğlu Sami OP-277, P-0432, P-0469
Hatunkız Nazmiye Mehtap P-1011
Haughney John OP-241
Hayashi Mikio P-0245
Hayran Osman OP-078, OP-117
Hayward Richard Andrew OP-201
Hazar Can OP-110
Hazen Ankie P-1222
Healy Pamela OP-109
Heerdink Eibert R OP-254
Hegazy Nagwa Nashat P-0035, P-0808
Heijde Claudia M. Van Der P-0454
Heijmans Stéphane WS-084
Heiskanen Riitta Anneli BR-054
Hekimoğlu Levent OP-281, Course-012
Hellberdn Hilde P-0821
Helmfelt Minobis Adriana P-0284
Helsper Charles OP-216, SYM-012
Helsper Charles Dalcanale CON-002
Helsper Charles W OP-047, P-1026
Hendrickx Kristin P-0762
Hennequin Martine P-0487
Henrichsen Svein Høegh Course-001, SYM-001
Henriot Aymeric OP-262
Heras Antonio P-0048, P-1032
Herdea Alexandru T P-0397
Herdea Teodor Gh P-0397
Herdea Valeria V WS-027, P-0397
Herek Bülent P-0820
Herenda Samira P-1312
Hernandez Elodie P-0945
Hernandez Enriqueta Hernandez P-0176, P-0334, P-1102
Hernandez Juan Matamoros P-0176
Hernandez Bacardit Carla P-1218
Hernandez Baeza Ana P-0896
Hernández Beltrán María Inmaculada P-0040

Hernández Cerón Inmaculada P-1066
Hernández Deleón Eduardo P-0282, P-0284
Hernández Fernández Jaime P-0264
Hernandez Ibañez M Rosario P-0034
Hernández Ibáñez Rosario P-0599
Hernansanz Caviedes Pedro Luis P-0518
Herqutanto Herqutanto SYM-018
Herranz Martinez Cristina P-0095, P-0290, P-0308
Herrera Carmen María Jimenez P-1348
Herrera Rodriguez Pilar P-0166
Herrero Barrera David P-0502
Herrero Velazquez Sonia P-0518, P-0739, P-0812, P-0818, P-0821
Herrmann François P-1020
Herrmann Markus Ludwig, Heinrich P-1128
Hervada Maria Petra Perez P-0150
Hervás Amparo P-0084, P-0141, P-0905
Hervas Docon Amparo P-1363
Hespanhol Alberto Pinto P-0303, P-0921
Hessler Jonas P-0833
Hesso Ahmad P-0552, P-0746
Heybeli Hilal P-0010, P-1248
Heybet Meryem OP-256
Hickner John OP-255
Hidalgo Jorge P-0002, P-0256
Hidalgo Calleja Yolanda P-0040
Hidiroğlu Seyhan P-0036, P-0142, P-0443, P-0685, P-0820, P-0956, P-1236, P-1255, P-1272, P-1292
Higgins Nicola Joanna P-0172
Hillesheim Terezinha P-1214
Ho Chin Yu P-0037
Hobbs Richard WS-084, CON-001
Hodzic Emina P-1015
Hodzic Nadira P-1015
Hoedebecke Kyle OP-143, P-0881, P-0927, P-1142
Hoes Arno W OP-098, OP-208
Hoffmann Kathryn OP-178, WS-039, SYM-010
Högberg Cecilia P-0987
Hollander Monika OP-098, OP-100
Holm Anne P-1037, P-1215
Holt Richard SYM-005
Hombrados Gonzalo María Pilar P-0040, P-0044
Honkoop Persijn WS-083
Hopayian Kevork P-0262
Hotakainen Kristina P-0348
Howard John OP-148
Howe Amanda WS-042, WS-089, WS-105
Howley Derval P-1017
Hrcic Senada P-1081, P-1312
Hsin Tan Chou P-0208
Hsu Hung Tseng P-0208
Htoo Kaug Myat P-1272
Huang Jessica Dos Santos P-0600
Hudelson Patricia P-0906
Huertas Andres Egea P-0003, P-0030, P-0083
Hueso Quesada Rosa P-0040
Huguet Laia Gené P-0886, P-0905, P-1151, P-1363
Huidobro Dosal Carmen OP-199

Huirne Judith OP-223
Hungin Pali WS-008
Hünkerler Zeynep P-0409
Hurtado De Mendoza Medina Ángel P-0347, P-0960, P-1241
Husic Fuad Abit P-0851, P-1023
Hutton Catherine OP-241
Huyuk Gizem P-0414
Hwang Hee Jin P-0998
Hyodo Hideya OP-218
Iacob Mihai Sorin OP-227, P-1056, P-1067
Iacovazzo Pasquale P-0489
Iannos Marie P-0887
Ibán Ochoa Rosa María P-0518
Ibañez Gladys OP-140
Ibañez Jose Antonio P-0101, P-0611, P-1270, P-1306
Ibarra Sánchez Ana María P-0044
Ibisevic Dzenisa P-0577
Ibrahim Gültekin P-0696
Idoia Arrillaga Ocampo P-1380
Idoipe David P-0101, P-0611, P-1270, P-1306
Iftode Claudia OP-045, SYM-010
Igde Mahir P-1021
İğde Mahir P-0366, P-0975, P-1194
Iglesias Quintana Juan Ramón P-0040
Igpoulou Olga P-1346
Ileri Alper P-0475
İleri Hande P-0475, P-0798, P-1160, P-1167, P-1168
Ilhan Pinar P-1176
Ilhan Pinar P-1181
Iliffe Steve P-0777
Illamola Martin Laura OP-006
Inácio Ana Sofia P-0614
Inayatullah Sheila OP-113
İncaman Deniz P-0365
Incecik Yesim P-0804
Incecik Yeşim OP-003
Inci Habibe P-0534, P-0858
Inci Melek P-1309
Indra Syarif OP-030
İncikli Mehmet Fatih P-1193
Ineli Bekir P-0700
Infantino Antonio OP-241
Ing Ab Tanapong P-0042
Ingilok Sezen P-0939
Ingvarsson Catharina P-1001
Insua Flor P-1000
Intrakumhang Chayutra P-0042
Iorgulescu Eugenia A OP-061
Ipek Muhterem P-0937
Iraklianou Styliani P-1071
Iren Akbıyık Derya P-0490
Irene Padial Reyes P-1380
Irie Rosana WS-066, PNL-005
Irigoyen Alvaro P-0611, P-1270, P-1306
Iritaş Servet Birgin P-0192
Iriyanti Devi A P-1313

Irmak Naciye OP-064, OP-065, P-0477, P-0709
Irving Greg WS-100
Isa Tijah P-0561
Isaksson Bertil WS-062
Isanta Pomar Carlos P-0830
Işcan Gökçe P-0458
Iscen Sinan P-1093
Işgüzar Kayhan Süreyya P-1132, P-1157
Işık Memet P-1183
Işık Oğuz P-0416, P-0528, P-0954, P-0964, P-1170, P-1171, P-1356, P-1357, P-1396
Ismail Ilham Ameera P-0456
Ismail Irmı Zarina OP-029, OP-259
Ismail Norhasimah P-1002
İsmail Adibah Hanim OP-056, OP-259
Iswan Akmal Irsyadi OP-030
Iturrioz Pedro P-1000
Iurciuc Mircea OP-045
Iurciuc Stela OP-045
Izquierdo Martinez Maravillas P-0370
Jacevičiūtė Rūta P-0488
Jacinto Nuno P-1310, P-1316
Jacques Zurbach P-0516
Jacquet Jean Pierre OP-262, WS-041, SYM-015, SYM-023
Jaganjac Edina P-0555
Jahan Firdous OP-114, BR-001, BR-016, WS-081, P-0928
Jahn Kassim Puteri Shanaz P-0453, P-0594
Jain Piyush P-0624
Jakstaite Gintare P-0604, P-0605, P-1344
Jałowiecka Izabela OP-002
Jamani Nurjasmıne Aida P-0453
Jameel Sabena Yasmin WS-051
James Adriana P-0199, P-0200
Jamouille Marc P-0933
Janaudis Marco Aurelio OP-220, PNL-005, P-0891
Jancsó Zoltán OP-088
Jandric Ljiljana P-0567
Janeková Etela P-0070
Jang Mi Ae OP-210
Janssen Jolien OP-015
Janssen Maarten OP-157
Jaruseviciene Lina P-1098
Jassim Ghufıran OP-200, P-0800
Jatic Dzanana P-0925
Jatic Zaim P-0851, P-0925
Javier Dodero OP-187
Javierre Miranda Ana Pilar P-0040, P-0044
Javoric Hida P-0997
Jawadi Awatef P-1289
Jeannot Emilien P-0633
Jelastopulu Eleni P-0938
Jelısic Ruzica P-0564, P-1206, P-1207, P-1208
Jenedi Kemal P-1309
Jesic Aleksandra Petar P-0567
Jimenez Juan Reyes WS-002
Jiménez Jesús Salvador P-0563, P-0733
Jiménez Asensio Sandra P-1349

Jiménez González Mercè P-0509
Jiménez Herrera Carmen María P-0347, P-0504, P-0618, P-0960, P-1241
Jimenez Martinez Juana OP-132, OP-263, P-0714, P-0895
Jimenez Muñoz Beatriz P-0265, P-0899
Jiwani Aziz Abdul Rehman OP-229
Johnson Jeffrey Allen P-0873
Joksimović Bojan P-0008
Jong Dd De OP-171, OP-172
Jongstra Susan OP-091
Joore Ivo OP-026
Jordan Kelvin OP-201
Jordana Nuria Montella OP-046, P-0803
Jorge Stéphane P-0196
Jorro Maili WS-017
Joseph Jean Philippe P-0139, P-0515
Joseph Vilaplana Jordi P-0265, P-0899
Jousimaa Jukkapekka P-0291
Joyce Catherine OP-214
Julin Bettina P-0100
Jun Ji Hye P-0066
Juncosa Jordi OP-006
Jung Ha Ji P-0790
Junior Aristóteles Homero Dos Santos Cardona OP-176
Junod Perron Noëlle WS-071, P-0906
Jurado Juan Carlos De Sola P-0597, P-1273
Jurado María Bustillo P-0001
Jurado Sonia Falla OP-132, P-0714, P-0895
Jurgova Eva WS-022
Juste Marin Asunción P-0264
Kaasenbrood Femke OP-098
Kabakcioglu Feyza Parlak P-1107
Kabasakal Hilal P-1194
Kaçar Ezgi P-0436, P-0441, P-0447, P-1115, P-1258
Kaçar Mehtap P-1186
Kaçmaz Ersü Nazmiye P-0463
Kaewpitoon Soraya P-0042
Kaewsawat Anek P-0042
Kafadar Didem OP-016, OP-283, BR-023, WS-016, WS-103, P-0050, P-0411, P-0584, P-0773
Kahveci Rabia OP-249, OP-256, OP-264, WS-104, P-0055, P-0081, P-0321, P-0350, P-0478, P-0690, P-0765, P-0867, P-0961, P-1154, P-1174, P-1177, P-1226, P-1243, P-1266, P-1353
Kakar Atul OP-209
Kakavitsas Foivos Evangelos P-0213, P-0866
Kalabay László OP-097
Kalda Ruth WS-054, WS-055, WS-057, WS-110
Kalem Pınar P-0761
Kalisch Ellett Lisa P-0887
Kalistratos Manolis S P-0169
Kallestrup Per P-0894
Kalliokoski Paul P-0763
Kalpakçı Pınar P-0683
Kalucka Sylwia P-1130
Kalucka Sylwia Katarzyna P-1129
Kamale Samuel S P-1313
Kamaratos Alexandros P-1071
Kamardi Rima Semiarty P-0844, P-0846
Kamradt Martina OP-257

Kanatlı Ulunay P-0367
Kandou Grace P-1162
Kang Hee Chul P-0573
Kanuncu Serdal P-0355, P-1191
Kanyılmaz Bircan P-1368
Kaplan Mustafa P-0022
Kaplan Yusuf Cem OP-177
Kappelle Jaap OP-015
Kapsalakis Georgios P-1068
Kara Ayla P-1337
Kara İsmail Hamdi OP-041, OP-057, Course-009, WS-120
Kara Selami OP-280, P-0472, P-0764
Karabayraktar Tülay P-0231
Karabıyık Berna OP-284
Karabulut Nadiye P-0299, P-0322
Karaca Ayla P-1172
Karaca Yuksel P-0657
Karacağil Mehmet P-0963
Karadağ Berrin P-0512
Karadağ Saygı Evrim Course-013, P-0376
Karademir Beray P-0142
Karademirci Merve P-0946
Karagoz İbrahim P-0467
Karagöz Umut P-1172
Karahan Emine P-0980
Karakaya Ekrem P-0005
Karakoç Esat Veli P-0480, P-0854
Karakoula Konstantina P-1296
Karakurt Davut P-0758
Karakurt Murat P-0189
Karakurt Seda P-1292
Karakuş Serkan P-0653
Karaman Ayşegül P-1244
Karaman Özgür Nadiye P-0538
Karaman Kenesarı Ceren P-0799, P-0966, P-1402
Karaman Tunç Sibel P-1276
Karaoglu Sinem Aslan P-0569
Karaoğlu Merve P-0951
Karaoğlu Nazan BR-036, BR-051, PNL-006
Karatas Ayca OP-264
Karataş Eray İrep OP-060, P-0143, P-0460, P-0742, P-1083, P-1108, P-1176, P-1179, P-1181, P-1184, P-1377, P-1387
Karatekin Güner P-1194
Karathanos Vasileios Trifon P-0938
Karavus Melda P-0142, P-0820, P-1236, P-1255, P-1272, P-1292
Karayürek Yusuf BR-057, P-0222, P-0440
Kardas Przemysław P-0922, P-1146
Kardaş Selçuk P-1395
Kardelen Dizdar Evrim P-1112, P-1259
Kargin Süleyman P-0859
Karic Enisa P-0973
Kariri Abdulrahman P-0408
Kars Veysel OP-017, P-0173
Karsandık Akyol Aylin P-1131
Karsavuran Karaağaç Nadire P-0771
Karslıoğlu Salih Zekeriya P-0047

Kartal Mehtap OP-052, OP-074, OP-111, OP-126, OP-203, OP-233, OP-243, P-0010, P-0149, P-0239, P-0519, P-0531, P-0546, P-0882, P-0966, P-1113, P-1248, P-1288

Kasap Burcu Harmandar P-0755

Kasim İsmail P-1174, OP-264, P-0055, P-0350, P-0478, P-0690, P-0961, P-1154, P-1177, P-1226, P-1266

Kasiulevicius Vytautas P-0060, P-0061, P-0062, P-0064, P-0076, P-0078, P-0086, P-0827, P-1028

Katana Kenan P-0953

Katı Elçin P-0316, P-0321, P-1266

Katic Biljana P-0008

Katrapas Andreas OP-072, P-0312

Katsouri Viktoria P-1071

Katz Natan P-0855, P-0856

Kaufman Tara K. P-0016

Kavaklı Geriř Burçin P-0768

Kavasoğulları Cemal OP-110, OP-147, BR-052, P-0644, P-0929

Kavukcu Ethem P-0529, P-1237

Kawai Makoto OP-218

Kaya Abdulkadir P-1048, P-1049, P-1053, P-1085

Kaya Abdulkadir P-0980, P-0981

Kaya Dayimi P-1244, P-1288

Kaya Ender P-0996

Kaya Ertugrul P-1136

Kaya Ferit P-0157, P-1233

Kaya Gülin OP-094

Kaya Mustafa P-0952, P-0958

Kaya Seyhmus P-1117

Kaya Yasemin P-0210

Kayapinar Osman P-1126

Kayar Yusuf P-0156, P-0656

Kayhan Tetik Burcu OP-041, OP-057, OP-060, P-0417, P-0419, P-0726, P-0760

Kaynar Tuncel Ebru P-0701

Kaypak Ayře Ceren P-0036

Kayserili Gül P-0707

Kazakos Konstantinos P-0671

Kazan Rabee P-0095, P-0290, P-0308

Kearney Mary G WS-056

Kee Kok Wai P-0006

Keevallik Elle Mall BR-039, WS-017

Keglević Mladenka Vrcić OP-135, OP-211, OP-253, WS-064, P-0207, P-0924

Kekalih Aria OP-054, OP-258, P-0917

Kelemci Özer P-0222

Kelestemur Emel P-0460, P-1083

Kelly Maureen OP-109

Kender Ebru P-0672

Kendir Çopurlar Candan OP-066, OP-111, OP-262, P-0252, P-0939, P-1144

Keniş Cořkun Özge Course-013, P-0376

Kenkre Joyce WS-032, WS-033

Kepenek Enver P-0424

Keren Fatma P-0175

Kern Jean Baptiste OP-262

Kerr Mhairi P-0887

Kersnik Janko WS-057, WS-058, P-0665

Kesen Cemre Hilal OP-196

Keskin Ahmet P-0143, P-0160, P-0742, P-1143, P-1179, P-1181, P-1184, P-1376

Keskin Muharrem P-0198

Keskin Neře P-0443

Keskin Zeynep OP-062, P-0407

Keten Alper P-1158
Keten Derya P-0528, P-1158, P-1357, P-1394, P-1396, P-1397
Keten Hamit Sırrı P-0416, P-0470, P-0492, P-0528, P-0767, P-0954, P-0964, P-1158, P-1170, P-1171, P-1188, P-1189, P-1202, P-1356, P-1357, P-1394, P-1395, P-1396, P-1397
Khamis Amar H OP-141, OP-142
Khazzoum Collado David P-0167
Khimion Liudmyla P-0230
Khodatars Kuresh P-0293
Khoo Ee Ming OP-029
Kıbrıslı Erkan OP-017, P-0541, P-0944, P-1093, P-1117, P-1268
Kidd Michael WS-042
Kijowska Violetta WS-057
Kikot Lubov OP-160
Kilbas Zafer P-0723
Kilibarda Valentina P-0993
Kılıç Melek OP-057, OP-060
Kılıç Sema P-0712
Kılıç Tuncer P-0143, P-0160, P-0360, P-0742, P-1108, P-1176, P-1179, P-1184
Kılıç Öztürk Yasemin OP-175, BR-055, P-0181, P-0793, P-0862
Kılıçarslan Barış P-1393
Kılıçaslan Ayşe Özlem P-0452
Kılıçoğlu Dane Pakizer Banu P-0761
Kılınç Faruk P-1012
Kılınç Selçuk P-0450, P-0722
Kilit Celal P-0233
Kim Byung Su P-0066, P-0998
Kim Chul Min P-0790, P-0998, P-1004, P-1005
Kim Hongbae P-0603
Kim Hyeon Ju P-1019
Kim Jin Hee P-0573
Kim Jong Myoung P-0573
Kim Kyoung Rak P-1005
Kim Lee Oh P-1019
Kim Young Sik P-0066, P-0573, P-0998
Kim Young Zu P-0065
Kim Hwee Koh P-0306
Kinder Karen OP-191, WS-102
King Emma P-1403
King Katharine WS-051
Kinouani Shérazade OP-125, OP-167
Kinova Sona P-0715
Kiortsis Dimitrios Nikiforos P-1073
Kiortsis Nikiforos Dimitrios P-1069
Kiosses Vasileios Nikolaos P-0938
Kır Doğru Gülümser P-0602, P-0687, P-0688
Kiral Serkan P-0765
Kiraz Halime Dilber P-1166
Kireva Levena P-0108, P-0110, P-0916
Kırımlı Emrah OP-007, OP-031, OP-067, OP-194, OP-239, BR-043, P-1200
Kırımlıoğlu Nurdan P-0970
Kirinoki Sonoko OP-218
Kirk Ulrik Bak WS-069, WS-091, PNL-003, P-0833, P-0888, P-0889
Kissling Bruno WS-004, WS-106
Kivipelto Miia OP-091, OP-092
Kizil Meltem P-0657
Kızıl Ali P-1089

Kiziler Aliriza P-1078
Kızıldaş Özlem P-1094
Kızmaz Muhammed P-0708
Kjaer Niels WS-057
Klančnik Liljana P-0126
Klemenc Ketis Zalika WS-040, WS-058, WS-117, WS-118, P-0665
Klevarová Kristýna P-0621
Klusova Elena WS-034, P-0805
Koc Bayram P-0295
Koc Murat OP-112
Koç Ali Murat P-1353
Koç Asım P-0724
Koç Esra Meltem OP-249, P-0961, P-1353
Koç Meltem P-0321, P-1226, P-1243
Koca Rafet P-1251
Kocadağ Sabahattin OP-121
Kocaman Fatma P-0137
Kocaman Sevil P-1101
Kocaman Tayfun Barış P-1101
Kocan Yusuf P-0516
Koçanoğlu Abdulkadir P-0326
Koçar Begüm P-1172
Kocazeybek Emre P-0461, P-0699
Koekkoek Paula OP-015
Kökoğlu Burcu OP-261
Köksal Pınar P-0463
Köksal Selçuk P-1031
Köktürk Firuzan P-0479
Kolcu Giray BR-058, BR-075, BR-076, WS-121
Koleilat Camilo Franco Ribeiro P-1382
Kolesnyk Pavlo OP-088
Koliogeorgi Roza Ioannis P-0503
Kömürcüoğlu Yüksel Furkan P-0431
Koné Insa P-0613
Kong Mi Hee P-1019
Kong Sie Zin P-1002
Konitsiotis Spyridon P-1069, P-1073
Konstantinidis Theodoros P-0153
Kontarakis Nikolaos P-0379, P-0847, P-0968, P-1279
Kontopoulou Konstantina P-0623
Kooistra Minke OP-015
Kopcavar Gucek Nena WS-033, WS-046, P-0218
Kopeć Sylwia OP-084
Kör Yılmaz P-1132
Kordalis Athanasios P-0170
Kordi Eleni P-0418
Korkmaz Hasret P-0793
Korkmaz Muammer P-0131
Korkmaz Mustafa P-1384
Korkmaz Sıdıka Büşra OP-285, P-0705
Korkut Yasemin OP-284, P-0232, P-0233, P-0473, P-0702, P-0703, P-0864, P-1141, P-1190, P-1192, P-1367, P-1389
Koroğlu Mustafa P-0345, P-0534, P-0761
Korovski Viviane P-1214
Korpershoek Yvonne P-0077
Korur Aslı P-0072, P-0148, P-0154, P-0523, P-1090, P-1111, P-1329
Koşar Yaşar P-0354, P-0711, P-0954, P-1188, P-1202, P-1359

Kose Seyit Ali P-0467
Köse Dilek P-1132, P-1157
Köse Özlem Onur P-0735
Koskela Tuomas SYM-010
Kosojevic Aleksandra P-0567
Kossarova Lucia P-1220
Kostagiolas Petros P-0866
Kosucu Sibel P-0071, P-0073
Koturoglu Güldane P-0385
Kouraki Athina P-0497
Koureas Achileas P-1296
Kourtparasidou Sofia P-1040
Koutsogiannou Persa P-0938
Kovač Milena Blaž OP-213, P-0109
Koyuncu Murat P-0005, P-0345, P-0761
Kozlov Roman P-0343
Kozlovska Liga P-0810
Kozlovska Maija P-0810
Krasniqi Marsida P-0554
Kravtchenko Oleg WS-040, SYM-015, WS-041
Kreitmayer Pestic Sanda P-0557, P-0593, P-1030
Krievina Gita P-0642, P-1009
Kringos Dionne SYM-025
Kristiansson Robert P-0100
Krivokapic Ana P-0268
Krnac Stefan P-0591
Kropiwiec Maria Volpato P-1214
Kruijer Marjan OP-026
Krztoń Królewiecka Anna OP-002, OP-084
Küçük Hamdi P-0479
Küçükceran Hatice P-0350
Küçükceran Hatice P-0765
Kucukerdem Halime Seda OP-177, P-0729
Küçükkaragöz Hadiye OP-251, WS-007, WS-075, WS-116, P-1225
Kucukyalcin Volkan P-1078
Küçükzeybek Yüksel P-0789
Kuharchuk Christine M P-1109
Kühlein Thomas WS-079
Kukuckova Lucia P-0491, P-0496, P-0636
Kul Ayhan P-1332, P-1334, P-1339, P-1379
Kul Seval P-0431
Külahlı Gökçen P-0326
Kulbay Yuksel Hayriye BR-026
Kulikauskaitė Gabrielė P-0488
Kulotu Suleyman P-1158
Kulovic Atifa P-0041
Kumar Pratyush OP-209
Kumar Vinod P-0549
Kumpunen Stephanie WS-100, P-0835, P-1220
Kunnamo Ilkka WS-102, WS-104, P-0291, P-0540
Kunosic Lejla P-0051
Kuo Chao Hung P-0575, P-0575
Küpeli Emine OP-237
Kuppferberg Irit OP-039
Kuran Muzaffer Yiğit P-0492
Kurban Nursen P-0743

Kurban Yüksel P-0743
Kurc Bionda Alma OP-212
Kurdak Hatice OP-003, PNL-007, P-0168, P-0804, P-1372
Kurdak Sanlı Sadi PNL-007
Kuri Rahman P-1149, P-1159
Kurnaz Mehmet Ali P-0789
Kurpas Donata OP-262, WS-040, SYM-010
Kurşun Hasan P-0532, P-0673
Kurtalic Lejla Mahmut P-1023
Kurtaran Hanefi OP-028
Kurtoglu Emel P-0474
Kurtoğlu Yakıcı Melike P-1042
Kurtuluş Duygu P-0175
Kurugol Zafer P-0385
Kurul Murat P-1031, P-1211
Kurver Miranda WS-011
Kuş Celal P-0470, P-0492, P-0767, P-1170, P-1188, P-1202, P-1356, P-1397
Kusaslan Avcı Dilek OP-207, OP-272, OP-273, P-0994, P-0995, P-1036
Kut Altuğ OP-043, OP-120, OP-226, P-0689, P-0695, P-1111, P-1152, P-1369, P-1373
Kutan Fenercioğlu Ayşen P-0071, P-0073
Kutlu Orkide P-0161, P-0163, P-0171, P-0188, P-0471
Kutlu Orkide P-0198
Kutlu Ruhuşen OP-124, P-0452, P-0718, P-0946
Kutlucan Ali P-1126
Kutlucan Leyla P-0467
Kuyucu Yunus Emre P-0437, P-0704
Kuz Ozan Fırat P-0712
Kuzdan Canan P-0437
Kvåle Alice OP-242
Kvedaras Virmantas P-0604, P-0605, P-1344
Kwaśniak Joanna OP-084
Kwon Ki Young P-0065
Kyriazis Ioannis A P-0169, P-0170
Laan Wijnand P-1006, P-1007
Laçin Tunç P-0142
Lago Fernando OP-085
Lagro Janssen Toine WS-035
Lainez Sara P-0101, P-0611, P-1270, P-1306
Lakiss Sara P-0162, P-0941
Lale Gülseren OP-096
Lambert John OP-247
Lambert Philippe P-0527
Lammers Jan Willem J OP-208
Lamot Leonard P-1254
Lanau Roig Anna P-0099
Lancho Lancho Santiago P-0621
Lanier Cédric WS-071, P-0906
Lapão Luís Velez OP-159, P-0829, P-0845
Larrañaga Lourdes Larrañaga P-1342
Lasevic Margarita P-0060, P-0061, P-0062, P-0064, P-0076, P-0078, P-0086
Lashari Usman Ghani P-1153
Lasic Amra P-0041, P-0577
Lasic Amra Mustafa P-1023
Latham John WS-068
Laurent Geoffroy P-0657
Lavalle Eulalia Villacampa OP-144

Lavorini Federico OP-241
Le Moul Domiique P-0516
Le Moul Dominique OP-051, P-0327
Le Reste Jean Yves SYM-010
Leandro Raquel Burón P-1046
Leandro Suzie S. P-0446
Leça Joana P-0250, P-0375, P-1010
Lechner Matthias OP-147
Leconte Sophie P-1127
Lee Hyeree P-0603
Lee Jeong Ah P-0065, P-0066
Lee Jung Ah P-0573, P-0998
Lee Su May OP-029
Lee Wai Khew OP-029
Lee Yeon Ji OP-210
Lee Yeow Siong P-1002
Lee Yong Joo P-0790
Lee Yongjae P-0603
Leendertse Anne P-1219, P-1222
Leganes Ramos Alejandro P-0074
Leite Adilson Segades P-0910
Leite Catarina Ferreira P-0093, P-0130, P-1253
Leite Luana Thaís Dos Anjos OP-176
Leite Mariana Fidalgo Ferreira P-0292
Leite Mariana Pinto P-1116
Leite Tiago Artur Lyra P-0383, P-0388
Leite Vânia P-0103
Leiva Cepas Fernando OP-228, P-1080
Lejnieks Aivars P-0642
Leksell Janeth P-0100
Lemke Klaus OP-191
Lemos Mariana Oliveira P-0770
Leners Jean Claude SYM-024, P-0500
Leon Vincent T WS-044
Leon Vincent Ted WS-021
Leoni Eleonora P-0579
Leontidou Eleni P-0153, P-0179, P-0180, P-0418, P-0671
Leopanda Zorayda WS-089
Lepenos Theocharis Georgios P-0503
Letona Santiago P-1270
Leveille Donald P-0551
Levites Marcelo Rozenfeld PNL-005
Lewandowska Karolina WS-069, P-0888, P-0889
Liarou Maria Dimitrios P-0503
Libardi Mônica Beatriz Ortolan P-0839, P-0840
Lichtenstein Albert OP-143
Lichtwarck Bjorn SYM-010
Ličyté Indré P-0572, P-0828
Lievano Paola P-0101, P-0611, P-1270, P-1306
Lightbourne Alison WS-042
Liiskmann Agne OP-195
Lilja Mikael P-0100, P-0987, P-1001
Lima Ana Lia De Oliveira OP-150
Lima Inês P-0617
Limem Manel P-1289
Limnili Gizem P-0712, P-0713, P-0799, P-1245

Linares Manuel OP-010, P-0330, P-0341, P-0537
Linares Sicilia Yolanda P-1034
Lindberg Agneta P-0100
Lindberg Maija Riitta P-0348
Lindgren Peter P-0100
Lindqvist Erik P-0205
Ling Helen OP-195
Ling Chun Ou P-0208
Lionis Christos WS-025, WS-040, WS-058, SYM-015, SYM-016, SYM-023, CON-004
Liosi Vasiliki P-1071
Liroz Mercedes P-0091
Lisman Van Leeuwen Yvonne OP-206
Lisspers Karin OP-241
Litra Eirini P-1296
Ljuca Farid P-0019
Lloro Patricia P-0101
Lluch Rodrigo Jose Antonio P-0570
Lluch Rodrigo José Antonio P-0571
Llussà Judit P-0048, P-1032
Lo Fo Wong Sylvie Course-011, WS-032, WS-033, WS-035
Lobato Cortesao Nobre Maria Joao P-0740
Lobato Martinez Rocio P-0679, P-1238
Löfvander Monica P-0763
Logan Alec WS-076
Loganathan Kandan Course-005, WS-012, P-0466
Logotheti Akrivi P-1285
Löndahl Fredrik P-0100
Loogman Masja WS-095
Lopes Iva P-0250, P-0375, P-1010
Lopes M. P-0396
Lopes Marta P-0136, P-0304, P-0314, P-0459, P-0634
Lopes Rita P-1310, P-1316
Lopes Vitor P-0309, P-0389
Lopes Braga Márcia Sofia Dos Reis Gonçalves P-0118
Lopez Jose Antonio PASCUAL P-0003, P-0030, P-0033, P-0083
Lopez Rocio P-0031
López Ana Cristina Menéndez OP-132, OP-263, P-0714, P-0895
López Gregorio P-0733
López Pedro María Martínez P-0003, P-0030, P-0033, P-0083
Lopez Abuin Jose Manuel WS-058
López Blanco Celia Alsu hail OP-001
Lopez Del Pueyo Miguel P-0101, P-0611, P-1270, P-1306
López García Mónica OP-224
Lopez Gonzalez Jose P-1247
López Gonzalo Esther OP-006
López Izquierdo Raúl P-0739
Lopez Lanza Jose Ramon OP-198, OP-199, P-0031, P-0241, P-0370, P-0972, P-0976, P-0979
López Moreno Javier OP-228, P-1080
Lopez Rios Carmen Maria P-0269, P-0270, P-0271, P-0272, P-0274, P-0277, P-0279
López Ríos Carmen María P-0273, P-0275, P-0278, P-0280, P-0294, P-0297, P-0298, P-0300, P-0301
López Tarazaga Ana Belén P-0739
López Torres Jesús OP-083, P-0884, P-0897
López Uriarte Beatriz P-0044
Lopez Videras Rocio P-0370
Lorente Lorente Pilar P-0566
Lorenzo Estela P-0563

Lorenzo Borda María Soledad P-0040
Loström Muth Karin P-0100
Loughman Sheila P-0945
Lourenço André P-0627, P-0639
Lourenço André Pereira P-0510, P-0719, P-1231
Lovatón Giovanna P-0002, P-0256
Lozano M^a Nieves P-0611
Lozano Fernández M^a Jose P-0353
Lu I Cheng OP-180
Luaces Baptiste OP-167
Lucarelli Massimiliano P-0914, P-0920
Ludwicki Tomasz OP-157
Lugo Ramos Hector Leonardo P-0089, P-0206, P-0253, P-0254, P-0276, P-0679, P-0680, P-0681, P-1213, P-1238, P-1278
Luha Jan P-0491, P-0496
Lüleci Emel P-0443, P-0820
Lüleci N. Emel P-1249
Lüleci Nimet Emel P-0036, P-1236, P-1255
Lüleci Nurettin P-0036
Lum Grace P-0405
Lum Grace Huiting P-0932
Luna Gámez Maria Rosa OP-006
Luna Maldonado Aurelio P-0852
Lunsky Yona P-0587
Lup Maria WS-024, WS-026, PNL-001, SYM-013, P-0936
Luptakova Jana P-0636
Luquin Ciuró Nuria P-0323, P-1252
Luquin Martinez Rafael WS-002, P-0323, P-1247, P-1252
Luz Luiza Breuel OP-220, P-0891
Lygidakis Charilaos OP-093, OP-205, WS-113, P-0940
Lygidakis Harris WS-083, PNL-003, P-1297
M Luz Peralta OP-187
Maagaard Roar WS-052, WS-057
Maan Nancy P-0552
Mabic Mirela P-0816
Macedo Inês P-0627
Macedo Inês Espiga P-0510, P-0639, P-0719
Macedo Isabelle Cristine De Jesus P-0598
MacFarlane Anne OP-269, WS-068, P-1013
Machacova Michaela P-0591
Machado Camila Pedruzze P-0926
Machado Célia P-0090
Machado João Fernando Martins P-0292
Machaqueiro Sílvia OP-159, P-0829, P-0845
Macho Del Barrio Ana Isabel P-0040, P-0044
Macit Rümeyza P-0326
Macmahon John P-0421
Macq Jean P-1127
Madanelo Sofia OP-027, P-0096
Madeira Sara P-1091
Madeira Martins Joao Miguel OP-228, P-1080
Madrid Sánchez Encarnación OP-263
Madueño Garro Clara P-0265
Madureira Maria Inês P-1054, P-1057
Maffon Catherine P-0517
Magalhaes Luis P-0317

Magalhães Ana P-0310
Magalhães Joana Palmira P-0307, P-1271
Magalhães Luis Monteiro P-0052, P-0053, P-0261
Magalhães Marta P-0147
Magalhães Sara WS-015, P-0520, P-1082
Magalhães Sara Almeida WS-074, P-0112
Magalhães Sara Raquel P-0333
Magalhães Thiago Cavalcante P-0600, P-1041
Magdalena Carreres M Teresa P-0166, P-0659, P-1099
Maghsoudi Gazelle WS-069, P-0888, P-0889
Magin Parker P-0875
Maguire Gavin P-0466
Mahashur Ashok P-0343
Mahlmeister Jarmila OP-088
Mahsereci Ece P-0431
Mahsun Esra Beşir P-0422, P-0428, P-0429, P-0550
Maier Manfred OP-178, WS-057, WS-080, PNL-006
Majchrzak Król Jolanta OP-002
Makaraviciene Daiva P-0574, P-1028
Makarem Nisrine WS-053
Makas Yasemin Nur P-0616
Mäki Minna P-0348
Maksimovic Veroslava P-0268, P-1290
Maksimovic Zlatko P-0564, P-1206, P-1207, P-1208
Malarska Maria P-0922, P-1146
Maldarytė Laura P-0011
Maleš Bilić Ljiljana P-0593
Malhan Šimten OP-076
Malheiro Felicidade P-0121, P-1076
Malone Louise WS-068
Manas Leocadio Rodriguez SYM-007
Mancha Doblas Isabel P-0107, P-1294, P-1301
Manclús Montoya Luis P-0659, P-1099
Mandıracioğlu Aliye P-1249
Manhal Al Ward Mustafa P-0928
Manjas Menkher P-0846
Manning Garth SYM-022
Manolis Apostolos P-0153, P-0179, P-0180, P-0418, P-0671
Manolis Athanasios J P-0169
Manresa Josep M^a P-1032
Manso Rui Miguel Gigante P-0177
Manso García Susana P-0518
Mant Jonathan P-0983
Manthorpe Jill P-0777
Manzano Inmaculada Vega OP-144
Manzano Montero Mónica OP-221
Marakoğlu Kamile P-0655, P-0708, P-0859, P-0860
Maral Işıl P-0957
Marçalo Sofia P-0630
Marcato Francesco OP-093
Marcelino Gemma Rovira P-0908
Marcelo Sonia P-0117, P-0395, P-1274
March Jordi Gemma OP-077
March Llull Sebastià P-0626
Marchese Juliane P-0387
Marciniak Dominik OP-262

Marco Cristina P-0611
Marco Macián María Dolores OP-154
Margaritis Athanasios P-1346
María Ana Rita P-0811
María Fernandez Zambrano P-1380
María Cristina Garrido Laguna P-1380
Mariani Yusianmar WS-034, WS-092, WS-107, P-0805
Mariano Leal Catarina P-0187, P-0340
Marin Maria Ros P-0003, P-0030, P-0033, P-0083
Marina Victor Lopez P-0150, P-0803
Mariolis Anargiros OP-072, WS-009, P-0312
Markham Genequand Lydia P-0633
Markovic Biserka Bergman SYM-021
Markovic Kristina P-0268
Maroto Delgado Olga OP-095
Marqueño Ellacuría Ana P-0599, P-1034
Marques Diana Costa P-0132, P-1319, P-1320, P-1323
Marques Helena P-0128, P-0448
Marques Nicole P-0214
Marques Nicole Santos P-0770
Marques Rute Nascimento P-0969
Marques Sérgio P-0514
Marqueta Laura P-0563
Marquez Patricia P-0054, P-1161
Marti Amparo Ridaura P-0176
Martí Clavé Laia P-0099
Martin Carmel WS-106
Martin Lourdes OP-050, OP-163, OP-187, P-0074
Martin Nayade Jorge P-0597, P-1273
Martín M Yolanda Valpuesta P-1342
Martín M. Carmen Ruiz P-0244
Martín Borràs Carme OP-146, P-1047
Martín Calle María Carmen P-0044
Martín Cantera Carlos OP-146, OP-221, OP-222, P-1046, P-1047
Martin De Vidales Adriana OP-169
Martín Escudero Juan Carlos P-0518
Martín Fernández Ana Isabel P-0044
Martín Ivorra Rosa P-0570, P-0571
Martín Martín Julian P-0099
Martin Peña Natividad P-0034, P-0599
Martín Pérez Beatriz P-0311
Martine Fuerte Rosario P-0018, P-0325, P-0403, P-0521, P-0524
Martinez Alicia Sanchez OP-132, P-0714, P-0895
Martinez Iris P-1029
Martinez Luc OP-116
Martinez M Pilar Martinez OP-144
Martinez Miguel P-0832
Martinez Raquel P-0611
Martinez Rocio Lobato P-0206
Martinez Sonia Labrador OP-144
Martinez Teresa Rama P-0150, P-0803
Martinez Yolanda P-0540
Martínez Eliseo Manuel Álvarez P-0140
Martínez Juan María Rodríguez OP-137, P-0945
Martínez M Mar Fraga OP-144
Martinez Alonso Gloria Amaranta P-0270, P-0273, P-0278

Martinez Bianchi, Gp Viviane WS-013
Martínez Carmona Remedios P-1066
Martinez De La Iglesia Georgina P-0509
Martínez Fernández Miriam P-1304, P-1349
Martinez Ferris Oscar P-0659, P-1099
Martínez García Elena P-1084
Martinez Gonzalez Susana P-1247
Martínez Liñares Romina P-0508
Martinez Moyano Lourdes P-0794
Martínez Ramos Elena P-1047
Martínez Ruiz Marta P-1066
Martínez Téllez Judit P-0621
Martinón Torres Federico OP-010, P-0330, P-0341
Martins Aníbal P-1231
Martins Carlos P-0303, P-0921
Martins Erivelto Pires OP-133, P-0912
Martins Inês Vinga P-0622
Martins Moysés Ost Damm P-0910
Martins Sara P-0637, P-1325, P-1327
Martins Silvia P-0640
Martins Sílvia P-0134
Martins Simão P-0120, P-0395, P-0736, P-1274
Martins Teresa P-0090, P-0103, P-0392, P-0520
Martins Teresa Pereira P-0296, P-0615
Martorell Daniel Casiano Palacios P-0176
Marty Marie Laure P-0139
Marx Yvonne P-1128
Mascarós Enrique OP-010, P-0330, P-0341
Massana Anna P-0199, P-0200
Mastronuzzi Tecla P-0914
Masvidal Moreno Raquel P-1365
Mata C. P-0116
Mata Célia P-1347
Mata Eva Muñoz OP-046
Mata Manel SYM-004
Mata Maria Dolores Bosque OP-132, P-0714, P-0895
Mateo Gambarte Maria Rosario P-0264
Mateu Nuria Tuset P-0009, P-0791
Mathers Nigel Joseph WS-006
Mathew Rammya P-0777
Matias Catarina P-1310, P-1316
Matin Nayade Jorge P-0079, P-0596
Matos Ana OP-103, P-0286
Matos Carlos P-0585
Matsagos Spyridon P-1073
Matsumura Shin P-1059
Mattila Kari P-1216
Matyjaszczyk Michał P-0922, P-1146
Maucec Zakotnik Jozica P-0686
Mavridou Konstantina P-1064, P-1284, P-1285
Mawardi Maliza OP-161, P-0453, P-0594
May Anne M OP-047
May Laetitia OP-168
Maynard Rafael De Abreu OP-176, P-1295
Mays Nick P-0835
Mazıcıoğlu Mumtaz M OP-086, WS-087, P-0989

Mc Manus Samuel P-0849
Mccullagh Heather P-0421
Mcdonagh Neasa WS-068
Mcdonnell Christina P-1013
Mcfarlane Patrick S BR-034, WS-031, P-0826
Mchugh Sheena M P-1163
Mcnally Grainne OP-197
Mcneil Diane C OP-025
Mcwalter Patricia BR-014
Meakin Richard P-1024
Medeiros Susana WS-015, P-1082
Medlock Stephanie P-1221
Medrano Laura P-0285
Mehic Bakir P-0925
Mehic Farida P-0041
Meijman Frans J. P-0454
Mejia Ganoza Ione Veronica P-0058, P-0063
Mejia Lancheros Cilia P-0105
Melidonis Andreas P-1060, P-1068, P-1069, P-1071, P-1073
Mello Matheus Maia De Souza P-0902
Mellou Kassiani P-0623
Mellouli Menel P-1289
Melo Cláudia P-0400
Melo Isabel P-0610
Melo Leila Medeiros OP-063
Melo Tayná De Souza P-0879, P-0880
Melo E Sousa Inês P-0697
Membrilla Pastor Silvia OP-006, P-1293
Mendes Clara P-0214
Mendes Clara Gameiro P-0770
Mendes Erica P-0267, P-0390
Mendes Inês Abreu P-0619
Mendes Paula OP-231, P-0400, P-0787, P-1086
Mendes Sheila P-0509
Méndez Guillaumet Josep María P-0626
Menegony Martina P-1254
Menendez Suarez Marta P-0812, P-0818, P-0821
Meng Tse Lee P-0208
Menin Alessandro WS-108
Merchant Zabeena P-0494
Mercimek Kutsal P-0210
Mercimek Oznur Berke P-0210
Merder Coşkun Demet OP-042, OP-075, OP-152, Course-013, P-0376, P-0908, P-0939, P-0959
Merdzanovic Elma P-0041, P-0577
Mereu Alessandro P-1212
Mergen Haluk P-0463, P-0795, P-0798, CON-007
Merriel Sam WS-052
Merriel Samuel William David OP-023
Merry Stephen P-0080
Mert Ertan P-0229
Mert Meral P-0469
Merz Victoire OP-009
Mesçi Banu P-0326
Mesquita Umbelina P-0120, P-0736
Mete Nuriye OP-004
Metin Salih P-0430, P-0550

Metsemakers Job OP-038
Mevsim Vildan SYM-030, P-0252, P-0667, P-0991, P-1070, P-1106, P-1169, P-1235, P-1259
Meynard Anne WS-013, WS-014, P-0633
Mezquiriz Javier P-0202
Michael Jennet P-1002
Midik Özlem OP-008
Midik Özpak Ayşe P-1134
Migkos Michail P-1064
Míguez Eva P-0759
Mihailovic Snezana P-1264
Mihos Constantinos OP-072, P-0312
Mijatovic Aleksandra P-0564, P-1206, P-1207
Mijatovic Srdjan P-0564, P-1206, P-1207, P-1208
Mileva Daniela P-0108, P-0110, P-0916
Milios Konstantinos P-1346
Miller Linda WS-063
Millet Joan Pau P-0865
Min Sun Hong P-0065
Minaya Max Encarnación P-0240
Mingir Serdar P-0745, P-1317
Minguenza Marta Bandrés P-0240
Minobis Adriana Helffelt OP-137
Mir Sinan WS-112
Mir Sánchez Carolina OP-095
Mira Mariana Anete OP-103, P-0124, P-0286, P-0614
Miranda Catarina P-1231
Miranda Rita P-0629
Miranda Sara P-0610
Mirzaev Ziya P-0980
Mistik Selcuk OP-014
Mitchell Geoff WS-030
Móczár Csaba OP-088
Modi Rakesh WS-086, WS-112
Modinakis Georgios P-1279
Moffat Mandy OP-118
Mohamad Mohazmi OP-019
Mohamad Gani Abdul Hafiz BR-040, P-0094, P-0561
Mohammad Eini Ali P-0982
Moharrami Fard Majid P-0982
Mohd Salleh Mohammad Ikram P-1058
Mohdyusoff Harmacy OP-029
Mola Ernesto P-0098, P-0920
Molahaliloğlu Salih P-0346
Molas Pilar P-0650
Moldes Esperanza Rodríguez P-0001
Molina Jesús OP-010, P-0330, P-0341
Moliner Molins Cristina P-0539
Molinos Carrasco Cristina P-0559
Moll Van Charante Eric OP-026, OP-092, P-0985
Moloney James OP-197
Moncau Mayola Andrea P-0099
Monique Aubart SYM-024
Moniz Avelina Pereira P-0114, P-0115, P-0622
Monninkhof Evelyn P-0077
Montalva Barra Juan Carlos P-0166, P-0659, P-1099
Monteiro Nina WS-034, WS-107, P-0318, P-0805

Montella Nuria P-0202
Montellà Jordana Núria P-0559
Montenegro Hernan WS-042
Montero Mónica Manzano OP-144
Montero Alía Pilar P-0509
Montero Alvaredo Ana Belén P-0290
Montero Carretero Teresa P-0739
Montesdeoca Carles Alvarado P-1229, P-1311
Montesinos Ramon Laura OP-154, BR-067, P-0167
Montgomery Barney P-0255
Montoya Alvaro Ruiz Risueño OP-132, P-0895
Montoya Francisco P-0199, P-0200
Montoya Julio P-0884, P-0897
Montserrat Capdevila Josep OP-202
Moon Ji Hyun P-1019
Moons Karel G OP-208
Moore Ronnie WS-118
Moores David G OP-025, WS-094
Mora Martinez Albert P-1228
Mora Monago Fatima P-0349, P-0353
Moraes Ana Luisa Ataíde P-0600
Moraes Ana Luiza Ataíde P-0806
Moraes Láyla Moanna Araujo P-1295
Moraes Marielly De P-0918
Moraes Suzana Guimarães OP-220, P-0891
Morais Débora Galli P-1214
Moral Betül P-0529
Morales Espinoza Enma Marianela P-0502, P-0838
Morales López Rosario OP-001
Moran Carthage P-0014
Moran Joe P-0014
Moreira Carolina P-1286, P-1287
Moreira Carolina Martins BR-047, P-0585, P-0586, P-0893, P-1263
Moreira Fernando Erick Damasceno OP-102, P-0598
Moreira Hugo De Souza Motta P-0904
Moreira Margarida P-1231
Moreira Rickella Aparecida Alves OP-005, OP-063, P-0848
Moreira Sara P-0317
Moreira Sara Matos P-0052, P-0053, P-0261
Moreira Sónia OP-190
Moreira Sónia Manuela Rodrigues P-0219, P-1185
Morena Susana OP-083, OP-085
Moreno Cristina Blánquez P-0886
Moreno Samuel García P-1348
Moreno Fernández Gemma OP-006
Moreno Fontiveros Maria Angeles P-0027, P-0082
Moreti Eleni P-0195
Moreto Graziela WS-066, PNL-005
Morgado Catarina Ameixa P-0622
Morgado Patrícia OP-024, OP-027, P-0096, P-0097
Morgan Douglas R P-1051
Moriano M Dolores Garcia P-0791, P-0009
Moriarty Toireas OP-197
Moricova Stefania P-0491, P-0496
Morna Madalina Beatrice P-0242, P-0246
Morozovas Valerijus P-0834, P-1022

Morrão Bruno P-0305, P-0629
Mossberg Lennart OP-070
Mota Monica P-0641
Mota Monica Vanessa P-0697
Mota Rute P-1231
Motolese Paolo OP-204
Motwani Heera P-0549
Moulon Isabelle WS-046
Moura Ana Luisa Franco OP-005, OP-131, OP-252, P-0757, P-0772, P-1178, P-1180
Mousafiri Urania P-1346
Moutinho João Rocha P-0224, P-0302, P-0313
Moya De La Calle Marta P-0518
Mpahara Aikaterini OP-072, P-0312
Mpellos Dimitrios Lampros P-0503
Mtiraoui Ali P-1289
Mucha Fatima P-1214
Muchlyte Estera P-0060, P-0061, P-0062, P-0064, P-0076, P-0078, P-0086
Mucuk Salime P-0989
Mudifer Omar P-0408
Müdüroğlu Yunus P-0238
Muijsenbergh Maria Van Den WS-013, WS-014
Mulabegovic Nedzad P-0851
Mulder Johannes OP-171, OP-172, OP-173
Mulero Cervantes Juan Francisco WS-002
Mulholland Christopher P-0947
Mullen Jennifer OP-197
Mullis Ricky P-0983
Mundet Xavier P-0105
Munggaran Ayu Indriyani OP-113
Muñiz Quinto Ester P-1265
Muñoz Eva P-0202
Muñoz José Luis P-0733
Muñoz Leticia P-0563
Muñoz Abad Laura P-0349
Muñoz Franco Isabel OP-198, OP-199, P-0241, P-0370, P-0972, P-0976, P-0979
Muñoz Maya Ruth BR-005, WS-109, P-0347, P-0504, P-0618, P-0960, P-1241
Muñoz Ortiz Laura P-0509
Munoz Perez Miguel A. WS-084, P-0105
Muresan Ioan WS-027
Murgui Betran Sandra P-1363
Murphy Carol OP-247
Murphy Enda BR-006, Course-005, WS-012
Murphy Katie P-0014
Murray Scott WS-030
Mussina Aigul Sakariyevna OP-189
Mustan Kemal OP-246
Mustapha Maila P-1002
Mutlu Hasan Hüseyin P-0414, P-1123, P-1124, P-1125, P-1354
Nager Anna SYM-023
Nagy Marijana P-1281
Nakanishi Luciana P-0383, P-0388
Nalet Paul OP-125
Nalian Osman P-0671
Nallbani Genta P-0554
Namora Nuno P-0090, P-0392, P-0520, P-0730, P-1054, P-1057
Nanos Panagiotis P-1025

Naous Jihane OP-184, WS-019
Narring Françoise P-0633
Nascimento Luiz Felipe Cunha P-0910
Natal Fernando Ferreira OP-102, P-0837
Navarro Pujol Margarita P-1224
Navarro Robles Cristina P-0606
Navas Nieves P-0782
Navey Fleur WS-063
Navntoft Dorte P-0833
Neam Sok Naye P-0516
Nease, Jr. Donald OP-143
Negre Mireia Leal P-1229, P-1311
Nelken Bestvina Darja OP-212
Nelson Henrik WS-062
Nena Evangelia P-0153, P-0179, P-0180
Nerkiz Polat P-0378, P-1256
Nessler Katarzyna OP-002, OP-084
Neto Cláudia P-0391
Netto Antônio Freitas P-0913
Neumoexpertos On Behalf Of OP-010, P-0330, P-0341
Neves Ana Luisa WS-083
Neves Rosa P-1100, P-1234
Ng Nawi P-1051
Ng Victor WS-052, WS-061, P-0881
Ng Victor K WS-010
Nguyen Gerard OP-051, BR-008, P-0327, P-0516, P-0517
Niakas Dimitrios P-0866
Nic An Fhaili Mairead OP-270
Nicolás Carrillo Andrea P-0852
Nicolucci Antonio SYM-005
Nicsa Ovidiu P-0539
Niedvaraitė Monika P-0060, P-0061, P-0062, P-0064, P-0076, P-0078, P-0086, P-1028
Nielen Mark OP-100
Nieto Sánchez Sara P-0311, P-1304, P-1349
Nijvelt Mirjam WS-065
Nikitidou Elpida P-0671
Nikolić Sara P-1281
Niksic Dragana P-0925
Nizam Serap P-0582
Nizamoğlu Gözde P-0441, P-0447, P-1115, P-1258
Nobre Maria Joao P-0088
Nobre Maria João P-0766
Nóbrega Letícia Batista P-0902
Nogueira Cilia P-1274
Nogueira Paulo OP-159, P-0829, P-0845
Noonan Laura P-0343
Nordeman Lena P-0205
Norman Armando Henrique CON-002
Norman Gift OP-021
Novaković Igor P-1205
Ntambwe Nicodeme P-0516
Nuhoğlu Çağatay P-0434
Numanoğlu Rukiye OP-076
Nunes Nidia P-0136, P-0304, P-0314, P-0459, P-0634
Nunes Barata Ana WS-107
Núñez Mònica Torremorell P-0085

Nurhan Ekin P-0769
Nuria Marañón Henrich Nuria P-0044
O`riordan Ciara OP-197
O Carroll Austin OP-247, OP-269, WS-067, WS-068, P-1013, P-1017
O Shea Marie T. OP-215
O`brien Rowena WS-063
O`connor Ray OP-197, P-1013
O`Reilly Fiona OP-269, WS-068
O`sullivan Ciara OP-197
O`donnell Patrick OP-269, WS-090, P-1013
Oana Cristian Sever OP-118
Ocaña Daniel OP-010, P-0330, P-0341
Ochiai Yuri P-0091, P-0635
Ock Sun Myeong P-1004
Odriozola Izaskun P-1000
Ognjanova Biljana Petkovska P-0067
Ognjanova Violeta P-0067
Öğülmüş Sevim OP-164, P-0481, P-1176, P-1181, P-1376, P-1377, P-1387
Oguz Ayten P-0068
Oğuz Aytekin P-0023, P-0024, P-0043
Oğuz Esin P-0616
Oğuzhan Delican OP-196
Oğuzhan Hakan P-0211
Oh Han Jin P-0998
Ohara Toshihiko OP-218
Ok Sun Wha P-0998
Okada Tadao P-1059
Ökmen Zeynep Hazıroğlu P-1166
Öksüz Banu Gülcan P-0366, P-0975, P-1021
Öksüz Ergün OP-041, OP-057, OP-076
Öksüz Mehmet Ergun OP-193, P-0813, P-0822
Oksuz Zortul Sultan P-0654, P-0737, P-0788, P-0931, P-1341
Oktay Cem P-0355
Oktay Gülseren P-0028, P-0427, P-0437, P-0536, P-0704, P-1307
Oktay Muhammet P-0028
Okudan Yunus Emre OP-236
Okur Tuğba P-0423
Okuturlar Yildiz P-0469
Okuyan Ertuğrul OP-283
Olinto Rafael P-0836
Oliva Célia Pinto saraiva P-1185
Oliveira Albina P-0638
Oliveira Bruno OP-024, P-0097
Oliveira Davison Rodrigues Lima OP-131, P-0772
Oliveira Isabela Aniz OP-150
Oliveira Milca Lopes De P-0892
Oliveira Pedro P-1234
Oliveira Pedro Ribeiro P-0412, P-1100
Oliveira Ricardo P-0412, P-1100
Oliveira Trícia Guerra E P-0885
Oliver Maria Reyes P-0563
Oliver Reyes P-0733
Olivo Ros Jose Pedro P-1084
Ölmez Caner P-1395
Ölmez Soner P-0492, P-0954, P-1171, P-1188, P-1189, P-1356, P-1395, P-1396
Omanović Alen P-0015

Omar Juslina P-1002
Omar Mimi OP-029
Ömeroğlu Tuba P-0774
Onal Fulya P-1233
Onal Osman Aga P-1354
Önal Derya P-0478
Önal Zehra Esra P-0434
Onalan Orhan P-0345
Onat Tuğba OP-119, P-0678, P-1135
Onat Tuğba OP-066, P-1144, P-1169
Önay Hakan P-0416, P-0954, P-1170
Öncü Ufuk Birim Öncü P-0142
Öncül Börekci Nazire P-0694
Öncül Börekçi Nazire PNL-008
Önder Nurgül OP-277, P-0432
Oner Ercan P-0995
Öner Can OP-013, OP-059, P-0023, P-0024, P-0137, P-0450, P-0451, P-0721, P-0722, P-1385
Ong Julia Hui Li P-0932
Onganer Efe WS-077, P-0560
Öngel Kurtuluş OP-101, OP-175, Course-010, WS-119, P-0463, P-0475, P-0793, P-0795, P-0796, P-0797, P-0802, P-0871, P-0872, P-1160, P-1167, P-1168, P-1393, CON-007
Önler Dilek P-0075
Onodera Naoko OP-218
Onwuteaka Philipsen Bregje OP-266, OP-267
Oosterberg Eldine WS-013
Orak Murat P-0151, P-0152
Orçun Asuman P-0231
Örenler Mehmet P-0424
Orhan Miyase P-1190
Oriordan Caitriona P-1013
Ormeño Victorero Giancarlo Jesús P-0058
Ortega Angeles P-0256
Ortega Lluïsa P-0865
Ortega Maria P-0905
Ortí Clara P-0650
Ortiz José Ángel Sanchez P-0079, P-0596, P-0597, P-1273
Oruç Muhammet Ali P-0682, P-0683
Oscanoa Patricia Elena P-0664
Oscanoa Huamán Patricia P-0174
Oscar Perez Quintana P-0334
Ose Dominik Johannes OP-257
Osman Hibah WS-030
Otero Angel OP-050
Otero Leiro Noa P-0508
Oungsakul Teeranart P-0042
Outumuro Elena Pintado P-0009, P-0791
Ova Mehmet Emin P-1158
Ovejero Gomez Victor OP-198, P-0241, P-0972
Övet Neslihan P-0749
Öz Emin P-1101
Öz Firat OP-075
Ozad Ulvan OP-110
Özata Musa OP-249
Ozay Gülper P-0588, P-0589, P-0590
Özbakır Zeliha OP-120, P-1373
Özbakiş Serkan OP-031

Özberk Derya Işıklar P-0452

Özçakar Nilgün OP-052, OP-089, OP-126, OP-203, OP-240, WS-037, SYM-030, P-0197, P-0239, P-0352, P-0356, P-0361, P-0401, P-0464, P-0706, P-0712, P-0713, P-0799, P-0819, P-0882, P-0934, P-0966, P-1204, P-1245, P-1337, P-1339, P-1370, P-1401, P-1402

Ozcakir Alis WS-030

Özcan Fatih P-0823

Özcan Sevgi OP-237, PNL-007, P-0168, P-0558, P-0955

Özcan Dost Betül P-1355

Özçelik Esmâ P-0477, P-0709

Özçelik Gülsüm P-0980

Ozciftci Nuran P-1106

Ozdemir Mustafa Turan P-1035

Özdemir Çiğdem P-0168

Özdemir Osman OP-285

Özdemir Serkan OP-007, P-0355

Özdemir Zeynep Tuba P-0211, P-0212

Özdemir Özhan P-0765

Özden Aslan P-0853

Özder Aclan P-1145

Ozdinc Serife P-0725

Özdoğan Şebnem OP-068

Özel Kerem OP-069

Özen Mehmet OP-282, P-0532, P-0673

Özenç Salim P-0032, P-0295, P-0372, P-0373, P-0780, P-1093

Özendi Yeliz OP-090, P-0209, P-0338, P-0545

Özenli Yarkın P-1050, P-1089

Ozer Ozlem P-0737, P-0788, P-0931

Özer Burcin P-1309

Özer Cahit OP-265, P-1309

Özer Hatice P-0204

Özer Ilkay P-0337

Özer Özlem P-0406, P-0616, P-0654, P-1341

Özer Yelda Zeliha P-1372

Ozeraitiene Violeta P-0574

Özeren Mehmet P-0475

Özğün Burak P-0431

Özgür Salih P-1160

Ozhan Hakan P-1126

Özince Ege P-0201, P-0420, P-0996

Öziş Türkan Nadir P-0183, P-0190

Özkahraman Aylin P-0036

Özkan Nurşah OP-281, P-0355

Özkara Adem OP-256, OP-264, P-0020, P-0022, P-0055, P-0081, P-0257, P-0258, P-0321, P-0350, P-0478, P-0506, P-0690

Özkara Adem P-0691

Özkara Adem P-0765, P-0867, P-0961, P-1154, P-1174, P-1177, P-1226, P-1266

Özkaya Hilal P-0534, P-0682

Özkayar Nihal P-0021

Özlem Nuraydın P-0974

Özmen Berk Barış P-1072

Özmen Ülkü P-0479

Özşahin Akatlı Kürşat P-1111

Özşahin Aytekin P-0122, P-0135, P-0741

Özsu Elif P-1103

Öztaş Dilek P-0346

Öztaş Özlem P-0417, P-0760

Öztekin Coşkun OP-286
Öztürk Ahmet P-0989
Öztürk Cansu P-0393, P-1275
Öztürk Gülsah P-1196, P-1392
Öztürk Makbule OP-057, OP-060
Öztürk Onur OP-008, P-0012, P-0366, P-0480, P-0974, P-0975, P-0977, P-1194, P-1195, P-1196, P-1355, P-1392
Öztürk Yasemin Kılıç P-0795, P-0796, P-0797
Özyurt Ayşegül P-0951
Özyurt Beyhan Cengiz OP-139
Pacheco Gustavo Oliveira P-0910, P-0913
Pacheco Lorena Nogueira OP-150
Pachniak Paulina P-0922, P-1146
Padiyal Reyes Irene P-0606
Padullers Gloria P-1240
Padullers Furriols Gloria P-1265
Padure Ioana OP-045
Pagan Dato Enrique P-1298, P-1299, P-1302, P-1318
Pais J. P-0396
Pais Juliana P-0377, P-0382, P-0448, P-0493, P-0580, P-0583
Paiva Marcele P-0017
Paiva Zara P-0384
Paixão Luís Miguel P-0698
Paixão Luís Miguel Azeredo Lopes De Moura P-0824
Pakasi Trevino Aristakus OP-055, P-0915, P-1164, P-1239, P-1313
Pala Emin P-1368
Palacín Piquero Herminia P-1224
Palacios Jesús García P-0244
Palacios Colom Alberto WS-002
Palacios Fort Rosa M^a P-0039, P-0247, P-0248, P-0249
Palancı Yılmaz OP-017, P-1384
Palandeng Henry OP-244, P-0693, P-1162, P-1350
Palanduz Ayşe P-0185
Palisaiyte Dalia P-0060, P-0061, P-0062, P-0064, P-0076, P-0078, P-0086
Pallarés Carratalá Vicente P-0666
Pamuk Gülseren WS-119
Pamukcic Crnogorcevic Mirsada P-1312
Panadero Francisca P-0199, P-0200
Panaitescu Catalina OP-118
Paniccia Cuocco Franco P-0095
Pantic Xenia P-0332, P-0661
Papaioannou Christodoulos P-1285
Papanas Nikolaos P-1040
Papazafeiropoulou Athanasia P-1060, P-1068, P-1069, P-1071, P-1073
Papazoglou Dimitrios P-1040
Papendang Harry Allan OP-055, P-0915
Papi Alberto OP-241
Pardo Jacobo OP-010, P-0330, P-0341
Paredes Carlos Moral P-0001
Paredes Elisa P-0731
Parellada Neus P-0539
Parellada Esquius Neus P-0857
Parent Mathias Veronica P-0092, P-0288, P-0289, P-0380, P-0727, P-0728, P-1291
Parente Joana P-0130
Parente Joana Silva P-0093, P-1253
Parıldar Hülya P-0692, P-0695
Park Hye Won P-1267

Park Js P-0548
Park Yj P-0548
Parkan Sirin WS-077, P-0560
Parlak Adem P-0032, P-0131, P-0372, P-0373, P-0780, P-0883, P-0900, P-1093
Parlak Nehir P-0032, P-0372, P-0373, P-0780, P-0883, P-0900
Parodi López Naldy BR-065
Parra David Botaro OP-137, P-0908
Párraga Martínez Ignacio OP-083, OP-085, P-1066
Parrella Silvana Francesca P-0489
Pars Ecem P-0871
Pas Leo WS-005
Pas Lodewijk Course-011, WS-023, WS-032, WS-033
Paşalı Kilit Türkan P-0232, P-0233
Pascual Rosa Codina P-0085
Pascual Val Teresa P-0044
Pasman Roeline OP-266, OP-267
Pastor Juana Noelia López P-0003, P-0030, P-0083
Pastor Maria Úbeda OP-144
Pastor Gradolí Noelia OP-020
Pastor Villalba Eliseo P-0570, P-0571
Pastore Fabrizio OP-204, P-0489
Patel Anjali OP-247
Patel Niraj P-1220
Patiran Florensiana P-1313
Patramanis Ioannis P-0497
Patras Luminita P-0896
Paula Amanda Ferreira De P-0903
Paula Pedro Subtil PNL-005
Paulino Sofia P-0627
Paulius Mindaugas P-0572, P-0828
Pavkovic Bojan Zoran P-0087, P-0315, P-1055, P-1077
Pavlov Renata WS-007, P-0924, P-1018
Pawelec Anna P-0945
Paz Enrique López P-0144
Paz Galiana Juan P-0273, P-0280, P-0294, P-0297, P-0298, P-0300, P-0301
Peddle, Md Allison P-0783
Pedone Sabrina P-0395, P-1274
Pedreira Samuel P-0296
Pedrosa Daniela P-0219, P-0344
Peixoto Catarina P-1231
Pekelman Renata OP-138, P-0918
Pekez Pavlisko Tanja WS-032, WS-033, WS-041, WS-045, WS-047, SYM-015
Pekgenç Abatay Mukaddes P-0203
Pekgör Selma P-0161, P-0188, P-0191, P-0471
Pektas Esra P-0654, P-0931
Pena Ana Sofia OP-103, BR-062, P-0124, P-0286, P-0614
Peña Edgar Martin P-1051
Peña Antón Nuria P-0040
Pena Pérez Xoel P-0502
Penedo Cláudia P-0283
Penel Isabelle OP-051
Perakis Ioannis P-0213
Peralta M Luz OP-163
Pereda Garcia Maria Angeles P-0241, P-0976, P-0979
Pereira Altamiro Costa P-0303
Pereira Álvaro P-0511

Pereira Anderson De Almeida OP-176
Pereira António OP-159, P-0829, P-0845
Pereira Carolina Martins P-0598
Pereira Enrique Gestal P-0145
Pereira Gonçalo P-1116
Pereira Marcela Ramos P-0903
Pereira Margarida P-0318
Pereira Olga P-0319, P-1280
Pereira Pedro Miguel Paulino P-1185
Pereira Raul Marques P-0177
Pereira Sandra P-0511
Pereira Leite Teresa P-0136, P-0202, P-0304, P-0314, P-0459, P-0634
Perez Alvaro P-0031
Perez Concepcion P-0563
Perez Edelmira Moreno P-0334
Perez Maria Rosa Sánchez P-0596, P-0597
Pérez Beatriz Martínez P-0145
Pérez José Jorge OP-085
Pérez Laura Ruiz P-1102
Pérez Manu P-0782
Pérez Caballero Francisco Luis P-0349, P-0353
Perez Cachafeiro Santiago P-0556, P-0601, P-1029, P-1043, P-1044
Perez De Ayala Enrique P-1000
Pérez González Irene P-0311, P-1304, P-1349
Pérez Gutierrez Nuria OP-006
Perez Hernandez Flora P-0370
Pérez Herrera Mar P-1224
Pérez López Silvia P-0025, P-0026, P-0566
Perez Martin Alvaro OP-198, OP-199, P-0241, P-0370, P-0972, P-0976, P-0979
Perez Nicolas Estefania OP-154, P-0167
Pérez Stachowski Javier P-0592
Perfors Ietje A.A. OP-047
Perić Stojan P-1290
Perk Gürün Hande P-0956
Perla San Martin Rodrigo P-0265
Perla San Martin Rodrigo Gonzalo P-0899
Perona Pagán Miquel P-1224
Perpinyà Elvira P-0782
Perry Andrea P-0587
Pérula De Torres Luis Ángel OP-228, P-0553, P-1080
Pervanlar Ayşe P-0449
Pešević Pajčin Jadranka P-1352
Pesic Marijana Aleksandar P-0809
Pessanha Paulo Rui P-0303, P-1400
Petek Davorina SYM-010
Peters Ron J OP-092
Petra Marianna P-0029
Petrazuoli Ferdinando OP-088, WS-041, WS-079, WS-102, SYM-010, SYM-015, P-0545
Petropoulou Eleni OP-072, P-0312
Petsas Vasileios P-0497
Pettigrew Luisa WS-100, P-1220
Pettigrew Maria Luisa M WS-042, P-0835
Pianca Danilo Dos Santos P-0877
PICANCO Marilucia Rocha De Almeida P-0383, P-0387, P-0388
Picanço De Miranda Junior Ubirajara José OP-102, P-0598, P-0600, P-0806, P-0836, P-0839, P-0840, P-0841, P-0904, P-1041

Picañol Dolors Costa P-0150
Pichlhöfer Otto OP-178, P-1156
Piera Salmerón Aina P-0621
Pighi Andrea BR-027
Pijoan Anna María De Pedro OP-137
Pijoan Anna Maria Pedro P-0908
Piko Lesley Margaret OP-214, WS-088, P-1118, P-1119
Pilar García OP-187
Pilco Alicia Díaz P-0595, P-0842, P-0843, P-1217, P-1218, P-1265
Pilegaard Rikke P-0833
Pina C. P-0116, P-0396
Pina Carla P-0377, P-0382, P-1347
Piñana Lopez Alfonso P-0323, P-1247, P-1252
Piñana López Jose Antonio P-1252
Pineda Coronel Rahalf Martin P-0566
Pineda Pérez Maria Soledad P-0353
Pinheiro Torres Sofia P-0511
Pinho Ana Margarida OP-127, OP-155, P-0123, P-0580, P-0583, P-0628, P-1014
Pinho Celia P-0893
Pinnock Hilary OP-118
Piñón Gamallo Ana Belen P-0556, P-1029, P-1044
Pinto Andreia P-0610
Pinto Anny Priscila Gutemberg P-0904
Pinto Daniel SYM-010
Pinto Daniela P-0344
Pinto Duarte P-0219
Pinto Luísa P-0320
Pinto Oriana Correia P-0669
Pinto Sofia Correia P-0638, P-0669, P-1122
Pinto Sofia Rendeiro Correia P-1185
Pinto Antunes Jorge SYM-017
Pinto Antunez Jorge P-0831
Pirdal Hasan P-0480
Pires Ana Catarina P-1010
Pires Ana Luisa P-1010
Pires Camila Guedes Silva OP-176
Pires Karem Cristina Martins P-0885
Piric Lejla P-0051, P-0557
Pirincci Edibe P-0157, P-0651, P-0748, P-0817, P-1233
Pirotta Enzo OP-088
Pişkin İbrahim Etem OP-238
Pivic Gordana P-0816
Pivic Maja P-0816
Plaku Sokol P-0554
Plath Jasper P-0613
Platin Ayşe Rana P-0175
Plaza Carmen OP-187
Plaza Isabel P-0199, P-0200
Plédran Bernard OP-167
Pleite Raposo Raquel P-0040
Poçan Ahmet Gürhan P-0689, P-0720, P-1111
Poças Gabriela Silva P-0052, P-0053, P-0261, P-0317
Podgórski Michał P-0922, P-1146
Poduval Shoba P-1092
Polat Abdurrahman P-0584
Polat Zeynep P-0004

Polatçı Havva P-0385
Pollack Craig OP-191
Polónia Jorge P-1400
Pongoh Natasha P-0693
Pons Laura Pons P-0244
Pons Querol Monica OP-018, P-0058, P-0059
Ponsico Gemma Puig P-0085
Pontes Mônica Barros De P-0885
Poon Victoria P-0821
Popescu Dana Stefana WS-024, WS-026, PNL-001, SYM-013, P-0936
Poplas Susic Antonija OP-099, OP-213, P-0109, P-0126, P-0620
Poplas Susic Tonka OP-104, P-0125
Popov Borislav Nikolov P-0911
Popovic Dusan P-0953
Porta Enrique Álvarez OP-137
Portero Alonso Antonio P-0570, P-0571
Portillo Horcajada Laura P-0074
Postelnicu Thérèse OP-051
Potrebica Silva P-0133
Poulorinakis Ioannis P-0968
Pouwer Frans SYM-004
Poviloniene Rima P-0060, P-0061, P-0062, P-0064, P-0076, P-0078, P-0086
Prabudi Edo P-1164
Pranjic Nurka P-0007, P-0593, P-1016
Pranjić Anja P-0593
Prasiddha Lorens P-1239
Prasinou Tzormpatzaki Panagiota Vasileios P-0503
Prasko Subhija P-0015
Prasopa Plaizier Nittita WS-042
Prassas Nikolaos P-0623
Prat Rovira Josep P-0509
Prates João Ricardo Simczak OP-102, P-0841
Prazasta Raka OP-245
Pretto Michele Paula P-0855
Price David B. OP-241
Price Jim WS-106
Prins Jan OP-026
Prljević Gordana P-1254
Prudente Lorena De Almeida Ribeiro OP-005, OP-131, OP-252, P-0757, P-0772, P-1178, P-1180
Pruteanu Daniela Florentina OP-020, OP-095
Puce Sandra P-0810
Puente Hector P-0537
Puig Ponsico Gemma P-0264, P-1224
Puigdomenech Elisa P-1046, OP-146
Pujol Maria José P-0650
Pulcinelli Danielle OP-108
Purcu Serhat P-0469
Puronaite Roma P-0060, P-0061, P-0062, P-0064, P-0076, P-0078, P-0086
Puskoriute Daiva P-0732
Putra Khoiron Muhsinin OP-113
Putri Novana Perdana SYM-018
Pyzio Monika OP-084
Qidwai Waris WS-082, CON-006
Queiroz Valério Rui P-0119
Quelha Sara P-0121, P-0305, P-0629, P-1076
Quélier Christine OP-106

Quesada Rosa Hueso P-0044
Quesnot Helene P-0516
Quezada Cherrielyn Recana P-1104
Quezada Gertrudis Garcia OP-046
Quinlan Diarmuid OP-181
Quiñones Perez Antonia P-0779
Quintana Oscar Perez P-0176, P-1102
Quiroz Celia P-0256
Quispe Suárez Marco Arturo P-0559
Rabadan Manuela Carmona OP-144
Rabanales Joseba OP-083, OP-085
Racic Maja SYM-015, P-0008, P-0993, P-1205
Radosavljevic Nevenka Strahinja P-0967, P-1209
Radovanovic Cedomir P-1207, P-1208
Radunovic Draginja SYM-029
Raga Alfredo Quiles P-0176, P-0334, P-1102
Rahman Süheyla OP-139
Rahman Yong Rafidah Abdul P-0943
Raineri François OP-116
Raivio Risto P-1216
Rajan Dheepa WS-042
Ramdzan Siti Nurkamilla P-0456
Ramic Enisa P-0013, P-0015, P-0019, P-0973, P-0992
Ramic Irma P-0013
Ramírez Manent Ignacio WS-002, P-0282, P-0284, P-0285
Ramirez Tarruella Dolors P-0857
Ramirez Temblador Mauricio P-1366
Ramón Susana Sánchez P-1342
Ramon Marsal Josep OP-202
Ramos Elena Martínez OP-146
Ramos Casals Manuel P-0838
Ramos Corbella Elena OP-006
Ramos Ordoñez Adriana P-0221, P-1365
Ramos Segura José Ramon P-0666
Randall Smith Jane OP-262, SYM-015
Rando Jimenez Ana P-0727
Rapazote Madalena P-0617
Raquel Barba OP-187
Rascón García Ana P-0095, P-0308
Rasic Veronika BR-038, WS-097, P-0881
Rasmussen Martin SYM-012
Rasschaert Nele P-0762
Rätsep Anneli WS-110
Rauck Sandra P-0613
Raudonyte Daura P-0060, P-0061, P-0062, P-0064, P-0076, P-0078, P-0086
Rausch Siggy WS-001, PNL-004, SYM-024
Raussi Jaana P-0348
Rawat Ming WS-068
Rea Jennifer Nicola Maeve P-1024
Reboul Marie Catherine P-0527
Rechou Antonio Garcia P-0145
Redondo Esther OP-010, P-0330, P-0341
Redondo Miquelina P-1116, P-1303, P-1324
Redondo Berná Gerson P-0290
Redondo Sánchez Mercedes P-0044
Rees Claire Patricia P-1210

Regente Jacinta P-0614
Reichel Christofer Patrick WS-092, P-0908, P-0945
Reichel Patrick WS-107, P-0894, P-1297
Reid Jim Course-002, SYM-001
Reig Botella Mila P-0666
Reijnders Leida OP-186
Rein Maria Rosario Rosillo P-1273
Reinders Marcel WS-065
Reis Bruno P-0309, P-0389
Reitsma Johannes B OP-208
Rejón Sandra Jiménez OP-001
Relva Joana P-0329, P-1325
Relvas Adriana P-0446, P-1014
Relvas Adriana Rosas OP-155
Relvas Mariana Almeida Pinto Moura P-0318
Renda Marta P-0740
Renom Guiteras Anna P-0540
Reolid Martínez Ricardo Enrique OP-224, P-1066
Reoyo Gloria Inmaculada Mestre P-1273
Repar Bornsek Simona OP-104, P-0125
Repiso Gento Irene P-0812, P-0818
Requena Ferrer Rosa P-1298, P-1299, P-1302, P-1318
Requena Ferrer Rosa María P-1084
Requesens Catalan Maria Àntonia OP-006
Resende David Carvalho OP-005, OP-131, OP-252, P-0757, P-0772, P-1178, P-1180
Review Group PRIMA eDS P-0540
Rey Seoane Miriam P-0095, P-0290, P-0308, P-0539
Reyhani Negin P-1013
Rho Jun Seung P-1004
Riba Llana Iolanda P-1032
Ribas Maria José CON-008
Ribeiro Helena P-0090, P-0103, P-0296, P-0391, P-0392, P-0520
Ribeiro Hugo P-0731
Ribeiro Joana OP-024, OP-027, P-0096, P-0097
Ribeiro Leticia P-0371
Ribeiro Luis P-0632
Ribeiro Luís P-0738
Ribeiro Thaís Viana P-0890
Ribeiro Tiago P-1054, P-1057
Ribot Serra Blanca OP-077
Richard Edo OP-091, OP-092
Riera Cervera María Dolors P-0174
Riesgo Susana Elizabeth P-0009, P-0174, P-0240, P-0664, P-0791
Riesgo Escudero Brenda Elizabeth P-0009, P-0240, P-0791
Rifouna Maria OP-072, P-0312
Rigon Sara BR-048, Course-008, WS-034, WS-107, P-0805, P-0894, P-0945
Rinawan Fedri Ruluwenta OP-170
Rioja Zarrabeitia Luis P-0241, P-0976
Rios Susana P-1116, P-1303, P-1324
Rita Susana OP-103
Rita Susana Cordeiro P-0124, P-0127, P-0286, P-0614
Rivas Miguel P-0101, P-0611, P-1270, P-1306
Rivas Ruiz Francisco P-0728
Rivera Ainhoa Toscano OP-144, P-0650
Rivera Mónica Arcos P-0033
Rivera Monica Michelle Arcos P-0083

Rivera Casares Francisca P-0025, P-0026, P-0566
Rivera Jimenez Nuria P-0349, P-0353
Rivero Irene OP-010, P-0330, P-0341
Rizzato Ângela Eugênio OP-220, P-0891
Roa Santervas Leonor P-0849
Robinson Louise SYM-010
Robledo Lidia Evangelista P-0009
Robra Bernt Peter P-1128
Robson Noorzurani OP-161
Robusto Fabio OP-204, P-0489
Roca Dani P-0199, P-0200
Roca Lafont Marta P-1218
Rocha Ana P-0627, P-0639
Rocha Ana Sofia P-0719, P-1260
Rocha Érica Viana P-0333, P-0776
Rocha Paula Alexandra P-1087
Rocha Sara De Sousa OP-230, P-0625
Roche Nicolas OP-241
Rochefort Andrée WS-093, WS-093, WS-099
Roda Ignacio Borque OP-137
Rodrigues Ana Catarina P-0628
Rodrigues David P-0136, P-0304, P-0459, P-0634
Rodrigues David Tomaz P-0314
Rodrigues Edelvels OP-138
Rodrigues Fernanda P-0730, P-1054, P-1057
Rodrigues Larissa Dos Reis P-0598
Rodrigues Maria Lurdes P-1283
Rodrigues Wallace Pinheiro OP-005, OP-131, OP-252, P-0757, P-0772, P-1178, P-1180
Rodriguez Belen Sanchez OP-144
Rodriguez Delia P-0054, P-1161
Rodriguez Dolors OP-146
Rodriguez Francisca OP-163
Rodriguez Ingrid Pinilla OP-144
Rodriguez Jaime P-0832
Rodriguez M Victòria Feijoo OP-144
Rodriguez Miguel OP-241, SYM-003, SYM-009
Rodríguez Ana P-0759
Rodríguez Carmen Lires P-0145
Rodríguez Cecilia Doménech P-1229, P-1311
Rodríguez Miguel Roman Course-002, SYM-001, SYM-002
Rodriguez Casal Paula Pilar P-0556, P-0601, P-1029, P-1043, P-1044
Rodriguez Gómez Inmaculada P-0353
Rodriguez Latre Lluisa P-0857
Rodriguez Martínez Fernando Jose WS-002
Rodriguez Pérez M Carmen P-0509
Rodríguez Rodríguez Ana Olga P-0040
Rodriguez Santos Maria Dolores P-1252
Rodriguez Trujillo Antonio P-0243
Rodriguez Vallejo Juan Jesus P-0089, P-0253, P-0254, P-0276, P-1213, P-1238, P-1261, P-1278
Roh Hye Ri P-0573
Rohmah Riza Mawaddatar OP-245
Rohrbasser Adrian WS-091
Rohrer James P-0080, P-0394
Rohrer James E. OP-012, P-0016
Rohrer James Edwin P-0723
Roiatti Isabella OP-110, OP-147, P-0929

Roig Espert Belén P-0666
Rojas Andrés R. Parra P-0244
Roldan Javier OP-163
Rollán Gómez M^a Jesús P-0739
Romagosa Pérez Portabella Ana P-0621
Romaguera Lliso Amparo P-0857
Roman Carmen OP-045
Roman Rudi P-0855, P-0856
Romani Maya P-1147, P-1148
Romão Ana Margarida OP-230, P-0625
Rombot Dina P-0693
Romera Liébana Laura P-0621
Romero Arancha P-0884
Romero Carme Claramunt P-1047
Romero Gregorio Pizarro P-0150, P-0803
Romero José P-0664
Romero Garcia Elisa P-1043
Romero Rodríguez Esperanza María OP-228, P-0553, P-1080
Romero Tamara Jose P-0174
Romo Maria Dolores P-0606
Roncero Vidal Romualdo P-0353
Ros Martinez Encarna P-1252
Ros Martínez Encarnación P-0323
Rosa Ana Patrícia Rodrigues Carvalho P-0140
Rosa Matilde P-0829, P-0845
Rosa Zambrana M Belen P-0221
Rosario Frederico WS-023
Rosario Dourthe Pablo Alexander P-0626
Rosen Rebecca P-1220
Roshu Anelya P-0332, P-0661
Rosich Martí Isabel P-1224
Rosillo González Antonio P-0044
Roughhead Elizabeth P-0887
Rovira Marcelino Gemma P-0265, P-0899
Roy Rakesh P-0781
Rroku Besmira P-0554
Rua Ana Sofia P-0631, P-0738
Rua Sofia P-0632
Ruano Inmaculada Pacheco P-0714
Ruano Núria Sánchez P-0886, P-1151
Rubin Greg WS-008, SYM-012
Rubinstein Aguñin Pablo OP-018, P-0059
Rubio Villar Mercedes P-0040
Rudebeck Carl Edvard WS-062
Rudland Simon Victor BR-012
Rueda Beatriz García P-1046
Rueda Laura Sanz P-1342
Rufaidah Melia Fatrani OP-245
Ruiz Arantxa Castillejos P-1229, P-1311
Ruiz Rocio Gil P-0079, P-0596
Ruiz Toni López OP-144
Ruiz García Antonio P-0040, P-0044
Ruiz Martínez David P-0186
Ruiz Téllez Angel WS-102
Runa Daniela WS-015, P-1082
Rurik Imre OP-088, OP-088, PNL-006

Russo José Carlos Da Silva OP-230, P-0118
Russo José Silva P-0625
Russo Marc P-0255
Ruth Muñoz Maya P-1375
Rutten Frans H OP-098, OP-208
Rutten Guy OP-015, OP-080, P-0069
Ryan Deborah P-0421
Ryan Dermot OP-241, SYM-002, SYM-003, SYM-009
Ryan Paul OP-181
Rynikova Melania P-0591
Rzayev Aynur P-1125
Sa Maria Miguel OP-155, P-0377, P-0382, P-0446, P-0448, P-0493, P-0580, P-0583, P-0668, P-1014
Sá Luísa P-0303, P-0921
Sá Susana P-1116, P-1300, P-1303, P-1324
Sá Vanessa P-0214
Saa Trianggrid Sara P-1313
Saab Basem Roberto WS-053
Saad Robert P-0487
Saad Zahra P-0746
Saad Eldin Mohamed Elmoktar OP-149
Saadallah Nazek P-0162, P-0874, P-1343
Saaltink Anne Linde OP-206
Saatçı Esra P-0861, P-1090, P-1150
Saba Ekin OP-007
Saenz Juan Ignacio OP-032, OP-087
Saez Rubio Gemma P-0034
Saffel Shrier Susan BR-049, P-0645
Saftescu Sorina OP-227, P-1056, P-1067
Sağ Çiğdem P-0434
Sagia Chariklia P-1068
Saglam Kenan P-0122, P-0131, P-0135, P-0394, P-0723, P-0741
Sağlam Zuhale Aydan OP-272, OP-273, P-0004, P-0326, P-0413, P-0414, P-0426, P-0449, P-1042, P-1062, P-1120, P-1123, P-1124, P-1125, P-1354
Sağlıker Saba P-1275, P-1276
Sağun Hatice Gül P-0004
Şahan Hasan Can P-1292
Sahin Hüseyin Avni OP-207, OP-272, OP-273, P-0994, P-0995, P-1036
Sahin İrfan OP-016
Sahin M. Kursat P-0949, P-0950
Sahin Murat P-0068
Şahin Cem OP-053, P-0538
Şahin Erkan Melih OP-034, OP-082, OP-225, P-0480, P-0999, P-1035
Şahin Gülay P-0483, P-0484, P-1138, P-1140
Şahin Hasan Hüseyin BR-018
Şahin Hüseyin Avni WS-045
Şahin Mustafa P-0443
Şahin Mustafa Kürşat OP-279, P-0235, P-0433, P-0483, P-0484, P-0674, P-0675, P-0676, P-0677, P-0701, P-0801, P-1138, P-1139, P-1140, P-1200
Şahin Saliha P-0209, P-0338
Şahin Sevnaz OP-139
Sahin Kavaklı Havva P-1377
Saigusa Taro OP-218
Saini Anita S OP-025
Sakaite Asta P-0060, P-0061, P-0062, P-0064, P-0076, P-0078, P-0086
Sakallı Cemal P-0644
Sakar Şükriye P-0427

Sakin Abdullah P-0163
Sala Nüría P-0865
Salama Aml Ahmed OP-036, OP-105, BR-007, CON-005
Salanova Penalba Alejandro OP-154, P-0167
Salazar Juan Carlos OP-032
Salcedo Esther Díaz P-0085
Salciute Greta P-1028
Saldır Mehmet P-0378
Salgado Frederico P-0697
Salguero Abrego Glenda P-0349
Salgür Funda P-1152
Salim Hani Syahida P-1058
Salman Zeliha P-0178
Salva Turhan P-0820
Salvado Marta Gamez OP-046
Salvador Mafalda P-0214
Salvador Mateo Agnès P-0621
Samad Norlehan Abdul P-0943
Samiotou Dimitra P-1060
Samoutis George OP-148
Sampaio Rafael P-0902
Samuel García Moreno P-1375
Samuel Noelia Benítez P-0003, P-0030, P-0033, P-0083
Samuelsson Eva P-0987
San Andres Sagrario Barcos OP-144
San Juan Minchero Javier P-0979
San Miguel Martin Nuria OP-199
San Roman Arispe Iris Nathalie OP-202
Sanaan Rajab Hassan OP-173
Sanches Ana Menezes P-0399
Sanchez Inma OP-032, OP-087
Sánchez Cristina Gallardo P-0085
Sánchez Encarna Rodríguez P-0085
Sánchez Estela Diaz P-0079
Sánchez José Carlos Perez P-0079, P-0596, P-0597, P-1273
Sánchez Nuria P-0141, P-0905
Sánchez Nüría P-0084
Sánchez Albarrán José Luis P-0509
Sánchez Belmonte Sara P-1265
Sánchez Burgos María Fernanda P-0502
Sánchez Calso Antonio P-0040
Sanchez Casco Silvia OP-018, P-0058, P-0059
Sanchez Galan Patricia P-0186
Sánchez López Ana Belén P-1066
Sanchez Martinez Diana P-0595
Sanchez Ramon Susana P-0311, P-0518, P-0739, P-0812, P-0818, P-0821, P-1304, P-1349
Sánchez Ramos María Carmen P-0040
Sánchez Rodríguez Juan Carlos P-0311, P-1349
Sanchez Sanchez Maria José P-1252
Sancho Perpiñan Amparo P-0559
Sanda Luminita PNL-002
Sandıkçı Kamuran Bahar OP-276, P-0486
Sandıkçı Mert Muhittin OP-276
Sandra Roldan García P-1375
Sandutu Dorica WS-024, WS-026, PNL-001, SYM-013, P-0936
Sang Ngam Thawee P-0042

Sangkarit Pantipa P-0042
Sanjurjo Sergio Cinza P-0001, P-0144, P-0145
Sanner Kathleen P-0260
Sanromà Anna P-0091
Santamaría Susana Hernández P-1342
Santeugini Bosch Anna P-0221
Santiago García Mari Carmen WS-002
Santos Ana Dulce Batista P-1295
Santos Angeles P-0650
Santos Cleuzieli Moraes OP-158
Santos Gui P-0266, P-0283
Santos Henrique Batista Araujo P-0904
Santos Jéssica Tamires Souza OP-176
Santos Jonathan P-0227
Santos José OP-024, P-0096, P-0097
Santos José António OP-027
Santos Lais Silva Neves P-0926
Santos Liliana P-0389
Santos Luis OP-024, P-0097
Santos Luís OP-027, P-0096
Santos Luiza Costa Cysne Dos P-0890
Santos Marta P-0120
Santos Marta Sousa P-0736, P-1274
Santos Paulo P-0303, P-0921
Santos Paulo Alexandre Azevedo Pereira P-1087
Santos Ricardo P-0641, P-0697
Santoso Fabianto P-1164
Santsalvador Font Isabel P-0308
Sanz Maite OP-163
Sanz García Francisco Javier P-0666
Sanz Gonzalez Natalia P-0018, P-0325, P-0403, P-0521, P-0524
Sanz Velasco Carmelina P-0040
Sapoka Virgilijus P-0060, P-0061, P-0062, P-0064, P-0076, P-0078, P-0086, P-0827, P-1028
Sapulete Margareth OP-244
Saraiva Izabela Maciel OP-063
Sardo Ana Franganito P-0766, P-0792
Sargin Fatma P-1125
Sargin Mehmet Course-003, P-0231
Sari Della Puspita P-1239
Sari Gülsah P-1317
Sari Ayşe Nur P-0431
Sarı Nagihan P-0470, P-0767
Sarı Oktay P-0122, P-0131, P-0135, P-0295, P-0723, P-0741, P-0750, P-0807, P-1114
Sarıçam Hicri P-1131
Sarıcı Gülben P-0702, P-1367
Sariöz Abdullah P-1292
Sarteur Laetitia P-0517
Sasaki Eduardo OP-220, P-0891
Sastre Sara P-0101
Sattler Martin OP-123
Sauco Colon Inmaculada P-0680, P-1364
Savage Autumn P-0494
Savassi Leonardo Caçado Monteiro P-0878
Save Dilsad OP-033, OP-094, P-0461, P-0735, P-0699, P-0956
Savino Laurie P-0260
Sayalı Erhan OP-031

Saygılı Lütfiye Füsün P-1248
Sayılır Ayşe Gökçen P-0160
Sayın Seher P-0718
Sayın Dinçer Zeynep OP-062, P-0316, P-0350, P-0407, P-1097
Sayre Jerry W. OP-192
Sazak Özlem P-0299
Sazak Seda P-0708
Scafato Emanuele OP-093
Scafuri Francesca OP-093
Scanlon Lorraine P-0014
Schachtel Bernard P-0260
Schachtel Emily P-0260
Schäfer Willemijn SYM-025
Schandorf Eva P-0833
Schellevis Francois OP-100
Schlager Roman WS-104, P-0540
Schmitz David WS-047
Schrans Diego SYM-010
Schulz Rothe Sylvia P-0613
Schürerer Svenja P-1305
Schuurmans Marieke OP-040, P-0077
Schwarz Peter SYM-006
Searle Kendall Anne BR-042, P-1371
Sebo Paul P-1020
Segura Jose M P-0054
Segura Jose Maria P-1161
Segura Miguel Angel Asmat P-0030, P-0083
Sehovic Rasema P-0041, P-0577
Seidu Samuel SYM-004
Seifert Bohumil SYM-012
Seker İlknur Suidiye P-0467
Sekeri Zafiria P-1025
Selamet Gülçinay P-1236
Selçuk Engin Burak OP-041, OP-057, OP-060, P-0726
Selçuk Mustafa Yasin P-1392
Selek Demirel Fatma P-0171, P-0815
Selek Demirel Fatma P-0337
Selick Avra P-0587
Selvi Nora P-0141, P-0886, P-0905
Semedo Luís P-0216
Semerdjieva Maria P-0108, P-0110, P-0916
Şen Gökhan OP-260
Şen Merve PNL-008
Şen Mustafa Gökhan P-0882
Şen Şerife Gözde P-0036
Sena De Barros Nuno P-0631, P-0738
Şencan İrfan OP-264, P-0055, P-0257, P-0258, P-0350, P-0478, P-0506, P-0690, P-0958, P-0961, P-1154, P-1174, P-1177, P-1226, P-1266
Sendra Marta P-0199, P-0200
Sener Alp OP-177
Sengezer Tijen OP-122, OP-177, P-0691
Şengören Dikiş Özlem P-0971
Şengül Mesut P-0536
Şengüleroğlu Nuri P-1097, P-1360
Şenol Gamze P-1031, P-1061
Sensoy Nazli P-0725, P-0745, P-1262, P-1317

Şentosun Yetkin P-0351
Şentürk Hayriye P-0171, P-0188, P-0191
Seo Yuri P-0988
Seoane Jose Miguel P-0563
Sereesongsaeng Thanaban P-0042
Serin Halil Ibrahim P-0211
Serna Elena P-0031
Serra Marta Albiol P-0085
Serra Serra Domenec P-0509
Serrano Gil Abel P-0243
Serrano Lozano Maria Carmen P-0264
Serrano Montagud Silvana P-0566
Serrano Morales Cristina P-0599
Sessa Aurelio P-0343
Set Turan P-0045, P-0047, P-0146, P-0236, P-0259, P-0445, P-0485, P-0660, P-1149, P-1159, P-1388
Setiawati Elsa Pudji OP-170, P-0522
Sevim Ramazan P-0431
Sevim Sezgin P-0990
Seydaoglu Gülsah P-0955
Seydel Emine Hilal P-0568
Seyler Didier OP-116
Sezek Isa P-1101
Sezen Gülbin P-0467
Sezer Asiye P-0608, P-0609
Sezer Burcu P-1021, P-1165
Sezer Hacı Ömer P-0404
Sezer Recep Erol PNL-002, P-1186
Sezgin Yılmaz OP-288, P-1121
Sgouros Kostantinos P-0170
Shaaban Juwita OP-029, OP-056
Shafrazyam Mger P-0202
Shah Waqaar OP-035, P-0165
Shaheen Hala Mohamed Elmoselhi P-0808
Shaku Fumio P-0778
Shalak Manar P-1147, P-1148
Shalihati Fithriyyah OP-054, P-0917
Shamsuddin Nurainul Hana P-0453, P-0456, P-1058
Shanmuganathan Punithavathy P-0456
Shariff Ghazali Sazlina P-0594
Sharma Satya OP-242
Sharp Deborah OP-023
Shea Tim P-0260
Shephard Adrian P-0255, P-0260, P-0343
Shevtsova Natalia OP-160
Shiigai Masanari P-0245
Shim Jaeyong P-0603
Shiner Alice WS-105
Shukri Baker P-0849
Siagian Iyone P-1350
Siauliene Laura P-0060, P-0061, P-0062, P-0064, P-0076, P-0078, P-0086
Siauryte Skipariene Ligita P-1098
Siddiqui Muhammad A OP-114
Sidiropoulos Haralampos P-0418
Siebenhofer Andrea P-0613
Sierra Martinez Iker P-0325, P-0403, P-0521, P-0524
Sierra Martinez Leticia P-0018, P-0325, P-0403, P-0521, P-0524

Sierra Quintana Eva P-0311, P-1304, P-1349
Siersma Volkert P-1215
Sigwald François OP-051
Sıkar Derya OP-277, P-0432
Silina Vija P-1009
Siljander Tuula P-0348
Siloti Rayza Montovani P-0926
Silva Abimbola WS-033
Silva Bianka De Oliveira OP-108
Silva Carla P-0134
Silva Carla Thiebaut Jussim Kalil P-0877
Silva Carlos Franclim Moreira P-1087
Silva Celia P-1014
Silva Célia Gomes OP-127, OP-155, P-0123, P-0628
Silva Diogo P-0132, P-1319, P-1320, P-1323
Silva Joana P-0526, P-0641
Silva Joana Guerra P-0766, P-0792
Silva José Bastos P-0668
Silva Lisete Aires P-0117, P-0120, P-0287, P-0395, P-0736, P-1274
Silva Mara P-1014
Silva Maria Teresa Pereira Rodrigues Gaudêncio P-0228, P-0359
Silva Mariana Sousa P-0784, P-0785
Silva Patrícia P-0514
Silva Sara P-0697
Silva Vera Pires Da Course-008, P-0381
Silva González Yolanda P-1304
Silveira Lara Louise Guimarães OP-005, OP-063, OP-131, OP-252, P-0757, P-0772, P-0848, P-1178, P-1180, P-1382
Simanauskas Kazys P-0011, P-0374, P-0444, P-0572, P-0716, P-0732, P-0751, P-0752, P-0753, P-0754, P-0828
Simanauskienė Eglė P-0374, P-0572, P-0828
Simatoniene Violeta P-1098
Šimić Dobrislav P-0581
Simko Juraj P-0715
Simkova Adriana P-0715
Simos Yannis P-1069
Simsek Ergun P-0071, P-0073
Şimşek Oğuz Kaan P-0461, P-0699
Şimşek Yasemin Course-010, P-1160, P-1167, P-1168
Şimşek Yurt Nur P-1096, P-1101, P-1095
Sin Eun Kyung P-0790
Sincan Suat OP-286, BR-066, P-1048, P-1049, P-1053, P-1085
Sipahioğlu Fikret BR-033, P-1031, P-1061
Şişli Zafer P-0966
Sisó Almirall Antoni P-0838
Sit Dede P-0156
Sitepu Monika Saraswati SYM-018
Sivaslıoğlu Ebru P-0211
Sivrel Uzun Ece P-1031, P-1211
Skeraj Fitim P-1203
Skobe Viktor WS-062
Skoufias Spyridon Panagiotis P-0503
Škrinjar Andrej P-0126
Skufca Sterle Mateja OP-099
Skuja Ilze P-0642
Slama Chaudhry Anbreen BR-003, WS-003
Sletvold Bjørn P-0849
Sloane Peter A WS-083, WS-091, WS-092, WS-113, PNL-003

Sloeserwij Vivianne P-1219, P-1222
Smajlovic Renata P-0992
Smalinskaitė Gintarė P-0444
Smeets Hugo M OP-254
Smith Gary P-0255, P-0260
Smolina Liudmyla P-0230
Smout André Pm P-1006, P-1007
Smrekar Ulrike P-0821
Smyrnakis Emmanouil P-0942
Snaidere Julija P-1009
Soares Catarina P-0219
Soares Márcia P-1074, P-1227, P-1230, P-1315, P-1322
Sobral Maria Ana WS-015, P-0776, P-0786, P-1082
Sobrinho Lino Martins De Oliveira OP-176
Softic Albina P-0007, P-1015, P-1016
Sohn Augustine Jungmoon OP-255
Soininen Hilka OP-092
Solak Karabörk Meryem P-0711
Solak Tekin Nilgün P-1251
Soldea(herdea) Lidia T P-0397
Soler Jean Karl PNL-006, SYM-010
Soler Arau Josefa P-0595, P-1217
Soleski Kiril OP-162
Solha Isabel P-0227
Solha Isabel Santos P-0287
Solias M Roser Sanchez OP-144
Solís Aguilera María Del Mar P-0960
Solito Martino P-0489
Solmaz Mehmet Solmaz P-0142
Solmaz Nisa OP-115, P-0490, P-0501, P-1075
Solmaz Soner P-1329
Sonmez Feruze Turan P-0028
Sönmez Bilge OP-041, OP-057, OP-060, OP-076, P-0355, P-0409
Sönmez Cemil Işık P-0028
Sönmez Ferah P-0435
Sönnichsen Andreas P-0540
Soria Navalon Beatriz P-0039, P-0247, P-0248, P-0249
Soriano Diestre Silvia P-0539
Šormaz Ljubomir P-1352
Soteras Oriol Gallart P-1047
Sotirov Andriana P-0620
Soto Casas Miguel P-1326
Soto Diaz Sonia P-0074
Souliotaki Evangellia P-0497
Sousa Daniel Beirão P-0630
Sousa Hélder P-1314
Sousa Inês Melo P-0641
Sousa José Nunes OP-155
Sousa Lourdes P-1277
Sousa Luís Alves P-1231
Sousa Manuel P-0329
Sousa Sophie P-0402
Sousa Sophie Amandine P-0336
Sousa Silva Mariana P-0119
Souto Inês OP-190
Souza Cristina OP-158

Souza Ludimilia Henrique De P-0912
Souza Rafaela De Paula P-0926
Soyluol Gulec Selen P-1250
Soysal Nazlı P-1167, P-1393
Sözen Fisun OP-120, P-0425, P-0578, P-1152, P-1155, P-1369, P-1373
Sozmen Kaan OP-177
Sozmen Melih Kaan P-0457
Spatharas Vasileios Ioannis P-0503
Spruit Bentvelzen Lotte P-0077
Spyropoulou Panagiota P-1073
Sruogaitė Veronika P-0374
Stahl Juliane OP-157
Ställberg Björn OP-241
Stanetić Kosana P-0984
Stankovic Marko P-0268
Statkuvienė Ernesta P-1098
Stavdal Anna WS-046, WS-117, WS-118
Stavrikj Katarina SYM-020
Stefanescu Claudia Maria OP-045
Stefanescu Daniela WS-024, WS-026, PNL-001, SYM-013, P-0936
Stefani Dimitra P-0170
Steiropoulos Pashalis P-0153, P-0179, P-0180
Stella Bárbara Breda OP-220, P-0891
Stender Kristina Mauer PNL-002
Stephan Blossom C OP-092
Steylaerts Carl WS-115, SYM-028, P-0933, CON-003
Stoffers Jelle WS-085
Stokes Lampard Helen Jayne WS-006
Stol Daphne OP-100
Storman Monika OP-002
Streit Sven SYM-010
Struzzo Pierluigi OP-093
Stufano Angela P-0914
Stukena Inga P-0642
Sturmberg Joachim OP-166, WS-004, WS-106
Suárez Carmen P-0832
Subirats Duran Natàlia P-0621
Sucaklı Mustafa Haki P-0354, P-1111, P-1359, P-1395
Sucha Veronika P-0491
Sucu Pakize P-1368
Suer Necdet P-0449
Suhaimi Julia P-0456
Suherman Suherman OP-113
Sukriev Ljubin SYM-019
Suleiman Emad Eldin Eljak OP-149
Suleiman Sitizaleha OP-029
Sulejmanovic Sevko P-1015
Sumilaite Agne P-0716
Sunay Didem P-0046, P-0525, P-0643, P-0743, P-0758, P-1039
Sungur Mustafa Azmi P-1394
Sunwoo Sung P-0066, P-0998, P-1267
Sur Ünal Ülkü Course-004
Surkov Sergey OP-037, OP-037
Sütlü Sevinç P-0450, P-0722
Suvan Şeniz P-1172
Suzaki Makoto OP-218

Svab Igor OP-213, WS-057
Svanholm Christina WS-069, WS-091, P-0888, P-0889
Svensson Ann Marie P-0100
Sveroni Eirini Matthaïos P-0503
Swensen Elizabeth WS-058
Swinglehurst Deborah WS-076
Szecsényi Joachim OP-257
Szpilman Ana Rosa Murad OP-133, OP-136, P-0877, P-0879, P-0880, P-0885, P-0890, P-0902, P-0903, P-0910, P-0912, P-0913, P-0926
Tabak Damir P-0207, P-1003
Tabak Vesna OP-179, P-0207, P-1003
Tabouraing Patrick BR-056, PNL-004, SYM-024
Tacheva Veselina Petrova P-0911
Taçol Esin P-0764
Taft Angela WS-033
Tahmazoğlu Burak P-0443
Tajada Viales Celia P-0559
Takagi Pedro Thiago Hideyuki P-0904
Tamarit García Juan José P-0666
Tamás Ferenc OP-097
Tamm Helena WS-028
Tan Boon Yeow P-0932
Tan Makbule Neslişah OP-126, P-1259
Tanaka Akihiro OP-218
Tannous Reine P-0162, P-0941
Tanovic Dzenana P-0851
Tanriover Ozlem P-0685, P-0820, P-1272
Tanriöver Özlem OP-117, PNL-002, P-1186
Tanriverdi Mehmet Halis P-1117, P-1268
Tanriverdi Hamit Alper P-0351
Tanriverdi Mehmet Halis OP-017, Course-009, P-0541
Tanyıldızı Ipek OP-058
Tarbajovska Eva P-0591
Tarcan Ercument P-0729
Tarcin Ozlem P-0692
Tarczyńska Anna OP-002
Tarda Walid OP-205, P-0940
Tarhan Fatih OP-069
Tarhini Hassan P-0874
Tarımtay Zülal P-1255
Tarín Martí Marc P-0599, P-1034
Taşcı Ç. Batuhan P-0951
Taslak Şengül Ayşen P-0263
Taşoğlu Selahattin P-0952, P-0958
Taşova Mehtap P-0536
Taştan Kenan OP-286, P-0406, P-0616, P-0981, P-1048, P-1049, P-1053, P-1085, P-1183
Taştan Merve P-0478
Taştekin Nagehan P-0455
Tatli Hülya P-0657
Tatsi Crysanthi P-0847
Tatsioni Athina SYM-010
Taubenroth Maja P-0613
Tavares Cristina Ferreira P-0128
Taylaner Bora OP-011
Taylor Tane SYM-027
Teixeira Cláudia P-0113, P-0320

Teixeira Dalila P-0134
Teixeira Inês Domingues P-0399, P-0669
Teixidó Cristina P-0509
Tejerizo Alvaro P-0733
Tekayak Halil Volkan P-0939
Tekçe Mustafa P-0231
Teker Ayşe Gülsen P-0036, P-1255
Teker Ayşe Irem P-1193
Tekgül Nurdan P-0795
Tekin Murat OP-034, OP-082, OP-225, P-0480, P-0990, P-0999
Tekin Nil WS-089, PNL-009, P-0513, P-0519, P-0546, P-0707
Tekin Oguz P-1039
Tekin Oğuz OP-256, P-0458, P-0710, P-0978, P-1094, P-1097, P-1134, P-1198, P-1360
Tekin Sakin P-0231
Tekin Vatansever Buket P-0231
Tekindal Mustafa Agah OP-057
Tekiner Ayşe Selda OP-011, OP-129, P-0251, P-0357, P-0482, P-0749, P-0774, P-1175
Tekiner Selda OP-096, P-0462
Tektaş Kemal P-1192
Telatar Berrin OP-069, P-0137, P-1385
Téllez Juan Manuel OP-085, P-0884, P-0897
Tellioglu Merve OP-065
Tello Nieves Gema María P-1066
Telyak Erol P-0657
Temiz Hatice Esin P-1124
Temizkan Şule P-0231
Temurtaş Mehmet P-1336
Ten Bokkel Roxanne P-1026
Tena Guerrero Jose Maria P-0349, P-0353
Tena Huertas M^a Jesus P-0349
Tena Huertas M^a Jesús P-0353
Tengerek Deniz P-0036
Tenias Jesus P-0101, P-1306
Tenias Jesus Maria P-0611, P-1270
Tenias Jose Maria P-0896
Tepe Derya P-1103
Teran Monica WS-034
Terbovc Alenka P-0665
Terlemez Semiha P-0365
Terli Mehmet Akif OP-057, OP-060
Termorshuizen Fabian OP-254
Terra Denise Galvêas P-0903
Tersar Costanza OP-093
Tessma Mesfin Kassaye P-1009
Tetikçok Ramazan P-0437, P-0536, P-0704, P-1307
Teunissen Erik SYM-016
Tevrizoğlu Mine WS-037
Tezcan Oğuzhan OP-278, P-0542, P-1386, P-1390, P-1391
Theochari Alkmini P-1040
Theodorou Evangelos P-0671
Thio Eulalia Borrell OP-046, P-0202
Tholib Risahmawati OP-113, OP-245
Thomas Claire Marie WS-092, P-1297
Thompson Samantha OP-241
Thorne Joanna WS-112
Thulesius Hans WS-085, SYM-010

Thurston Mckennan P-0394
Ticmane Gunta WS-058, P-0810
Tieleman Robert G OP-098
Tierney Edel P-1013
Tijhuis Elke OP-040
Tiljak Hrvoje OP-135, WS-064
Tilkeridis Konstantinos P-0671
Tina Lamprini WS-009
Tió Berta P-0199, P-0200
Tiyek Gülayşe OP-250
Tkachenko Victoria I OP-188, P-0919, P-1109, P-1110
Todorova Sevdalina Alekova P-0507, P-0901, P-0911
Tok Duran P-1093
Tokatlıoğlu Özcan Fatma Begüm P-1134
Tokgöz Saliha P-0191
Toklucu Mustafa Özgür P-0423
Toktas İzzettin OP-112
Tomasevic Tanja P-0849
Tomasik Tomasz WS-057
Tomaz João Pedro P-0228, P-0359
Tombokan Gideon OP-244
Toop Les P-1232
Topal Kenan P-0056, P-0404, P-0523, P-0720, P-0930, P-1050, P-1089, P-1131, P-1132, P-1157, P-1197
Topaloğlu Ayca P-0393
Topçu Yenerçağ Feyza Nur P-1095, P-1096, P-1101, P-1103
Topolovec Nižetić Vlatka P-1065
Toprak Dilek OP-079, P-0386, P-0393, P-0495, P-0512, P-0582, P-0608, P-0609, P-1166, P-1250, P-1275, P-1276
Toprak Dilek Evcik P-0569
Topsever Pinar OP-031, WS-077, P-0560
Topsever Pınar WS-070, PNL-010, P-1072
Topuz Ayşe Nur P-0164
Topuz Mustafa P-0164
Torán Pere P-0509, P-1032
Tormo Jose Pascual OP-032
Torrabadella Fabrega Jordi P-0857
Torremorell Núñez Mònica P-0264, P-1224
Torrente José Ignacio P-0159
Torrente Silvia P-0159
Torrente Nieto Laura P-1228
Torres Federico Vendrell P-0176
Torres Rodriguez Annabell OP-006
Torzsa Peter OP-097, SYM-010, SYM-023
Tosic Milena P-1205
Tosun Melis P-1272
Tosun Erdem Seckin P-0457
Tountas Christos P-1060
Tozman Murat P-0871
Trachanatzi Eirini P-0379, P-1279
Trad Ayssa Teles Abrao OP-005, OP-131, OP-252, P-0757, P-1178, P-1180
Trancoso Adam Das Almas OP-176
Trapp Barbara P-0387
Trappenburg Jaap OP-040, P-0077
Traspuerto Pascual Cecilia OP-198, OP-199, P-0241, P-0370, P-0972, P-0976, P-0979
Trecet Nerea P-0174, P-0664
Tretjakovs Peteris P-1009
Trikilis Nikolaos P-1025

Trindade Maria Cecília Dias P-0806
Trindade Maria João P-0824
Triwibowo Wisnu G P-1313
Troni Leonor WS-114, P-0619, P-1173
Trujillo Gómez Jose Manuel OP-146, OP-221, OP-222, P-1046, P-1047
Trypsianis Grigorios P-0153, P-0179, P-0180, P-0418, P-0671
Tsakountakis Nikolaos P-0195
Tsaousi Sofia P-0170
Tsiatsiou Panagiota P-0623
Tsiga Evaggelia P-0942
Tsiligianni Ioanna OP-118, Course-001, SYM-001
Tsimplot Stefanaki Eirini P-0968
Tsimtsiliakou Antigoni P-1296
Tsimtsiou Zoi P-1025, P-1296
Tsipou Alexandra WS-097
Tsipou Alexandra Georgios BR-041
Tsironi Maria WS-009, SYM-008
Tsolaki Kyriakoula P-0418, P-1040
Tsuha Daniel Henrique OP-158
Tsutsumi Madoka P-0778
Tu Jiachi P-0037
Tubert Jeannin Stephanie P-0487
Tufan Turgut P-0723
Tufan Koçak Zeliha P-0346
Tuğal Önder P-1050
Tugaut Béatrice OP-116
Tulunay Münevver OP-115, P-0490, P-0501, P-1038, P-1075, P-1201
Tümer Seray P-1158
Tunay Merthan P-0168
Tunç Senem P-1383
Tuncar Safa P-0142
Turan Cem Armağan P-1272
Turan Tuğçe Refika P-0425, P-1155
Turebayev Mukhit Nauryzgaliyevich OP-189
Türeyici Lena P-1132
Turfaner Sipahioğlu Nurver P-1031, P-1061, P-1211
Turgut Bilge OP-064, OP-130, OP-271, WS-049
Turhan Vedat SYM-008
Türk Ipek P-0164
Turker Yasemin P-1126, P-1136
Turker Yasin P-1126, P-1136
Türker Rukiyye P-0643
Türker Yasemin Karaşör OP-007
Türkmen Yasemin Korkut P-0442
Türkoğlu Aziz Kaan OP-075
Turkyılmaz Esengul P-1083
Tutkun Engin P-0183, P-0184, P-0189, P-0190, P-0192
Tuz Canan OP-152, OP-193, BR-020, WS-070, WS-092, P-0813, P-0822, P-0939, P-0959
Tuzcular Vural Emine Zeynep SYM-014, P-0547, P-0670
Tuzcular Vural Zeynep Course-006, Course-007, WS-029, PNL-010, P-0155, P-0237
Tuzlak Ahmet P-0013, P-0019
Tuzun Dilek P-0068
Tüzün Hasan P-1211
Tüzün Sabah OP-031, Course-004
Úbeda García Carmen P-0264

Ubiña Carbonero Antonio P-0269, P-0270, P-0271, P-0272, P-0273, P-0274, P-0275, P-0277, P-0278, P-0279, P-0280, P-0294, P-0297, P-0298, P-0300, P-0301

Ubović Radmila P-1352

Üçer Hüseyin P-0470, P-0492, P-0528, P-0767, P-1171, P-1188, P-1202, P-1357, P-1396, P-1397

Ucgun Taner P-1126

Üçgün Serdar P-0232

Uçkan Mustafa Ülkü P-0978

Üçüncü Merve Müge P-0582

Ugarte Jurgi P-1032

Uğur Elif P-1255

Uğur Halis P-1242

Uğur Mahir P-1334, P-1335

Uğur Altun Betül P-0692

Uğurlu Mehmet OP-164, P-0143, P-0160, P-0203, P-0346, P-0481, P-0742, P-1176, P-1179, P-1184, P-1376, P-1387

Ulaşoğlu Celal P-1042

Ülger Nazlı P-0869

Uludağ Samet P-0460

Uludağ Ayşegül OP-034, OP-082, OP-225, P-0442, P-0990, P-0999, P-1035

Uludağ Samet P-1108

Ünal Ahmet P-0204, P-0234, P-0351, P-0362, P-0365, P-0435, P-0439, P-0775

Ünal Asli Dogruk P-0692

Ünal Erdinç P-0854

Ünal Esengül P-0354

Ünal Mustafa P-0687, P-0688, P-0974, P-1195, P-1196, P-1355

Ünal Yasemin OP-053

Ünalacak Murat P-0937, P-1143

Ünalın C. Gülru Pemra OP-196, WS-049, WS-064, PNL-009, SYM-010, SYM-011, P-0138, P-0545, P-0694, P-0957, P-1242

Uncu Yesim WS-070

Uncu Yeşim OP-007

Ungan Mehmet OP-011, OP-044, BR-024, WS-082, WS-117, SYM-023, SYM-028, P-0251, P-0357, P-0482, P-0646, P-0774, P-1175

Ungar Tamas P-0551

Ungvári Timea OP-088

Ünlü Ufuk P-0427, P-0536, P-0704, P-1307

Ünlüoğlu İlhami OP-261, SYM-026, P-0937, P-0970, P-1336

Ünlüsoy Mehmet OP-007

Ünsal Çiğdem P-0506

Ünüvar Mavişe Esra OP-285, P-0705

Ünüvar Tolga P-0775

Urgancı Nafiye OP-068

Uria Carmen Coladas P-0001

Urieta Laura P-0101, P-0611, P-1270, P-1306

Us Dülger Seyhan P-0971

Üsküdar Teke Havva P-1336

Usman Gökhan OP-017

Usta Ayşe Merve OP-068

Ustaoğlu Mehmet Ali P-0231

Usterme Necibe P-0723

Üstü Yusuf OP-164, OP-276, P-0143, P-0160, P-0203, P-0346, P-0481, P-0742, P-1179, P-1181, P-1184, P-1376, P-1387

Üstün Levent P-0366

Üstündağ Mehmet P-0151, P-0152

Üstündağ Reyhan P-0436, P-0441, P-0447, P-1258

Uta Adela Ioana P-0335, P-0830

Uta Claudia Elena P-0335, P-0830
Utap Maurice Steve P-1002
Utkan Yunus P-0871
Utlu Gokcenur OP-177
Uyanık Nuh Esad P-0222
Uyanıkoğlu Ahmet P-0182
Uwimbabazi Sarah P-1403
Uyar Kübra P-0239, P-0352, P-0361, P-0519, P-0706, P-1133, P-1169
Uysal Cem P-1384
Uysal Yücel P-0229, P-1111
Uzuner Arzu OP-042, OP-064, OP-065, OP-075, OP-130, OP-196, OP-271, OP-281, WS-025, PNL-008, P-0376, P-0477, P-0709, P-1242
Uzuriaga Miriam P-0832
Vainoriene Simona P-1098
Vajer Peter OP-097
Vakas Michail P-0671, P-1040
Vakkila Jukka P-0348
Valente Carolina Alice De Camargo OP-220, P-0891
Valentín Juan Francisco Sanz P-1342
Valero Francisco Javier Fernández P-0003, P-0030, P-0033, P-0083
Vallcorba Oriol P-0199, P-0200
Valls Roca Francisco P-0666
Valpuesta Marta Lasheras P-1342
Valpuesta Martin Yolanda P-0518, P-0739, P-0812, P-0818, P-0821
Van Abbema Doris OP-217
Van Asselt Kristel M P-1026
Van Bergen Jan OP-026
Van Blijswijk Sophie C.e. OP-049
van de Mortel Thea P-0875
Van De Vijver Paul WS-065
Van Den Akker Marjan OP-217
Van Den Brekel Karolien WS-022
Van Den Brink Gerline P-1026
van den Brink Marian J. OP-206
Van Den Broek Stijn WS-095
Van Den Broeke Carine OP-217
Van Der Molen Thys OP-241
Van Der Post Kees WS-065
Van Der Steen Berry SYM-007
Van Der Velden Suzanne OP-100
Van Der Voet Lucet OP-223
Van Der Wall Elsen OP-047
Van Dijk Christel E OP-232
Van Dijk Frank WS-050, SYM-022
van Driel Mieke P-0875
Van Erp Nicole OP-216
Van Exel Job OP-157
Van Gool Willem A OP-092
Van Houwelingen Anne H. OP-049
Van Maele Louis P-1127
Van Marwijk Harm SYM-010
Van Melle Marije OP-185
Van Mourik Yvonne OP-208
Van Stel Henk OP-185
Van Weert Henk C P-1221, WS-098
Van Zelst Maria Inês Dos Reis M. P-0621

Vande Bussche Piet WS-093, WS-093, WS-096
Vaquero Sara García P-1342
Vargas Carina P-1091
Vargas David Rodriguez P-0150, P-0803
Vargas Diego Agustín OP-010, P-0330, P-0341
Vargas Machuca Cabañero Concepción P-0040, P-0044
Varthalis Dionysios P-0379
Varvuolyte Sonata P-0574
Vasconcellos Raíssa Rocha De Holanda OP-176
Vasilakis Dimitrios P-0379
Vasilopoulos Theodoros P-0195, P-0379, P-0497, P-0847, P-0968, P-1279
Vassie Claire OP-147
Vatopoulos Alkiviadis P-0623
Vaverkova Iveta OP-088
Vaz Bruno P-0103, P-0296, P-1308
Vaz Jacinta P-1014
Vaz Jacinta Oliveira OP-155
Vaz De Miranda Diana P-0319, P-0320, P-1308
Vázquez Xose P-1032
Vázquez Pirillo Gastón Ezequiel P-0265, P-0899
Vehid Suphi P-1061
Velázquez Sonia Herrero P-1342
Velgan Marta WS-028
Velíhanova Nahida P-0980
Velonakis Emmanouil P-0623
Veloso Monserrat Piriz P-1342
Verastegui Cordova Julio P-0095
Verategui Cordova Julio P-0308
Verdasca Maria José P-0786
Verdi Yıldız P-1031
Verdú Rotellar Jose Maria P-0105
Verger Pierre OP-107, OP-169
Vergna Elaine Caliman P-0885, P-0903
Verras Christos P-1060, P-1068, P-1069, P-1071, P-1073
Vesa Mădălina P-0936
Vestal Gemma PNL-002
Viana Daphne Rios P-0926
Viana José Manuel P-0303, P-1400,
Viana Thompson Dias P-0903
Vicanovic Amela P-0008
Vicente Ricardo P-0132, P-1319, P-1320, P-1323
Vidakovic Estera Dusan P-0809
Vidal German Allut P-0145
Vidal Rosa M. Viñas P-0240
Vidal Alaball Josep BR-068, P-0794, P-0865
Vidal Ribas Cristina P-0282, P-0284, P-0285
Vidal Royo Josep Maria P-1224
Vidal Vaz Padro P-0284
Vidal Vaz Pedro P-0282, P-0285
Vidiawati Dhanasari SYM-018
Viegas Dias Catarina P-0187, P-0340
Vieira Sara P-0641
Vieira Wilton Paulo De Freitas Martins P-0904
Vieira Pascual María Carmen P-0044
Vieira Rodríguez Angela Inés P-0599, P-1034
Vilchez Jaimez Maria P-0272

Villalba Francisca Maria Aceituno OP-132, P-0714, P-0895
Villani Patrick OP-107
Villar Cruz OP-032
Villena Alejandro OP-083, OP-085
Villimar Rodriguez Ana P-0074
Viñas Cristina Viladot P-0085
Vinci Paolo OP-204
Vinker Shlomo SYM-010
Vintere Ruta P-0810
Vinyoles Ernest P-0105
Viotto Laura P-0920
Visentin Giorgio WS-108
Visockiene Zydrune P-0060, P-0061, P-0062, P-0064, P-0076, P-0078, P-0086
Vissoci Juliana Carolina Martins P-0387
Voegele Claus OP-123
Vojvodic Zeljko OP-211, OP-212
Von Hintzenstern Julia P-1128
Vonk Peter P-0454
Vos Rimke OP-080, P-0069
Vouga Luis Afonso P-0585
Voulgari Paraskevi P-1064
Voutilainen Seppo P-1216
Vracko Pia P-0686
Vrbovsek Sanja P-0686
Vrtarić Darko P-0281
Vrtarić Slavica P-0281
Vucak Jasna P-0945
Vulpi Ivo P-0914
Vural Ramazan P-0673
Vural Tolga OP-007
VURUCU Sebahattin P-1114
Wainsaf Indah Ein F P-1313
Wainwright David P-1017
Wakakuri Hiroaki OP-218
Walinga Chris WS-072, WS-073, P-1282
Wallace Carolyn WS-040
Wallace Paul OP-093, OP-205, WS-084, P-0940
Wallenburg Iris OP-157
Wallis Katharine Ann BR-060
Walsh Allyn WS-052, WS-061
Walsh Allyn Elizabeth P-0876
Walsh Thomas OP-109
Wass Val WS-052
Watson Jessica WS-105
Watson William WS-052
Watt David WS-059, WS-060
Wawrzycka Karolina P-0779
Wawrzynek Malgorzata P-0612
Wawrzynek Wojciech P-0612
Weersma Renee WS-043
Weijden Trudy Van Der OP-038
Weller David WS-030
Welsh Victoria WS-086
Wens Johan SYM-006
Wensaas Knut Arne WS-008, SYM-023
Westaway Kerrie P-0887

Westerik Janine Anne Marie OP-241
Whalley Katrina P-0945
Wheeler Gerald OP-197
Wibaut Sabine P-0657
Widyahening Indah S SYM-018
Widyahening Indah Suci P-1164, P-1239
Wieringa Sietse OP-219, WS-043, WS-100
Willaing Ingrid SYM-005
Willems Dick OP-267, P-0985
Willems Sara WS-090, WS-096
Williams Sian OP-118
Wilson C. Ruth WS-044
Wilson Clare BR-015, BR-071, P-0863
Wilson Ruth WS-021
Windak Adam OP-002, OP-084, WS-057
Winkler Eva OP-257
Winterholler Marion P-0821
Withnall Rich WS-045, P-0923
Wiwaha Guswan OP-170
Wolf Katrin P-0821
Wollmann Lucas OP-174
Wong William WS-090
Wood Julie OP-154
Wyler Lazarevic Claire Anne P-0633
xx Joana Neto P-0908
Yaghi Shadene P-0552, P-0746
Yaghi Yasser P-0552, P-0746
Yahya Hoşcan Ahmet P-0696
Yaka Hümeýra P-0161, P-0163, P-0171, P-0191, P-0198
Yakar Burkay P-0442
Yalcin Saadet Berrin P-0449
Yalçın Bektaş Murat OP-008, P-0480, P-0687, P-0688, P-0854, P-0974, P-1195, P-1196, P-1355
Yalçıntaş Aynur P-0417, P-0419, P-0760
Yalçıntaş Emre P-0222
Yaman Hakan BR-017, WS-016
Yanel Diego Sebastián P-1034
Yang Chen Cheng P-0575, P-0575, P-0575, P-0575, P-1008, P-1008, P-1008
Yang Yun Jun P-0573
Yanık Serdar P-0212
Yapakçı Ali OP-196
Yapan Goral Nilgun BR-069
Yaphe Jonah CON-008
Yaprak Seval OP-236, WS-037, WS-116, P-0464, P-0819
Yardım Nazan OP-121
Yarış Füsün P-0474, P-0588, P-0602, P-1045, P-1138, P-1140
Yaşar İlknur P-1226
Yaşar Şirin P-0547
Yasin Abd Elrahman Abd El Fatah OP-105
Yasin Mohd Irfan P-1002
Yasutake Masahiro OP-218
Yavuz Derya OP-194
Yavuz Elif Burcu P-0182, P-0424
Yavuz Erdinç OP-007, OP-067, OP-194, OP-239, BR-019, BR-044, Course-009, P-0355, P-0823, P-1191, P-1200, P-1362
Yavuz Serkan P-0934, P-1204
Yavuzylmaz Fatma OP-068

Yayla Erol OP-007, OP-067, OP-239, P-0355, P-1362
Yayla Muhteşem Erol OP-194, P-1200
Yazıcı Onur P-0858
Yazıcı Suzan BR-030, P-0653, P-0673
Yazıcıoğlu Bahadır P-0012, P-0102, P-0364, P-0695, P-0977, P-1021, P-1027, P-1033, P-1045, P-1196
Yazlı Nurullah P-1242
Yee Hing Tang Eugene WS-086, SYM-010
Yeğın Zehra OP-226
Yen Shao En Sharon OP-180
Yendim Halil P-0647
Yengil Duygu P-0458
Yengil Erhan OP-250, OP-265, P-1111
Yenice Necati P-0182
Yeniçeri Emine Neşe OP-053, P-0538, P-0755
Yeniçeri Neşe OP-246, WS-087
Yenigün Ayşe P-0362
Yeniocak Selman P-0322
Yenjean Mei Chu OP-180, OP-180, OP-180
Yerrakalva Dharani P-0562, P-0983
Yeşiltepe Gözde WS-037
Yeves Jesus P-0896
Yeverska Irina P-0380, P-0727, P-1291
Yiğit Emel P-0955
Yiğit Ezgi P-1242
Yiğit Ferhat P-0864
Yiğit Gülşah P-1242, P-1381
Yiğit Nurdan P-0461, P-0699
Yiğitbaşı Halenur P-0512
Yiğitbaşıoğlu Özlem P-0952, P-0958
Yıkılkan Hülya OP-115, OP-278, P-0468, P-0490, P-0501, P-0542, P-0568, P-0724, P-1038, P-1075, P-1386, P-1390, P-1391
Yıldırım Ahmet P-0163, P-0367
Yıldırım Birdal OP-053, P-0538, P-0755
Yıldırım Duygu İlke P-0251, P-0357, P-0367
Yıldırım Ediz P-1112, P-1133, P-1135
Yıldırım Emine P-0458
Yıldırım Fatış P-0416, P-0528, P-1171, P-1356, P-1357
Yıldırım İlhami P-0404
Yıldırım Kadir P-0974
Yıldırım Nevruz P-0368, P-0429, P-0550
Yıldırım Sait P-1157
Yıldırım Aksakal Berrak P-0748
Yıldırım Şimşir Iğın P-0010
Yıldız Orhan P-0505
Yıldız Selcuk P-1377
Yıldız Ummugulsum P-1174, P-1177
Yıldız Bahri Course-009
Yıldız Hüseyin OP-042
Yıldız İsmail OP-004
Yıldız Pınar P-1143
Yıldız Selçuk OP-164, P-0481, P-1376
Yıldız Süleyman Sezai P-0050
Yıldız Ülkü P-0546, P-1245
Yıldız Çelttek Nagihan P-0427, P-0437, P-0536, P-0704, P-1307
Yılmaz Emre BR-073
Yılmaz Mehmet P-1262, P-1317

Yilmaz Niyazi P-0149
Yilmaz Oguz P-1135
Yilmaz Tuğba P-0867
Yilmaz Ahmet OP-017, P-0151, P-0152, P-0173, P-0541, P-0647, P-0944, P-1012, P-1093, P-1117, P-1268
Yilmaz Ayşe Eren P-1255
Yilmaz Aziz P-0222
Yilmaz Bektaş P-0871
Yilmaz Demet OP-079
Yilmaz Dilek P-0435
Yilmaz Ebru OP-164, WS-101, P-0481, P-1376, P-1377
Yilmaz Emrullah P-1101
Yilmaz Fatma Özlem OP-249
Yilmaz Halis OP-042, P-0138
Yilmaz Mahmut P-1166
Yilmaz Nisbet P-0022
Yilmaz Nisbet P-0257, P-0258
Yilmaz Oğuz P-0038, P-0513, P-1106
Yilmaz Ömer Hınç P-0183, P-0184, P-0189, P-0190, P-0192
Yilmaz Orhan P-1062
Yilmaz Tarık Eren P-0020, P-0021, P-0022, P-0055, P-0867
Yilmaz Keskin Ebru P-0371
Yilmazer Ayşe P-0360, P-1184
Yilmazer Sezin P-0963
Yilmazer Tefvik Tanju OP-101, BR-031, P-0795
Yngvesson Maria WS-062
Yoğurtçu Nazmi P-0531
Yoldemir Tefvik OP-064, OP-130
Yönem Arif P-1345, P-1351
Yöney Adnan P-0236
Yoo Seung Hyun P-0998
Yoon Hyun Soo P-0790
Yoon Jo Hi P-0790
Yorgancıoğlu Arzu Course-010
Yörük Nurdan P-0023, P-0043
Youkedebah Ebikaboere P-0551
Youn Sang Ah P-1004, P-1005
Young Richard P-0494, P-0783
Yousif Magda Elhadi Ahmed OP-149
Yozgatlı Tahir Koray P-1072
Yu Wen Ruey P-0037
Yüce Adnan P-0468
Yüce Fatıma P-1401
Yücel Alev P-0952, P-0958
Yücel Feyza P-0046, P-0643
Yüksek Esin P-0443
Yuksel Cankut P-0644
Yuksel Servet P-0723
Yüksel Hatice OP-017
Yüksel Hayriye Kubilay P-0461, P-0699
Yüksel Hilal P-1038
Yuksel Salduz Zeyneb Irem P-1145
Yurdabakan İrfan P-1137
Yurdakul Fatma Gul P-0081
Yurdakul Tuğba P-0482
Yurtsever Ceyhun P-0236, P-0445, P-0485, P-1149
Yusufoğlu Özkan P-0222

Zafosnik Uros OP-099
Zahirovic Izudin P-0973
Zahmacioğlu Oğuzhan OP-078
Zaidi Nurfarhana OP-029
Zaiour Wajih P-0552
Zakariah Siti Zulaikha P-1058
Zalihic Amra P-0057, P-0816, P-1088
Zalihic Pita Adna P-0816
Zarco Manjavacas Julian P-0269, P-0270, P-0271, P-0272, P-0273, P-0274, P-0275, P-0277, P-0278, P-0279, P-0280, P-0294, P-0297, P-0298, P-0300, P-0301
Zaric Marija Marjan P-0087, P-0315, P-1055, P-1077
Zarici Iuliana OP-045
Zarrad Emna OP-140, WS-097
Zedini Chekib P-1289
Zeekeon Joy OP-244, P-0693
Zekey Fethi Sada OP-152, P-0939, P-0959
Zekonyte Egle P-0751, P-0752, P-0753, P-0754
Zengin Esra P-0690
Zepeda Oscar P-0101, P-0611, P-1270, P-1306
Zevallos Roxana P-0635
Zhamaliyeva Lazzat Manbetzhanovna OP-189
Žitnik Šircelj Metka P-0607
Zivkovic Duvnjak Branka P-1003
Zoițanu Raluca WS-024, WS-026, PNL-001, PNL-003, SYM-013
Zorlu Ölmez Emel P-1395
Zortul Abdulsamet P-0788, P-1341
Zortul Abdussemet P-0654
Zoupas Spyros P-0213
Zulhafdy Muhammad OP-245
Zulkifly Steven P-1164
Zvoníčková Marie OP-157
Zwart Dorien OP-185, OP-186, P-1219, P-1222
Zwisler Jon P-0833